



■ Report No.: DDT-R23022419-2E01

■ Issued Date: Mar. 17, 2023

FCC AND ISED CERTIFICATION TEST REPORT

FOR

| | | |
|-----------------------------|---|---|
| Applicant | : | Harman International Industries, Inc. |
| Address | : | 8500 Balboa Boulevard, Northridge, CA 91329, UNITED STATES |
| Equipment under Test | : | 21" POWERED BLUETOOTH SOUNDBAR AUDIO SYSTEM WITH LED LIGHTING |
| Model No. | : | RALLYBAR |
| Trade Mark | : | JBL |
| FCC ID | : | APIJBLRBAR |
| IC | : | 6132A-JBLRBAR |
| Manufacturer | : | Harman International Industries, Inc. |
| Address | : | 8500 Balboa Boulevard, Northridge, CA 91329, UNITED STATES |

Issued By: Dongguan Dongdian Testing Service Co., Ltd.

Add.: No. 17, Zongbu Road 2, Songshan Lake Sci&Tech, Industry Park,
Dongguan City, Guangdong Province, China, 523808

Tel.: +86-0769-38826678, **E-mail:** ddt@dgddt.com, <http://www.dgddt.com>

REPORT

Table of Contents

| | | |
|------|---|----|
| | Test report declares..... | 4 |
| 1. | Summary of Test Results..... | 7 |
| 2. | General Test Information | 8 |
| 2.1. | Description of EUT | 8 |
| 2.2. | Accessories of EUT..... | 9 |
| 2.3. | Assistant equipment used for test..... | 9 |
| 2.4. | Block diagram of EUT configuration for test | 9 |
| 2.5. | Deviations of test standard..... | 9 |
| 2.6. | Test environment conditions | 10 |
| 2.7. | Test laboratory | 10 |
| 2.8. | Measurement uncertainty..... | 10 |
| 3. | Equipment Used During Test..... | 11 |
| 4. | 20 dB Bandwidth | 12 |
| 4.1. | Block diagram of test setup..... | 12 |
| 4.2. | Limits | 12 |
| 4.3. | Test procedure | 12 |
| 4.4. | test result..... | 12 |
| 4.5. | Test graphs | 13 |
| 5. | 99% Bandwidth | 17 |
| 5.1. | Block diagram of test setup..... | 17 |
| 5.2. | Limits | 17 |
| 5.3. | Test procedure | 17 |
| 5.4. | Test Result | 17 |
| 5.5. | Test Graphs..... | 18 |
| 6. | Maximum Peak Output Power | 22 |
| 6.1. | Block diagram of test setup..... | 22 |
| 6.2. | Limits | 22 |
| 6.3. | Test procedure | 22 |
| 6.4. | Test Result Peak..... | 23 |
| 6.5. | Test graphs | 23 |
| 7. | Carrier Frequency Separation..... | 27 |
| 7.1. | Block diagram of test setup..... | 27 |
| 7.2. | Limits | 27 |
| 7.3. | Test procedure | 27 |
| 7.4. | Test result..... | 28 |
| 7.5. | Test graphs | 28 |
| 8. | Dwell Time..... | 30 |

| | | |
|-------|---|----|
| 8.1. | Block diagram of test setup..... | 30 |
| 8.2. | Limits | 30 |
| 8.3. | Test procedure | 30 |
| 8.4. | Test result..... | 31 |
| 8.5. | Test graphs | 31 |
| 9. | Number of Hopping Channel | 38 |
| 9.1. | Block diagram of test setup..... | 38 |
| 9.2. | Limits | 38 |
| 9.3. | Test procedure | 38 |
| 9.4. | Test result..... | 39 |
| 9.5. | Test graphs | 39 |
| 10. | Band Edge Compliance (Conducted Method) | 41 |
| 10.1. | Block diagram of test setup..... | 41 |
| 10.2. | Limit..... | 41 |
| 10.3. | Test procedure | 41 |
| 10.4. | Test result..... | 42 |
| 10.5. | Test graphs | 42 |
| 11. | RF Conducted Spurious Emissions | 47 |
| 11.1. | Block diagram of test setup..... | 47 |
| 11.2. | Limits | 47 |
| 11.3. | Test procedure | 47 |
| 11.4. | Test result..... | 48 |
| 11.5. | Test graphs | 48 |
| 12. | Duty cycle..... | 58 |
| 12.1. | Block diagram of test setup..... | 58 |
| 12.2. | Limit..... | 58 |
| 12.3. | Test procedure | 58 |
| 12.4. | Test result..... | 59 |
| 12.5. | Test graphs | 59 |
| 13. | Radiated Emission | 63 |
| 13.1. | Block diagram of test setup..... | 63 |
| 13.2. | Limit..... | 64 |
| 13.3. | Test Procedure..... | 66 |
| 13.4. | Test result..... | 67 |
| 14. | Band Edge Compliance (Radiated Method) | 76 |
| 14.1. | Block diagram of test setup..... | 76 |
| 14.2. | Limit..... | 76 |
| 14.3. | Test Procedure..... | 76 |

| | | |
|-------|---|----|
| 14.4. | Test result..... | 76 |
| 15. | Power Line Conducted Emission..... | 89 |
| 15.1. | Block diagram of test setup..... | 89 |
| 15.2. | Power line conducted emission limits..... | 89 |
| 15.3. | Test procedure..... | 89 |
| 15.4. | Test result..... | 90 |
| 16. | Antenna Requirements..... | 91 |
| 16.1. | Limit..... | 91 |
| 16.2. | Result..... | 91 |
| 17. | Test Setup Photograph..... | 92 |
| 18. | Photos of the EUT..... | 94 |

Test Report Declare

| | | |
|-----------------------------|---|---|
| Applicant | : | Harman International Industries, Inc. |
| Address | : | 8500 Balboa Boulevard, Northridge, CA 91329, UNITED STATES |
| Equipment under Test | : | 21" POWERED BLUETOOTH SOUNDBAR AUDIO SYSTEM WITH LED LIGHTING |
| Model No. | : | RALLYBAR |
| Trade Mark | : | JBL |
| Manufacturer | : | Harman International Industries, Inc. |
| Address | : | 8500 Balboa Boulevard, Northridge, CA 91329, UNITED STATES |

Test Standard Used:

FCC Rules and Regulations Part 15 Subpart C, RSS-247 Issue 2 February 2017.

Test Procedure Used:

ANSI C63.10:2013, RSS-Gen Issue 5, Apr. 2018, Amendment 2 (February 2021)

We Declare:

The equipment described above is tested by Dongguan Dongdian Testing Service Co., Ltd. and in the configuration tested the equipment complied with the standards specified above. The test results are contained in this test report and Dongguan Dongdian Testing Service Co., Ltd. is assumed of full responsibility for the accuracy and completeness of these tests.

After test and evaluation, our opinion is that the equipment provided for test compliance with the requirement of the above FCC&ISED standards.

| | | | |
|-------------------------|--------------------|----------------------|-------------------------------|
| Report No.: | DDT-R23022419-2E01 | | |
| Date of Receipt: | Mar. 02, 2023 | Date of Test: | Mar. 02, 2023 ~ Mar. 17, 2023 |

Prepared By:

Johnny Wang

Johnny Wang/Engineer

Approved By:



Damon Hu/EMC Manager

Note: This report applies to above tested sample only. This report shall not be reproduced in parts without written approval of Dongguan Dongdian Testing Service Co., Ltd.

Revision History

| Rev. | Revisions | Issue Date | Revised By |
|------|---------------|---------------|------------|
| --- | Initial issue | Mar. 17, 2023 | |
| | | | |

1. Summary of Test Results

| Description of Test Item | Standard | Verdict |
|---------------------------------|---|---------|
| Maximum Peak Output Power | FCC Part 15: 15.247(b)(1) RSS-247 Issue 2 clause 5.4(b) | Pass |
| 20 dB Bandwidth | FCC Part 15: 15.247(a)(1) RSS-247 Issue 2 clause 5.1(a) | Pass |
| 99% Bandwidth | RSS-Gen Issue 5 clause 6.7 | Pass |
| Carrier Frequency Separation | FCC Part 15: 15.247(a)(1) RSS-247 Issue 2 clause 5.1(b) | Pass |
| Number of Hopping Channel | FCC Part 15: 15.247(a)(1)(iii) RSS-247 Issue 2 clause 5.1(d) | Pass |
| Dwell Time | FCC Part 15: 15.247(a)(1)(iii) RSS-247 Issue 2 clause 5.1(d) | Pass |
| RF Conducted Spurious Emissions | FCC Part 15: 15.247(d) RSS-247 Issue 2 clause 5.5 | Pass |
| Radiated Emission | FCC Part 15: 15.205(a) FCC Part 15: 15.209(a) FCC Part 15: 15.247(d) RSS-247 Issue 2 clause 5.5 RSS-Gen Issue 5 clause 8.9 RSS-Gen Issue 5 clause 8.10 | Pass |
| Band Edge Compliance | FCC Part 15: 15.205(a) FCC Part 15: 15.209(a) FCC Part 15: 15.247(d) RSS-247 Issue 2 clause 5.5 RSS-Gen Issue 5 clause 8.9 RSS-Gen Issue 5 clause 8.10 | Pass |
| Power Line Conducted Emissions | FCC Part 15: 15.207(a) RSS-Gen Issue 5 clause 8.8 | N/A |
| Antenna Requirement | FCC Part 15: 15.203 RSS-Gen Issue 5 clause 6.8 | Pass |

Note: N/A is an abbreviation for Not Applicable

2. General Test Information

2.1. Description of EUT

| | |
|---------------------------|---|
| EUT* Name | : 21" POWERED BLUETOOTH SOUNDBAR AUDIO SYSTEM WITH LED LIGHTING |
| Model Number | : RALLYBAR |
| EUT* Function Description | : Please reference user manual of this device |
| Power Supply | : DC 12V |
| Radio Specification | : Bluetooth V5.3 |
| Operation Frequency | : 2402 MHz - 2480 MHz |
| Modulation | : GFSK, $\pi/4$ -DQPSK, 8DPSK |
| Data Rate | : 1 Mbps, 2 Mbps, 3 Mbps |
| Antenna | : FPC antenna, maximum PK gain: 2.36 dBi |
| Sample Number | : S23022419-10 for conductive, S23022419-11 for radiation |

Note: EUT is the ab. of equipment under test.

| Channel information | | | | | |
|---------------------|-----------------|---------|-----------------|---------|-----------------|
| Channel | Frequency (MHz) | Channel | Frequency (MHz) | Channel | Frequency (MHz) |
| 0 | 2402 | 27 | 2429 | 54 | 2456 |
| 1 | 2403 | 28 | 2430 | 55 | 2457 |
| 2 | 2404 | 29 | 2431 | 56 | 2458 |
| 3 | 2405 | 30 | 2432 | 57 | 2459 |
| 4 | 2406 | 31 | 2433 | 58 | 2460 |
| 5 | 2407 | 32 | 2434 | 59 | 2461 |
| 6 | 2408 | 33 | 2435 | 60 | 2462 |
| 7 | 2409 | 34 | 2436 | 61 | 2463 |
| 8 | 2410 | 35 | 2437 | 62 | 2464 |
| 9 | 2411 | 36 | 2438 | 63 | 2465 |
| 10 | 2412 | 37 | 2439 | 64 | 2466 |
| 11 | 2413 | 38 | 2440 | 65 | 2467 |
| 12 | 2414 | 39 | 2441 | 66 | 2468 |
| 13 | 2415 | 40 | 2442 | 67 | 2469 |
| 14 | 2416 | 41 | 2443 | 68 | 2470 |
| 15 | 2417 | 42 | 2444 | 69 | 2471 |
| 16 | 2418 | 43 | 2445 | 70 | 2472 |
| 17 | 2419 | 44 | 2446 | 71 | 2473 |
| 18 | 2420 | 45 | 2447 | 72 | 2474 |
| 19 | 2421 | 46 | 2448 | 73 | 2475 |
| 20 | 2422 | 47 | 2449 | 74 | 2476 |
| 21 | 2423 | 48 | 2450 | 75 | 2477 |
| 22 | 2424 | 49 | 2451 | 76 | 2478 |
| 23 | 2425 | 50 | 2452 | 77 | 2479 |
| 24 | 2426 | 51 | 2453 | 78 | 2480 |
| 25 | 2427 | 52 | 2454 | | |
| 26 | 2428 | 53 | 2455 | | |

2.2. Accessories of EUT

| Description of Accessories | Manufacturer | Model number | Description | Remark |
|----------------------------|--------------|--------------|-------------|--------|
| N/A | N/A | N/A | N/A | N/A |

2.3. Assistant equipment used for test

| Assistant equipment | Manufacturer | Model number | EMC Compliance | SN |
|---------------------|--------------|--------------|----------------|-----|
| N/A | N/A | N/A | N/A | N/A |

2.4. Block diagram of EUT configuration for test



Test software: FCCTestTool.exe

The test software was used to control EUT work in Continuous Tx mode, and select test channel, wireless mode as below table.

The pathloss of external cable: 0.5 dB (According to the manufacturer's claims)

| Tested mode, channel, information | | | |
|------------------------------------|------------------|-------------|-----------------|
| Mode | Setting Tx Power | Channel | Frequency (MHz) |
| GFSK hopping on Tx mode | 0x0112 | CH0 to CH78 | 2402 to 2480 |
| $\pi/4$ -DQPSK hopping on Tx mode | 0x0112 | CH0 to CH78 | 2402 to 2480 |
| 8DPSK hopping on Tx mode | 0x0112 | CH0 to CH78 | 2402 to 2480 |
| GFSK hopping off Tx mode | 0x0112 | CH0 | 2402 |
| | 0x0112 | CH39 | 2441 |
| | 0x0112 | CH78 | 2480 |
| $\pi/4$ -DQPSK hopping off Tx mode | 0x0112 | CH0 | 2402 |
| | 0x0112 | CH39 | 2441 |
| | 0x0112 | CH78 | 2480 |
| 8DPSK hopping off Tx mode | 0x0112 | CH0 | 2402 |
| | 0x0112 | CH39 | 2441 |
| | 0x0112 | CH78 | 2480 |

2.5. Deviations of test standard

No deviation.

2.6. Test environment conditions

| | |
|--------------------|-------------------|
| Temperature range: | +15°C to +35 °C |
| Humidity range: | 20% to 75% |
| Pressure range: | 86 kPa to 106 kPa |

2.7. Test laboratory

Dongguan Dongdian Testing Service Co., Ltd.

Add.: No. 17, Zongbu Road 2, Songshan Lake Sci&Tech, Industry Park, Dongguan City, Guangdong Province, China, 523808.

Tel.: +86-0769-38826678, <http://www.dgddt.com>, Email: ddt@dgddt.com.

CNAS Accreditation No. L6451; A2LA Accreditation Number: 3870.01

FCC Designation Number: CN1182, Test Firm Registration Number: 540522

Innovation, Science and Economic Development Canada Site Registration Number: 10288A

Conformity Assessment Body identifier: CN0048

VCCI facility registration number: C-20087, T-20088, R-20123, R-20155, G-20118

2.8. Measurement uncertainty

| Test Item | Uncertainty |
|--|--|
| Bandwidth | 1.1% |
| Peak Output Power (Conducted) (Spectrum analyzer) | 0.86 dB (10 MHz ≤ f < 3.6 GHz); |
| | 1.38 dB (3.6 GHz ≤ f < 8 GHz) |
| Peak Output Power (Conducted) (Power Sensor) | 0.74 dB |
| Power Spectral Density | 0.74 dB (10 MHz ≤ f < 3.6 GHz); |
| | 1.38 dB (3.6 GHz ≤ f < 8 GHz) |
| Frequencies Stability | 6.7 × 10 ⁻⁸ (Antenna couple method) |
| | 5.5 × 10 ⁻⁸ (Conducted method) |
| Conducted spurious emissions | 0.86 dB (10 MHz ≤ f < 3.6 GHz); |
| | 1.40 dB (3.6 GHz ≤ f < 8 GHz) |
| | 1.66 dB (8 GHz ≤ f < 26.5 GHz) |
| Uncertainty for radio frequency (RBW < 20 kHz) | 3×10 ⁻⁸ |
| Temperature | 0.4 °C |
| Humidity | 2 % |
| Uncertainty for Radiation Emission test (9 kHz – 30 MHz) | 3.44 dB |
| Uncertainty for Radiation Emission test (30 MHz - 1 GHz) | 4.70 dB (Antenna Polarize: V) |
| | 4.84 dB (Antenna Polarize: H) |
| Uncertainty for Radiation Emission test (1 GHz - 40 GHz) | 4.10 dB (1 - 6 GHz) |
| | 4.40 dB (6 GHz - 18 GHz) |
| | 3.54 dB (18 GHz - 26 GHz) |
| | 4.30 dB (26 GHz - 40 GHz) |
| Uncertainty for Power line conduction emission test | 3.34dB (150KHz-30MHz) |
| | 3.72dB (9KHz-150KHz) |

Note: This uncertainty represents an expanded uncertainty expressed at approximately the 95% confidence level using a coverage factor of k=2.

3. Equipment Used During Test

| Equipment | Manufacturer | Model No. | Serial No. | Last Cal. | Cal. Interval |
|---|-----------------|---|-------------------|---------------|---------------|
| <input checked="" type="checkbox"/>RF Connected Test (Tonscend RF Measurement System 3#) | | | | | |
| Signal & Spectrum analyzer | R&S | FSV40 | 101407 | Jul. 21, 2022 | 1 Year |
| Wideband Radio Communication tester | R&S | CMW500 | 117491 | May 18, 2022 | 1 Year |
| Vector Signal Generator | Agilent | N5182A | MY19060405 | May 18, 2022 | 1 Year |
| Vector Signal Generator | Agilent | N5182A | MY48180912 | May 18, 2022 | 1 Year |
| RF Control Unit | Tonscend | JS0806-2 | 20C8060230 | May 18, 2022 | 1 Year |
| Temp&Humi Programmable | ZHIXIANG | ZXGDJS-150L | ZX170110-A | May 26, 2022 | 1 Year |
| Test Software | JS Tonscend | JS1120-3 | Ver.3.2.22 | N/A | N/A |
| <input checked="" type="checkbox"/>Radiation 3#chamber | | | | | |
| EMI Test Receiver | R&S | ESU26 | 100472 | May 19, 2022 | 1 Year |
| Spectrum analyzer | Agilent | E4447A | MY50180031 | May 17, 2022 | 1 Year |
| Active Loop antenna | Schwarzbeck | FMZB-1519 | 1519-038 | Sep. 29, 2022 | 1 Year |
| Trilog Broadband Antenna | Schwarzbeck | VULB 9163 | 01429 | Jul. 22, 2022 | 1 Year |
| Double Ridged Horn Antenna | Schwarzbeck | BBHA9120 D | 02468 | Sep. 29, 2022 | 1 Year |
| Broad Band Horn Antenna | Schwarzbeck | BBHA 9170 | 790 | May 06, 2022 | 1 Year |
| Pre-amplifier | COM-POWER | PAM-118A | 18040084 | Aug.17, 2022 | 1 Year |
| Pre-amplifier | COM-POWER | PAM-840A | 461369 | Apr. 11, 2022 | 1 Year |
| RE Cable | N/A | W23.02 CP1-X2 + W23.09 AP1-X8+ JCT26S-NJ-NJ-1.5M+ JCT26S-NJ-NJ-1.5M | 4.5M+8M+1.5M+1.5M | Aug.17, 2022 | 1 Year |
| RF Cable | Yuhu Technology | JCTB810-NJ-NJ-9M | 21123964 | May. 19, 2022 | 1 Year |
| RF Cable | Yuhu Technology | ZT26S-SMAJ-SMAJ-1M | 21073466 | Aug.17, 2022 | 1 Year |
| Test software | Tonscend | JS32-RE | V 5.0.0.1 | N/A | N/A |
| <input type="checkbox"/>Power Line Conducted Emissions Test 1# | | | | | |
| Test Receiver | R&S | ESCI | 100551 | Aug. 26, 2022 | 1 Year |
| LISN 1 | R&S | ENV216 | 101109 | Aug. 26, 2022 | 1 Year |
| LISN 2 | R&S | ESH2-Z5 | 100309 | Aug. 26, 2022 | 1 Year |
| Pulse Limiter | R&S | ESH3-Z2 | 101242 | Aug. 26, 2022 | 1 Year |
| CE Cable 1 | HUBSER | N/A | W10.01 | Aug. 26, 2022 | 1 Year |
| Test software | Audix | E3 | V 6.11111b | N/A | N/A |
| Test Receiver | R&S | ESCI | 100551 | Aug. 26, 2022 | 1 Year |

4. 20 dB Bandwidth

4.1. Block diagram of test setup

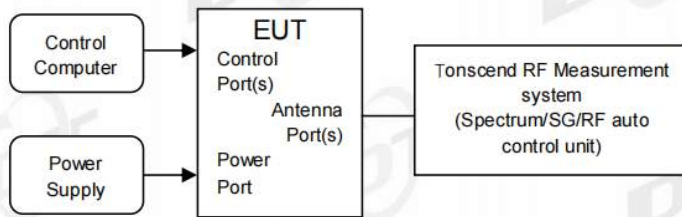

4.2. Limits

Intentional radiators operating under the alternative provisions to the general emission limits, as contained in § 15.217 through 15.257 and in Subpart E of this part, must be designed to ensure that the 20 dB bandwidth of the emission, or whatever bandwidth may otherwise be specified in the specific rule section under which the equipment operates, is contained within the frequency band designated in the rule section under which the equipment is operated.

4.3. Test procedure

- (1) The test according to ANSI C63.10-2013 clause 6.9.2.
- (2) Connect EUT's antenna output to spectrum analyzer by RF cable, the path loss was compensated to the results
- (3) Set the EUT as maximum power setting and enable the EUT transmit continuously
- (4) Use the following spectrum analyzer settings for the 20 dB bandwidth measurement:

| | |
|----------------|-------------------------------------|
| RBW: | 1% to 5% of the OBW |
| VBW: | approximately three times RBW |
| Span: | between 2 times and 5 times the OBW |
| Detector Mode: | Peak |
| Sweep time: | Auto |
| Trace mode: | Max hold |
- (5) Measure and record the results in the report.

4.4. test result

| Test Mode | Antenna | Frequency [MHz] | 20dB EBW[MHz] |
|-----------|---------|-----------------|---------------|
| DH5 | Ant1 | 2402 | 0.95 |
| | | 2441 | 0.94 |
| | | 2480 | 0.94 |
| 2DH5 | Ant1 | 2402 | 1.29 |
| | | 2441 | 1.28 |
| | | 2480 | 1.28 |
| 3DH5 | Ant1 | 2402 | 1.28 |
| | | 2441 | 1.28 |
| | | 2480 | 1.29 |

4.5. Test graphs



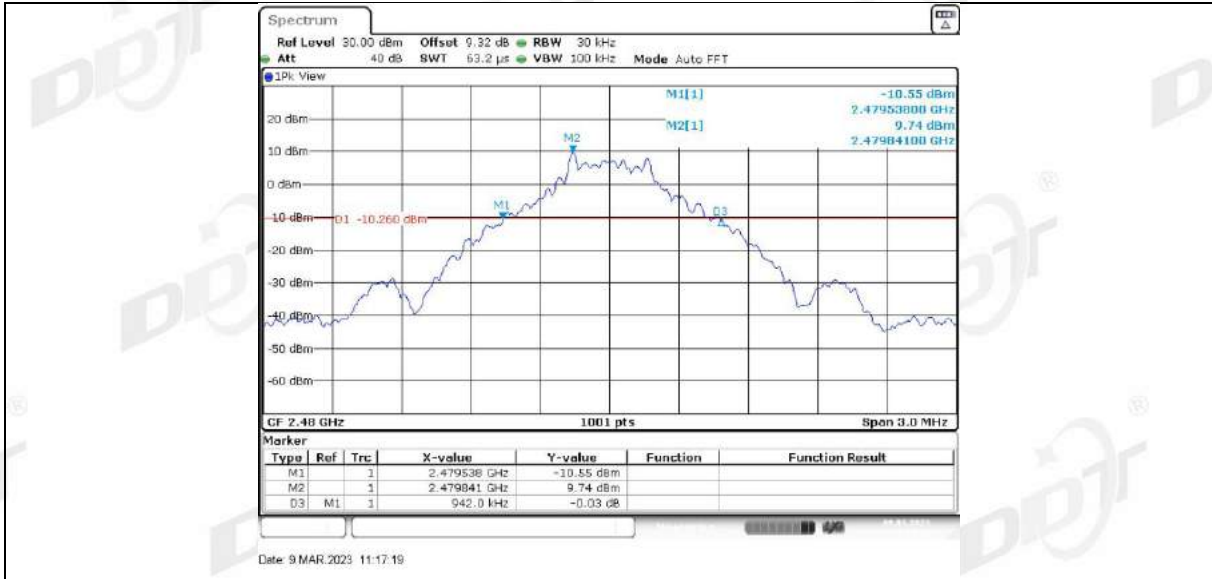

2DH5 Ant1_2402

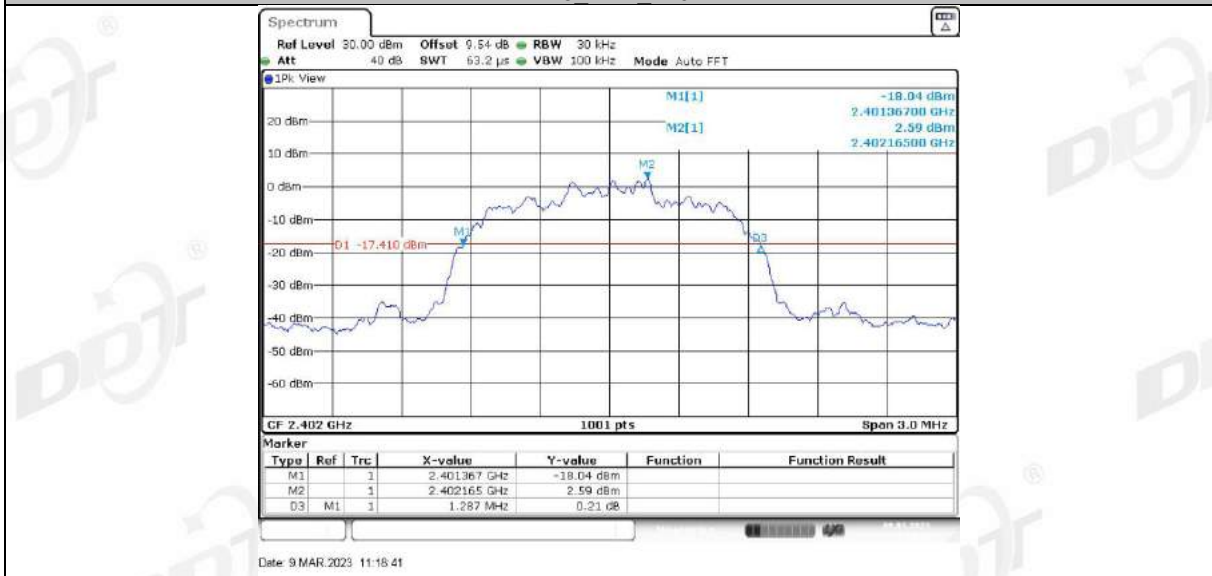

2DH5 Ant1_2441



2DH5 Ant1_2480



3DH5 Ant1_2402



3DH5 Ant1_2441

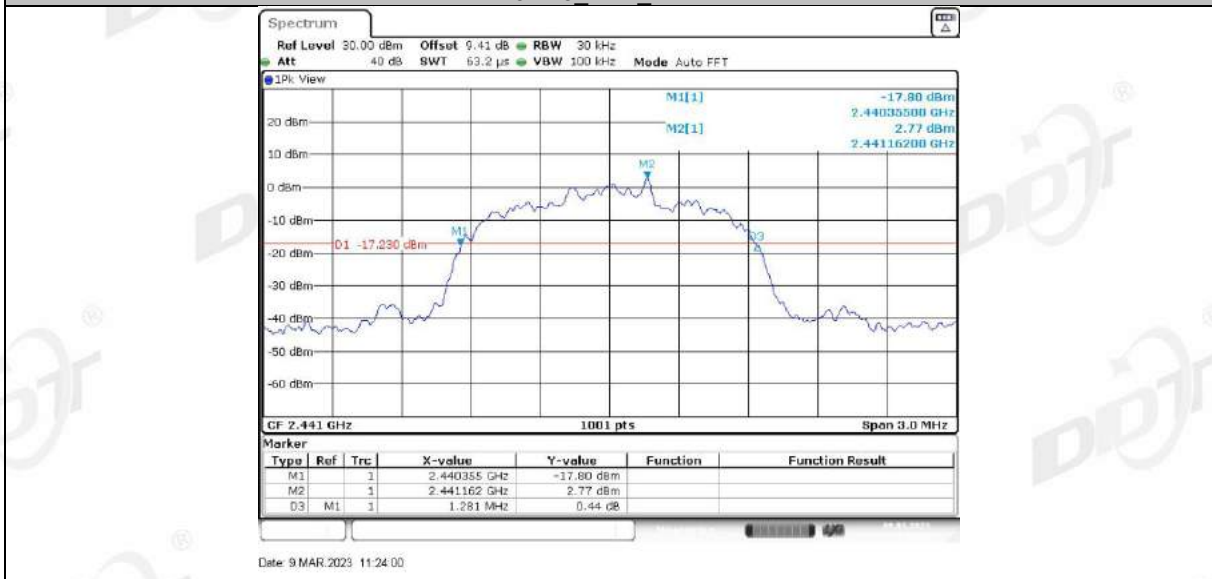

3DH5 Ant1_2480

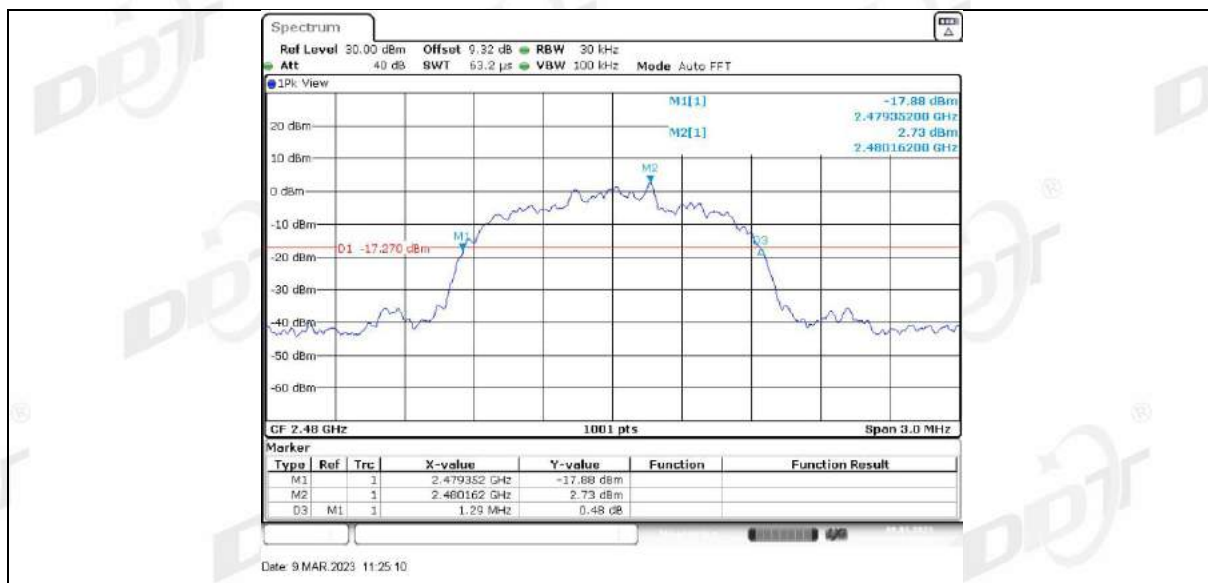

5. 99% Bandwidth

5.1. Block diagram of test setup

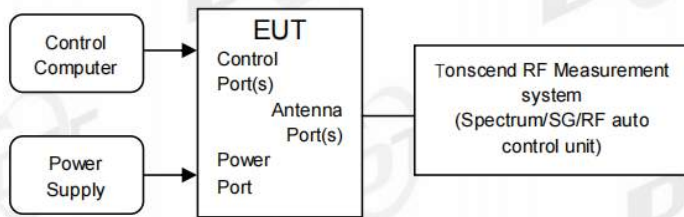

5.2. Limits

Just for Report.

5.3. Test procedure

- (1) The test according to ANSI C63.10-2013 clause 6.9.3.
- (2) Connect EUT's antenna output to spectrum analyzer by RF cable, the path loss was compensated to the results
- (3) Set the EUT as maximum power setting and enable the EUT transmit continuously
- (4) Use the following spectrum analyzer settings for the 99% bandwidth measurement:

| | |
|----------------|---|
| RBW: | 1% to 5% of the OBW |
| VBW: | approximately three times RBW |
| Span: | between 1.5 times and 5.0 times the OBW |
| Detector Mode: | Peak |
| Sweep time: | Auto |
| Trace mode: | Max hold |
- (5) Measure and record the results in the report.

5.4. Test Result

| Test Mode | Antenna | Frequency [MHz] | OCB [MHz] | FL[MHz] | FH[MHz] |
|-----------|---------|-----------------|-----------|-----------|-----------|
| DH5 | Ant1 | 2402 | 0.896 | 2401.5564 | 2402.4525 |
| | | 2441 | 0.893 | 2440.5564 | 2441.4496 |
| | | 2480 | 0.896 | 2479.5564 | 2480.4525 |
| 2DH5 | Ant1 | 2402 | 1.160 | 2401.4186 | 2402.5784 |
| | | 2441 | 1.157 | 2440.4186 | 2441.5754 |
| | | 2480 | 1.157 | 2479.4186 | 2480.5754 |
| 3DH5 | Ant1 | 2402 | 1.163 | 2401.4216 | 2402.5844 |
| | | 2441 | 1.163 | 2440.4216 | 2441.5844 |
| | | 2480 | 1.163 | 2479.4216 | 2480.5844 |

5.5. Test Graphs





2DH5 Ant1_2402

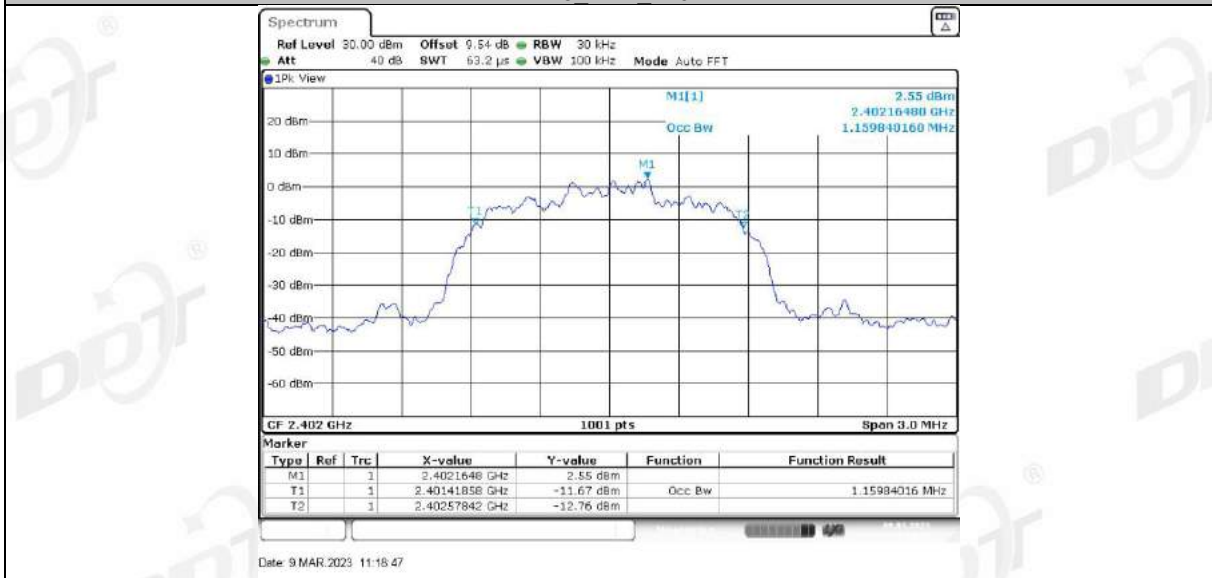

2DH5 Ant1_2441



2DH5 Ant1_2480



3DH5 Ant1_2402

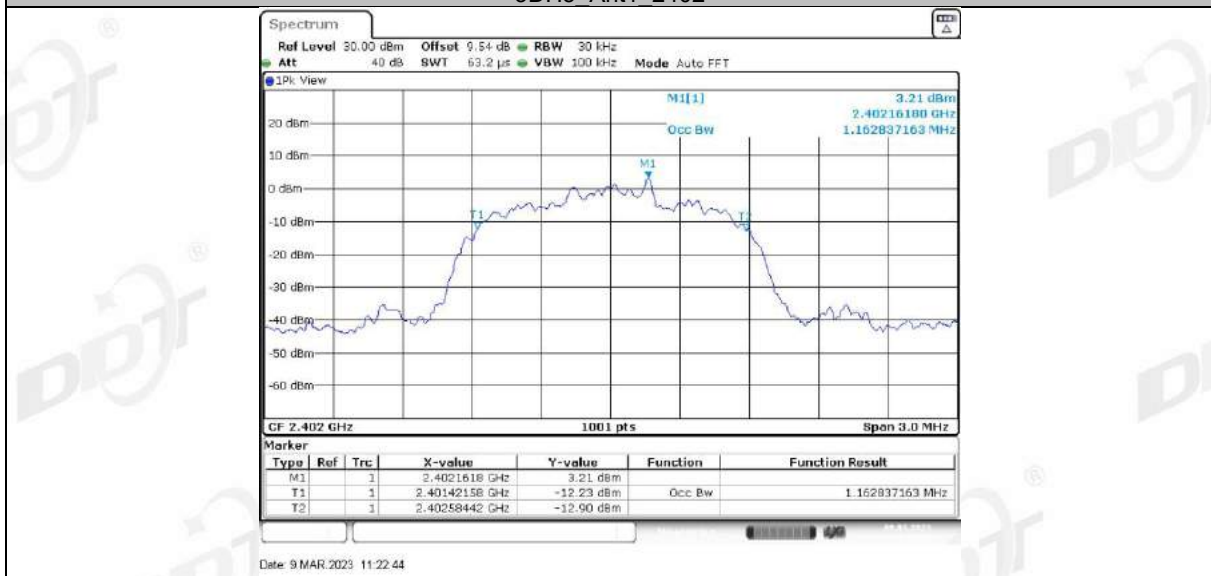

3DH5 Ant1_2441

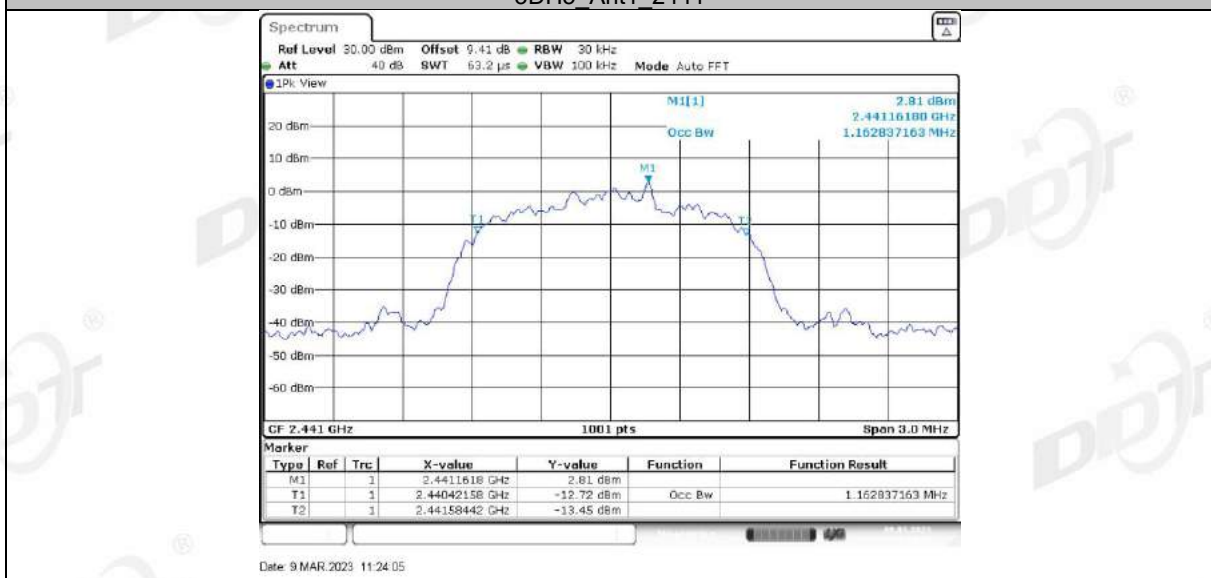

3DH5 Ant1_2480

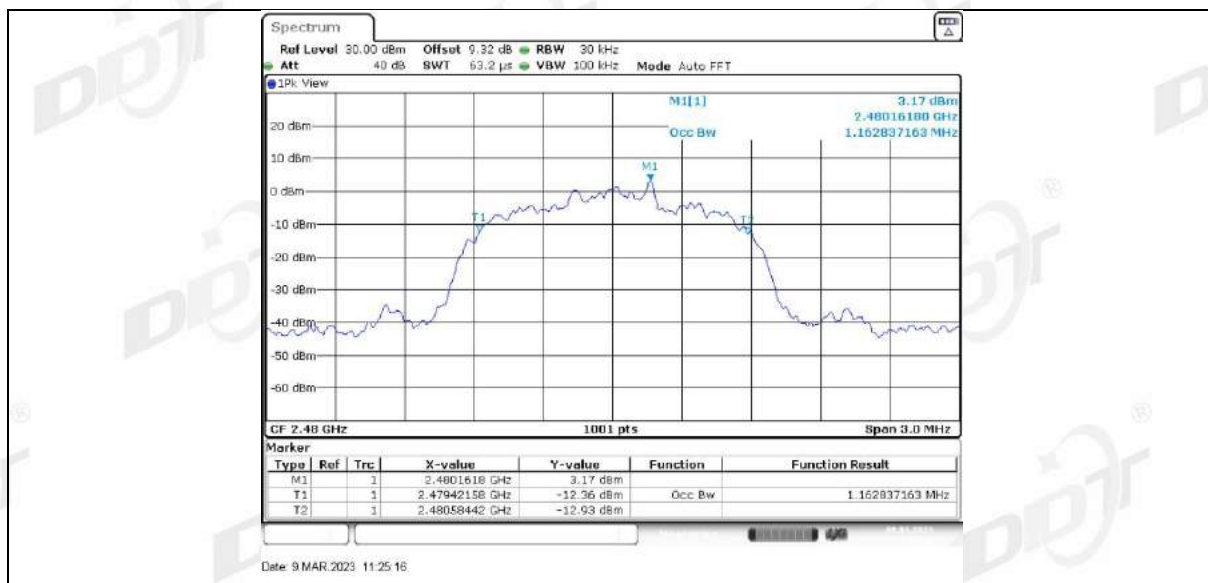

6. Maximum Peak Output Power

6.1. Block diagram of test setup

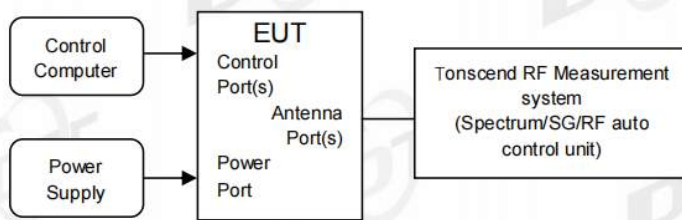

6.2. Limits

For frequency hopping systems operating in the 2400-2483.5 MHz band employing at least 75 non-overlapping hopping channels, and all frequency hopping systems in the 5725-5850 MHz band: 1 watt. For all other frequency hopping systems in the 2400-2483.5 MHz band: 0.125 watts, the e.i.r.p shall not exceed 4W.

6.3. Test procedure

- (1) The test according to ANSI C63.10-2013 clause 7.8.5.
- (2) Connect EUT's antenna output to spectrum analyzer by RF cable, the path loss was compensated to the results.
- (3) Set the EUT as maximum power setting and enable the EUT transmit continuously.
- (4) Use the following spectrum analyzer settings for the maximum peak output power measurement:

| | |
|----------------|--|
| RBW: | > 20 dB bandwidth of the emission being measured. |
| VBW: | $VBW \geq RBW$. |
| Span: | Approximately five times the 20 dB bandwidth, centered on a hopping channel. |
| Detector Mode: | Peak |
| Sweep time: | Auto |
| Trace mode: | Max hold |
- (5) Use the marker-to-peak function to set the marker to the peak of the emission and record the results in the report.

6.4. Test Result Peak

| Test Mode | Antenna | Frequency [MHz] | Conducted Peak Power[dBm] | Conducted Limit[dBm] | EIRP[dBm] | EIRP Limit[dBm] | Verdict |
|-----------|---------|-----------------|---------------------------|----------------------|--------------|-----------------|---------|
| DH5 | Ant1 | 2402 | 10.91 | ≤20.97 | 13.27 | ≤30 | PASS |
| | | 2441 | 10.72 | ≤20.97 | 13.08 | ≤30 | PASS |
| | | 2480 | 10.68 | ≤20.97 | 13.04 | ≤30 | PASS |
| 2DH5 | Ant1 | 2402 | 6.42 | ≤20.97 | 8.78 | ≤30 | PASS |
| | | 2441 | 5.83 | ≤20.97 | 8.19 | ≤30 | PASS |
| | | 2480 | 6.69 | ≤20.97 | 9.05 | ≤30 | PASS |
| 3DH5 | Ant1 | 2402 | 6.53 | ≤20.97 | 8.89 | ≤30 | PASS |
| | | 2441 | 6.21 | ≤20.97 | 8.57 | ≤30 | PASS |
| | | 2480 | 6.52 | ≤20.97 | 8.88 | ≤30 | PASS |

6.5. Test graphs



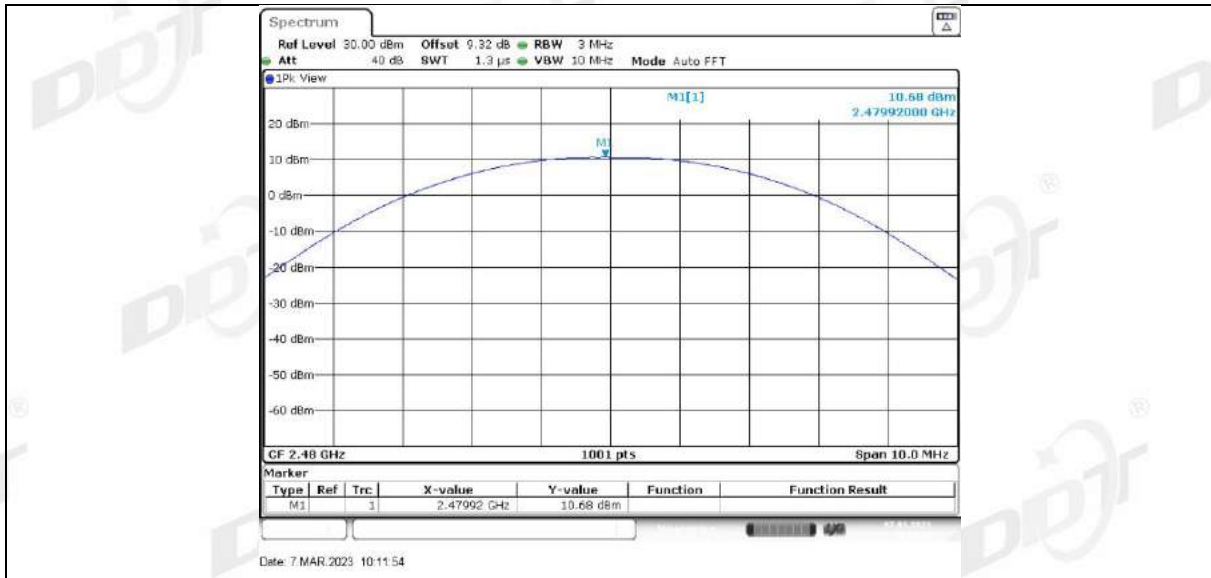

2DH5 Ant1_2402



2DH5 Ant1_2441

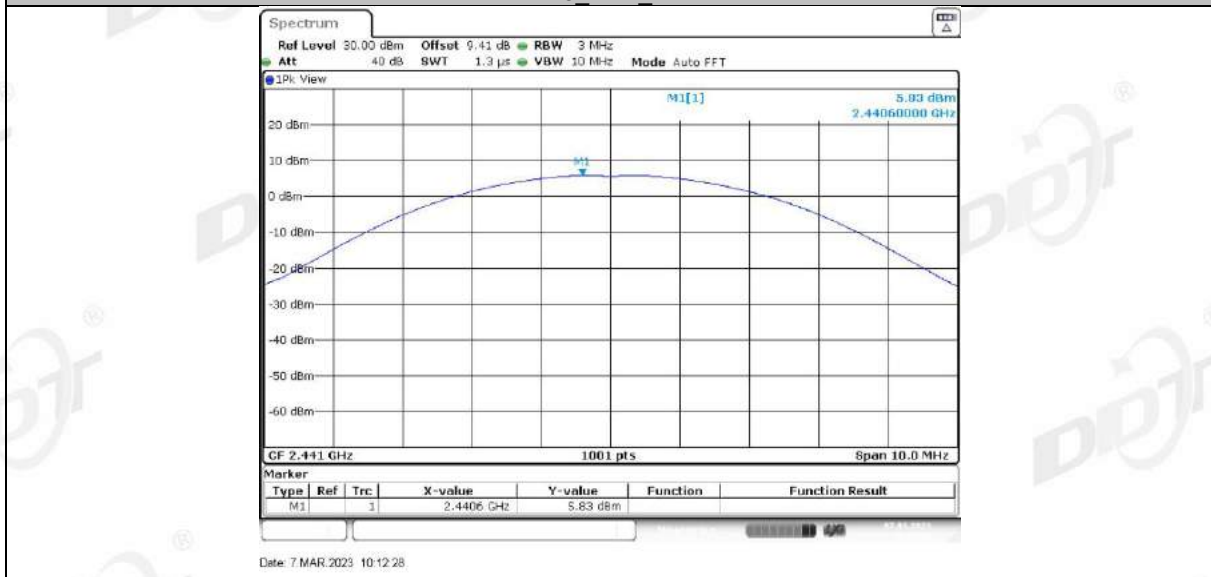

2DH5 Ant1_2480

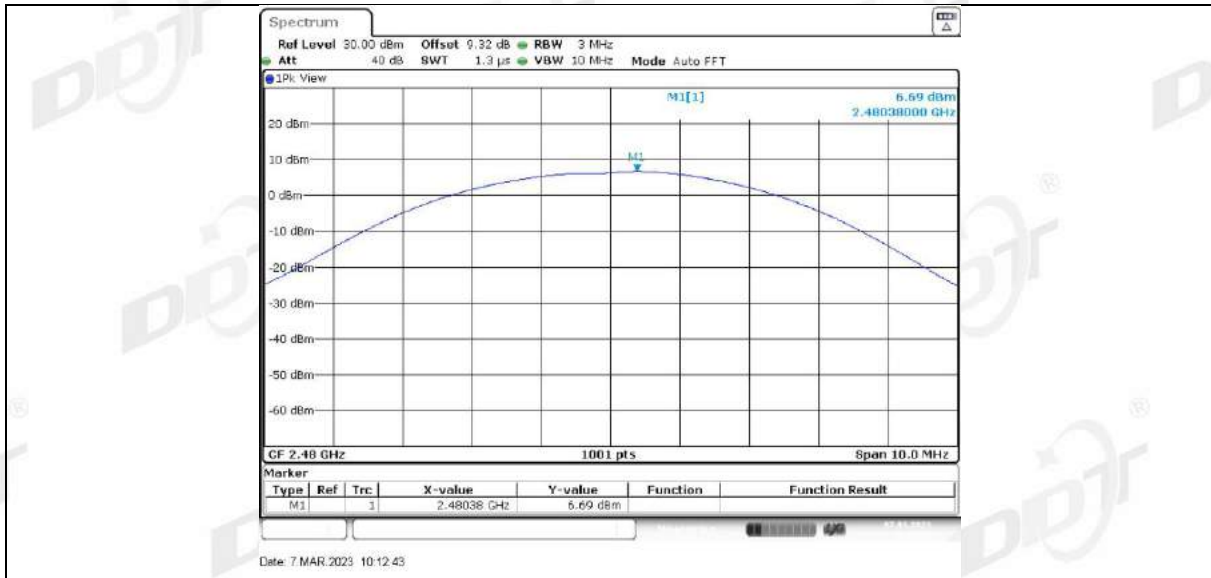

3DH5 Ant1_2402

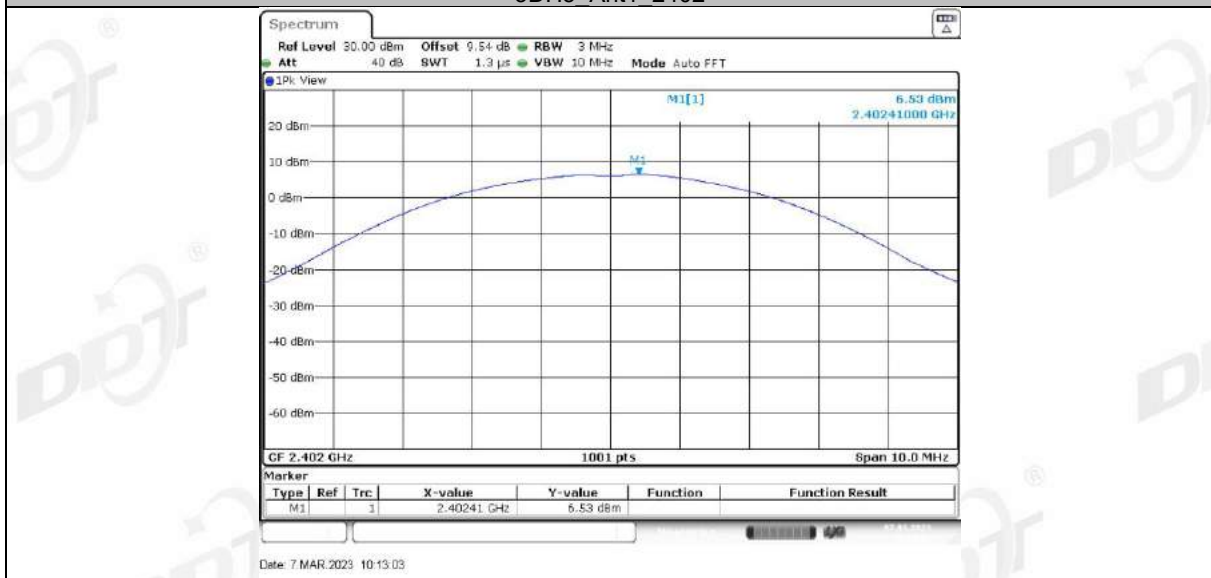

3DH5 Ant1_2441

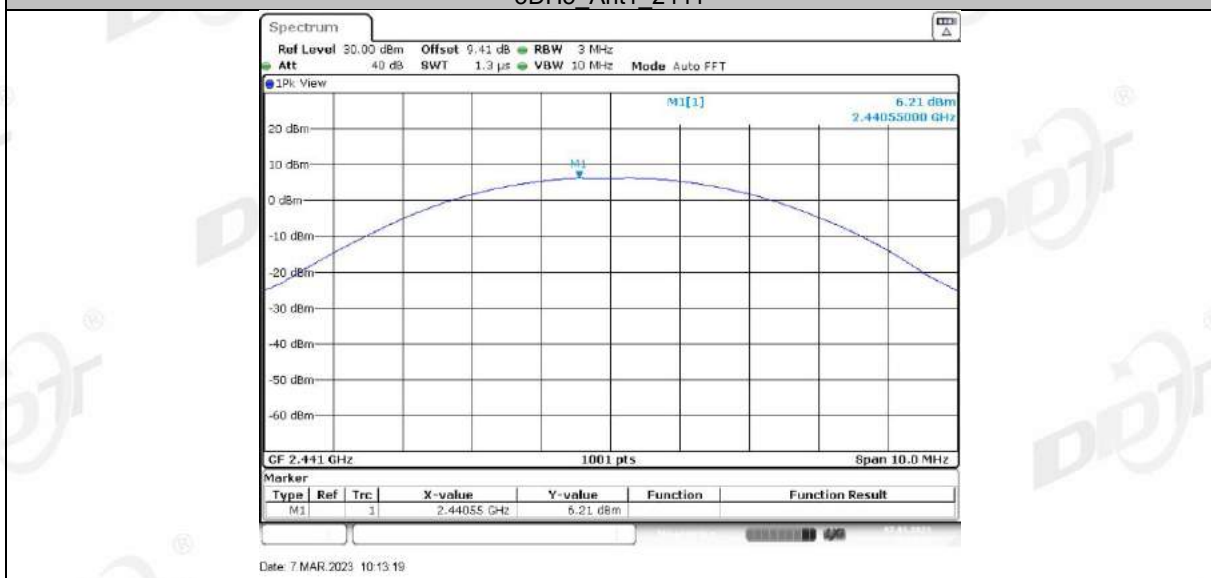

3DH5 Ant1_2480

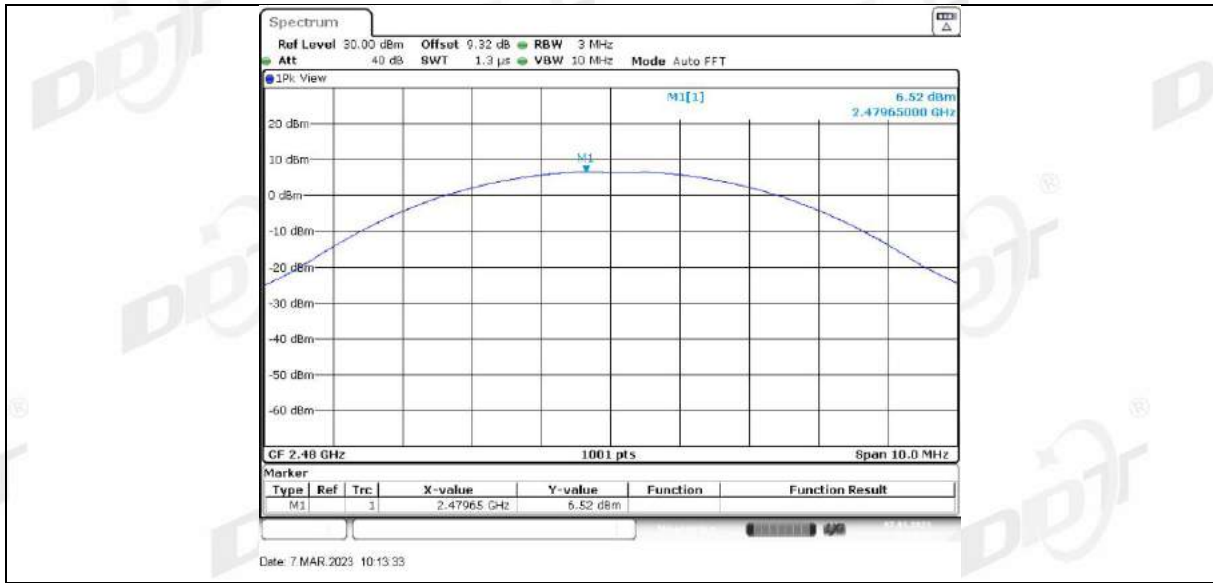

7. Carrier Frequency Separation

7.1. Block diagram of test setup

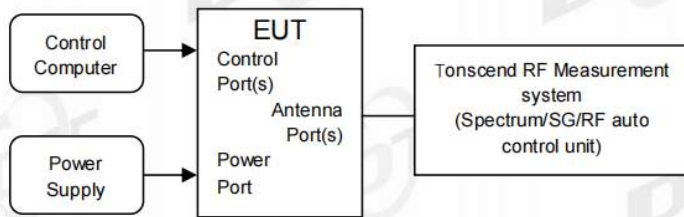

7.2. Limits

Frequency hopping systems shall have hopping channel carrier frequencies separated by a minimum of 25 kHz or the 20 dB bandwidth of the hopping channel, whichever is greater. Alternatively, frequency hopping systems operating in the 2400-2483.5 MHz band may have hopping channel carrier frequencies that are separated by 25 kHz or two-thirds of the 20 dB bandwidth of the hopping channel, whichever is greater, provided the systems operate with an output power no greater than 125 mW.

7.3. Test procedure

- (1) The test according to ANSI C63.10-2013 clause 7.8.2.
- (2) Connect EUT's antenna output to spectrum analyzer by RF cable, the path loss was compensated to the results.
- (3) Set the EUT as maximum power setting and enable the EUT transmit continuously.
- (4) Use the following spectrum analyzer settings for the maximum peak output power measurement:

| | |
|----------------|--|
| RBW: | approximately 30% of the channel spacing |
| VBW: | $VBW \geq RBW$. |
| Span: | Wide enough to capture the peaks of two adjacent channels. |
| Detector Mode: | Peak |
| Sweep time: | Auto |
| Trace mode: | Max hold |

- (5) Use the marker-delta function to determine the separation between the peaks of the adjacent channels and record the results in the report.

7.4. Test result

| Test Mode | Antenna | Frequency [MHz] | Result [MHz] | Limit [MHz] | Verdict |
|-----------|---------|-----------------|--------------|-------------|---------|
| DH5 | Ant1 | Hop | 0.997 | ≥0.633 | PASS |
| 2DH5 | Ant1 | Hop | 0.994 | ≥0.860 | PASS |
| 3DH5 | Ant1 | Hop | 0.997 | ≥0.860 | PASS |

7.5. Test graphs



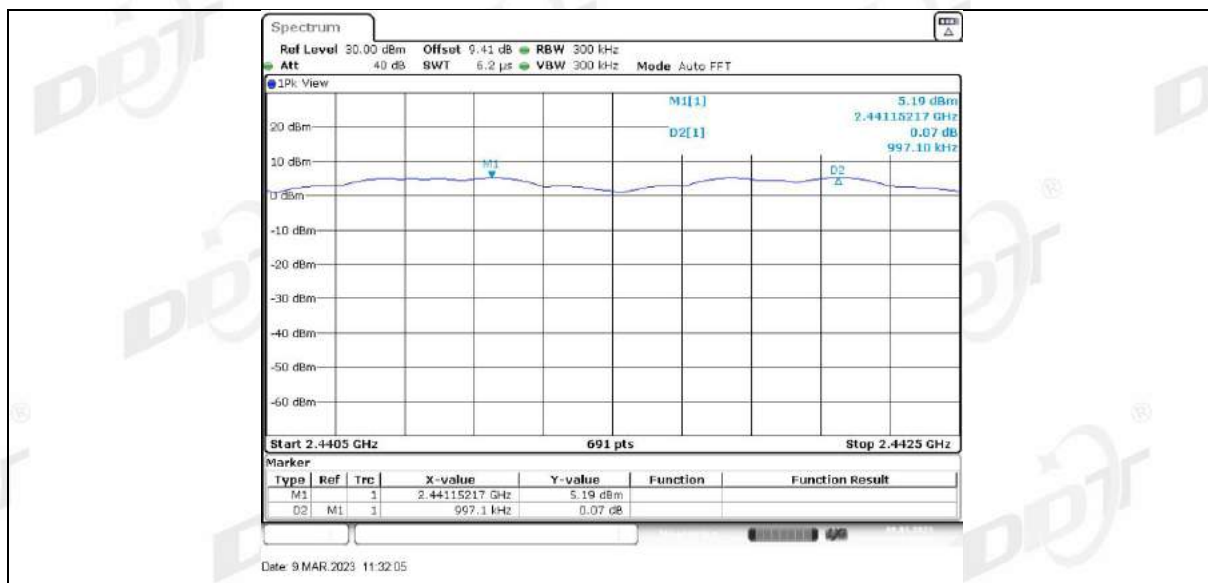

8. Dwell Time

8.1. Block diagram of test setup

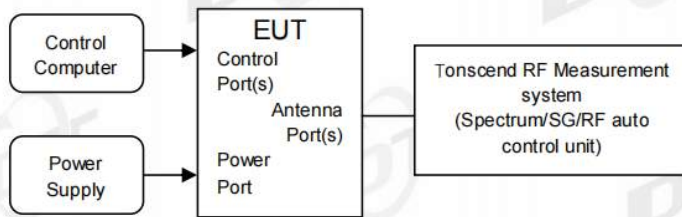

8.2. Limits

The average time of occupancy on any channel shall not be greater than 0.4 seconds within a period of 0.4 seconds multiplied by the number of hopping channels employed.

8.3. Test procedure

- (1) The test according to ANSI C63.10-2013 clause 7.8.4.
- (2) Connect EUT's antenna output to spectrum analyzer by RF cable, the path loss was compensated to the results.
- (3) Set the EUT as maximum power setting and enable the EUT transmit continuously.
- (4) Use the following spectrum analyzer settings for the maximum peak output power measurement:

| | |
|----------------|---|
| RBW: | \leq channel spacing and where possible RBW should be set $\gg 1 / T$ |
| VBW: | $VBW \geq RBW$. |
| Span: | Zero span, centered on a hopping channel. |
| Detector Mode: | Peak |
| Sweep time: | Auto |
| Trace mode: | Max hold |

Measure and record the results in the report.

- (5) The test period: $T = 0.4 \text{ Second/Channel} \times 79 \text{ Channel} = 31.6 \text{ s}$
- (6) Measure the hopping number and on time of each pulse with spectrum analyzer in zero span set, and calculate dwell time with formula $\text{Dwell time} = \text{total hops} \times \text{pulse's on time}$.

8.4. Test result

| Test Mode | Antenna | Frequency [MHz] | BurstWidth [ms] | TotalHops [Num] | Result[s] | Limit[s] | Verdict |
|-----------|---------|-----------------|-----------------|-----------------|-----------|----------|---------|
| DH1 | Ant1 | Hop | 0.37 | 314 | 0.116 | ≤0.4 | PASS |
| DH3 | Ant1 | Hop | 1.64 | 158 | 0.259 | ≤0.4 | PASS |
| DH5 | Ant1 | Hop | 2.89 | 100 | 0.289 | ≤0.4 | PASS |
| 2DH1 | Ant1 | Hop | 0.38 | 314 | 0.119 | ≤0.4 | PASS |
| 2DH3 | Ant1 | Hop | 1.63 | 159 | 0.259 | ≤0.4 | PASS |
| 2DH5 | Ant1 | Hop | 2.87 | 100 | 0.287 | ≤0.4 | PASS |
| 3DH1 | Ant1 | Hop | 0.37 | 314 | 0.116 | ≤0.4 | PASS |
| 3DH3 | Ant1 | Hop | 1.62 | 159 | 0.258 | ≤0.4 | PASS |
| 3DH5 | Ant1 | Hop | 2.88 | 113 | 0.325 | ≤0.4 | PASS |

8.5. Test graphs



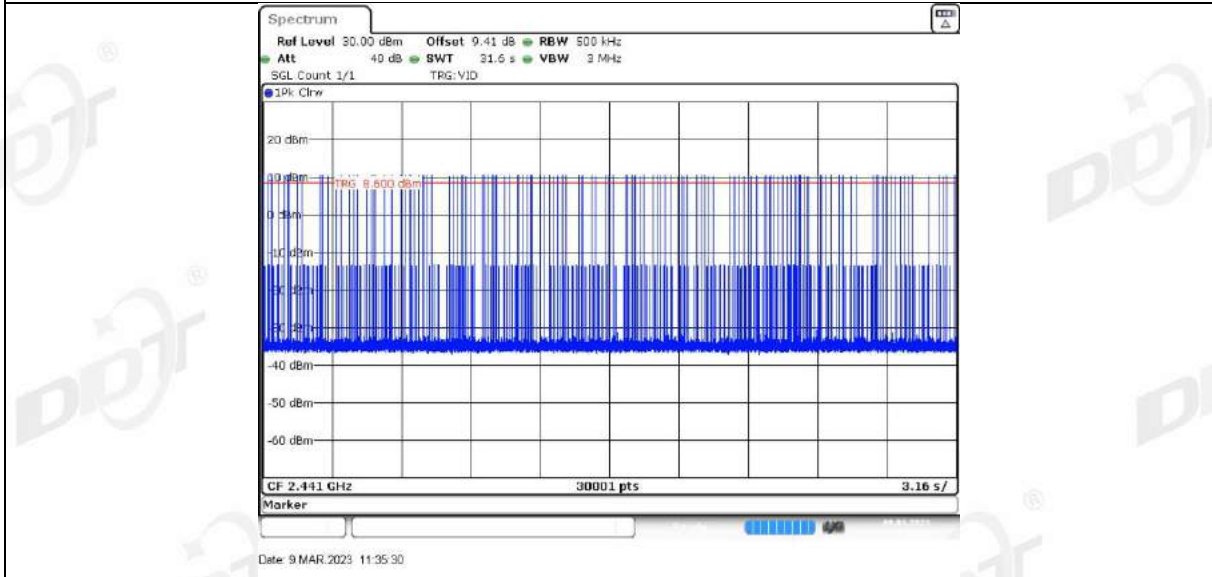
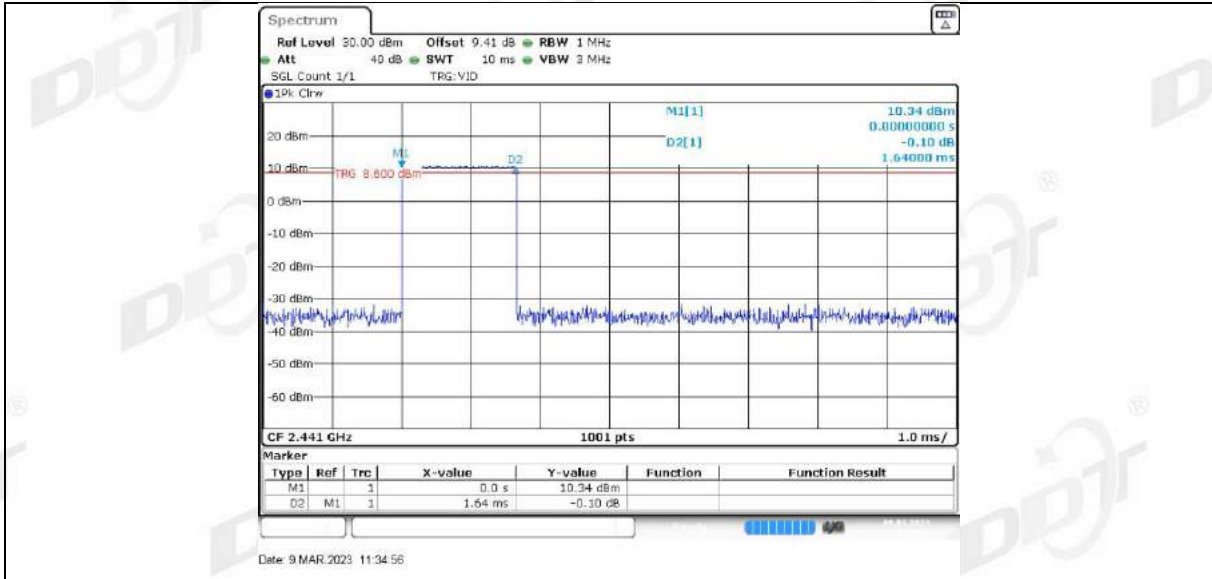

DH5_Ant1_Hop

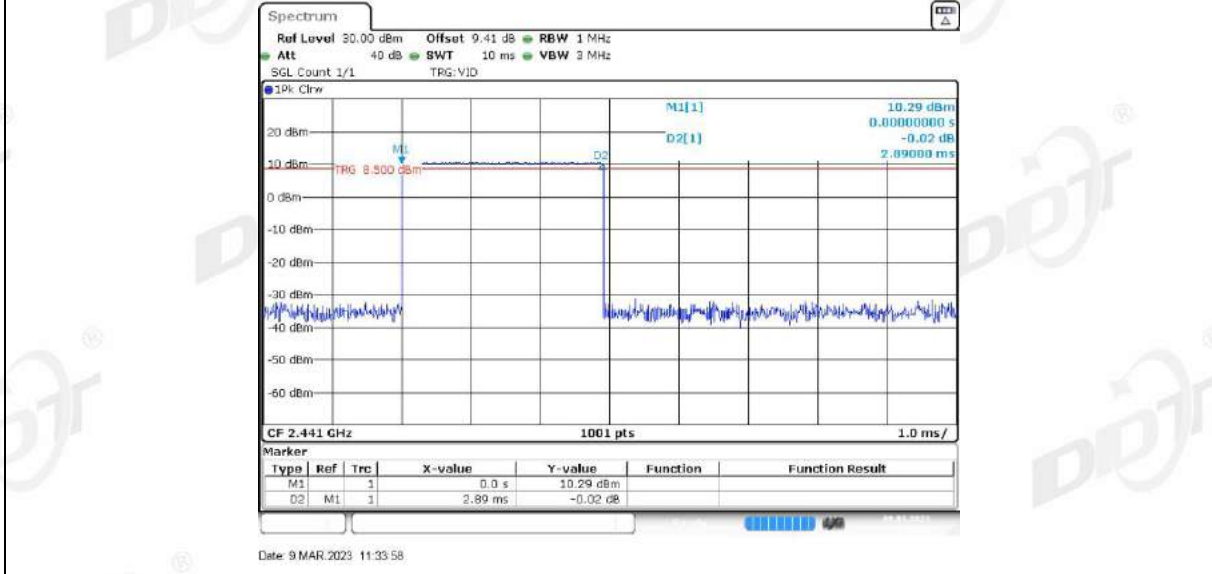

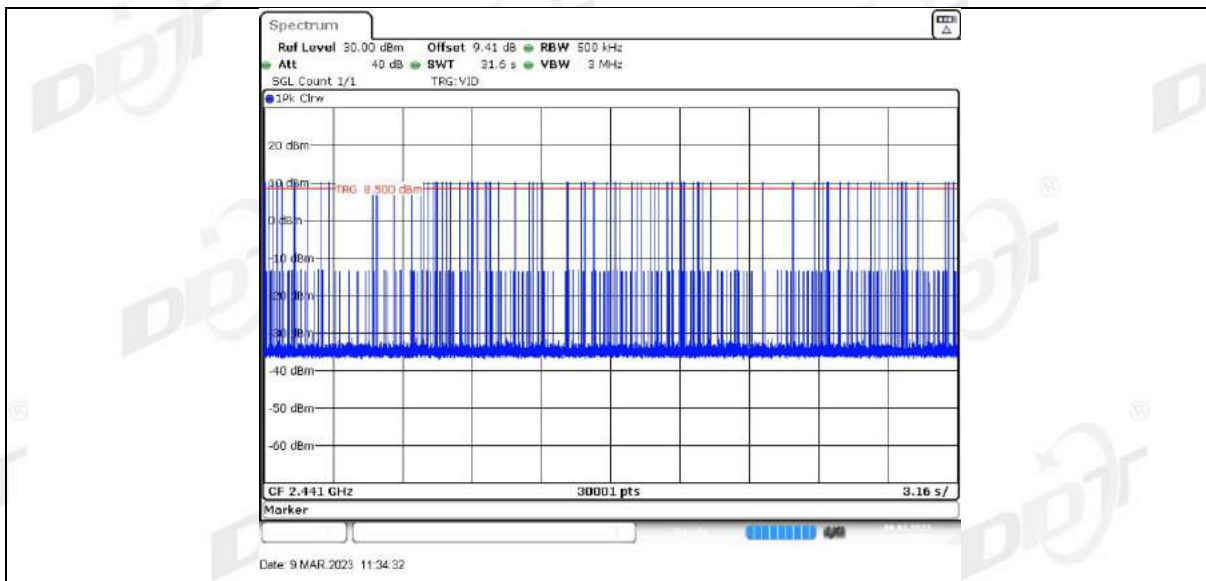

2DH1 Ant1 Hop

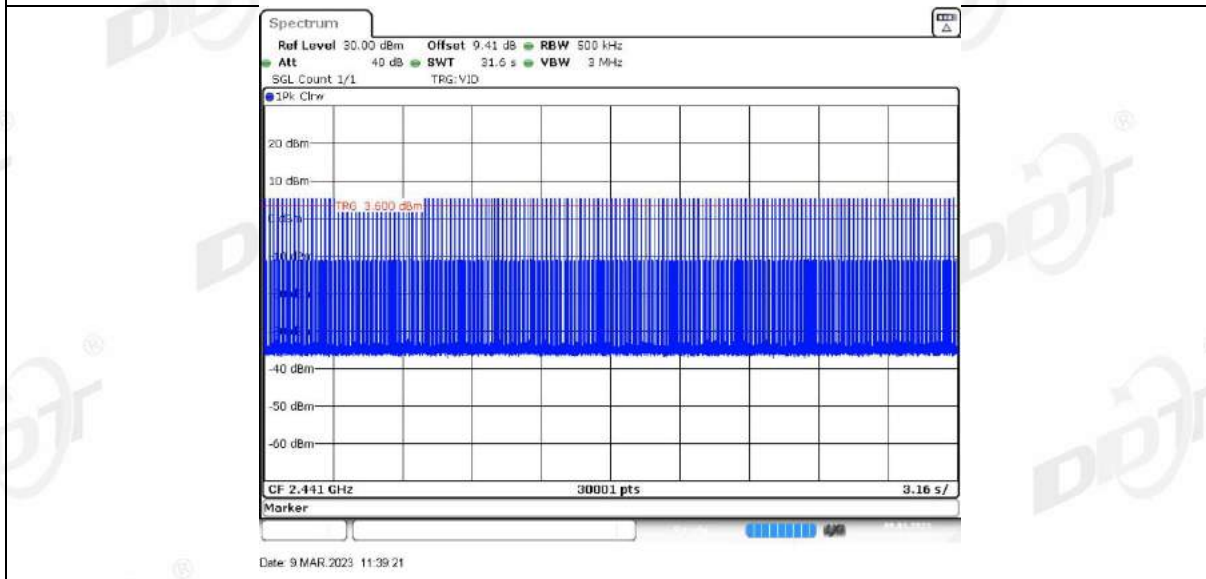
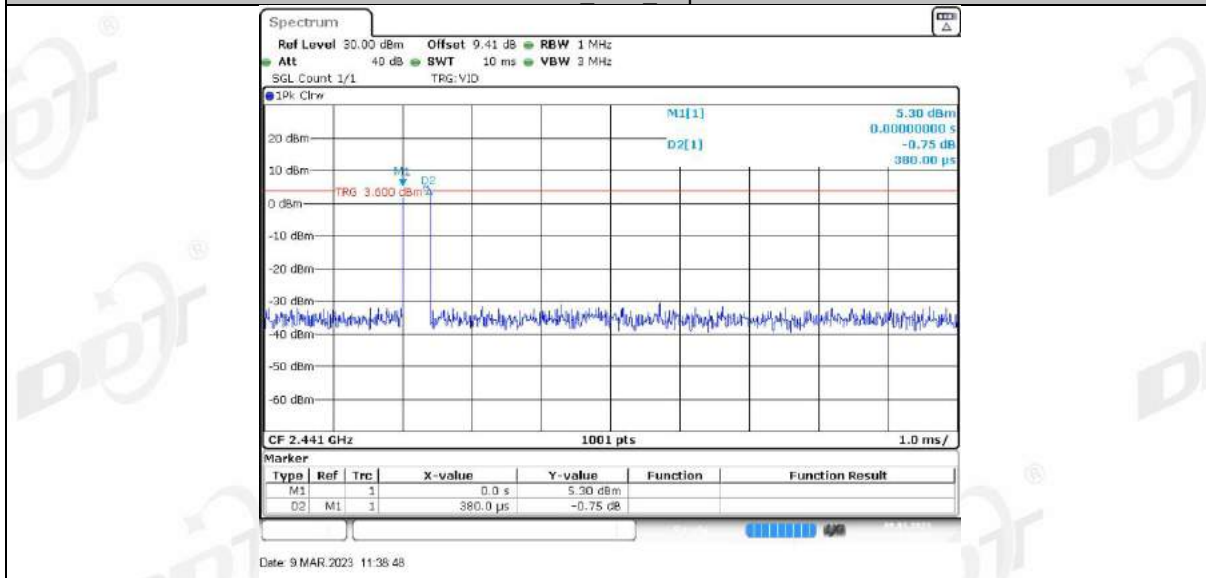

2DH3 Ant1 Hop

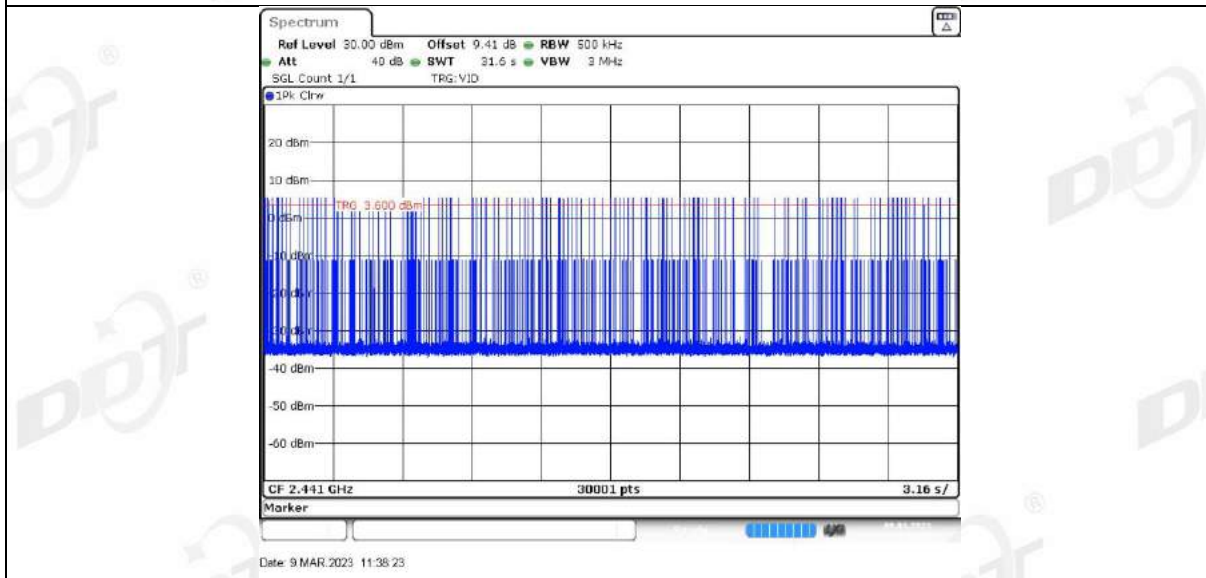
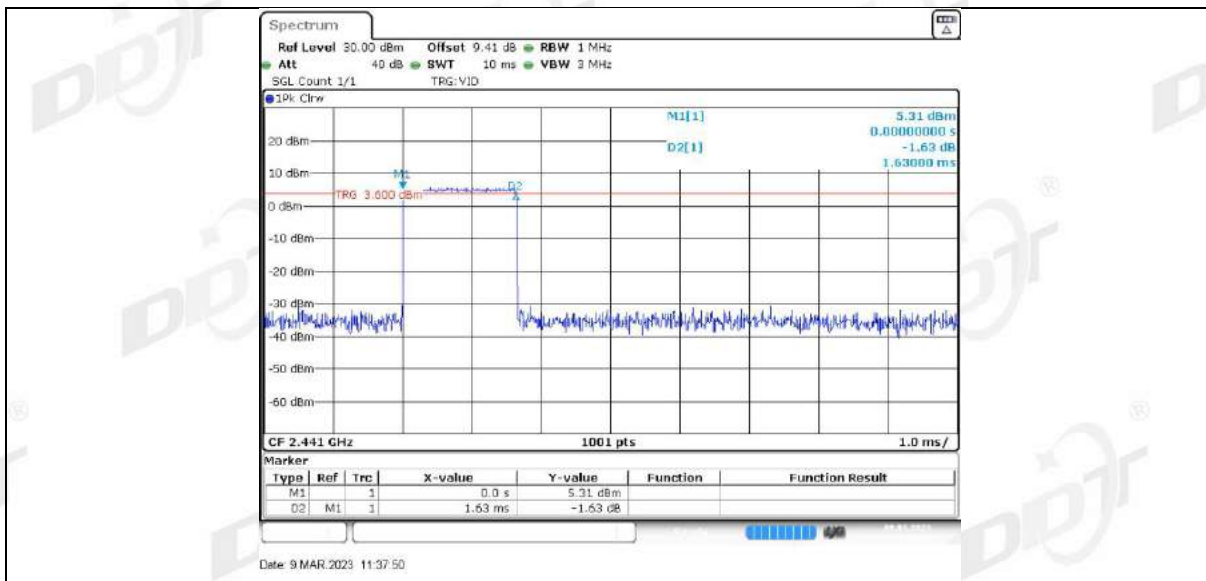

2DH5_Ant1_Hop

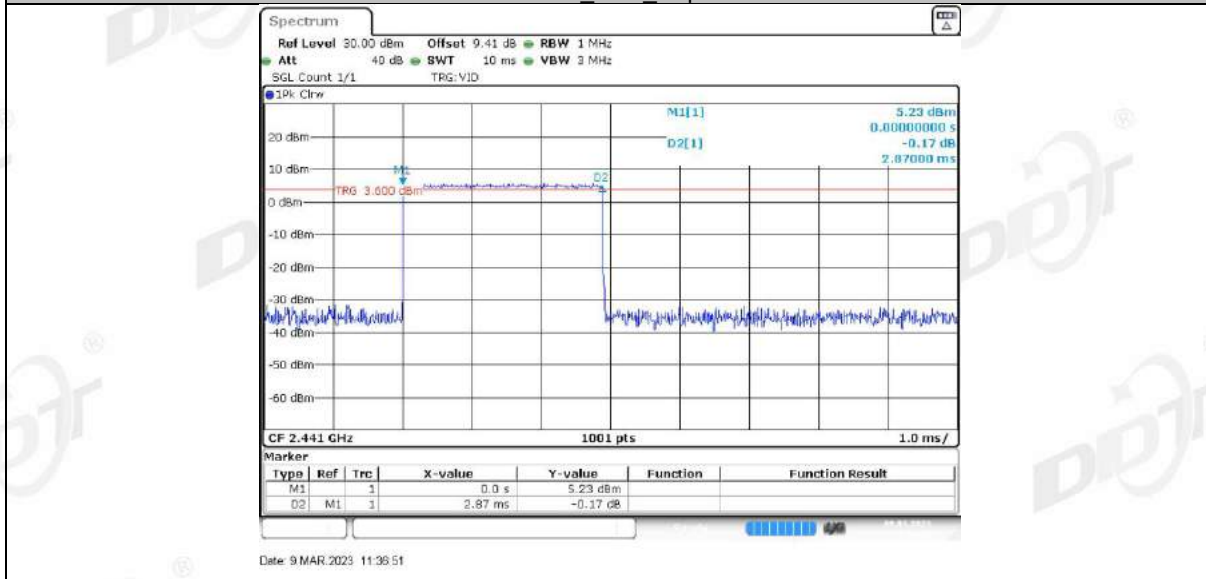

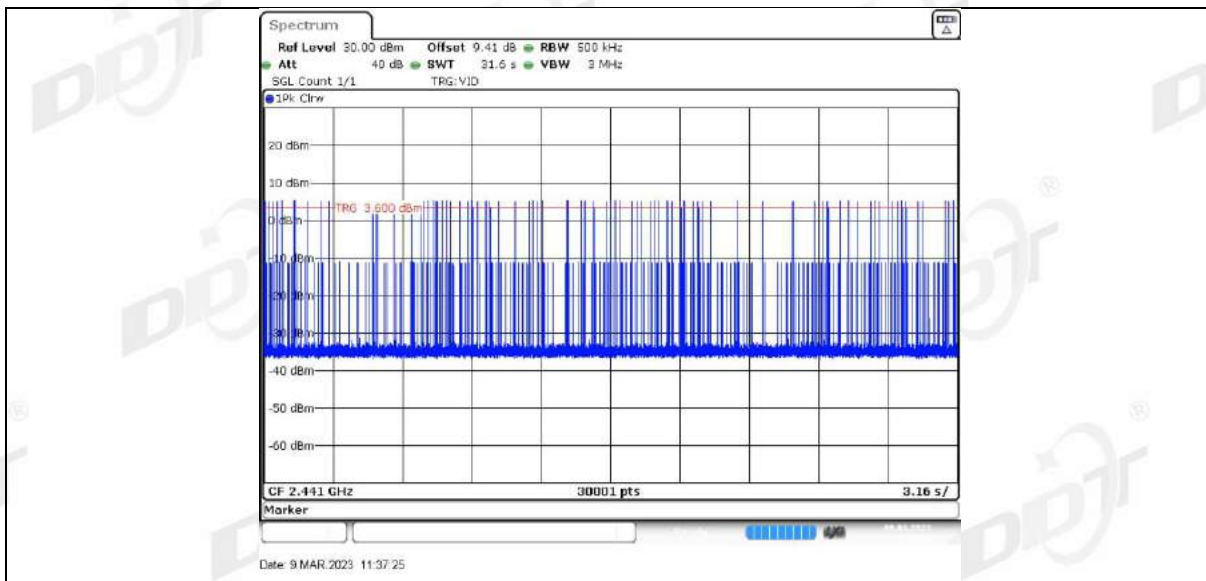

3DH1 Ant1 Hop

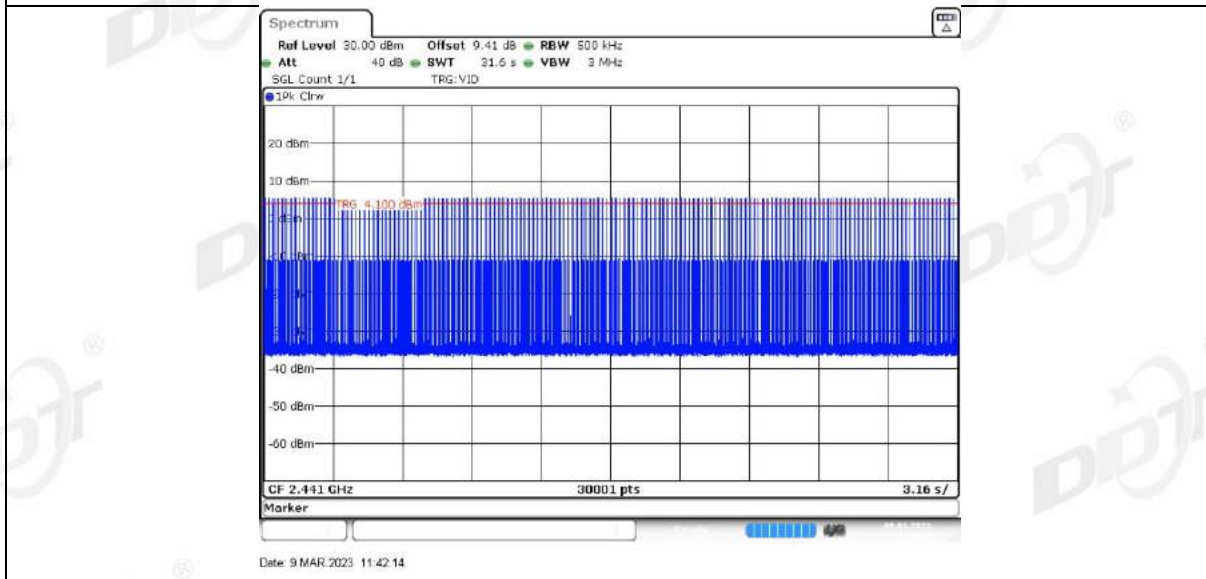
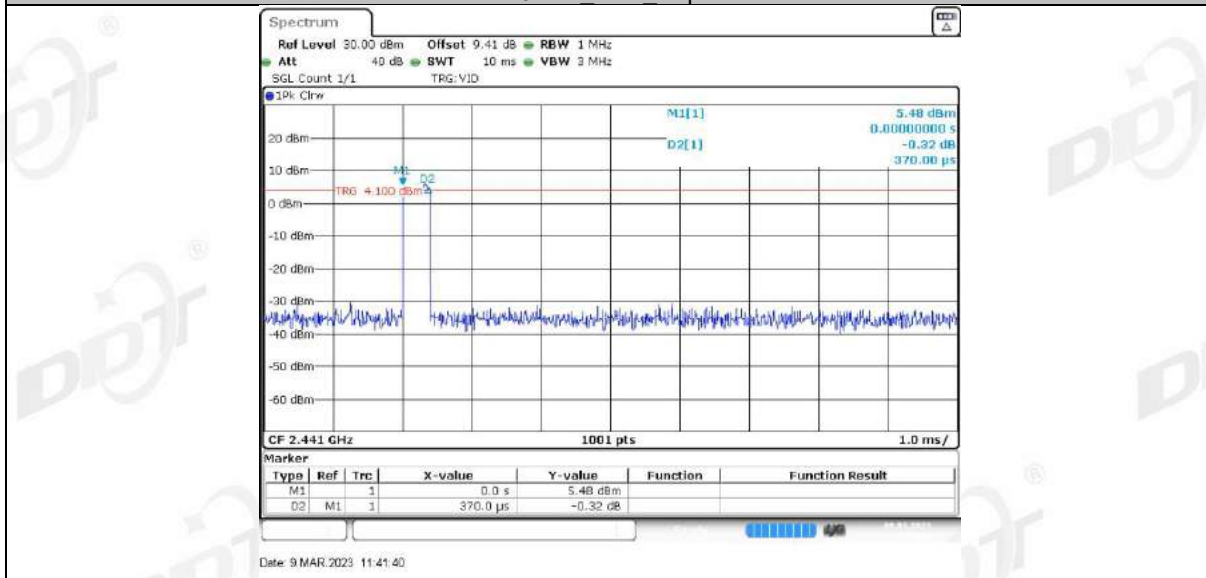

3DH3 Ant1 Hop

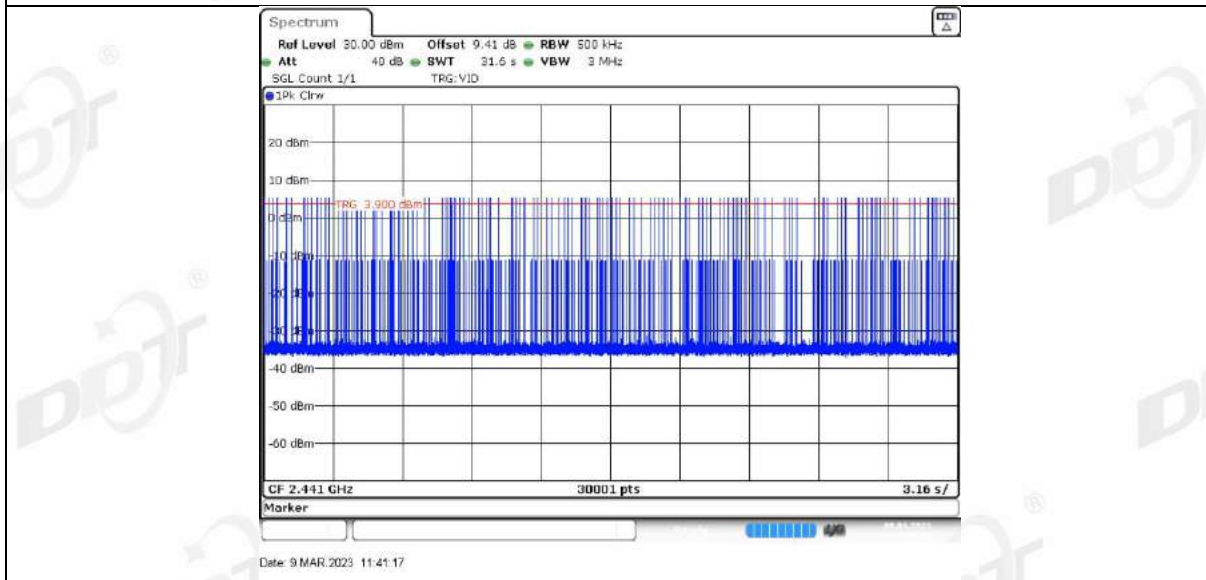
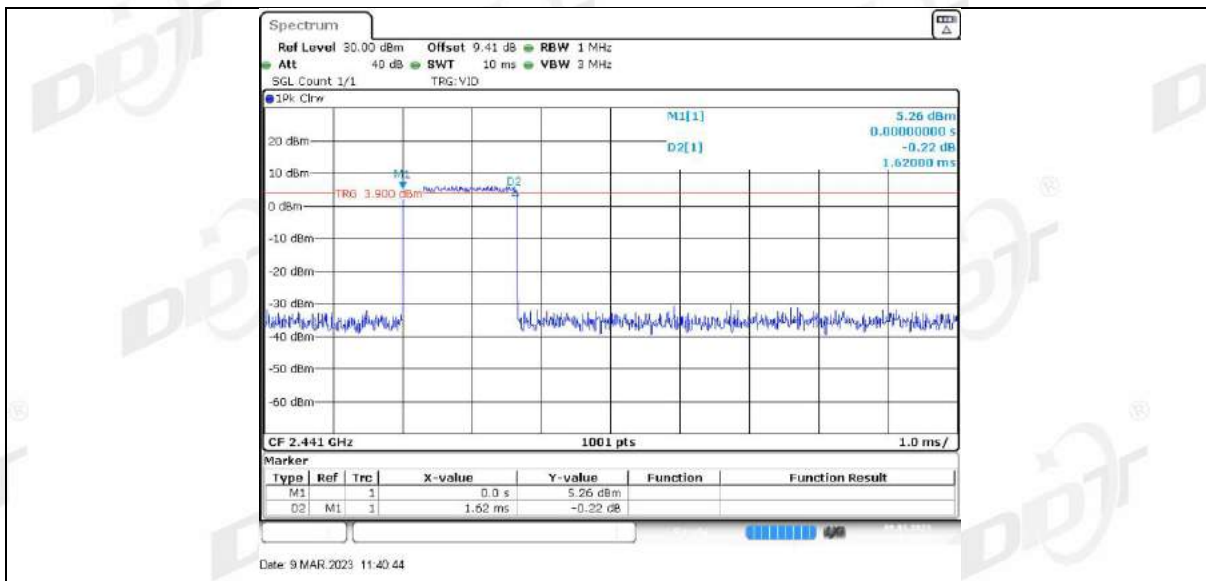

3DH5_Ant1_Hop

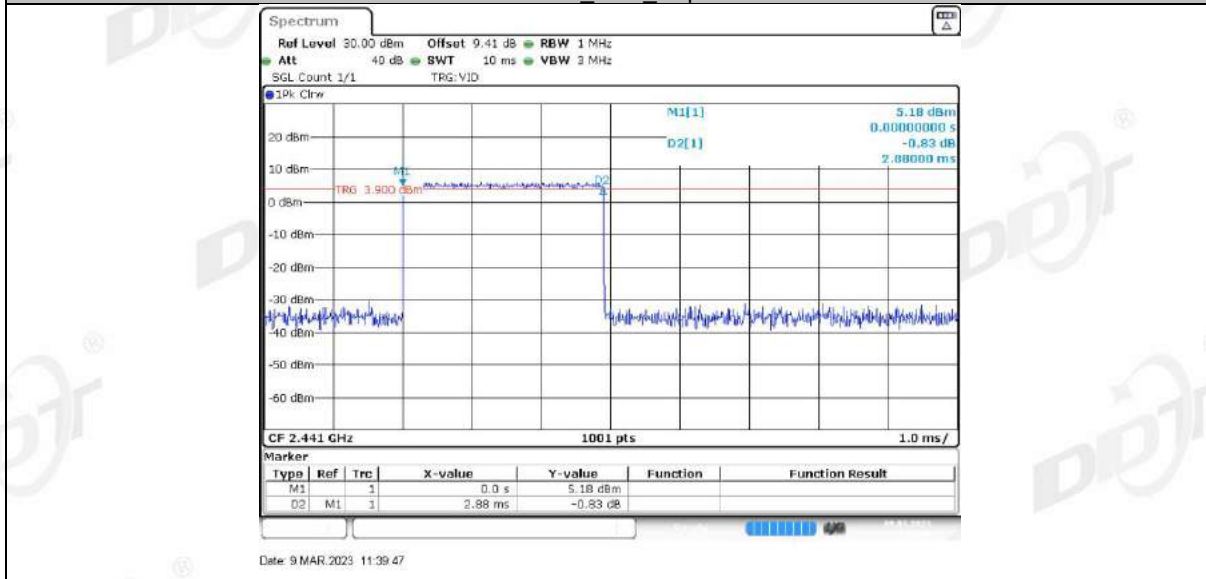

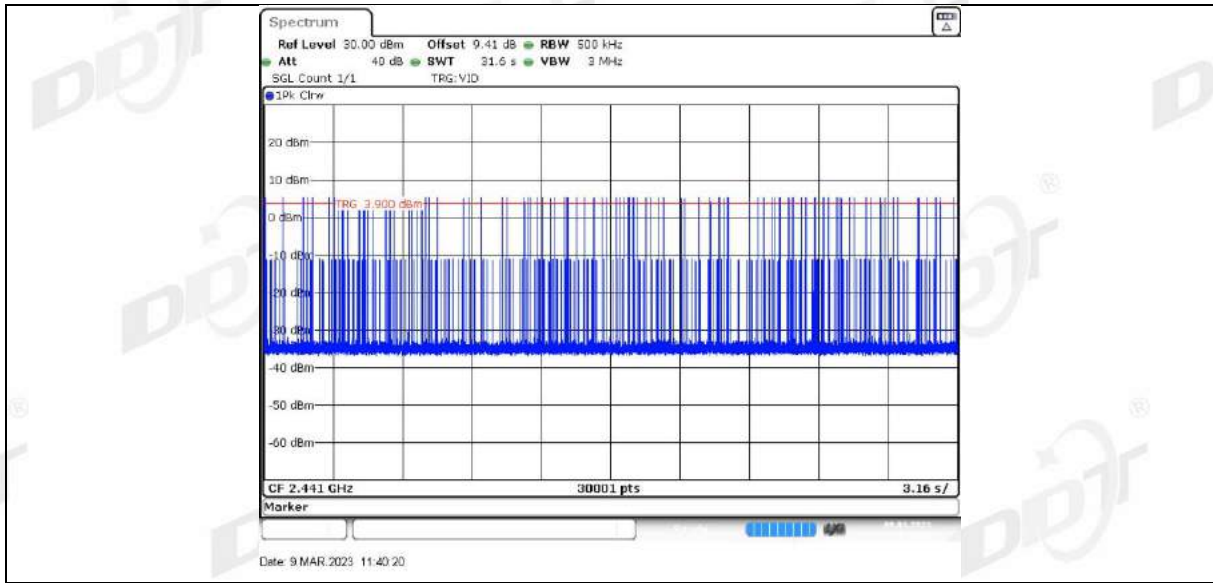

9. Number of Hopping Channel

9.1. Block diagram of test setup

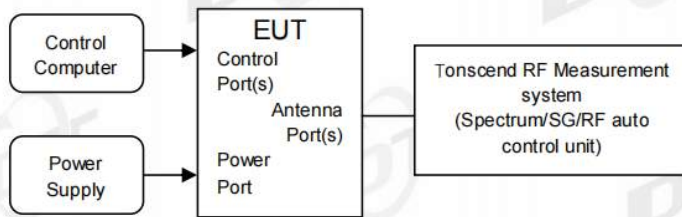

9.2. Limits

Frequency hopping systems in the 2400-2483.5 MHz band shall use at least 15 channels.

9.3. Test procedure

- (1) The test according to ANSI C63.10-2013 clause 7.8.3.
- (2) Connect EUT's antenna output to spectrum analyzer by RF cable, the path loss was compensated to the results.
- (3) Set the EUT as maximum power setting and enable the EUT transmit continuously.
- (4) Use the following spectrum analyzer settings for the maximum peak output power measurement:

| | |
|----------------|---|
| RBW: | RBW to less than 30% of the channel spacing or the 20 dB bandwidth, whichever is smaller. |
| VBW: | VBW \geq RBW. |
| Span: | The frequency band of operation |
| Detector Mode: | Peak |
| Sweep time: | Auto |
| Trace mode: | Max hold |

Measure and record the results in the report.

- (5) Measure the hopping number and record the results in the report.

9.4. Test result

| Test Mode | Antenna | Frequency [MHz] | Result [Num] | Limit [Num] | Verdict |
|-----------|---------|-----------------|--------------|-------------|---------|
| DH5 | Ant1 | Hop | 79 | ≥15 | PASS |
| 2DH5 | Ant1 | Hop | 79 | ≥15 | PASS |
| 3DH5 | Ant1 | Hop | 79 | ≥15 | PASS |

9.5. Test graphs



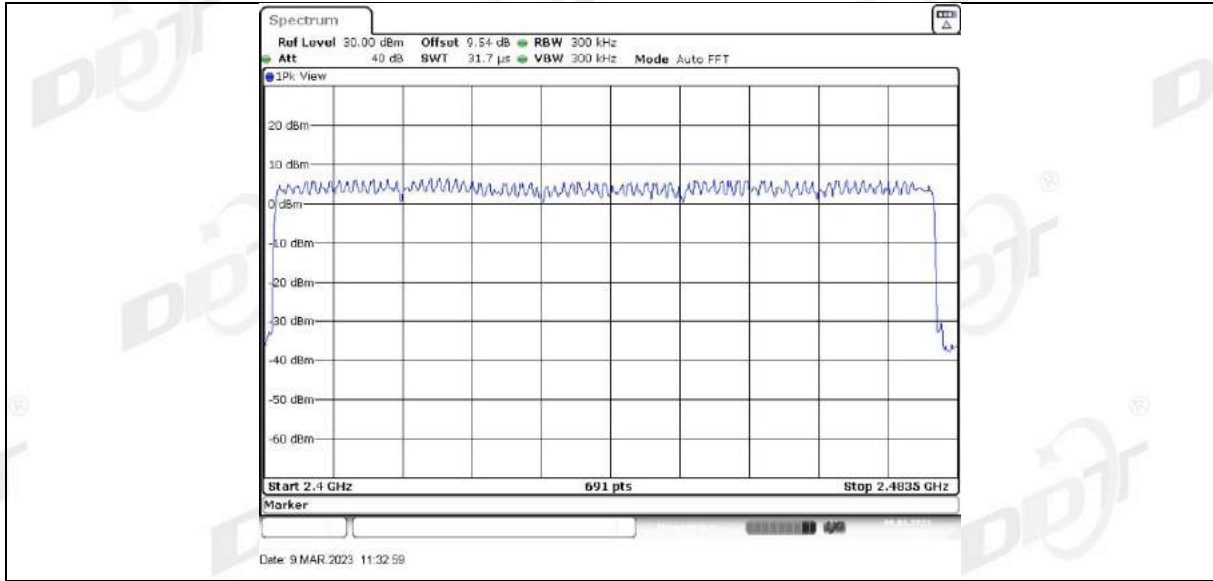

10. Band Edge Compliance (Conducted Method)

10.1. Block diagram of test setup

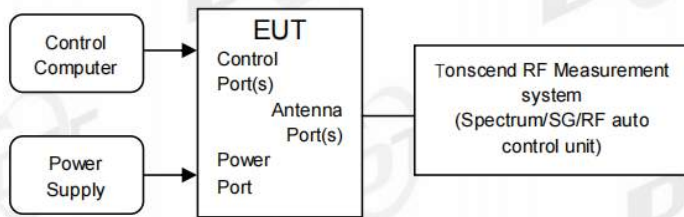

10.2. Limit

All restriction band should comply with 15.209, other emission should be at least 20dB below the fundamental.

10.3. Test procedure

(1) Connect EUT's antenna output to spectrum analyzer by RF cable.

(2) Establish a reference level by using the following procedure:

| | |
|----------------|--|
| RBW: | 100 kHz |
| VBW: | 300 kHz |
| Span | Encompass frequency range to be measured |
| Detector Mode: | Peak |
| Sweep time: | Auto |
| Trace mode | Max hold |

(3) Allow the trace to stabilize, use the peak marker function to determine the maximum peak power level to establish the reference level.

(4) Then mark the maximum amplitude of all unwanted emissions outside of the authorized frequency band.

10.4. Test result

| Mode | Freq. (MHz) | Verdict |
|----------------|------------------|---------|
| GFSK | Hopping off 2402 | Pass |
| | Hopping off 2480 | Pass |
| | Hopping on | Pass |
| $\pi/4$ -DQPSK | Hopping off 2402 | Pass |
| | Hopping off 2480 | Pass |
| | Hopping on | Pass |
| 8DPSK | Hopping off 2402 | Pass |
| | Hopping off 2480 | Pass |
| | Hopping on | Pass |

10.5. Test graphs



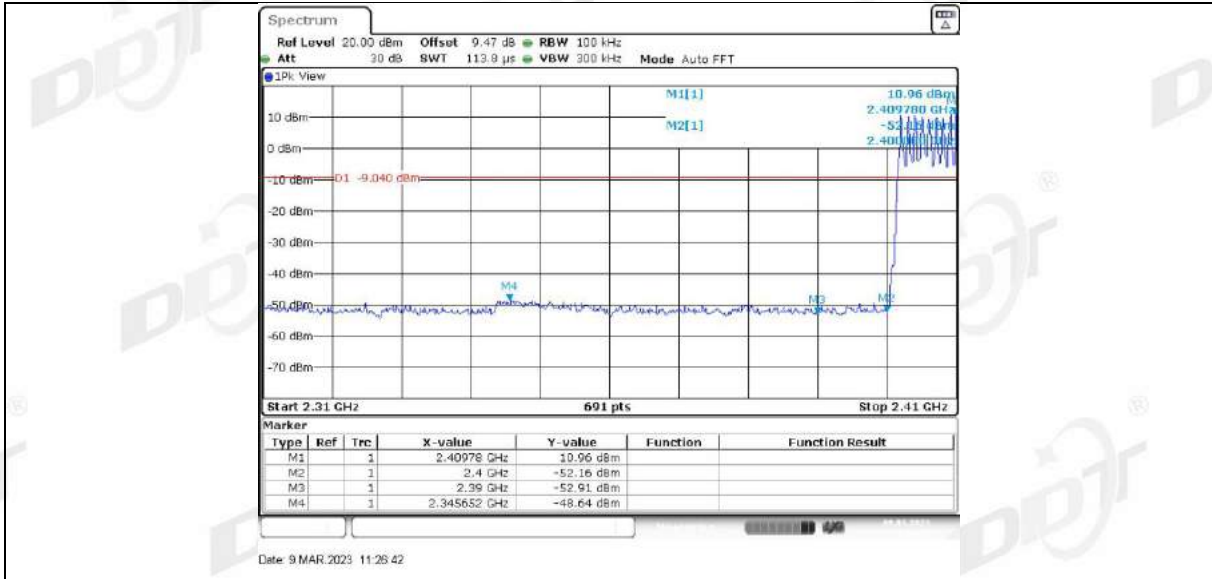

DH5 Ant1 High Hop 2480

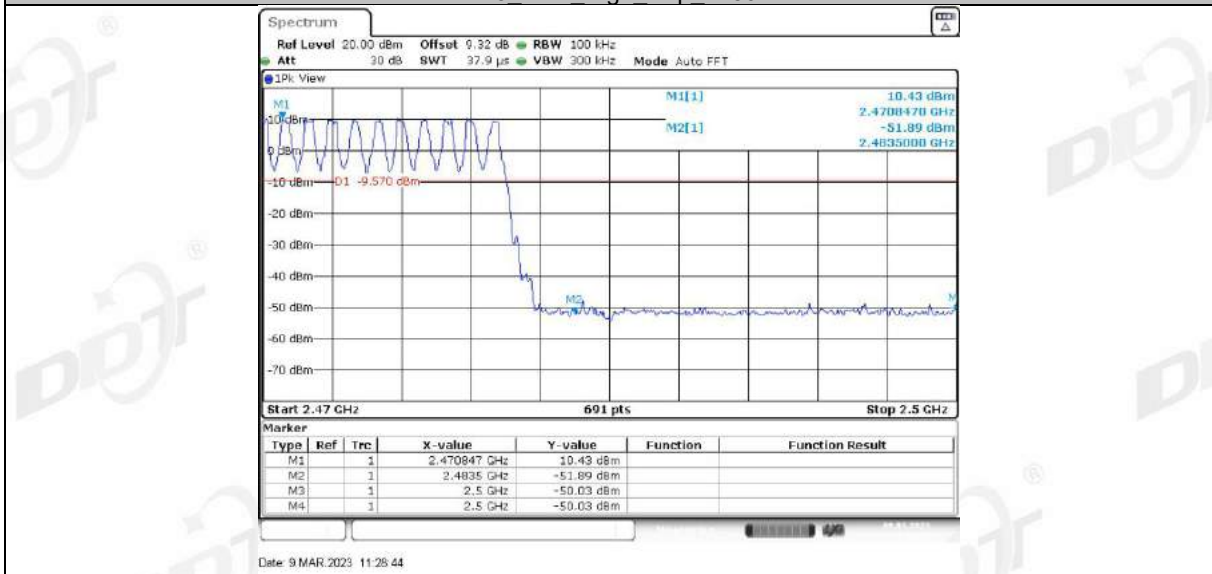

2DH5 Ant1 Low 2402

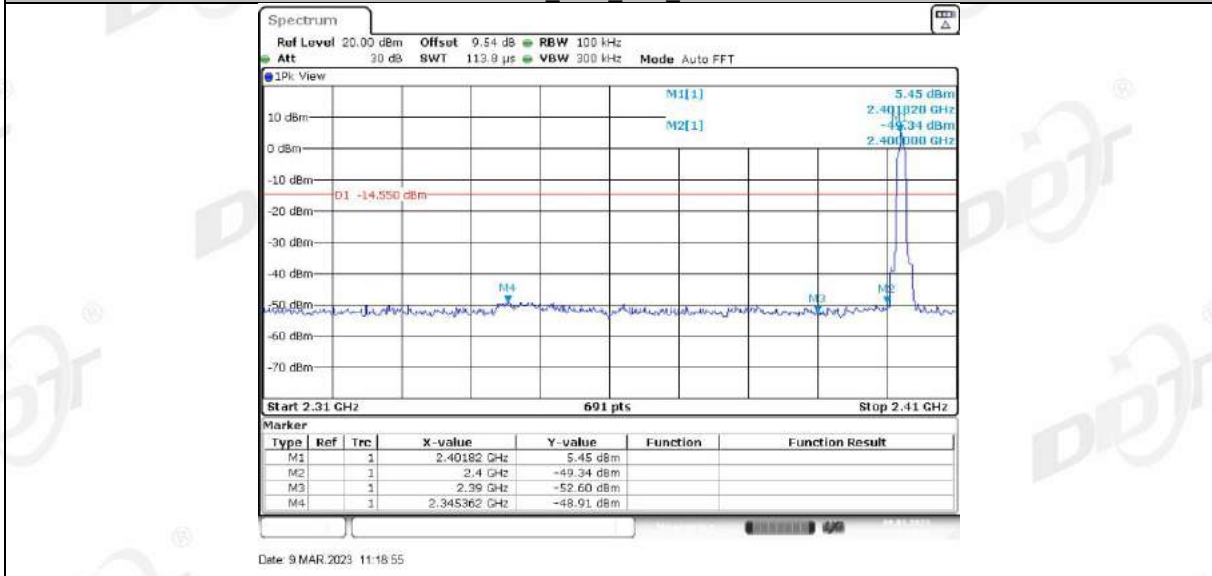

2DH5 Ant1 High 2480

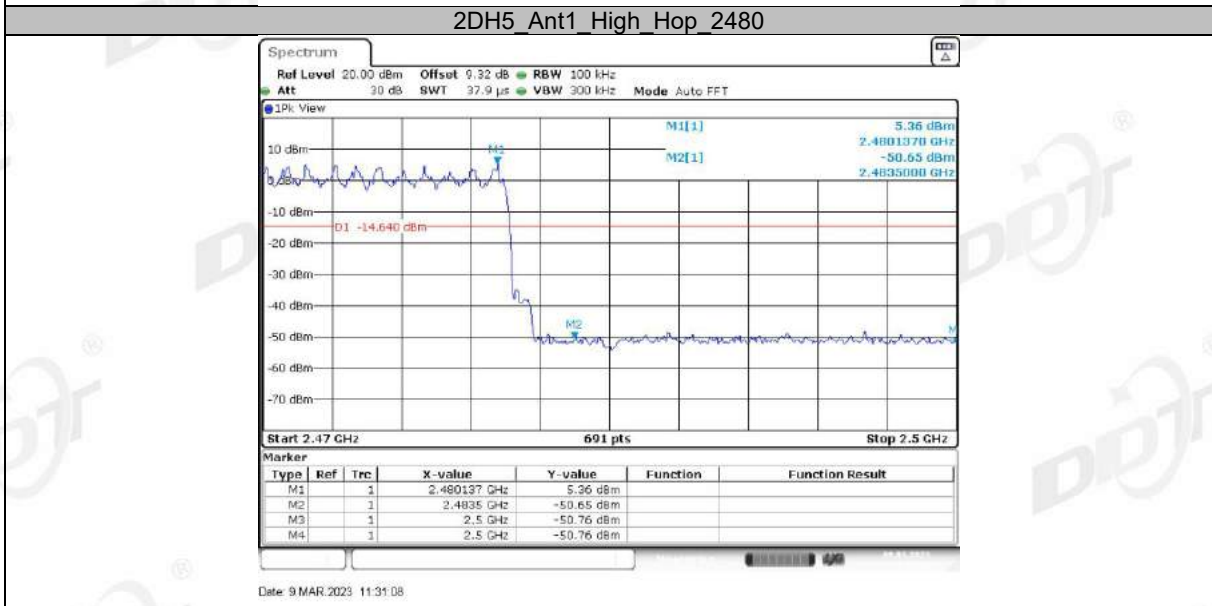
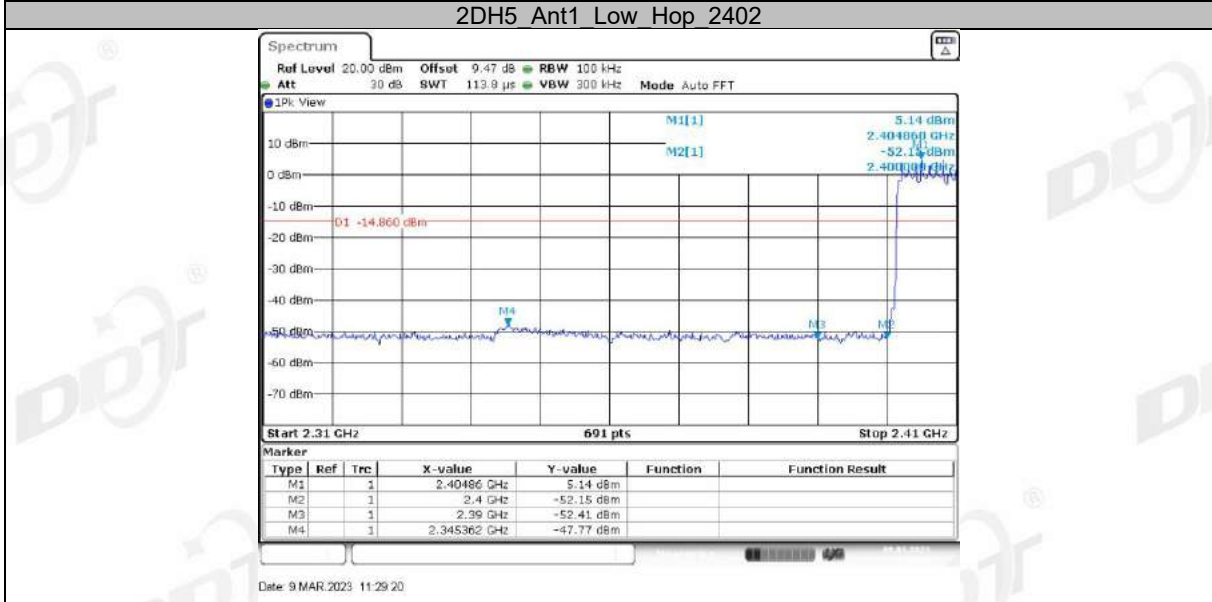
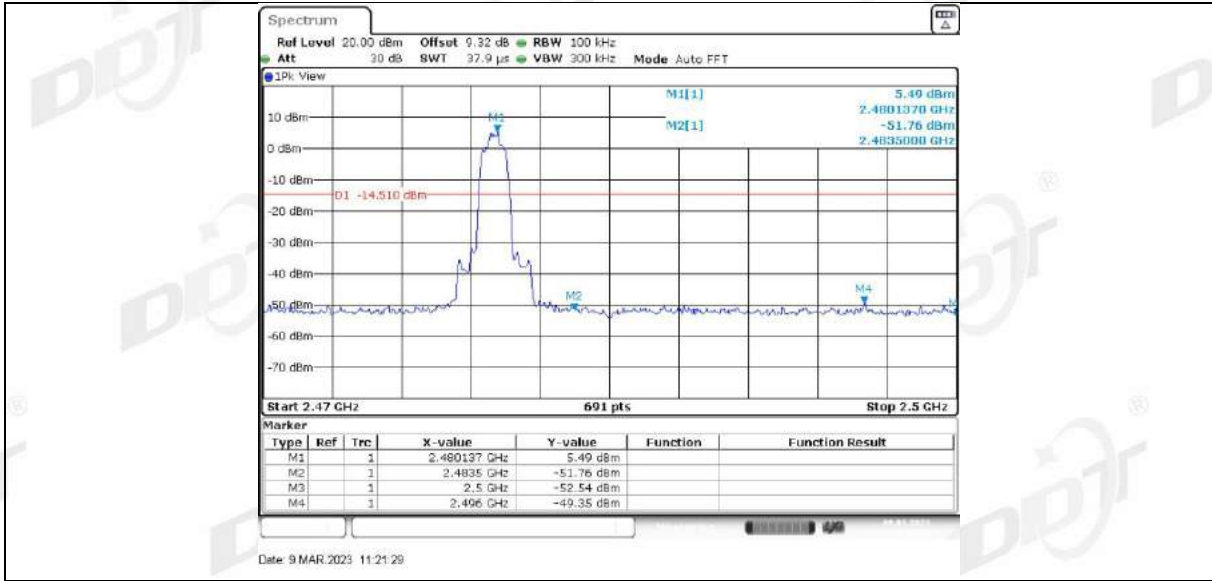

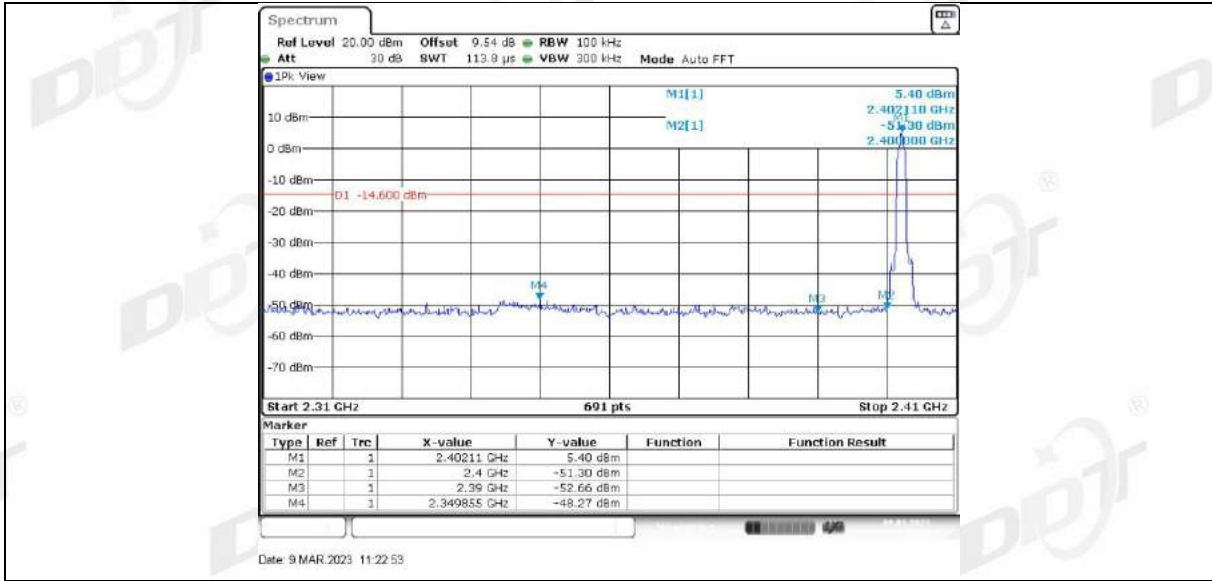

3DH5 Ant1 High 2480

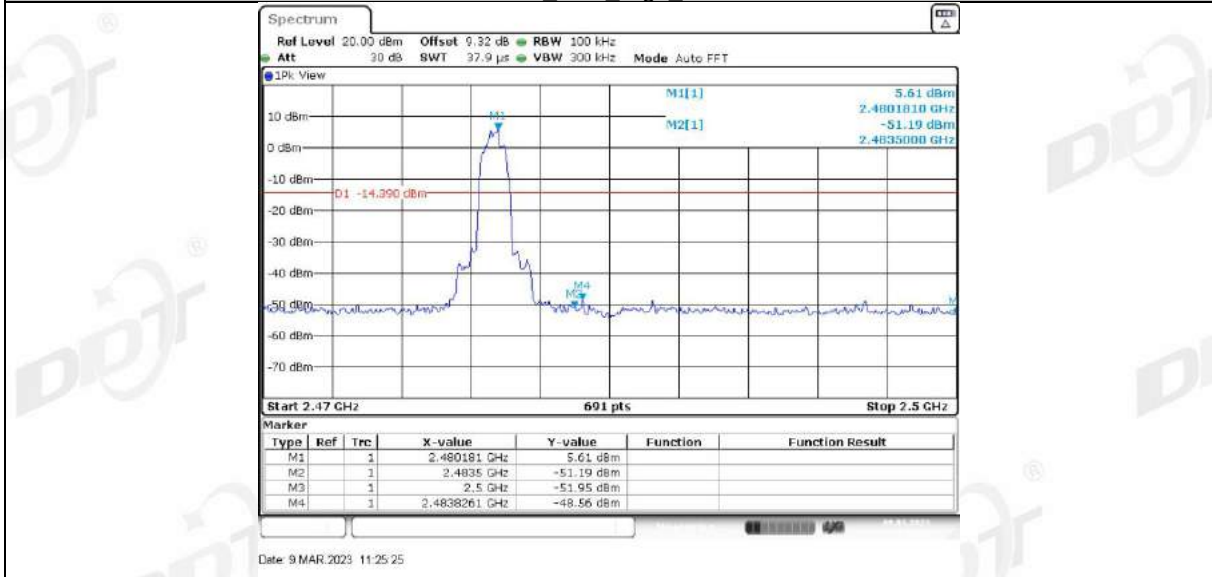

3DH5 Ant1 Low Hop 2402

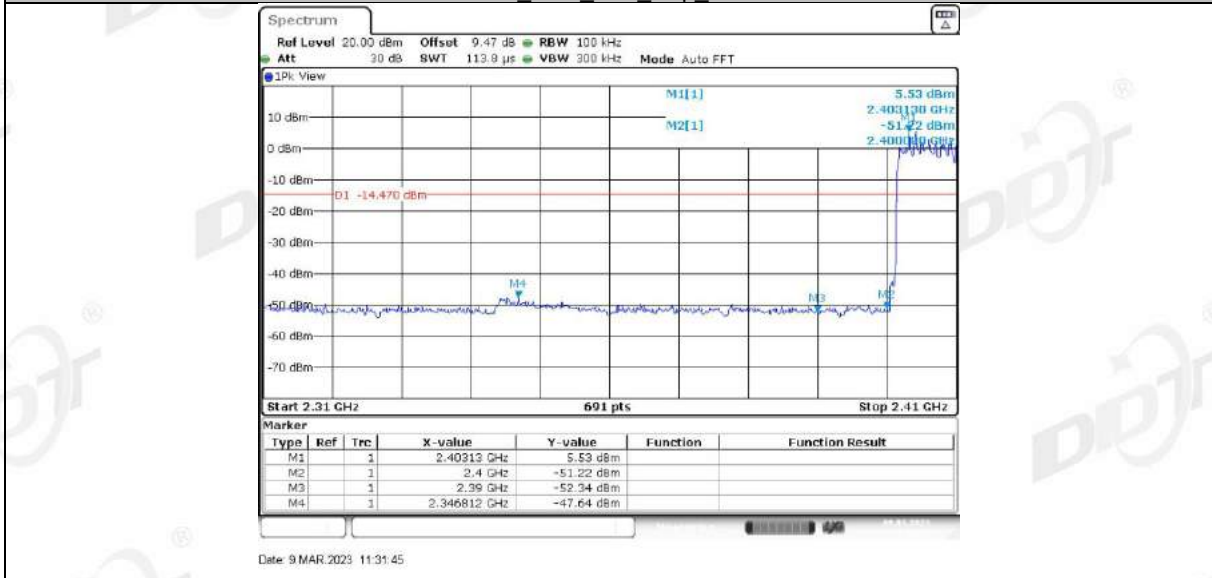

3DH5 Ant1 High Hop 2480

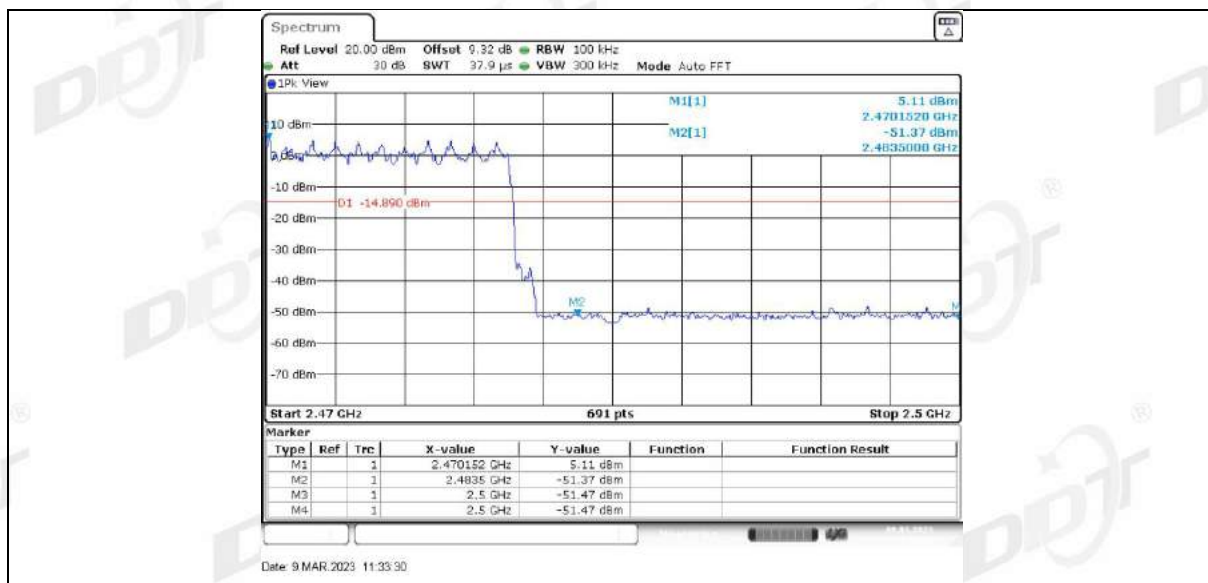

11. RF Conducted Spurious Emissions

11.1. Block diagram of test setup

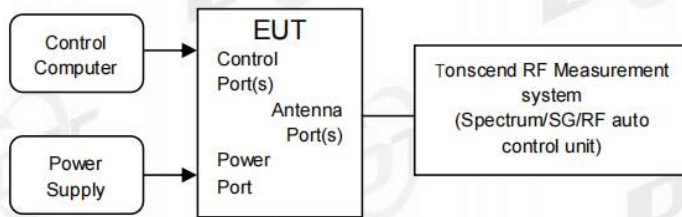

11.2. Limits

In any 100 kHz bandwidth outside the frequency bands in which the spread spectrum intentional radiator is operating, the radio frequency power that is produced by the intentional radiator shall be at least 20 dB below that in the 100 kHz bandwidth within the band that contains the highest level of the desired power.

11.3. Test procedure

- (1) Connect EUT's antenna output to spectrum analyzer by RF cable.
- (2) Establish a reference level by using the following procedure:

| | |
|------------------|---|
| Center frequency | Test frequency |
| RBW: | 100 kHz |
| VBW: | 300 kHz |
| Span | Wide enough to capture the peak level of the in-band emission |
| Detector Mode: | Peak |
| Sweep time: | Auto |
| Trace mode | Max hold |

- (3) Allow the trace to stabilize, use the peak marker function to determine the maximum peak power level to establish the reference level.

- (4) Set the spectrum analyzer as follows:

| | |
|------------------------------|--|
| RBW: | 100 kHz |
| VBW: | 300 kHz |
| Span | Encompass frequency range to be measured |
| Number of measurement points | $\geq \text{span}/\text{RBW}$ |
| Detector Mode: | Peak |
| Sweep time: | Auto |
| Trace mode | Max hold |

Allow the trace to stabilize, use the peak marker function to determine the maximum amplitude of all unwanted emissions outside of the authorized frequency band

11.4. Test result

| Mode | Freq. (MHz) | Verdict |
|----------------|------------------|---------|
| GFSK | Hopping off 2402 | Pass |
| | Hopping off 2441 | Pass |
| | Hopping off 2480 | Pass |
| $\pi/4$ -DQPSK | Hopping off 2402 | Pass |
| | Hopping off 2441 | Pass |
| | Hopping off 2480 | Pass |
| 8DPSK | Hopping off 2402 | Pass |
| | Hopping off 2441 | Pass |
| | Hopping off 2480 | Pass |

11.5. Test graphs

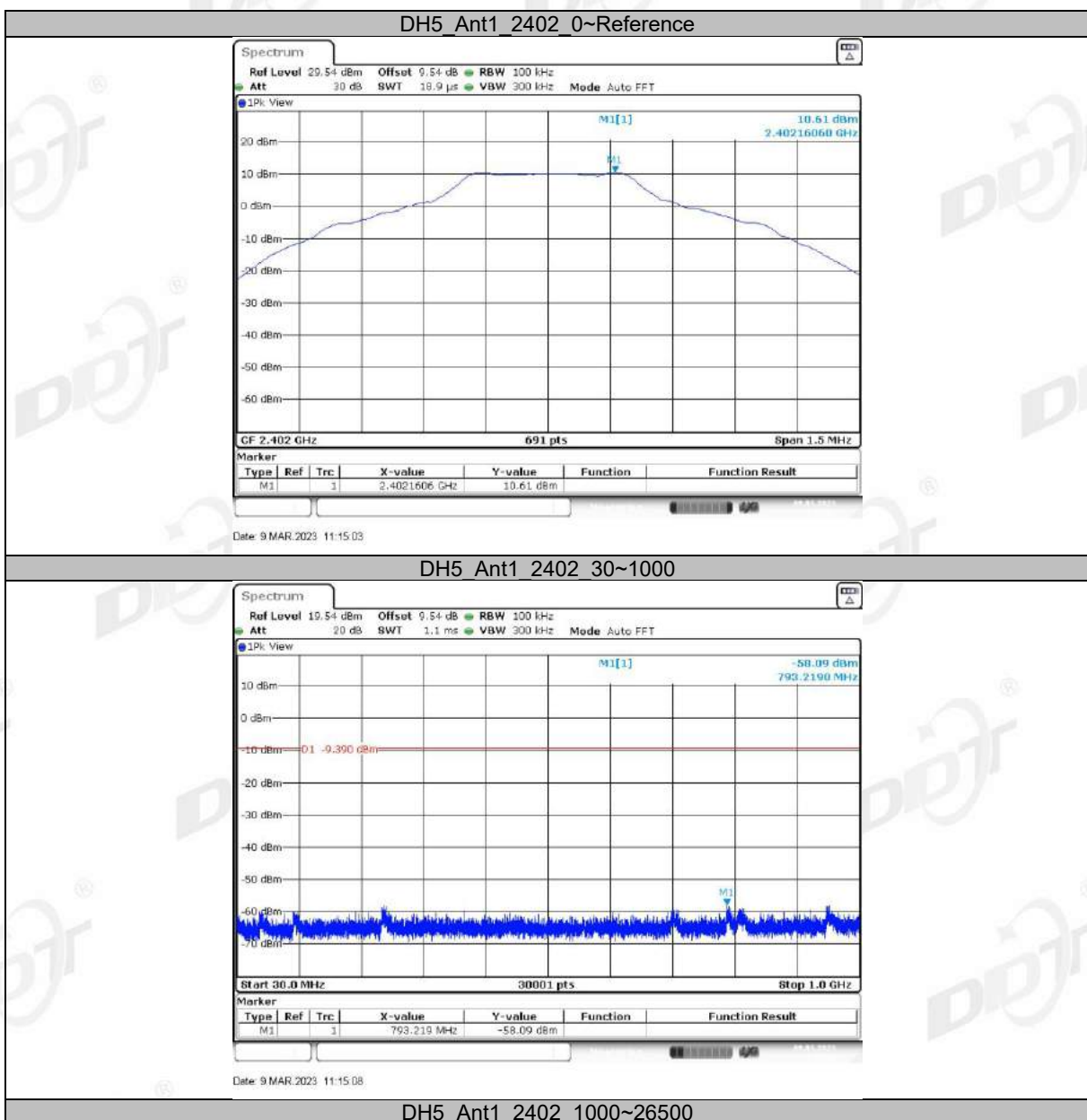

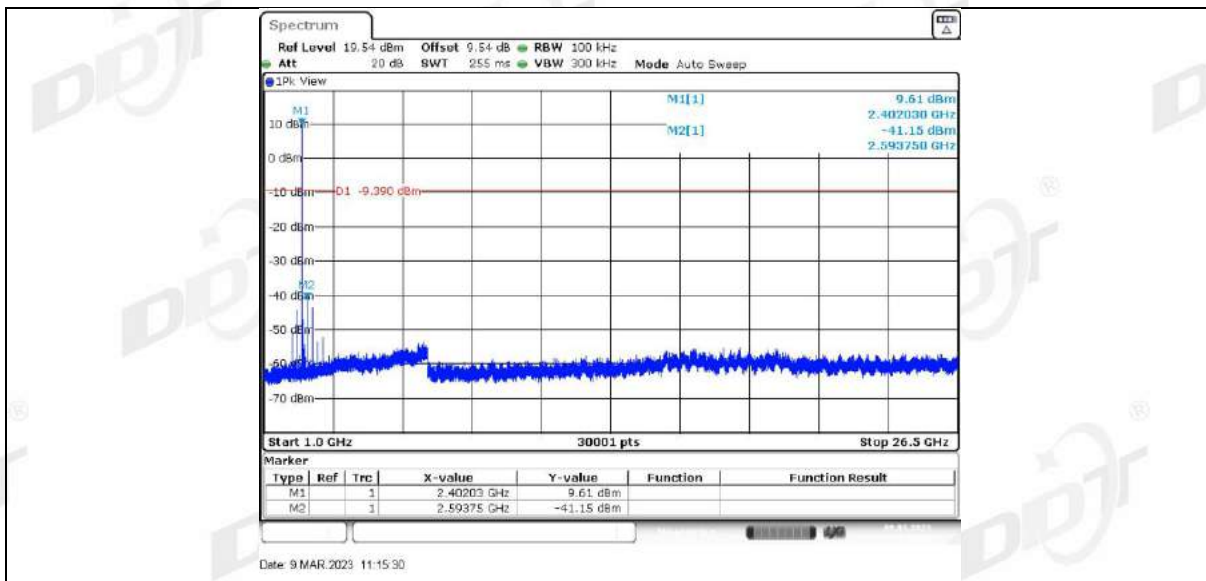

DH5 Ant1 2441 0~Reference

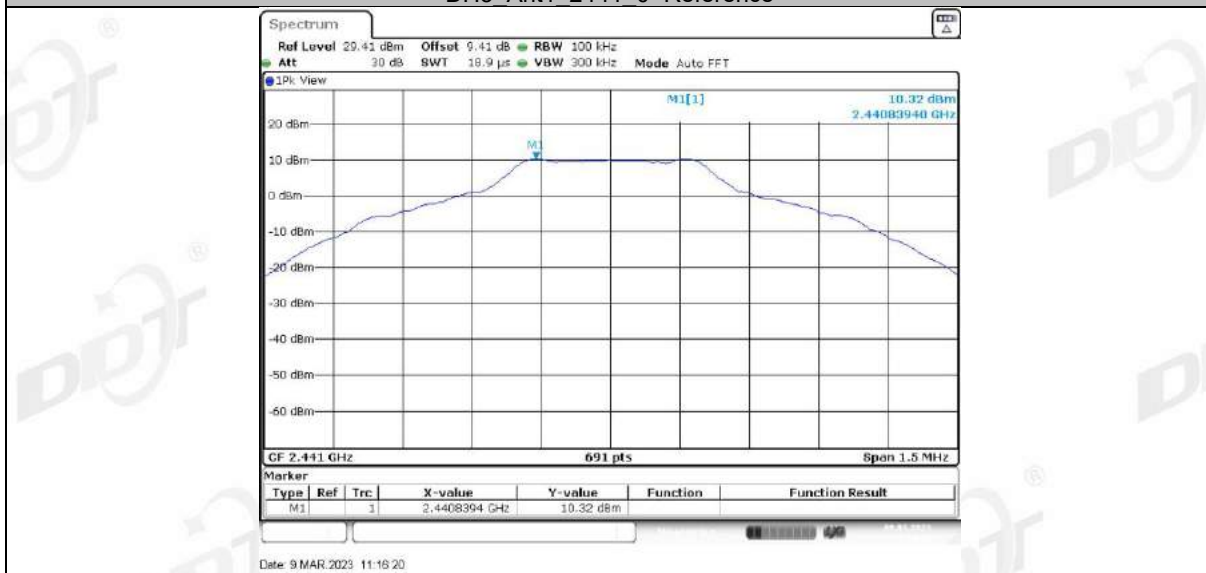

DH5 Ant1 2441 30~1000

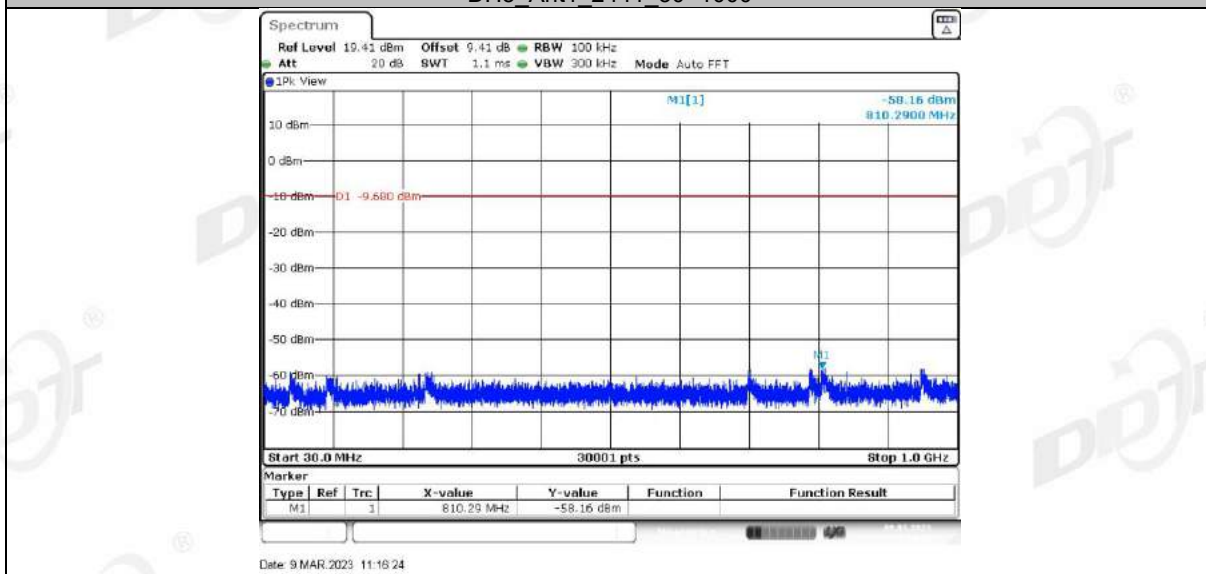

DH5 Ant1 2441 1000~26500

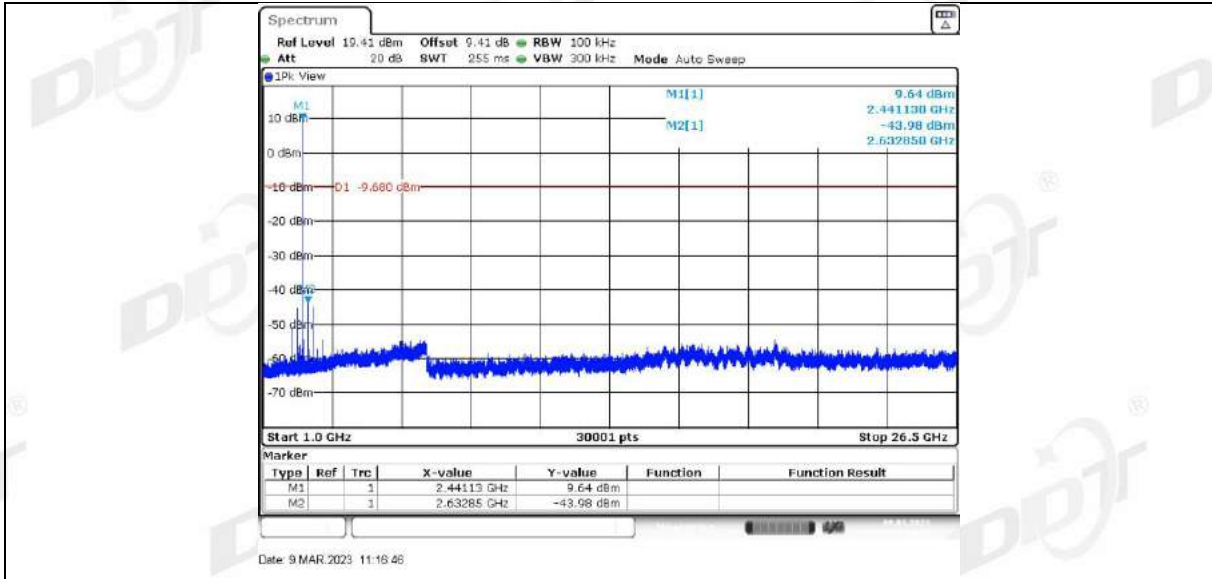

DH5 Ant1 2480 0~Reference

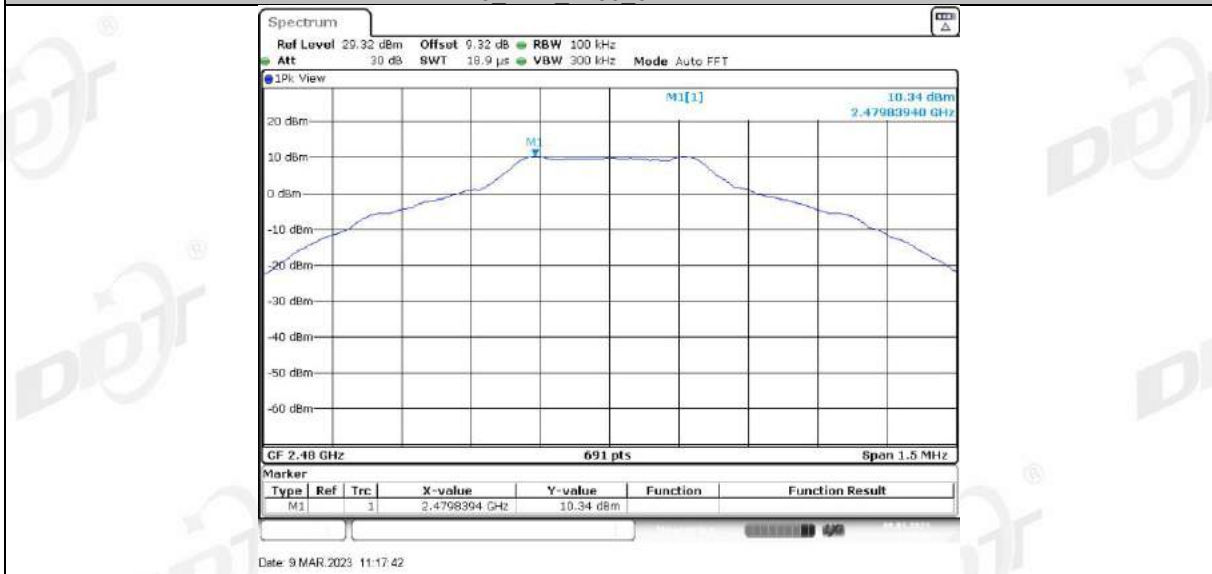

DH5 Ant1 2480 30~1000

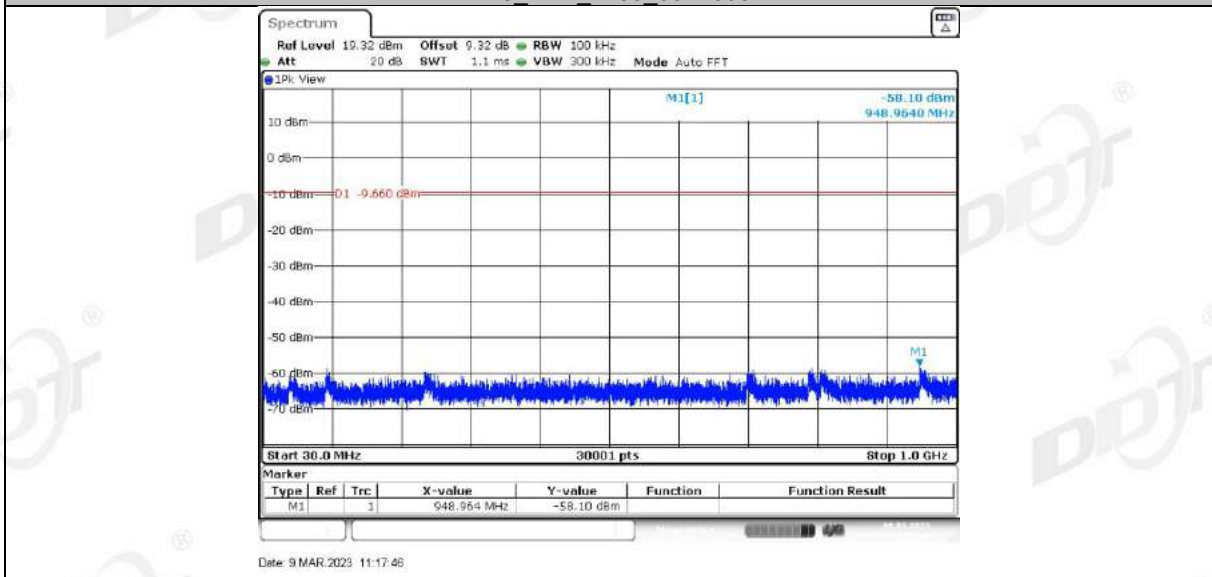

DH5 Ant1 2480 1000~26500

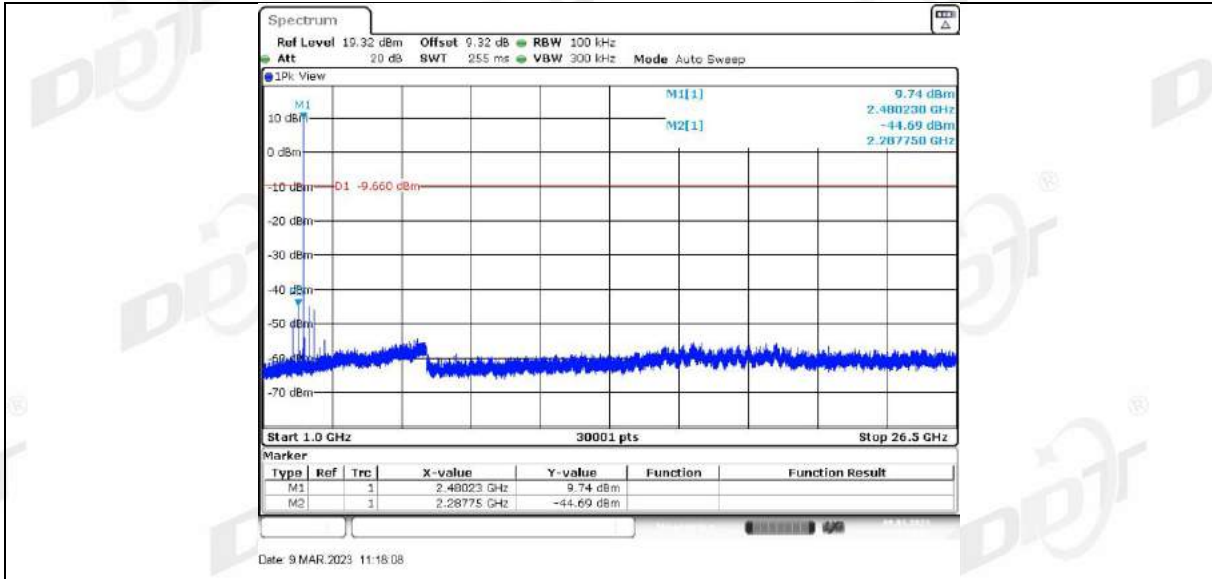

2DH5 Ant1 2402 0~Reference

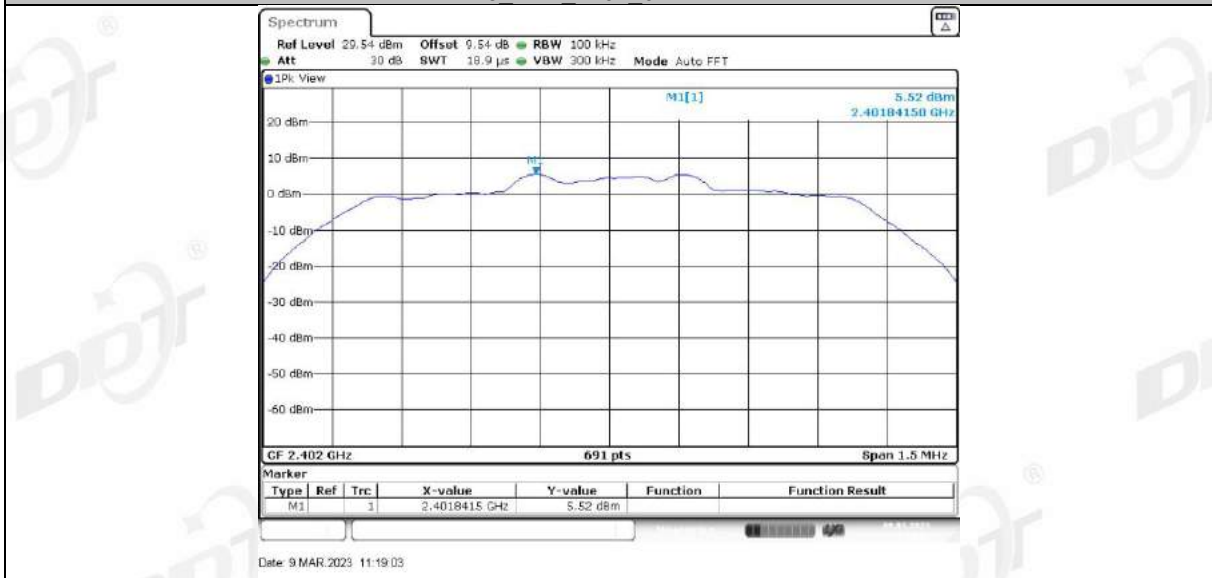

2DH5 Ant1 2402 30~1000

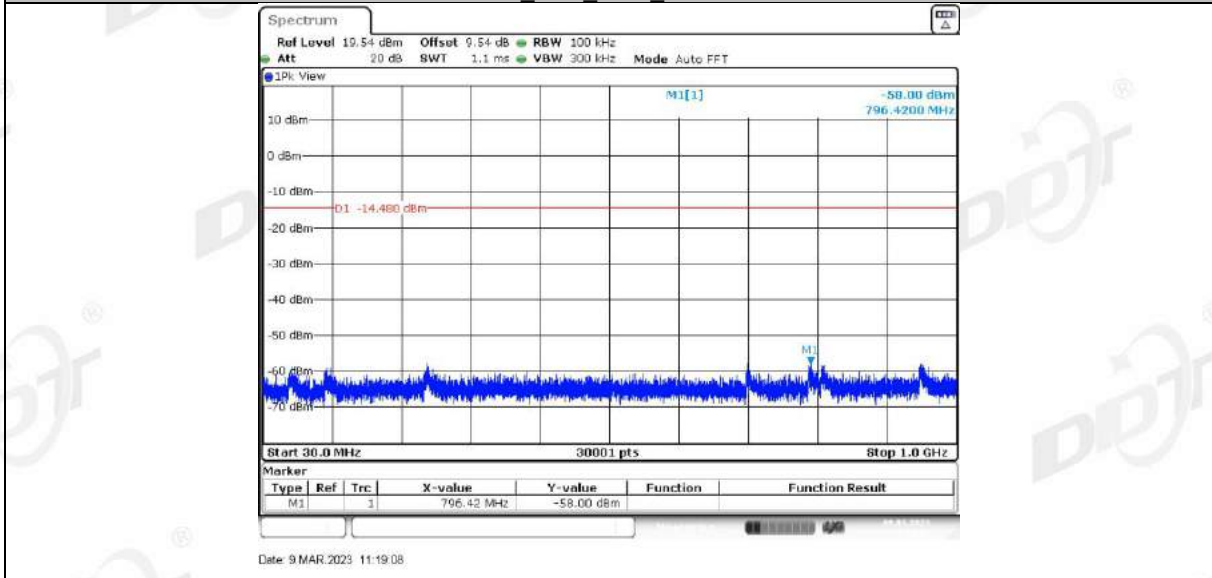

2DH5 Ant1 2402 1000~26500

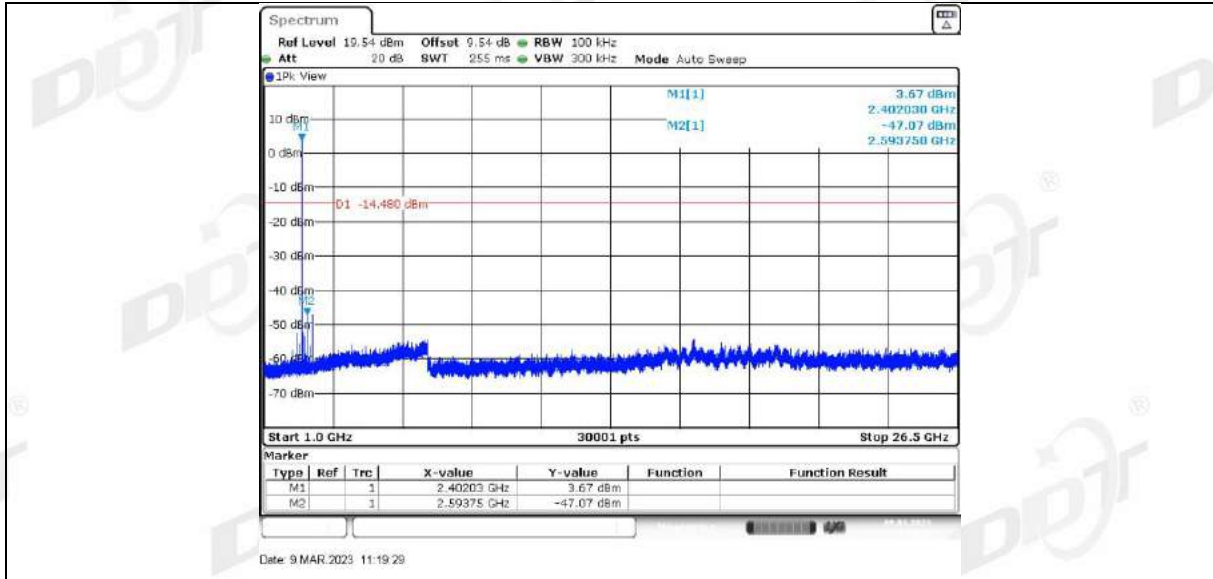

2DH5 Ant1 2441 0~Reference

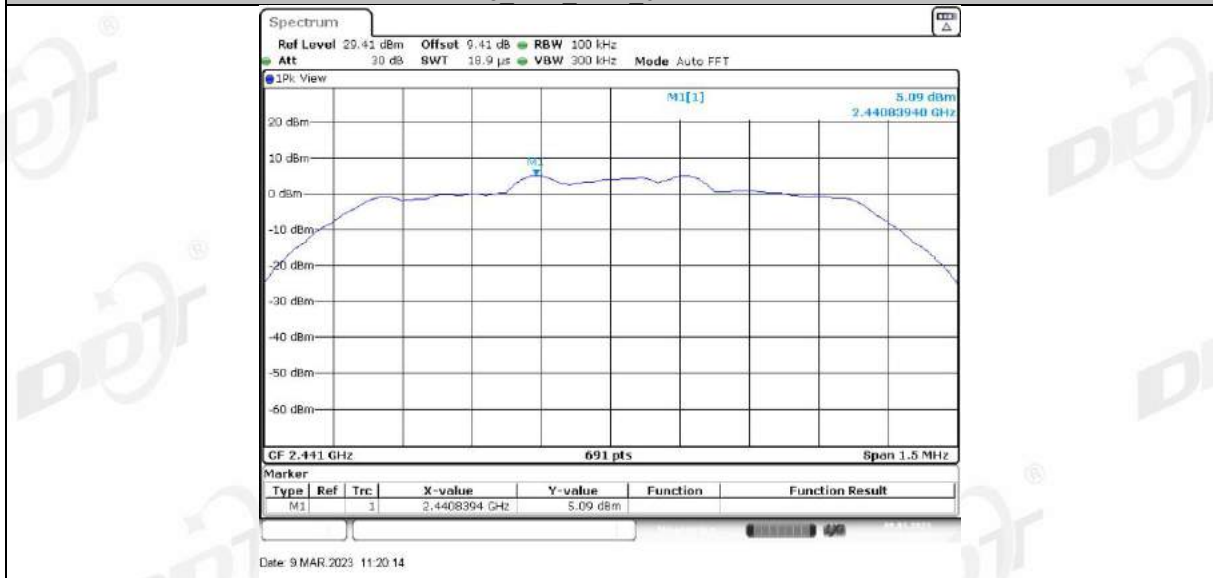

2DH5 Ant1 2441 30~1000

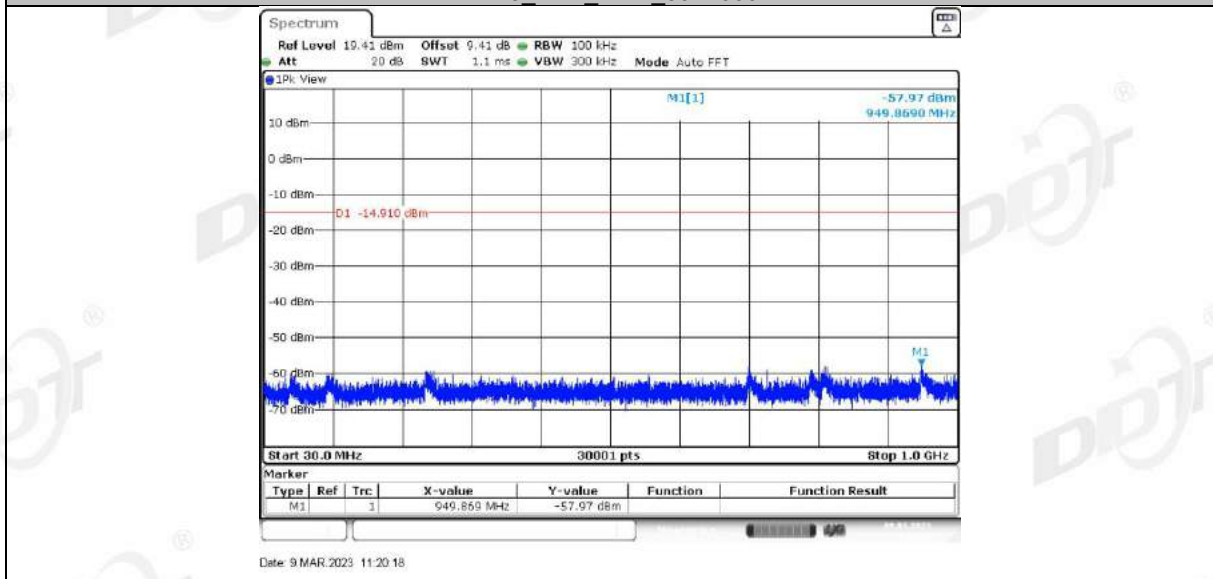

2DH5 Ant1 2441 1000~26500

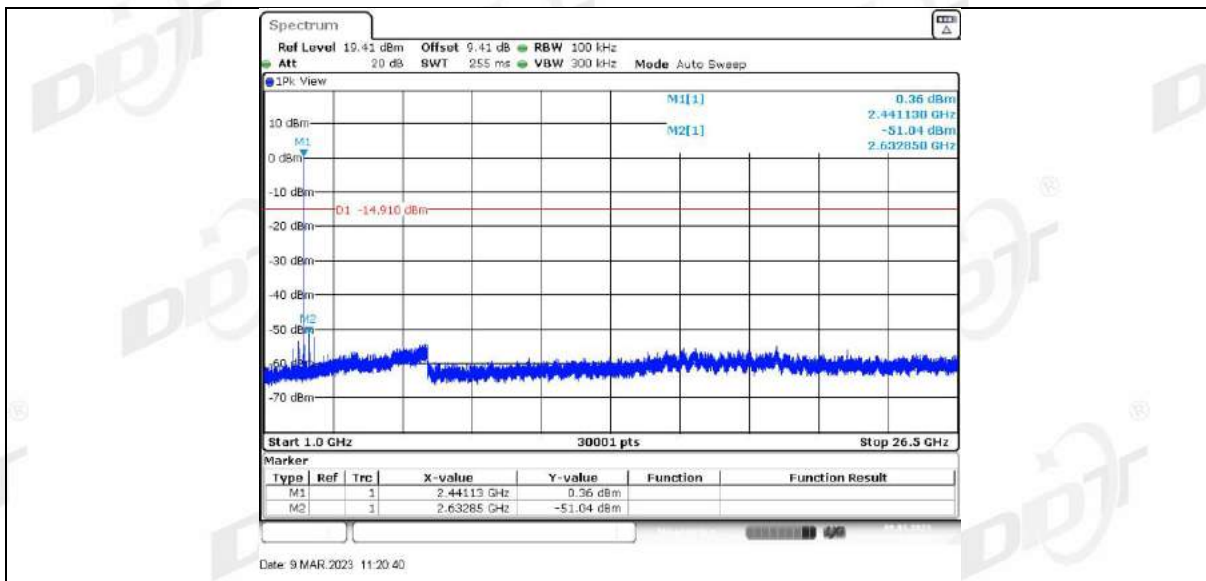

2DH5 Ant1 2480 0~Reference

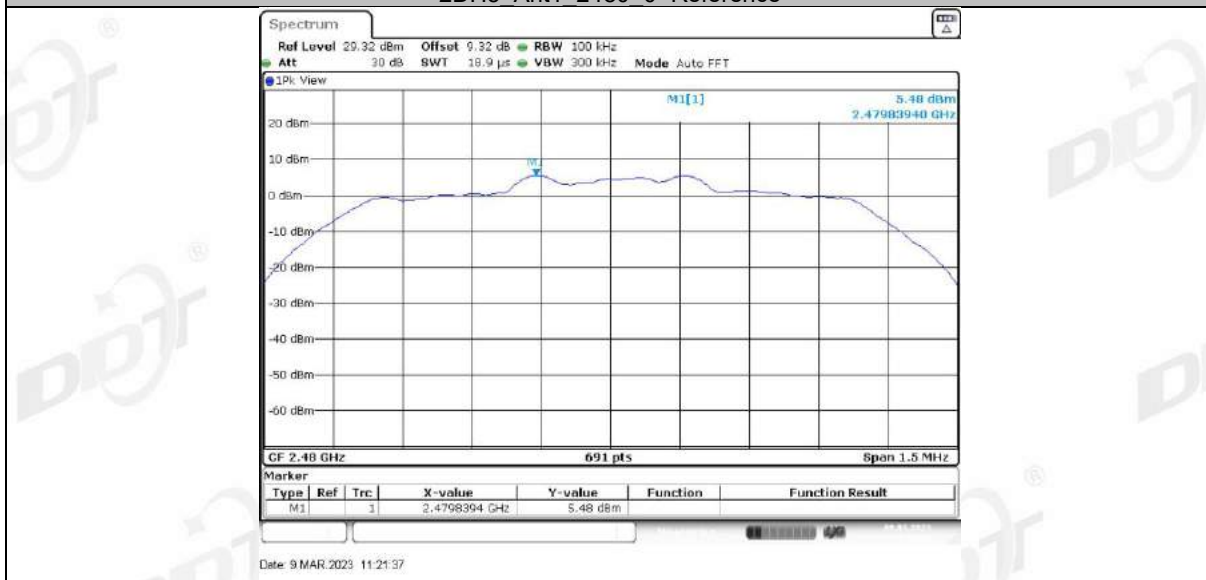

2DH5 Ant1 2480 30~1000

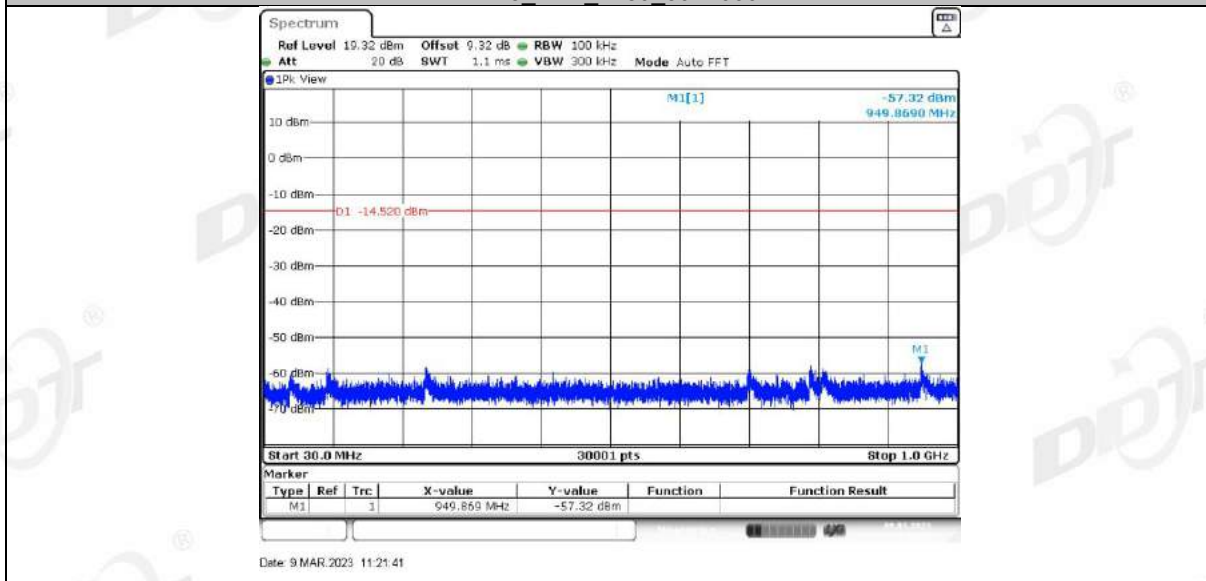

2DH5 Ant1 2480 1000~26500

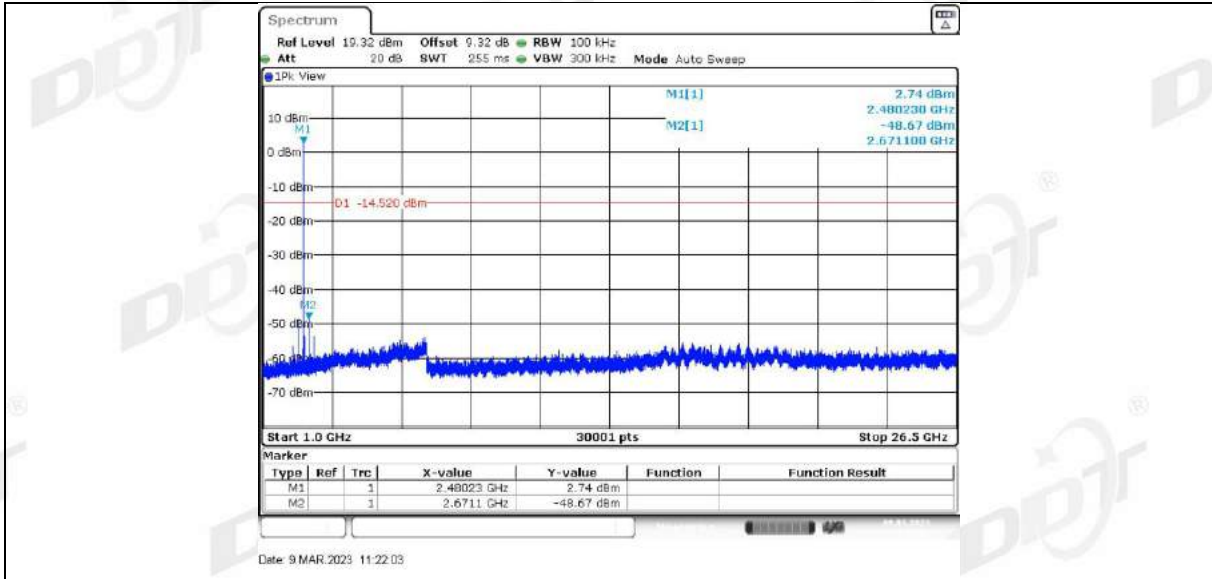

3DH5 Ant1 2402 0~Reference

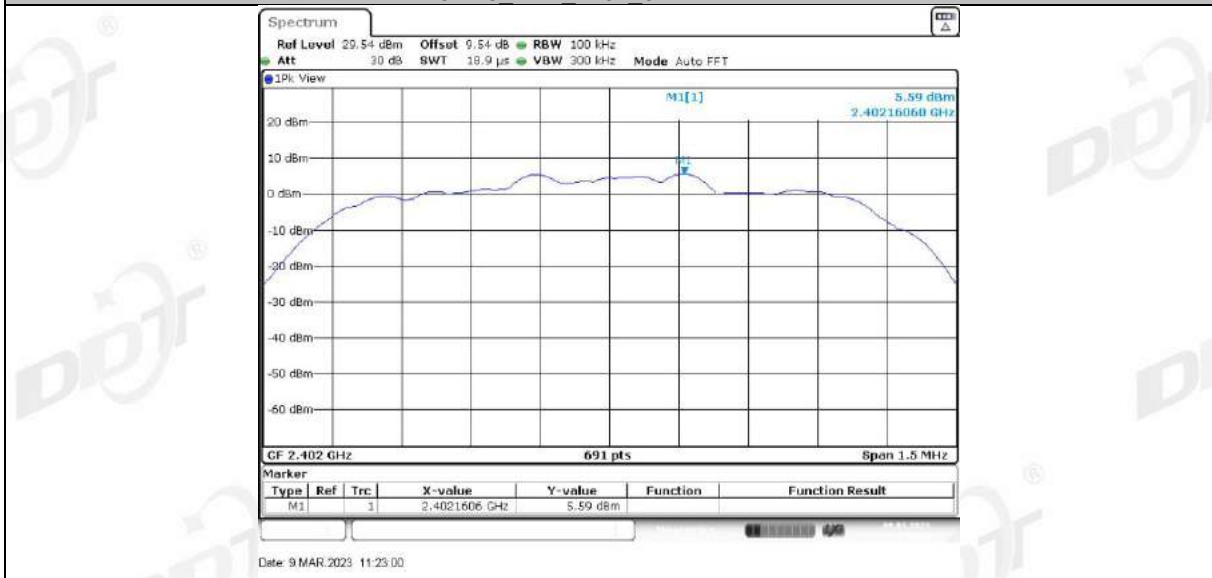

3DH5 Ant1 2402 30~1000

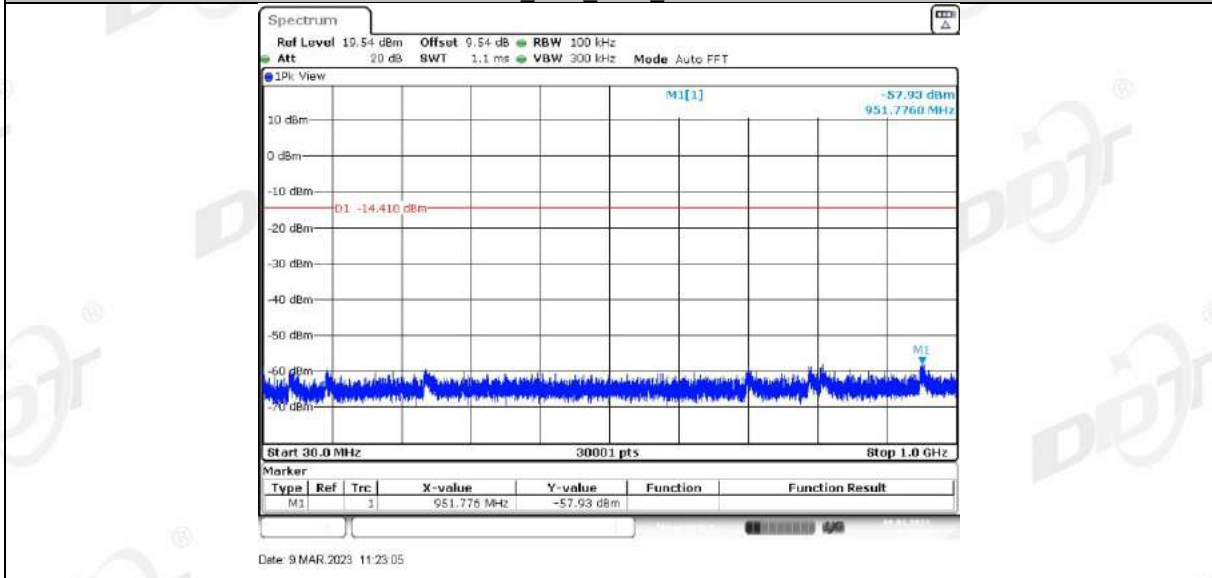

3DH5 Ant1 2402 1000~26500

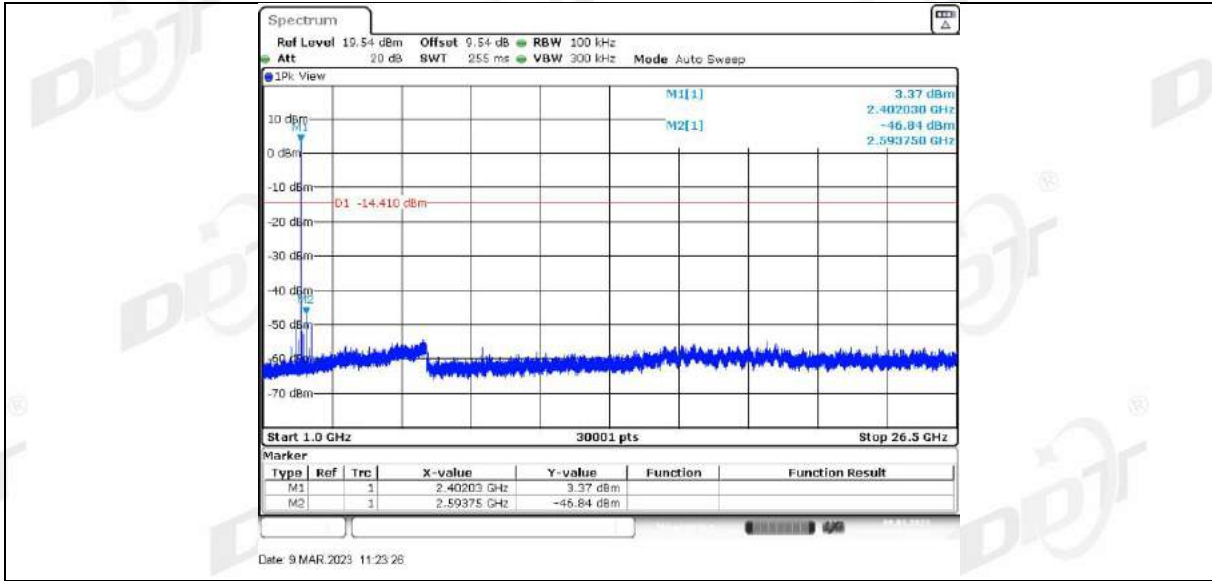

3DH5 Ant1 2441 0~Reference

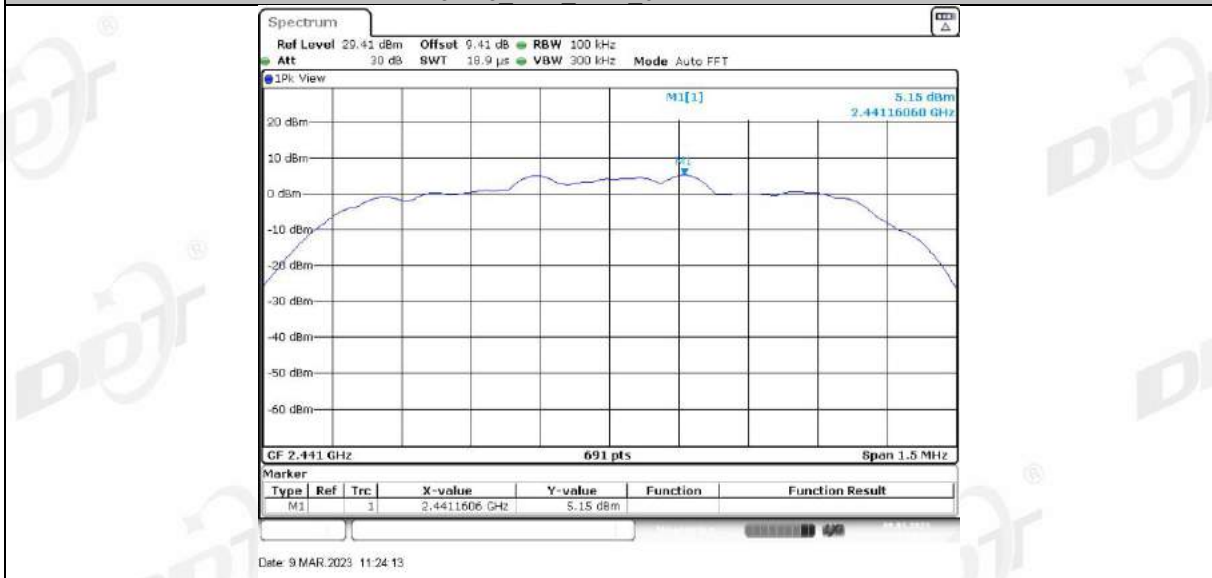

3DH5 Ant1 2441 30~1000

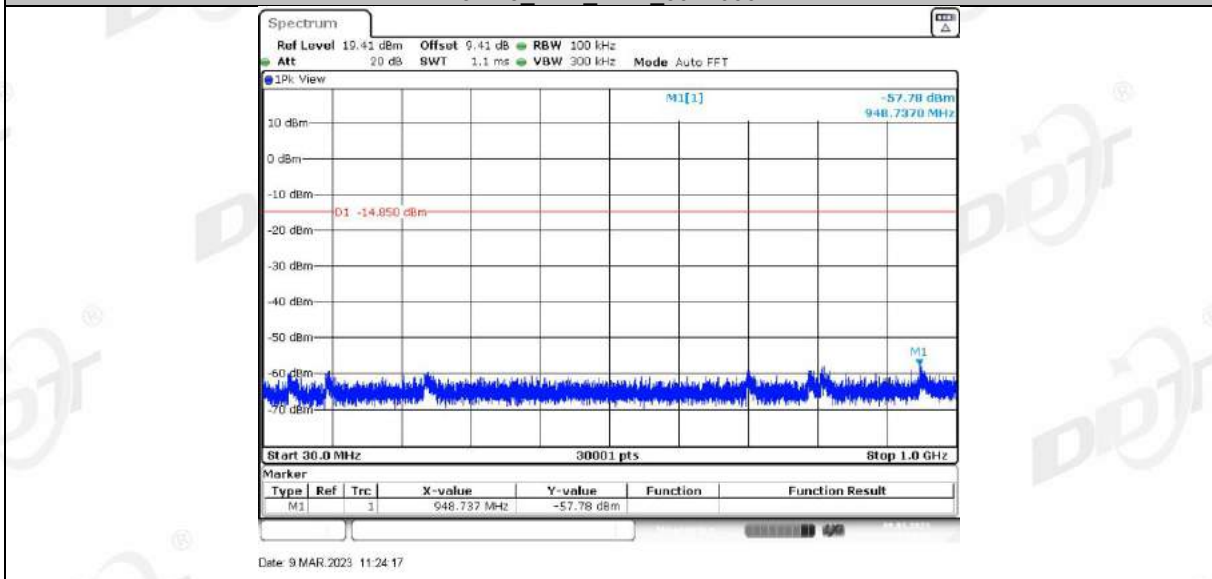

3DH5 Ant1 2441 1000~26500

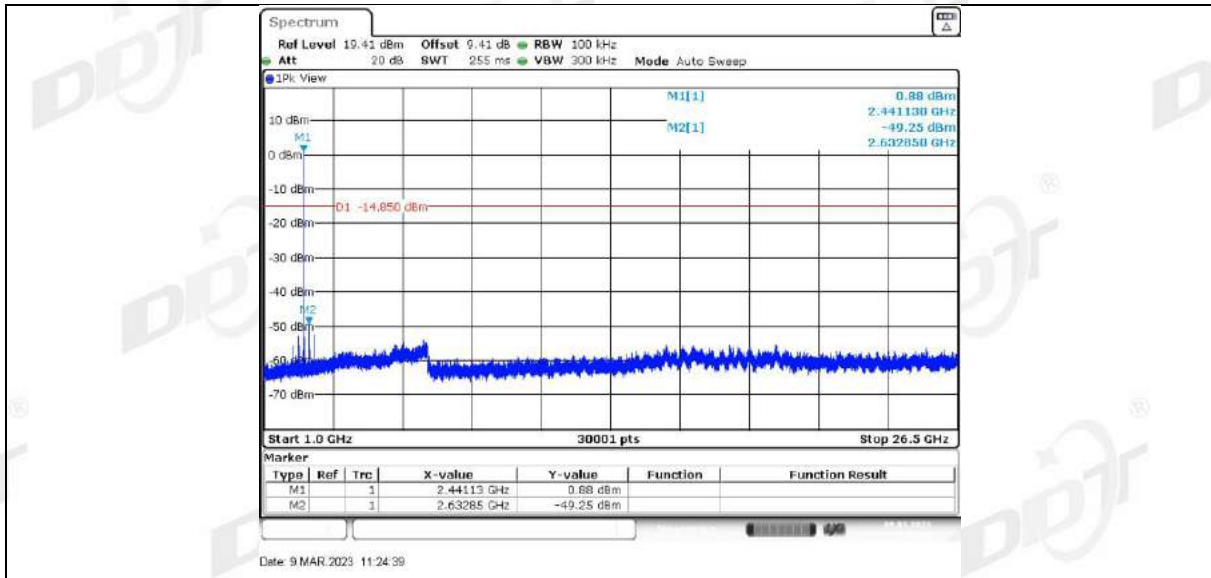

3DH5 Ant1 2480 0~Reference

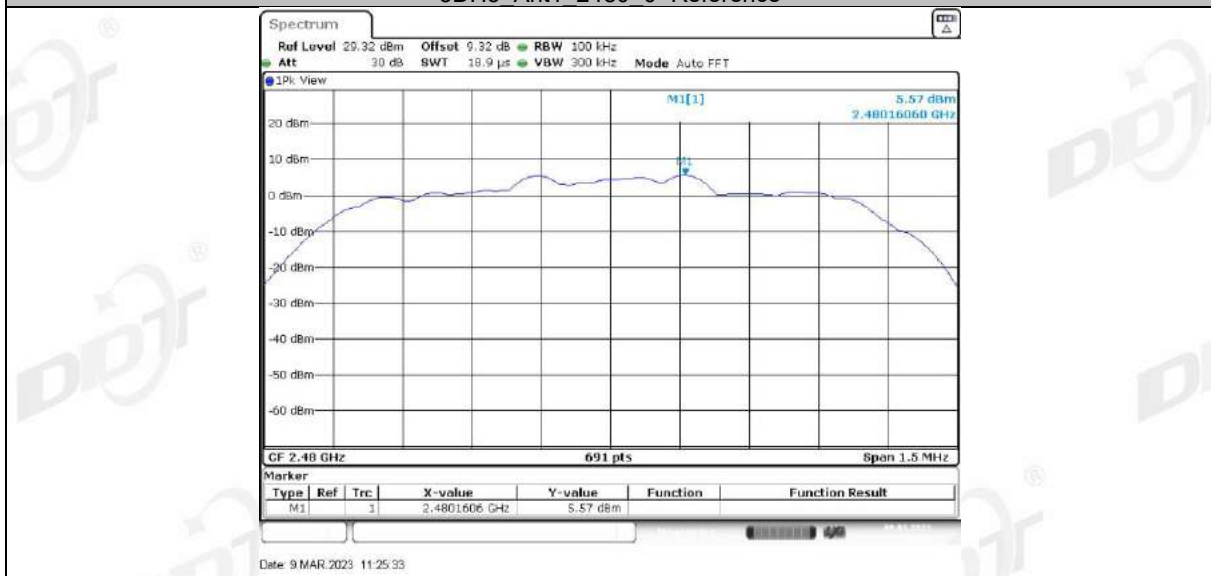

3DH5 Ant1 2480 30~1000

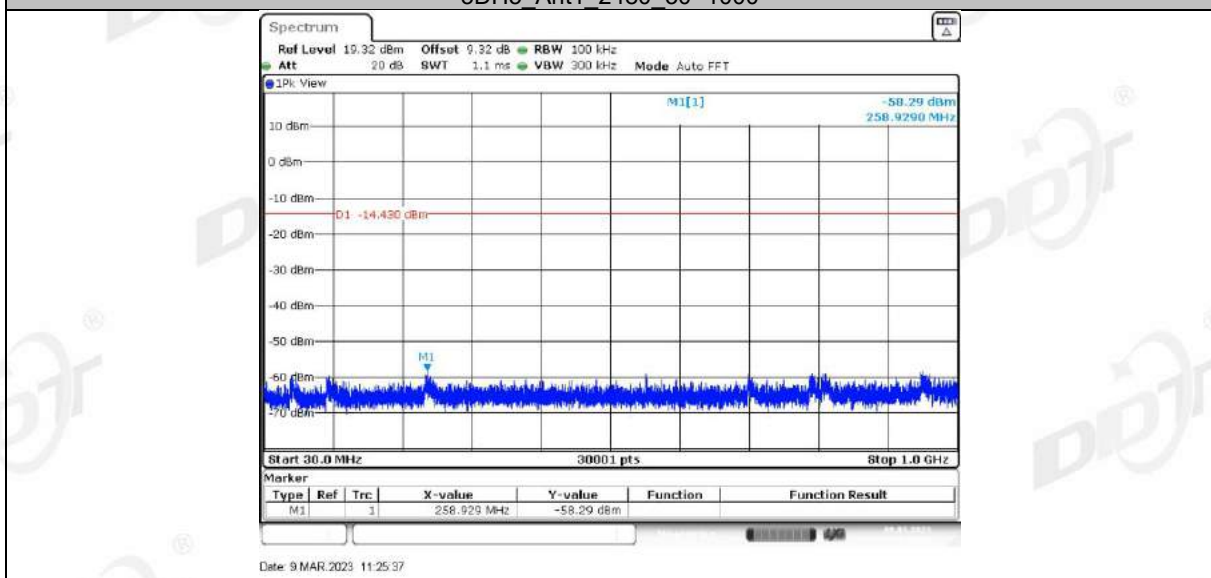

3DH5 Ant1 2480 1000~26500

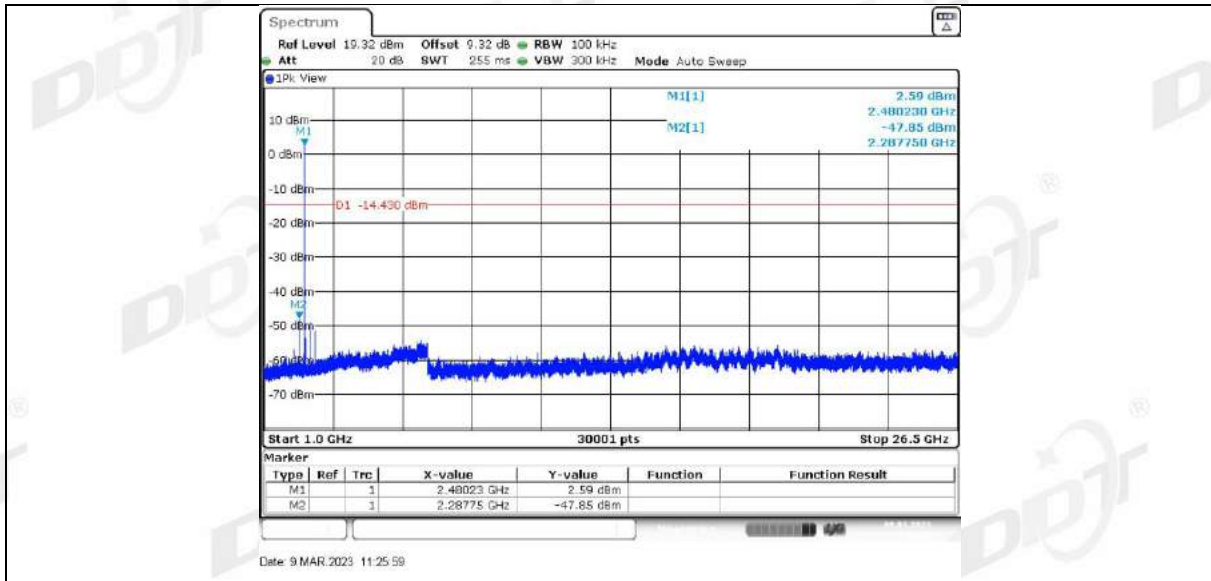

12. Duty cycle

12.1. Block diagram of test setup

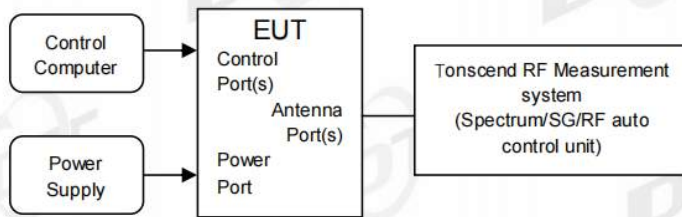

12.2. Limit

Just for Report.

12.3. Test procedure

- (1) Connected the EUT's antenna port to the Spectrum Analyzer by suitable attenuator, The cable loss and attenuator loss have been put into spectrum analyzer as amplitude offset.
set the Spectrum Analyzer as below:

Centre Frequency: The centre frequency of the middle hopping channel.

Resolution BW: 10 MHz.

Video BW: 10 MHz.

Span: Zero span.

Detector: Peak.

Trace Mode: Max hold.

Sweep: Video Trigger

- (2) When the trace is complete, measure the sending time of 1 burst and the duty cycle of 1 burst cycle.
- (3) Calculate dwell time follow below formula:
Duty cycle= Pulse's on time / Burst cycle

12.4. Test result

| Test Mode | Antenna | Frequency [MHz] | ON Time [ms] | Period [ms] | Duty Cycle [%] | Duty Cycle Factor[dB] |
|-----------|---------|-----------------|--------------|-------------|----------------|-----------------------|
| DH5 | Ant1 | 2402 | 2.91 | 3.76 | 77.39 | 1.11 |
| | | 2441 | 2.91 | 3.75 | 77.60 | 1.10 |
| | | 2480 | 2.91 | 3.75 | 77.60 | 1.10 |
| 2DH5 | Ant1 | 2402 | 2.90 | 3.76 | 77.13 | 1.13 |
| | | 2441 | 2.90 | 3.75 | 77.33 | 1.12 |
| | | 2480 | 2.89 | 3.75 | 77.07 | 1.13 |
| 3DH5 | Ant1 | 2402 | 2.90 | 3.75 | 77.33 | 1.12 |
| | | 2441 | 2.90 | 3.76 | 77.13 | 1.13 |
| | | 2480 | 2.90 | 3.76 | 77.13 | 1.13 |

12.5. Test graphs



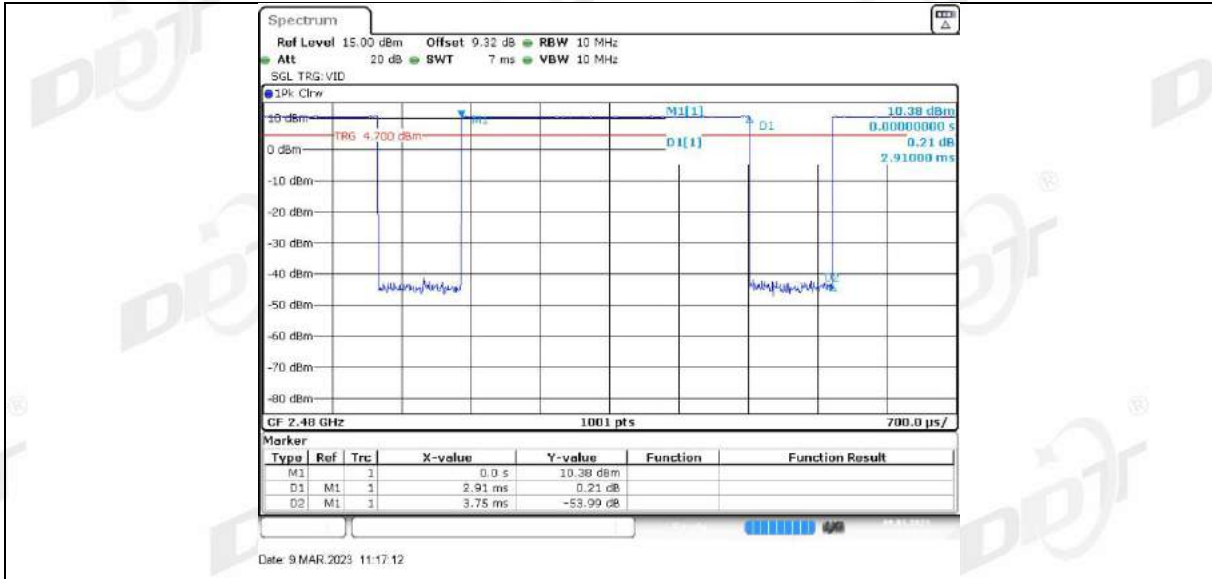

2DH5 Ant1_2402

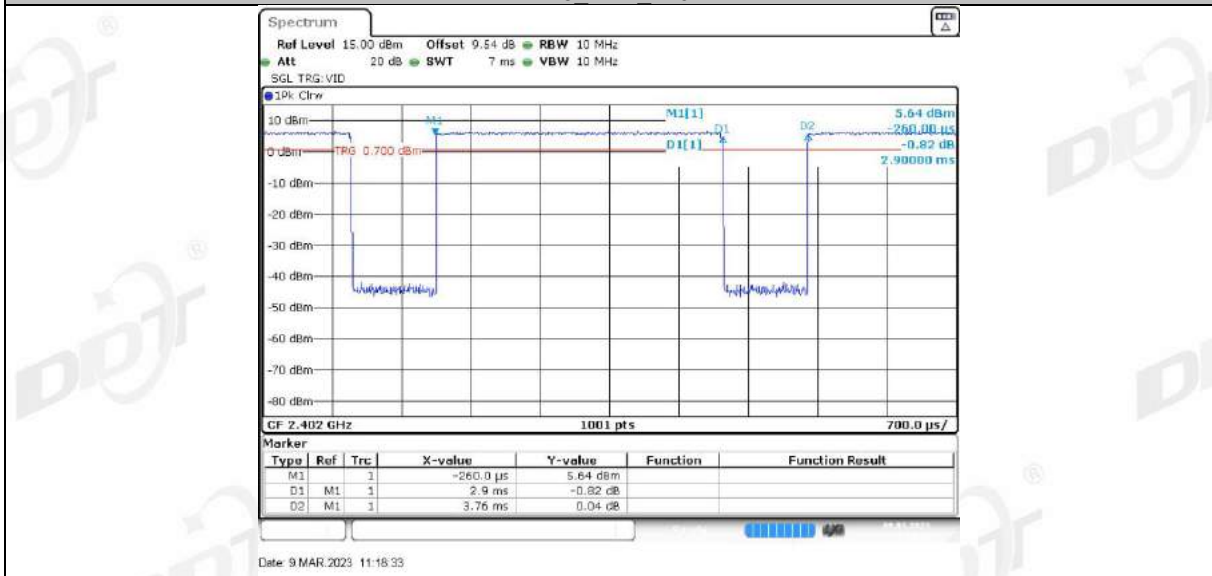

2DH5 Ant1_2441

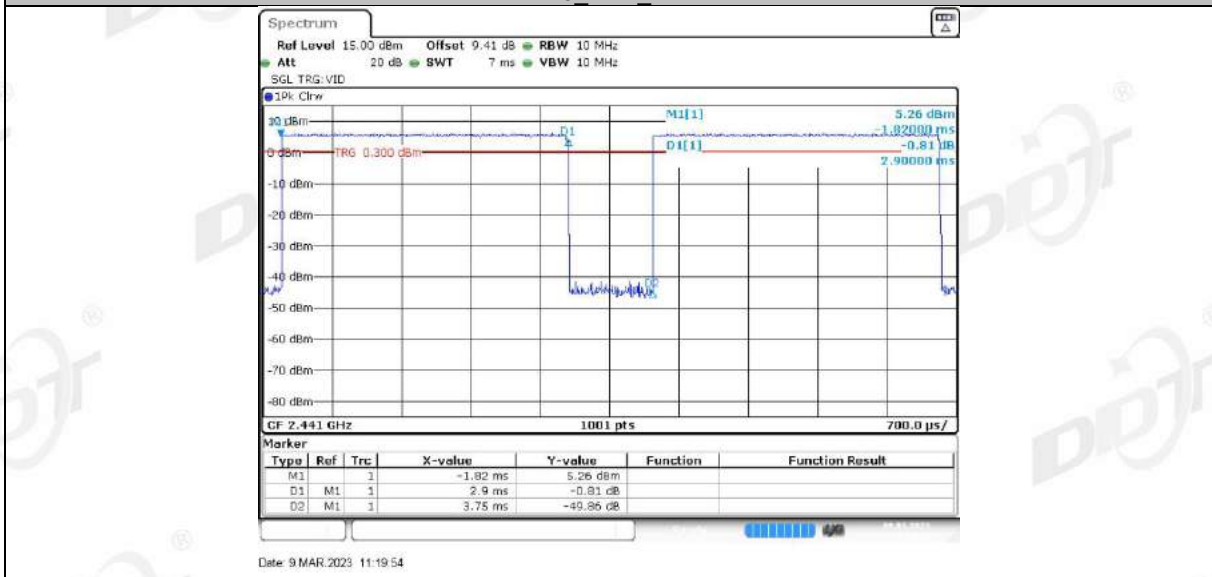

2DH5 Ant1_2480

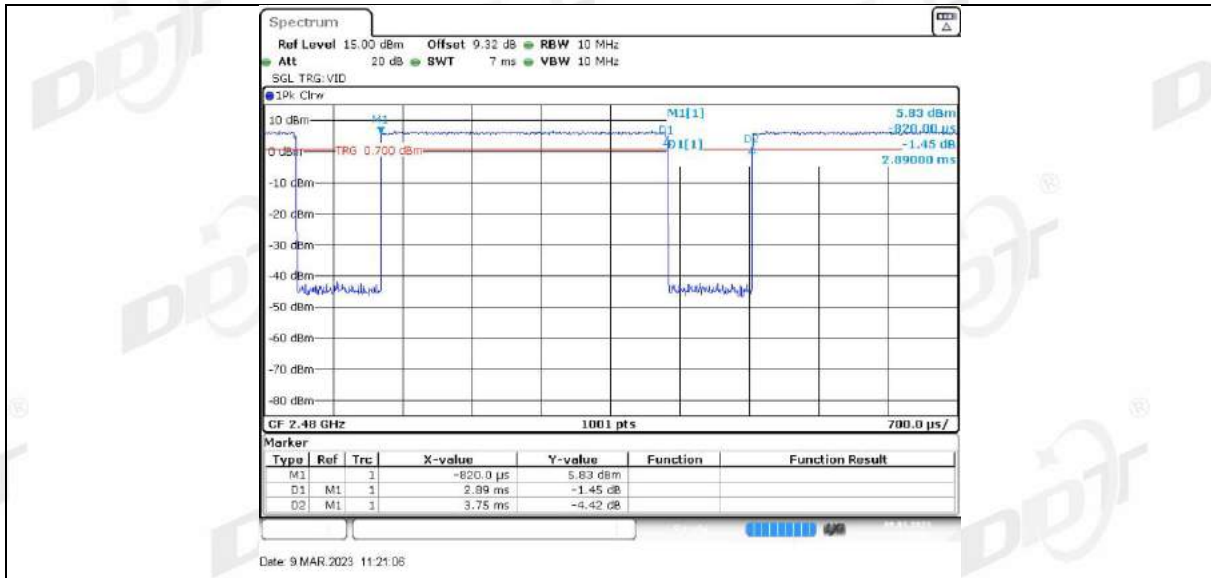

3DH5 Ant1_2402

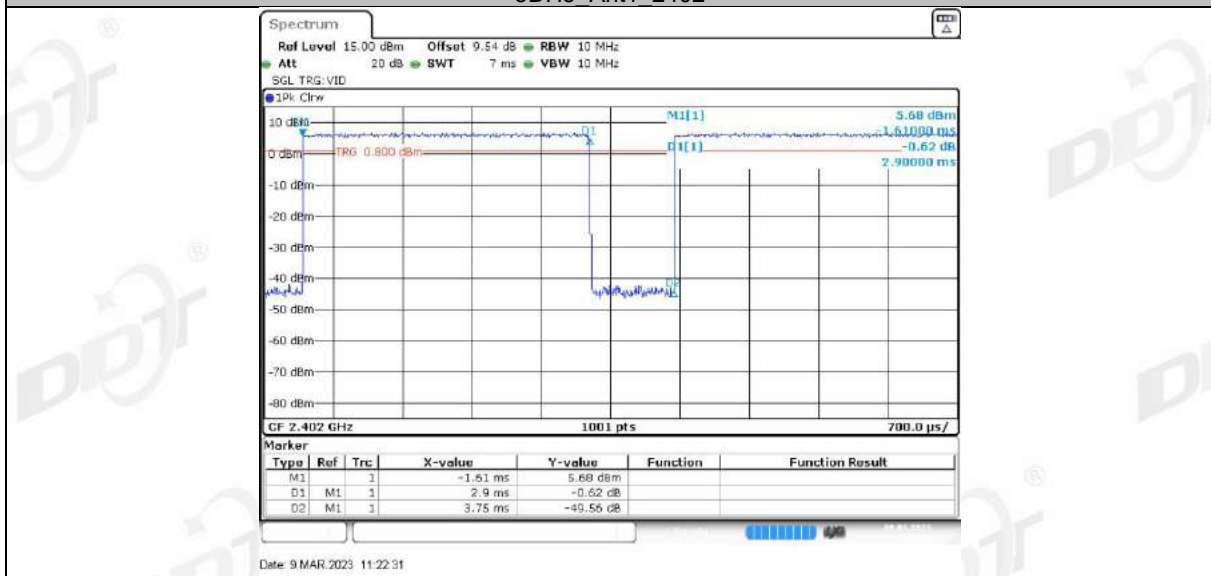

3DH5 Ant1_2441

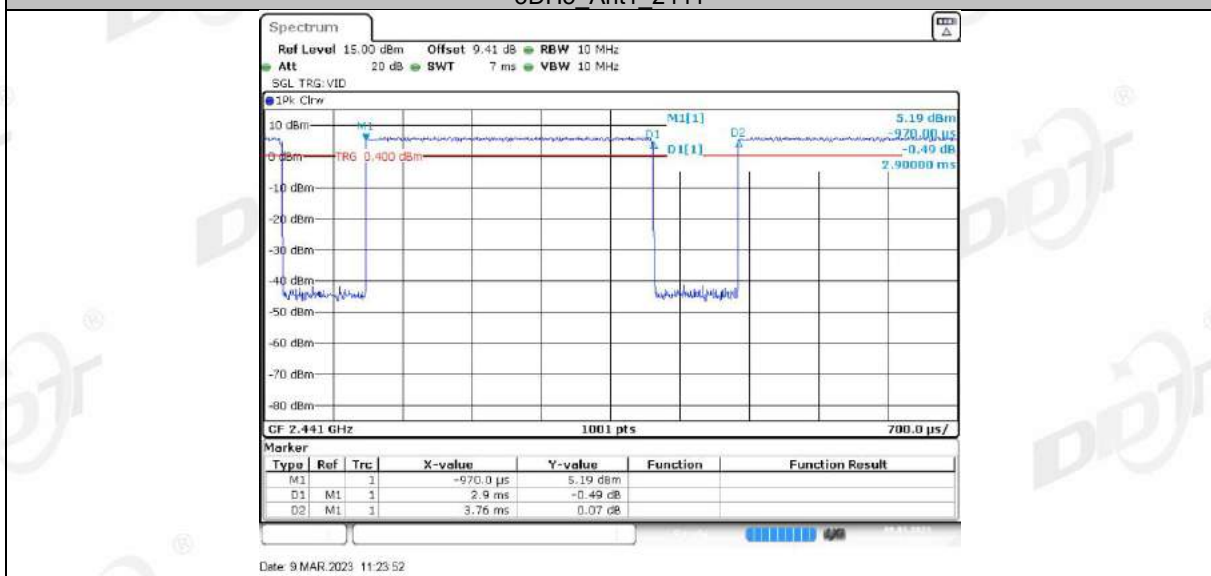

3DH5 Ant1_2480

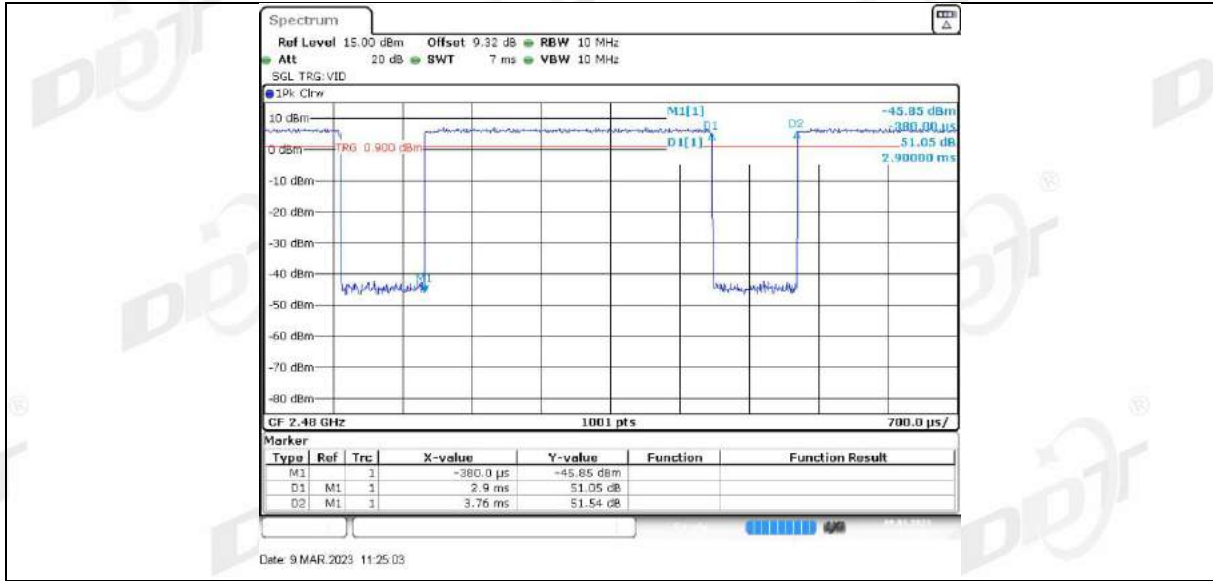

13. Radiated Emission

13.1. Block diagram of test setup

In 3 m Anechoic Chamber, test setup diagram for 9 kHz - 30 MHz:

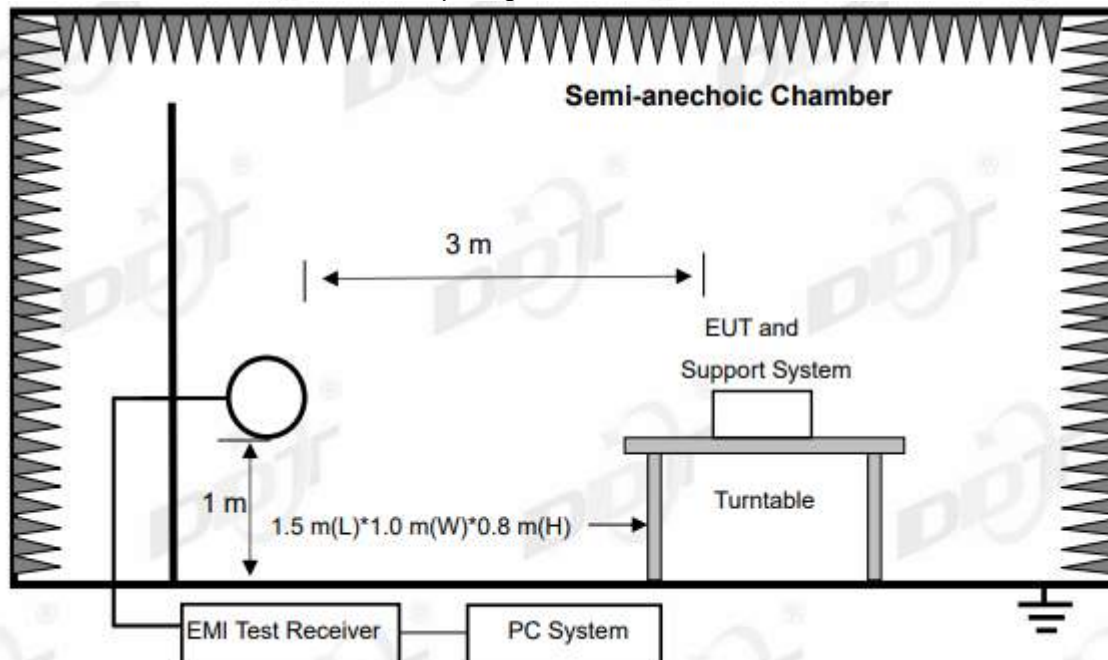

In 3 m Anechoic Chamber, test setup diagram for 30 MHz - 1 GHz:

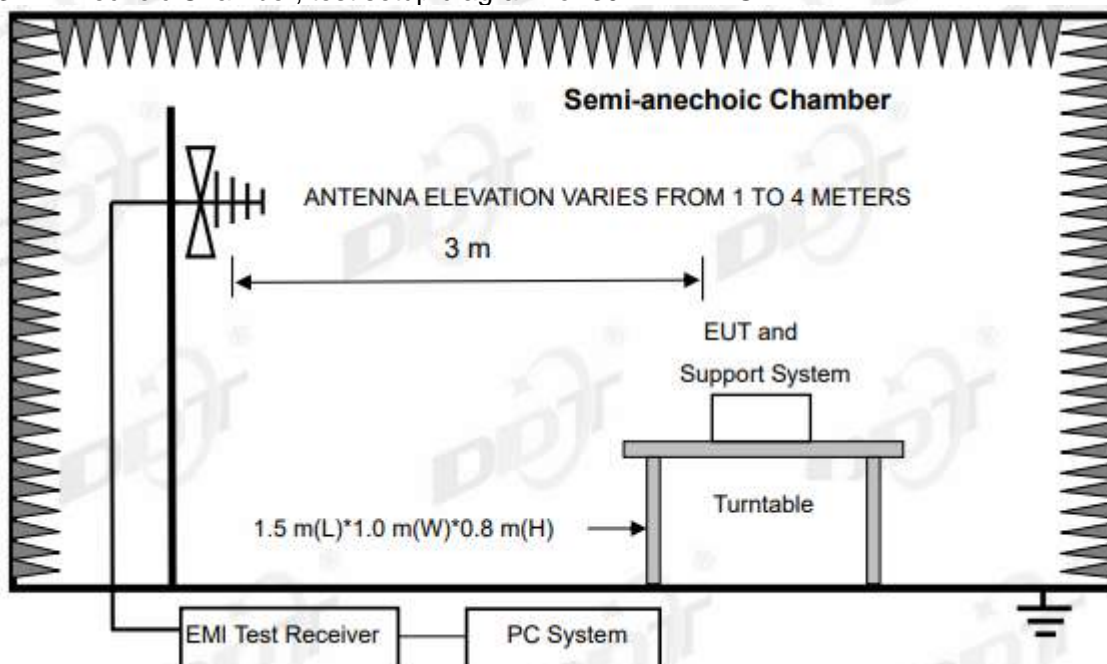

In 3 m Anechoic Chamber, test setup diagram for frequency above 1 GHz:

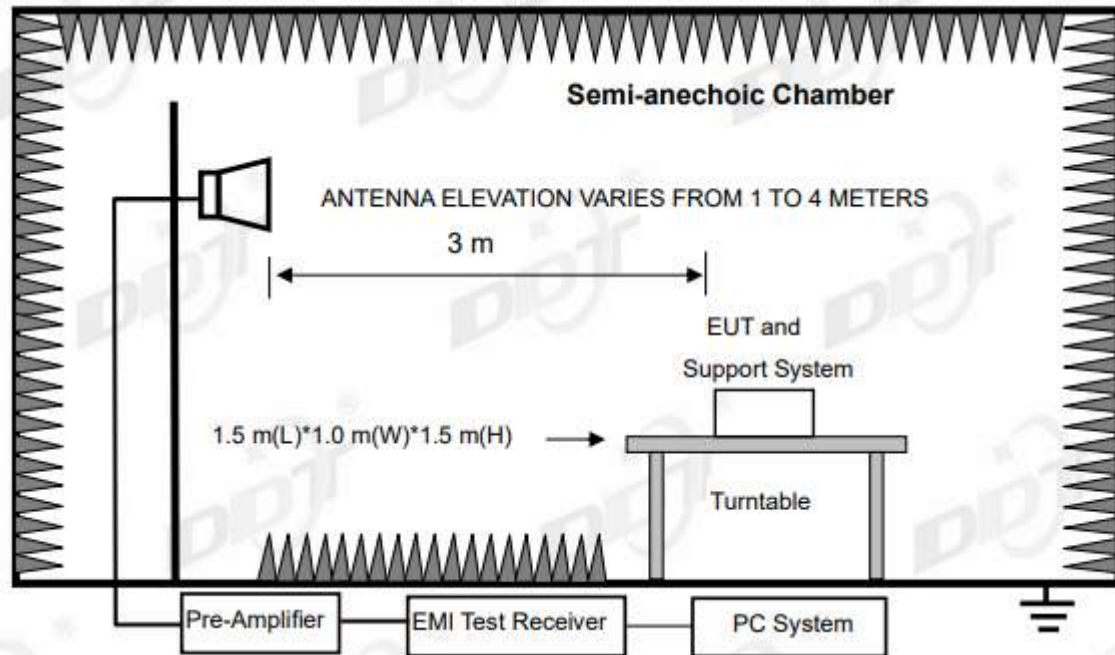

Note: For harmonic emissions test an appropriate high pass filter was inserted in the input port of AMP.

13.2. Limit

(1) FCC 15.205 Restricted frequency band

| MHz | MHz | MHz | GHz |
|--------------------------|---------------------|---------------|------------------|
| 0.090-0.110 | 16.42-16.423 | 399.9-410 | 4.5-5.15 |
| ¹ 0.495-0.505 | 16.69475-16.69525 | 608-614 | 5.35-5.46 |
| 2.1735-2.1905 | 16.80425-16.80475 | 960-1240 | 7.25-7.75 |
| 4.125-4.128 | 25.5-25.67 | 1300-1427 | 8.025-8.5 |
| 4.1772&4.17775 | 37.5-38.25 | 1435-1626.5 | 9.0-9.2 |
| 4.2072&4.20775 | 73-74.6 | 1645.5-1646.5 | 9.3-9.5 |
| 6.215-6.218 | 74.8-75.2 | 1660-1710 | 10.6-12.7 |
| 6.26775-6.26825 | 108-121.94 | 1718.8-1722.2 | 13.25-13.4 |
| 6.31175-6.31225 | 123-138 | 2200-2300 | 14.47-14.5 |
| 8.291-8.294 | 149.9-150.05 | 2310-2390 | 15.35-16.2 |
| 8.362-8.366 | 156.52475-156.52525 | 2483.5-2500 | 17.7-21.4 |
| 8.37625-8.38675 | 156.7-156.9 | 2690-2900 | 22.01-23.12 |
| 8.41425-8.41475 | 162.0125-167.17 | 3260-3267 | 23.6-24.0 |
| 12.29-12.293 | 167.72-173.2 | 3332-3339 | 31.2-31.8 |
| 12.51975-12.52025 | 240-285 | 3345.8-3358 | 36.43-36.5 |
| 12.57675-12.57725 | 322-335.4 | 3600-4400 | (²) |
| 13.36-13.41 | | | |

¹Until February 1, 1999, this restricted band shall be 0.490-0.510 MHz

²Above 38.6

RSS-Gen section 8.10 Restricted frequency bands*

| MHz | MHz | MHz | GHz |
|-----------------|---------------------|---------------|-------------|
| 0.090-0.110 | 12.51975-12.52025 | 240-285 | 3.5-4.4 |
| 0.495-0.505 | 12.57675-12.57725 | 322-335.4 | 4.5-5.15 |
| 2.1735-2.1905 | 13.36-13.41 | 399.9-410 | 5.35-5.46 |
| 3.020-3.026 | 16.42-16.423 | 608-614 | 7.25-7.75 |
| 4.125-4.128 | 16.69475-16.69525 | 960-1427 | 8.025-8.5 |
| 4.1772&4.17775 | 16.80425-16.80475 | 1435-1626.5 | 9.0-9.2 |
| 4.2072&4.20775 | 25.5-25.67 | 1645.5-1646.5 | 9.3-9.5 |
| 5.677-5.683 | 37.5-38.25 | 1660-1710 | 10.6-12.7 |
| 6.215-6.218 | 73-74.6 | 1718.8-1722.2 | 13.25-13.4 |
| 6.26775-6.26825 | 74.8-75.2 | 2200-2300 | 14.47-14.5 |
| 6.31175-6.31225 | 108-138 | 2310-2390 | 15.35-16.2 |
| 8.291-8.294 | 149.9-150.05 | 2483.5-2500 | 17.7-21.4 |
| 8.362-8.366 | 156.52475-156.52525 | 2655-2900 | 22.01-23.12 |
| 8.37625-8.38675 | 156.7-156.9 | 3260-3267 | 23.6-24.0 |
| 8.41425-8.41475 | 162.0125-167.17 | 3332-3339 | 31.2-31.8 |
| 12.29-12.293 | 167.72-173.2 | 3345.8-3358 | 36.43-36.5 |
| | | | Above 38.6 |

* Certain frequency bands listed in table and in bands above 38.6 GHz are designated for licence-exempt applications. These frequency bands and the requirements that apply to related devices are set out in the 200 and 300 series of RSSs.

(2) FCC 15.209 Limit & RSS-Gen section 8.9 Limit

| FREQUENCY MHz | DISTANCE Meters | FIELD STRENGTHS LIMIT | |
|------------------|--------------------|---|-----------------------------------|
| | | $\mu\text{V}/\text{m}$ | $\text{dB}(\mu\text{V})/\text{m}$ |
| 0.009 ~ 0.490 | 300 | 2400/F(kHz) | 67.6-20log(F) |
| 0.490 ~ 1.705 | 30 | 24000/F(kHz) | 87.6-20log(F) |
| 1.705 ~ 30.0 | 30 | 30 | 29.54 |
| 30 ~ 88 | 3 | 100 | 40.0 |
| 88 ~ 216 | 3 | 150 | 43.5 |
| 216 ~ 960 | 3 | 200 | 46.0 |
| 960 ~ 1000 | 3 | 500 | 54.0 |
| Above 1000 | 3 | 74.0 dB(μV)/m (Peak) 54.0 dB(μV)/m (Average) | |

Note: (1) The emission limits shown in the above table are based on measurements employing a CISPR QP detector except for the frequency bands 9 - 90 kHz, 110 - 490 kHz and above 1000 MHz, radiated emissions limits in these three bands are based on measurements employing an average detector.

(2) At frequencies below 30 MHz, measurement may be performed at a distance closer than that specified, and the limit at closer measurement distance can be extrapolated by below formula:

$$\text{Limit}_{3\text{m}}(\text{dB}\mu\text{V}/\text{m}) = \text{Limit}_{30\text{m}}(\text{dB}\mu\text{V}/\text{m}) + 40\text{Log}(30\text{m}/3\text{m})$$

(3) Limit for this EUT

The emissions appearing within 15.205 restricted frequency bands shall not exceed the limits shown in 15.209, and the emissions appearing within RSS-Gen section 8.10 Restricted frequency bands shall not exceed the limits shown in RSS-Gen section 8.9, all the other emissions shall be at least 20 dB below the fundamental emissions or comply with 15.209 limits and RSS-Gen section 8.9 limits.

13.3. Test Procedure

- (1) EUT was placed on a non-metallic table, 80 cm above the ground plane inside a semi-anechoic chamber for below 1G and 150 cm above the ground plane inside a fully-anechoic chamber for above 1G.
- (2) Test antenna was located 3 m from the EUT on an adjustable mast, and the antenna used as below table.

| Test frequency range | Test antenna used | Test antenna distance |
|----------------------|--|-----------------------|
| 9 kHz - 30 MHz | Active Loop antenna | 3 m |
| 30 MHz - 1 GHz | Trilog Broadband Antenna | 3 m |
| 1 GHz - 18 GHz | Double Ridged Horn Antenna (1 GHz - 18 GHz) | 3 m |
| 18 GHz - 40 GHz | Horn Antenna (18 GHz - 40 GHz) | 1 m |

According ANSI C63.10:2013 clause 6.4.6 and 6.5.3, for measurements below 30 MHz, Antenna was located 3 m from EUT, the loop antenna was positioned in three antenna orientations (parallel, perpendicular, and round-parallel), for each measurement antenna alignment, the EUT shall be rotated through 0° to 360° on a turntable, and the lowest height of the magnetic antenna shall be 1 m above the ground. For measurement above 30MHz, the trilog Broadband Antenna or Horn Antenna was located 3m from EUT, Measurements were made with the antenna positioned in both the horizontal and vertical planes of Polarization, and the measurement antenna was varied from 1 m to 4 m. in height above the reference ground plane to obtain the maximum signal strength.

(3) Below pre-scan procedure was first performed in order to find prominent frequency spectrum radiated emissions from 9 kHz to 25 GHz:

(a) Scanning the peak frequency spectrum with the antenna specified in step (3), and the EUT was rotated 360 degree, the antenna height was varied from 1 m to 4 m (Except loop antenna, it's fixed 1 m above ground.)

(b) Change work frequency or channel of device if practicable.

(c) Change modulation type of device if practicable.

(d) Change power supply range from 85% to 115% of the rated supply voltage

(e) Rotated EUT though three orthogonal axes to determine the attitude of EUT arrangement produces highest emissions.

Spectrum frequency from 9 kHz to 25 GHz (tenth harmonic of fundamental frequency) was

investigated, and no any obvious emission were detected from 18 GHz to 25 GHz, so below final test was performed with frequency range from 9 kHz to 18 GHz.

- (4) For final emissions measurements at each frequency of interest, the EUT was rotated and the antenna height was varied between 1 m and 4 m in order to maximize the emission. Measurements in both horizontal and vertical polarities were made and the data was recorded. In order to find the maximum emission, the relative positions of equipment and all of the interface cables were changed according to ANSI C63.10:2013 on Radiated Emission test.
- (5) The emissions from 9 kHz to 1 GHz were measured based on CISPR QP detector except for the frequency bands 9 - 90 kHz, 110 - 490 kHz, for emissions from 9 kHz - 90 kHz, 110 kHz - 490 kHz and above 1 GHz were measured based on average detector, for emissions above 1 GHz, peak emissions also be measured and need comply with Peak limit.
- (6) The emissions from 9 kHz to 1 GHz, QP or average values were measured with EMI receiver with below RBW.

| Frequency band | RBW |
|------------------|---------|
| 9 kHz - 150 kHz | 200 Hz |
| 150 kHz - 30 MHz | 9 kHz |
| 30 MHz - 1 GHz | 120 kHz |

- (7) For emissions above 1GHz, both Peak and Average level were measured with Spectrum Analyzer, and the RBW is set at 1 MHz, VBW is set at 3 MHz for Peak measure; According ANSI C63.10:2013 clause 4.1.4.2.2 procedure for average measure.
- (8) For portable device, X axis, Y axis, Z axis are tested, and worse setup is reported.

13.4. Test result

Pass. (See below detailed test result)

All the emissions except fundamental emission from 9 kHz to 25 GHz were comply with 15.209 limits and RSS-Gen section 8.9 limits.

Note1: According exploratory test, the emission levels are 20 dB below the limit detected from 9 kHz to 30 MHz and 18 GHz to 25 GHz, so the final test was performed with frequency range from 30 MHz to 18 GHz and recorded in below.

Note2: 30 MHz ~ 25 GHz: (Scan with GFSK, $\pi/4$ -DQPSK and 8DPSK, the worst case is GFSK Mode)

Note3: For emissions below 1 GHz, according exploratory explorer test, when change Tx mode and channel, have no distinct influence on emissions level, so for emissions below 1 GHz, the final test was only performed with EUT working in GFSK, Tx 2402 MHz mode.

Note4: For emissions above 1 GHz. If peak results comply with AV limit, AV Result is deemed to comply with AV limit.

Radiated Emission test (below 1 GHz)

TR-4-E-009 Radiated Emission Test Result

Test Date: 2023-03-07 **Tested By:** Liaowanrong
EUT: 21" POWERED BLUETOOTH SOUNDBAR AUDIO SYSTEM WITH LED LIGHTING **Model Number:** RALLYBAR
Test Mode: TX Mode **Power Supply:** DC 12V
Condition: Temp:23.2°C;Humi:47.2% **Test Site:** DDT 3# Chamber
File Path: d:\ts\2023 report date\Q23022419-2E RALLYBAR\FCC BELOW 1G\20230307-114030_H
Memo: BT

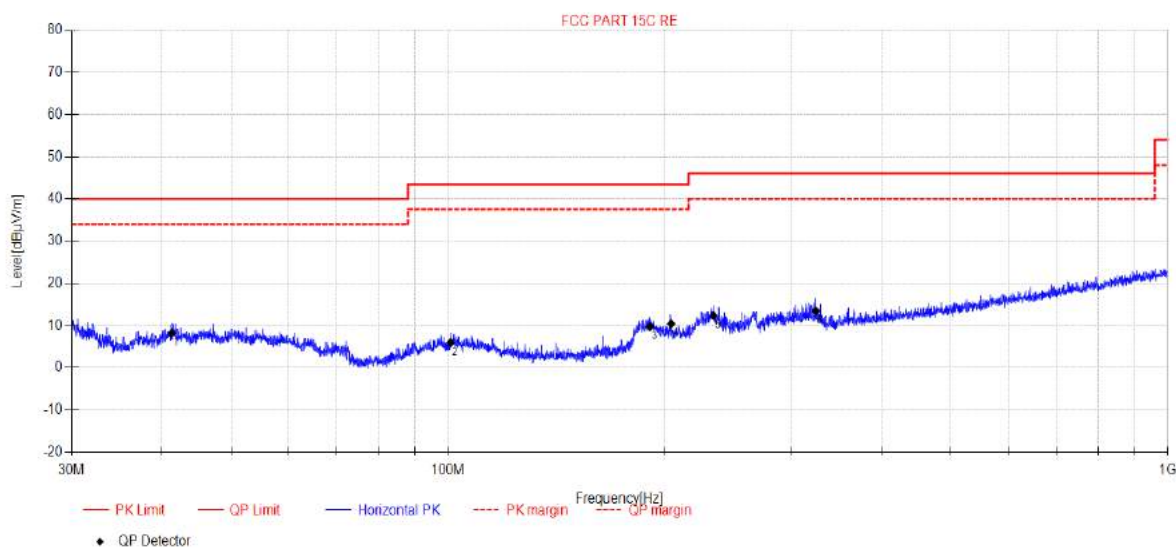

| Final Data List | | | | | | | | | | |
|-----------------|-------------|------------------|---------------------|-----------------|----------|-----------------|----------------|-------------|----------|------------|
| NO. | Freq. [MHz] | Reading [dBμV/m] | Antenna Factor [dB] | Cable Loss [dB] | AMP [dB] | Result [dBμV/m] | Limit [dBμV/m] | Margin [dB] | Detector | Polarity |
| 1 | 41.30 | 27.41 | 12.36 | 0.72 | -32.28 | 8.21 | 40.00 | 31.79 | QP | Horizontal |
| 2 | 100.84 | 25.84 | 10.98 | 1.41 | -32.24 | 5.99 | 43.50 | 37.51 | QP | Horizontal |
| 3 | 190.74 | 29.76 | 10.27 | 1.94 | -32.26 | 9.71 | 43.50 | 33.79 | QP | Horizontal |
| 4 | 204.16 | 29.89 | 10.78 | 2.02 | -32.26 | 10.43 | 43.50 | 33.07 | QP | Horizontal |
| 5 | 233.91 | 30.57 | 11.86 | 2.15 | -32.18 | 12.40 | 46.00 | 33.60 | QP | Horizontal |
| 6 | 324.30 | 29.27 | 13.97 | 2.54 | -32.33 | 13.45 | 46.00 | 32.55 | QP | Horizontal |

Note:

1. Result Level = Reading + Cable loss + Antenna Factor + AMP
2. If Peak Result complies with QP limit, QP Result is deemed to comply with QP limit.
3. Test setup: RBW: 120 kHz, VBW: 300 kHz, Sweep time: auto.

TR-4-E-009 Radiated Emission Test Result

Test Date: 2023-03-07 **Tested By:** Liaowanrong
EUT: 21" POWERED BLUETOOTH SOUNDBAR AUDIO SYSTEM WITH LED LIGHTING **Model Number:** RALLYBAR
Test Mode: TX Mode **Power Supply:** DC 12V
Condition: Temp:23.2°C;Humi:47.2% **Test Site:** DDT 3# Chamber
File Path: d:\ts\2023 report date\Q23022419-2E RALLYBAR\FCC BELOW 1G\20230307-114120_V
Memo: BT

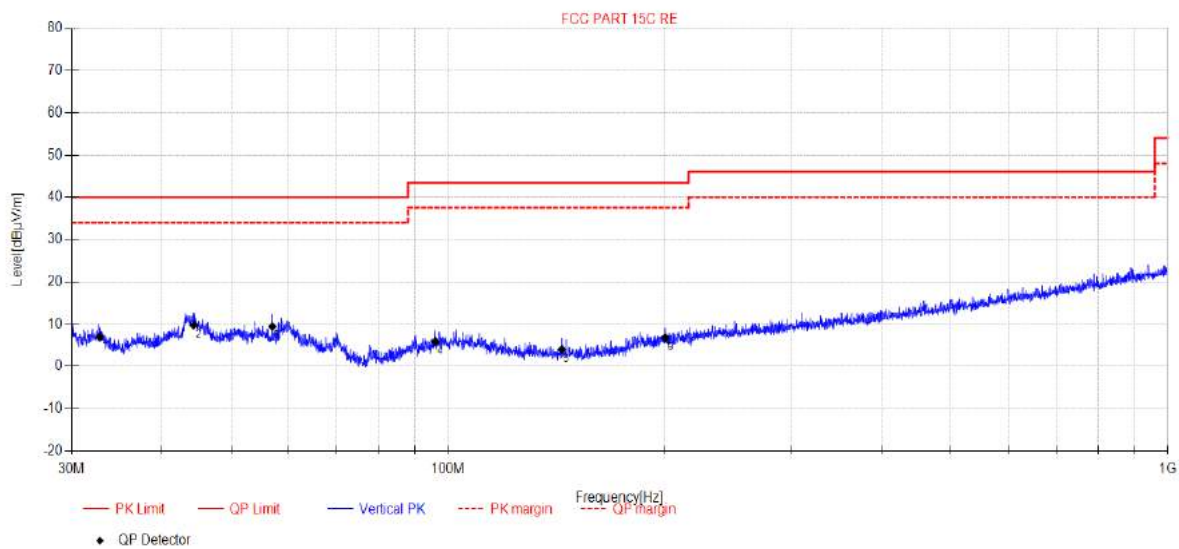

| Final Data List | | | | | | | | | | |
|-----------------|-------------|------------------|---------------------|-----------------|----------|-----------------|----------------|-------------|----------|----------|
| NO. | Freq. [MHz] | Reading [dBμV/m] | Antenna Factor [dB] | Cable Loss [dB] | AMP [dB] | Result [dBμV/m] | Limit [dBμV/m] | Margin [dB] | Detector | Polarity |
| 1 | 32.79 | 28.29 | 10.40 | 0.63 | -32.29 | 7.03 | 40.00 | 32.97 | QP | Vertical |
| 2 | 44.30 | 28.36 | 12.93 | 0.75 | -32.28 | 9.76 | 40.00 | 30.24 | QP | Vertical |
| 3 | 56.98 | 28.42 | 12.40 | 0.89 | -32.27 | 9.44 | 40.00 | 30.56 | QP | Vertical |
| 4 | 96.01 | 26.25 | 10.50 | 1.35 | -32.24 | 5.86 | 43.50 | 37.64 | QP | Vertical |
| 5 | 143.99 | 27.17 | 7.40 | 1.66 | -32.19 | 4.04 | 43.50 | 39.46 | QP | Vertical |
| 6 | 200.33 | 26.37 | 10.71 | 2.00 | -32.28 | 6.80 | 43.50 | 36.70 | QP | Vertical |

Note:

1. Result Level = Reading + Cable loss + Antenna Factor + AMP
2. If Peak Result complies with QP limit, QP Result is deemed to comply with QP limit.
3. Test setup: RBW: 120 kHz, VBW: 300 kHz, Sweep time: auto.

Radiated Emission test (above 1 GHz)

TR-4-E-009 Radiated Emission Test Result

Test Date: 2023-03-09 **Tested By:** Liaowanrong
EUT: 21" POWERED BLUETOOTH SOUNDBAR AUDIO SYSTEM WITH LED LIGHTING **Model Number:** RALLYBAR
Test Mode: TX Mode **Power Supply:** DC 12V
Condition: Temp:23.2°C;Humi:47.2% **Test Site:** DDT 3# Chamber
File Path: d:\ts\2023 report date\Q23022419-2E RALLYBAR\FCC ABOVE 1G\3
Memo: DH5 2402

Test Graph

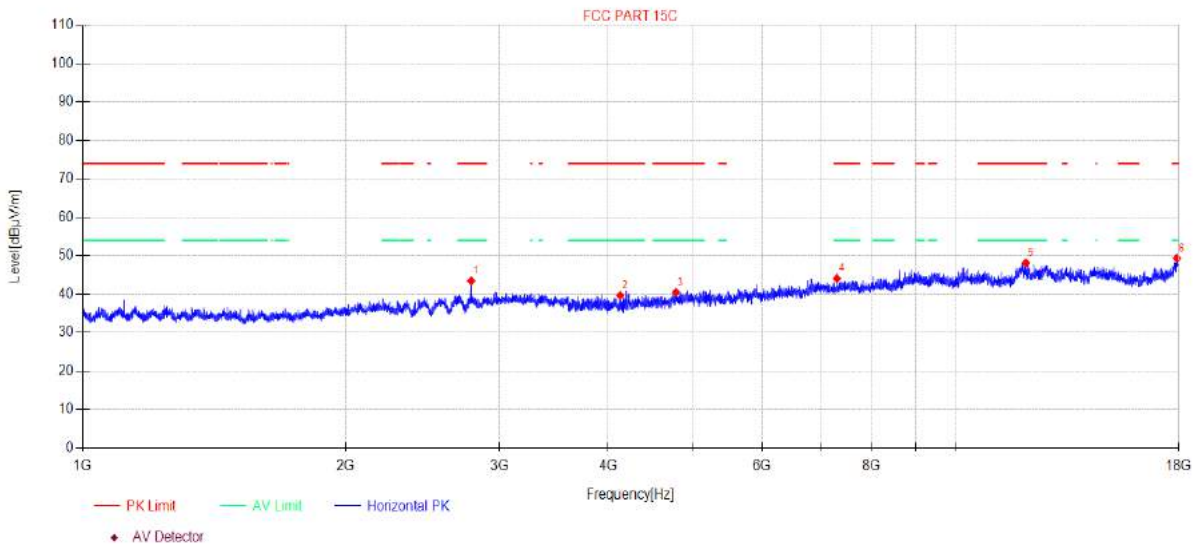

| Suspected Data List | | | | | | | | | | |
|---------------------|-------------|----------------|-----------------|---------------------|----------|----------------|----------------|-------------|----------|------------|
| NO | Freq. [MHz] | Reading [dBµV] | Cable Loss [dB] | Antenna Factor [dB] | AMP [dB] | Level [dBµV/m] | Limit [dBµV/m] | Margin [dB] | Detector | Polarity |
| 1 | 2785.80 | 52.11 | 3.49 | 28.47 | -40.56 | 43.51 | 74.00 | 30.49 | PK | Horizontal |
| 2 | 4125.95 | 46.88 | 3.20 | 30.95 | -41.36 | 39.67 | 74.00 | 34.33 | PK | Horizontal |
| 3 | 4779.81 | 46.18 | 3.28 | 32.22 | -41.17 | 40.51 | 74.00 | 33.49 | PK | Horizontal |
| 4 | 7307.89 | 44.92 | 3.71 | 36.50 | -41.00 | 44.13 | 74.00 | 29.87 | PK | Horizontal |
| 5 | 12024.14 | 43.30 | 4.80 | 38.95 | -38.92 | 48.13 | 74.00 | 25.87 | PK | Horizontal |
| 6 | 17916.96 | 40.17 | 8.57 | 41.30 | -40.67 | 49.37 | 74.00 | 24.63 | PK | Horizontal |

Note:

- Level = Reading + Cable Loss + Antenna Factor + AMP
- If Peak Result complies with AV limit, AV Result is deemed to comply with AV limit.
- Test setup: RBW: 1 MHz, VBW: 3 MHz, Sweep time: auto.

TR-4-E-009 Radiated Emission Test Result

Test Date: 2023-03-09 **Tested By:** Liaowanrong
EUT: 21" POWERED BLUETOOTH SOUNDBAR AUDIO SYSTEM WITH LED LIGHTING **Model Number:** RALLYBAR
Test Mode: TX Mode **Power Supply:** DC 12V
Condition: Temp:23.2°C;Humi:47.2% **Test Site:** DDT 3# Chamber
File Path: d:\ts\2023 report date\Q23022419-2E RALLYBAR\FCC ABOVE 1G\4
Memo: DH5 2402

Test Graph

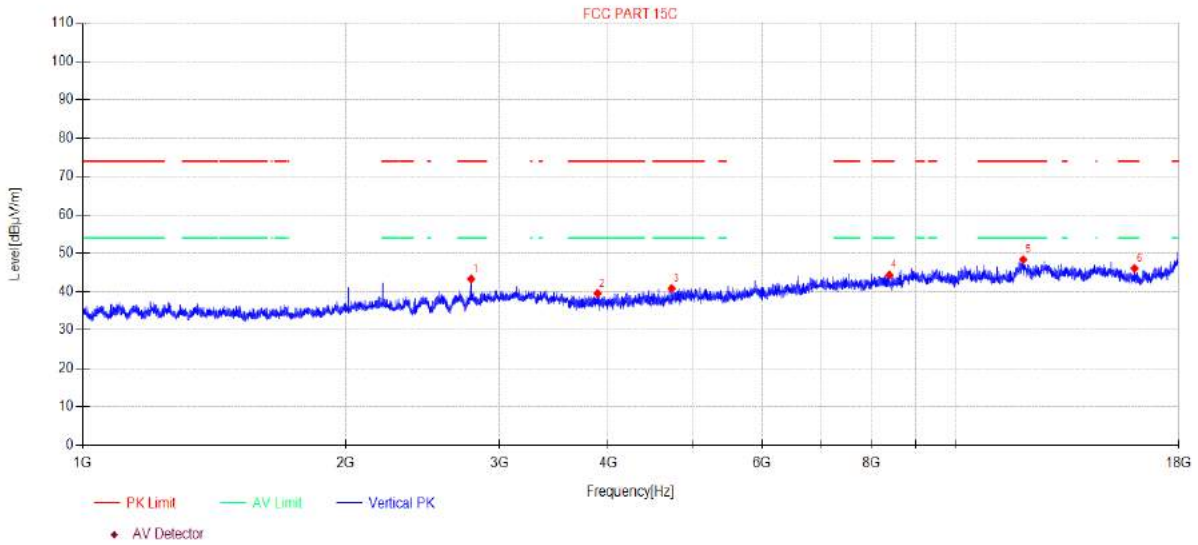

| Suspected Data List | | | | | | | | | | |
|---------------------|-------------|----------------|-----------------|---------------------|----------|----------------|----------------|-------------|----------|----------|
| NO | Freq. [MHz] | Reading [dBµV] | Cable Loss [dB] | Antenna Factor [dB] | AMP [dB] | Level [dBµV/m] | Limit [dBµV/m] | Margin [dB] | Detector | Polarity |
| 1 | 2785.80 | 51.95 | 3.49 | 28.47 | -40.56 | 43.35 | 74.00 | 30.65 | PK | Vertical |
| 2 | 3886.36 | 47.15 | 3.25 | 30.47 | -41.33 | 39.54 | 74.00 | 34.46 | PK | Vertical |
| 3 | 4724.88 | 46.69 | 3.27 | 32.05 | -41.18 | 40.83 | 74.00 | 33.17 | PK | Vertical |
| 4 | 8390.51 | 43.52 | 3.92 | 37.28 | -40.38 | 44.34 | 74.00 | 29.66 | PK | Vertical |
| 5 | 11944.48 | 43.71 | 4.78 | 38.84 | -38.99 | 48.34 | 74.00 | 25.66 | PK | Vertical |
| 6 | 16021.02 | 41.86 | 6.70 | 37.88 | -40.40 | 46.04 | 74.00 | 27.96 | PK | Vertical |

Note:

1. Level = Reading + Cable Loss + Antenna Factor + AMP
2. If Peak Result complies with AV limit, AV Result is deemed to comply with AV limit.
3. Test setup: RBW: 1 MHz, VBW: 3 MHz, Sweep time: auto.

TR-4-E-009 Radiated Emission Test Result

Test Date: 2023-03-09 **Tested By:** Liaowanrong
EUT: 21" POWERED BLUETOOTH SOUNDBAR AUDIO SYSTEM WITH LED LIGHTING **Model Number:** RALLYBAR
Test Mode: TX Mode **Power Supply:** DC 12V
Condition: Temp:23.2°C;Humi:47.2% **Test Site:** DDT 3# Chamber
File Path: d:\ts\2023 report date\Q23022419-2E RALLYBAR\FCC ABOVE 1G\7
Memo: DH5 2441

Test Graph

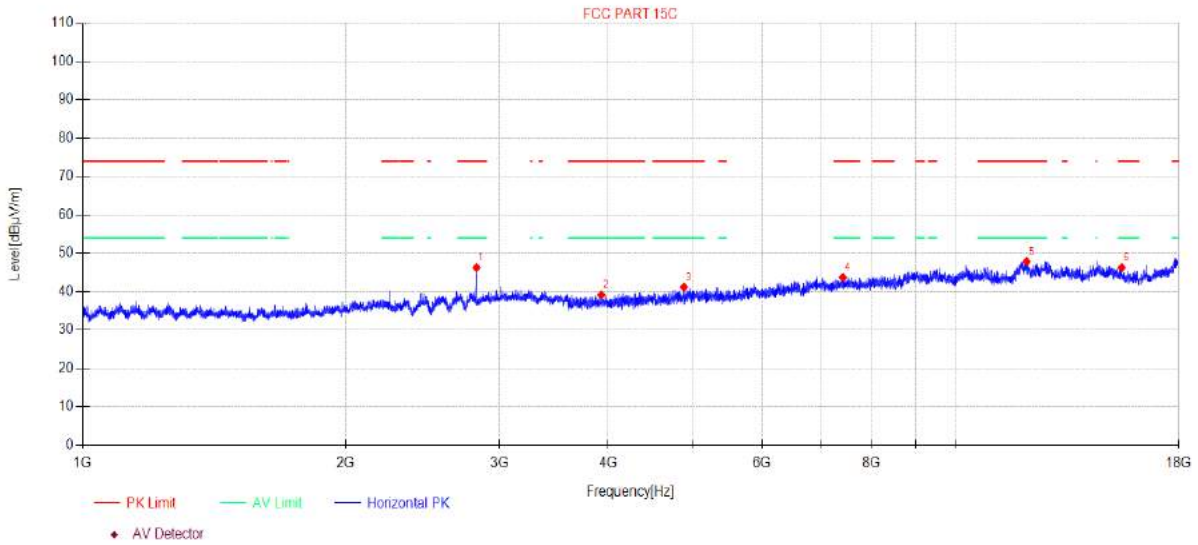

| Suspected Data List | | | | | | | | | | |
|---------------------|-------------|----------------|-----------------|---------------------|----------|----------------|----------------|-------------|----------|------------|
| NO | Freq. [MHz] | Reading [dBµV] | Cable Loss [dB] | Antenna Factor [dB] | AMP [dB] | Level [dBµV/m] | Limit [dBµV/m] | Margin [dB] | Detector | Polarity |
| 1 | 2824.71 | 54.73 | 3.52 | 28.60 | -40.61 | 46.24 | 74.00 | 27.76 | PK | Horizontal |
| 2 | 3927.00 | 46.72 | 3.23 | 30.55 | -41.36 | 39.14 | 74.00 | 34.86 | PK | Horizontal |
| 3 | 4881.73 | 46.50 | 3.29 | 32.56 | -41.14 | 41.21 | 74.00 | 32.79 | PK | Horizontal |
| 4 | 7422.84 | 44.54 | 3.74 | 36.50 | -41.00 | 43.78 | 74.00 | 30.22 | PK | Horizontal |
| 5 | 12051.97 | 42.98 | 4.81 | 39.00 | -38.95 | 47.84 | 74.00 | 26.16 | PK | Horizontal |
| 6 | 15488.34 | 41.34 | 6.33 | 38.61 | -40.04 | 46.24 | 74.00 | 27.76 | PK | Horizontal |

Note:

1. Level = Reading + Cable Loss + Antenna Factor + AMP
2. If Peak Result complies with AV limit, AV Result is deemed to comply with AV limit.
3. Test setup: RBW: 1 MHz, VBW: 3 MHz, Sweep time: auto.

TR-4-E-009 Radiated Emission Test Result

Test Date: 2023-03-09 **Tested By:** Liaowanrong
EUT: 21" POWERED BLUETOOTH SOUNDBAR AUDIO SYSTEM WITH LED LIGHTING **Model Number:** RALLYBAR
Test Mode: TX Mode **Power Supply:** DC 12V
Condition: Temp:23.2°C;Humi:47.2% **Test Site:** DDT 3# Chamber
File Path: d:\ts\2023 report date\Q23022419-2E RALLYBAR\FCC ABOVE 1G\8
Memo: DH5 2441

Test Graph

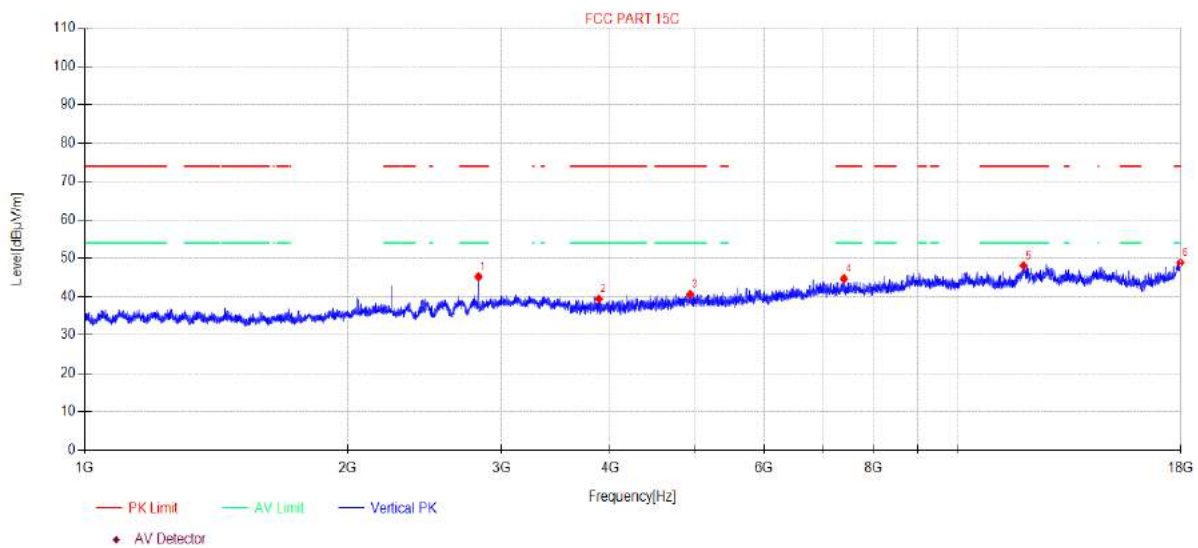

Suspected Data List

| NO | Freq. [MHz] | Reading [dBμV] | Cable Loss [dB] | Antenna Factor [dB] | AMP [dB] | Level [dBμV/m] | Limit [dBμV/m] | Margin [dB] | Detector | Polarity |
|----|-------------|----------------|-----------------|---------------------|----------|----------------|----------------|-------------|----------|----------|
| 1 | 2824.71 | 53.68 | 3.52 | 28.60 | -40.61 | 45.19 | 74.00 | 28.81 | PK | Vertical |
| 2 | 3879.62 | 47.01 | 3.25 | 30.46 | -41.33 | 39.39 | 74.00 | 34.61 | PK | Vertical |
| 3 | 4935.64 | 45.71 | 3.29 | 32.74 | -41.12 | 40.62 | 74.00 | 33.38 | PK | Vertical |
| 4 | 7407.84 | 45.46 | 3.73 | 36.50 | -41.00 | 44.69 | 74.00 | 29.31 | PK | Vertical |
| 5 | 11892.81 | 43.57 | 4.77 | 38.80 | -39.07 | 48.07 | 74.00 | 25.93 | PK | Vertical |
| 6 | 17989.60 | 39.16 | 8.67 | 41.74 | -40.70 | 48.87 | 74.00 | 25.13 | PK | Vertical |

Note:

- Level = Reading + Cable Loss + Antenna Factor + AMP
- If Peak Result complies with AV limit, AV Result is deemed to comply with AV limit.
- Test setup: RBW: 1 MHz, VBW: 3 MHz, Sweep time: auto.

TR-4-E-009 Radiated Emission Test Result

Test Date: 2023-03-09 **Tested By:** Liaowanrong
EUT: 21" POWERED BLUETOOTH SOUNDBAR AUDIO SYSTEM WITH LED LIGHTING **Model Number:** RALLYBAR
Test Mode: TX Mode **Power Supply:** DC 12V
Condition: Temp:23.2°C;Humi:47.2% **Test Site:** DDT 3# Chamber
File Path: d:\ts\2023 report date\Q23022419-2E RALLYBAR\FCC ABOVE 1G\9
Memo: DH5 2480

Test Graph

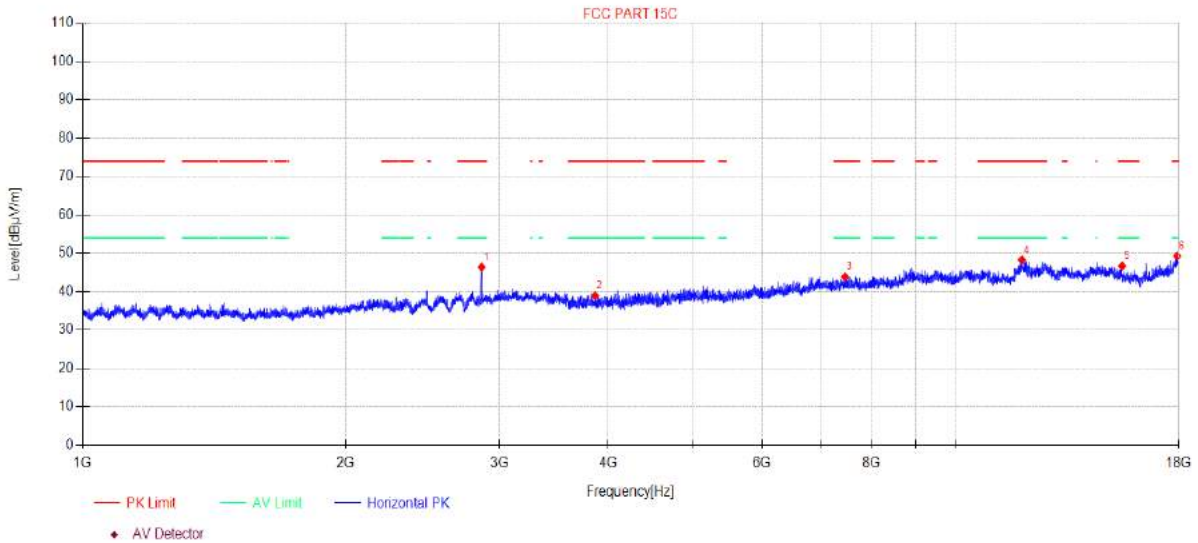

| Suspected Data List | | | | | | | | | | |
|---------------------|-------------|----------------|-----------------|---------------------|----------|----------------|----------------|-------------|----------|------------|
| NO | Freq. [MHz] | Reading [dBµV] | Cable Loss [dB] | Antenna Factor [dB] | AMP [dB] | Level [dBµV/m] | Limit [dBµV/m] | Margin [dB] | Detector | Polarity |
| 1 | 2863.34 | 54.69 | 3.56 | 28.75 | -40.65 | 46.35 | 74.00 | 27.65 | PK | Horizontal |
| 2 | 3862.84 | 46.54 | 3.26 | 30.43 | -41.32 | 38.91 | 74.00 | 35.09 | PK | Horizontal |
| 3 | 7465.87 | 44.68 | 3.75 | 36.47 | -41.00 | 43.90 | 74.00 | 30.10 | PK | Horizontal |
| 4 | 11903.12 | 43.78 | 4.77 | 38.80 | -39.06 | 48.29 | 74.00 | 25.71 | PK | Horizontal |
| 5 | 15506.26 | 41.79 | 6.34 | 38.59 | -40.05 | 46.67 | 74.00 | 27.33 | PK | Horizontal |
| 6 | 17927.32 | 40.01 | 8.58 | 41.36 | -40.67 | 49.28 | 74.00 | 24.72 | PK | Horizontal |

Note:

1. Level = Reading + Cable Loss + Antenna Factor + AMP
2. If Peak Result complies with AV limit, AV Result is deemed to comply with AV limit.
3. Test setup: RBW: 1 MHz, VBW: 3 MHz, Sweep time: auto.

TR-4-E-009 Radiated Emission Test Result

Test Date: 2023-03-09 **Tested By:** Liaowanrong
EUT: 21" POWERED BLUETOOTH SOUNDBAR AUDIO SYSTEM WITH LED LIGHTING **Model Number:** RALLYBAR
Test Mode: TX Mode **Power Supply:** DC 12V
Condition: Temp:23.2°C;Humi:47.2% **Test Site:** DDT 3# Chamber
File Path: d:\ts\2023 report date\Q23022419-2E RALLYBAR\FCC ABOVE 1G\10
Memo: DH5 2480

Test Graph

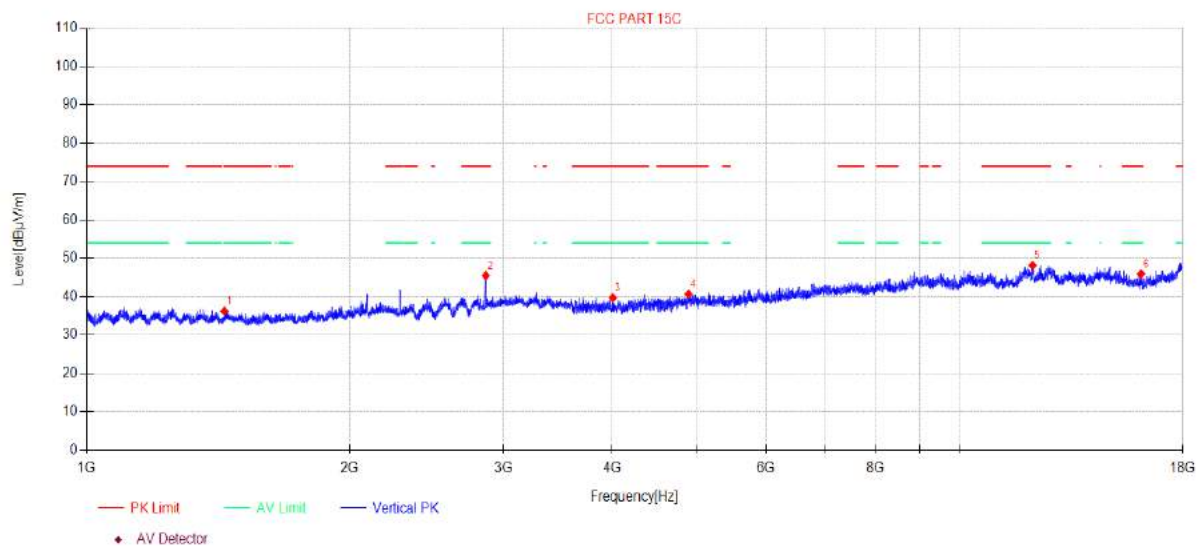

Suspected Data List

| NO | Freq. [MHz] | Reading [dBμV] | Cable Loss [dB] | Antenna Factor [dB] | AMP [dB] | Level [dBμV/m] | Limit [dBμV/m] | Margin [dB] | Detector | Polarity |
|----|-------------|----------------|-----------------|---------------------|----------|----------------|----------------|-------------|----------|----------|
| 1 | 1438.04 | 47.43 | 2.10 | 25.60 | -38.86 | 36.27 | 74.00 | 37.73 | PK | Vertical |
| 2 | 2864.17 | 53.81 | 3.56 | 28.76 | -40.65 | 45.48 | 74.00 | 28.52 | PK | Vertical |
| 3 | 4004.94 | 47.21 | 3.19 | 30.71 | -41.40 | 39.71 | 74.00 | 34.29 | PK | Vertical |
| 4 | 4890.20 | 45.93 | 3.29 | 32.58 | -41.13 | 40.67 | 74.00 | 33.33 | PK | Vertical |
| 5 | 12114.83 | 43.24 | 4.82 | 39.10 | -39.01 | 48.15 | 74.00 | 25.85 | PK | Vertical |
| 6 | 16123.21 | 41.76 | 6.77 | 37.78 | -40.39 | 45.92 | 74.00 | 28.08 | PK | Vertical |

Note:

- Level = Reading + Cable Loss + Antenna Factor + AMP
- If Peak Result complies with AV limit, AV Result is deemed to comply with AV limit.
- Test setup: RBW: 1 MHz, VBW: 3 MHz, Sweep time: auto.

14. Band Edge Compliance (Radiated Method)

14.1. Block diagram of test setup

In 3 m Anechoic Chamber, test setup diagram for frequency above 1 GHz:

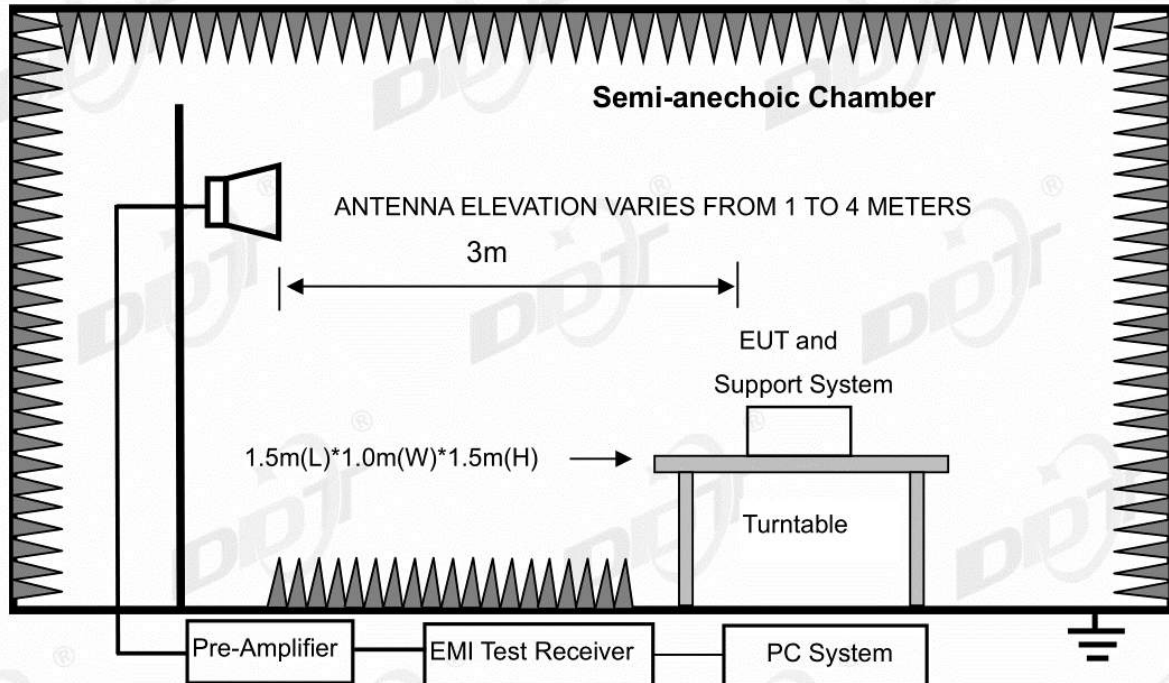

14.2. Limit

All restriction band should comply with 15.209 and RSS-Gen section 8.9 limits, other emission should be at least 20 dB below the fundamental.

14.3. Test Procedure

Same with Radiated Emission except change investigated frequency range from 2310 MHz to 2410 MHz and 2475 MHz to 2500 MHz.

Remark: All restriction band have been tested, and only the worst case is shown in report.

14.4. Test result

Pass. (See below detailed test result)

Remark: hopping on and hopping off mode all have been test, hopping off mode is worse and reported only. Scan with all mode, the worst case is recorded in this report.

TR-4-E-009 Radiated Emission Test Result

Test Date: 2023-03-09 **Tested By:** Liaowanrong
EUT: 21" POWERED BLUETOOTH SOUNDBAR AUDIO SYSTEM WITH LED LIGHTING **Model Number:** RALLYBAR
Test Mode: TX Mode **Power Supply:** DC 12V
Condition: Temp:23.2°C;Humi:47.2% **Test Site:** DDT 3# Chamber
File Path: d:\ts\2023 report date\Q23022419-2E RALLYBAR\FCC ABOVE 1G\5
Memo: DH5 2402

Test Graph

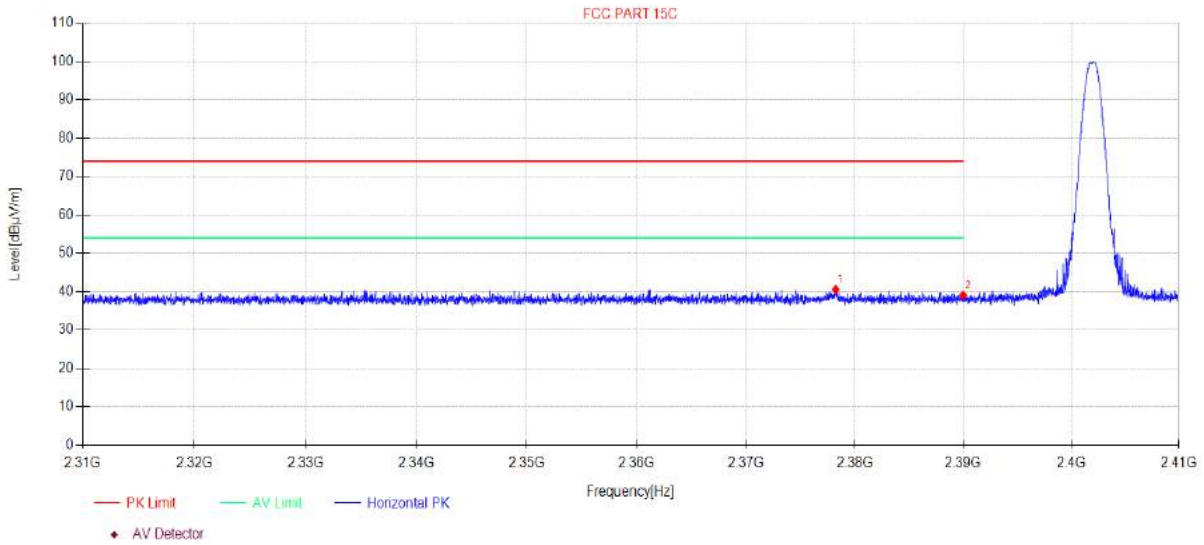

| Suspected Data List | | | | | | | | | | |
|---------------------|-------------|----------------|-----------------|---------------------|----------|----------------|----------------|-------------|----------|------------|
| NO | Freq. [MHz] | Reading [dBµV] | Cable Loss [dB] | Antenna Factor [dB] | AMP [dB] | Level [dBµV/m] | Limit [dBµV/m] | Margin [dB] | Detector | Polarity |
| 1 | 2378.24 | 50.18 | 3.04 | 27.46 | -40.12 | 40.56 | 74.00 | 33.44 | PK | Horizontal |
| 2 | 2390.00 | 48.62 | 3.06 | 27.48 | -40.13 | 39.03 | 74.00 | 34.97 | PK | Horizontal |

Note:

1. Level = Reading + Cable Loss + Antenna Factor + AMP
2. If Peak Result complies with AV limit, AV Result is deemed to comply with AV limit.
3. Test setup: RBW: 1 MHz, VBW: 3 MHz, Sweep time: auto.

TR-4-E-009 Radiated Emission Test Result

Test Date: 2023-03-09 **Tested By:** Liaowanrong
EUT: 21" POWERED BLUETOOTH SOUNDBAR AUDIO SYSTEM WITH LED LIGHTING **Model Number:** RALLYBAR
Test Mode: TX Mode **Power Supply:** DC 12V
Condition: Temp:23.2°C;Humi:47.2% **Test Site:** DDT 3# Chamber
File Path: d:\ts\2023 report date\Q23022419-2E RALLYBAR\FCC ABOVE 1G\6
Memo: DH5 2402

Test Graph

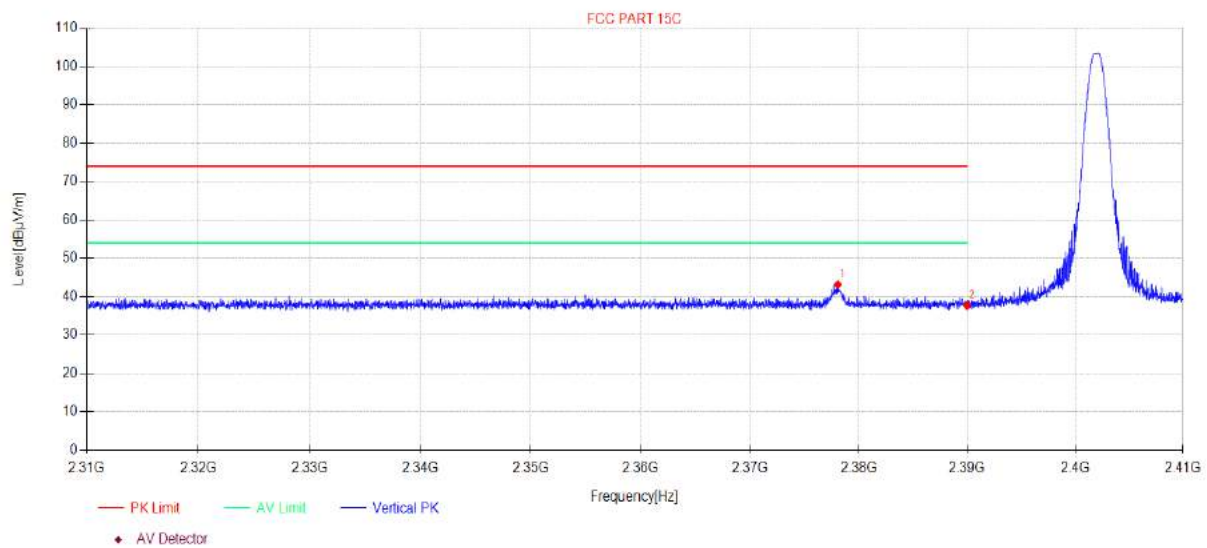

| Suspected Data List | | | | | | | | | | |
|---------------------|-------------|----------------|-----------------|---------------------|----------|----------------|----------------|-------------|----------|----------|
| NO | Freq. [MHz] | Reading [dBμV] | Cable Loss [dB] | Antenna Factor [dB] | AMP [dB] | Level [dBμV/m] | Limit [dBμV/m] | Margin [dB] | Detector | Polarity |
| 1 | 2378.06 | 52.81 | 3.04 | 27.46 | -40.12 | 43.19 | 74.00 | 30.81 | PK | Vertical |
| 2 | 2390.00 | 47.32 | 3.06 | 27.48 | -40.13 | 37.73 | 74.00 | 36.27 | PK | Vertical |

Note:

1. Level = Reading + Cable Loss + Antenna Factor + AMP
2. If Peak Result complies with AV limit, AV Result is deemed to comply with AV limit.
3. Test setup: RBW: 1 MHz, VBW: 3 MHz, Sweep time: auto.

TR-4-E-009 Radiated Emission Test Result

Test Date: 2023-03-09 **Tested By:** Liaowanrong
EUT: 21" POWERED BLUETOOTH SOUNDBAR AUDIO SYSTEM WITH LED LIGHTING **Model Number:** RALLYBAR
Test Mode: TX Mode **Power Supply:** DC 12V
Condition: Temp:23.2°C;Humi:47.2% **Test Site:** DDT 3# Chamber
File Path: d:\ts\2023 report date\Q23022419-2E RALLYBAR\FCC ABOVE 1G\17
Memo: 2DH5 2402

Test Graph

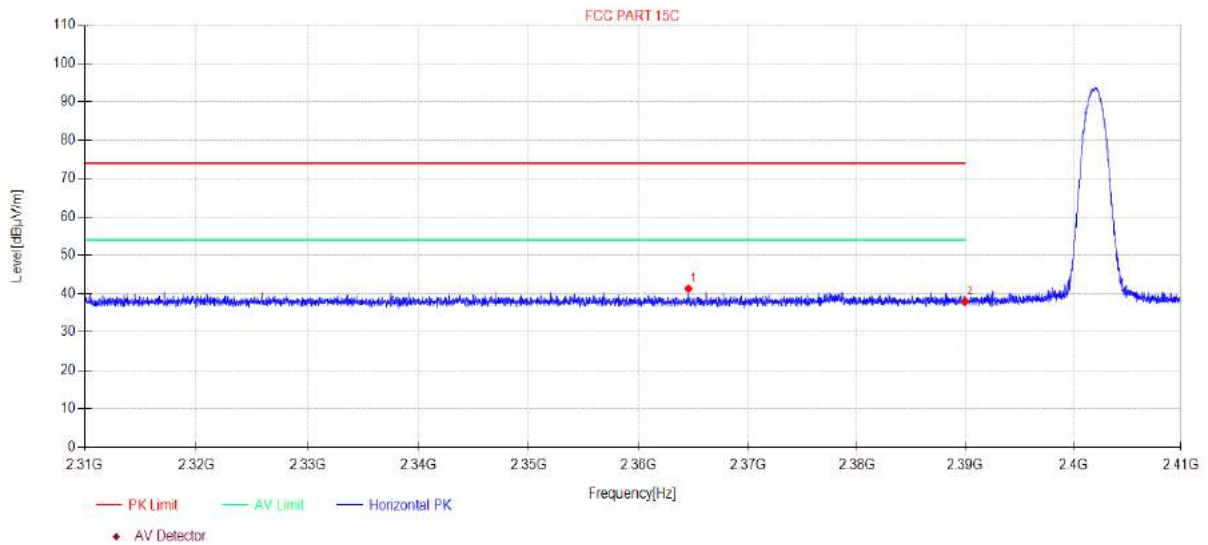

| Suspected Data List | | | | | | | | | | |
|---------------------|-------------|----------------|-----------------|---------------------|----------|----------------|----------------|-------------|----------|------------|
| NO | Freq. [MHz] | Reading [dBµV] | Cable Loss [dB] | Antenna Factor [dB] | AMP [dB] | Level [dBµV/m] | Limit [dBµV/m] | Margin [dB] | Detector | Polarity |
| 1 | 2364.56 | 50.96 | 3.03 | 27.43 | -40.10 | 41.32 | 74.00 | 32.68 | PK | Horizontal |
| 2 | 2390.00 | 47.56 | 3.06 | 27.48 | -40.13 | 37.97 | 74.00 | 36.03 | PK | Horizontal |

Note:

- Level = Reading + Cable Loss + Antenna Factor + AMP
- If Peak Result complies with AV limit, AV Result is deemed to comply with AV limit.
- Test setup: RBW: 1 MHz, VBW: 3 MHz, Sweep time: auto.

TR-4-E-009 Radiated Emission Test Result

Test Date: 2023-03-09 **Tested By:** Liaowanrong
EUT: 21" POWERED BLUETOOTH SOUNDBAR AUDIO SYSTEM WITH LED LIGHTING **Model Number:** RALLYBAR
Test Mode: TX Mode **Power Supply:** DC 12V
Condition: Temp:23.2°C;Humi:47.2% **Test Site:** DDT 3# Chamber
File Path: d:\ts\2023 report date\Q23022419-2E RALLYBAR\FCC ABOVE 1G\18
Memo: 2DH5 2402

Test Graph

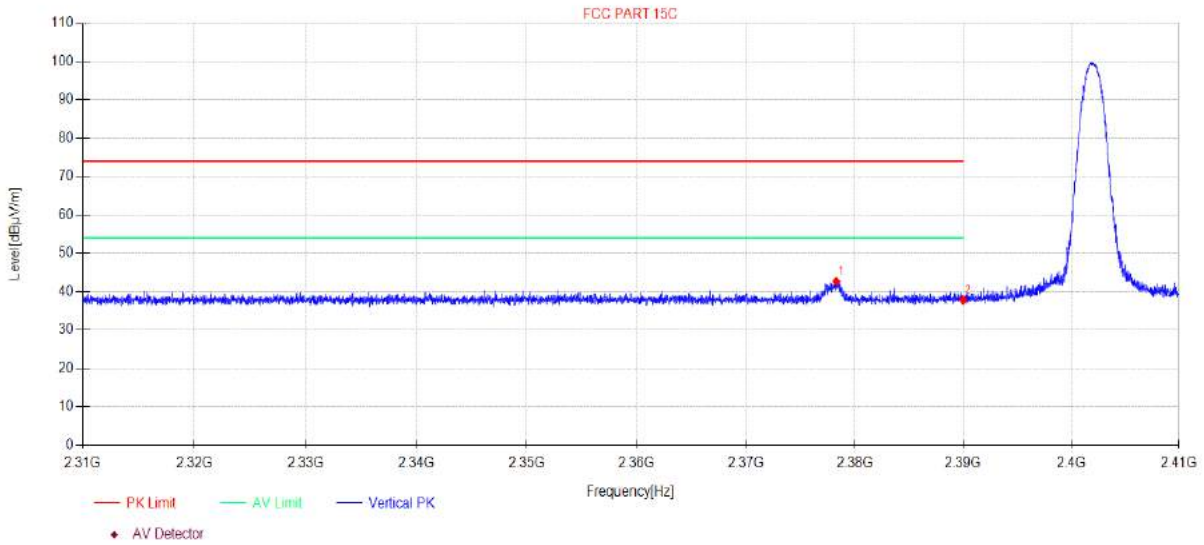

Suspected Data List

| NO | Freq. [MHz] | Reading [dBµV] | Cable Loss [dB] | Antenna Factor [dB] | AMP [dB] | Level [dBµV/m] | Limit [dBµV/m] | Margin [dB] | Detector | Polarity |
|----|-------------|----------------|-----------------|---------------------|----------|----------------|----------------|-------------|----------|----------|
| 1 | 2378.30 | 52.33 | 3.04 | 27.46 | -40.12 | 42.71 | 74.00 | 31.29 | PK | Vertical |
| 2 | 2390.00 | 47.40 | 3.06 | 27.48 | -40.13 | 37.81 | 74.00 | 36.19 | PK | Vertical |

Note:

1. Level = Reading + Cable Loss + Antenna Factor + AMP
2. If Peak Result complies with AV limit, AV Result is deemed to comply with AV limit.
3. Test setup: RBW: 1 MHz, VBW: 3 MHz, Sweep time: auto.

TR-4-E-009 Radiated Emission Test Result

Test Date: 2023-03-09 **Tested By:** Liaowanrong
EUT: 21" POWERED BLUETOOTH SOUNDBAR AUDIO SYSTEM WITH LED LIGHTING **Model Number:** RALLYBAR
Test Mode: TX Mode **Power Supply:** DC 12V
Condition: Temp:23.2°C;Humi:47.2% **Test Site:** DDT 3# Chamber
File Path: d:\ts\2023 report date\Q23022419-2E RALLYBAR\FCC ABOVE 1G\19
Memo: 3DH5 2402

Test Graph

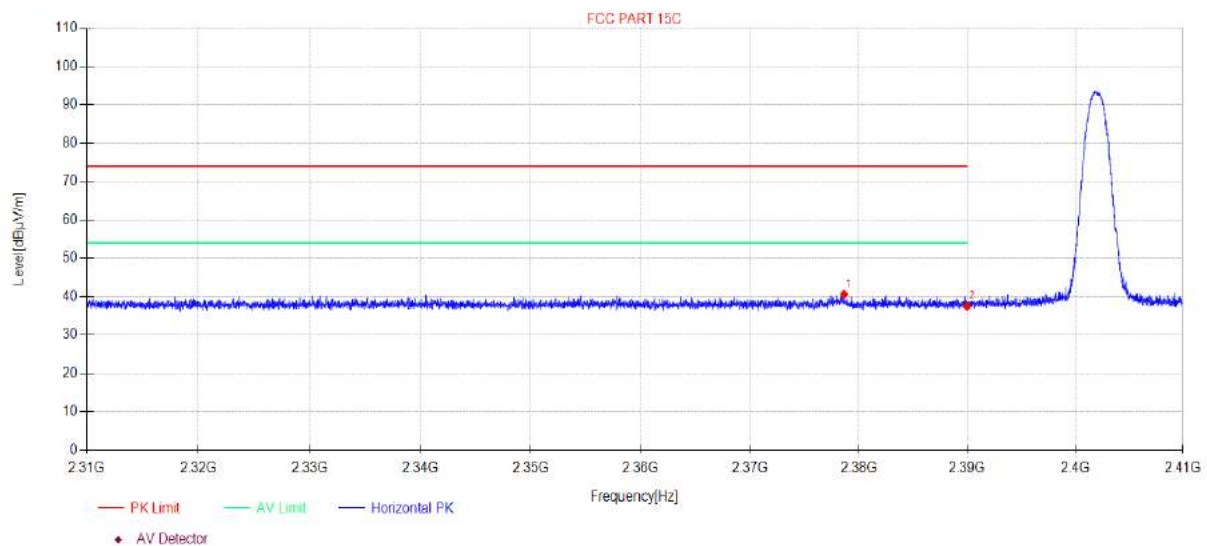

| Suspected Data List | | | | | | | | | | |
|---------------------|-------------|----------------|-----------------|---------------------|----------|----------------|----------------|-------------|----------|------------|
| NO | Freq. [MHz] | Reading [dBμV] | Cable Loss [dB] | Antenna Factor [dB] | AMP [dB] | Level [dBμV/m] | Limit [dBμV/m] | Margin [dB] | Detector | Polarity |
| 1 | 2378.64 | 50.24 | 3.04 | 27.46 | -40.12 | 40.62 | 74.00 | 33.38 | PK | Horizontal |
| 2 | 2390.00 | 47.10 | 3.06 | 27.48 | -40.13 | 37.51 | 74.00 | 36.49 | PK | Horizontal |

Note:

1. Level = Reading + Cable Loss + Antenna Factor + AMP
2. If Peak Result complies with AV limit, AV Result is deemed to comply with AV limit.
3. Test setup: RBW: 1 MHz, VBW: 3 MHz, Sweep time: auto.

TR-4-E-009 Radiated Emission Test Result

Test Date: 2023-03-09 **Tested By:** Liaowanrong
EUT: 21" POWERED BLUETOOTH SOUNDBAR AUDIO SYSTEM WITH LED LIGHTING **Model Number:** RALLYBAR
Test Mode: TX Mode **Power Supply:** DC 12V
Condition: Temp:23.2°C;Humi:47.2% **Test Site:** DDT 3# Chamber
File Path: d:\ts\2023 report date\Q23022419-2E RALLYBAR\FCC ABOVE 1G\20
Memo: 3DH5 2402

Test Graph

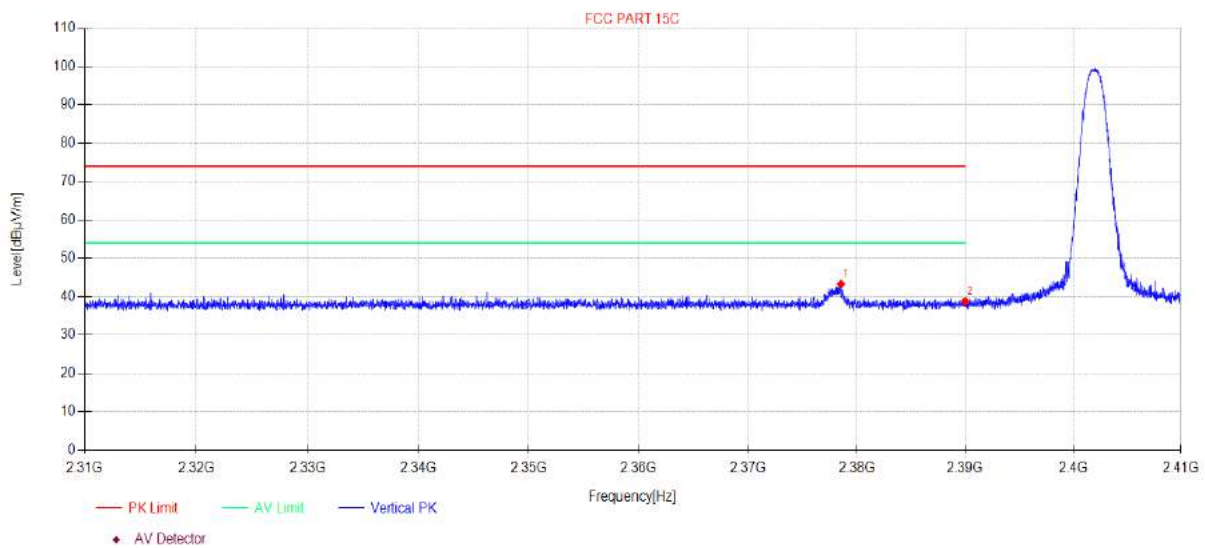

Suspected Data List

| NO | Freq. [MHz] | Reading [dBμV] | Cable Loss [dB] | Antenna Factor [dB] | AMP [dB] | Level [dBμV/m] | Limit [dBμV/m] | Margin [dB] | Detector | Polarity |
|----|-------------|----------------|-----------------|---------------------|----------|----------------|----------------|-------------|----------|----------|
| 1 | 2378.54 | 52.93 | 3.04 | 27.46 | -40.12 | 43.31 | 74.00 | 30.69 | PK | Vertical |
| 2 | 2390.00 | 48.35 | 3.06 | 27.48 | -40.13 | 38.76 | 74.00 | 35.24 | PK | Vertical |

Note:

1. Level = Reading + Cable Loss + Antenna Factor + AMP
2. If Peak Result complies with AV limit, AV Result is deemed to comply with AV limit.
3. Test setup: RBW: 1 MHz, VBW: 3 MHz, Sweep time: auto.

TR-4-E-009 Radiated Emission Test Result

Test Date: 2023-03-09 **Tested By:** Liaowanrong
EUT: 21" POWERED BLUETOOTH SOUNDBAR AUDIO SYSTEM WITH LED LIGHTING **Model Number:** RALLYBAR
Test Mode: TX Mode **Power Supply:** DC 12V
Condition: Temp:23.2°C;Humi:47.2% **Test Site:** DDT 3# Chamber
File Path: d:\ts\2023 report date\Q23022419-2E RALLYBAR\FCC ABOVE 1G\11
Memo: DH5 2480

Test Graph

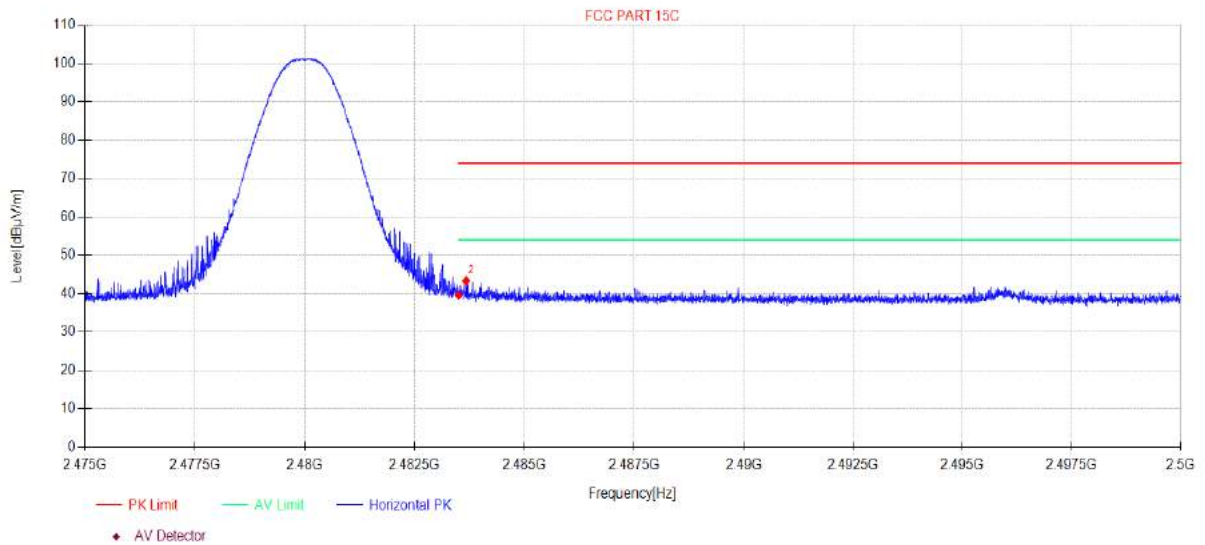

| Suspected Data List | | | | | | | | | | |
|---------------------|-------------|----------------|-----------------|---------------------|----------|----------------|----------------|-------------|----------|------------|
| NO | Freq. [MHz] | Reading [dBµV] | Cable Loss [dB] | Antenna Factor [dB] | AMP [dB] | Level [dBµV/m] | Limit [dBµV/m] | Margin [dB] | Detector | Polarity |
| 1 | 2483.50 | 48.96 | 3.15 | 27.73 | -40.23 | 39.61 | 74.00 | 34.39 | PK | Horizontal |
| 2 | 2483.68 | 52.76 | 3.15 | 27.73 | -40.23 | 43.41 | 74.00 | 30.59 | PK | Horizontal |

Note:

1. Level = Reading + Cable Loss + Antenna Factor + AMP
2. If Peak Result complies with AV limit, AV Result is deemed to comply with AV limit.
3. Test setup: RBW: 1 MHz, VBW: 3 MHz, Sweep time: auto.

TR-4-E-009 Radiated Emission Test Result

Test Date: 2023-03-09 **Tested By:** Liaowanrong
EUT: 21" POWERED BLUETOOTH SOUNDBAR AUDIO SYSTEM WITH LED LIGHTING **Model Number:** RALLYBAR
Test Mode: TX Mode **Power Supply:** DC 12V
Condition: Temp:23.2°C;Humi:47.2% **Test Site:** DDT 3# Chamber
File Path: d:\ts\2023 report date\Q23022419-2E RALLYBAR\FCC ABOVE 1G\12
Memo: DH5 2480

Test Graph

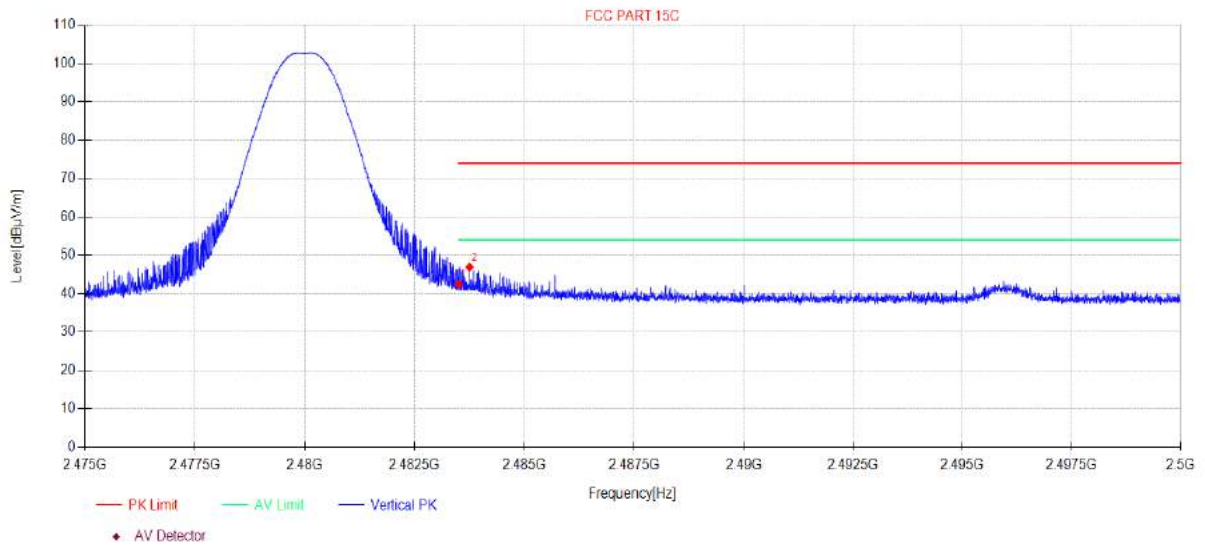

| Suspected Data List | | | | | | | | | | |
|---------------------|-------------|----------------|-----------------|---------------------|----------|----------------|----------------|-------------|----------|----------|
| NO | Freq. [MHz] | Reading [dBµV] | Cable Loss [dB] | Antenna Factor [dB] | AMP [dB] | Level [dBµV/m] | Limit [dBµV/m] | Margin [dB] | Detector | Polarity |
| 1 | 2483.50 | 51.84 | 3.15 | 27.73 | -40.23 | 42.49 | 74.00 | 31.51 | PK | Vertical |
| 2 | 2483.75 | 56.24 | 3.15 | 27.74 | -40.23 | 46.90 | 74.00 | 27.10 | PK | Vertical |

Note:

1. Level = Reading + Cable Loss + Antenna Factor + AMP
2. If Peak Result complies with AV limit, AV Result is deemed to comply with AV limit.
3. Test setup: RBW: 1 MHz, VBW: 3 MHz, Sweep time: auto.

TR-4-E-009 Radiated Emission Test Result

Test Date: 2023-03-09 **Tested By:** Liaowanrong
EUT: 21" POWERED BLUETOOTH SOUNDBAR AUDIO SYSTEM WITH LED LIGHTING **Model Number:** RALLYBAR
Test Mode: TX Mode **Power Supply:** DC 12V
Condition: Temp:23.2°C;Humi:47.2% **Test Site:** DDT 3# Chamber
File Path: d:\ts\2023 report date\Q23022419-2E RALLYBAR\FCC ABOVE 1G\21
Memo: 2DH5 2480

Test Graph

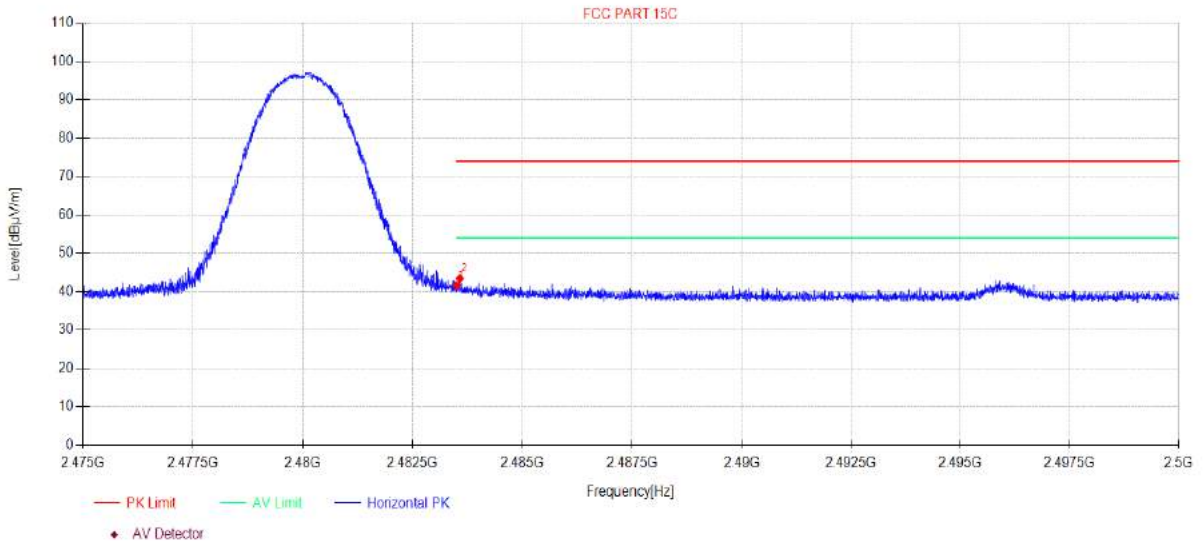

| Suspected Data List | | | | | | | | | | |
|---------------------|-------------|----------------|-----------------|---------------------|----------|----------------|----------------|-------------|----------|------------|
| NO | Freq. [MHz] | Reading [dBµV] | Cable Loss [dB] | Antenna Factor [dB] | AMP [dB] | Level [dBµV/m] | Limit [dBµV/m] | Margin [dB] | Detector | Polarity |
| 1 | 2483.50 | 51.00 | 3.15 | 27.73 | -40.23 | 41.65 | 74.00 | 32.35 | PK | Horizontal |
| 2 | 2483.58 | 52.84 | 3.15 | 27.73 | -40.23 | 43.49 | 74.00 | 30.51 | PK | Horizontal |

Note:

1. Level = Reading + Cable Loss + Antenna Factor + AMP
2. If Peak Result complies with AV limit, AV Result is deemed to comply with AV limit.
3. Test setup: RBW: 1 MHz, VBW: 3 MHz, Sweep time: auto.

TR-4-E-009 Radiated Emission Test Result

Test Date: 2023-03-09 **Tested By:** Liaowanrong
EUT: 21" POWERED BLUETOOTH SOUNDBAR AUDIO SYSTEM WITH LED LIGHTING **Model Number:** RALLYBAR
Test Mode: TX Mode **Power Supply:** DC 12V
Condition: Temp:23.2°C;Humi:47.2% **Test Site:** DDT 3# Chamber
File Path: d:\ts\2023 report date\Q23022419-2E RALLYBAR\FCC ABOVE 1G\2
Memo: 2DH5 2480

Test Graph

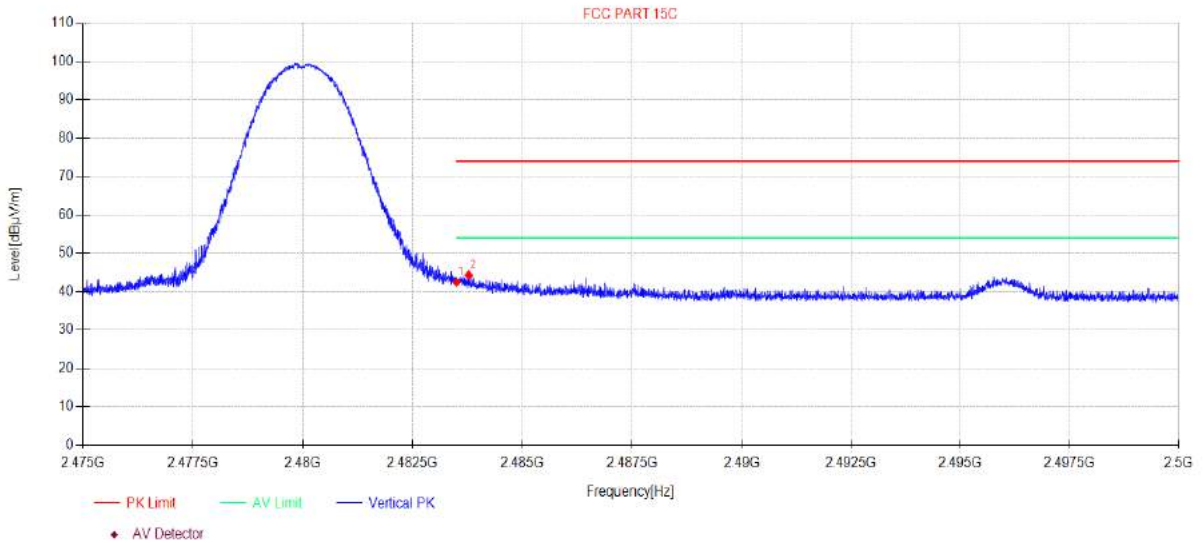

| Suspected Data List | | | | | | | | | | |
|---------------------|-------------|----------------|-----------------|---------------------|----------|----------------|----------------|-------------|----------|----------|
| NO | Freq. [MHz] | Reading [dBµV] | Cable Loss [dB] | Antenna Factor [dB] | AMP [dB] | Level [dBµV/m] | Limit [dBµV/m] | Margin [dB] | Detector | Polarity |
| 1 | 2483.50 | 51.84 | 3.15 | 27.73 | -40.23 | 42.49 | 74.00 | 31.51 | PK | Vertical |
| 2 | 2483.78 | 53.67 | 3.15 | 27.74 | -40.23 | 44.33 | 74.00 | 29.67 | PK | Vertical |

Note:

1. Level = Reading + Cable Loss + Antenna Factor + AMP
2. If Peak Result complies with AV limit, AV Result is deemed to comply with AV limit.
3. Test setup: RBW: 1 MHz, VBW: 3 MHz, Sweep time: auto.

TR-4-E-009 Radiated Emission Test Result

Test Date: 2023-03-09 **Tested By:** Liaowanrong
EUT: 21" POWERED BLUETOOTH SOUNDBAR AUDIO SYSTEM WITH LED LIGHTING **Model Number:** RALLYBAR
Test Mode: TX Mode **Power Supply:** DC 12V
Condition: Temp:23.2°C;Humi:47.2% **Test Site:** DDT 3# Chamber
File Path: d:\ts\2023 report date\Q23022419-2E RALLYBAR\FCC ABOVE 1G\23
Memo: 3DH5 2480

Test Graph

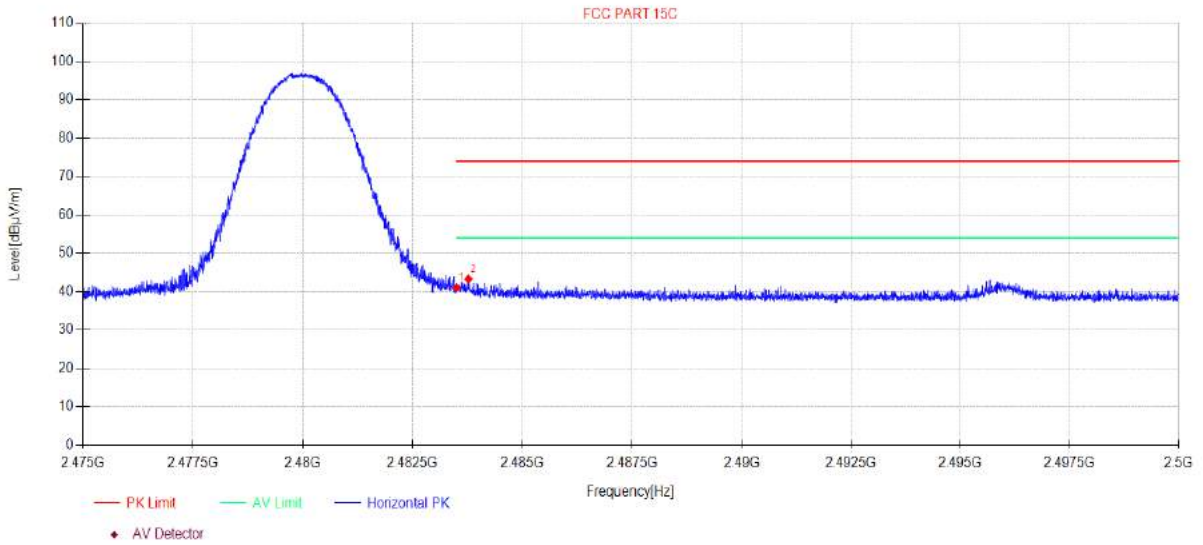

| Suspected Data List | | | | | | | | | | |
|---------------------|-------------|----------------|-----------------|---------------------|----------|----------------|----------------|-------------|----------|------------|
| NO | Freq. [MHz] | Reading [dBµV] | Cable Loss [dB] | Antenna Factor [dB] | AMP [dB] | Level [dBµV/m] | Limit [dBµV/m] | Margin [dB] | Detector | Polarity |
| 1 | 2483.50 | 50.40 | 3.15 | 27.73 | -40.23 | 41.05 | 74.00 | 32.95 | PK | Horizontal |
| 2 | 2483.77 | 52.68 | 3.15 | 27.74 | -40.23 | 43.34 | 74.00 | 30.66 | PK | Horizontal |

Note:

1. Level = Reading + Cable Loss + Antenna Factor + AMP
2. If Peak Result complies with AV limit, AV Result is deemed to comply with AV limit.
3. Test setup: RBW: 1 MHz, VBW: 3 MHz, Sweep time: auto.

TR-4-E-009 Radiated Emission Test Result

Test Date: 2023-03-09 **Tested By:** Liaowanrong
EUT: 21" POWERED BLUETOOTH SOUNDBAR AUDIO SYSTEM WITH LED LIGHTING **Model Number:** RALLYBAR
Test Mode: TX Mode **Power Supply:** DC 12V
Condition: Temp:23.2°C;Humi:47.2% **Test Site:** DDT 3# Chamber
File Path: d:\ts\2023 report date\Q23022419-2E RALLYBAR\FCC ABOVE 1G\24
Memo: 3DH5 2480

Test Graph

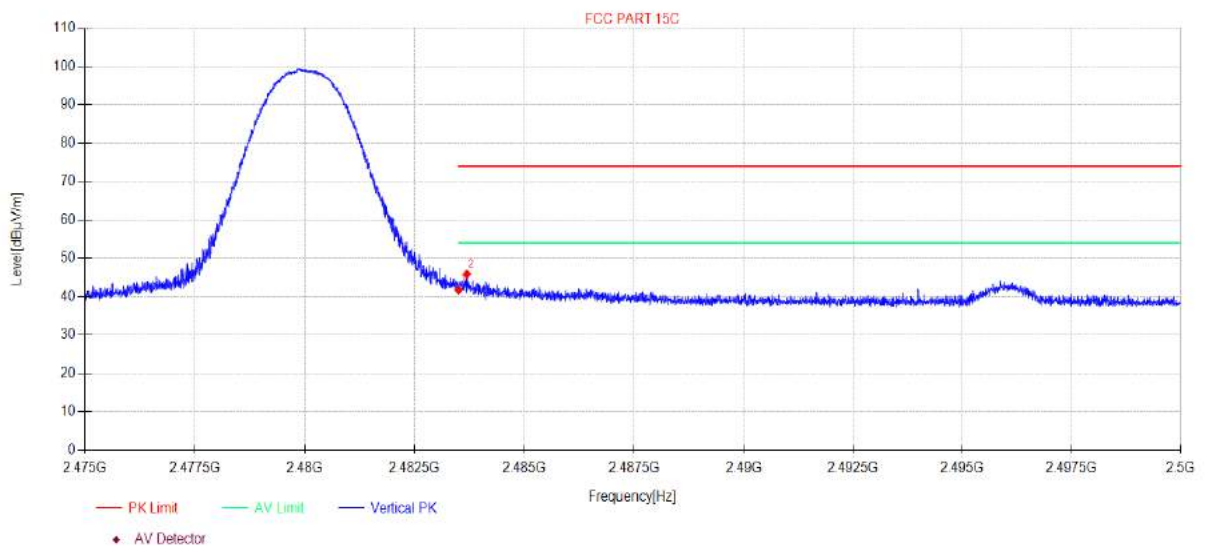

| Suspected Data List | | | | | | | | | | |
|---------------------|-------------|----------------|-----------------|---------------------|----------|----------------|----------------|-------------|----------|----------|
| NO | Freq. [MHz] | Reading [dBµV] | Cable Loss [dB] | Antenna Factor [dB] | AMP [dB] | Level [dBµV/m] | Limit [dBµV/m] | Margin [dB] | Detector | Polarity |
| 1 | 2483.50 | 51.09 | 3.15 | 27.73 | -40.23 | 41.74 | 74.00 | 32.26 | PK | Vertical |
| 2 | 2483.69 | 55.21 | 3.15 | 27.73 | -40.23 | 45.86 | 74.00 | 28.14 | PK | Vertical |

Note:

1. Level = Reading + Cable Loss + Antenna Factor + AMP
2. If Peak Result complies with AV limit, AV Result is deemed to comply with AV limit.
3. Test setup: RBW: 1 MHz, VBW: 3 MHz, Sweep time: auto.

15. Power Line Conducted Emission

15.1. Block diagram of test setup

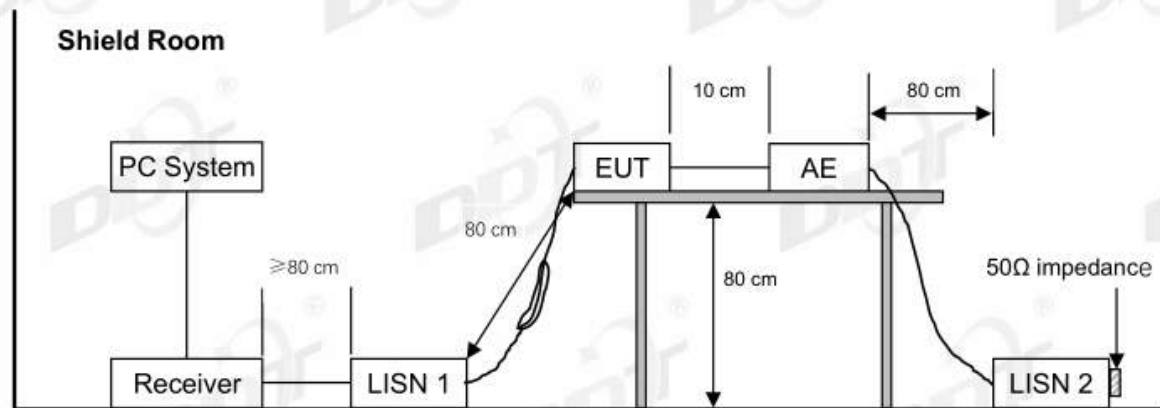

15.2. Power line conducted emission limits

| Frequency | Quasi-Peak Level dB(μ V) | Average Level dB(μ V) |
|-------------------|----------------------------------|-------------------------------|
| 150 kHz ~ 500 kHz | 66 ~ 56* | 56 ~ 46* |
| 500 kHz ~ 5 MHz | 56 | 46 |
| 5 MHz ~ 30 MHz | 60 | 50 |

Note 1: * Decreasing linearly with logarithm of frequency.

Note 2: The lower limit shall apply at the transition frequencies.

15.3. Test procedure

The EUT and Support equipment, if needed, were put placed on a non-metallic table, 80cm above the ground plane.

All support equipment power received from a second LISN.

Emissions were measured on each current carrying line of the EUT using an EMI Test Receiver connected to the LISN powering the EUT.

The Receiver scanned from 150 kHz to 30 MHz for emissions in each of the test modes.

During the above scans, the emissions were maximized by cable manipulation.

The test mode(s) described in clause 2.4 were scanned during the preliminary test.

After the preliminary scan, we found the test mode producing the highest emission level.

The EUT configuration and worse cable configuration of the above highest emission levels were recorded for reference of the final test.

EUT and support equipment were set up on the test bench as per the configuration with highest emission level in the preliminary test.

A scan was taken on both power lines, Neutral and Line, recording at least the six highest

emissions.

Emission frequency and amplitude were recorded into a computer in which correction factors were used to calculate the emission level and compare reading to the applicable limit.

The test data of the worst-case condition(s) was recorded.

The bandwidth of test receiver is set at 9 kHz.

15.4. Test result

N/A.

The EUT is powered by DC.

16. Antenna Requirements

16.1. Limit

For intentional device, according to FCC 47 CFR Section 15.203, an intentional radiator shall be designed to ensure that no antenna other than that furnished by the responsible party shall be used with the device. And according to FCC 47 CFR Section 15.247 (b), if transmitting antennas of directional gain greater than 6 dBi are used, the power shall be reduced by the amount in dB that the directional gain of the antenna exceeds 6 dBi.

For intentional device, according to RSS-Gen issue 5 section 6.8.

The applicant for equipment certification shall provide a list of all antenna types that may be used with the transmitter, where applicable (i.e. for transmitters with detachable antenna), indicating the maximum permissible antenna gain (in dBi) and the required impedance for each antenna. The test report shall demonstrate the compliance of the transmitter with the limit for maximum equivalent isotropically radiated power (e.i.r.p.) specified in the applicable RSS, when the transmitter is equipped with any antenna type, selected from this list.

16.2. Result

The antenna used for this product is FPC antenna and that no antenna other than that furnished by the responsible party shall be used with the device, the maximum peak gain of the transmit antenna is 2.36 dBi.

18. Photos of the EUT

Please refer to appendix I.

END OF REPORT