

FCC AND IC CERTIFICATION TEST REPORT

FOR

Applicant	:	Harman International Industries, Inc.
Address	:	8500 Balboa Boulevard, Northridge, CA 91329, UNITED STATES
Equipment under Test	:	USB Wireless Dongle
Model No.	:	QUANTUM800TM
Trade Mark	:	JBL
FCC ID	:	APIJBLQ800TM
IC	:	6132A-JBLQ800TM
Manufacturer	:	Harman International Industries, Inc.
Address	:	8500 Balboa Boulevard, Northridge, CA 91329, UNITED STATES

Issued By: Dongguan Dongdian Testing Service Co., Ltd.

Add: No. 17, Zongbu Road 2, Songshan Lake Sci&Tech, Industry Park, Dongguan
City, Guangdong Province, China, 523808

Tel: +86-0769-38826678, **E-mail:** ddt@dgddt.com, <http://www.dgddt.com>

TABLE OF CONTENTS

Test report	
declares.....	4
1. Summary of test results	6
2. General test information	7
2.1. Description of EUT.....	7
2.2. Accessories of EUT	7
2.3. Assistant equipment used for test.....	7
2.4. Block diagram of EUT configuration for test	8
2.5. Test environment conditions	8
2.6. Deviations of test standard	8
2.7. Test laboratory.....	8
2.8. Measurement uncertainty	9
3. Equipment used during test	10
4. 20dB Bandwidth and 99% Bandwidth.....	11
4.1. Block diagram of test setup	11
4.2. Limits	11
4.3. Test Procedure	11
4.4. Test Result	11
4.5. Original test data.....	12
5. Radiated emission	16
5.1. Block diagram of test setup	16
5.2. Limit.....	17
5.3. Test Procedure	18
5.4. Test result.....	19
6. Band Edge Compliance	24
6.1. Block diagram of test setup	24
6.2. Limit.....	24
6.3. Test Procedure	24
6.4. Test result.....	24
7. Power Line Conducted Emission	33
7.1. Block diagram of test setup	33
7.2. Power Line Conducted Emission Limits.....	33
7.3. Test Procedure	33
7.4. Test Result	34
8. Antenna Requirements	35
8.1. Limit.....	35
8.2. Result	35



TEST REPORT DECLARE

Applicant	:	Harman International Industries, Inc.
Address	:	8500 Balboa Boulevard, Northridge, CA 91329, UNITED STATES
Equipment under Test	:	USB Wireless Dongle
Model No.	:	QUANTUM800TM
Trade mark	:	JBL
Manufacturer	:	Harman International Industries, Inc.
Address	:	8500 Balboa Boulevard, Northridge, CA 91329, UNITED STATES

Test Standard Used:

FCC Rules and Regulations Part 15 Subpart C, RSS-210 Issue 9 August 2016.

Test procedure used:

ANSI C63.10:2013, RSS-Gen Issue 5, Apr. 2018.

We Declare:

The equipment described above is tested by Dongguan Dongdian Testing Service Co., Ltd. and in the configuration tested the equipment complied with the standards specified above. The test results are contained in this test report and Dongguan Dongdian Testing Service Co., Ltd. is assumed of full responsibility for the accuracy and completeness of these tests.

After test and evaluation, our opinion is that the equipment provided for test compliance with the requirement of the above FCC&IC standards.

Report No:	DDT-R19092705-1E7		
Date of Receipt:	Oct. 10, 2019	Date of Test:	Oct. 10, 2019 ~ Nov. 01, 2019

Prepared By:

Sam Li

Sam Li/Engineer

Approved By:



Damon Hu/EMC Manager

Note: This report applies to above tested sample only. This report shall not be reproduced in parts without written approval of Dongguan Dongdian Testing Service Co., Ltd.

Revision history

Rev.	Revisions	Issue Date	Revised By
---	Initial issue	Nov. 01, 2019	

1. Summary of test results

The EUT have been tested according to the applicable standards as referenced below.		
Description of Test Item	Standard	Results
20dB Bandwidth and 99% Bandwidth	FCC Part 15: 15.215 ANSI C63.10:2013 RSS-210 Issue 9 RSS-Gen Issue 5	PASS
Radiated Emission	FCC Part 15: 15.209 FCC Part 15: 15.249 ANSI C63.10:2013 RSS-210 Issue 9 RSS-Gen Issue 5	PASS
Band Edge Compliance	FCC Part 15: 15.205 FCC Part 15: 15.249 ANSI C63.10:2013 RSS-210 Issue 9 RSS-Gen Issue 5	PASS
Power Line Conducted Emission	FCC Part 15: 15.207 ANSI C63.10:2013 RSS-Gen Issue 5	N/A
Antenna requirement	FCC Part 15: 15.203 RSS-Gen Issue 5	PASS

Note: N/A is an abbreviation for Not Applicable.

2. General test information

2.1. Description of EUT

EUT* Name	: USB Wireless Dongle
Model Number	: QUANTUM800TM
EUT function description	: Please reference user manual of this device
Power supply	: DC 5V
Operation frequency	: 2403.35MHz-2479.35MHz
Modulation	: $\pi/4$ -DQPSK
Antenna Type	: Antenna 1: Dedicated FPC antenna, maximum PK gain: 0.88 dBi Antenna 2: Dedicated FPC antenna, maximum PK gain: 0.88 dBi
Sample Type	: Series production

Note: EUT is the ab. of equipment under test.

EUT channels and frequencies list:

Channel information					
Channel	Frequency (MHz)	Channel	Frequency (MHz)	Channel	Frequency (MHz)
1	2403.35	14	2429.35	27	2455.35
2	2405.35	15	2431.35	28	2457.35
3	2407.35	16	2433.35	29	2459.35
4	2409.35	17	2435.35	30	2461.35
5	2411.35	18	2437.35	31	2463.35
6	2413.35	19	2439.35	32	2465.35
7	2415.35	20	2441.35	33	2467.35
8	2417.35	21	2443.35	34	2469.35
9	2419.35	22	2445.35	35	2471.35
10	2421.35	23	2447.35	36	2473.35
11	2423.35	24	2449.35	37	2475.35
12	2425.35	25	2451.35	38	2477.35
13	2427.35	26	2453.35	39	2479.35

2.2. Accessories of EUT

Description of Accessories	Manufacturer	Model number	Description	Remark
Type C cable	Harman	N/A	Length: 156cm, unshielded	N/A
AUX cable	Harman	N/A	Length: 139cm, unshielded	N/A

2.3. Assistant equipment used for test

Assistant equipment	Manufacturer	Model number	EMC Compliance	SN
Notebook	Lenovo Beijing Co. Ltd.	ThinkPad	FCC/CE	TP00015A

2.4. Block diagram of EUT configuration for test

Tx Mode:

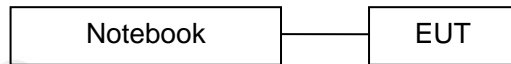

Test software: VMldebug-1.1.6.56.exe

The test software was used to control EUT work in Continuous Tx mode, and select test channel, wireless mode as below table.

Tested mode, channel, information			
Mode	Channel	Setting Tx Power	Frequency (MHz)
$\pi/4$ -DQPSK Tx mode	CH 1	0x1A	2403.35
	CH 20	0x1A	2441.35
	CH 39	0x1A	2479.35

2.5. Test environment conditions

During the measurement the environmental conditions were within the listed ranges:

Temperature range:	21-25°C
Humidity range:	40-75%
Pressure range:	86-106kPa

2.6. Deviations of test standard

No Deviation.

2.7. Test laboratory

Dongguan Dongdian Testing Service Co., Ltd

Add: No. 17, Zongbu Road 2, Songshan Lake Sci&Tech, Industry Park, Dongguan City, Guangdong Province, China, 523808

Tel: +86-0769-38826678, <http://www.dgddt.com>, Email: ddt@dgddt.com

CNAS Accreditation No. L6451; A2LA Accreditation No. 3870.01

Designation Number: CN1182; Test Firm Registration Number: 540522

Industry Canada site registration number: 10288A-1

2.8. Measurement uncertainty

Test Item	Uncertainty
Bandwidth	1.1%
Peak Output Power (Conducted) (Spectrum analyzer)	0.86dB (10MHz ≤ f < 3.6GHz);
	1.38dB (3.6GHz ≤ f < 8GHz)
Peak Output Power (Conducted) (Power Sensor)	0.74dB
Power Spectral Density	0.74dB (10MHz ≤ f < 3.6GHz);
	1.38dB (3.6GHz ≤ f < 8GHz)
Conducted spurious emissions	0.86dB (10MHz ≤ f < 3.6GHz);
	1.40dB (3.6GHz ≤ f < 8GHz)
	1.66dB (8GHz ≤ f < 22GHz)
Uncertainty for radio frequency (RBW<20kHz)	3×10^{-8}
Temperature	0.4℃
Humidity	2%
Uncertainty for Radiation Emission test (30MHz-1GHz)	4.70dB (Antenna Polarize: V)
	4.84dB (Antenna Polarize: H)
Uncertainty for Radiation Emission test (1GHz-18GHz)	4.10dB (1-6GHz)
	4.40dB (6GHz-18GHz)
Uncertainty for Power line conduction emission test	3.32dB (150kHz-30MHz)

Note: This uncertainty represents an expanded uncertainty expressed at approximately the 95% confidence level using a coverage factor of k=2.

3. Equipment used during test

Equipment	Manufacturer	Model No.	Serial No.	Last Cal.	Cal. Interval
RF Connected Test (Tonscend RF Measurement System)					
Spectrum analyzer	R&S	FSU26	200071	Sep. 29, 2019	1 Year
Wideband Radio Communication tester	R&S	CMW500	117491	Jun. 25, 2019	1 Year
Vector Signal Generator	Agilent	E8267D	US49060192	Sep. 29, 2019	1 Year
Vector Signal Generator	Agilent	N5182A	MY48180737	Jun. 25, 2019	1 Year
Power Sensor	Agilent	U2021XA	MY55150010	Jun. 28, 2019	1 Year
Power Sensor	Agilent	U2021XA	MY55150011	Jun. 28, 2019	1 Year
DC Power Source	MATRIS	MPS-3005L-3	D813058W	Jun. 25, 2019	1 Year
RF Cable	Micable	C10-01-01-1	100309	Sep. 29, 2019	1 Year
Temp&Humi Programmable	ZHIXIANG	ZXGDJS-150L	ZX170110-A	Sep. 29, 2019	1 Year
Test Software	JS Tonscend	JS1120-3	Ver.2.7	N/A	N/A
Radiation 1#chamber					
EMI Test Receiver	R&S	ESU8	100316	Sep. 29, 2019	1 Year
Spectrum analyzer	Agilent	E4447A	MY50180031	Jun. 25, 2019	1 Year
Trilog Broadband Antenna	Schwarzbeck	VULB9163	9163-462	Nov. 09, 2018	1 Year
Active Loop antenna	Schwarzbeck	FMZB-1519	1519-038	Sep. 29, 2019	1 Year
Double Ridged Horn Antenna	R&S	HF907	100276	Nov. 16, 2018	1 Year
Broad Band Horn Antenna	Schwarzbeck	BBHA 9170	790	Sep. 29, 2019	1 Year
Pre-amplifier	A.H.	PAM-0118	360	Sep. 29, 2019	1 Year
Pre-amplifier	TERA-MW	TRLA-0040 G35	101303	Sep. 29, 2019	1 Year
RF Cable	HUBSER	CP-X2+ CP-X1	W11.03+ W12.02	Sep. 29, 2019	1 Year
RF Cable	N/A	SMAJ-SMA J-1M+ 11M	17070133+17070131	Sep. 29, 2019	1 Year
MI Cable	HUBSER	C10-01-01-1 M	1091629	Sep. 29, 2019	1 Year
Test software	Audix	E3	V 6.11111b	N/A	N/A
Power Line Conducted Emissions Test					
EMI Test Receiver	R&S	ESU8	100316	Sep. 29, 2019	1 Year
LISN 1	R&S	ENV216	101109	Sep. 29, 2019	1 Year
LISN 2	R&S	ESH2-Z5	100309	Sep. 29, 2019	1 Year
Pulse Limiter	R&S	ESH3-Z2	101242	Sep. 29, 2019	1 Year
CE Cable 1	HUBSER	N/A	W10.01	Sep. 29, 2019	1 Year
Test software	Audix	E3	V 6.11111b	N/A	N/A

4. 20dB Bandwidth and 99% Bandwidth

4.1. Block diagram of test setup

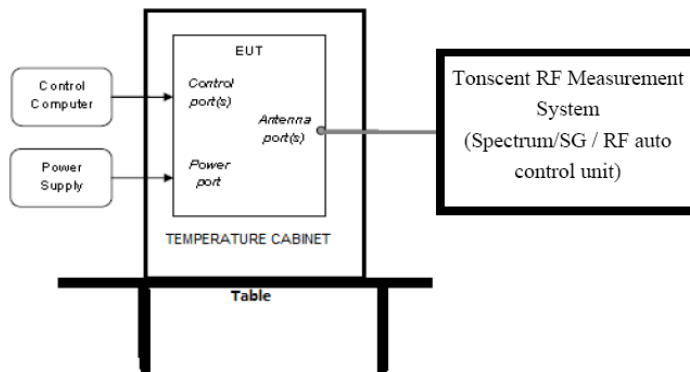

4.2. Limits

Intentional radiators operating under the alternative provisions to the general emission limits, as contained in § 15.217 through 15.257 and in Subpart E of this part, must be designed to ensure that the 20dB bandwidth of the emission, or whatever bandwidth may otherwise be specified in the specific rule section under which the equipment operates, is contained within the frequency band designated in the rule section under which the equipment is operated.

4.3. Test Procedure

- (1) Connect EUT's antenna output to spectrum analyzer by RF cable.
- (2) Set the spectrum analyzer as follows:

RBW:	30kHz
VBW:	100kHz
Detector Mode:	Peak
Sweep time:	auto
Trace mode	Max hold
- (3) Allow the trace to stabilize, measure the 20dB and 99% bandwidth of signal.

4.4. Test Result

Test Mode	Freq. (MHz)	Antenna	99% bandwidth Result (MHz)	20dB bandwidth Result (MHz)	Conclusion
$\pi/4$ -DQPSK	2403.35	Ant1	1.910	2.163	PASS
	2403.35	Ant2	1.897	2.163	PASS
	2441.35	Ant1	1.910	2.147	PASS
	2441.35	Ant2	1.910	2.179	PASS
	2479.35	Ant1	1.910	2.179	PASS
	2479.35	Ant2	1.897	2.179	PASS

4.5. Original test data

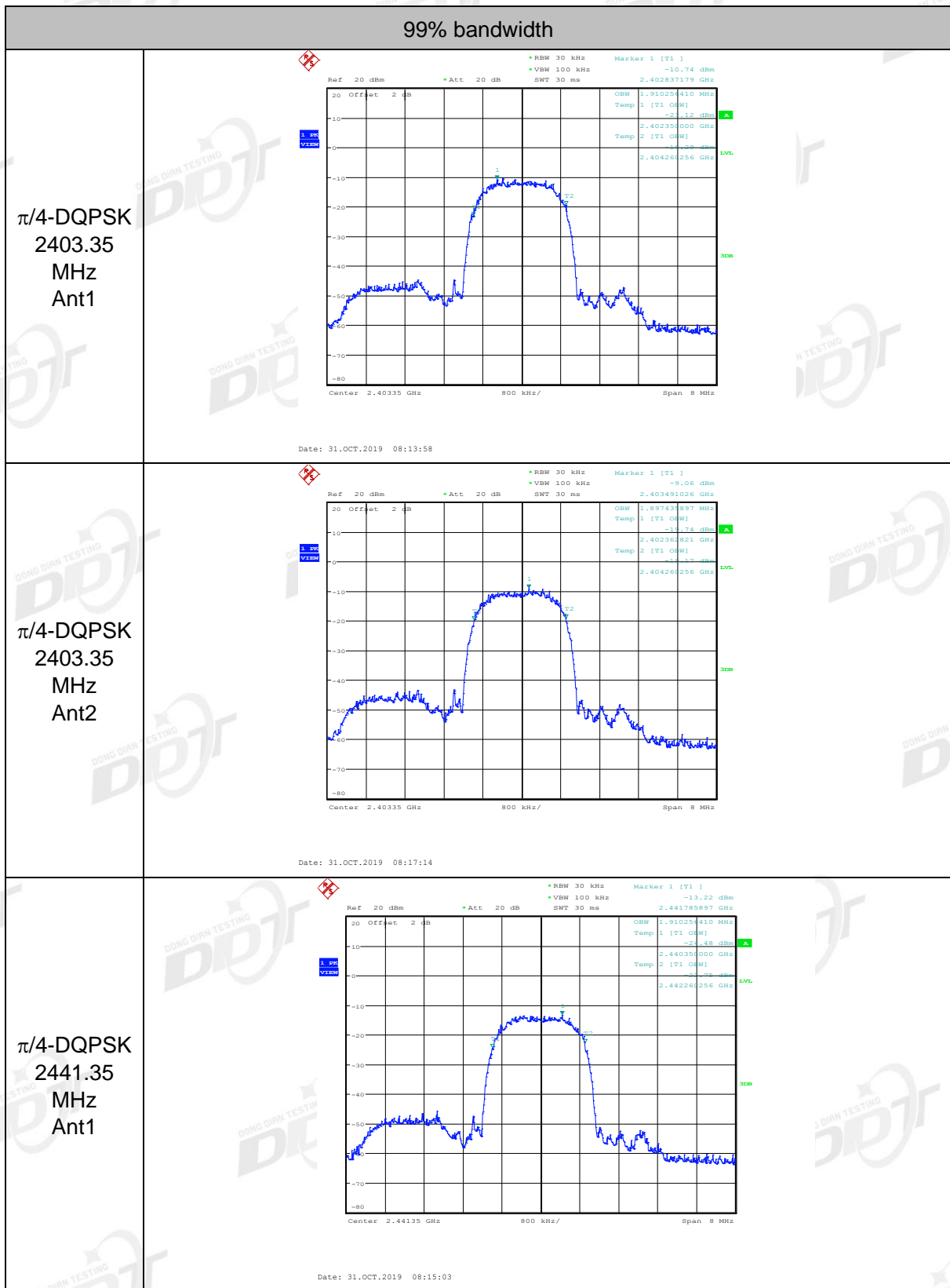

$\pi/4$ -DQPSK
2441.35
MHz
Ant2

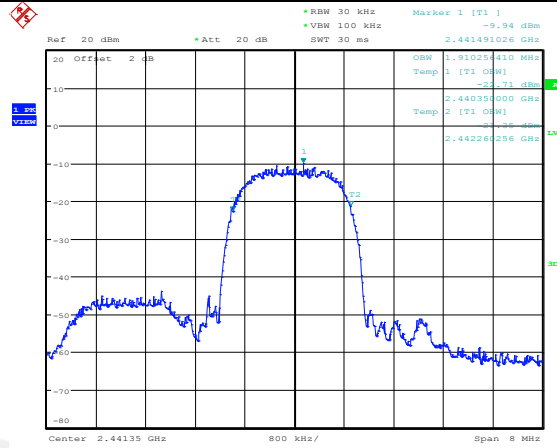

Date: 31.OCT.2019 08:16:45

$\pi/4$ -DQPSK
2479.35
MHz
Ant1

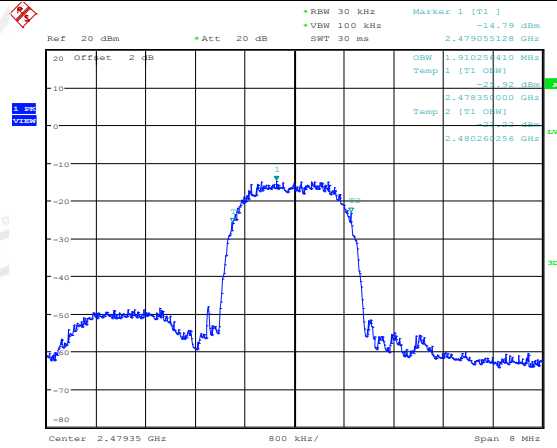

Date: 31.OCT.2019 08:15:40

$\pi/4$ -DQPSK
2479.35
MHz
Ant2

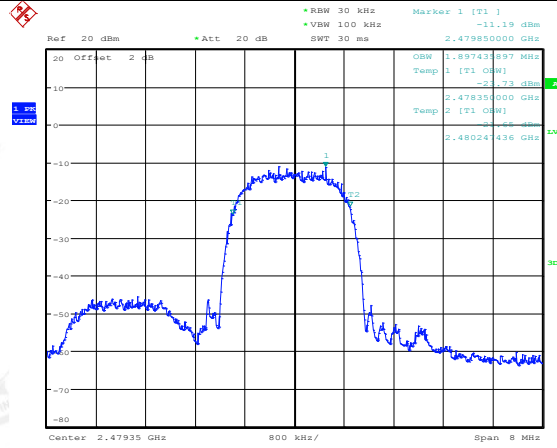

Date: 31.OCT.2019 08:16:18

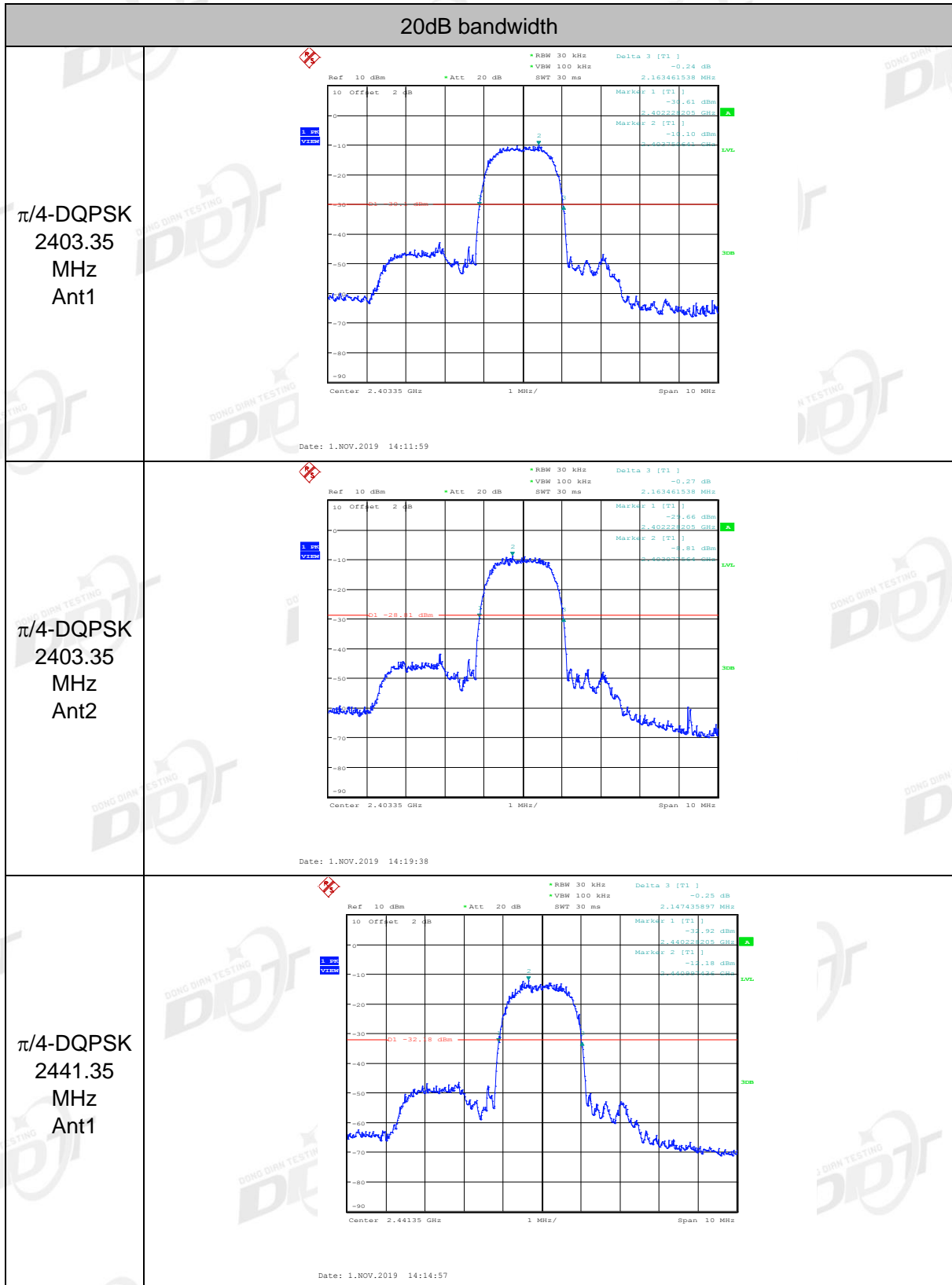

$\pi/4$ -DQPSK
2441.35
MHz
Ant2

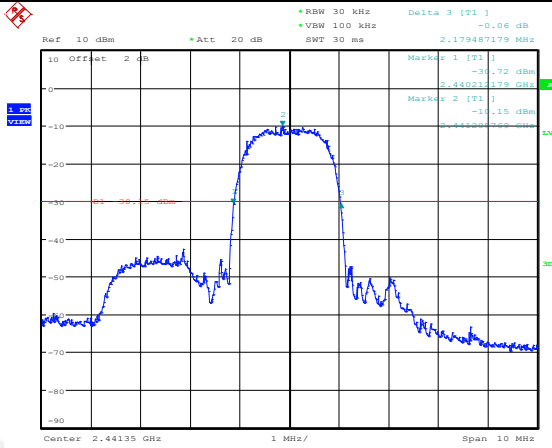

Date: 1.NOV.2019 14:18:45

$\pi/4$ -DQPSK
2479.35
MHz
Ant1

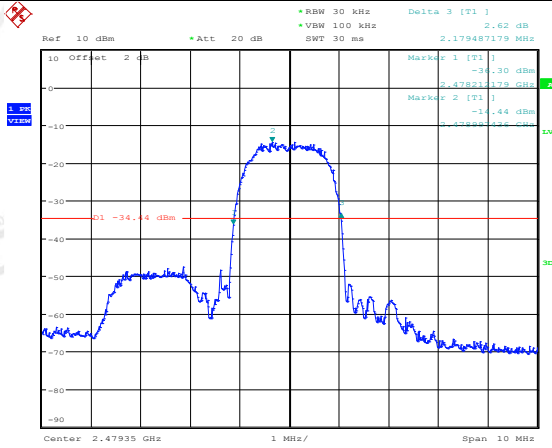

Date: 1.NOV.2019 14:16:35

$\pi/4$ -DQPSK
2479.35
MHz
Ant2

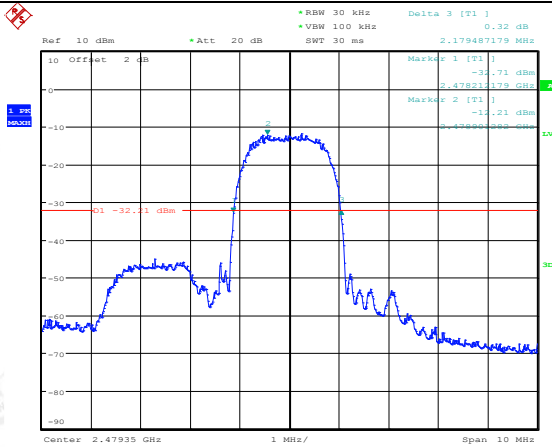

Date: 1.NOV.2019 14:17:44

5. Radiated emission

5.1. Block diagram of test setup

In 3m Anechoic Chamber Test Setup Diagram for 9kHz-30MHz

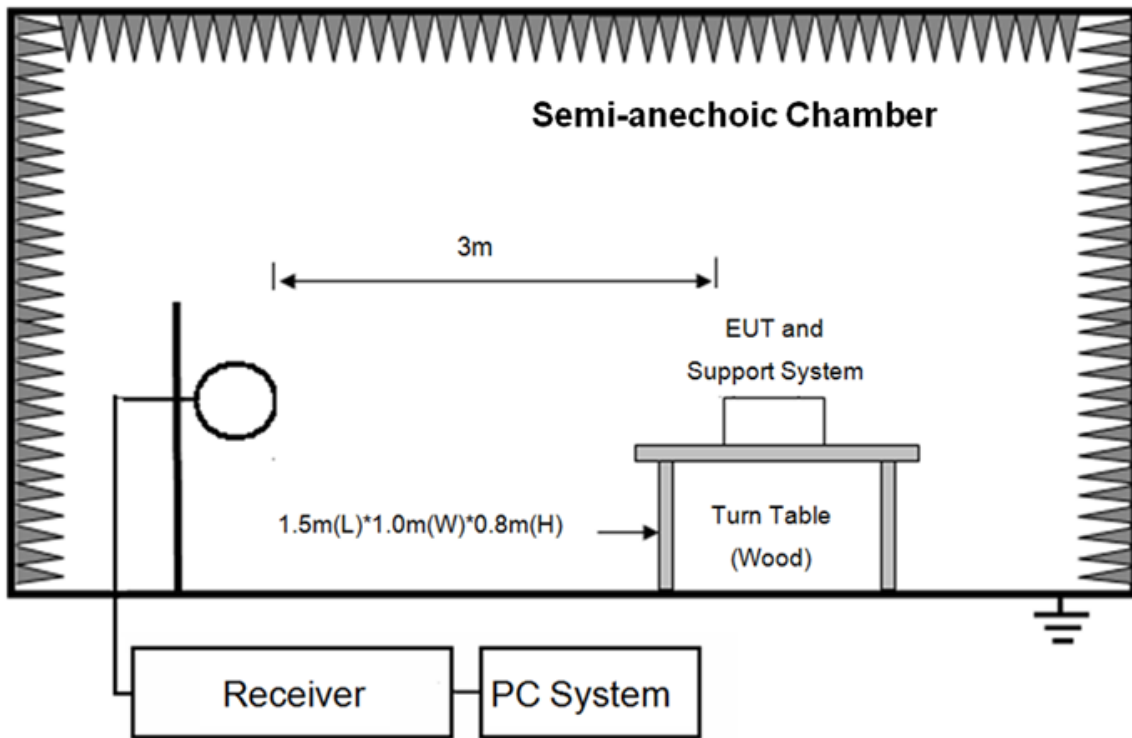

In 3m Anechoic Chamber Test Setup Diagram for 30MHz-1GHz

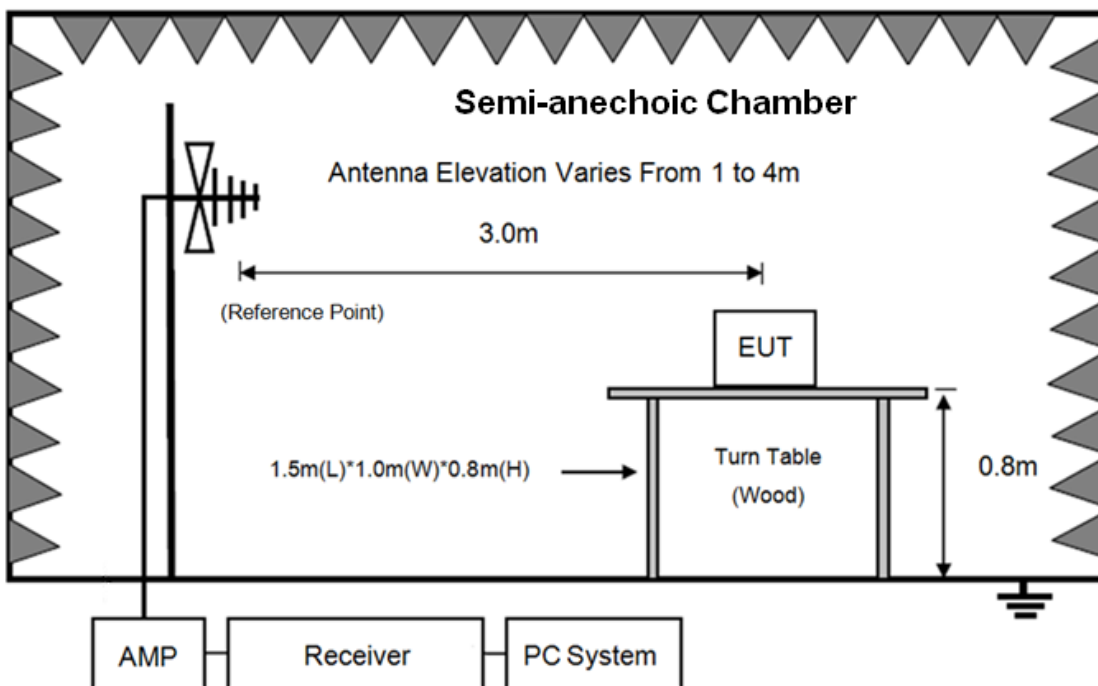

In 3m Anechoic Chamber Test Setup Diagram for frequency above 1GHz

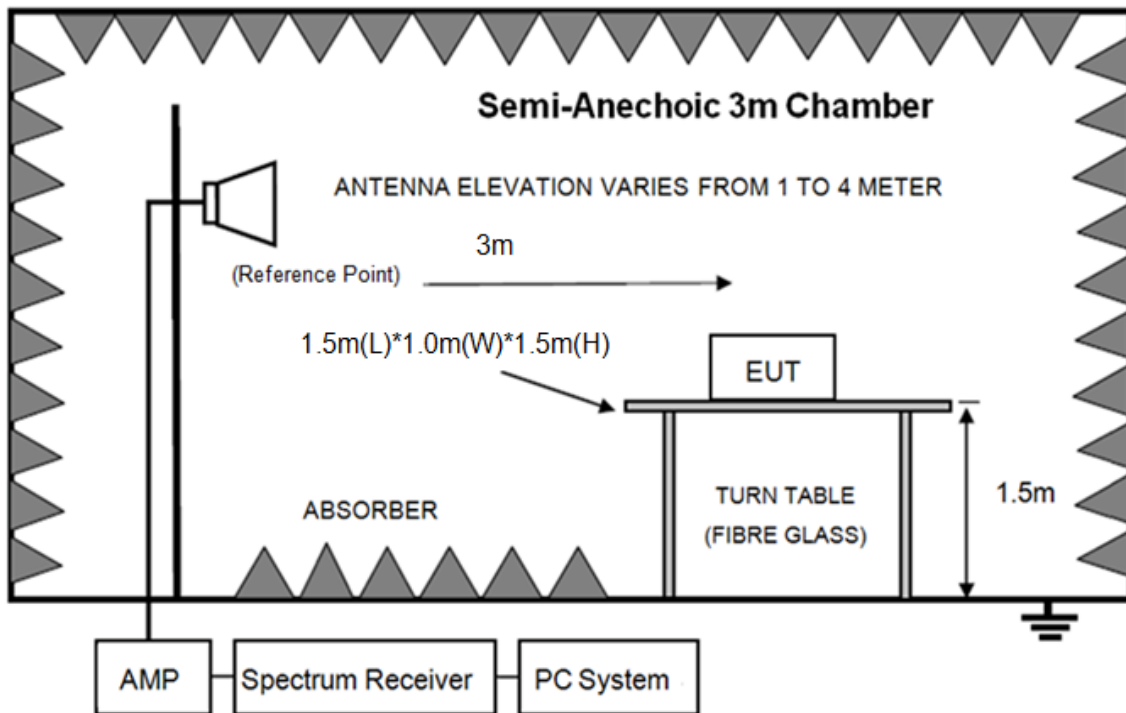

Note: For harmonic emissions test an appropriate high pass filter was inserted in the input port of AMP.

5.2. Limit

FREQUENCY MHz	DISTANCE Meters	FIELD STRENGTHS LIMIT	
		$\mu\text{V}/\text{m}$	$\text{dB}(\mu\text{V})/\text{m}$
30 ~ 88	3	100	40.0
88 ~ 216	3	150	43.5
216 ~ 960	3	200	46.0
960 ~ 1000	3	500	54.0
Above 1000MHz	3	74.0 $\text{dB}(\mu\text{V})/\text{m}$ (Peak) 54.0 $\text{dB}(\mu\text{V})/\text{m}$ (Average)	
Field Strength of Fundamental emission for 2.4GHz-2.4835GHz	3	94.0 $\text{dB}(\mu\text{V})/\text{m}$ (Average) 114.0 $\text{dB}(\mu\text{V})/\text{m}$ (Peak)	
Field Strength of Harmonics	3	74.0 $\text{dB}(\mu\text{V})/\text{m}$ (Peak) 54.0 $\text{dB}(\mu\text{V})/\text{m}$ (Average)	

Remark:

- (1) Emission level $\text{dB}\mu\text{V} = 20 \log$ Emission level $\mu\text{V}/\text{m}$
- (2) The smaller limit shall apply at the cross point between two frequency bands.
- (3) Distance is the distance in meters between the measuring instrument, antenna and the closest point of any part of the device or system.
- (4) The emission limits shown in the above table are based on measurements employing a CISPR quasi-peak detector except for the frequency bands 9-90 kHz, 110-490 kHz and above 1000MHz, radiated emission limits in these three bands are based on measurements employing an average detector.

5.3. Test Procedure

- (1) EUT was placed on a non-metallic table, 80 cm above the ground plane inside a semi-anechoic chamber.
- (2) Setup EUT and assistant system according clause 2.3 and 4.2
- (3) Test antenna was located 3m from the EUT on an adjustable mast. Below pre-scan procedure was first performed in order to find prominent radiated emissions.
 - (a) Change work frequency or channel of device if practicable.
 - (b) Change modulation type of device if practicable.
 - (c) Change power supply range from 85% to 115% of the rated supply voltage
 - (d) Rotated EUT though three orthogonal axes to determine the attitude of EUT arrangement produces highest emissions
- (4) Spectrum frequency from 9kHz to 25GHz (tenth harmonic of fundamental frequency) was investigated, and no any obvious emission were detected from 9kHz to 30MHz and 18GHz to 25GHz, so below final test was performed with frequency range from 30MHz to 18GHz.
- (5) For final emissions measurements at each frequency of interest, the EUT were rotated and the antenna height was varied between 1m and 4m in order to maximize the emission. Measurements in both horizontal and vertical polarities were made and the data was recorded. In order to find the maximum emission, the relative positions of equipments and all of the interface cables were changed according to ANSI C63.10:2013 on Radiated Emission test.
- (6) For emissions from 30MHz to 1GHz, Quasi-Peak values were measured with EMI Receiver and the bandwidth of Receiver is 120 kHz.
- (7) For emissions above 1GHz, both Peak and Average level were measured with Spectrum Analyzer, and the RBW is set at 1MHz, VBW is set at 3MHz for Peak measure; RBW is set at 1MHz, VBW is set at 10Hz for Average measure. Peak detector is used for both PK and AV test.
- (8) For fundamental frequency test, set spectrum analyzer's RBW=3MHz, VBW=10MHz. peak detector for PK, RMS detector for AV, Read the Level in spectrum analyzer and record.

5.4. Test result

PASS. (See below detailed test result)

All the emissions except fundamental emission from 9kHz to 25GHz were comply with 15.209 limit.

Note1: According exploratory test no any obvious emission was detected from 9kHz to 30MHz and 18GHz to 25GHz, so the final test was performed with frequency range from 30MHz to 18GHz and recorded in below.

Note2: For emissions below 1GHz, according exploratory explorer test, when change Tx mode and channel, have no distinct influence on emissions level, so for emissions below 1GHz, the final test was only performed with EUT working in $\pi/4$ -DQPSK, Tx Ant2 2441.35MHz mode.

Note3: For emissions above 1GHz. If peak results comply with AV limit, AV Result is deemed to comply with AV limit.

Field Strength of the Fundamental Signal

Freq. (MHz)	Read level (dB μ V)	Antenna Factor (dB/m)	PRM Factor (dB)	Cable Loss (dB)	Result Level (dB μ V/m)	Limit (dB μ V/m)	Margin (dB)	Detector type	Polarization
$\pi/4$-DQPSK Tx mode Ant1									
2403.35	105.01	29.12	43.29	3.75	94.59	114.00	-19.41	Peak	HORIZONTAL
2403.35	99.77	29.12	43.29	3.75	89.35	94.00	-4.65	Average	HORIZONTAL
2403.35	101.99	29.12	43.29	3.75	91.57	114.00	-22.43	Peak	VERTICAL
2441.35	104.77	29.19	43.33	3.80	94.43	114.00	-19.57	Peak	HORIZONTAL
2441.35	100.29	29.19	43.33	3.80	89.95	94.00	-4.05	Average	HORIZONTAL
2441.35	100.03	29.19	43.33	3.80	89.69	114.00	-24.31	Peak	VERTICAL
2479.35	104.67	29.26	43.37	3.86	94.42	114.00	-19.58	Peak	HORIZONTAL
2479.35	100.17	29.26	43.37	3.86	89.92	94.00	-4.08	Average	HORIZONTAL
2479.35	99.96	29.26	43.37	3.86	89.71	114.00	-24.29	Peak	VERTICAL
$\pi/4$-DQPSK Tx mode Ant2									
2403.30	104.81	29.12	43.29	3.74	94.38	114.00	-19.62	Peak	HORIZONTAL
2403.30	99.90	29.12	43.29	3.74	89.47	94.00	-4.53	Average	HORIZONTAL
2403.35	102.91	29.12	43.29	3.75	92.49	114.00	-21.51	Peak	VERTICAL
2441.35	105.03	29.19	43.33	3.80	94.69	114.00	-19.31	Peak	HORIZONTAL
2441.35	100.33	29.19	43.33	3.80	89.99	94.00	-4.01	Average	HORIZONTAL
2441.35	99.77	29.19	43.33	3.80	89.43	114.00	-24.57	Peak	VERTICAL
2479.35	104.63	29.26	43.37	3.86	94.38	114.00	-19.62	Peak	HORIZONTAL
2479.35	100.07	29.26	43.37	3.86	89.82	94.00	-4.18	Average	HORIZONTAL
2479.35	101.03	29.26	43.37	3.86	90.78	114.00	-23.22	Peak	VERTICAL
Result: Pass									

Note: 1. Result Level = Read Level + Antenna Factor + Cable loss - PRM Factor.

2. For emissions above 1GHz. If peak results comply with AV limit, AV Result is deemed to comply with AV limit.

Radiated Emission test (below 1GHz) TR-4-E-009 Radiated Emission Test Result

<p>Test Site : DDT 3m Chamber 1#</p> <p>Test Date : 2019-10-15</p> <p>EUT : USB Wireless Dongle</p> <p>Power Supply : DC 5V</p> <p>Condition : Temp:24.5°C,Humi:55%,Press:101.4kPa</p> <p>Memo :</p>	<p>D:\2019 RE1# Report Data\Q19092705-1E QUANTUM800\FCC BELOW1G.EM6</p> <p>Tested By : Jacky</p> <p>Model Number : QUANTUM800TM</p> <p>Test Mode : Tx mode</p> <p>Antenna/Distance : 2018 VULB 9163 1#/3m/VERTICAL</p>
--	--

Data: 1

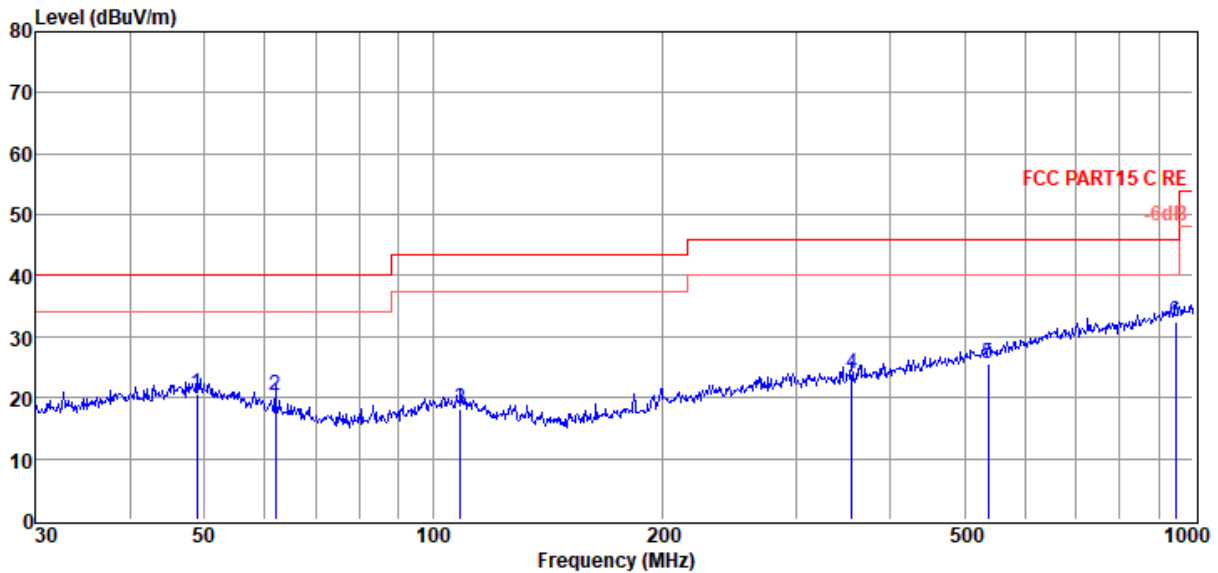

Item (Mark)	Freq. (MHz)	Read Level (dBμV)	Antenna Factor (dB/m)	Cable Loss (dB)	Result Level (dBμV/m)	Limit Line (dBμV/m)	Over Limit (dB)	Detector	Polarization
1	48.84	2.36	14.47	3.86	20.69	40.00	-19.31	QP	VERTICAL
2	62.00	5.32	11.00	3.97	20.29	40.00	-19.71	QP	VERTICAL
3	108.65	2.22	11.79	4.25	18.26	43.50	-25.24	QP	VERTICAL
4	355.43	3.53	14.94	5.37	23.84	46.00	-22.16	QP	VERTICAL
5	537.59	2.06	17.66	5.93	25.65	46.00	-20.35	QP	VERTICAL
6	948.76	3.09	22.25	7.06	32.40	46.00	-13.60	QP	VERTICAL

Note: 1. Result Level = Read Level + Antenna Factor + Cable loss.
 2. If Peak Result complies with QP limit, QP Result is deemed to comply with QP limit.
 3. Test setup: RBW: 120 kHz, VBW: 300 kHz, Sweep time: auto.

TR-4-E-009 Radiated Emission Test Result

Test Site : DDT 3m Chamber 1#
Test Date : 2019-10-15
EUT : USB Wireless Dongle
Power Supply : DC 5V
Condition : Temp:24.5°C,Humi:55%,Press:101.4kPa
Memo :

D:\2019 RE1# Report Data\Q19092705-1E QUANTUM800\FCC BELOW1G.EM6
Tested By : Jacky
Model Number : QUANTUM800TM
Test Mode : Tx mode
Antenna/Distance : 2018 VULB 9163 1#/3m/HORIZONTAL

Data: 2

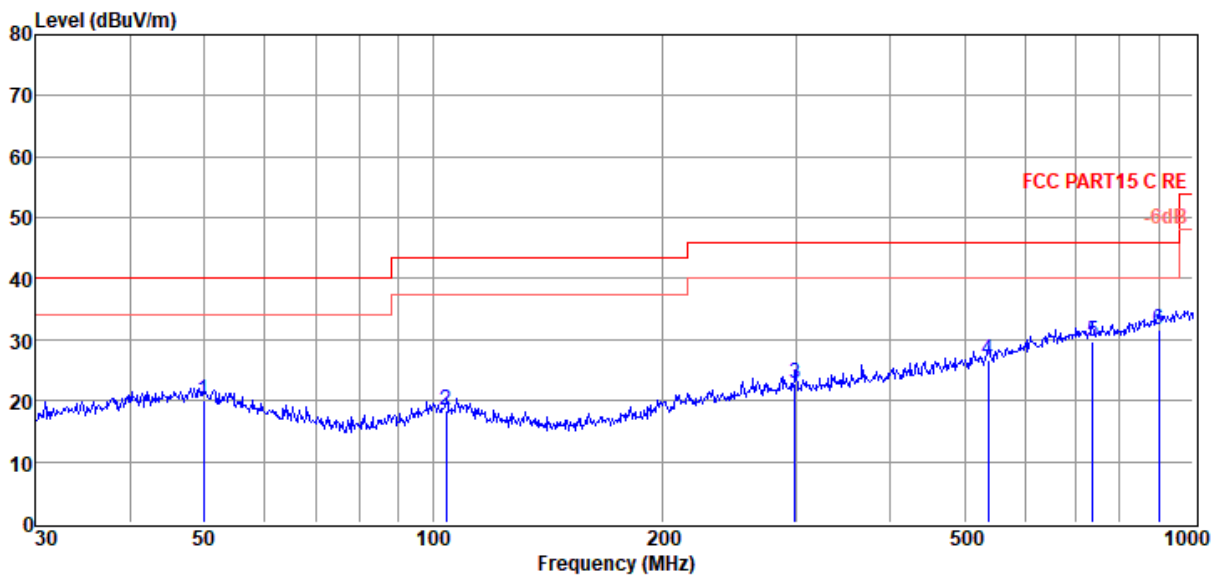

Item (Mark)	Freq. (MHz)	Read Level (dBuV)	Antenna Factor (dB/m)	Cable Loss (dB)	Result Level (dBuV/m)	Limit Line (dBuV/m)	Over Limit (dB)	Detector	Polarization
1	49.88	1.71	14.59	3.87	20.17	40.00	-19.83	QP	HORIZONTAL
2	104.17	2.41	11.74	4.23	18.38	43.50	-25.12	QP	HORIZONTAL
3	299.32	3.58	13.99	5.18	22.75	46.00	-23.25	QP	HORIZONTAL
4	537.59	3.17	17.66	5.93	26.76	46.00	-19.24	QP	HORIZONTAL
5	737.07	2.96	20.33	6.47	29.76	46.00	-16.24	QP	HORIZONTAL
6	900.15	3.00	21.70	6.92	31.62	46.00	-14.38	QP	HORIZONTAL

Note: 1. Result Level = Read Level + Antenna Factor + Cable loss.
 2. If Peak Result complies with QP limit, QP Result is deemed to comply with QP limit.
 3. Test setup: RBW: 120 kHz, VBW: 300 kHz, Sweep time: auto.

Radiated Emission test (above 1GHz)

Freq. (MHz)	Read level (dB μ V)	Antenna Factor (dB/m)	PRM Factor (dB)	Cable Loss (dB)	Result Level (dB μ V/m)	Limit (dB μ V/m)	Margin (dB)	Detector type	Polarization
$\pi/4$ -DQPSK Tx mode 2403.35MHz									
4009.00	46.01	32.91	44.25	5.28	39.95	74.00	-34.05	Peak	HORIZONTAL
5981.00	45.62	34.69	43.16	6.59	43.74	74.00	-30.26	Peak	HORIZONTAL
7936.00	44.71	36.25	43.18	7.26	45.04	74.00	-28.96	Peak	HORIZONTAL
10316.00	44.71	37.59	42.81	8.82	48.31	74.00	-25.69	Peak	HORIZONTAL
12696.00	43.82	38.18	42.92	10.22	49.30	74.00	-24.70	Peak	HORIZONTAL
14464.00	43.53	40.29	41.73	11.16	53.25	74.00	-20.75	Peak	HORIZONTAL
5505.00	45.17	34.30	43.21	6.10	42.36	74.00	-31.64	Peak	VERTICAL
7970.00	45.74	36.28	43.17	7.30	46.15	74.00	-27.85	Peak	VERTICAL
9585.00	45.72	37.16	43.06	8.40	48.22	74.00	-25.78	Peak	VERTICAL
11625.00	44.80	38.45	42.56	9.06	49.75	74.00	-24.25	Peak	VERTICAL
12951.00	46.23	38.28	42.84	10.63	52.30	74.00	-21.70	Peak	VERTICAL
14396.00	43.23	40.28	41.74	11.15	52.92	74.00	-21.08	Peak	VERTICAL
$\pi/4$ -DQPSK Tx mode 2441.35MHz									
5590.00	43.88	34.37	43.18	6.19	41.26	74.00	-32.74	Peak	HORIZONTAL
8395.00	43.92	36.70	42.37	7.57	45.82	74.00	-28.18	Peak	HORIZONTAL
10316.00	44.71	37.59	42.81	8.82	48.31	74.00	-25.69	Peak	HORIZONTAL
11761.00	44.64	38.28	42.60	9.08	49.40	74.00	-24.60	Peak	HORIZONTAL
12951.00	44.11	38.28	42.84	10.63	50.18	74.00	-23.82	Peak	HORIZONTAL
14141.00	43.74	40.23	41.75	11.12	53.34	74.00	-20.66	Peak	HORIZONTAL
5845.00	45.43	34.58	43.14	6.45	43.32	74.00	-30.68	Peak	VERTICAL
7766.00	45.26	36.12	43.25	7.06	45.19	74.00	-28.81	Peak	VERTICAL
8769.00	43.59	36.80	42.18	7.79	46.00	74.00	-28.00	Peak	VERTICAL
11081.00	43.93	37.68	41.55	9.01	49.07	74.00	-24.93	Peak	VERTICAL
13070.00	44.38	38.40	42.75	10.74	50.77	74.00	-23.23	Peak	VERTICAL
13614.00	44.31	39.28	42.17	10.95	52.37	74.00	-21.63	Peak	VERTICAL
$\pi/4$ -DQPSK Tx mode 2479.35MHz									
5845.00	44.20	34.58	43.14	6.45	42.09	74.00	-31.91	Peak	HORIZONTAL
8905.00	43.71	36.80	42.18	7.86	46.19	74.00	-27.81	Peak	HORIZONTAL
10554.00	43.82	37.68	42.42	8.88	47.96	74.00	-26.04	Peak	HORIZONTAL
12050.00	45.34	38.01	42.70	9.18	49.83	74.00	-24.17	Peak	HORIZONTAL
13580.00	43.97	39.19	42.21	10.94	51.89	74.00	-22.11	Peak	HORIZONTAL
14464.00	43.23	40.29	41.73	11.16	52.95	74.00	-21.05	Peak	HORIZONTAL
4961.00	45.78	33.88	43.71	5.57	41.52	74.00	-32.48	Peak	VERTICAL
7834.00	45.12	36.17	43.22	7.14	45.21	74.00	-28.79	Peak	VERTICAL
10146.00	43.68	37.49	43.05	8.78	46.90	74.00	-27.10	Peak	VERTICAL
11880.00	45.13	38.14	42.64	9.09	49.72	74.00	-24.28	Peak	VERTICAL
13461.00	44.27	38.95	42.33	10.89	51.78	74.00	-22.22	Peak	VERTICAL
14141.00	43.18	40.23	41.75	11.12	52.78	74.00	-21.22	Peak	VERTICAL
Result: Pass									

Note: 1. 30MHz~25GHz: (Scan with Ant1 and Ant2, worse case is Ant2)

2. Result Level = Read Level + Antenna Factor + Cable loss - PRM Factor.

3: For emissions above 1GHz. If peak results comply with AV limit, AV Result is deemed to comply with AV limit.

6. Band Edge Compliance

6.1. Block diagram of test setup

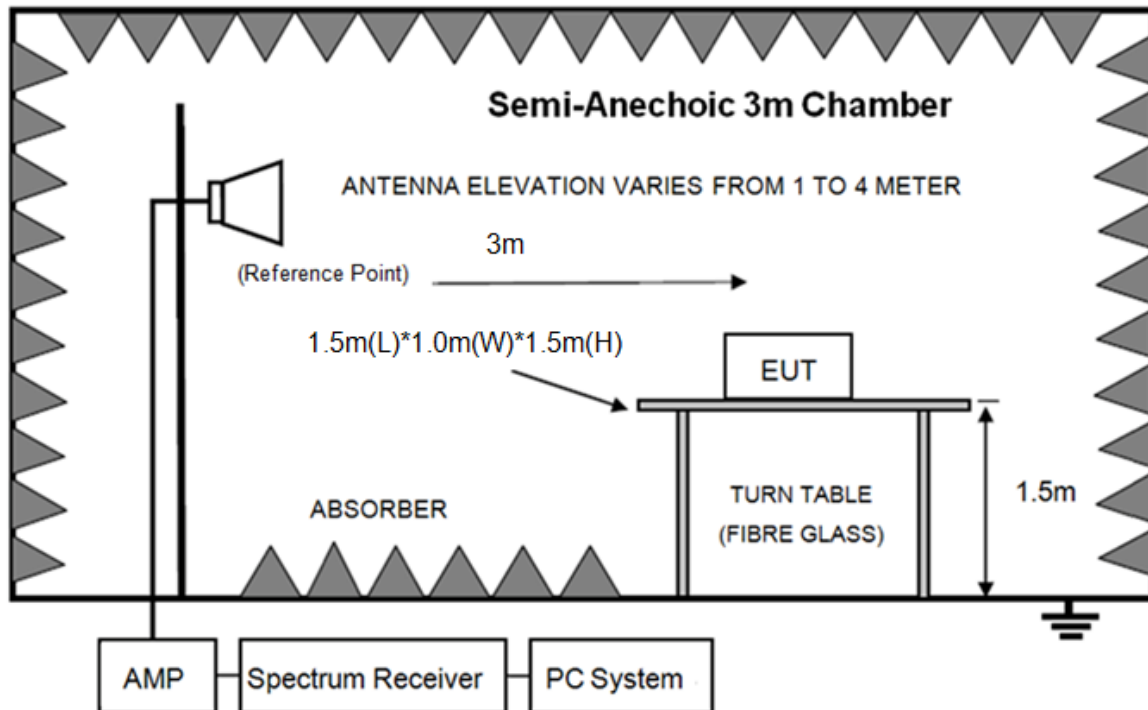

6.2. Limit

All the lower and upper band-edges emissions appearing within 2310MHz to 2390MHz and 2483.5MHz to 2500MHz restricted frequency bands shall not exceed the limits shown in 15.209, all the other emissions outside operation frequency band 2400MHz to 2483.5MHz and 5725MHz to 5850MHz shall be at least 20dB below the fundamental emissions, or comply with 15.209 limits.

6.3. Test Procedure

Same with clause 8.3 except change investigated frequency range from 2310MHz to 2410MHz and 2475MHz to 2500MHz.

Remark: All restriction band have been tested, and only the worst case is shown in report.

6.4. Test result

PASS. (See below detailed test result)

TR-4-E-009 Radiated Emission Test Result

Test Site : DDT 3m Chamber 1#
Test Date : 2019-10-22
EUT : USB Wireless Dongle
Power Supply : DC 5V
Condition : Temp:24.5°C,Humi:55%,Press:101.4kPa
Memo : 2403.35 ant1

D:\2019 RE1# Report Data\Q19092705-1E
QUANTUM800\FCC ABOVE 1G.EM6
Tested By : Jacky
Model Number : QUANTUM800TM
Test Mode : Tx mode
Antenna/Distance : 2018 HF 907/3m/VERTICAL

Data: 56

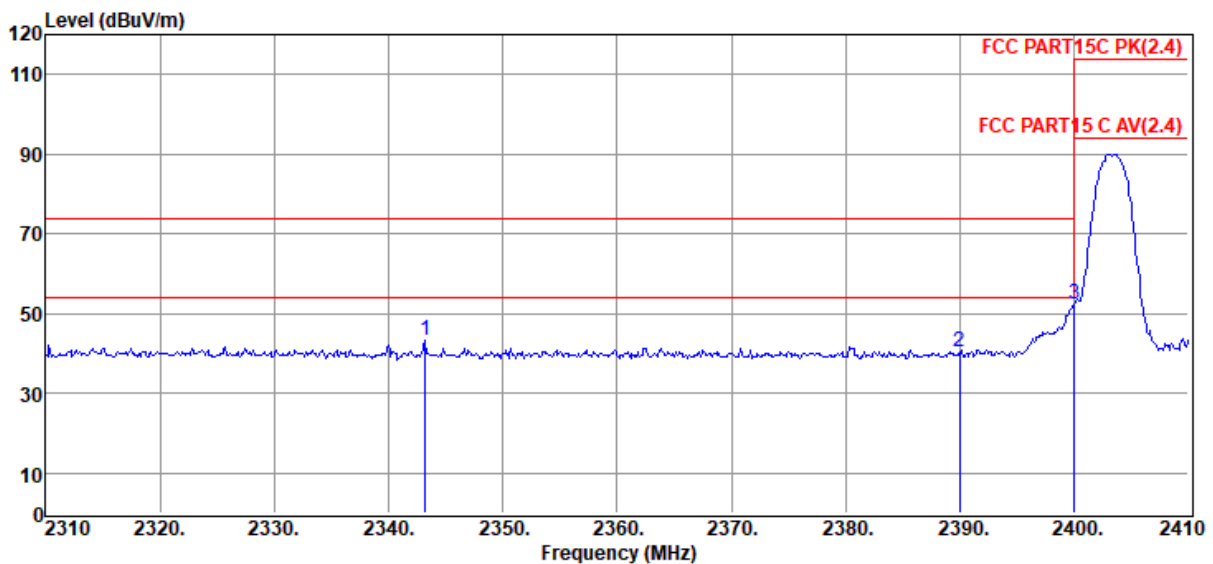

Item (Mark)	Freq. (MHz)	Read Level (dBμV)	Antenna Factor (dB/m)	PRM Factor (dB)	Cable Loss (dB)	Result Level (dBμV/m)	Limit Line (dBμV/m)	Over Limit (dB)	Detector	Polarization
1	2343.20	53.66	29.01	43.22	3.65	43.10	74.00	-30.90	Peak	VERTICAL
2	2390.00	50.82	29.10	43.27	3.73	40.38	74.00	-33.62	Peak	VERTICAL
3	2400.00	62.99	29.12	43.28	3.74	52.57	74.00	-21.43	Peak	VERTICAL

Note: 1. Result Level = Read Level + Antenna Factor + Cable loss - PRM Factor.
 2. If Peak Result complies with AV limit, AV Result is deemed to comply with AV limit.
 3. Test setup: RBW: 1 MHz, VBW: 3 MHz, Sweep time: auto.

TR-4-E-009 Radiated Emission Test Result

Test Site : DDT 3m Chamber 1#

D:\2019 RE1# Report Data\Q19092705-1E
QUANTUM800\FCC ABOVE 1G.EM6

Test Date : 2019-10-22

Tested By : Jacky

EUT : USB Wireless Dongle

Model Number : QUANTUM800TM

Power Supply : DC 5V

Test Mode : Tx mode

Condition : Temp:24.5°C,Humi:55%,Press:101.4kPa

Antenna/Distance : 2018 HF 907/3m/HORIZONTAL

Memo : 2403.35 ant1

Data: 57

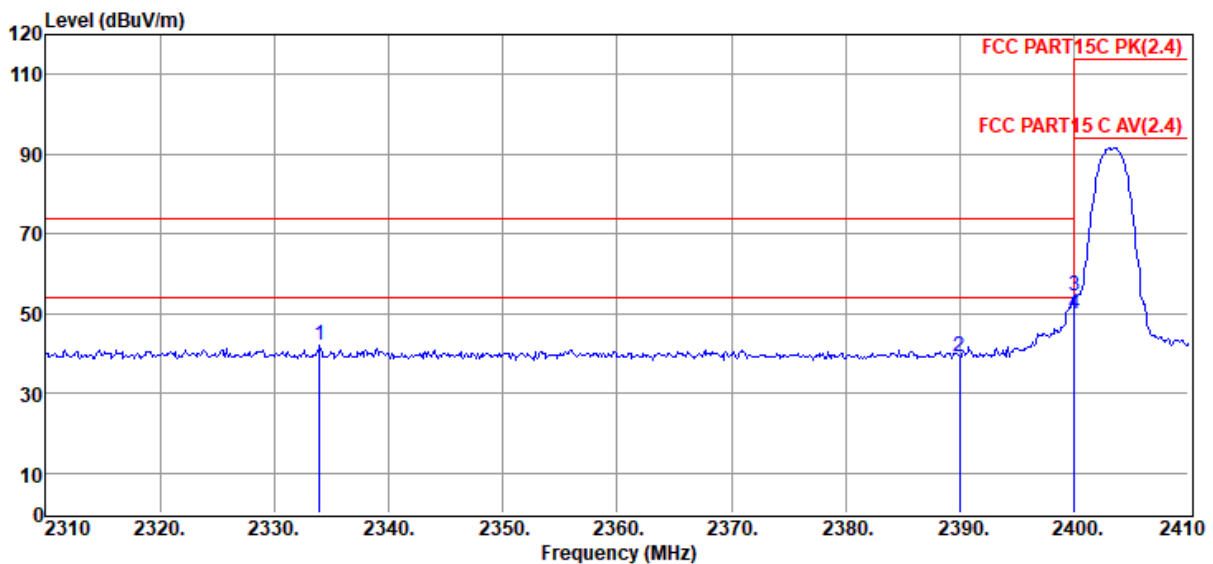

Item (Mark)	Freq. (MHz)	Read Level (dBuV)	Antenna Factor (dB/m)	PRM Factor (dB)	Cable Loss (dB)	Result Level (dBuV/m)	Limit Line (dBuV/m)	Over Limit (dB)	Detector	Polarization
1	2334.00	52.54	28.99	43.21	3.64	41.96	74.00	-32.04	Peak	HORIZONTAL
2	2390.00	49.69	29.10	43.27	3.73	39.25	74.00	-34.75	Peak	HORIZONTAL
3	2400.00	64.65	29.12	43.28	3.74	54.23	74.00	-19.77	Peak	HORIZONTAL
4	2400.00	60.34	29.12	43.28	3.74	49.92	54.00	-4.08	Average	HORIZONTAL

Note: 1. Result Level = Read Level + Antenna Factor + Cable loss - PRM Factor.

2. If Peak Result complies with AV limit, AV Result is deemed to comply with AV limit.

3. Test setup: RBW: 1 MHz, VBW: 3 MHz, Sweep time: auto.

TR-4-E-009 Radiated Emission Test Result

Test Site : DDT 3m Chamber 1#
Test Date : 2019-10-22
EUT : USB Wireless Dongle
Power Supply : DC 5V
Condition : Temp:24.5°C,Humi:55%,Press:101.4kPa
Memo : 2403.35 ant2
D:\2019 RE1# Report Data\Q19092705-1E QUANTUM800\FCC ABOVE 1G.EM6
Tested By : Jacky
Model Number : QUANTUM800TM
Test Mode : Tx mode
Antenna/Distance : 2018 HF 907/3m/HORIZONTAL

Data: 58

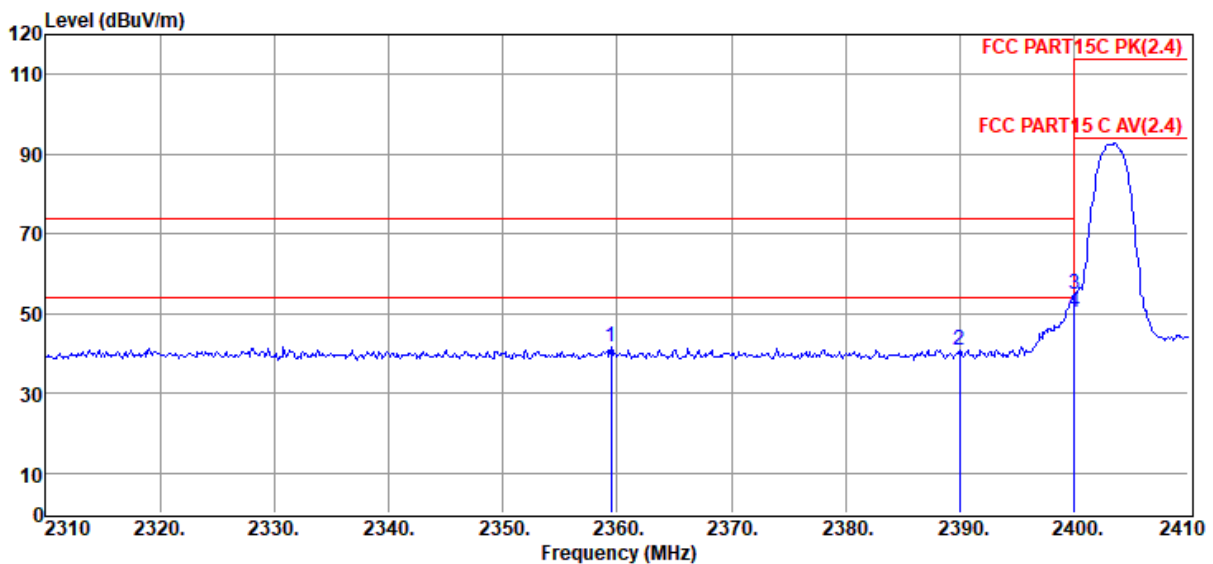

Item (Mark)	Freq. (MHz)	Read Level (dBμV)	Antenna Factor (dB/m)	PRM Factor (dB)	Cable Loss (dB)	Result Level (dBμV/m)	Limit Line (dBμV/m)	Over Limit (dB)	Detector	Polarization
1	2359.50	52.34	29.04	43.24	3.68	41.82	74.00	-32.18	Peak	HORIZONTAL
2	2390.00	51.08	29.10	43.27	3.73	40.64	74.00	-33.36	Peak	HORIZONTAL
3	2400.00	65.45	29.12	43.28	3.74	55.03	74.00	-18.97	Peak	HORIZONTAL
4	2400.00	60.94	29.12	43.28	3.74	50.52	54.00	-3.48	Average	HORIZONTAL

Note: 1. Result Level = Read Level + Antenna Factor + Cable loss - PRM Factor.
 2. If Peak Result complies with AV limit, AV Result is deemed to comply with AV limit.
 3. Test setup: RBW: 1 MHz, VBW: 3 MHz, Sweep time: auto.

TR-4-E-009 Radiated Emission Test Result

Test Site : DDT 3m Chamber 1#

D:\2019 RE1# Report Data\Q19092705-1E
QUANTUM800\FCC ABOVE 1G.EM6

Test Date : 2019-10-22

Tested By : Jacky

EUT : USB Wireless Dongle

Model Number : QUANTUM800TM

Power Supply : DC 5V

Test Mode : Tx mode

Condition : Temp:24.5°C,Humi:55%,Press:101.4kPa

Antenna/Distance : 2018 HF 907/3m/VERTICAL

Memo : 2403.35 ant2

Data: 59

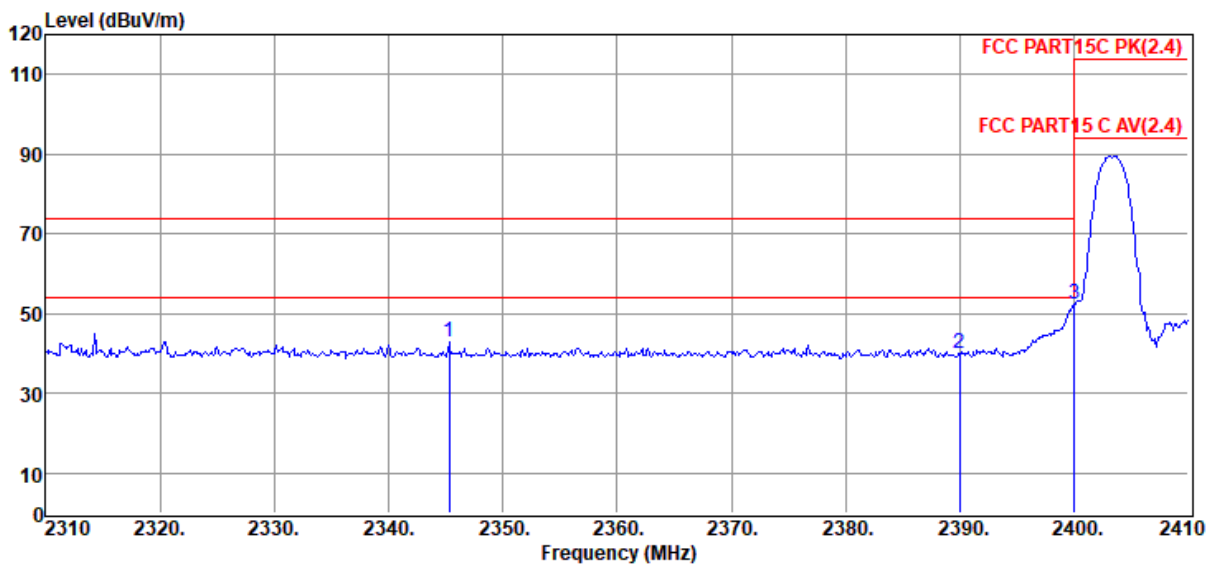

Item (Mark)	Freq. (MHz)	Read Level (dBuV)	Antenna Factor (dB/m)	PRM Factor (dB)	Cable Loss (dB)	Result Level (dBuV/m)	Limit Line (dBuV/m)	Over Limit (dB)	Detector	Polarization
1	2345.30	53.34	29.01	43.22	3.66	42.79	74.00	-31.21	Peak	VERTICAL
2	2390.00	50.43	29.10	43.27	3.73	39.99	74.00	-34.01	Peak	VERTICAL
3	2400.00	62.61	29.12	43.28	3.74	52.19	74.00	-21.81	Peak	VERTICAL

Note: 1. Result Level = Read Level + Antenna Factor + Cable loss - PRM Factor.

2. If Peak Result complies with AV limit, AV Result is deemed to comply with AV limit.

3. Test setup: RBW: 1 MHz, VBW: 3 MHz, Sweep time: auto.

TR-4-E-009 Radiated Emission Test Result

Test Site : DDT 3m Chamber 1#
Test Date : 2019-10-22
EUT : USB Wireless Dongle
Power Supply : DC 5V
Condition : Temp:24.5°C,Humi:55%,Press:101.4kPa
Memo : 2479.35 ant1
D:\2019 RE1# Report Data\Q19092705-1E QUANTUM800\FCC ABOVE 1G.EM6
Tested By : Jacky
Model Number : QUANTUM800TM
Test Mode : Tx mode
Antenna/Distance : 2018 HF 907/3m/HORIZONTAL

Data: 60

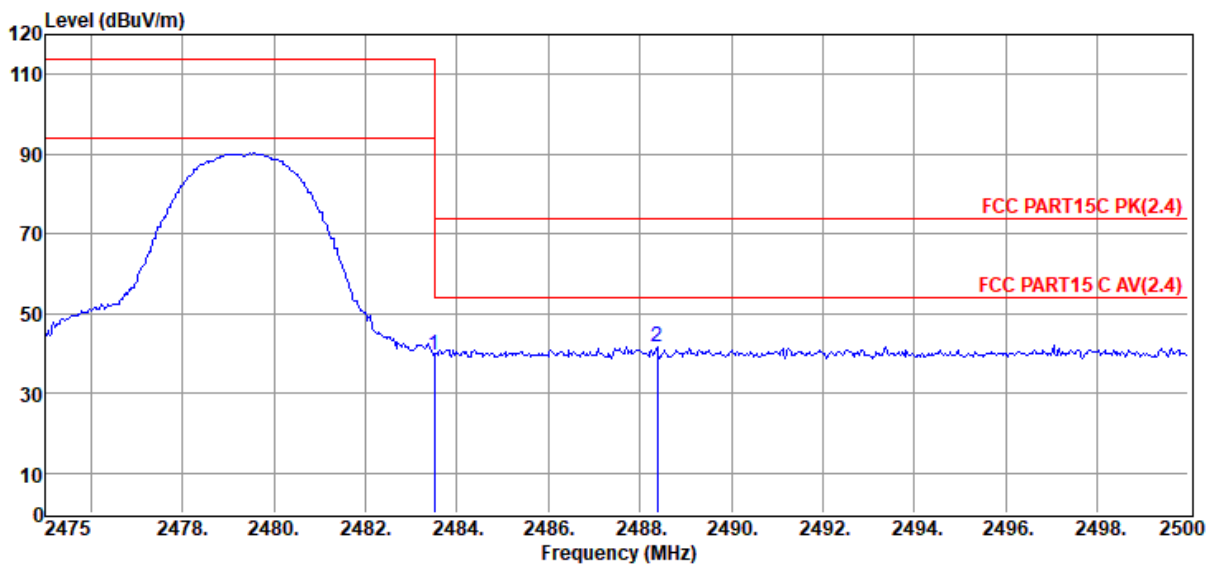

Item (Mark)	Freq. (MHz)	Read Level (dBμV)	Antenna Factor (dB/m)	PRM Factor (dB)	Cable Loss (dB)	Result Level (dBμV/m)	Limit Line (dBμV/m)	Over Limit (dB)	Detector	Polarization
1	2483.50	49.68	29.27	43.37	3.87	39.45	74.00	-34.55	Peak	HORIZONTAL
2	2488.38	51.81	29.28	43.38	3.87	41.58	74.00	-32.42	Peak	HORIZONTAL

- Note: 1. Result Level = Read Level + Antenna Factor + Cable loss - PRM Factor.
 2. If Peak Result complies with AV limit, AV Result is deemed to comply with AV limit.
 3. Test setup: RBW: 1 MHz, VBW: 3 MHz, Sweep time: auto.

TR-4-E-009 Radiated Emission Test Result

Test Site : DDT 3m Chamber 1# **D:\2019 RE1# Report Data\Q19092705-1E**
QUANTUM800\FCC ABOVE 1G.EM6
Test Date : 2019-10-22 **Tested By** : Jacky
EUT : USB Wireless Dongle **Model Number** : QUANTUM800TM
Power Supply : DC 5V **Test Mode** : Tx mode
Condition : Temp:24.5°C,Humi:55%,Press:101.4kPa **Antenna/Distance** : 2018 HF 907/3m/VERTICAL
Memo : 2479.35 ant1

Data: 61

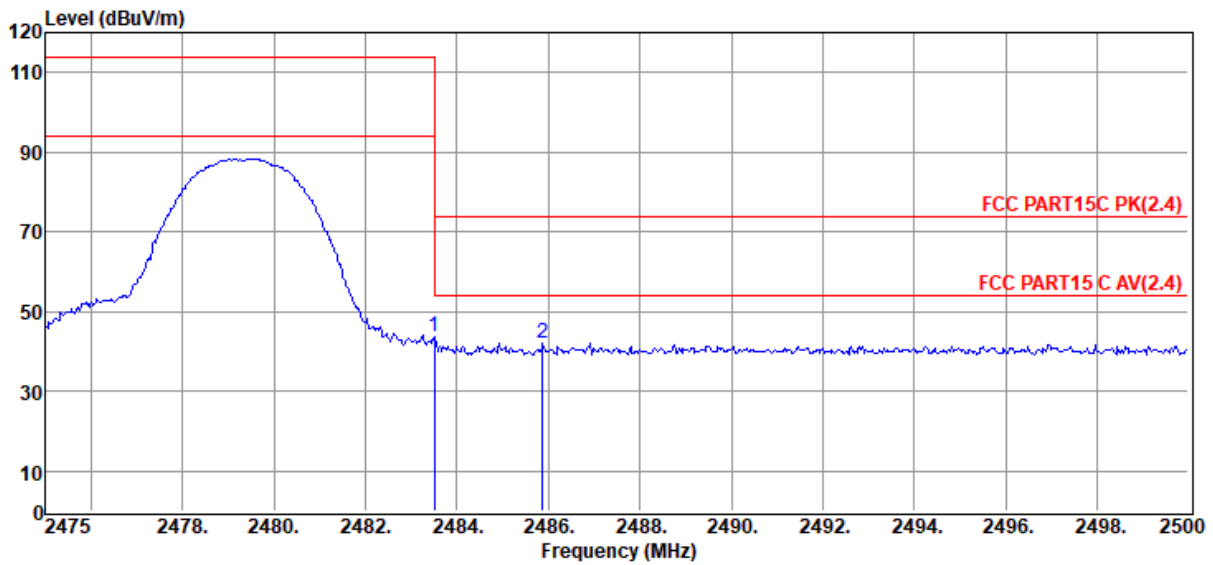

Item (Mark)	Freq. (MHz)	Read Level (dBμV)	Antenna Factor (dB/m)	PRM Factor (dB)	Cable Loss (dB)	Result Level (dBμV/m)	Limit Line (dBμV/m)	Over Limit (dB)	Detector	Polarization
1	2483.50	53.91	29.27	43.37	3.87	43.68	74.00	-30.32	Peak	VERTICAL
2	2485.88	52.17	29.27	43.37	3.87	41.94	74.00	-32.06	Peak	VERTICAL

- Note: 1. Result Level = Read Level + Antenna Factor + Cable loss - PRM Factor.
 2. If Peak Result complies with AV limit, AV Result is deemed to comply with AV limit.
 3. Test setup: RBW: 1 MHz, VBW: 3 MHz, Sweep time: auto.

TR-4-E-009 Radiated Emission Test Result

Test Site : DDT 3m Chamber 1#

D:\2019 RE1# Report Data\Q19092705-1E
QUANTUM800\FCC ABOVE 1G.EM6

Test Date : 2019-10-22

Tested By : Jacky

EUT : USB Wireless Dongle

Model Number : QUANTUM800TM

Power Supply : DC 5V

Test Mode : Tx mode

Condition : Temp:24.5°C,Humi:55%,Press:101.4kPa

Antenna/Distance : 2018 HF 907/3m/VERTICAL

Memo : 2479.35 ant2

Data: 62

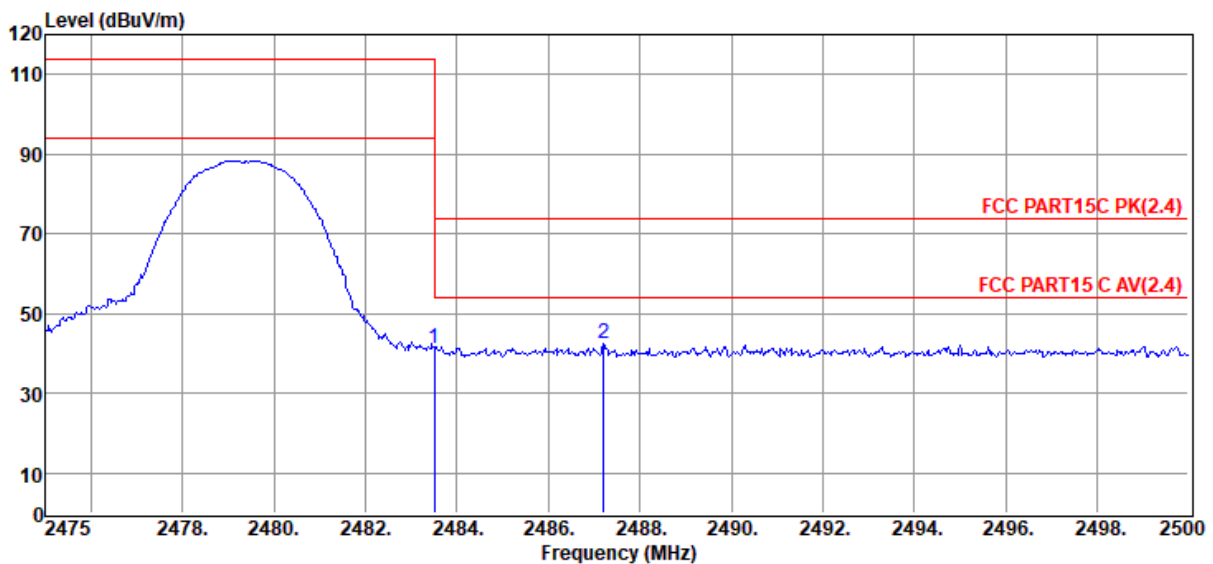

Item (Mark)	Freq. (MHz)	Read Level (dBuV)	Antenna Factor (dB/m)	PRM Factor (dB)	Cable Loss (dB)	Result Level (dBuV/m)	Limit Line (dBuV/m)	Over Limit (dB)	Detector	Polarization
1	2483.50	51.56	29.27	43.37	3.87	41.33	74.00	-32.67	Peak	VERTICAL
2	2487.20	52.81	29.28	43.38	3.87	42.58	74.00	-31.42	Peak	VERTICAL

- Note: 1. Result Level = Read Level + Antenna Factor + Cable loss - PRM Factor.
 2. If Peak Result complies with AV limit, AV Result is deemed to comply with AV limit.
 3. Test setup: RBW: 1 MHz, VBW: 3 MHz, Sweep time: auto.

TR-4-E-009 Radiated Emission Test Result

Test Site : DDT 3m Chamber 1# **D:\2019 RE1# Report Data\Q19092705-1E**
QUANTUM800\FCC ABOVE 1G.EM6
Test Date : 2019-10-22 **Tested By** : Jacky
EUT : USB Wireless Dongle **Model Number** : QUANTUM800TM
Power Supply : DC 5V **Test Mode** : Tx mode
Condition : Temp:24.5°C,Humi:55%,Press:101.4kPa **Antenna/Distance** : 2018 HF 907/3m/HORIZONTAL
Memo : 2479.35 ant2

Data: 63

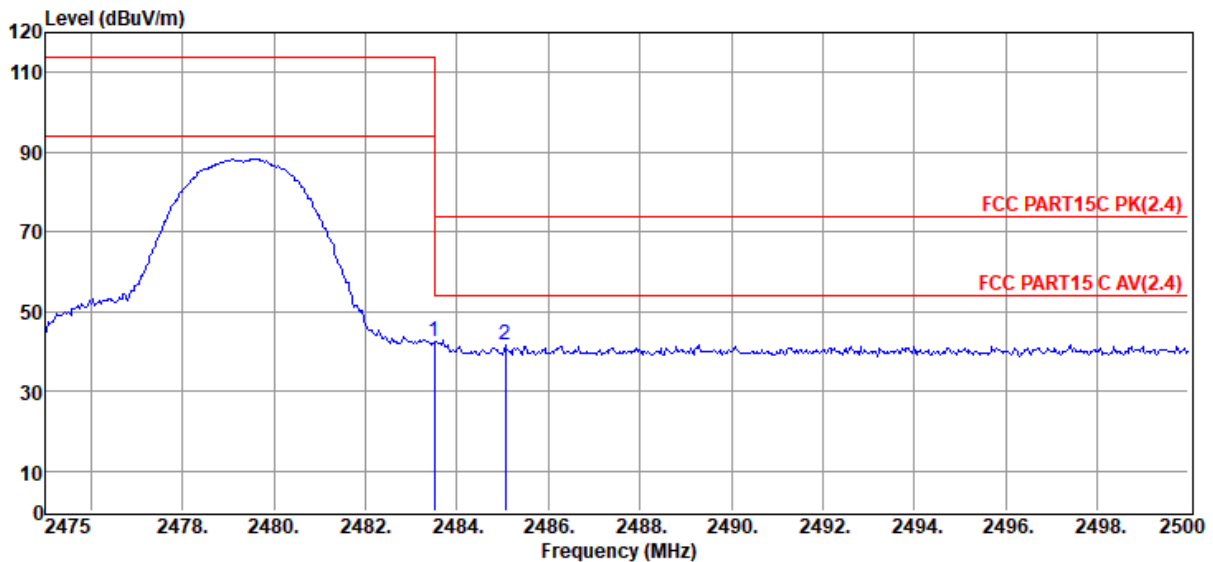

Item (Mark)	Freq. (MHz)	Read Level (dBuV)	Antenna Factor (dB/m)	PRM Factor (dB)	Cable Loss (dB)	Result Level (dBuV/m)	Limit Line (dBuV/m)	Over Limit (dB)	Detector	Polarization
1	2483.50	52.77	29.27	43.37	3.87	42.54	74.00	-31.46	Peak	HORIZONTAL
2	2485.05	51.99	29.27	43.37	3.87	41.76	74.00	-32.24	Peak	HORIZONTAL

- Note: 1. Result Level = Read Level + Antenna Factor + Cable loss - PRM Factor.
 2. If Peak Result complies with AV limit, AV Result is deemed to comply with AV limit.
 3. Test setup: RBW: 1 MHz, VBW: 3 MHz, Sweep time: auto.

7. Power Line Conducted Emission

7.1. Block diagram of test setup

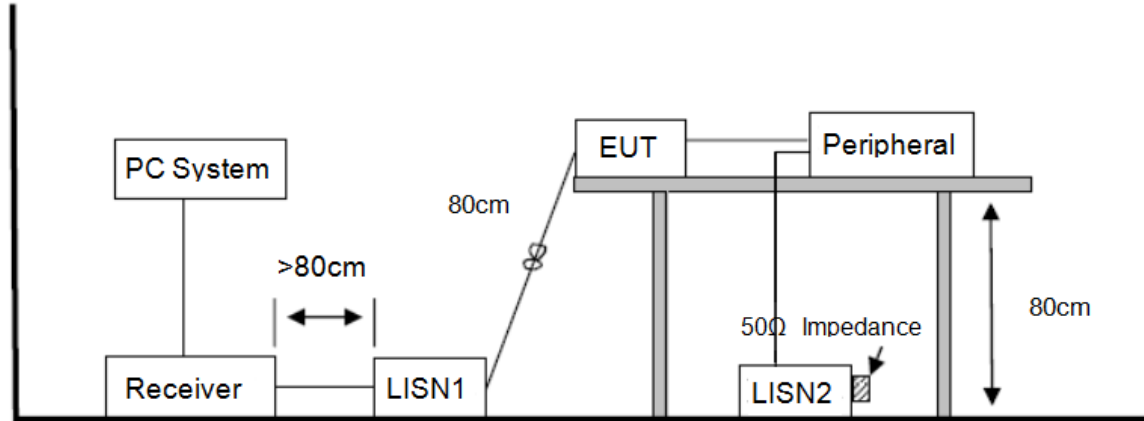

7.2. Power Line Conducted Emission Limits

Frequency	Quasi-Peak Level dB(μ V)	Average Level dB(μ V)
150kHz ~ 500kHz	66 ~ 56*	56 ~ 46*
500kHz ~ 5MHz	56	46
5MHz ~ 30MHz	60	50

Note 1: * Decreasing linearly with logarithm of frequency.

Note 2: The lower limit shall apply at the transition frequencies.

7.3. Test Procedure

The EUT and Support equipment, if needed, were put placed on a non-metallic table, 80cm above the ground plane.

Configuration EUT to simulate typical usage as described in clause 2.4 and test equipment as described in clause 10.2 of this report.

All I/O cables were positioned to simulate typical actual usage as per ANSI C63.10.

All support equipment power received from a second LISN.

Emissions were measured on each current carrying line of the EUT using an EMI Test Receiver connected to the LISN powering the EUT.

The Receiver scanned from 150 kHz to 30MHz for emissions in each of the test modes.

During the above scans, the emissions were maximized by cable manipulation.

The test mode(s) described in clause 2.4 were scanned during the preliminary test.

After the preliminary scan, we found the test mode producing the highest emission level. The EUT configuration and worse cable configuration of the above highest emission levels were

recorded for reference of the final test.

EUT and support equipment were set up on the test bench as per the configuration with highest emission level in the preliminary test.

A scan was taken on both power lines, Neutral and Line, recording at least the six highest emissions.

Emission frequency and amplitude were recorded into a computer in which correction factors were used to calculate the emission level and compare reading to the applicable limit.

The test data of the worst-case condition(s) was recorded.

The bandwidth of test receiver is set at 9 kHz.

7.4. Test Result

Not Applicable, since the EUT is not AC-operated device.

8. Antenna Requirements

8.1. Limit

For intentional device, according to FCC 47 CFR Section 15.203, an intentional radiator shall be designed to ensure that no antenna other than that furnished by the responsible party shall be used with the device.

8.2. Result

The antennas used for this product are dedicated FPC antenna and that no antenna other than that furnished by the responsible party shall be used with the device, the maximum peak gain of the transmit antenna is only 0.88 dBi.

END OF REPORT