

11AC20 ANT2 5320

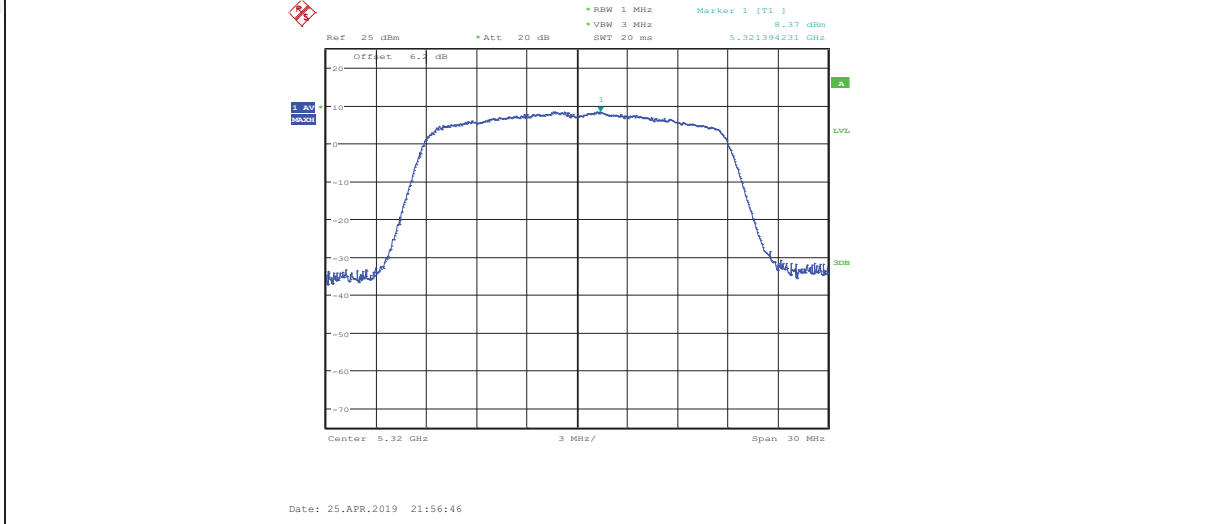

11AC20 ANT1 5500

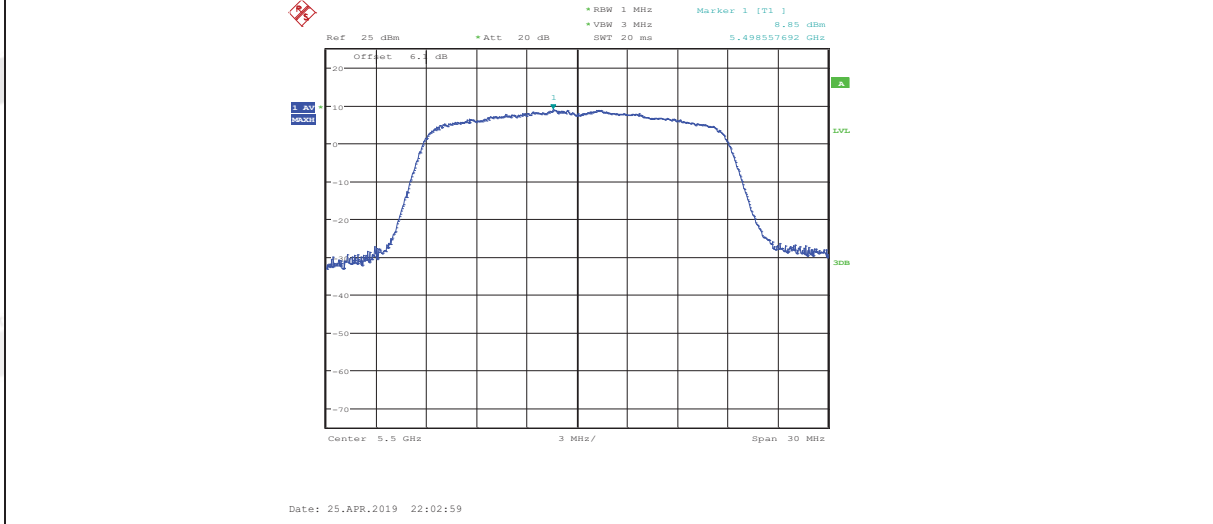

11AC20 ANT2 5500

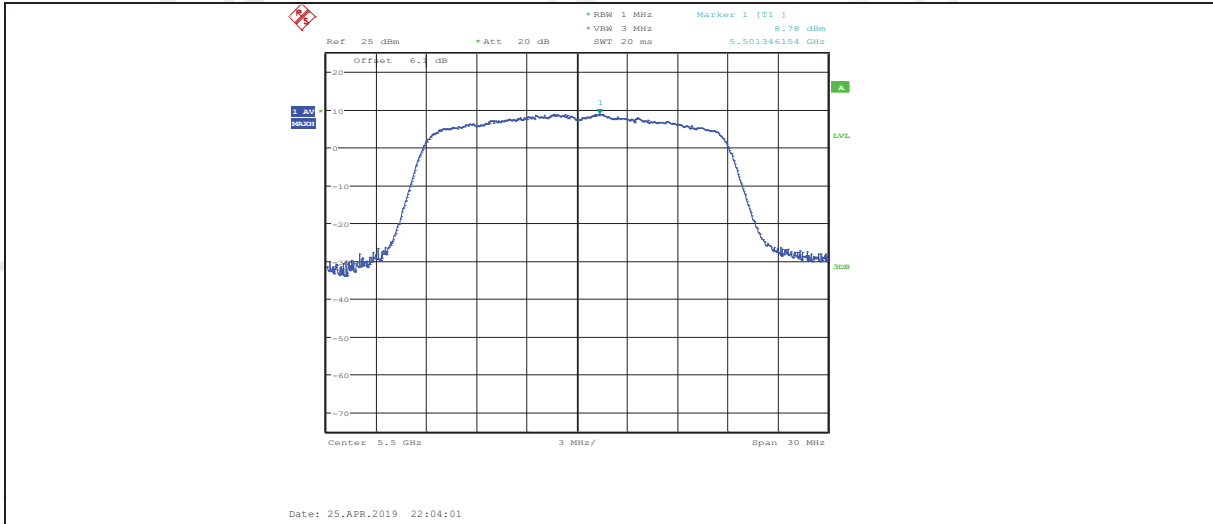

11AC20 ANT1 5580

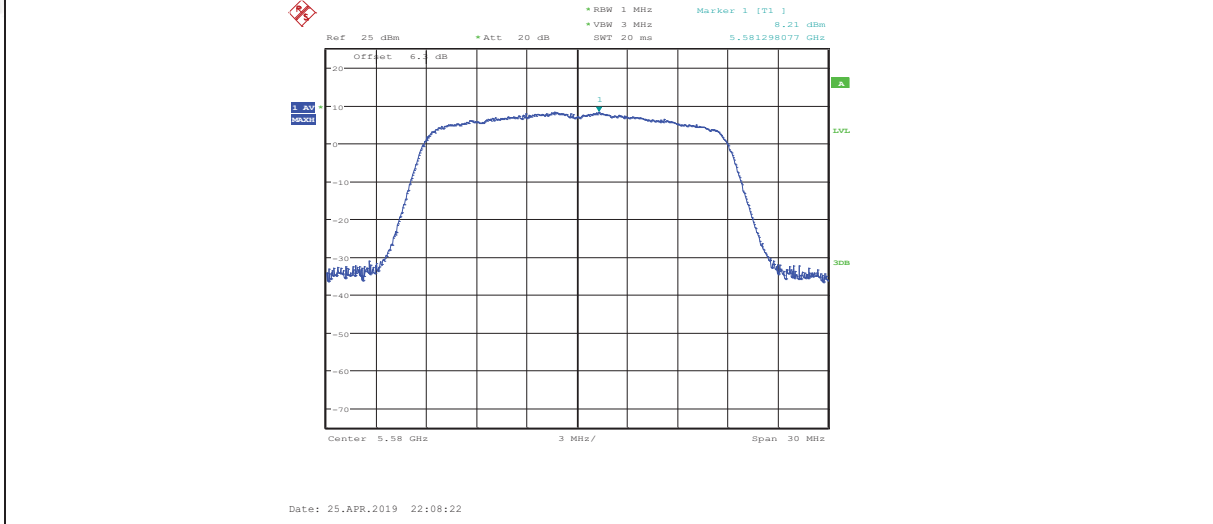

11AC20 ANT2 5580

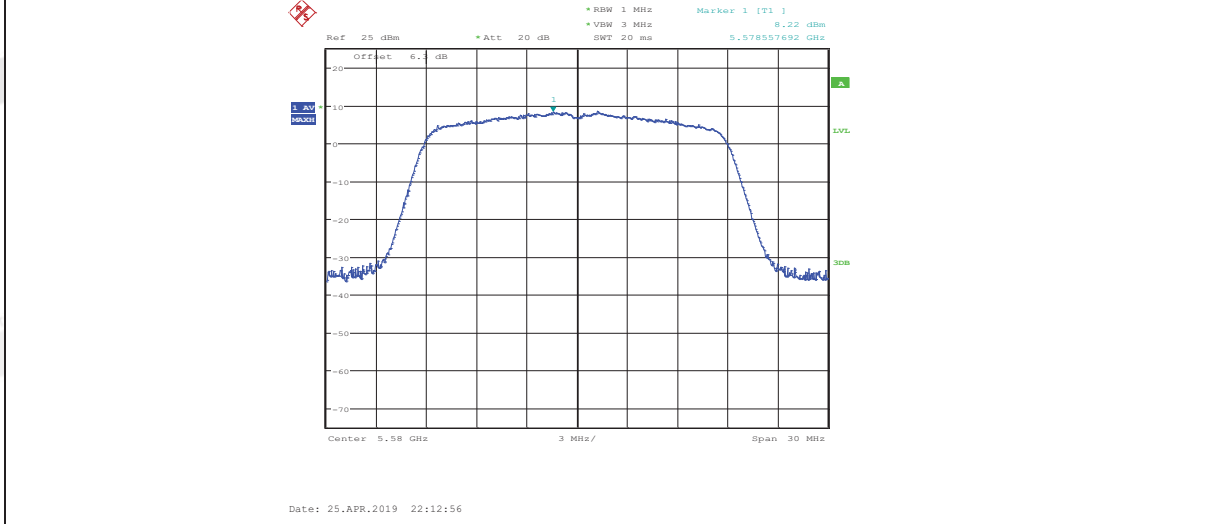

11AC20 ANT1 5700

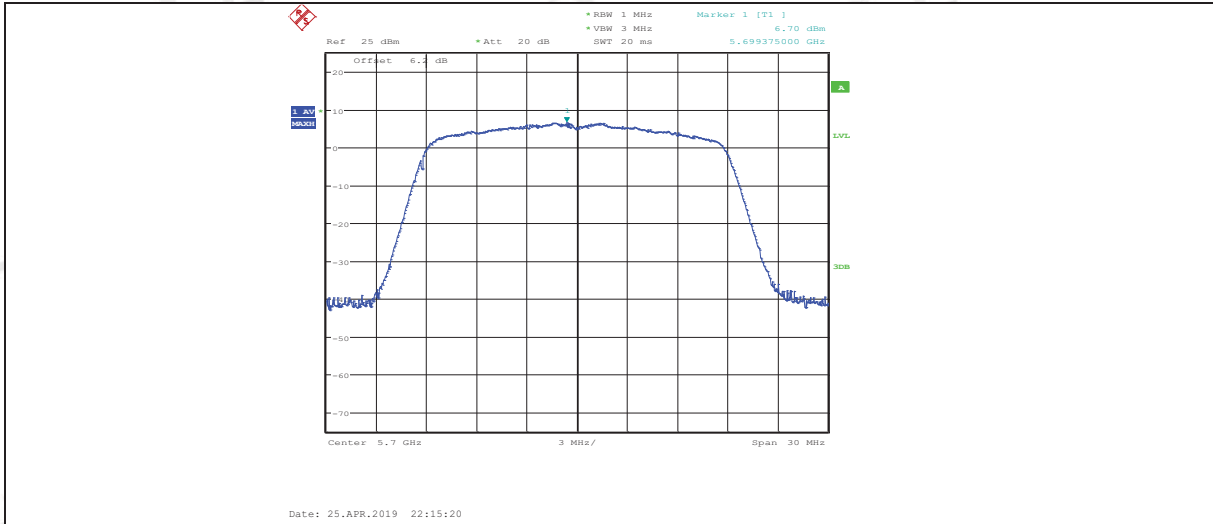

11AC20 ANT2 5700

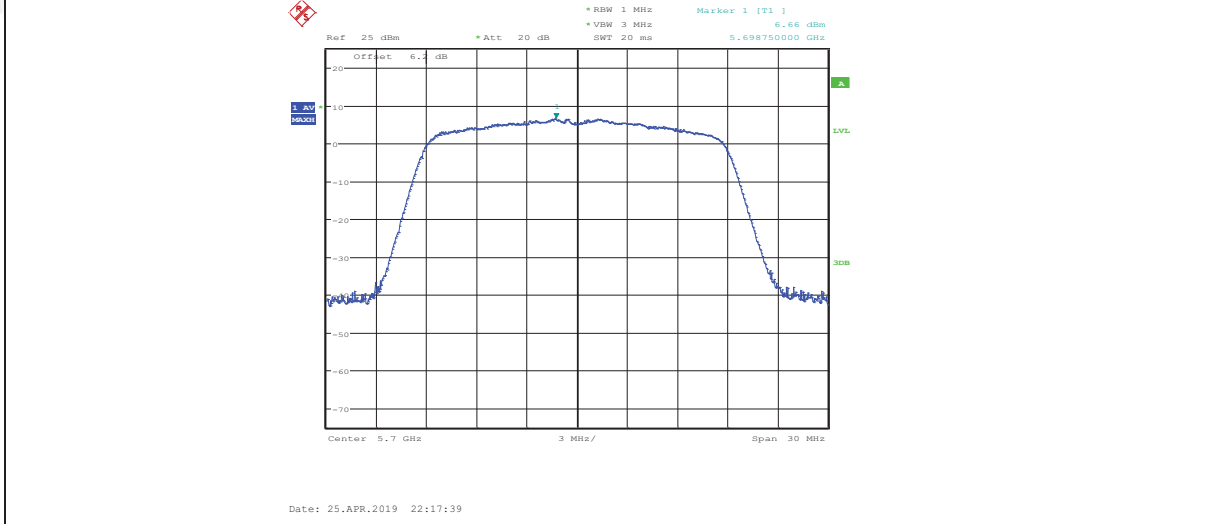

11AC20 ANT1 5745

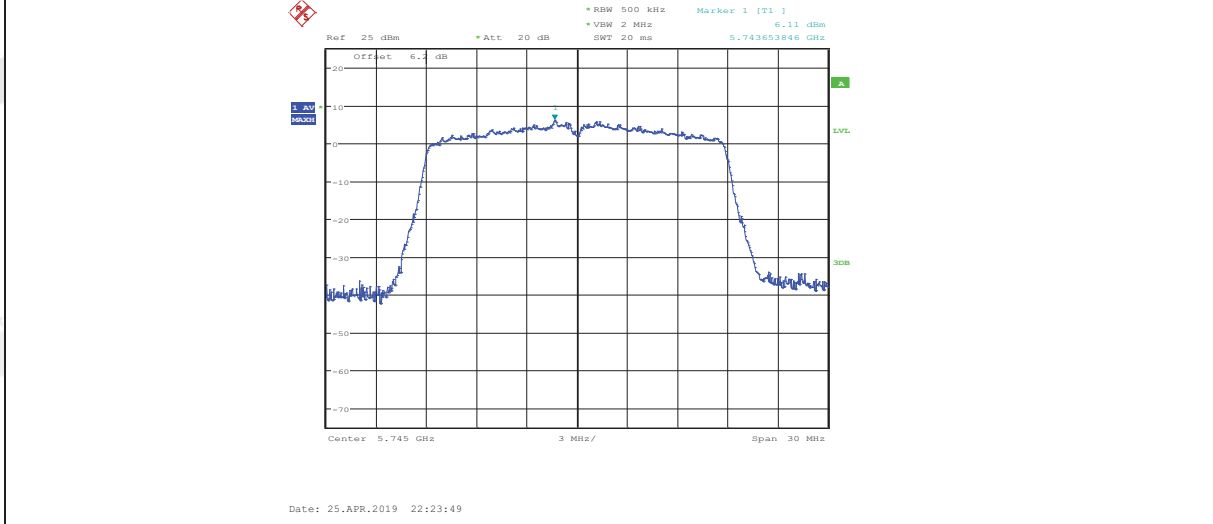

11AC20 ANT2 5745

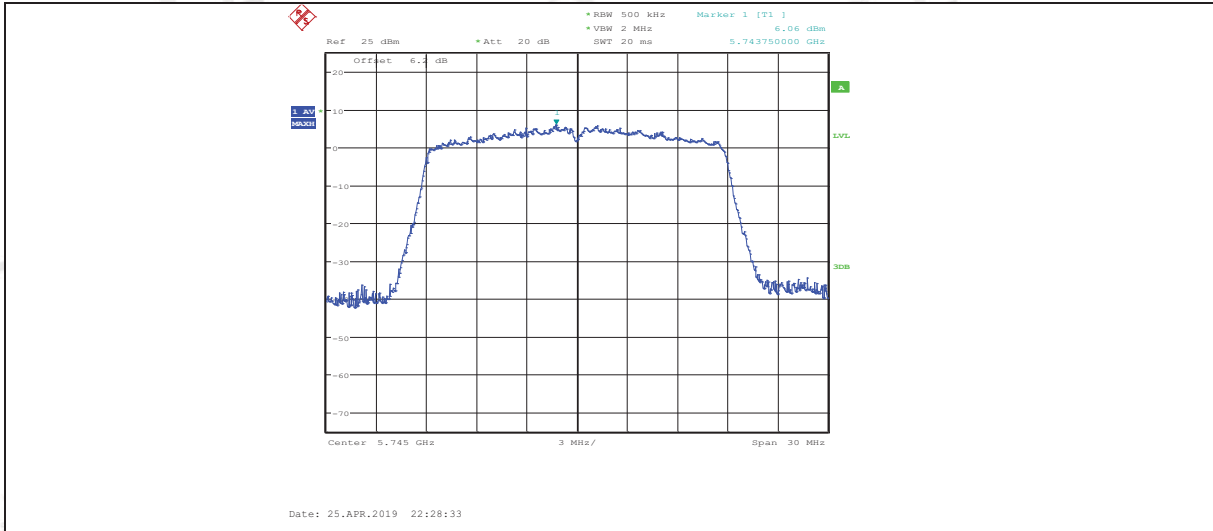

11AC20 ANT1 5785

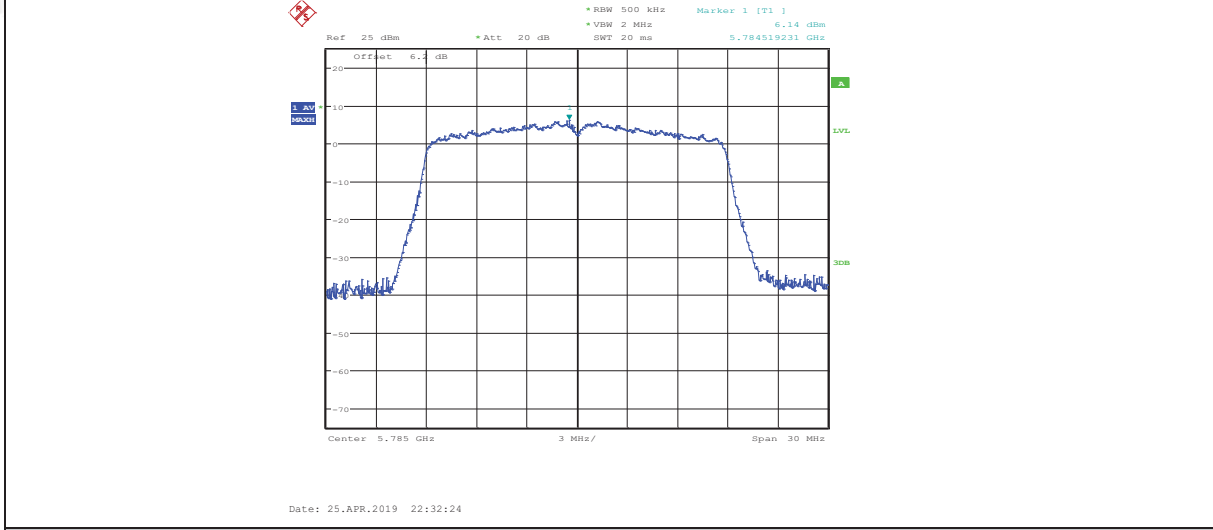

11AC20 ANT2 5785

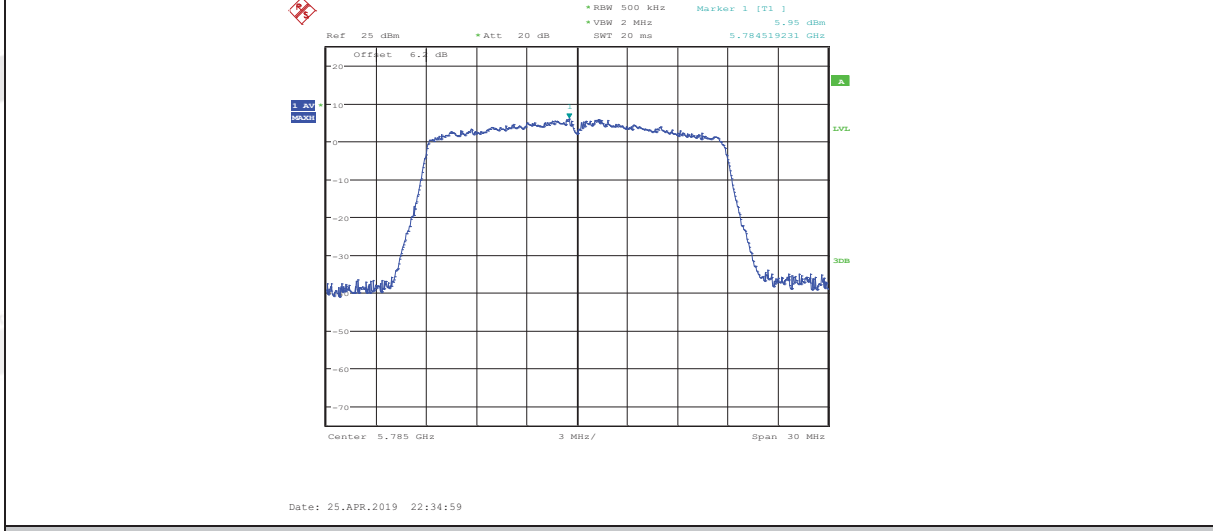

11AC20 ANT1 5825

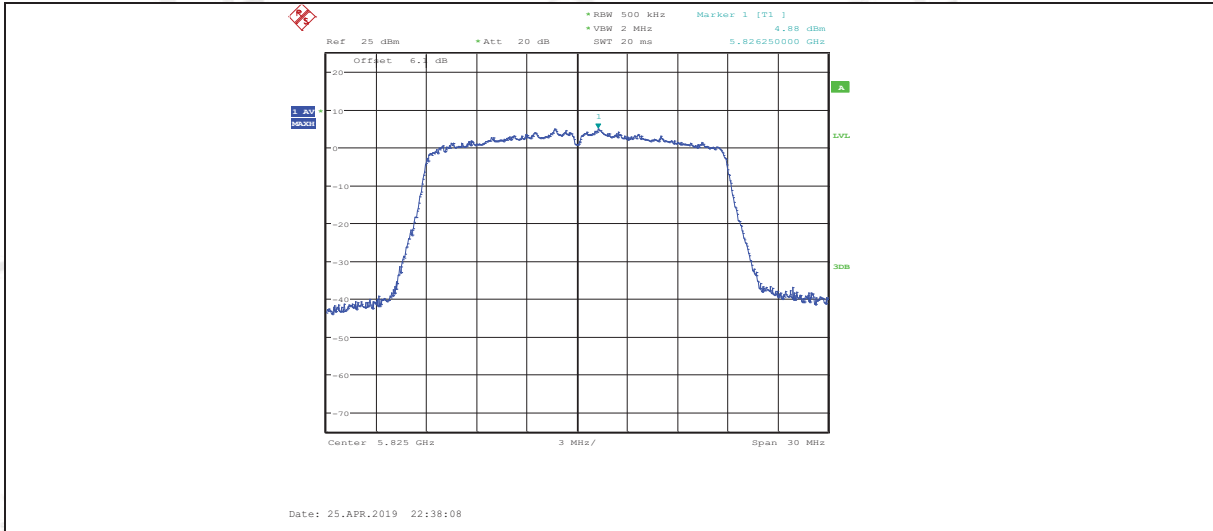

11AC20 ANT2 5825

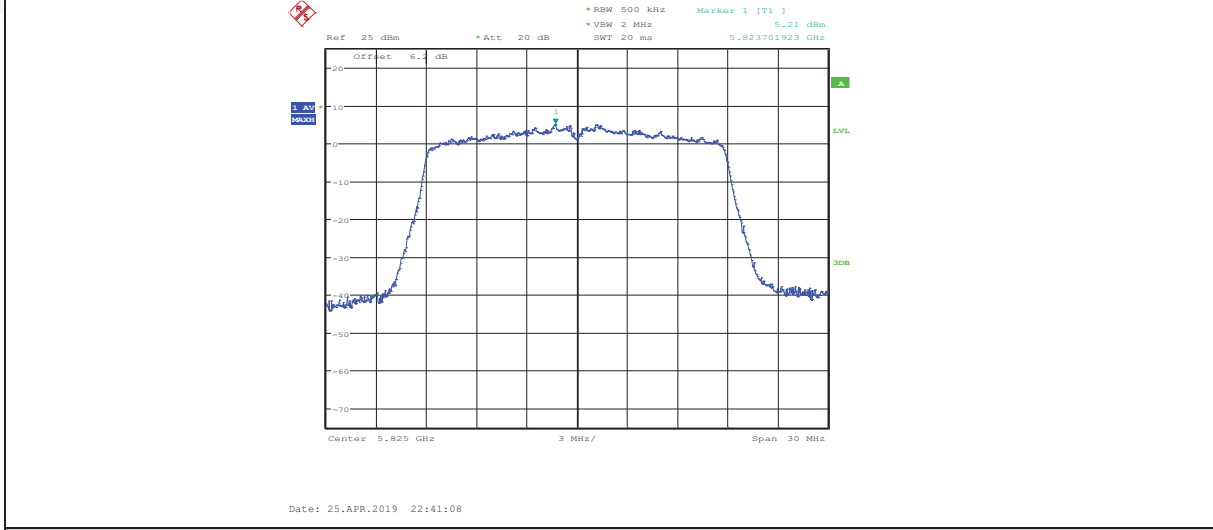

11AC40 ANT1 5190

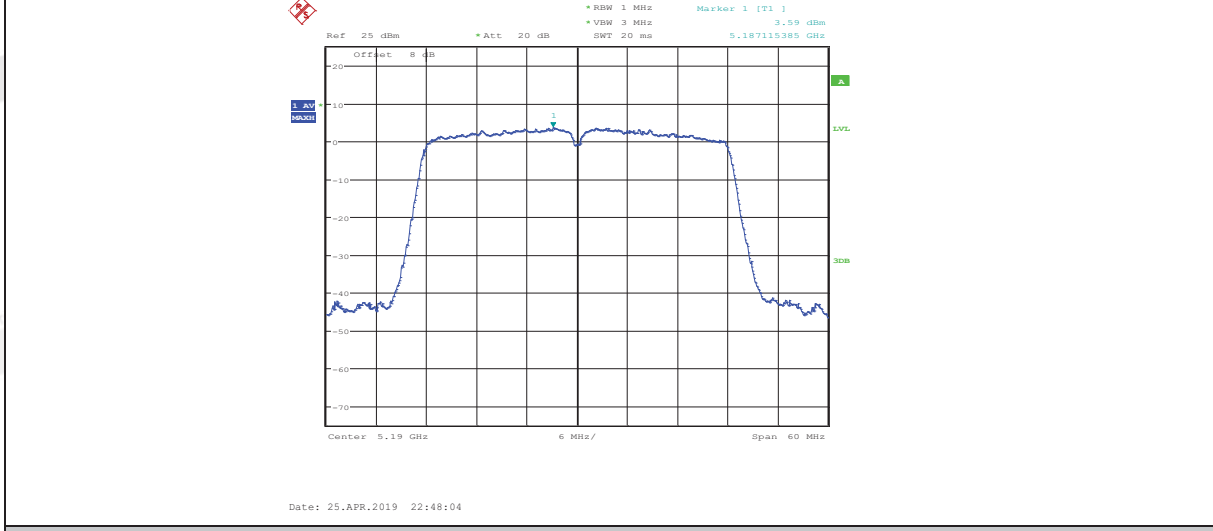

11AC40 ANT2 5190

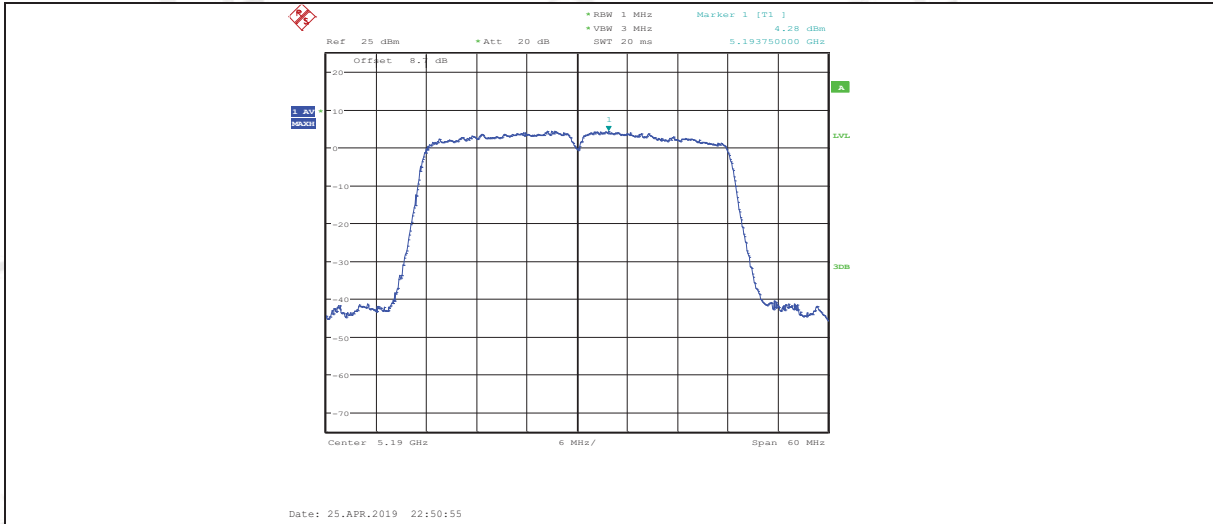

11AC40 ANT1 5230

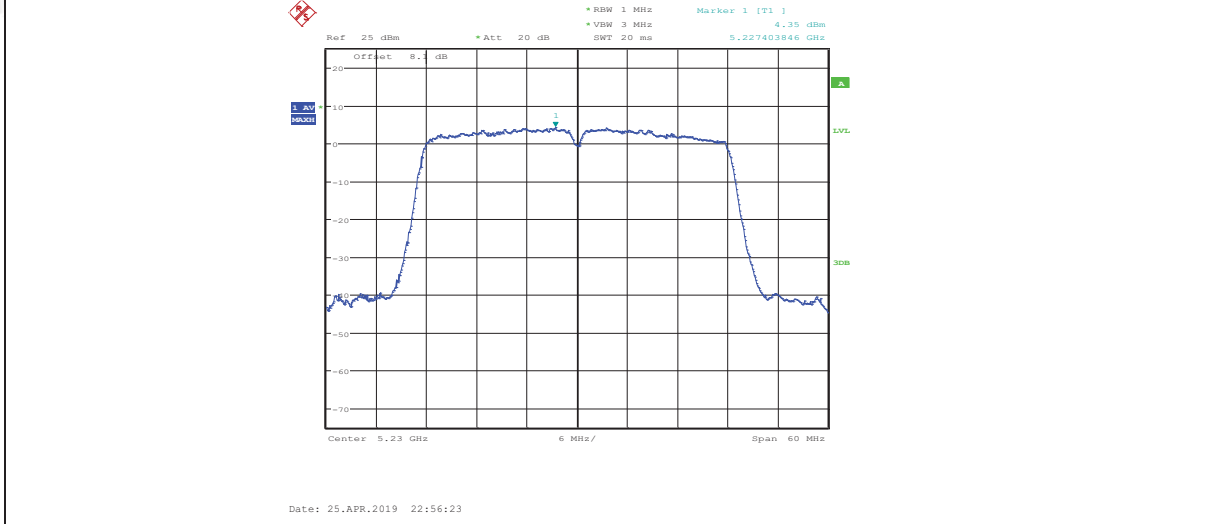

11AC40 ANT2 5230

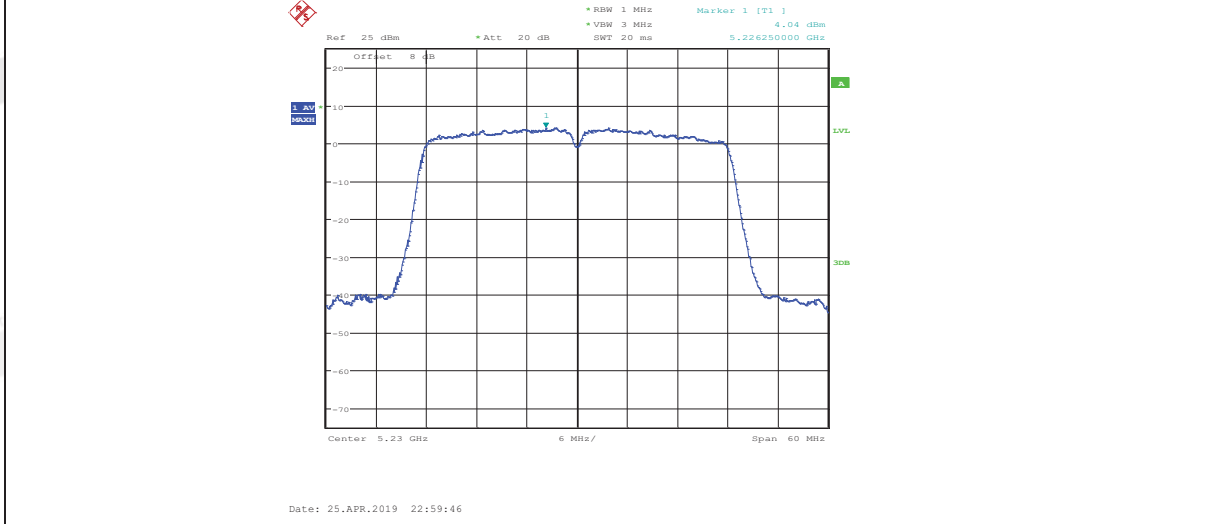

11AC40 ANT1 5270



11AC40 ANT2 5270

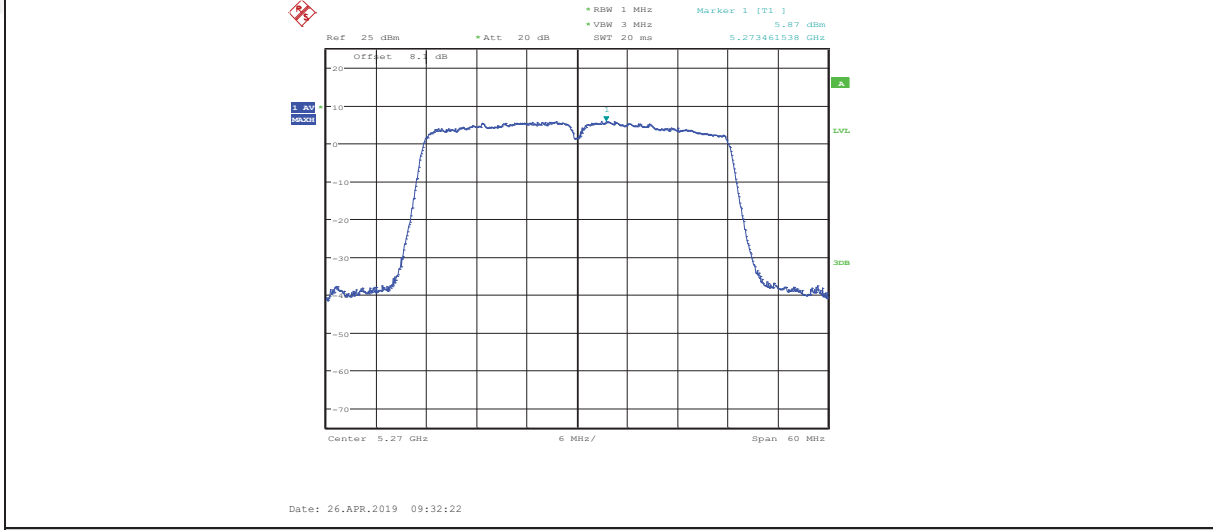

11AC40 ANT1 5310

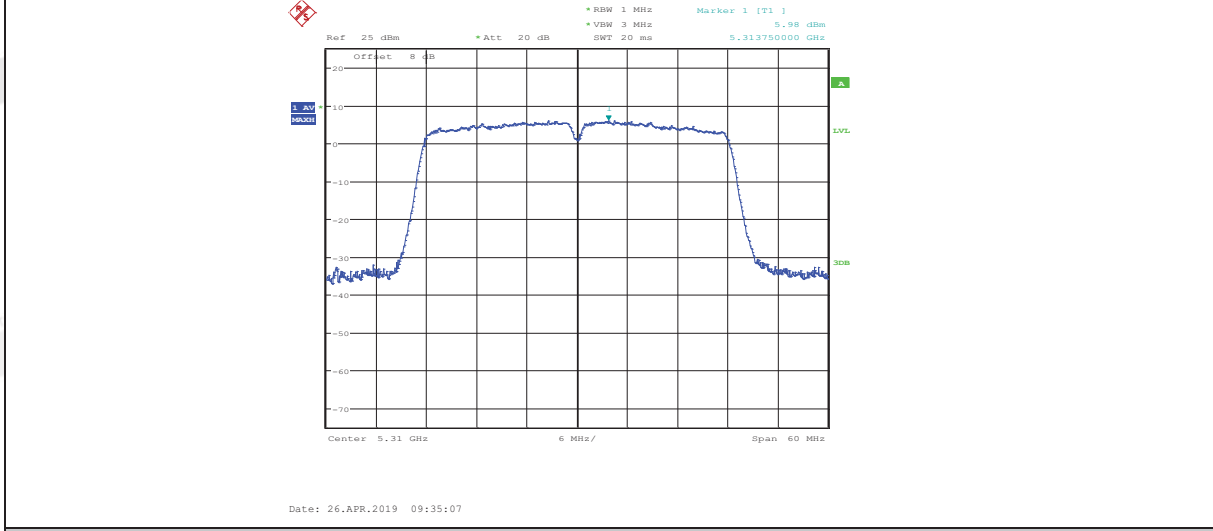

11AC40 ANT2 5310

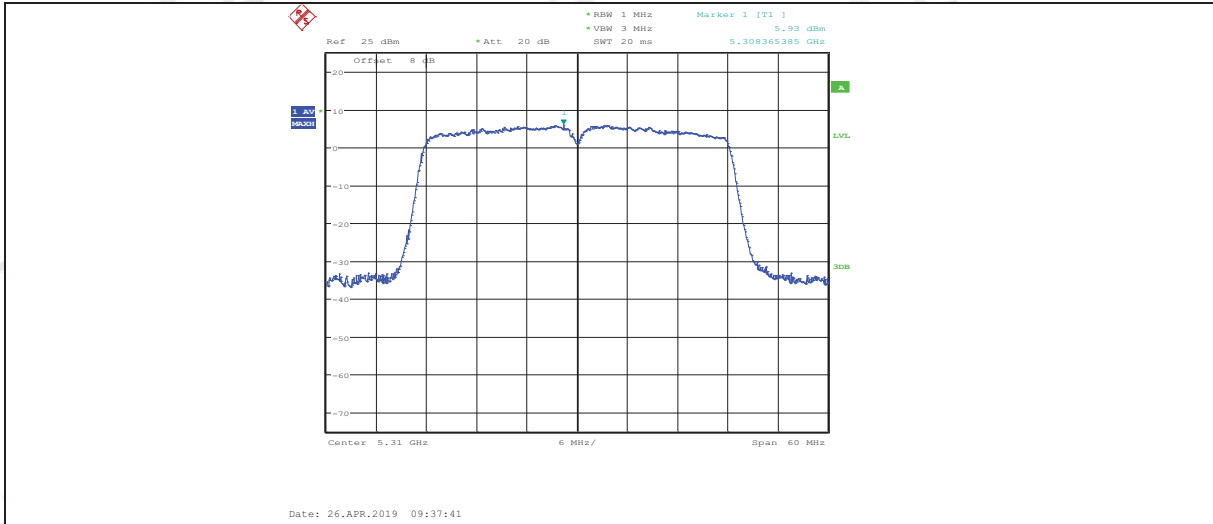

11AC40 ANT1 5510

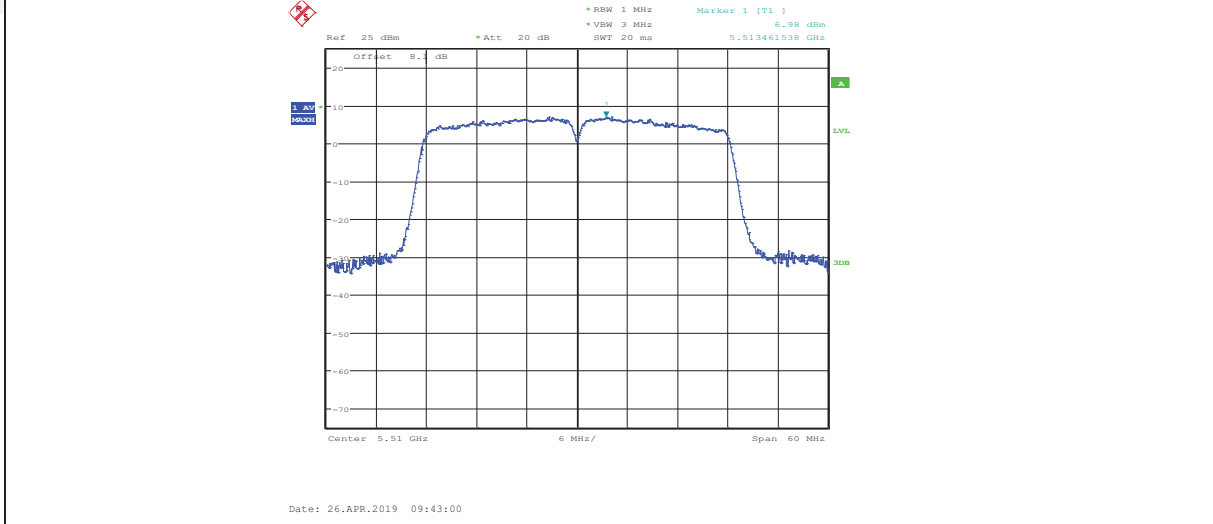

11AC40 ANT2 5510

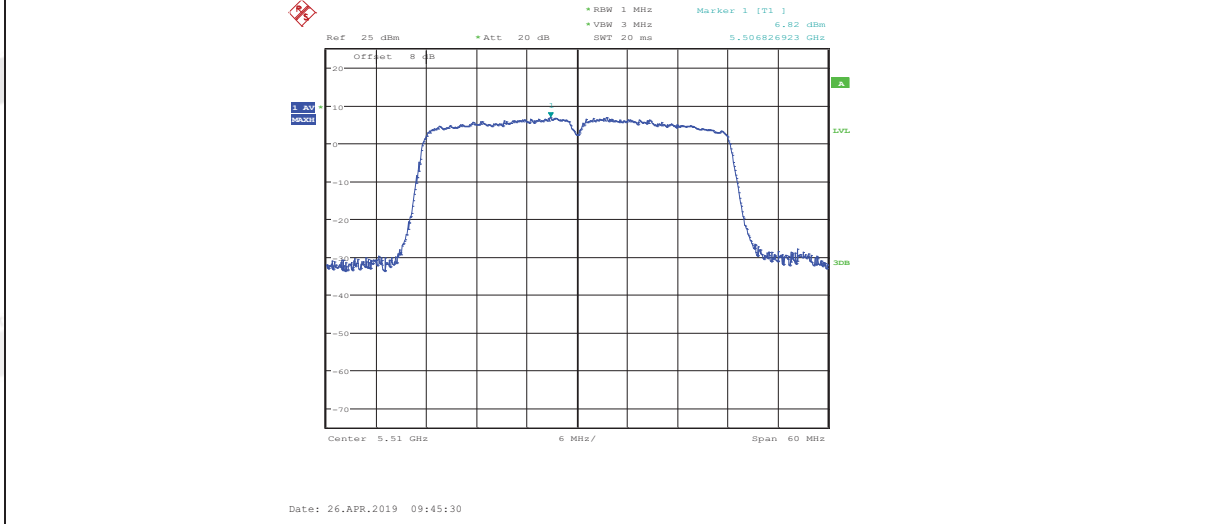

11AC40 ANT1 5550

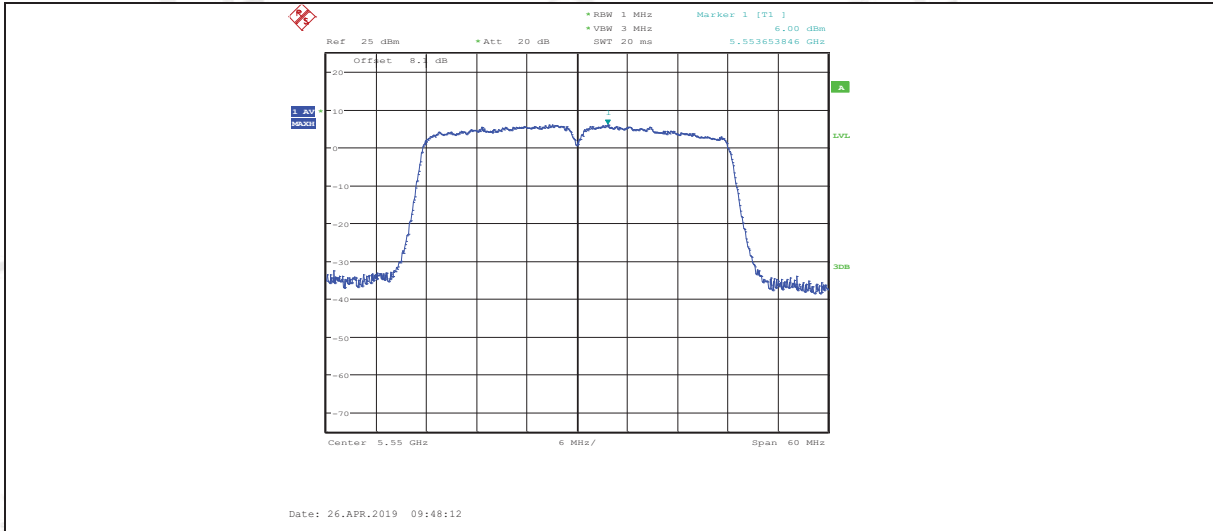

11AC40 ANT2 5550

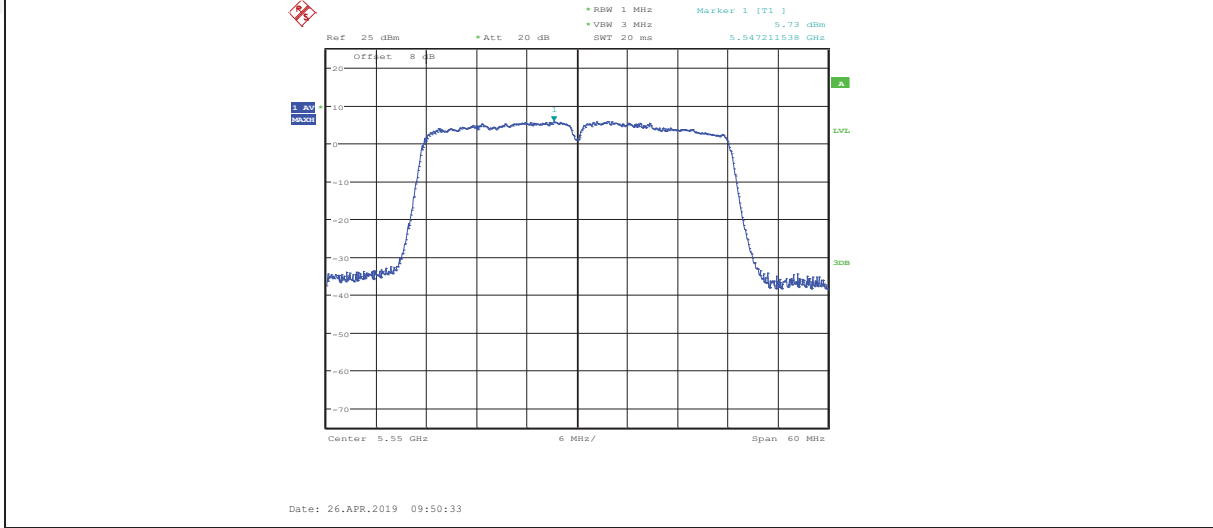

11AC40 ANT1 5670

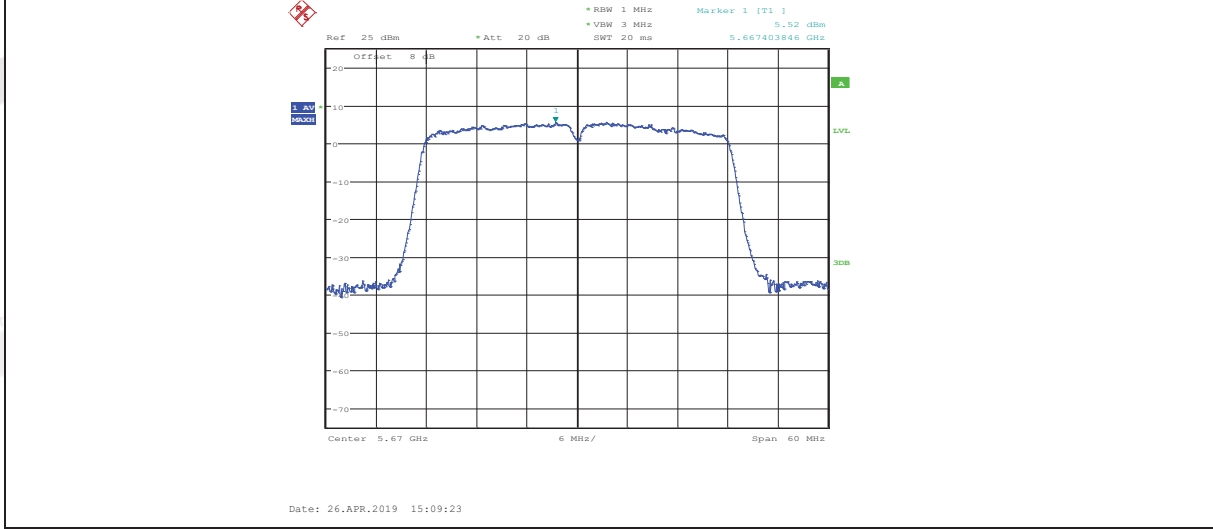

11AC40 ANT2 5670

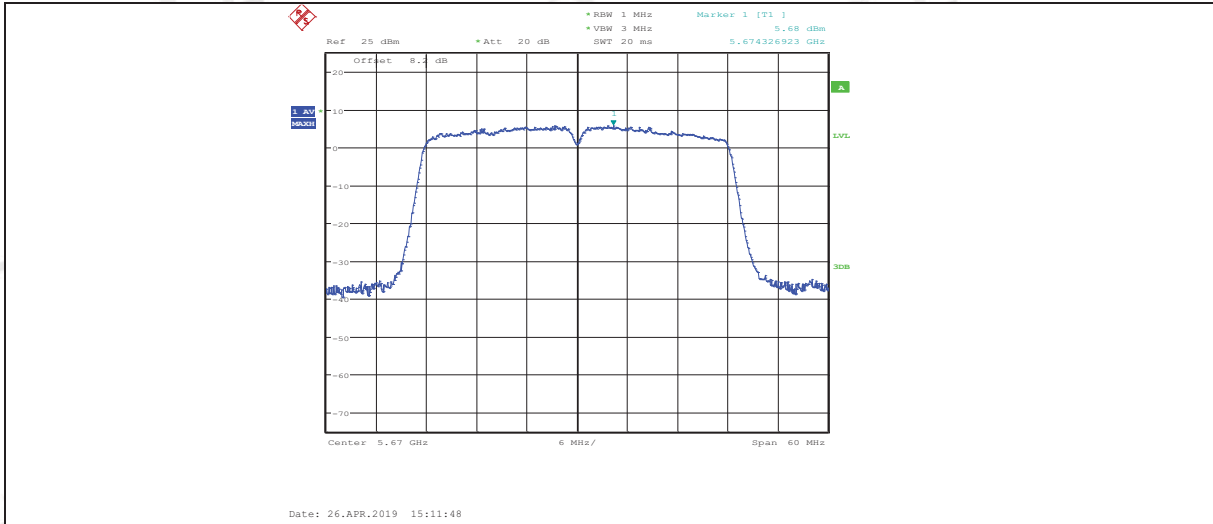

11AC40 ANT1 5755

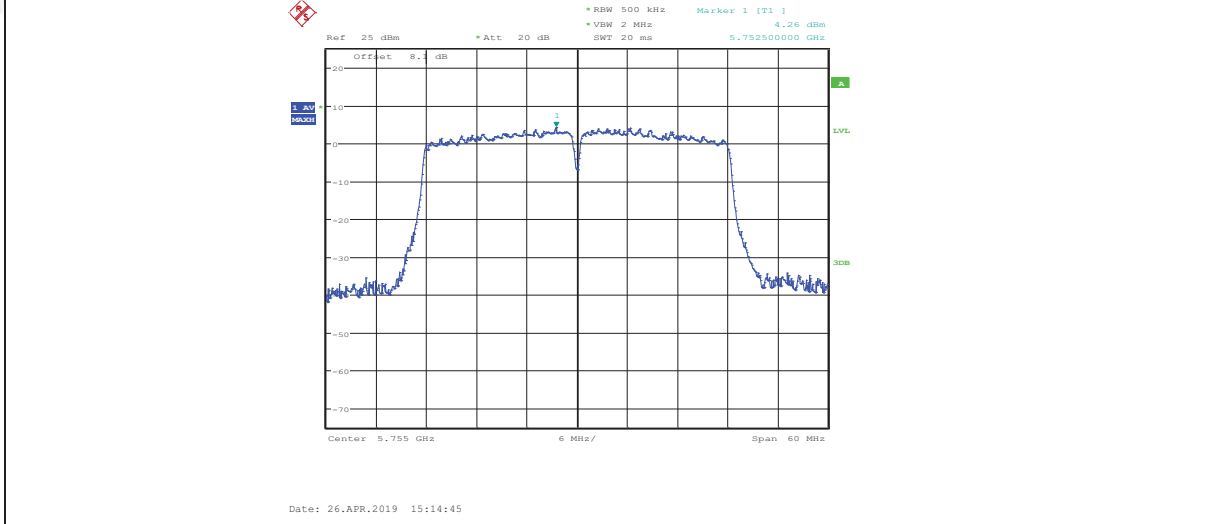

11AC40 ANT2 5755

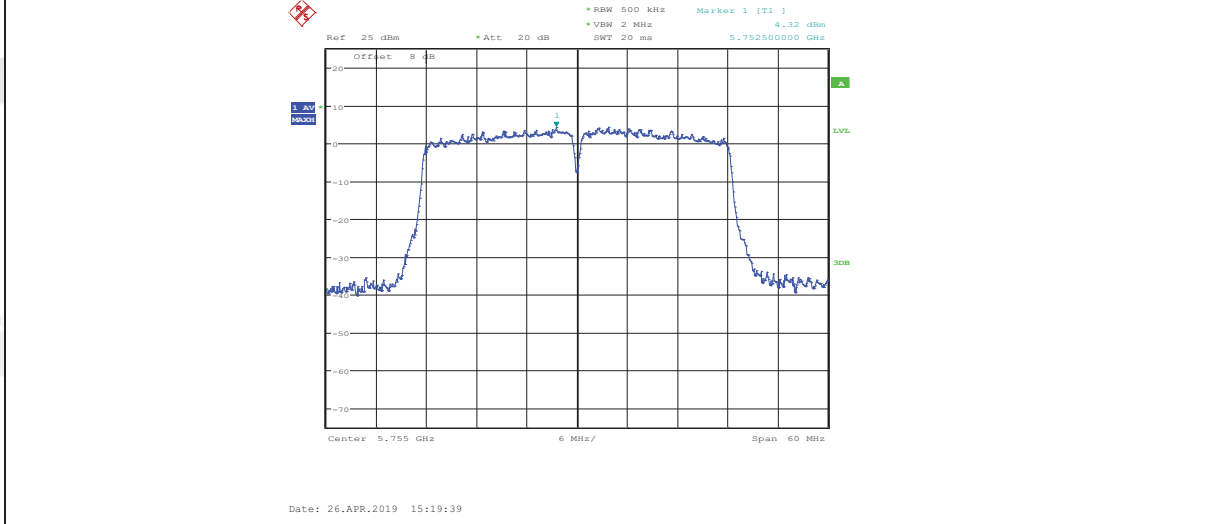

11AC40 ANT1 5795

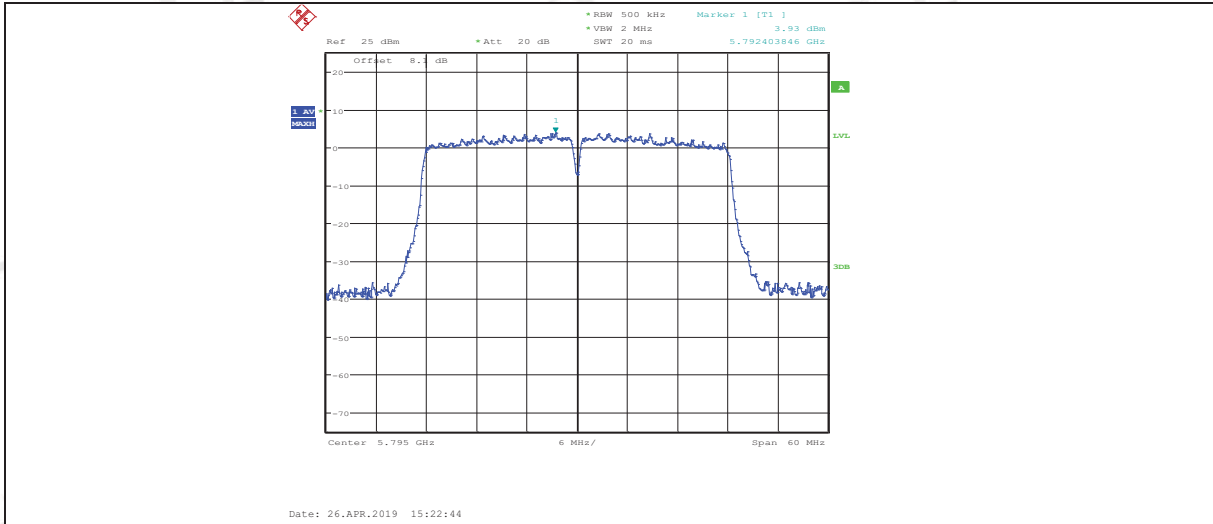

11AC40 ANT2 5795

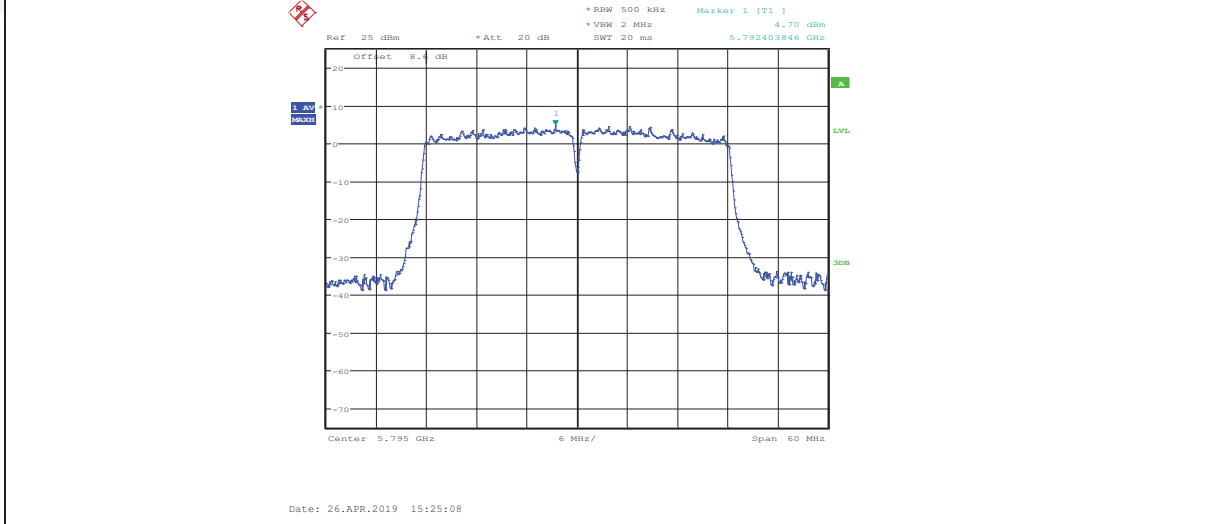

11AC80 ANT1 5210

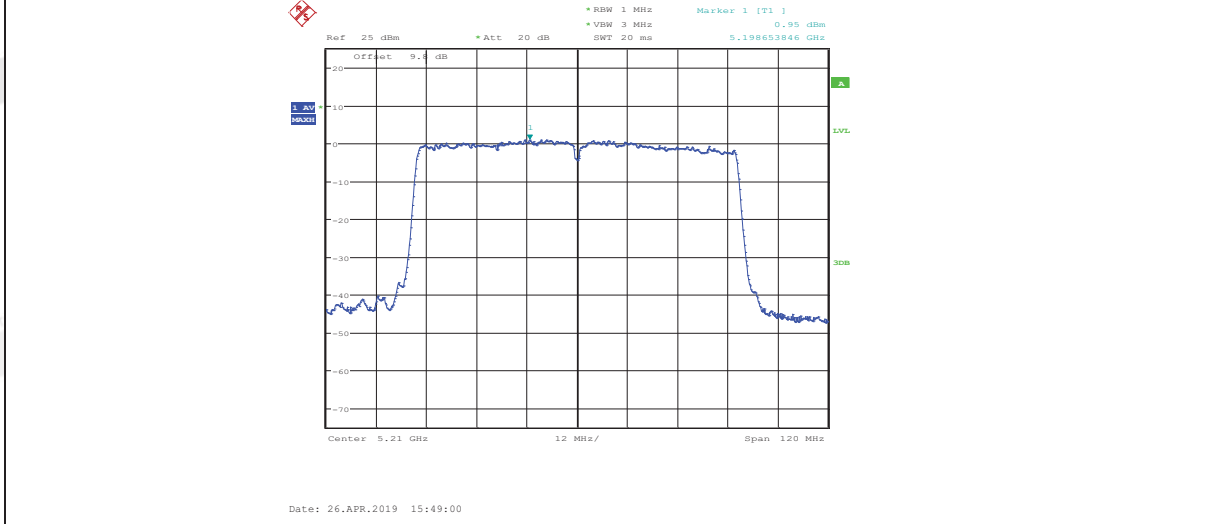

11AC80 ANT2 5210

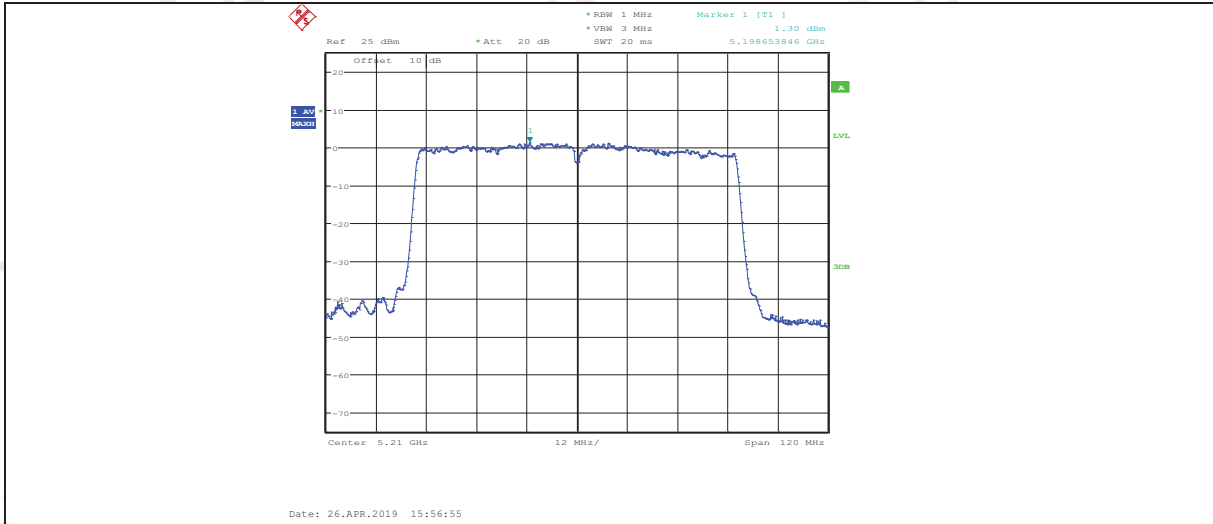

11AC80 ANT1 5290

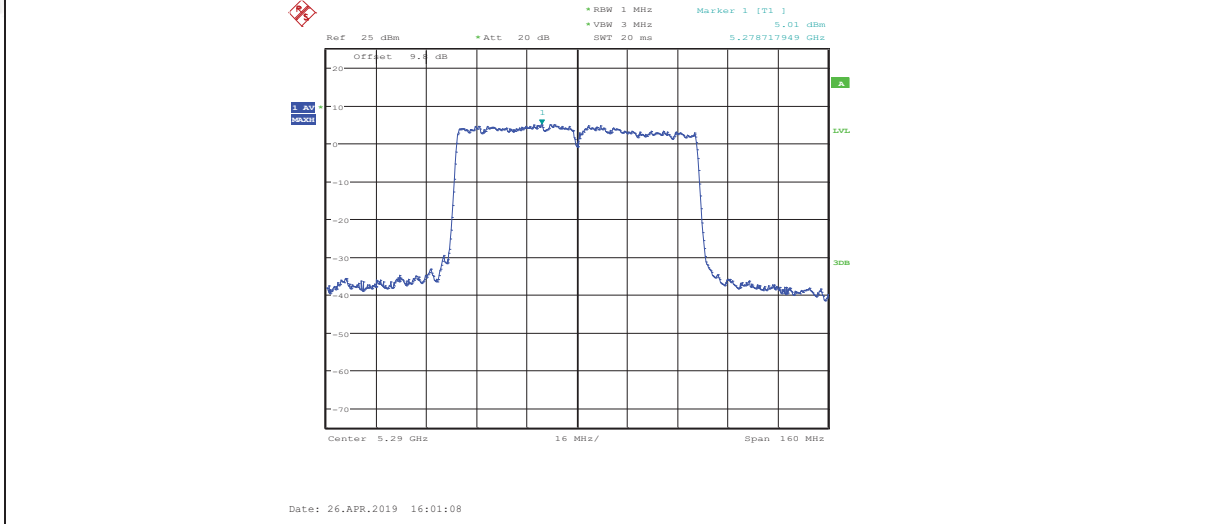

11AC80 ANT2 5290

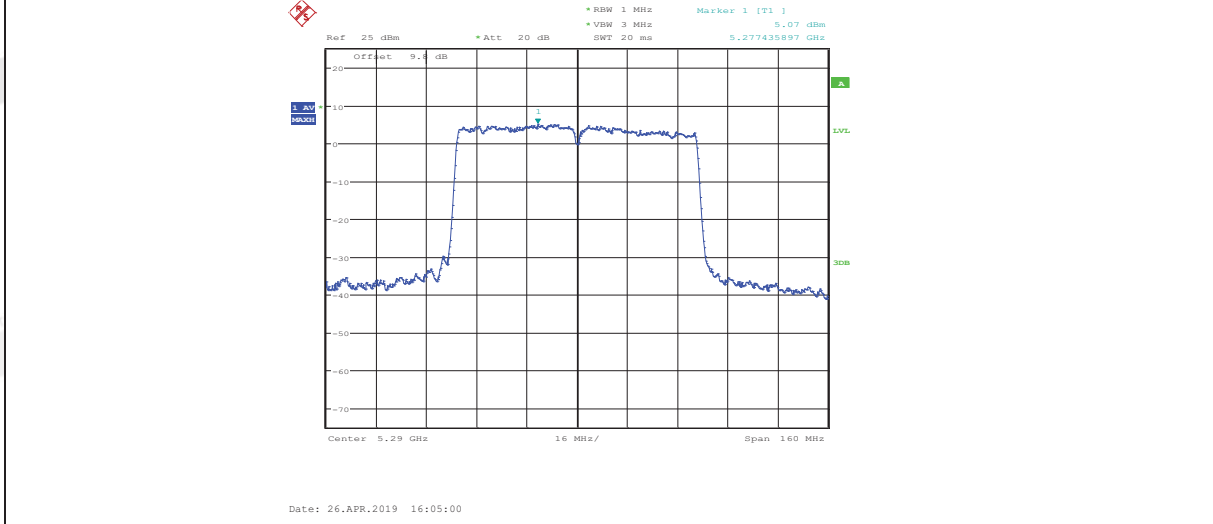

11AC80 ANT1 5530

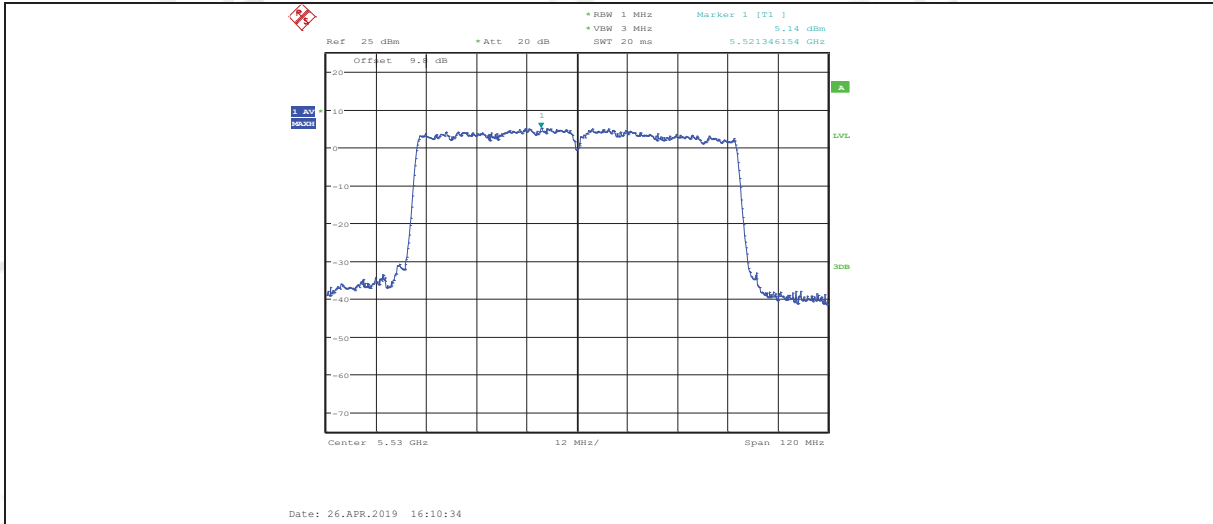

11AC80 ANT2 5530

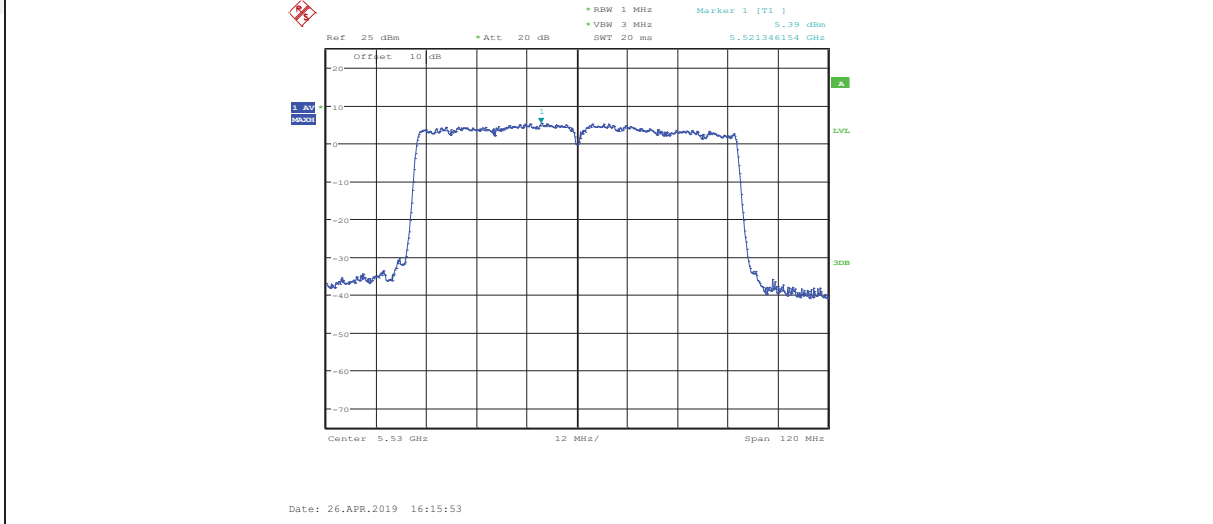

11AC80 ANT1 5775

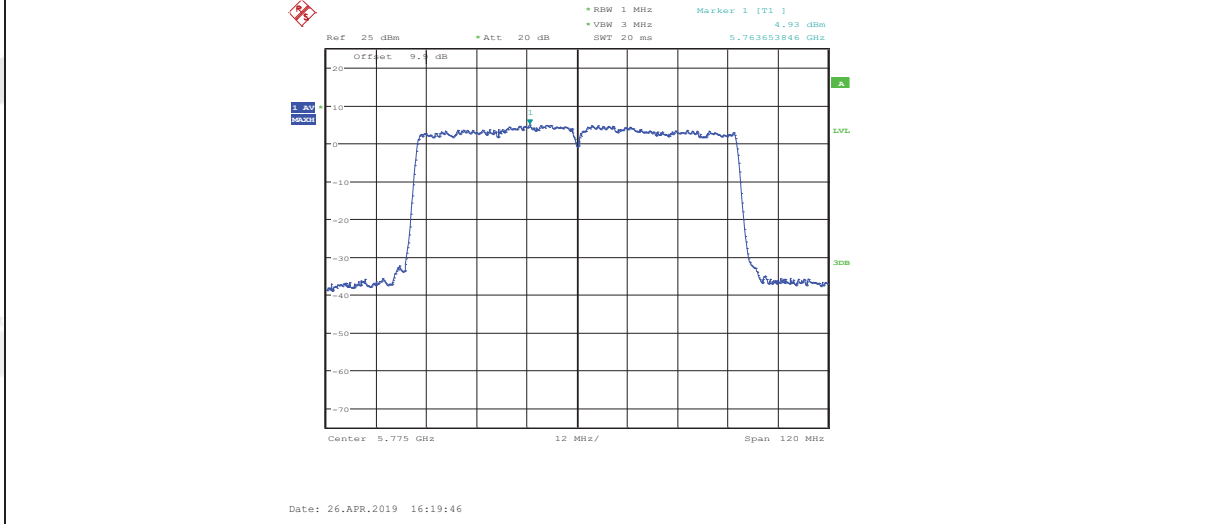

11AC80 ANT2 5775



7. Frequency Stability Measurement

7.1. Limit of Frequency Stability

Manufacturers of U-NII devices are responsible for ensuring frequency stability such that an emission is maintained within the band of operation under all conditions of normal operation as specified in the user's manual.

7.2. Measuring Instruments

The measuring equipment is listed in the section 4 of this test report.

7.3. Test Procedures

(1) To ensure emission at the band edge is maintained within the authorized band, those values shall be measured by radiation emissions at upper and lower frequency points, and finally compensated by frequency deviation as procedures below.

(2) The EUT was operated at the maximum output power, and connected to the spectrum analyzer, which is set to maximum hold function and peak detector. The peak value of the power envelope was measured and noted. The upper and lower frequency points were respectively measured relatively 10 dB lower than the measured peak value.

(3) The frequency deviation was calculated by adding the upper frequency point and the lower frequency point divided by two. Those detailed values of frequency deviation are provided in table below.

7.4. Test Setup

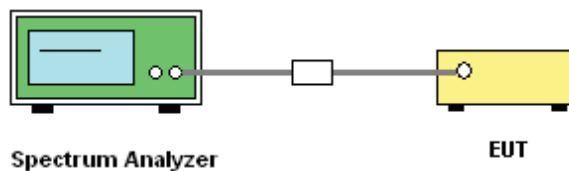

7.5. Test Result

Voltage								
Test Mode	Antenna	Channel	Voltage [Vdc]	Temperature (°C)	Deviation (kHz)	Deviation (ppm)	Limit (ppm)	Verdict
11A	ANT1	5180	NV	NT	0	0	20	PASS
11A	ANT1	5180	LV	NT	0	0	20	PASS
11A	ANT1	5180	HV	NT	-80	-15.444015	20	PASS
11A	ANT2	5180	NV	NT	0	0	20	PASS
11A	ANT2	5180	LV	NT	0	0	20	PASS
11A	ANT2	5180	HV	NT	-80	-15.444015	20	PASS
11A	ANT1	5200	NV	NT	-80	-15.384615	20	PASS
11A	ANT1	5200	LV	NT	0	0	20	PASS
11A	ANT1	5200	HV	NT	-80	-15.384615	20	PASS
11A	ANT2	5200	NV	NT	-80	-15.384615	20	PASS
11A	ANT2	5200	LV	NT	-80	-15.384615	20	PASS

11A	ANT2	5200	HV	NT	-80	-15.384615	20	PASS
11A	ANT1	5240	NV	NT	-80	-15.267176	20	PASS
11A	ANT1	5240	LV	NT	-80	-15.267176	20	PASS
11A	ANT1	5240	HV	NT	-80	-15.267176	20	PASS
11A	ANT2	5240	NV	NT	-80	-15.267176	20	PASS
11A	ANT2	5240	LV	NT	-80	-15.267176	20	PASS
11A	ANT2	5240	HV	NT	-80	-15.267176	20	PASS
11A	ANT1	5260	NV	NT	-80	-15.209125	20	PASS
11A	ANT1	5260	LV	NT	-80	-15.209125	20	PASS
11A	ANT1	5260	HV	NT	-80	-15.209125	20	PASS
11A	ANT2	5260	NV	NT	-80	-15.209125	20	PASS
11A	ANT2	5260	LV	NT	-80	-15.209125	20	PASS
11A	ANT2	5260	HV	NT	-80	-15.209125	20	PASS
11A	ANT1	5280	NV	NT	-80	-15.151515	20	PASS
11A	ANT1	5280	LV	NT	-80	-15.151515	20	PASS
11A	ANT1	5280	HV	NT	-80	-15.151515	20	PASS
11A	ANT2	5280	NV	NT	-80	-15.151515	20	PASS
11A	ANT2	5280	LV	NT	-80	-15.151515	20	PASS
11A	ANT2	5280	HV	NT	-80	-15.151515	20	PASS
11A	ANT1	5320	NV	NT	-80	-15.037594	20	PASS
11A	ANT1	5320	LV	NT	-80	-15.037594	20	PASS
11A	ANT1	5320	HV	NT	-80	-15.037594	20	PASS
11A	ANT2	5320	NV	NT	-80	-15.037594	20	PASS
11A	ANT2	5320	LV	NT	-80	-15.037594	20	PASS
11A	ANT2	5320	HV	NT	-80	-15.037594	20	PASS
11A	ANT1	5500	NV	NT	-80	-14.545455	20	PASS
11A	ANT1	5500	LV	NT	-80	-14.545455	20	PASS
11A	ANT1	5500	HV	NT	0	0	20	PASS
11A	ANT2	5500	NV	NT	0	0	20	PASS
11A	ANT2	5500	LV	NT	0	0	20	PASS
11A	ANT2	5500	HV	NT	-80	-14.545455	20	PASS
11A	ANT1	5580	NV	NT	-80	-14.336918	20	PASS
11A	ANT1	5580	LV	NT	-80	-14.336918	20	PASS
11A	ANT1	5580	HV	NT	-80	-14.336918	20	PASS
11A	ANT2	5580	NV	NT	-80	-14.336918	20	PASS
11A	ANT2	5580	LV	NT	-80	-14.336918	20	PASS
11A	ANT2	5580	HV	NT	0	0	20	PASS
11A	ANT1	5700	NV	NT	-80	-14.035088	20	PASS
11A	ANT1	5700	LV	NT	-80	-14.035088	20	PASS

11A	ANT1	5700	HV	NT	-80	-14.035088	20	PASS
11A	ANT2	5700	NV	NT	-80	-14.035088	20	PASS
11A	ANT2	5700	LV	NT	-80	-14.035088	20	PASS
11A	ANT2	5700	HV	NT	-80	-14.035088	20	PASS
11A	ANT1	5745	NV	NT	-80	-13.925152	20	PASS
11A	ANT1	5745	LV	NT	-80	-13.925152	20	PASS
11A	ANT1	5745	HV	NT	-80	-13.925152	20	PASS
11A	ANT2	5745	NV	NT	0	0	20	PASS
11A	ANT2	5745	LV	NT	-80	-13.925152	20	PASS
11A	ANT2	5745	HV	NT	-80	-13.925152	20	PASS
11A	ANT1	5785	NV	NT	-80	-13.828868	20	PASS
11A	ANT1	5785	LV	NT	0	0	20	PASS
11A	ANT1	5785	HV	NT	-80	-13.828868	20	PASS
11A	ANT2	5785	NV	NT	-80	-13.828868	20	PASS
11A	ANT2	5785	LV	NT	-80	-13.828868	20	PASS
11A	ANT2	5785	HV	NT	-80	-13.828868	20	PASS
11A	ANT1	5825	NV	NT	0	0	20	PASS
11A	ANT1	5825	LV	NT	0	0	20	PASS
11A	ANT1	5825	HV	NT	-80	-13.733906	20	PASS
11A	ANT2	5825	NV	NT	-80	-13.733906	20	PASS
11A	ANT2	5825	LV	NT	-80	-13.733906	20	PASS
11A	ANT2	5825	HV	NT	-80	-13.733906	20	PASS
11N20	ANT1	5180	NV	NT	0	0	20	PASS
11N20	ANT1	5180	LV	NT	0	0	20	PASS
11N20	ANT1	5180	HV	NT	0	0	20	PASS
11N20	ANT2	5180	NV	NT	0	0	20	PASS
11N20	ANT2	5180	LV	NT	0	0	20	PASS
11N20	ANT2	5180	HV	NT	0	0	20	PASS
11N20	ANT1	5200	NV	NT	0	0	20	PASS
11N20	ANT1	5200	LV	NT	0	0	20	PASS
11N20	ANT1	5200	HV	NT	0	0	20	PASS
11N20	ANT2	5200	NV	NT	0	0	20	PASS
11N20	ANT2	5200	LV	NT	0	0	20	PASS
11N20	ANT2	5200	HV	NT	0	0	20	PASS
11N20	ANT1	5240	NV	NT	0	0	20	PASS
11N20	ANT1	5240	LV	NT	0	0	20	PASS
11N20	ANT1	5240	HV	NT	0	0	20	PASS
11N20	ANT2	5240	NV	NT	0	0	20	PASS
11N20	ANT2	5240	LV	NT	0	0	20	PASS

11N20	ANT2	5240	HV	NT	0	0	20	PASS
11N20	ANT1	5260	NV	NT	0	0	20	PASS
11N20	ANT1	5260	LV	NT	0	0	20	PASS
11N20	ANT1	5260	HV	NT	0	0	20	PASS
11N20	ANT2	5260	NV	NT	0	0	20	PASS
11N20	ANT2	5260	LV	NT	0	0	20	PASS
11N20	ANT2	5260	HV	NT	0	0	20	PASS
11N20	ANT1	5280	NV	NT	0	0	20	PASS
11N20	ANT1	5280	LV	NT	0	0	20	PASS
11N20	ANT1	5280	HV	NT	0	0	20	PASS
11N20	ANT2	5280	NV	NT	0	0	20	PASS
11N20	ANT2	5280	LV	NT	0	0	20	PASS
11N20	ANT2	5280	HV	NT	0	0	20	PASS
11N20	ANT1	5320	NV	NT	0	0	20	PASS
11N20	ANT1	5320	LV	NT	0	0	20	PASS
11N20	ANT1	5320	HV	NT	0	0	20	PASS
11N20	ANT2	5320	NV	NT	0	0	20	PASS
11N20	ANT2	5320	LV	NT	0	0	20	PASS
11N20	ANT2	5320	HV	NT	0	0	20	PASS
11N20	ANT1	5500	NV	NT	0	0	20	PASS
11N20	ANT1	5500	LV	NT	0	0	20	PASS
11N20	ANT1	5500	HV	NT	0	0	20	PASS
11N20	ANT2	5500	NV	NT	0	0	20	PASS
11N20	ANT2	5500	LV	NT	0	0	20	PASS
11N20	ANT2	5500	HV	NT	0	0	20	PASS
11N20	ANT1	5580	NV	NT	0	0	20	PASS
11N20	ANT1	5580	LV	NT	0	0	20	PASS
11N20	ANT1	5580	HV	NT	0	0	20	PASS
11N20	ANT2	5580	NV	NT	0	0	20	PASS
11N20	ANT2	5580	LV	NT	0	0	20	PASS
11N20	ANT2	5580	HV	NT	0	0	20	PASS
11N20	ANT1	5700	NV	NT	0	0	20	PASS
11N20	ANT1	5700	LV	NT	0	0	20	PASS
11N20	ANT1	5700	HV	NT	0	0	20	PASS
11N20	ANT2	5700	NV	NT	-80	-14.035088	20	PASS
11N20	ANT2	5700	LV	NT	0	0	20	PASS
11N20	ANT2	5700	HV	NT	0	0	20	PASS
11N20	ANT1	5745	NV	NT	0	0	20	PASS
11N20	ANT1	5745	LV	NT	0	0	20	PASS

11N20	ANT1	5745	HV	NT	0	0	20	PASS
11N20	ANT2	5745	NV	NT	0	0	20	PASS
11N20	ANT2	5745	LV	NT	0	0	20	PASS
11N20	ANT2	5745	HV	NT	0	0	20	PASS
11N20	ANT1	5785	NV	NT	0	0	20	PASS
11N20	ANT1	5785	LV	NT	0	0	20	PASS
11N20	ANT1	5785	HV	NT	0	0	20	PASS
11N20	ANT2	5785	NV	NT	0	0	20	PASS
11N20	ANT2	5785	LV	NT	0	0	20	PASS
11N20	ANT2	5785	HV	NT	0	0	20	PASS
11N20	ANT1	5825	NV	NT	0	0	20	PASS
11N20	ANT1	5825	LV	NT	0	0	20	PASS
11N20	ANT1	5825	HV	NT	0	0	20	PASS
11N20	ANT2	5825	NV	NT	0	0	20	PASS
11N20	ANT2	5825	LV	NT	0	0	20	PASS
11N20	ANT2	5825	HV	NT	0	0	20	PASS
11N40	ANT1	5190	NV	NT	-80	-15.414258	20	PASS
11N40	ANT1	5190	LV	NT	0	0	20	PASS
11N40	ANT1	5190	HV	NT	0	0	20	PASS
11N40	ANT2	5190	NV	NT	-80	-15.414258	20	PASS
11N40	ANT2	5190	LV	NT	-80	-15.414258	20	PASS
11N40	ANT2	5190	HV	NT	-80	-15.414258	20	PASS
11N40	ANT1	5230	NV	NT	0	0	20	PASS
11N40	ANT1	5230	LV	NT	-80	-15.296367	20	PASS
11N40	ANT1	5230	HV	NT	-80	-15.296367	20	PASS
11N40	ANT2	5230	NV	NT	-80	-15.296367	20	PASS
11N40	ANT2	5230	LV	NT	0	0	20	PASS
11N40	ANT2	5230	HV	NT	-80	-15.296367	20	PASS
11N40	ANT1	5270	NV	NT	-80	-15.180266	20	PASS
11N40	ANT1	5270	LV	NT	0	0	20	PASS
11N40	ANT1	5270	HV	NT	-80	-15.180266	20	PASS
11N40	ANT2	5270	NV	NT	-80	-15.180266	20	PASS
11N40	ANT2	5270	LV	NT	0	0	20	PASS
11N40	ANT2	5270	HV	NT	-80	-15.180266	20	PASS
11N40	ANT1	5310	NV	NT	0	0	20	PASS
11N40	ANT1	5310	LV	NT	0	0	20	PASS
11N40	ANT1	5310	HV	NT	0	0	20	PASS
11N40	ANT2	5310	NV	NT	0	0	20	PASS
11N40	ANT2	5310	LV	NT	-80	-15.065913	20	PASS

11N40	ANT2	5310	HV	NT	-80	-15.065913	20	PASS
11N40	ANT1	5510	NV	NT	-80	-14.519056	20	PASS
11N40	ANT1	5510	LV	NT	0	0	20	PASS
11N40	ANT1	5510	HV	NT	0	0	20	PASS
11N40	ANT2	5510	NV	NT	0	0	20	PASS
11N40	ANT2	5510	LV	NT	0	0	20	PASS
11N40	ANT2	5510	HV	NT	0	0	20	PASS
11N40	ANT1	5550	NV	NT	-80	-14.414414	20	PASS
11N40	ANT1	5550	LV	NT	0	0	20	PASS
11N40	ANT1	5550	HV	NT	0	0	20	PASS
11N40	ANT2	5550	NV	NT	-80	-14.414414	20	PASS
11N40	ANT2	5550	LV	NT	0	0	20	PASS
11N40	ANT2	5550	HV	NT	-80	-14.414414	20	PASS
11N40	ANT1	5670	NV	NT	-80	-14.109347	20	PASS
11N40	ANT1	5670	LV	NT	0	0	20	PASS
11N40	ANT1	5670	HV	NT	-80	-14.109347	20	PASS
11N40	ANT2	5670	NV	NT	0	0	20	PASS
11N40	ANT2	5670	LV	NT	-80	-14.109347	20	PASS
11N40	ANT2	5670	HV	NT	-80	-14.109347	20	PASS
11N40	ANT1	5755	NV	NT	-80	-13.900956	20	PASS
11N40	ANT1	5755	LV	NT	0	0	20	PASS
11N40	ANT1	5755	HV	NT	-80	-13.900956	20	PASS
11N40	ANT2	5755	NV	NT	0	0	20	PASS
11N40	ANT2	5755	LV	NT	0	0	20	PASS
11N40	ANT2	5755	HV	NT	0	0	20	PASS
11N40	ANT1	5795	NV	NT	0	0	20	PASS
11N40	ANT1	5795	LV	NT	0	0	20	PASS
11N40	ANT1	5795	HV	NT	0	0	20	PASS
11N40	ANT2	5795	NV	NT	0	0	20	PASS
11N40	ANT2	5795	LV	NT	0	0	20	PASS
11N40	ANT2	5795	HV	NT	0	0	20	PASS
11AC20	ANT1	5180	NV	NT	0	0	20	PASS
11AC20	ANT1	5180	LV	NT	-80	-15.444015	20	PASS
11AC20	ANT1	5180	HV	NT	-80	-15.444015	20	PASS
11AC20	ANT2	5180	NV	NT	0	0	20	PASS
11AC20	ANT2	5180	LV	NT	0	0	20	PASS
11AC20	ANT2	5180	HV	NT	-80	-15.444015	20	PASS
11AC20	ANT1	5200	NV	NT	-80	-15.384615	20	PASS
11AC20	ANT1	5200	LV	NT	0	0	20	PASS

11AC20	ANT1	5200	HV	NT	-80	-15.384615	20	PASS
11AC20	ANT2	5200	NV	NT	-80	-15.384615	20	PASS
11AC20	ANT2	5200	LV	NT	-80	-15.384615	20	PASS
11AC20	ANT2	5200	HV	NT	-80	-15.384615	20	PASS
11AC20	ANT1	5240	NV	NT	-80	-15.267176	20	PASS
11AC20	ANT1	5240	LV	NT	0	0	20	PASS
11AC20	ANT1	5240	HV	NT	0	0	20	PASS
11AC20	ANT2	5240	NV	NT	-80	-15.267176	20	PASS
11AC20	ANT2	5240	LV	NT	-80	-15.267176	20	PASS
11AC20	ANT2	5240	HV	NT	0	0	20	PASS
11AC20	ANT1	5260	NV	NT	-80	-15.209125	20	PASS
11AC20	ANT1	5260	LV	NT	0	0	20	PASS
11AC20	ANT1	5260	HV	NT	-80	-15.209125	20	PASS
11AC20	ANT2	5260	NV	NT	-80	-15.209125	20	PASS
11AC20	ANT2	5260	LV	NT	0	0	20	PASS
11AC20	ANT2	5260	HV	NT	-80	-15.209125	20	PASS
11AC20	ANT1	5280	NV	NT	0	0	20	PASS
11AC20	ANT1	5280	LV	NT	0	0	20	PASS
11AC20	ANT1	5280	HV	NT	0	0	20	PASS
11AC20	ANT2	5280	NV	NT	-80	-15.151515	20	PASS
11AC20	ANT2	5280	LV	NT	0	0	20	PASS
11AC20	ANT2	5280	HV	NT	-80	-15.151515	20	PASS
11AC20	ANT1	5320	NV	NT	-80	-15.037594	20	PASS
11AC20	ANT1	5320	LV	NT	-80	-15.037594	20	PASS
11AC20	ANT1	5320	HV	NT	0	0	20	PASS
11AC20	ANT2	5320	NV	NT	-80	-15.037594	20	PASS
11AC20	ANT2	5320	LV	NT	-80	-15.037594	20	PASS
11AC20	ANT2	5320	HV	NT	0	0	20	PASS
11AC20	ANT1	5500	NV	NT	-80	-14.545455	20	PASS
11AC20	ANT1	5500	LV	NT	0	0	20	PASS
11AC20	ANT1	5500	HV	NT	0	0	20	PASS
11AC20	ANT2	5500	NV	NT	0	0	20	PASS
11AC20	ANT2	5500	LV	NT	0	0	20	PASS
11AC20	ANT2	5500	HV	NT	0	0	20	PASS
11AC20	ANT1	5580	NV	NT	0	0	20	PASS
11AC20	ANT1	5580	LV	NT	-80	-14.336918	20	PASS
11AC20	ANT1	5580	HV	NT	-80	-14.336918	20	PASS
11AC20	ANT2	5580	NV	NT	0	0	20	PASS
11AC20	ANT2	5580	LV	NT	0	0	20	PASS

11AC20	ANT2	5580	HV	NT	-80	-14.336918	20	PASS
11AC20	ANT1	5700	NV	NT	-80	-14.035088	20	PASS
11AC20	ANT1	5700	LV	NT	-80	-14.035088	20	PASS
11AC20	ANT1	5700	HV	NT	-80	-14.035088	20	PASS
11AC20	ANT2	5700	NV	NT	-80	-14.035088	20	PASS
11AC20	ANT2	5700	LV	NT	-80	-14.035088	20	PASS
11AC20	ANT2	5700	HV	NT	-80	-14.035088	20	PASS
11AC20	ANT1	5745	NV	NT	-80	-13.925152	20	PASS
11AC20	ANT1	5745	LV	NT	-80	-13.925152	20	PASS
11AC20	ANT1	5745	HV	NT	0	0	20	PASS
11AC20	ANT2	5745	NV	NT	-80	-13.925152	20	PASS
11AC20	ANT2	5745	LV	NT	-80	-13.925152	20	PASS
11AC20	ANT2	5745	HV	NT	-80	-13.925152	20	PASS
11AC20	ANT1	5785	NV	NT	-80	-13.828868	20	PASS
11AC20	ANT1	5785	LV	NT	-80	-13.828868	20	PASS
11AC20	ANT1	5785	HV	NT	0	0	20	PASS
11AC20	ANT2	5785	NV	NT	-80	-13.828868	20	PASS
11AC20	ANT2	5785	LV	NT	-80	-13.828868	20	PASS
11AC20	ANT2	5785	HV	NT	-80	-13.828868	20	PASS
11AC20	ANT1	5825	NV	NT	-80	-13.733906	20	PASS
11AC20	ANT1	5825	LV	NT	0	0	20	PASS
11AC20	ANT1	5825	HV	NT	0	0	20	PASS
11AC20	ANT2	5825	NV	NT	-80	-13.733906	20	PASS
11AC20	ANT2	5825	LV	NT	0	0	20	PASS
11AC20	ANT2	5825	HV	NT	-80	-13.733906	20	PASS
11AC40	ANT1	5190	NV	NT	0	0	20	PASS
11AC40	ANT1	5190	LV	NT	0	0	20	PASS
11AC40	ANT1	5190	HV	NT	0	0	20	PASS
11AC40	ANT2	5190	NV	NT	0	0	20	PASS
11AC40	ANT2	5190	LV	NT	0	0	20	PASS
11AC40	ANT2	5190	HV	NT	-80	-15.414258	20	PASS
11AC40	ANT1	5230	NV	NT	-80	-15.296367	20	PASS
11AC40	ANT1	5230	LV	NT	0	0	20	PASS
11AC40	ANT1	5230	HV	NT	0	0	20	PASS
11AC40	ANT2	5230	NV	NT	0	0	20	PASS
11AC40	ANT2	5230	LV	NT	0	0	20	PASS
11AC40	ANT2	5230	HV	NT	0	0	20	PASS
11AC40	ANT1	5270	NV	NT	0	0	20	PASS
11AC40	ANT1	5270	LV	NT	0	0	20	PASS

11AC40	ANT1	5270	HV	NT	0	0	20	PASS
11AC40	ANT2	5270	NV	NT	0	0	20	PASS
11AC40	ANT2	5270	LV	NT	0	0	20	PASS
11AC40	ANT2	5270	HV	NT	0	0	20	PASS
11AC40	ANT1	5310	NV	NT	0	0	20	PASS
11AC40	ANT1	5310	LV	NT	0	0	20	PASS
11AC40	ANT1	5310	HV	NT	0	0	20	PASS
11AC40	ANT2	5310	NV	NT	0	0	20	PASS
11AC40	ANT2	5310	LV	NT	0	0	20	PASS
11AC40	ANT2	5310	HV	NT	0	0	20	PASS
11AC40	ANT1	5510	NV	NT	0	0	20	PASS
11AC40	ANT1	5510	LV	NT	0	0	20	PASS
11AC40	ANT1	5510	HV	NT	0	0	20	PASS
11AC40	ANT2	5510	NV	NT	0	0	20	PASS
11AC40	ANT2	5510	LV	NT	0	0	20	PASS
11AC40	ANT2	5510	HV	NT	0	0	20	PASS
11AC40	ANT1	5550	NV	NT	0	0	20	PASS
11AC40	ANT1	5550	LV	NT	-80	-14.414414	20	PASS
11AC40	ANT1	5550	HV	NT	-80	-14.414414	20	PASS
11AC40	ANT2	5550	NV	NT	0	0	20	PASS
11AC40	ANT2	5550	LV	NT	-80	-14.414414	20	PASS
11AC40	ANT2	5550	HV	NT	0	0	20	PASS
11AC40	ANT1	5670	NV	NT	0	0	20	PASS
11AC40	ANT1	5670	LV	NT	0	0	20	PASS
11AC40	ANT1	5670	HV	NT	0	0	20	PASS
11AC40	ANT2	5670	NV	NT	0	0	20	PASS
11AC40	ANT2	5670	LV	NT	0	0	20	PASS
11AC40	ANT2	5670	HV	NT	0	0	20	PASS
11AC40	ANT1	5755	NV	NT	0	0	20	PASS
11AC40	ANT1	5755	LV	NT	0	0	20	PASS
11AC40	ANT1	5755	HV	NT	0	0	20	PASS
11AC40	ANT2	5755	NV	NT	0	0	20	PASS
11AC40	ANT2	5755	LV	NT	0	0	20	PASS
11AC40	ANT2	5755	HV	NT	80	13.900956	20	PASS
11AC40	ANT1	5795	NV	NT	0	0	20	PASS
11AC40	ANT1	5795	LV	NT	0	0	20	PASS
11AC40	ANT1	5795	HV	NT	0	0	20	PASS
11AC40	ANT2	5795	NV	NT	0	0	20	PASS
11AC40	ANT2	5795	LV	NT	0	0	20	PASS

11AC40	ANT2	5795	HV	NT	0	0	20	PASS
11AC80	ANT1	5210	NV	NT	-80	-15.355086	20	PASS
11AC80	ANT1	5210	LV	NT	0	0	20	PASS
11AC80	ANT1	5210	HV	NT	-80	-15.355086	20	PASS
11AC80	ANT2	5210	NV	NT	0	0	20	PASS
11AC80	ANT2	5210	LV	NT	0	0	20	PASS
11AC80	ANT2	5210	HV	NT	0	0	20	PASS
11AC80	ANT1	5290	NV	NT	-80	-15.122873	20	PASS
11AC80	ANT1	5290	LV	NT	-80	-15.122873	20	PASS
11AC80	ANT1	5290	HV	NT	-80	-15.122873	20	PASS
11AC80	ANT2	5290	NV	NT	-80	-15.122873	20	PASS
11AC80	ANT2	5290	LV	NT	-80	-15.122873	20	PASS
11AC80	ANT2	5290	HV	NT	0	0	20	PASS
11AC80	ANT1	5530	NV	NT	0	0	20	PASS
11AC80	ANT1	5530	LV	NT	0	0	20	PASS
11AC80	ANT1	5530	HV	NT	-80	-14.466546	20	PASS
11AC80	ANT2	5530	NV	NT	0	0	20	PASS
11AC80	ANT2	5530	LV	NT	0	0	20	PASS
11AC80	ANT2	5530	HV	NT	0	0	20	PASS
11AC80	ANT1	5775	NV	NT	0	0	20	PASS
11AC80	ANT1	5775	LV	NT	0	0	20	PASS
11AC80	ANT1	5775	HV	NT	0	0	20	PASS
11AC80	ANT2	5775	NV	NT	-80	-13.852814	20	PASS
11AC80	ANT2	5775	LV	NT	0	0	20	PASS
11AC80	ANT2	5775	HV	NT	0	0	20	PASS

Temperature								
Test Mode	Antenna	Channel	Voltage [Vdc]	Temperature (°C)	Deviation (kHz)	Deviation (ppm)	Limit (ppm)	Verdict
11A	ANT1	5180	NV	-30	-80	-15.444015	20	PASS
11A	ANT1	5180	NV	-20	0	0	20	PASS
11A	ANT1	5180	NV	-10	0	0	20	PASS
11A	ANT1	5180	NV	0	0	0	20	PASS
11A	ANT1	5180	NV	10	0	0	20	PASS
11A	ANT1	5180	NV	20	-80	-15.444015	20	PASS
11A	ANT1	5180	NV	30	-80	-15.444015	20	PASS
11A	ANT1	5180	NV	40	-80	-15.444015	20	PASS
11A	ANT1	5180	NV	50	0	0	20	PASS
11A	ANT2	5180	NV	-30	-80	-15.444015	20	PASS
11A	ANT2	5180	NV	-20	-80	-15.444015	20	PASS

11A	ANT2	5180	NV	-10	0	0	20	PASS
11A	ANT2	5180	NV	0	0	0	20	PASS
11A	ANT2	5180	NV	10	-80	-15.444015	20	PASS
11A	ANT2	5180	NV	20	-80	-15.444015	20	PASS
11A	ANT2	5180	NV	30	-80	-15.444015	20	PASS
11A	ANT2	5180	NV	40	0	0	20	PASS
11A	ANT2	5180	NV	50	0	0	20	PASS
11A	ANT1	5200	NV	-30	-80	-15.384615	20	PASS
11A	ANT1	5200	NV	-20	-80	-15.384615	20	PASS
11A	ANT1	5200	NV	-10	0	0	20	PASS
11A	ANT1	5200	NV	0	-80	-15.384615	20	PASS
11A	ANT1	5200	NV	10	-80	-15.384615	20	PASS
11A	ANT1	5200	NV	20	-80	-15.384615	20	PASS
11A	ANT1	5200	NV	30	0	0	20	PASS
11A	ANT1	5200	NV	40	-80	-15.384615	20	PASS
11A	ANT1	5200	NV	50	-80	-15.384615	20	PASS
11A	ANT2	5200	NV	-30	-80	-15.384615	20	PASS
11A	ANT2	5200	NV	-20	-80	-15.384615	20	PASS
11A	ANT2	5200	NV	-10	-80	-15.384615	20	PASS
11A	ANT2	5200	NV	0	-80	-15.384615	20	PASS
11A	ANT2	5200	NV	10	-80	-15.384615	20	PASS
11A	ANT2	5200	NV	20	-80	-15.384615	20	PASS
11A	ANT2	5200	NV	30	0	0	20	PASS
11A	ANT2	5200	NV	40	-80	-15.384615	20	PASS
11A	ANT2	5200	NV	50	0	0	20	PASS
11A	ANT1	5240	NV	-30	-80	-15.267176	20	PASS
11A	ANT1	5240	NV	-20	-80	-15.267176	20	PASS
11A	ANT1	5240	NV	-10	-80	-15.267176	20	PASS
11A	ANT1	5240	NV	0	-80	-15.267176	20	PASS
11A	ANT1	5240	NV	10	-80	-15.267176	20	PASS
11A	ANT1	5240	NV	20	-80	-15.267176	20	PASS
11A	ANT1	5240	NV	30	-80	-15.267176	20	PASS
11A	ANT1	5240	NV	40	-80	-15.267176	20	PASS
11A	ANT1	5240	NV	50	-80	-15.267176	20	PASS
11A	ANT2	5240	NV	-30	-80	-15.267176	20	PASS
11A	ANT2	5240	NV	-20	-80	-15.267176	20	PASS
11A	ANT2	5240	NV	-10	-80	-15.267176	20	PASS
11A	ANT2	5240	NV	0	-80	-15.267176	20	PASS
11A	ANT2	5240	NV	10	-80	-15.267176	20	PASS

11A	ANT2	5240	NV	20	-80	-15.267176	20	PASS
11A	ANT2	5240	NV	30	-80	-15.267176	20	PASS
11A	ANT2	5240	NV	40	-80	-15.267176	20	PASS
11A	ANT2	5240	NV	50	0	0	20	PASS
11A	ANT1	5260	NV	-30	-80	-15.209125	20	PASS
11A	ANT1	5260	NV	-20	-80	-15.209125	20	PASS
11A	ANT1	5260	NV	-10	-80	-15.209125	20	PASS
11A	ANT1	5260	NV	0	-80	-15.209125	20	PASS
11A	ANT1	5260	NV	10	-80	-15.209125	20	PASS
11A	ANT1	5260	NV	20	-80	-15.209125	20	PASS
11A	ANT1	5260	NV	30	-80	-15.209125	20	PASS
11A	ANT1	5260	NV	40	-80	-15.209125	20	PASS
11A	ANT1	5260	NV	50	-80	-15.209125	20	PASS
11A	ANT2	5260	NV	-30	-80	-15.209125	20	PASS
11A	ANT2	5260	NV	-20	-80	-15.209125	20	PASS
11A	ANT2	5260	NV	-10	-80	-15.209125	20	PASS
11A	ANT2	5260	NV	0	-80	-15.209125	20	PASS
11A	ANT2	5260	NV	10	-80	-15.209125	20	PASS
11A	ANT2	5260	NV	20	-80	-15.209125	20	PASS
11A	ANT2	5260	NV	30	-80	-15.209125	20	PASS
11A	ANT2	5260	NV	40	-80	-15.209125	20	PASS
11A	ANT2	5260	NV	50	-80	-15.209125	20	PASS
11A	ANT1	5280	NV	-30	-80	-15.151515	20	PASS
11A	ANT1	5280	NV	-20	-80	-15.151515	20	PASS
11A	ANT1	5280	NV	-10	-80	-15.151515	20	PASS
11A	ANT1	5280	NV	0	-80	-15.151515	20	PASS
11A	ANT1	5280	NV	10	-80	-15.151515	20	PASS
11A	ANT1	5280	NV	20	-80	-15.151515	20	PASS
11A	ANT1	5280	NV	30	0	0	20	PASS
11A	ANT1	5280	NV	40	-80	-15.151515	20	PASS
11A	ANT1	5280	NV	50	-80	-15.151515	20	PASS
11A	ANT2	5280	NV	-30	-80	-15.151515	20	PASS
11A	ANT2	5280	NV	-20	0	0	20	PASS
11A	ANT2	5280	NV	-10	-80	-15.151515	20	PASS
11A	ANT2	5280	NV	0	-80	-15.151515	20	PASS
11A	ANT2	5280	NV	10	-80	-15.151515	20	PASS
11A	ANT2	5280	NV	20	-80	-15.151515	20	PASS
11A	ANT2	5280	NV	30	-80	-15.151515	20	PASS
11A	ANT2	5280	NV	40	-80	-15.151515	20	PASS

11A	ANT2	5280	NV	50	-80	-15.151515	20	PASS
11A	ANT1	5320	NV	-30	-80	-15.037594	20	PASS
11A	ANT1	5320	NV	-20	-80	-15.037594	20	PASS
11A	ANT1	5320	NV	-10	-80	-15.037594	20	PASS
11A	ANT1	5320	NV	0	-80	-15.037594	20	PASS
11A	ANT1	5320	NV	10	-80	-15.037594	20	PASS
11A	ANT1	5320	NV	20	0	0	20	PASS
11A	ANT1	5320	NV	30	-80	-15.037594	20	PASS
11A	ANT1	5320	NV	40	-80	-15.037594	20	PASS
11A	ANT1	5320	NV	50	0	0	20	PASS
11A	ANT2	5320	NV	-30	-80	-15.037594	20	PASS
11A	ANT2	5320	NV	-20	-80	-15.037594	20	PASS
11A	ANT2	5320	NV	-10	-80	-15.037594	20	PASS
11A	ANT2	5320	NV	0	-80	-15.037594	20	PASS
11A	ANT2	5320	NV	10	-80	-15.037594	20	PASS
11A	ANT2	5320	NV	20	-80	-15.037594	20	PASS
11A	ANT2	5320	NV	30	-80	-15.037594	20	PASS
11A	ANT2	5320	NV	40	-80	-15.037594	20	PASS
11A	ANT2	5320	NV	50	-80	-15.037594	20	PASS
11A	ANT1	5500	NV	-30	-80	-14.545455	20	PASS
11A	ANT1	5500	NV	-20	-80	-14.545455	20	PASS
11A	ANT1	5500	NV	-10	-80	-14.545455	20	PASS
11A	ANT1	5500	NV	0	-80	-14.545455	20	PASS
11A	ANT1	5500	NV	10	0	0	20	PASS
11A	ANT1	5500	NV	20	-80	-14.545455	20	PASS
11A	ANT1	5500	NV	30	-80	-14.545455	20	PASS
11A	ANT1	5500	NV	40	-80	-14.545455	20	PASS
11A	ANT1	5500	NV	50	-80	-14.545455	20	PASS
11A	ANT2	5500	NV	-30	-80	-14.545455	20	PASS
11A	ANT2	5500	NV	-20	-80	-14.545455	20	PASS
11A	ANT2	5500	NV	-10	-80	-14.545455	20	PASS
11A	ANT2	5500	NV	0	-80	-14.545455	20	PASS
11A	ANT2	5500	NV	10	-80	-14.545455	20	PASS
11A	ANT2	5500	NV	20	-80	-14.545455	20	PASS
11A	ANT2	5500	NV	30	-80	-14.545455	20	PASS
11A	ANT2	5500	NV	40	-80	-14.545455	20	PASS
11A	ANT2	5500	NV	50	-80	-14.545455	20	PASS
11A	ANT1	5580	NV	-30	-80	-14.336918	20	PASS
11A	ANT1	5580	NV	-20	-80	-14.336918	20	PASS

11A	ANT1	5580	NV	-10	-80	-14.336918	20	PASS
11A	ANT1	5580	NV	0	-80	-14.336918	20	PASS
11A	ANT1	5580	NV	10	0	0	20	PASS
11A	ANT1	5580	NV	20	-80	-14.336918	20	PASS
11A	ANT1	5580	NV	30	-80	-14.336918	20	PASS
11A	ANT1	5580	NV	40	0	0	20	PASS
11A	ANT1	5580	NV	50	-80	-14.336918	20	PASS
11A	ANT2	5580	NV	-30	-80	-14.336918	20	PASS
11A	ANT2	5580	NV	-20	-80	-14.336918	20	PASS
11A	ANT2	5580	NV	-10	-80	-14.336918	20	PASS
11A	ANT2	5580	NV	0	-80	-14.336918	20	PASS
11A	ANT2	5580	NV	10	-80	-14.336918	20	PASS
11A	ANT2	5580	NV	20	-80	-14.336918	20	PASS
11A	ANT2	5580	NV	30	-80	-14.336918	20	PASS
11A	ANT2	5580	NV	40	-80	-14.336918	20	PASS
11A	ANT2	5580	NV	50	-80	-14.336918	20	PASS
11A	ANT1	5700	NV	-30	-80	-14.035088	20	PASS
11A	ANT1	5700	NV	-20	-80	-14.035088	20	PASS
11A	ANT1	5700	NV	-10	-80	-14.035088	20	PASS
11A	ANT1	5700	NV	0	-80	-14.035088	20	PASS
11A	ANT1	5700	NV	10	-80	-14.035088	20	PASS
11A	ANT1	5700	NV	20	0	0	20	PASS
11A	ANT1	5700	NV	30	0	0	20	PASS
11A	ANT1	5700	NV	40	-80	-14.035088	20	PASS
11A	ANT1	5700	NV	50	-80	-14.035088	20	PASS
11A	ANT2	5700	NV	-30	-80	-14.035088	20	PASS
11A	ANT2	5700	NV	-20	-80	-14.035088	20	PASS
11A	ANT2	5700	NV	-10	-80	-14.035088	20	PASS
11A	ANT2	5700	NV	0	-80	-14.035088	20	PASS
11A	ANT2	5700	NV	10	-80	-14.035088	20	PASS
11A	ANT2	5700	NV	20	-80	-14.035088	20	PASS
11A	ANT2	5700	NV	30	0	0	20	PASS
11A	ANT2	5700	NV	40	-80	-14.035088	20	PASS
11A	ANT2	5700	NV	50	0	0	20	PASS
11A	ANT1	5745	NV	-30	0	0	20	PASS
11A	ANT1	5745	NV	-20	-80	-13.925152	20	PASS
11A	ANT1	5745	NV	-10	-80	-13.925152	20	PASS
11A	ANT1	5745	NV	0	0	0	20	PASS
11A	ANT1	5745	NV	10	-80	-13.925152	20	PASS

11A	ANT1	5745	NV	20	0	0	20	PASS
11A	ANT1	5745	NV	30	-80	-13.925152	20	PASS
11A	ANT1	5745	NV	40	-80	-13.925152	20	PASS
11A	ANT1	5745	NV	50	0	0	20	PASS
11A	ANT2	5745	NV	-30	0	0	20	PASS
11A	ANT2	5745	NV	-20	-80	-13.925152	20	PASS
11A	ANT2	5745	NV	-10	-80	-13.925152	20	PASS
11A	ANT2	5745	NV	0	-80	-13.925152	20	PASS
11A	ANT2	5745	NV	10	-80	-13.925152	20	PASS
11A	ANT2	5745	NV	20	-80	-13.925152	20	PASS
11A	ANT2	5745	NV	30	-80	-13.925152	20	PASS
11A	ANT2	5745	NV	40	-80	-13.925152	20	PASS
11A	ANT2	5745	NV	50	0	0	20	PASS
11A	ANT1	5785	NV	-30	-80	-13.828868	20	PASS
11A	ANT1	5785	NV	-20	-80	-13.828868	20	PASS
11A	ANT1	5785	NV	-10	-80	-13.828868	20	PASS
11A	ANT1	5785	NV	0	-80	-13.828868	20	PASS
11A	ANT1	5785	NV	10	-80	-13.828868	20	PASS
11A	ANT1	5785	NV	20	0	0	20	PASS
11A	ANT1	5785	NV	30	-80	-13.828868	20	PASS
11A	ANT1	5785	NV	40	-80	-13.828868	20	PASS
11A	ANT1	5785	NV	50	-80	-13.828868	20	PASS
11A	ANT2	5785	NV	-30	-80	-13.828868	20	PASS
11A	ANT2	5785	NV	-20	-80	-13.828868	20	PASS
11A	ANT2	5785	NV	-10	-80	-13.828868	20	PASS
11A	ANT2	5785	NV	0	-80	-13.828868	20	PASS
11A	ANT2	5785	NV	10	-80	-13.828868	20	PASS
11A	ANT2	5785	NV	20	-80	-13.828868	20	PASS
11A	ANT2	5785	NV	30	-80	-13.828868	20	PASS
11A	ANT2	5785	NV	40	-80	-13.828868	20	PASS
11A	ANT2	5785	NV	50	-80	-13.828868	20	PASS
11A	ANT1	5825	NV	-30	-80	-13.733906	20	PASS
11A	ANT1	5825	NV	-20	-80	-13.733906	20	PASS
11A	ANT1	5825	NV	-10	-80	-13.733906	20	PASS
11A	ANT1	5825	NV	0	-80	-13.733906	20	PASS
11A	ANT1	5825	NV	10	-80	-13.733906	20	PASS
11A	ANT1	5825	NV	20	-80	-13.733906	20	PASS
11A	ANT1	5825	NV	30	0	0	20	PASS
11A	ANT1	5825	NV	40	-80	-13.733906	20	PASS

11A	ANT1	5825	NV	50	-80	-13.733906	20	PASS
11A	ANT2	5825	NV	-30	-80	-13.733906	20	PASS
11A	ANT2	5825	NV	-20	-80	-13.733906	20	PASS
11A	ANT2	5825	NV	-10	0	0	20	PASS
11A	ANT2	5825	NV	0	-80	-13.733906	20	PASS
11A	ANT2	5825	NV	10	0	0	20	PASS
11A	ANT2	5825	NV	20	-80	-13.733906	20	PASS
11A	ANT2	5825	NV	30	-80	-13.733906	20	PASS
11A	ANT2	5825	NV	40	-80	-13.733906	20	PASS
11A	ANT2	5825	NV	50	0	0	20	PASS
11N20	ANT1	5180	NV	-30	0	0	20	PASS
11N20	ANT1	5180	NV	-20	0	0	20	PASS
11N20	ANT1	5180	NV	-10	0	0	20	PASS
11N20	ANT1	5180	NV	0	0	0	20	PASS
11N20	ANT1	5180	NV	10	0	0	20	PASS
11N20	ANT1	5180	NV	20	0	0	20	PASS
11N20	ANT1	5180	NV	30	0	0	20	PASS
11N20	ANT1	5180	NV	40	0	0	20	PASS
11N20	ANT1	5180	NV	50	0	0	20	PASS
11N20	ANT2	5180	NV	-30	0	0	20	PASS
11N20	ANT2	5180	NV	-20	0	0	20	PASS
11N20	ANT2	5180	NV	-10	0	0	20	PASS
11N20	ANT2	5180	NV	0	0	0	20	PASS
11N20	ANT2	5180	NV	10	0	0	20	PASS
11N20	ANT2	5180	NV	20	0	0	20	PASS
11N20	ANT2	5180	NV	30	0	0	20	PASS
11N20	ANT2	5180	NV	40	0	0	20	PASS
11N20	ANT2	5180	NV	50	0	0	20	PASS
11N20	ANT1	5200	NV	-30	0	0	20	PASS
11N20	ANT1	5200	NV	-20	0	0	20	PASS
11N20	ANT1	5200	NV	-10	0	0	20	PASS
11N20	ANT1	5200	NV	0	0	0	20	PASS
11N20	ANT1	5200	NV	10	0	0	20	PASS
11N20	ANT1	5200	NV	20	0	0	20	PASS
11N20	ANT1	5200	NV	30	-80	-15.384615	20	PASS
11N20	ANT1	5200	NV	40	0	0	20	PASS
11N20	ANT1	5200	NV	50	0	0	20	PASS
11N20	ANT2	5200	NV	-30	0	0	20	PASS
11N20	ANT2	5200	NV	-20	0	0	20	PASS

11N20	ANT2	5200	NV	-10	-80	-15.384615	20	PASS
11N20	ANT2	5200	NV	0	0	0	20	PASS
11N20	ANT2	5200	NV	10	0	0	20	PASS
11N20	ANT2	5200	NV	20	0	0	20	PASS
11N20	ANT2	5200	NV	30	0	0	20	PASS
11N20	ANT2	5200	NV	40	0	0	20	PASS
11N20	ANT2	5200	NV	50	-80	-15.384615	20	PASS
11N20	ANT1	5240	NV	-30	0	0	20	PASS
11N20	ANT1	5240	NV	-20	0	0	20	PASS
11N20	ANT1	5240	NV	-10	0	0	20	PASS
11N20	ANT1	5240	NV	0	0	0	20	PASS
11N20	ANT1	5240	NV	10	-80	-15.267176	20	PASS
11N20	ANT1	5240	NV	20	0	0	20	PASS
11N20	ANT1	5240	NV	30	0	0	20	PASS
11N20	ANT1	5240	NV	40	-80	-15.267176	20	PASS
11N20	ANT1	5240	NV	50	0	0	20	PASS
11N20	ANT2	5240	NV	-30	0	0	20	PASS
11N20	ANT2	5240	NV	-20	0	0	20	PASS
11N20	ANT2	5240	NV	-10	0	0	20	PASS
11N20	ANT2	5240	NV	0	0	0	20	PASS
11N20	ANT2	5240	NV	10	0	0	20	PASS
11N20	ANT2	5240	NV	20	0	0	20	PASS
11N20	ANT2	5240	NV	30	0	0	20	PASS
11N20	ANT2	5240	NV	40	0	0	20	PASS
11N20	ANT2	5240	NV	50	0	0	20	PASS
11N20	ANT1	5260	NV	-30	-80	-15.209125	20	PASS
11N20	ANT1	5260	NV	-20	-80	-15.209125	20	PASS
11N20	ANT1	5260	NV	-10	0	0	20	PASS
11N20	ANT1	5260	NV	0	0	0	20	PASS
11N20	ANT1	5260	NV	10	0	0	20	PASS
11N20	ANT1	5260	NV	20	0	0	20	PASS
11N20	ANT1	5260	NV	30	0	0	20	PASS
11N20	ANT1	5260	NV	40	0	0	20	PASS
11N20	ANT1	5260	NV	50	0	0	20	PASS
11N20	ANT2	5260	NV	-30	0	0	20	PASS
11N20	ANT2	5260	NV	-20	0	0	20	PASS
11N20	ANT2	5260	NV	-10	0	0	20	PASS
11N20	ANT2	5260	NV	0	0	0	20	PASS
11N20	ANT2	5260	NV	10	0	0	20	PASS

11N20	ANT2	5260	NV	20	0	0	20	PASS
11N20	ANT2	5260	NV	30	0	0	20	PASS
11N20	ANT2	5260	NV	40	0	0	20	PASS
11N20	ANT2	5260	NV	50	0	0	20	PASS
11N20	ANT1	5280	NV	-30	0	0	20	PASS
11N20	ANT1	5280	NV	-20	0	0	20	PASS
11N20	ANT1	5280	NV	-10	0	0	20	PASS
11N20	ANT1	5280	NV	0	0	0	20	PASS
11N20	ANT1	5280	NV	10	0	0	20	PASS
11N20	ANT1	5280	NV	20	0	0	20	PASS
11N20	ANT1	5280	NV	30	0	0	20	PASS
11N20	ANT1	5280	NV	40	-80	-15.151515	20	PASS
11N20	ANT1	5280	NV	50	0	0	20	PASS
11N20	ANT2	5280	NV	-30	0	0	20	PASS
11N20	ANT2	5280	NV	-20	0	0	20	PASS
11N20	ANT2	5280	NV	-10	0	0	20	PASS
11N20	ANT2	5280	NV	0	0	0	20	PASS
11N20	ANT2	5280	NV	10	0	0	20	PASS
11N20	ANT2	5280	NV	20	0	0	20	PASS
11N20	ANT2	5280	NV	30	0	0	20	PASS
11N20	ANT2	5280	NV	40	0	0	20	PASS
11N20	ANT2	5280	NV	50	0	0	20	PASS
11N20	ANT1	5320	NV	-30	0	0	20	PASS
11N20	ANT1	5320	NV	-20	0	0	20	PASS
11N20	ANT1	5320	NV	-10	0	0	20	PASS
11N20	ANT1	5320	NV	0	0	0	20	PASS
11N20	ANT1	5320	NV	10	0	0	20	PASS
11N20	ANT1	5320	NV	20	0	0	20	PASS
11N20	ANT1	5320	NV	30	0	0	20	PASS
11N20	ANT1	5320	NV	40	0	0	20	PASS
11N20	ANT1	5320	NV	50	0	0	20	PASS
11N20	ANT2	5320	NV	-30	0	0	20	PASS
11N20	ANT2	5320	NV	-20	0	0	20	PASS
11N20	ANT2	5320	NV	-10	0	0	20	PASS
11N20	ANT2	5320	NV	0	0	0	20	PASS
11N20	ANT2	5320	NV	10	-80	-15.037594	20	PASS
11N20	ANT2	5320	NV	20	0	0	20	PASS
11N20	ANT2	5320	NV	30	0	0	20	PASS
11N20	ANT2	5320	NV	40	0	0	20	PASS

11N20	ANT2	5320	NV	50	0	0	20	PASS
11N20	ANT1	5500	NV	-30	0	0	20	PASS
11N20	ANT1	5500	NV	-20	0	0	20	PASS
11N20	ANT1	5500	NV	-10	0	0	20	PASS
11N20	ANT1	5500	NV	0	0	0	20	PASS
11N20	ANT1	5500	NV	10	-80	-14.545455	20	PASS
11N20	ANT1	5500	NV	20	0	0	20	PASS
11N20	ANT1	5500	NV	30	0	0	20	PASS
11N20	ANT1	5500	NV	40	0	0	20	PASS
11N20	ANT1	5500	NV	50	0	0	20	PASS
11N20	ANT2	5500	NV	-30	0	0	20	PASS
11N20	ANT2	5500	NV	-20	0	0	20	PASS
11N20	ANT2	5500	NV	-10	0	0	20	PASS
11N20	ANT2	5500	NV	0	0	0	20	PASS
11N20	ANT2	5500	NV	10	0	0	20	PASS
11N20	ANT2	5500	NV	20	0	0	20	PASS
11N20	ANT2	5500	NV	30	0	0	20	PASS
11N20	ANT2	5500	NV	40	0	0	20	PASS
11N20	ANT2	5500	NV	50	0	0	20	PASS
11N20	ANT1	5580	NV	-30	0	0	20	PASS
11N20	ANT1	5580	NV	-20	0	0	20	PASS
11N20	ANT1	5580	NV	-10	0	0	20	PASS
11N20	ANT1	5580	NV	0	0	0	20	PASS
11N20	ANT1	5580	NV	10	-80	-14.336918	20	PASS
11N20	ANT1	5580	NV	20	0	0	20	PASS
11N20	ANT1	5580	NV	30	0	0	20	PASS
11N20	ANT1	5580	NV	40	0	0	20	PASS
11N20	ANT1	5580	NV	50	0	0	20	PASS
11N20	ANT2	5580	NV	-30	0	0	20	PASS
11N20	ANT2	5580	NV	-20	0	0	20	PASS
11N20	ANT2	5580	NV	-10	0	0	20	PASS
11N20	ANT2	5580	NV	0	0	0	20	PASS
11N20	ANT2	5580	NV	10	0	0	20	PASS
11N20	ANT2	5580	NV	20	0	0	20	PASS
11N20	ANT2	5580	NV	30	0	0	20	PASS
11N20	ANT2	5580	NV	40	0	0	20	PASS
11N20	ANT2	5580	NV	50	0	0	20	PASS
11N20	ANT1	5700	NV	-30	0	0	20	PASS
11N20	ANT1	5700	NV	-20	0	0	20	PASS

11N20	ANT1	5700	NV	-10	0	0	20	PASS
11N20	ANT1	5700	NV	0	0	0	20	PASS
11N20	ANT1	5700	NV	10	-80	-14.035088	20	PASS
11N20	ANT1	5700	NV	20	-80	-14.035088	20	PASS
11N20	ANT1	5700	NV	30	0	0	20	PASS
11N20	ANT1	5700	NV	40	0	0	20	PASS
11N20	ANT1	5700	NV	50	0	0	20	PASS
11N20	ANT2	5700	NV	-30	0	0	20	PASS
11N20	ANT2	5700	NV	-20	0	0	20	PASS
11N20	ANT2	5700	NV	-10	0	0	20	PASS
11N20	ANT2	5700	NV	0	0	0	20	PASS
11N20	ANT2	5700	NV	10	0	0	20	PASS
11N20	ANT2	5700	NV	20	0	0	20	PASS
11N20	ANT2	5700	NV	30	0	0	20	PASS
11N20	ANT2	5700	NV	40	0	0	20	PASS
11N20	ANT2	5700	NV	50	0	0	20	PASS
11N20	ANT1	5745	NV	-30	0	0	20	PASS
11N20	ANT1	5745	NV	-20	0	0	20	PASS
11N20	ANT1	5745	NV	-10	0	0	20	PASS
11N20	ANT1	5745	NV	0	0	0	20	PASS
11N20	ANT1	5745	NV	10	0	0	20	PASS
11N20	ANT1	5745	NV	20	0	0	20	PASS
11N20	ANT1	5745	NV	30	0	0	20	PASS
11N20	ANT1	5745	NV	40	0	0	20	PASS
11N20	ANT1	5745	NV	50	0	0	20	PASS
11N20	ANT2	5745	NV	-30	0	0	20	PASS
11N20	ANT2	5745	NV	-20	0	0	20	PASS
11N20	ANT2	5745	NV	-10	0	0	20	PASS
11N20	ANT2	5745	NV	0	0	0	20	PASS
11N20	ANT2	5745	NV	10	0	0	20	PASS
11N20	ANT2	5745	NV	20	0	0	20	PASS
11N20	ANT2	5745	NV	30	0	0	20	PASS
11N20	ANT2	5745	NV	40	0	0	20	PASS
11N20	ANT2	5745	NV	50	0	0	20	PASS
11N20	ANT1	5785	NV	-30	-80	-13.828868	20	PASS
11N20	ANT1	5785	NV	-20	-80	-13.828868	20	PASS
11N20	ANT1	5785	NV	-10	0	0	20	PASS
11N20	ANT1	5785	NV	0	0	0	20	PASS
11N20	ANT1	5785	NV	10	0	0	20	PASS

11N20	ANT1	5785	NV	20	0	0	20	PASS
11N20	ANT1	5785	NV	30	0	0	20	PASS
11N20	ANT1	5785	NV	40	0	0	20	PASS
11N20	ANT1	5785	NV	50	0	0	20	PASS
11N20	ANT2	5785	NV	-30	-80	-13.828868	20	PASS
11N20	ANT2	5785	NV	-20	0	0	20	PASS
11N20	ANT2	5785	NV	-10	0	0	20	PASS
11N20	ANT2	5785	NV	0	0	0	20	PASS
11N20	ANT2	5785	NV	10	0	0	20	PASS
11N20	ANT2	5785	NV	20	0	0	20	PASS
11N20	ANT2	5785	NV	30	0	0	20	PASS
11N20	ANT2	5785	NV	40	0	0	20	PASS
11N20	ANT2	5785	NV	50	0	0	20	PASS
11N20	ANT1	5825	NV	-30	0	0	20	PASS
11N20	ANT1	5825	NV	-20	0	0	20	PASS
11N20	ANT1	5825	NV	-10	0	0	20	PASS
11N20	ANT1	5825	NV	0	0	0	20	PASS
11N20	ANT1	5825	NV	10	0	0	20	PASS
11N20	ANT1	5825	NV	20	0	0	20	PASS
11N20	ANT1	5825	NV	30	0	0	20	PASS
11N20	ANT1	5825	NV	40	0	0	20	PASS
11N20	ANT1	5825	NV	50	0	0	20	PASS
11N20	ANT2	5825	NV	-30	0	0	20	PASS
11N20	ANT2	5825	NV	-20	0	0	20	PASS
11N20	ANT2	5825	NV	-10	0	0	20	PASS
11N20	ANT2	5825	NV	0	0	0	20	PASS
11N20	ANT2	5825	NV	10	0	0	20	PASS
11N20	ANT2	5825	NV	20	0	0	20	PASS
11N20	ANT2	5825	NV	30	0	0	20	PASS
11N20	ANT2	5825	NV	40	0	0	20	PASS
11N20	ANT2	5825	NV	50	0	0	20	PASS
11N40	ANT1	5190	NV	-30	-80	-15.414258	20	PASS
11N40	ANT1	5190	NV	-20	-80	-15.414258	20	PASS
11N40	ANT1	5190	NV	-10	0	0	20	PASS
11N40	ANT1	5190	NV	0	-80	-15.414258	20	PASS
11N40	ANT1	5190	NV	10	-80	-15.414258	20	PASS
11N40	ANT1	5190	NV	20	-80	-15.414258	20	PASS
11N40	ANT1	5190	NV	30	0	0	20	PASS
11N40	ANT1	5190	NV	40	0	0	20	PASS

11N40	ANT1	5190	NV	50	0	0	20	PASS
11N40	ANT2	5190	NV	-30	0	0	20	PASS
11N40	ANT2	5190	NV	-20	0	0	20	PASS
11N40	ANT2	5190	NV	-10	0	0	20	PASS
11N40	ANT2	5190	NV	0	-80	-15.414258	20	PASS
11N40	ANT2	5190	NV	10	-80	-15.414258	20	PASS
11N40	ANT2	5190	NV	20	0	0	20	PASS
11N40	ANT2	5190	NV	30	-80	-15.414258	20	PASS
11N40	ANT2	5190	NV	40	-80	-15.414258	20	PASS
11N40	ANT2	5190	NV	50	-80	-15.414258	20	PASS
11N40	ANT1	5230	NV	-30	0	0	20	PASS
11N40	ANT1	5230	NV	-20	-80	-15.296367	20	PASS
11N40	ANT1	5230	NV	-10	0	0	20	PASS
11N40	ANT1	5230	NV	0	-80	-15.296367	20	PASS
11N40	ANT1	5230	NV	10	-80	-15.296367	20	PASS
11N40	ANT1	5230	NV	20	0	0	20	PASS
11N40	ANT1	5230	NV	30	0	0	20	PASS
11N40	ANT1	5230	NV	40	0	0	20	PASS
11N40	ANT1	5230	NV	50	0	0	20	PASS
11N40	ANT2	5230	NV	-30	-80	-15.296367	20	PASS
11N40	ANT2	5230	NV	-20	-80	-15.296367	20	PASS
11N40	ANT2	5230	NV	-10	-80	-15.296367	20	PASS
11N40	ANT2	5230	NV	0	0	0	20	PASS
11N40	ANT2	5230	NV	10	-80	-15.296367	20	PASS
11N40	ANT2	5230	NV	20	0	0	20	PASS
11N40	ANT2	5230	NV	30	-80	-15.296367	20	PASS
11N40	ANT2	5230	NV	40	-80	-15.296367	20	PASS
11N40	ANT2	5230	NV	50	-80	-15.296367	20	PASS
11N40	ANT1	5270	NV	-30	0	0	20	PASS
11N40	ANT1	5270	NV	-20	0	0	20	PASS
11N40	ANT1	5270	NV	-10	-80	-15.180266	20	PASS
11N40	ANT1	5270	NV	0	-80	-15.180266	20	PASS
11N40	ANT1	5270	NV	10	-80	-15.180266	20	PASS
11N40	ANT1	5270	NV	20	0	0	20	PASS
11N40	ANT1	5270	NV	30	0	0	20	PASS
11N40	ANT1	5270	NV	40	0	0	20	PASS
11N40	ANT1	5270	NV	50	0	0	20	PASS
11N40	ANT2	5270	NV	-30	0	0	20	PASS
11N40	ANT2	5270	NV	-20	0	0	20	PASS

11N40	ANT2	5270	NV	-10	-80	-15.180266	20	PASS
11N40	ANT2	5270	NV	0	-80	-15.180266	20	PASS
11N40	ANT2	5270	NV	10	-80	-15.180266	20	PASS
11N40	ANT2	5270	NV	20	0	0	20	PASS
11N40	ANT2	5270	NV	30	-80	-15.180266	20	PASS
11N40	ANT2	5270	NV	40	-80	-15.180266	20	PASS
11N40	ANT2	5270	NV	50	0	0	20	PASS
11N40	ANT1	5310	NV	-30	0	0	20	PASS
11N40	ANT1	5310	NV	-20	0	0	20	PASS
11N40	ANT1	5310	NV	-10	0	0	20	PASS
11N40	ANT1	5310	NV	0	-80	-15.065913	20	PASS
11N40	ANT1	5310	NV	10	0	0	20	PASS
11N40	ANT1	5310	NV	20	0	0	20	PASS
11N40	ANT1	5310	NV	30	0	0	20	PASS
11N40	ANT1	5310	NV	40	0	0	20	PASS
11N40	ANT1	5310	NV	50	0	0	20	PASS
11N40	ANT2	5310	NV	-30	0	0	20	PASS
11N40	ANT2	5310	NV	-20	0	0	20	PASS
11N40	ANT2	5310	NV	-10	0	0	20	PASS
11N40	ANT2	5310	NV	0	0	0	20	PASS
11N40	ANT2	5310	NV	10	0	0	20	PASS
11N40	ANT2	5310	NV	20	0	0	20	PASS
11N40	ANT2	5310	NV	30	0	0	20	PASS
11N40	ANT2	5310	NV	40	0	0	20	PASS
11N40	ANT2	5310	NV	50	0	0	20	PASS
11N40	ANT1	5510	NV	-30	-80	-14.519056	20	PASS
11N40	ANT1	5510	NV	-20	-80	-14.519056	20	PASS
11N40	ANT1	5510	NV	-10	0	0	20	PASS
11N40	ANT1	5510	NV	0	-80	-14.519056	20	PASS
11N40	ANT1	5510	NV	10	0	0	20	PASS
11N40	ANT1	5510	NV	20	0	0	20	PASS
11N40	ANT1	5510	NV	30	0	0	20	PASS
11N40	ANT1	5510	NV	40	0	0	20	PASS
11N40	ANT1	5510	NV	50	0	0	20	PASS
11N40	ANT2	5510	NV	-30	0	0	20	PASS
11N40	ANT2	5510	NV	-20	-80	-14.519056	20	PASS
11N40	ANT2	5510	NV	-10	0	0	20	PASS
11N40	ANT2	5510	NV	0	0	0	20	PASS
11N40	ANT2	5510	NV	10	0	0	20	PASS

11N40	ANT2	5510	NV	20	0	0	20	PASS
11N40	ANT2	5510	NV	30	0	0	20	PASS
11N40	ANT2	5510	NV	40	0	0	20	PASS
11N40	ANT2	5510	NV	50	0	0	20	PASS
11N40	ANT1	5550	NV	-30	0	0	20	PASS
11N40	ANT1	5550	NV	-20	-80	-14.414414	20	PASS
11N40	ANT1	5550	NV	-10	-80	-14.414414	20	PASS
11N40	ANT1	5550	NV	0	-80	-14.414414	20	PASS
11N40	ANT1	5550	NV	10	0	0	20	PASS
11N40	ANT1	5550	NV	20	-80	-14.414414	20	PASS
11N40	ANT1	5550	NV	30	-80	-14.414414	20	PASS
11N40	ANT1	5550	NV	40	0	0	20	PASS
11N40	ANT1	5550	NV	50	0	0	20	PASS
11N40	ANT2	5550	NV	-30	-80	-14.414414	20	PASS
11N40	ANT2	5550	NV	-20	0	0	20	PASS
11N40	ANT2	5550	NV	-10	-80	-14.414414	20	PASS
11N40	ANT2	5550	NV	0	0	0	20	PASS
11N40	ANT2	5550	NV	10	-80	-14.414414	20	PASS
11N40	ANT2	5550	NV	20	0	0	20	PASS
11N40	ANT2	5550	NV	30	0	0	20	PASS
11N40	ANT2	5550	NV	40	0	0	20	PASS
11N40	ANT2	5550	NV	50	-80	-14.414414	20	PASS
11N40	ANT1	5670	NV	-30	-80	-14.109347	20	PASS
11N40	ANT1	5670	NV	-20	-80	-14.109347	20	PASS
11N40	ANT1	5670	NV	-10	-80	-14.109347	20	PASS
11N40	ANT1	5670	NV	0	-80	-14.109347	20	PASS
11N40	ANT1	5670	NV	10	-80	-14.109347	20	PASS
11N40	ANT1	5670	NV	20	0	0	20	PASS
11N40	ANT1	5670	NV	30	-80	-14.109347	20	PASS
11N40	ANT1	5670	NV	40	-80	-14.109347	20	PASS
11N40	ANT1	5670	NV	50	-80	-14.109347	20	PASS
11N40	ANT2	5670	NV	-30	-80	-14.109347	20	PASS
11N40	ANT2	5670	NV	-20	-80	-14.109347	20	PASS
11N40	ANT2	5670	NV	-10	0	0	20	PASS
11N40	ANT2	5670	NV	0	-80	-14.109347	20	PASS
11N40	ANT2	5670	NV	10	-80	-14.109347	20	PASS
11N40	ANT2	5670	NV	20	-80	-14.109347	20	PASS
11N40	ANT2	5670	NV	30	-80	-14.109347	20	PASS
11N40	ANT2	5670	NV	40	0	0	20	PASS

11N40	ANT2	5670	NV	50	-80	-14.109347	20	PASS
11N40	ANT1	5755	NV	-30	-80	-13.900956	20	PASS
11N40	ANT1	5755	NV	-20	0	0	20	PASS
11N40	ANT1	5755	NV	-10	0	0	20	PASS
11N40	ANT1	5755	NV	0	-80	-13.900956	20	PASS
11N40	ANT1	5755	NV	10	-80	-13.900956	20	PASS
11N40	ANT1	5755	NV	20	-80	-13.900956	20	PASS
11N40	ANT1	5755	NV	30	-80	-13.900956	20	PASS
11N40	ANT1	5755	NV	40	-80	-13.900956	20	PASS
11N40	ANT1	5755	NV	50	0	0	20	PASS
11N40	ANT2	5755	NV	-30	-80	-13.900956	20	PASS
11N40	ANT2	5755	NV	-20	0	0	20	PASS
11N40	ANT2	5755	NV	-10	-80	-13.900956	20	PASS
11N40	ANT2	5755	NV	0	-80	-13.900956	20	PASS
11N40	ANT2	5755	NV	10	0	0	20	PASS
11N40	ANT2	5755	NV	20	0	0	20	PASS
11N40	ANT2	5755	NV	30	0	0	20	PASS
11N40	ANT2	5755	NV	40	-80	-13.900956	20	PASS
11N40	ANT2	5755	NV	50	-80	-13.900956	20	PASS
11N40	ANT1	5795	NV	-30	0	0	20	PASS
11N40	ANT1	5795	NV	-20	0	0	20	PASS
11N40	ANT1	5795	NV	-10	-80	-13.805004	20	PASS
11N40	ANT1	5795	NV	0	0	0	20	PASS
11N40	ANT1	5795	NV	10	0	0	20	PASS
11N40	ANT1	5795	NV	20	0	0	20	PASS
11N40	ANT1	5795	NV	30	0	0	20	PASS
11N40	ANT1	5795	NV	40	0	0	20	PASS
11N40	ANT1	5795	NV	50	0	0	20	PASS
11N40	ANT2	5795	NV	-30	-80	-13.805004	20	PASS
11N40	ANT2	5795	NV	-20	-80	-13.805004	20	PASS
11N40	ANT2	5795	NV	-10	0	0	20	PASS
11N40	ANT2	5795	NV	0	0	0	20	PASS
11N40	ANT2	5795	NV	10	0	0	20	PASS
11N40	ANT2	5795	NV	20	0	0	20	PASS
11N40	ANT2	5795	NV	30	0	0	20	PASS
11N40	ANT2	5795	NV	40	0	0	20	PASS
11N40	ANT2	5795	NV	50	0	0	20	PASS
11AC20	ANT1	5180	NV	-30	0	0	20	PASS
11AC20	ANT1	5180	NV	-20	-80	-15.444015	20	PASS

11AC20	ANT1	5180	NV	-10	0	0	20	PASS
11AC20	ANT1	5180	NV	0	0	0	20	PASS
11AC20	ANT1	5180	NV	10	0	0	20	PASS
11AC20	ANT1	5180	NV	20	0	0	20	PASS
11AC20	ANT1	5180	NV	30	0	0	20	PASS
11AC20	ANT1	5180	NV	40	0	0	20	PASS
11AC20	ANT1	5180	NV	50	0	0	20	PASS
11AC20	ANT2	5180	NV	-30	0	0	20	PASS
11AC20	ANT2	5180	NV	-20	0	0	20	PASS
11AC20	ANT2	5180	NV	-10	0	0	20	PASS
11AC20	ANT2	5180	NV	0	0	0	20	PASS
11AC20	ANT2	5180	NV	10	0	0	20	PASS
11AC20	ANT2	5180	NV	20	-80	-15.444015	20	PASS
11AC20	ANT2	5180	NV	30	0	0	20	PASS
11AC20	ANT2	5180	NV	40	0	0	20	PASS
11AC20	ANT2	5180	NV	50	0	0	20	PASS
11AC20	ANT1	5200	NV	-30	0	0	20	PASS
11AC20	ANT1	5200	NV	-20	-80	-15.384615	20	PASS
11AC20	ANT1	5200	NV	-10	-80	-15.384615	20	PASS
11AC20	ANT1	5200	NV	0	-80	-15.384615	20	PASS
11AC20	ANT1	5200	NV	10	0	0	20	PASS
11AC20	ANT1	5200	NV	20	0	0	20	PASS
11AC20	ANT1	5200	NV	30	0	0	20	PASS
11AC20	ANT1	5200	NV	40	0	0	20	PASS
11AC20	ANT1	5200	NV	50	-80	-15.384615	20	PASS
11AC20	ANT2	5200	NV	-30	0	0	20	PASS
11AC20	ANT2	5200	NV	-20	0	0	20	PASS
11AC20	ANT2	5200	NV	-10	0	0	20	PASS
11AC20	ANT2	5200	NV	0	0	0	20	PASS
11AC20	ANT2	5200	NV	10	-80	-15.384615	20	PASS
11AC20	ANT2	5200	NV	20	0	0	20	PASS
11AC20	ANT2	5200	NV	30	0	0	20	PASS
11AC20	ANT2	5200	NV	40	-80	-15.384615	20	PASS
11AC20	ANT2	5200	NV	50	0	0	20	PASS
11AC20	ANT1	5240	NV	-30	-80	-15.267176	20	PASS
11AC20	ANT1	5240	NV	-20	-80	-15.267176	20	PASS
11AC20	ANT1	5240	NV	-10	-80	-15.267176	20	PASS
11AC20	ANT1	5240	NV	0	-80	-15.267176	20	PASS
11AC20	ANT1	5240	NV	10	-80	-15.267176	20	PASS

11AC20	ANT1	5240	NV	20	0	0	20	PASS
11AC20	ANT1	5240	NV	30	-80	-15.267176	20	PASS
11AC20	ANT1	5240	NV	40	-80	-15.267176	20	PASS
11AC20	ANT1	5240	NV	50	0	0	20	PASS
11AC20	ANT2	5240	NV	-30	0	0	20	PASS
11AC20	ANT2	5240	NV	-20	-80	-15.267176	20	PASS
11AC20	ANT2	5240	NV	-10	0	0	20	PASS
11AC20	ANT2	5240	NV	0	0	0	20	PASS
11AC20	ANT2	5240	NV	10	0	0	20	PASS
11AC20	ANT2	5240	NV	20	0	0	20	PASS
11AC20	ANT2	5240	NV	30	0	0	20	PASS
11AC20	ANT2	5240	NV	40	0	0	20	PASS
11AC20	ANT2	5240	NV	50	-80	-15.267176	20	PASS
11AC20	ANT1	5260	NV	-30	0	0	20	PASS
11AC20	ANT1	5260	NV	-20	-80	-15.209125	20	PASS
11AC20	ANT1	5260	NV	-10	-80	-15.209125	20	PASS
11AC20	ANT1	5260	NV	0	-80	-15.209125	20	PASS
11AC20	ANT1	5260	NV	10	-80	-15.209125	20	PASS
11AC20	ANT1	5260	NV	20	-80	-15.209125	20	PASS
11AC20	ANT1	5260	NV	30	-80	-15.209125	20	PASS
11AC20	ANT1	5260	NV	40	-80	-15.209125	20	PASS
11AC20	ANT1	5260	NV	50	0	0	20	PASS
11AC20	ANT2	5260	NV	-30	-80	-15.209125	20	PASS
11AC20	ANT2	5260	NV	-20	-80	-15.209125	20	PASS
11AC20	ANT2	5260	NV	-10	0	0	20	PASS
11AC20	ANT2	5260	NV	0	0	0	20	PASS
11AC20	ANT2	5260	NV	10	-80	-15.209125	20	PASS
11AC20	ANT2	5260	NV	20	-80	-15.209125	20	PASS
11AC20	ANT2	5260	NV	30	-80	-15.209125	20	PASS
11AC20	ANT2	5260	NV	40	-80	-15.209125	20	PASS
11AC20	ANT2	5260	NV	50	-80	-15.209125	20	PASS
11AC20	ANT1	5280	NV	-30	-80	-15.151515	20	PASS
11AC20	ANT1	5280	NV	-20	-80	-15.151515	20	PASS
11AC20	ANT1	5280	NV	-10	0	0	20	PASS
11AC20	ANT1	5280	NV	0	0	0	20	PASS
11AC20	ANT1	5280	NV	10	-80	-15.151515	20	PASS
11AC20	ANT1	5280	NV	20	0	0	20	PASS
11AC20	ANT1	5280	NV	30	-80	-15.151515	20	PASS
11AC20	ANT1	5280	NV	40	0	0	20	PASS

11AC20	ANT1	5280	NV	50	0	0	20	PASS
11AC20	ANT2	5280	NV	-30	-80	-15.151515	20	PASS
11AC20	ANT2	5280	NV	-20	-80	-15.151515	20	PASS
11AC20	ANT2	5280	NV	-10	-80	-15.151515	20	PASS
11AC20	ANT2	5280	NV	0	-80	-15.151515	20	PASS
11AC20	ANT2	5280	NV	10	0	0	20	PASS
11AC20	ANT2	5280	NV	20	0	0	20	PASS
11AC20	ANT2	5280	NV	30	0	0	20	PASS
11AC20	ANT2	5280	NV	40	0	0	20	PASS
11AC20	ANT2	5280	NV	50	-80	-15.151515	20	PASS
11AC20	ANT1	5320	NV	-30	-80	-15.037594	20	PASS
11AC20	ANT1	5320	NV	-20	0	0	20	PASS
11AC20	ANT1	5320	NV	-10	0	0	20	PASS
11AC20	ANT1	5320	NV	0	-80	-15.037594	20	PASS
11AC20	ANT1	5320	NV	10	0	0	20	PASS
11AC20	ANT1	5320	NV	20	0	0	20	PASS
11AC20	ANT1	5320	NV	30	-80	-15.037594	20	PASS
11AC20	ANT1	5320	NV	40	0	0	20	PASS
11AC20	ANT1	5320	NV	50	-80	-15.037594	20	PASS
11AC20	ANT2	5320	NV	-30	0	0	20	PASS
11AC20	ANT2	5320	NV	-20	-80	-15.037594	20	PASS
11AC20	ANT2	5320	NV	-10	-80	-15.037594	20	PASS
11AC20	ANT2	5320	NV	0	-80	-15.037594	20	PASS
11AC20	ANT2	5320	NV	10	0	0	20	PASS
11AC20	ANT2	5320	NV	20	-80	-15.037594	20	PASS
11AC20	ANT2	5320	NV	30	0	0	20	PASS
11AC20	ANT2	5320	NV	40	-80	-15.037594	20	PASS
11AC20	ANT2	5320	NV	50	-80	-15.037594	20	PASS
11AC20	ANT1	5500	NV	-30	-80	-14.545455	20	PASS
11AC20	ANT1	5500	NV	-20	-80	-14.545455	20	PASS
11AC20	ANT1	5500	NV	-10	0	0	20	PASS
11AC20	ANT1	5500	NV	0	-80	-14.545455	20	PASS
11AC20	ANT1	5500	NV	10	0	0	20	PASS
11AC20	ANT1	5500	NV	20	0	0	20	PASS
11AC20	ANT1	5500	NV	30	-80	-14.545455	20	PASS
11AC20	ANT1	5500	NV	40	-80	-14.545455	20	PASS
11AC20	ANT1	5500	NV	50	0	0	20	PASS
11AC20	ANT2	5500	NV	-30	0	0	20	PASS
11AC20	ANT2	5500	NV	-20	-80	-14.545455	20	PASS

11AC20	ANT2	5500	NV	-10	0	0	20	PASS
11AC20	ANT2	5500	NV	0	0	0	20	PASS
11AC20	ANT2	5500	NV	10	0	0	20	PASS
11AC20	ANT2	5500	NV	20	0	0	20	PASS
11AC20	ANT2	5500	NV	30	0	0	20	PASS
11AC20	ANT2	5500	NV	40	0	0	20	PASS
11AC20	ANT2	5500	NV	50	0	0	20	PASS
11AC20	ANT1	5580	NV	-30	-80	-14.336918	20	PASS
11AC20	ANT1	5580	NV	-20	0	0	20	PASS
11AC20	ANT1	5580	NV	-10	-80	-14.336918	20	PASS
11AC20	ANT1	5580	NV	0	0	0	20	PASS
11AC20	ANT1	5580	NV	10	0	0	20	PASS
11AC20	ANT1	5580	NV	20	-80	-14.336918	20	PASS
11AC20	ANT1	5580	NV	30	-80	-14.336918	20	PASS
11AC20	ANT1	5580	NV	40	0	0	20	PASS
11AC20	ANT1	5580	NV	50	-80	-14.336918	20	PASS
11AC20	ANT2	5580	NV	-30	-80	-14.336918	20	PASS
11AC20	ANT2	5580	NV	-20	-80	-14.336918	20	PASS
11AC20	ANT2	5580	NV	-10	-80	-14.336918	20	PASS
11AC20	ANT2	5580	NV	0	0	0	20	PASS
11AC20	ANT2	5580	NV	10	0	0	20	PASS
11AC20	ANT2	5580	NV	20	-80	-14.336918	20	PASS
11AC20	ANT2	5580	NV	30	0	0	20	PASS
11AC20	ANT2	5580	NV	40	-80	-14.336918	20	PASS
11AC20	ANT2	5580	NV	50	-80	-14.336918	20	PASS
11AC20	ANT1	5700	NV	-30	-80	-14.035088	20	PASS
11AC20	ANT1	5700	NV	-20	0	0	20	PASS
11AC20	ANT1	5700	NV	-10	-80	-14.035088	20	PASS
11AC20	ANT1	5700	NV	0	-80	-14.035088	20	PASS
11AC20	ANT1	5700	NV	10	-80	-14.035088	20	PASS
11AC20	ANT1	5700	NV	20	-80	-14.035088	20	PASS
11AC20	ANT1	5700	NV	30	-80	-14.035088	20	PASS
11AC20	ANT1	5700	NV	40	0	0	20	PASS
11AC20	ANT1	5700	NV	50	0	0	20	PASS
11AC20	ANT2	5700	NV	-30	-80	-14.035088	20	PASS
11AC20	ANT2	5700	NV	-20	0	0	20	PASS
11AC20	ANT2	5700	NV	-10	-80000	-14.035088	20	PASS
11AC20	ANT2	5700	NV	0	-80000	-14.035088	20	PASS
11AC20	ANT2	5700	NV	10	-80000	-14.035088	20	PASS

11AC20	ANT2	5700	NV	20	0	0	20	PASS
11AC20	ANT2	5700	NV	30	-80	-14.035088	20	PASS
11AC20	ANT2	5700	NV	40	0	0	20	PASS
11AC20	ANT2	5700	NV	50	-80	-14.035088	20	PASS
11AC20	ANT1	5745	NV	-30	0	0	20	PASS
11AC20	ANT1	5745	NV	-20	0	0	20	PASS
11AC20	ANT1	5745	NV	-10	0	0	20	PASS
11AC20	ANT1	5745	NV	0	0	0	20	PASS
11AC20	ANT1	5745	NV	10	0	0	20	PASS
11AC20	ANT1	5745	NV	20	-80	-13.925152	20	PASS
11AC20	ANT1	5745	NV	30	0	0	20	PASS
11AC20	ANT1	5745	NV	40	-80	-13.925152	20	PASS
11AC20	ANT1	5745	NV	50	-80	-13.925152	20	PASS
11AC20	ANT2	5745	NV	-30	-80	-13.925152	20	PASS
11AC20	ANT2	5745	NV	-20	-80	-13.925152	20	PASS
11AC20	ANT2	5745	NV	-10	0	0	20	PASS
11AC20	ANT2	5745	NV	0	-80	-13.925152	20	PASS
11AC20	ANT2	5745	NV	10	-80	-13.925152	20	PASS
11AC20	ANT2	5745	NV	20	-80	-13.925152	20	PASS
11AC20	ANT2	5745	NV	30	0	0	20	PASS
11AC20	ANT2	5745	NV	40	-80	-13.925152	20	PASS
11AC20	ANT2	5745	NV	50	-80	-13.925152	20	PASS
11AC20	ANT1	5785	NV	-30	0	0	20	PASS
11AC20	ANT1	5785	NV	-20	-80	-13.828868	20	PASS
11AC20	ANT1	5785	NV	-10	-80	-13.828868	20	PASS
11AC20	ANT1	5785	NV	0	-80	-13.828868	20	PASS
11AC20	ANT1	5785	NV	10	-80	-13.828868	20	PASS
11AC20	ANT1	5785	NV	20	-80	-13.828868	20	PASS
11AC20	ANT1	5785	NV	30	-80	-13.828868	20	PASS
11AC20	ANT1	5785	NV	40	-80	-13.828868	20	PASS
11AC20	ANT1	5785	NV	50	-80	-13.828868	20	PASS
11AC20	ANT2	5785	NV	-30	-80	-13.828868	20	PASS
11AC20	ANT2	5785	NV	-20	-80	-13.828868	20	PASS
11AC20	ANT2	5785	NV	-10	-80	-13.828868	20	PASS
11AC20	ANT2	5785	NV	0	-80	-13.828868	20	PASS
11AC20	ANT2	5785	NV	10	0	0	20	PASS
11AC20	ANT2	5785	NV	20	-80	-13.828868	20	PASS
11AC20	ANT2	5785	NV	30	-80	-13.828868	20	PASS
11AC20	ANT2	5785	NV	40	0	0	20	PASS

11AC20	ANT2	5785	NV	50	-80	-13.828868	20	PASS
11AC20	ANT1	5825	NV	-30	0	0	20	PASS
11AC20	ANT1	5825	NV	-20	0	0	20	PASS
11AC20	ANT1	5825	NV	-10	0	0	20	PASS
11AC20	ANT1	5825	NV	0	0	0	20	PASS
11AC20	ANT1	5825	NV	10	0	0	20	PASS
11AC20	ANT1	5825	NV	20	-80	-13.733906	20	PASS
11AC20	ANT1	5825	NV	30	0	0	20	PASS
11AC20	ANT1	5825	NV	40	-80	-13.733906	20	PASS
11AC20	ANT1	5825	NV	50	0	0	20	PASS
11AC20	ANT2	5825	NV	-30	-80	-13.733906	20	PASS
11AC20	ANT2	5825	NV	-20	0	0	20	PASS
11AC20	ANT2	5825	NV	-10	0	0	20	PASS
11AC20	ANT2	5825	NV	0	0	0	20	PASS
11AC20	ANT2	5825	NV	10	0	0	20	PASS
11AC20	ANT2	5825	NV	20	-80	-13.733906	20	PASS
11AC20	ANT2	5825	NV	30	-80	-13.733906	20	PASS
11AC20	ANT2	5825	NV	40	0	0	20	PASS
11AC20	ANT2	5825	NV	50	-80	-13.733906	20	PASS
11AC40	ANT1	5190	NV	-30	0	0	20	PASS
11AC40	ANT1	5190	NV	-20	-80	-15.414258	20	PASS
11AC40	ANT1	5190	NV	-10	0	0	20	PASS
11AC40	ANT1	5190	NV	0	0	0	20	PASS
11AC40	ANT1	5190	NV	10	0	0	20	PASS
11AC40	ANT1	5190	NV	20	0	0	20	PASS
11AC40	ANT1	5190	NV	30	0	0	20	PASS
11AC40	ANT1	5190	NV	40	0	0	20	PASS
11AC40	ANT1	5190	NV	50	0	0	20	PASS
11AC40	ANT2	5190	NV	-30	0	0	20	PASS
11AC40	ANT2	5190	NV	-20	0	0	20	PASS
11AC40	ANT2	5190	NV	-10	0	0	20	PASS
11AC40	ANT2	5190	NV	0	0	0	20	PASS
11AC40	ANT2	5190	NV	10	0	0	20	PASS
11AC40	ANT2	5190	NV	20	0	0	20	PASS
11AC40	ANT2	5190	NV	30	0	0	20	PASS
11AC40	ANT2	5190	NV	40	0	0	20	PASS
11AC40	ANT2	5190	NV	50	0	0	20	PASS
11AC40	ANT1	5230	NV	-30	0	0	20	PASS
11AC40	ANT1	5230	NV	-20	0	0	20	PASS

11AC40	ANT1	5230	NV	-10	0	0	20	PASS
11AC40	ANT1	5230	NV	0	0	0	20	PASS
11AC40	ANT1	5230	NV	10	0	0	20	PASS
11AC40	ANT1	5230	NV	20	0	0	20	PASS
11AC40	ANT1	5230	NV	30	0	0	20	PASS
11AC40	ANT1	5230	NV	40	0	0	20	PASS
11AC40	ANT1	5230	NV	50	0	0	20	PASS
11AC40	ANT2	5230	NV	-30	0	0	20	PASS
11AC40	ANT2	5230	NV	-20	-80	-15.296367	20	PASS
11AC40	ANT2	5230	NV	-10	0	0	20	PASS
11AC40	ANT2	5230	NV	0	0	0	20	PASS
11AC40	ANT2	5230	NV	10	0	0	20	PASS
11AC40	ANT2	5230	NV	20	0	0	20	PASS
11AC40	ANT2	5230	NV	30	0	0	20	PASS
11AC40	ANT2	5230	NV	40	0	0	20	PASS
11AC40	ANT2	5230	NV	50	0	0	20	PASS
11AC40	ANT1	5270	NV	-30	0	0	20	PASS
11AC40	ANT1	5270	NV	-20	0	0	20	PASS
11AC40	ANT1	5270	NV	-10	0	0	20	PASS
11AC40	ANT1	5270	NV	0	0	0	20	PASS
11AC40	ANT1	5270	NV	10	0	0	20	PASS
11AC40	ANT1	5270	NV	20	0	0	20	PASS
11AC40	ANT1	5270	NV	30	0	0	20	PASS
11AC40	ANT1	5270	NV	40	0	0	20	PASS
11AC40	ANT1	5270	NV	50	0	0	20	PASS
11AC40	ANT2	5270	NV	-30	0	0	20	PASS
11AC40	ANT2	5270	NV	-20	-80	-15.180266	20	PASS
11AC40	ANT2	5270	NV	-10	0	0	20	PASS
11AC40	ANT2	5270	NV	0	0	0	20	PASS
11AC40	ANT2	5270	NV	10	0	0	20	PASS
11AC40	ANT2	5270	NV	20	0	0	20	PASS
11AC40	ANT2	5270	NV	30	0	0	20	PASS
11AC40	ANT2	5270	NV	40	0	0	20	PASS
11AC40	ANT2	5270	NV	50	-80	-15.180266	20	PASS
11AC40	ANT1	5310	NV	-30	0	0	20	PASS
11AC40	ANT1	5310	NV	-20	0	0	20	PASS
11AC40	ANT1	5310	NV	-10	0	0	20	PASS
11AC40	ANT1	5310	NV	0	0	0	20	PASS
11AC40	ANT1	5310	NV	10	-80	-15.065913	20	PASS

11AC40	ANT1	5310	NV	20	0	0	20	PASS
11AC40	ANT1	5310	NV	30	0	0	20	PASS
11AC40	ANT1	5310	NV	40	0	0	20	PASS
11AC40	ANT1	5310	NV	50	0	0	20	PASS
11AC40	ANT2	5310	NV	-30	0	0	20	PASS
11AC40	ANT2	5310	NV	-20	0	0	20	PASS
11AC40	ANT2	5310	NV	-10	0	0	20	PASS
11AC40	ANT2	5310	NV	0	0	0	20	PASS
11AC40	ANT2	5310	NV	10	0	0	20	PASS
11AC40	ANT2	5310	NV	20	0	0	20	PASS
11AC40	ANT2	5310	NV	30	0	0	20	PASS
11AC40	ANT2	5310	NV	40	0	0	20	PASS
11AC40	ANT2	5310	NV	50	0	0	20	PASS
11AC40	ANT1	5510	NV	-30	0	0	20	PASS
11AC40	ANT1	5510	NV	-20	0	0	20	PASS
11AC40	ANT1	5510	NV	-10	0	0	20	PASS
11AC40	ANT1	5510	NV	0	0	0	20	PASS
11AC40	ANT1	5510	NV	10	0	0	20	PASS
11AC40	ANT1	5510	NV	20	0	0	20	PASS
11AC40	ANT1	5510	NV	30	80	14.519056	20	PASS
11AC40	ANT1	5510	NV	40	0	0	20	PASS
11AC40	ANT1	5510	NV	50	0	0	20	PASS
11AC40	ANT2	5510	NV	-30	0	0	20	PASS
11AC40	ANT2	5510	NV	-20	0	0	20	PASS
11AC40	ANT2	5510	NV	-10	0	0	20	PASS
11AC40	ANT2	5510	NV	0	0	0	20	PASS
11AC40	ANT2	5510	NV	10	0	0	20	PASS
11AC40	ANT2	5510	NV	20	0	0	20	PASS
11AC40	ANT2	5510	NV	30	0	0	20	PASS
11AC40	ANT2	5510	NV	40	-80	-14.519056	20	PASS
11AC40	ANT2	5510	NV	50	0	0	20	PASS
11AC40	ANT1	5550	NV	-30	0	0	20	PASS
11AC40	ANT1	5550	NV	-20	0	0	20	PASS
11AC40	ANT1	5550	NV	-10	0	0	20	PASS
11AC40	ANT1	5550	NV	0	0	0	20	PASS
11AC40	ANT1	5550	NV	10	0	0	20	PASS
11AC40	ANT1	5550	NV	20	0	0	20	PASS
11AC40	ANT1	5550	NV	30	80	14.414414	20	PASS
11AC40	ANT1	5550	NV	40	-80	-14.414414	20	PASS

11AC40	ANT1	5550	NV	50	80	14.414414	20	PASS
11AC40	ANT2	5550	NV	-30	0	0	20	PASS
11AC40	ANT2	5550	NV	-20	0	0	20	PASS
11AC40	ANT2	5550	NV	-10	0	0	20	PASS
11AC40	ANT2	5550	NV	0	0	0	20	PASS
11AC40	ANT2	5550	NV	10	0	0	20	PASS
11AC40	ANT2	5550	NV	20	0	0	20	PASS
11AC40	ANT2	5550	NV	30	0	0	20	PASS
11AC40	ANT2	5550	NV	40	0	0	20	PASS
11AC40	ANT2	5550	NV	50	-80	-14.414414	20	PASS
11AC40	ANT1	5670	NV	-30	0	0	20	PASS
11AC40	ANT1	5670	NV	-20	0	0	20	PASS
11AC40	ANT1	5670	NV	-10	0	0	20	PASS
11AC40	ANT1	5670	NV	0	-80	-14.109347	20	PASS
11AC40	ANT1	5670	NV	10	0	0	20	PASS
11AC40	ANT1	5670	NV	20	-80	-14.109347	20	PASS
11AC40	ANT1	5670	NV	30	0	0	20	PASS
11AC40	ANT1	5670	NV	40	-80	-14.109347	20	PASS
11AC40	ANT1	5670	NV	50	0	0	20	PASS
11AC40	ANT2	5670	NV	-30	0	0	20	PASS
11AC40	ANT2	5670	NV	-20	0	0	20	PASS
11AC40	ANT2	5670	NV	-10	-80	-14.109347	20	PASS
11AC40	ANT2	5670	NV	0	0	0	20	PASS
11AC40	ANT2	5670	NV	10	0	0	20	PASS
11AC40	ANT2	5670	NV	20	0	0	20	PASS
11AC40	ANT2	5670	NV	30	0	0	20	PASS
11AC40	ANT2	5670	NV	40	80	14.109347	20	PASS
11AC40	ANT2	5670	NV	50	0	0	20	PASS
11AC40	ANT1	5755	NV	-30	0	0	20	PASS
11AC40	ANT1	5755	NV	-20	0	0	20	PASS
11AC40	ANT1	5755	NV	-10	0	0	20	PASS
11AC40	ANT1	5755	NV	0	0	0	20	PASS
11AC40	ANT1	5755	NV	10	0	0	20	PASS
11AC40	ANT1	5755	NV	20	-80	-13.900956	20	PASS
11AC40	ANT1	5755	NV	30	0	0	20	PASS
11AC40	ANT1	5755	NV	40	0	0	20	PASS
11AC40	ANT1	5755	NV	50	0	0	20	PASS
11AC40	ANT2	5755	NV	-30	0	0	20	PASS
11AC40	ANT2	5755	NV	-20	0	0	20	PASS

11AC40	ANT2	5755	NV	-10	0	0	20	PASS
11AC40	ANT2	5755	NV	0	0	0	20	PASS
11AC40	ANT2	5755	NV	10	0	0	20	PASS
11AC40	ANT2	5755	NV	20	0	0	20	PASS
11AC40	ANT2	5755	NV	30	0	0	20	PASS
11AC40	ANT2	5755	NV	40	0	0	20	PASS
11AC40	ANT2	5755	NV	50	0	0	20	PASS
11AC40	ANT1	5795	NV	-30	0	0	20	PASS
11AC40	ANT1	5795	NV	-20	0	0	20	PASS
11AC40	ANT1	5795	NV	-10	0	0	20	PASS
11AC40	ANT1	5795	NV	0	0	0	20	PASS
11AC40	ANT1	5795	NV	10	0	0	20	PASS
11AC40	ANT1	5795	NV	20	0	0	20	PASS
11AC40	ANT1	5795	NV	30	0	0	20	PASS
11AC40	ANT1	5795	NV	40	0	0	20	PASS
11AC40	ANT1	5795	NV	50	0	0	20	PASS
11AC40	ANT2	5795	NV	-30	0	0	20	PASS
11AC40	ANT2	5795	NV	-20	0	0	20	PASS
11AC40	ANT2	5795	NV	-10	0	0	20	PASS
11AC40	ANT2	5795	NV	0	0	0	20	PASS
11AC40	ANT2	5795	NV	10	0	0	20	PASS
11AC40	ANT2	5795	NV	20	0	0	20	PASS
11AC40	ANT2	5795	NV	30	0	0	20	PASS
11AC40	ANT2	5795	NV	40	0	0	20	PASS
11AC40	ANT2	5795	NV	50	0	0	20	PASS
11AC80	ANT1	5210	NV	-30	0	0	20	PASS
11AC80	ANT1	5210	NV	-20	0	0	20	PASS
11AC80	ANT1	5210	NV	-10	0	0	20	PASS
11AC80	ANT1	5210	NV	0	0	0	20	PASS
11AC80	ANT1	5210	NV	10	0	0	20	PASS
11AC80	ANT1	5210	NV	20	0	0	20	PASS
11AC80	ANT1	5210	NV	30	-80	-15.355086	20	PASS
11AC80	ANT1	5210	NV	40	0	0	20	PASS
11AC80	ANT1	5210	NV	50	-80	-15.355086	20	PASS
11AC80	ANT2	5210	NV	-30	0	0	20	PASS
11AC80	ANT2	5210	NV	-20	0	0	20	PASS
11AC80	ANT2	5210	NV	-10	0	0	20	PASS
11AC80	ANT2	5210	NV	0	0	0	20	PASS
11AC80	ANT2	5210	NV	10	0	0	20	PASS

11AC80	ANT2	5210	NV	20	-80	-15.355086	20	PASS
11AC80	ANT2	5210	NV	30	0	0	20	PASS
11AC80	ANT2	5210	NV	40	-80	-15.355086	20	PASS
11AC80	ANT2	5210	NV	50	-80	-15.355086	20	PASS
11AC80	ANT1	5290	NV	-30	-80	-15.122873	20	PASS
11AC80	ANT1	5290	NV	-20	-80	-15.122873	20	PASS
11AC80	ANT1	5290	NV	-10	0	0	20	PASS
11AC80	ANT1	5290	NV	0	0	0	20	PASS
11AC80	ANT1	5290	NV	10	0	0	20	PASS
11AC80	ANT1	5290	NV	20	-80	-15.122873	20	PASS
11AC80	ANT1	5290	NV	30	-80	-15.122873	20	PASS
11AC80	ANT1	5290	NV	40	-80	-15.122873	20	PASS
11AC80	ANT1	5290	NV	50	-80	-15.122873	20	PASS
11AC80	ANT2	5290	NV	-30	0	0	20	PASS
11AC80	ANT2	5290	NV	-20	-80	-15.122873	20	PASS
11AC80	ANT2	5290	NV	-10	-80	-15.122873	20	PASS
11AC80	ANT2	5290	NV	0	-80	-15.122873	20	PASS
11AC80	ANT2	5290	NV	10	-80	-15.122873	20	PASS
11AC80	ANT2	5290	NV	20	-80	-15.122873	20	PASS
11AC80	ANT2	5290	NV	30	-80	-15.122873	20	PASS
11AC80	ANT2	5290	NV	40	0	0	20	PASS
11AC80	ANT2	5290	NV	50	-80	-15.122873	20	PASS
11AC80	ANT1	5530	NV	-30	0	0	20	PASS
11AC80	ANT1	5530	NV	-20	-80	-14.466546	20	PASS
11AC80	ANT1	5530	NV	-10	0	0	20	PASS
11AC80	ANT1	5530	NV	0	0	0	20	PASS
11AC80	ANT1	5530	NV	10	0	0	20	PASS
11AC80	ANT1	5530	NV	20	0	0	20	PASS
11AC80	ANT1	5530	NV	30	0	0	20	PASS
11AC80	ANT1	5530	NV	40	-80	-14.466546	20	PASS
11AC80	ANT1	5530	NV	50	-80	-14.466546	20	PASS
11AC80	ANT2	5530	NV	-30	0	0	20	PASS
11AC80	ANT2	5530	NV	-20	0	0	20	PASS
11AC80	ANT2	5530	NV	-10	-80	-14.466546	20	PASS
11AC80	ANT2	5530	NV	0	-80	-14.466546	20	PASS
11AC80	ANT2	5530	NV	10	0	0	20	PASS
11AC80	ANT2	5530	NV	20	0	0	20	PASS
11AC80	ANT2	5530	NV	30	-80	-14.466546	20	PASS
11AC80	ANT2	5530	NV	40	0	0	20	PASS

11AC80	ANT2	5530	NV	50	0	0	20	PASS
11AC80	ANT1	5775	NV	-30	0	0	20	PASS
11AC80	ANT1	5775	NV	-20	-80	-13.852814	20	PASS
11AC80	ANT1	5775	NV	-10	0	0	20	PASS
11AC80	ANT1	5775	NV	0	0	0	20	PASS
11AC80	ANT1	5775	NV	10	0	0	20	PASS
11AC80	ANT1	5775	NV	20	0	0	20	PASS
11AC80	ANT1	5775	NV	30	0	0	20	PASS
11AC80	ANT1	5775	NV	40	0	0	20	PASS
11AC80	ANT1	5775	NV	50	0	0	20	PASS
11AC80	ANT2	5775	NV	-30	0	0	20	PASS
11AC80	ANT2	5775	NV	-20	0	0	20	PASS
11AC80	ANT2	5775	NV	-10	0	0	20	PASS
11AC80	ANT2	5775	NV	0	0	0	20	PASS
11AC80	ANT2	5775	NV	10	0	0	20	PASS
11AC80	ANT2	5775	NV	20	0	0	20	PASS
11AC80	ANT2	5775	NV	30	0	0	20	PASS
11AC80	ANT2	5775	NV	40	0	0	20	PASS
11AC80	ANT2	5775	NV	50	0	0	20	PASS

8. Emissions in restricted frequency bands

8.1. Block diagram of test setup

In 3m Anechoic Chamber Test Setup Diagram for 9kHz-30MHz

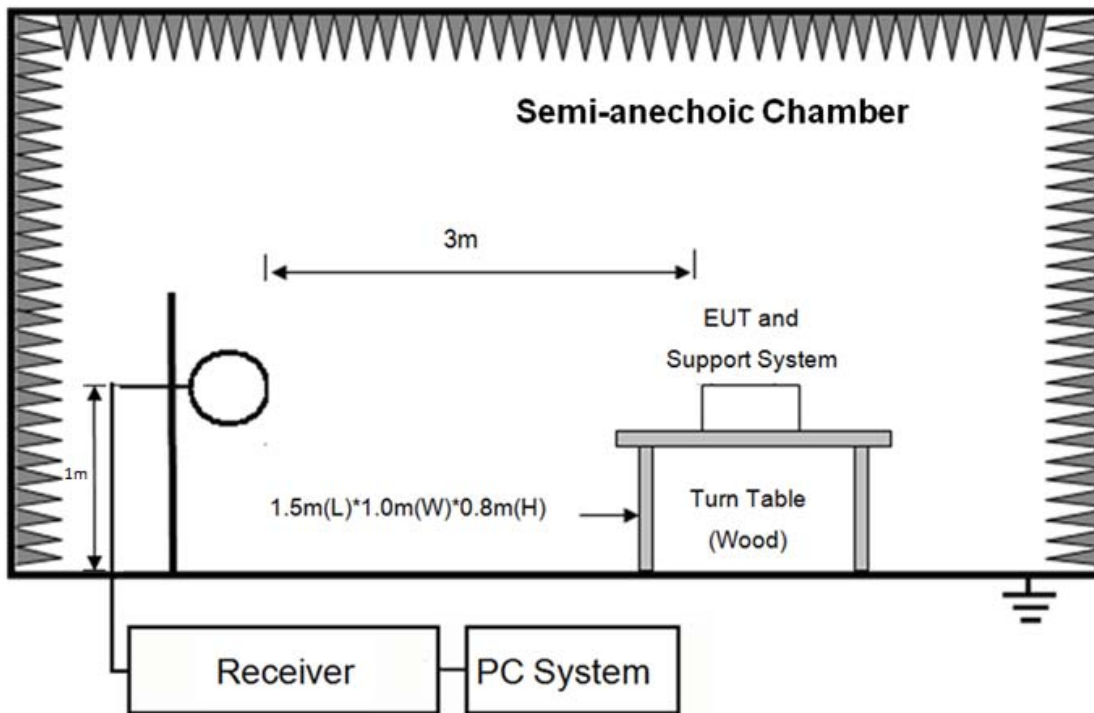

In 3m Anechoic Chamber Test Setup Diagram for 30MHz-1GHz

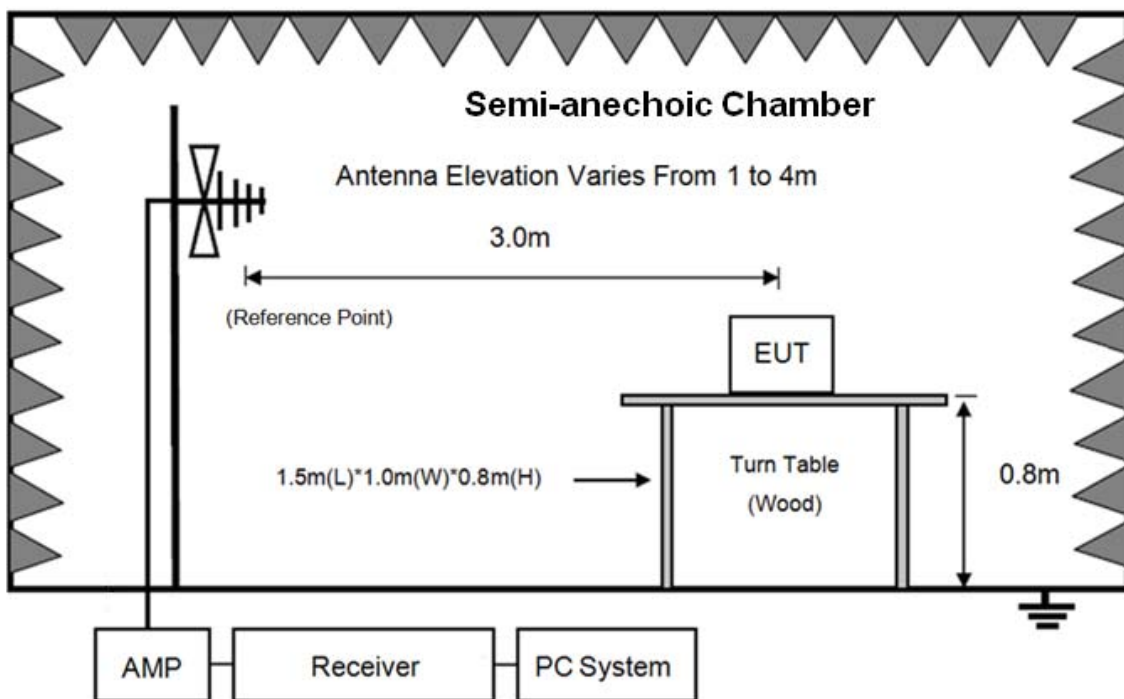

In 3m Anechoic Chamber Test Setup Diagram for frequency above 1GHz

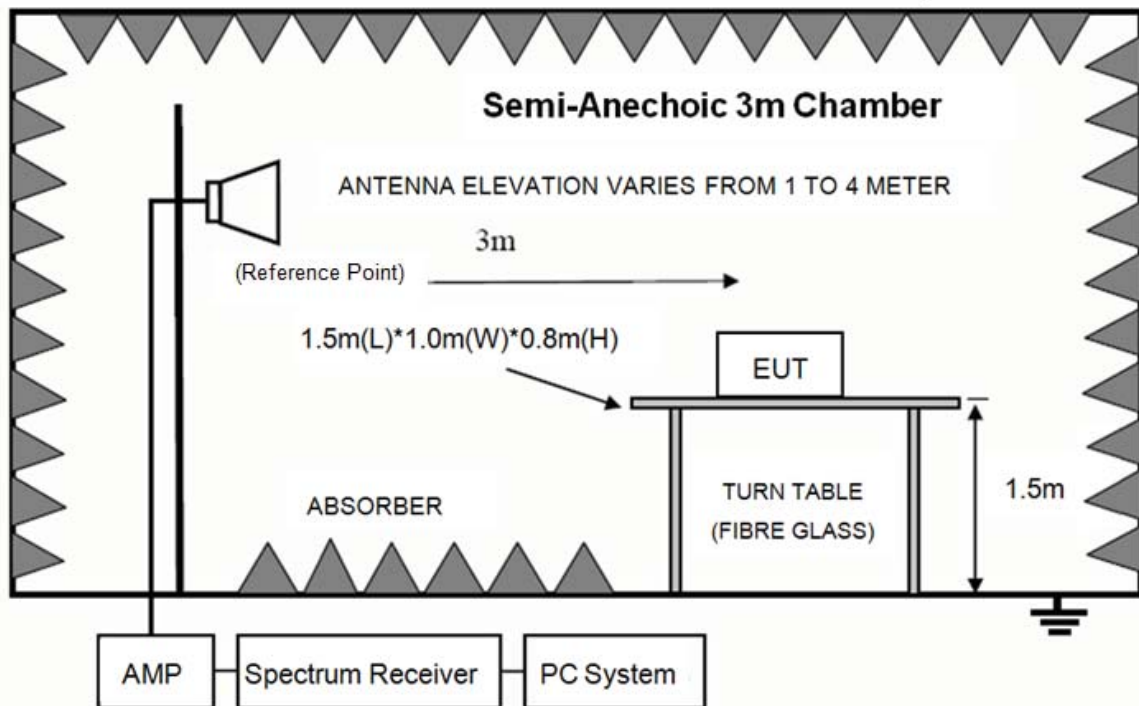

Note: For harmonic emissions test an appropriate high pass filter was inserted in the input port of AMP.

8.2. Limit

8.3.1 FCC 15.205 Restricted frequency band

MHz	MHz	MHz	GHz
0.090-0.110	16.42-16.423	399.9-410	4.5-5.15
10.495-0.505	16.69475-16.69525	608-614	5.35-5.46
2.1735-2.1905	16.80425-16.80475	960-1240	7.25-7.75
4.125-4.128	25.5-25.67	1300-1427	8.025-8.5
4.1772&4.17775	37.5-38.25	1435-1626.5	9.0-9.2
4.2072&4.20775	73-74.6	1645.5-1646.5	9.3-9.5
6.215-6.218	74.8-75.2	1660-1710	10.6-12.7
6.26775-6.26825	108-121.94	1718.8-1722.2	13.25-13.4
6.31175-6.31225	123-138	2200-2300	14.47-14.5
8.291-8.294	149.9-150.05	2310-2390	15.35-16.2
8.362-8.366	156.52475-156.52525	2483.5-2500	17.7-21.4
8.37625-8.38675	156.7-156.9	2690-2900	22.01-23.12
8.41425-8.41475	162.0125-167.17	3260-3267	23.6-24.0
12.29-12.293	167.72-173.2	3332-3339	31.2-31.8
12.51975-12.52025	240-285	3345.8-3358	36.43-36.5
12.57675-12.57725	322-335.4	3600-4400	(²)
13.36-13.41			

8.3.2 FCC 15.209 Limit.

FREQUENCY MHz	DISTANCE Meters	FIELD STRENGTHS LIMIT	
		$\mu\text{V}/\text{m}$	$\text{dB}(\mu\text{V})/\text{m}$
0.009 ~ 0.490	300	2400/F(kHz)	67.6-20log(F)
0.490 ~ 1.705	30	24000/F(kHz)	87.6-20log(F)
1.705 ~ 30.0	30	30	29.54
30 ~ 88	3	100	40.0
88 ~ 216	3	150	43.5
216 ~ 960	3	200	46.0
960 ~ 1000	3	500	54.0
Above 1000	3	74.0 dB(μV)/m (Peak) 54.0 dB(μV)/m (Average)	

Note: (1) The emission limits shown in the above table are based on measurements employing a CISPR QP detector except for the frequency bands 9-90kHz, 110-490kHz and above 1000MHz. Radiated emissions limits in these three bands are based on measurements employing an average detector.

(2) At frequencies below 30MHz, measurement may be performed at a distance closer than that specified, and the limit at closer measurement distance can be extrapolated by below formula:

$$\text{Limit}_{3\text{m}}(\text{dB}\mu\text{V}/\text{m}) = \text{Limit}_{30\text{m}}(\text{dB}\mu\text{V}/\text{m}) + 40\text{Log}(30\text{m}/3\text{m})$$

8.3.3 Limit for this EUT

All the emissions appearing within 15.205 restricted frequency bands shall not exceed the limits shown in 15.209, all the other emissions shall be at least 20dB below the fundamental emissions or comply with 15.209 limits.

8.3. Test Procedure

- (1) EUT height should be 0.8 m for below 1 GHz at a semi - anechoic chamber while EUT height should be 1.5 m for above 1GHz at full chamber or semi - anechoic chamber ground with absorbers
- (2) Setup EUT and assistant system according clause 2.3 and 8.2
- (3) Test antenna was located 3m from the EUT on an adjustable mast, and the antenna used as below table.

Test frequency range	Test antenna used	Test distance
9 kHz-30 MHz	Active Loop antenna	3 m
30 MHz-1 GHz	Trilog Broadband Antenna	3 m
1 GHz-18 GHz	Double Ridged Horn Antenna(1GHz-18GHz)	3 m
18 GHz-40 GHz	Horn Antenna(18GHz-40GHz)	1 m

According ANSI C63.10:2013 clause 6.4.4.2 and 6.5.3, for measurements below 30 MHz, the loop antenna was positioned with its plane vertical from the EUT and rotated about its vertical

axis for maximum response at each azimuth position around the EUT. And the loop antenna also be positioned with its plane horizontal at the specified distance from the EUT. The center of the loop is 1 m above the ground. for measurement above 30 MHz, the Trilog Broadband Antenna or Horn Antenna was located 3m from EUT, Measurements were made with the antenna positioned in both the horizontal and vertical planes of Polarization, and the measurement antenna was varied from 1 m to 4 m. in height above the reference ground plane to obtain the maximum signal strength.

(4) Below pre-scan procedure was first performed in order to find prominent frequency spectrum radiated emissions from 9 kHz to 40 GHz:

(a) Scanning the peak frequency spectrum with the antenna specified in step (3), and the EUT was rotated 360 degree, the antenna height was varied from 1 m to 4 m (Except loop antenna, it's fixed 1m above ground.)

(b) Change work frequency or channel of device if practicable.

(c) Change modulation type of device if practicable.

(d) Change power supply range from 85% to 115% of the rated supply voltage

(e) Rotated EUT though three orthogonal axes to determine the attitude of EUT arrangement produces highest emissions.

Spectrum frequency from 9 kHz to 40 GHz (tenth harmonic of fundamental frequency) was investigated, and no any obvious emission were detected from 9 kHz to 30 MHz and 18 GHz to 40 GHz, so below final test was performed with frequency range from 30 MHz to 18 GHz.

(5) For final emissions measurements at each frequency of interest, the EUT was rotated and the antenna height was varied between 1m and 4m in order to maximize the emission. Measurements in both horizontal and vertical polarities were made and the data was recorded. In order to find the maximum emission, the relative positions of equipments and all of the interface cables were changed according to ANSI C63.10:2013 on Radiated Emission test.

(6) The emissions from 9 kHz to 1 GHz were measured based on CISPR QP detector except for the frequency bands 9-90 kHz, 110-490 kHz, for emissions from 9kHz-90kHz,110kHz-490kHz and above 1GHz were measured based on average detector, for emissions above 1 GHz, peak emissions also be measured and need comply with Peak limit.

(7) The emissions from 9 kHz to 1 GHz, QP or average values were measured with EMI receiver with below RBW

Frequency band	RBW
9 kHz-150 kHz	200 Hz
150 kHz-30 MHz	9 kHz
30 MHz-1 GHz	120 kHz

(8) For emissions above 1 GHz, both Peak and Average level were measured with Spectrum Analyzer, and the RBW is set at 1 MHz, VBW is set at 3MHz for Peak measure, the RBW is set at 1 MHz, VBW is set at 10 Hz for AV value.

8.4. Test result

PASS. (See below detailed test result)

All the emissions except fundamental emission from 9kHz to 40GHz were comply with 15.209 limit.

Note1: According exploratory test no any obvious emission was detected from 9 kHz to 30 MHz and 18 GHz to 40 GHz, so the final test was performed with frequency range from 30 MHz to 18 GHz and recorded in below.

Note2: For emissions below 1 GHz, according exploratory explorer test, when change Tx mode and channel, have no distinct influence on emissions level, so for emissions below 1 GHz, the final test was only performed with EUT working in 11a mode.

Note3: For below test data, when the limit tabular marked “/” means this frequency point is the fundamental emission and no need comply with this limit.

Radiated Emission test (below 1GHz)

TR-4-E-009 Radiated Emission Test Result

Test Site : DDT 3m Chamber 1# D:\2019 RE1# Report Data\Q19032116-1E\RE.EM6
 Test Date : 2019-04-19 Tested By : Alan
 EUT : WIRELESS SPEAKER Model Number : LINK MUSIC
 Power Supply : AC 120V/60Hz Test Mode : Tx mode
 Condition : Temp:24.5°C, Humi:55%, Press:100.1kPa Antenna/Distance : 2018 VULB 9163 1#/3m/VERTICAL

Memo :

Data: 23

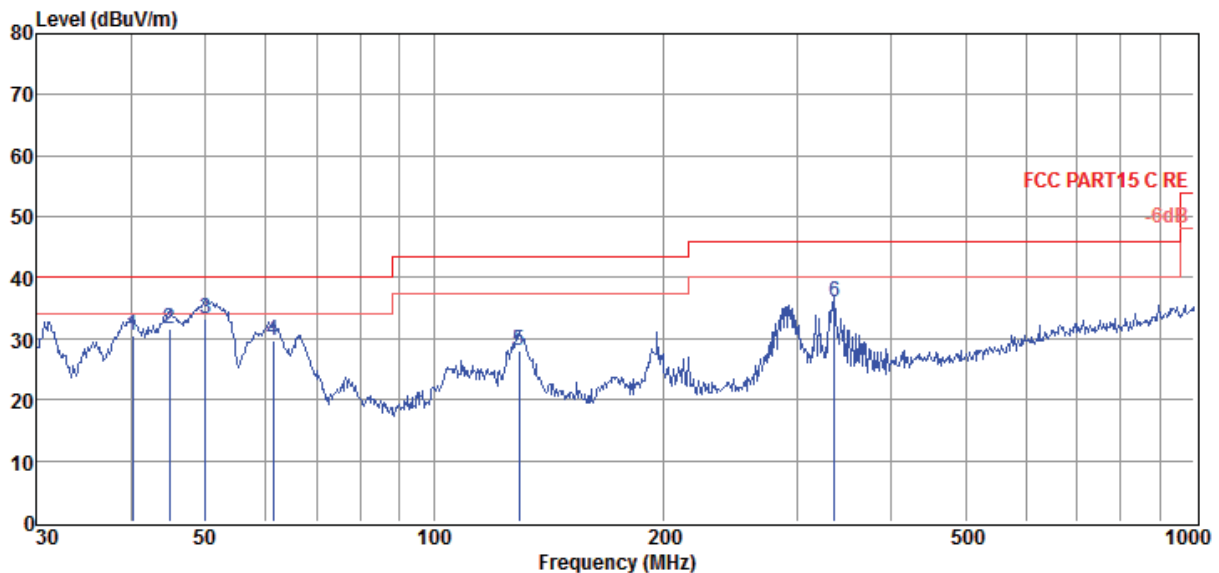

Item (Mark)	Freq. (MHz)	Read Level (dBμV)	Antenna Factor (dB/m)	Cable Loss (dB)	Result Level (dBμV/m)	Limit Line (dBμV/m)	Over Limit (dB)	Detector	Polarization
1	40.14	13.36	13.42	3.77	30.55	40.00	-9.45	QP	VERTICAL
2	44.90	13.79	14.02	3.82	31.63	40.00	-8.37	QP	VERTICAL
3	50.06	14.81	14.58	3.87	33.26	40.00	-6.74	QP	VERTICAL
4	61.35	14.70	11.13	3.96	29.79	40.00	-10.21	QP	VERTICAL
5	129.47	14.17	9.51	4.35	28.03	43.50	-15.47	QP	VERTICAL
6	336.04	15.98	14.63	5.31	35.92	46.00	-10.08	QP	VERTICAL

- Note: 1. Result Level = Read Level + Antenna Factor + Cable loss.
 2. If Peak Result complies with QP limit, QP Result is deemed to comply with QP limit.
 3. Test setup: RBW: 120 kHz, VBW: 300 kHz, Sweep time: auto.

TR-4-E-009 Radiated Emission Test Result

Test Site : DDT 3m Chamber 1# **D:\2019 RE1# Report Data\Q19032116-1E\RE.EM6**
Test Date : 2019-04-19 **Tested By** : Alan
EUT : WIRELESS SPEAKER **Model Number** : LINK MUSIC
Power Supply : AC 120V/60Hz **Test Mode** : Tx mode
Condition : Temp:24.5°C, Humi:55%, Press:100.1kPa **Antenna/Distance** : 2018 VULB 9163 1#/3m/HORIZONTAL
Memo :

Data: 24

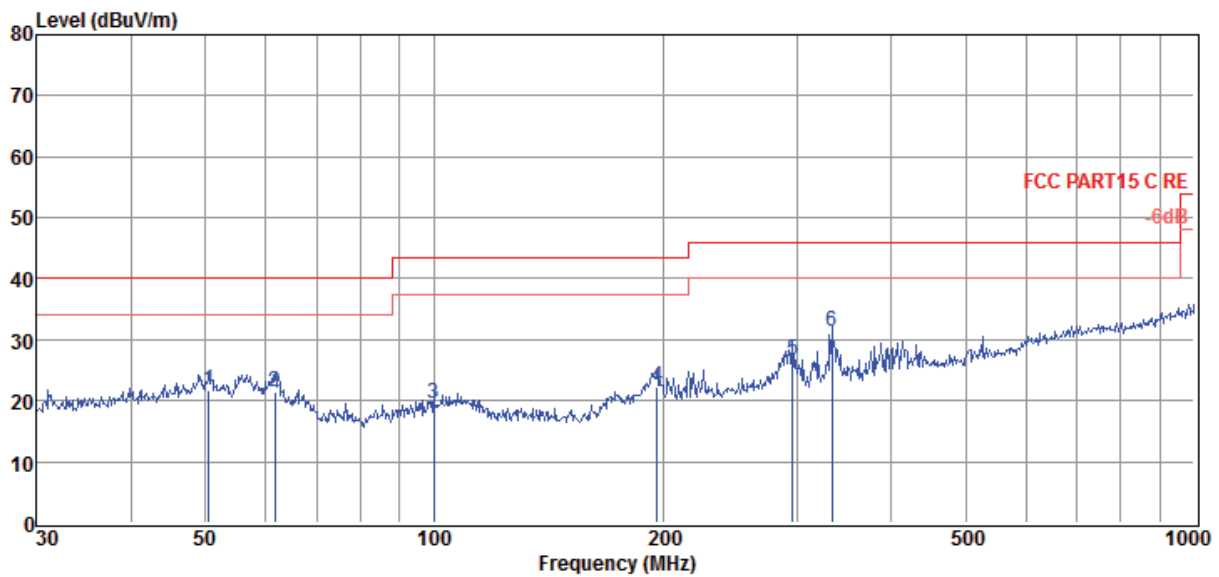

Item (Mark)	Freq. (MHz)	Read Level (dBμV)	Antenna Factor (dB/m)	Cable Loss (dB)	Result Level (dBμV/m)	Limit Line (dBμV/m)	Over Limit (dB)	Detector	Polarization
1	50.59	3.59	14.40	3.87	21.86	40.00	-18.14	QP	HORIZONTAL
2	61.78	6.55	11.04	3.96	21.55	40.00	-18.45	QP	HORIZONTAL
3	99.88	3.75	11.68	4.20	19.63	43.50	-23.87	QP	HORIZONTAL
4	196.51	6.42	10.92	4.80	22.14	43.50	-21.36	QP	HORIZONTAL
5	296.18	7.60	13.92	5.17	26.69	46.00	-19.31	QP	HORIZONTAL
6	333.69	11.45	14.59	5.30	31.34	46.00	-14.66	QP	HORIZONTAL

Note: 1. Result Level = Read Level + Antenna Factor + Cable loss.
 2. If Peak Result complies with QP limit, QP Result is deemed to comply with QP limit.
 3. Test setup: RBW: 120 kHz, VBW: 300 kHz, Sweep time: auto.

Radiated Emission test (above 1GHz)

Freq (MHz)	Read level (dBμV)	Antenna Factor (dB/m)	PRM Factor(dB)	Cable Loss (dB)	Result Level (dBμV/m)	Limit (dBμV/m)	Margin (dB)	Detector type	Polarization
11a CH36									
5675.00	40.70	34.44	44.06	11.19	42.27	74.00	-31.73	Peak	HORIZONTAL
7443.00	42.85	35.87	43.33	13.11	48.50	74.00	-25.50	Peak	HORIZONTAL
9075.00	39.52	36.85	43.67	14.37	47.07	74.00	-26.93	Peak	HORIZONTAL
10979.00	42.61	37.51	43.82	16.21	52.51	74.00	-21.49	Peak	HORIZONTAL
13087.00	35.77	38.42	43.30	18.98	49.87	74.00	-24.13	Peak	HORIZONTAL
15195.00	32.11	40.62	42.78	20.51	50.46	74.00	-23.54	Peak	HORIZONTAL
4910.00	41.34	33.85	44.22	9.83	40.80	74.00	-33.20	Peak	VERTICAL
6100.00	42.41	34.82	43.95	11.26	44.54	74.00	-29.46	Peak	VERTICAL
7426.00	40.98	35.86	43.33	13.10	46.61	74.00	-27.39	Peak	VERTICAL
9398.00	42.67	37.05	43.82	14.89	50.79	74.00	-23.21	Peak	VERTICAL
12067.00	40.05	38.01	43.54	17.90	52.42	74.00	-21.58	Peak	VERTICAL
14447.00	32.96	40.29	43.01	20.14	50.38	74.00	-23.62	Peak	VERTICAL
11a CH40									
6287.00	41.20	35.05	43.85	11.86	44.26	74.00	-29.74	Peak	HORIZONTAL
7698.00	38.72	36.06	43.22	13.01	44.57	74.00	-29.43	Peak	HORIZONTAL
9534.00	42.22	37.13	43.89	14.73	50.19	74.00	-23.81	Peak	HORIZONTAL
11370.00	41.55	38.32	43.72	16.83	52.98	74.00	-21.02	Peak	HORIZONTAL
13801.00	33.04	39.73	43.15	19.95	49.57	74.00	-24.43	Peak	HORIZONTAL
15671.00	29.91	40.74	42.49	21.63	49.79	74.00	-24.21	Peak	HORIZONTAL
5964.00	42.24	34.67	44.01	11.38	44.28	74.00	-29.72	Peak	VERTICAL
7409.00	43.17	35.85	43.34	13.09	48.77	74.00	-25.23	Peak	VERTICAL
8973.00	41.73	36.80	43.61	14.26	49.18	74.00	-24.82	Peak	VERTICAL
10962.00	42.28	37.51	43.83	16.19	52.15	74.00	-21.85	Peak	VERTICAL
12135.00	37.04	38.03	43.53	17.97	49.51	74.00	-24.49	Peak	VERTICAL
13597.00	35.69	39.24	43.19	19.67	51.41	74.00	-22.59	Peak	VERTICAL
11a CH48									
6780.00	43.38	35.47	43.62	12.30	47.53	74.00	-26.47	Peak	HORIZONTAL
9075.00	39.66	36.85	43.67	14.37	47.21	74.00	-26.79	Peak	HORIZONTAL
11047.00	39.28	37.61	43.81	16.31	49.39	74.00	-24.61	Peak	HORIZONTAL
12900.00	37.36	38.26	43.35	18.76	51.03	74.00	-22.97	Peak	HORIZONTAL
14481.00	34.91	40.30	43.00	20.14	52.35	74.00	-21.65	Peak	HORIZONTAL
16266.00	28.70	41.63	42.14	22.53	50.72	74.00	-23.28	Peak	HORIZONTAL
6559.00	41.83	35.34	43.72	11.99	45.44	74.00	-28.56	Peak	VERTICAL
8191.00	41.14	36.49	43.21	13.40	47.82	74.00	-26.18	Peak	VERTICAL
10231.00	42.80	37.54	44.03	15.27	51.58	74.00	-22.42	Peak	VERTICAL
11897.00	41.36	38.12	43.59	17.67	53.56	74.00	-20.44	Peak	VERTICAL
13903.00	34.02	39.97	43.12	20.09	50.96	74.00	-23.04	Peak	VERTICAL
15433.00	31.38	40.53	42.63	21.07	50.35	74.00	-23.65	Peak	VERTICAL
Conclusion: Pass									
Note: $-27 \text{ dBm/MHz Limit} = 95.2 + \text{EIRP}[\text{dBm}] = 95.2 - 27 = 68.2 \text{ dB}\mu\text{V/m}$ For transmitters operating in the 5150MHz-5250MHz, 5250MHz-5350MHz, 5470MHz-5725MHz, 5725MHz-5850MHz band: all emissions outside of the 5.15-5.35 GHz band shall not exceed an EIRP of -27 dBm/MHz.									

Note:1. 30MHz~40GHz: (11a, 11n20, n40, 11ac20, 11ac40, 11ac80 mode all have been tested, only 11a mode is the worst case and reported.)

2. Result Level = Read Level + Antenna Factor + Cable loss - PRM Factor.

3. Test setup: RBW: 1 MHz, VBW: 3 MHz, Sweep time: auto.

Freq (MHz)	Read level (dBμV)	Antenna Factor (dB/m)	PRM Factor(dB)	Cable Loss (dB)	Result Level (dBμV/m)	Limit (dBμV/m)	Margin (dB)	Detector type	Polarization
11a CH52									
5165.00	45.24	34.04	44.16	10.38	45.50	74.00	-28.50	Peak	HORIZONTAL
6542.00	41.38	35.33	43.73	11.97	44.95	74.00	-29.05	Peak	HORIZONTAL
8565.00	38.62	36.80	43.41	14.33	46.34	74.00	-27.66	Peak	HORIZONTAL
10809.00	40.92	37.58	43.87	16.00	50.63	74.00	-23.37	Peak	HORIZONTAL
13495.00	36.54	38.99	43.21	19.53	51.85	74.00	-22.15	Peak	HORIZONTAL
15467.00	33.18	40.51	42.61	21.15	52.23	74.00	-21.77	Peak	HORIZONTAL
6151.00	41.14	34.89	43.92	11.79	43.90	74.00	-30.10	Peak	VERTICAL
8055.00	39.51	36.36	43.13	13.74	46.48	74.00	-27.52	Peak	VERTICAL
9925.00	43.02	37.36	44.07	15.31	51.62	74.00	-22.38	Peak	VERTICAL
11812.00	39.01	38.22	43.61	17.53	51.15	74.00	-22.85	Peak	VERTICAL
13393.00	35.89	38.85	43.24	19.39	50.89	74.00	-23.11	Peak	VERTICAL
15127.00	33.65	40.65	42.82	20.35	51.83	74.00	-22.17	Peak	VERTICAL
11a CH56									
5590.00	41.82	34.37	44.08	11.15	43.26	74.00	-30.74	Peak	HORIZONTAL
7171.00	40.95	35.70	43.44	12.77	45.98	74.00	-28.02	Peak	HORIZONTAL
9058.00	40.42	36.84	43.66	14.37	47.97	74.00	-26.03	Peak	HORIZONTAL
10707.00	42.39	37.62	43.90	15.87	51.98	74.00	-22.02	Peak	HORIZONTAL
12594.00	38.48	38.14	43.42	18.44	51.64	74.00	-22.36	Peak	HORIZONTAL
14379.00	34.43	40.28	43.03	20.16	51.84	74.00	-22.16	Peak	HORIZONTAL
5318.00	43.54	34.16	44.13	10.47	44.04	74.00	-29.96	Peak	VERTICAL
6474.00	42.71	35.27	43.76	11.95	46.17	74.00	-27.83	Peak	VERTICAL
7885.00	42.30	36.21	43.15	13.75	49.11	74.00	-24.89	Peak	VERTICAL
9908.00	42.93	37.35	44.06	15.24	51.46	74.00	-22.54	Peak	VERTICAL
12135.00	40.45	38.03	43.53	17.97	52.92	74.00	-21.08	Peak	VERTICAL
14447.00	35.40	40.29	43.01	20.14	52.82	74.00	-21.18	Peak	VERTICAL
11a CH64									
5352.00	43.11	34.19	44.13	10.48	43.65	74.00	-30.35	Peak	HORIZONTAL
6474.00	42.95	35.27	43.76	11.95	46.41	74.00	-27.59	Peak	HORIZONTAL
8106.00	42.61	36.41	43.16	13.46	49.32	74.00	-24.68	Peak	HORIZONTAL
10333.00	43.67	37.60	44.00	15.40	52.67	74.00	-21.33	Peak	HORIZONTAL
12594.00	39.43	38.14	43.42	18.44	52.59	74.00	-21.41	Peak	HORIZONTAL
14736.00	33.89	40.49	42.95	20.09	51.52	74.00	-22.48	Peak	HORIZONTAL
5352.00	43.39	34.19	44.13	10.48	43.93	74.00	-30.07	Peak	VERTICAL
7545.00	43.13	35.94	43.28	13.13	48.92	74.00	-25.08	Peak	VERTICAL
9993.00	43.37	37.40	44.10	15.58	52.25	74.00	-21.75	Peak	VERTICAL
12781.00	38.44	38.21	43.37	18.63	51.91	74.00	-22.09	Peak	VERTICAL
14753.00	34.28	40.50	42.95	20.09	51.92	74.00	-22.08	Peak	VERTICAL
16419.00	30.15	41.87	42.05	22.60	52.57	74.00	-21.43	Peak	VERTICAL
Conclusion: Pass									
Note: -27 dBm/MHz Limit=95.2+EIRP[dBm]=95.2-27=68.2 dBμV/m									

For transmitters operating in the 5150MHz-5250MHz, 5250MHz-5350MHz, 5470MHz-5725MHz, 5725MHz-5850MHz band: all emissions outside of the 5.15-5.35 GHz band shall not exceed an EIRP of -27 dBm/MHz.

Note:1. 30MHz~40GHz: (11a, 11n20, n40, 11ac20, 11ac40, 11ac80 mode all have been tested, only 11a mode is the worst case and reported.)

2. Result Level = Read Level + Antenna Factor + Cable loss - PRM Factor.

3. Test setup: RBW: 1 MHz, VBW: 3 MHz, Sweep time: auto.

Freq (MHz)	Read level (dBμV)	Antenna Factor (dB/m)	PRM Factor(dB)	Cable Loss (dB)	Result Level (dBμV/m)	Limit (dBμV/m)	Margin (dB)	Detector type	Polarization
11a CH110									
5471.00	43.54	34.28	44.10	10.79	44.51	74.00	-29.49	Peak	HORIZONTAL
7137.00	39.11	35.68	43.46	12.70	44.03	74.00	-29.97	Peak	HORIZONTAL
9007.00	40.79	36.80	43.63	14.37	48.33	74.00	-25.67	Peak	HORIZONTAL
11336.00	40.55	38.24	43.73	16.77	51.83	74.00	-22.17	Peak	HORIZONTAL
13818.00	35.25	39.77	43.14	19.97	51.85	74.00	-22.15	Peak	HORIZONTAL
15348.00	33.97	40.56	42.68	20.87	52.72	74.00	-21.28	Peak	HORIZONTAL
5794.00	44.16	34.54	44.04	11.42	46.08	74.00	-27.92	Peak	VERTICAL
6746.00	41.18	35.45	43.63	12.20	45.20	74.00	-28.80	Peak	VERTICAL
7953.00	41.65	36.26	43.12	13.95	48.74	74.00	-25.26	Peak	VERTICAL
9483.00	42.14	37.10	43.86	14.65	50.03	74.00	-23.97	Peak	VERTICAL
11914.00	40.47	38.10	43.58	17.69	52.68	74.00	-21.32	Peak	VERTICAL
14022.00	34.43	40.20	43.10	20.22	51.75	74.00	-22.25	Peak	VERTICAL
11a CH116									
5862.00	43.18	34.59	44.03	11.42	45.16	74.00	-28.84	Peak	HORIZONTAL
6423.00	40.67	35.21	43.79	12.03	44.12	74.00	-29.88	Peak	HORIZONTAL
7409.00	43.12	35.85	43.34	13.09	48.72	74.00	-25.28	Peak	HORIZONTAL
8837.00	40.68	36.80	43.55	14.04	47.97	74.00	-26.03	Peak	HORIZONTAL
11387.00	38.95	38.36	43.72	16.86	50.45	74.00	-23.55	Peak	HORIZONTAL
13988.00	34.55	40.17	43.11	20.20	51.81	74.00	-22.19	Peak	HORIZONTAL
5777.00	43.89	34.53	44.04	11.38	45.76	74.00	-28.24	Peak	VERTICAL
7188.00	41.08	35.72	43.43	12.81	46.18	74.00	-27.82	Peak	VERTICAL
8735.00	40.81	36.80	43.49	14.14	48.26	74.00	-25.74	Peak	VERTICAL
10452.00	44.05	37.67	43.97	15.55	53.30	74.00	-20.70	Peak	VERTICAL
12679.00	39.46	38.17	43.40	18.53	52.76	74.00	-21.24	Peak	VERTICAL
14396.00	34.39	40.28	43.02	20.15	51.80	74.00	-22.20	Peak	VERTICAL
11a CH140									
6083.00	42.82	34.80	43.96	11.28	44.94	74.00	-29.06	Peak	HORIZONTAL
8140.00	40.51	36.44	43.18	13.43	47.20	74.00	-26.80	Peak	HORIZONTAL
10520.00	42.99	37.69	43.95	15.63	52.36	74.00	-21.64	Peak	HORIZONTAL
12526.00	39.06	38.11	43.43	18.37	52.11	74.00	-21.89	Peak	HORIZONTAL
14141.00	34.17	40.23	43.07	20.20	51.53	74.00	-22.47	Peak	HORIZONTAL
15586.00	32.90	40.62	42.54	21.43	52.41	74.00	-21.59	Peak	HORIZONTAL
5216.00	41.54	34.08	44.15	10.44	41.91	74.00	-32.09	Peak	VERTICAL
6083.00	43.17	34.80	43.96	11.28	45.29	74.00	-28.71	Peak	VERTICAL
7103.00	40.88	35.66	43.47	12.62	45.69	74.00	-28.31	Peak	VERTICAL
8259.00	42.15	36.56	43.24	13.37	48.84	74.00	-25.16	Peak	VERTICAL

10911.00	42.33	37.53	43.84	16.13	52.15	74.00	-21.85	Peak	VERTICAL
13750.00	36.04	39.61	43.16	19.88	52.37	74.00	-21.63	Peak	VERTICAL

Conclusion: Pass

Note: $-27 \text{ dBm/MHz Limit} = 95.2 + \text{EIRP}[\text{dBm}] = 95.2 - 27 = 68.2 \text{ dB}\mu\text{V/m}$

For transmitters operating in the 5150MHz-5250MHz, 5250MHz-5350MHz, 5470MHz-5725MHz, 5725MHz-5850MHz band: all emissions outside of the 5.15-5.35 GHz band shall not exceed an EIRP of -27 dBm/MHz.

Note:1. 30MHz~40GHz: (11a, 11n20, n40, 11ac20, 11ac40, 11ac80 mode all have been tested, only 11a mode is the worst case and reported.)

2. Result Level = Read Level + Antenna Factor + Cable loss - PRM Factor.

3. Test setup: RBW: 1 MHz, VBW: 3 MHz, Sweep time: auto.

Freq (MHz)	Read level (dB μ V)	Antenna Factor (dB/m)	PRM Factor(dB)	Cable Loss (dB)	Result Level (dB μ V/m)	Limit (dB μ V/m)	Margin (dB)	Detector type	Polarization
11a CH149									
5590.00	43.48	34.37	44.08	11.15	44.92	74.00	-29.08	Peak	HORIZONTAL
6984.00	38.96	35.59	43.52	12.59	43.62	74.00	-30.38	Peak	HORIZONTAL
9347.00	42.68	37.02	43.80	14.75	50.65	74.00	-23.35	Peak	HORIZONTAL
11965.00	39.40	38.04	43.57	17.77	51.64	74.00	-22.36	Peak	HORIZONTAL
14328.00	34.34	40.27	43.04	20.16	51.73	74.00	-22.27	Peak	HORIZONTAL
16130.00	31.00	41.41	42.22	22.47	52.66	74.00	-21.34	Peak	HORIZONTAL
5573.00	44.99	34.36	44.08	11.11	46.38	74.00	-27.62	Peak	VERTICAL
7392.00	43.62	35.84	43.35	13.05	49.16	74.00	-24.84	Peak	VERTICAL
9058.00	41.02	36.84	43.66	14.37	48.57	74.00	-25.43	Peak	VERTICAL
11574.00	40.05	38.51	43.67	17.15	52.04	74.00	-21.96	Peak	VERTICAL
14005.00	35.04	40.20	43.10	20.22	52.36	74.00	-21.64	Peak	VERTICAL
15824.00	31.26	40.96	42.40	21.99	51.81	74.00	-22.19	Peak	VERTICAL
11a CH157									
5114.00	44.21	33.99	44.18	10.31	44.33	74.00	-29.67	Peak	HORIZONTAL
6287.00	40.43	35.05	43.85	11.86	43.49	74.00	-30.51	Peak	HORIZONTAL
8395.00	42.02	36.70	43.32	13.55	48.95	74.00	-25.05	Peak	HORIZONTAL
10792.00	42.06	37.58	43.87	15.98	51.75	74.00	-22.25	Peak	HORIZONTAL
13529.00	37.36	39.07	43.21	19.58	52.80	74.00	-21.20	Peak	HORIZONTAL
15484.00	32.28	40.51	42.60	21.19	51.38	74.00	-22.62	Peak	HORIZONTAL
5284.00	41.06	34.13	44.14	10.46	41.51	74.00	-32.49	Peak	VERTICAL
6270.00	42.06	35.03	43.86	11.95	45.18	74.00	-28.82	Peak	VERTICAL
8276.00	41.83	36.58	43.25	13.36	48.52	74.00	-25.48	Peak	VERTICAL
10843.00	42.99	37.56	43.86	16.04	52.73	74.00	-21.27	Peak	VERTICAL
12866.00	38.59	38.25	43.35	18.72	52.21	74.00	-21.79	Peak	VERTICAL
15144.00	34.11	40.64	42.81	20.39	52.33	74.00	-21.67	Peak	VERTICAL
11a CH165									
5539.00	43.04	34.33	44.09	11.02	44.30	74.00	-29.70	Peak	HORIZONTAL
6746.00	42.39	35.45	43.63	12.20	46.41	74.00	-27.59	Peak	HORIZONTAL
8616.00	38.71	36.80	43.43	14.42	46.50	74.00	-27.50	Peak	HORIZONTAL
11251.00	39.59	38.06	43.75	16.64	50.54	74.00	-23.46	Peak	HORIZONTAL
13546.00	35.87	39.11	43.20	19.60	51.38	74.00	-22.62	Peak	HORIZONTAL
15943.00	31.41	41.12	42.33	22.28	52.48	74.00	-21.52	Peak	HORIZONTAL
5743.00	41.80	34.50	44.05	11.30	43.55	74.00	-30.45	Peak	VERTICAL

7630.00	40.68	36.01	43.25	13.07	46.51	74.00	-27.49	Peak	VERTICAL
9483.00	43.07	37.10	43.86	14.65	50.96	74.00	-23.04	Peak	VERTICAL
11353.00	41.58	38.28	43.72	16.80	52.94	74.00	-21.06	Peak	VERTICAL
13495.00	36.60	38.99	43.21	19.53	51.91	74.00	-22.09	Peak	VERTICAL
15518.00	32.26	40.53	42.58	21.27	51.48	74.00	-22.52	Peak	VERTICAL

Conclusion: Pass

Note: $-27 \text{ dBm/MHz Limit} = 95.2 + \text{EIRP}[\text{dBm}] = 95.2 - 27 = 68.2 \text{ dB}\mu\text{V/m}$

For transmitters operating in the 5150MHz-5250MHz, 5250MHz-5350MHz, 5470MHz-5725MHz, 5725MHz-5850MHz band: all emissions outside of the 5.15-5.35 GHz band shall not exceed an EIRP of -27 dBm/MHz.

Note: 1. 30MHz~40GHz: (11a, 11n20, n40, 11ac20, 11ac40, 11ac80 mode all have been tested, only 11a mode is the worst case and reported.)

2. Result Level = Read Level + Antenna Factor + Cable loss - PRM Factor.

3. Test setup: RBW: 1 MHz, VBW: 3 MHz, Sweep time: auto.

9. Band Edge Compliance

9.1. Block diagram of test setup

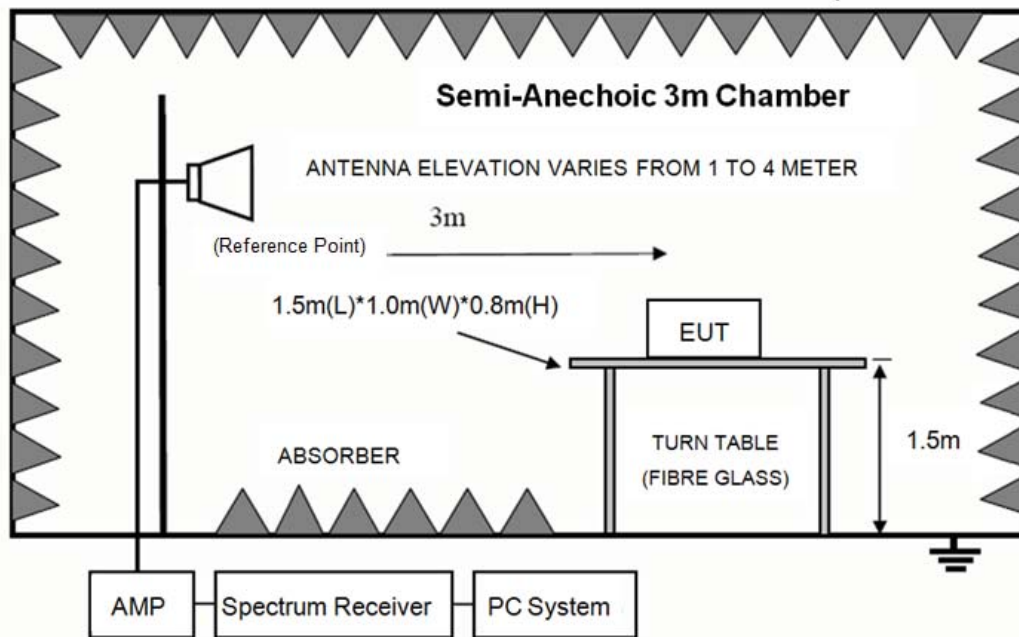

9.2. Limit

For transmitters operating in the 5.15-5.25 GHz and 5.725-5.85 GHz band: all emissions outside of the 5.15-5.35 GHz band shall not exceed an EIRP of -27 dBm/MHz.

$-27 \text{ dBm/MHz Limit} = 95.2 + \text{EIRP}[\text{dBm}] = 95.2 - 27 = 68.2 \text{ dB}\mu\text{V/m}$

9.3. Test Procedure

Same with clause 8.3 except change investigated frequency range from 5.15-5.25 GHz, 5250-5350 GHz, 5470-5725 GHz, 5.725-5.85 GHz.

Remark: All restriction band have been tested, and only the worst case is shown in report.

9.4. Test result

PASS. (See below detailed test result)

Note1: As specified in 15.407(b), emissions above 1000 MHz that are outside of the restricted bands are subject to a peak emission limit of -27 dBm/MHz (or -17 dBm/MHz as specified in 15.407(b)(4)). However, an out-of-band emission that complies with both the average and peak limits of 15.209 is not required to satisfy the -27 dBm/MHz or -17 dBm/MHz peak emission limit

Note2: 11a, 11n20, n40, 11ac20, 11ac40, 11ac80 mode all have been tested, only 11a mode is the worst case and reported.

TR-4-E-009 Radiated Emission Test Result

Test Site : DDT 3m Chamber 1#
Test Date : 2019-04-11
EUT : WIRELESS SPEAKER
Power Supply : AC 120V/60Hz
Condition : Temp:24.5°C, Humi:55%, Press:100.1kPa
Memo : 11a 5180MHz
Antenna/Distance : 2018 HF 907/3m/HORIZONTAL
Tested By : Sunny
Model Number : LINK MUSIC
Test Mode : Tx mode
Data: 47

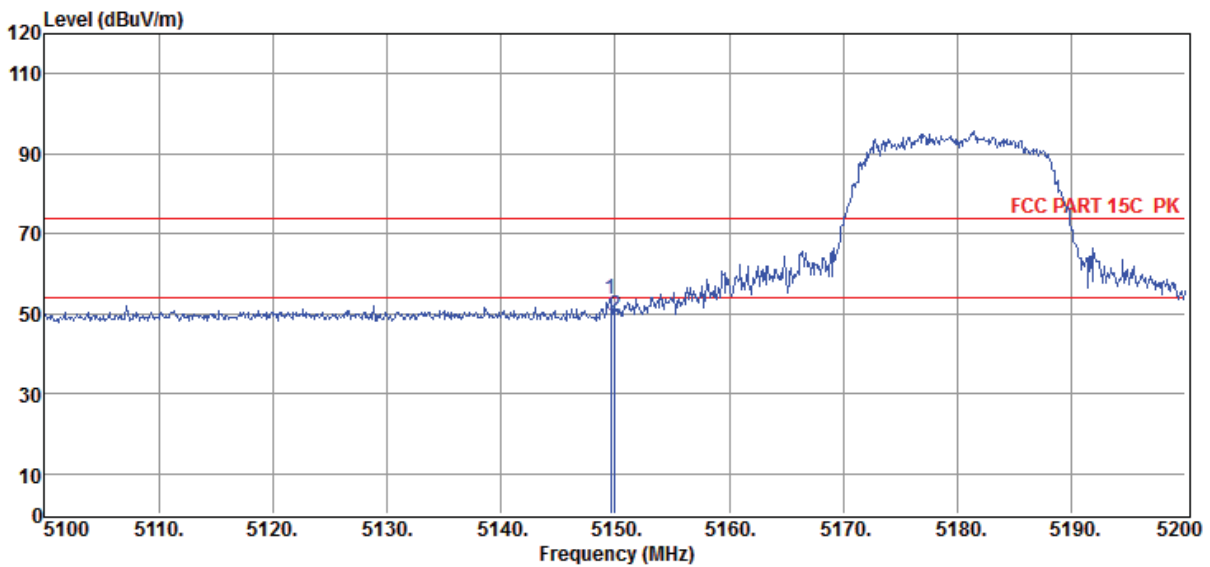

Item (Mark)	Freq. (MHz)	Read Level (dBμV)	Antenna Factor (dB/m)	PRM Factor (dB)	Cable Loss (dB)	Result Level (dBμV/m)	Limit Line (dBμV/m)	Over Limit (dB)	Detector	Polarization
1	5149.60	53.36	34.02	44.17	10.36	53.57	74.00	-20.43	Peak	HORIZONTAL
2	5150.00	49.18	34.02	44.17	10.36	49.39	74.00	-24.61	Peak	HORIZONTAL

Note: 1. Result Level = Read Level + Antenna Factor + Cable loss - PRM Factor.
 2. If Peak Result complies with AV limit, AV Result is deemed to comply with AV limit.
 3. Test setup: RBW: 1 MHz, VBW: 3 MHz, Sweep time: auto.

TR-4-E-009 Radiated Emission Test Result

Test Site : DDT 3m Chamber 1#
Test Date : 2019-04-11
EUT : WIRELESS SPEAKER
Power Supply : AC 120V/60Hz
Condition : Temp:24.5°C, Humi:55%, Press:100.1kPa
Memo : 11a 5180MHz
D:\2019 RE1# Report Data\Q20190411 GGEC LinkMusic\RF.EM6
Tested By : Sunny
Model Number : LINK MUSIC
Test Mode : Tx mode
Antenna/Distance : 2018 HF 907/3m/VERTICAL

Data: 48

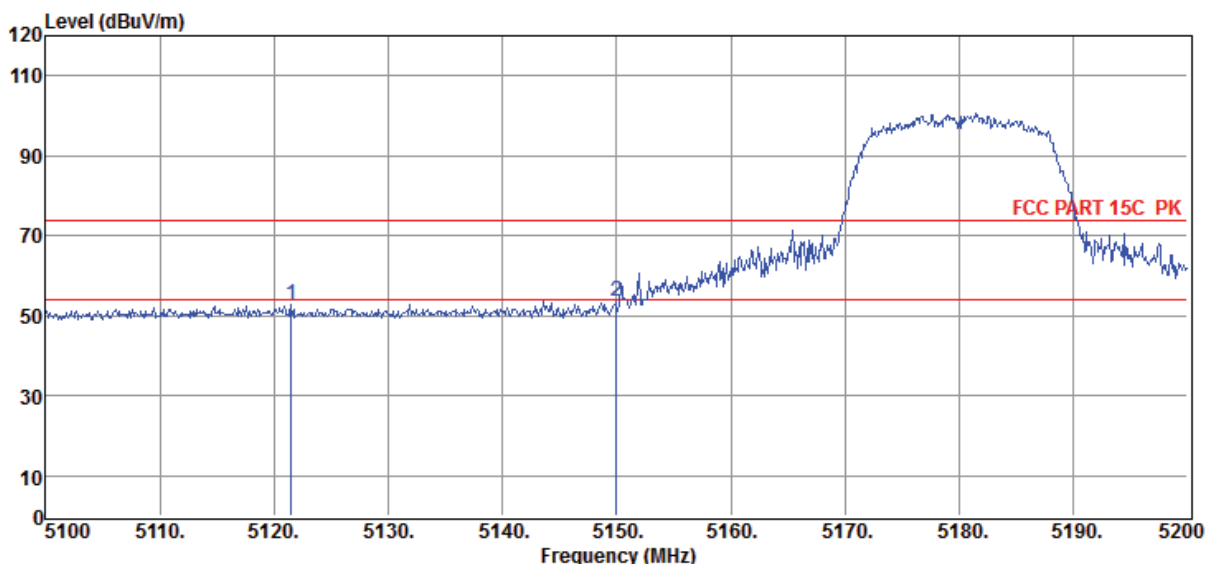

Item (Mark)	Freq. (MHz)	Read Level (dBμV)	Antenna Factor (dB/m)	PRM Factor (dB)	Cable Loss (dB)	Result Level (dBμV/m)	Limit Line (dBμV/m)	Over Limit (dB)	Detector	Polarization
1	5121.50	52.46	34.00	44.17	10.32	52.61	74.00	-21.39	Peak	VERTICAL
2	5150.00	53.39	34.02	44.17	10.36	53.60	74.00	-20.40	Peak	VERTICAL

- Note: 1. Result Level = Read Level + Antenna Factor + Cable loss - PRM Factor.
 2. If Peak Result complies with AV limit, AV Result is deemed to comply with AV limit.
 3. Test setup: RBW: 1 MHz, VBW: 3 MHz, Sweep time: auto.

TR-4-E-009 Radiated Emission Test Result

Test Site : DDT 3m Chamber 1#
Test Date : 2019-04-11
EUT : WIRELESS SPEAKER
Power Supply : AC 120V/60Hz
Condition : Temp:24.5°C, Humi:55%, Press:100.1kPa
Memo : 11a 5320MHz
D:\2019 RE1# Report Data\Q20190411 GSEC LinkMusic\RF.EM6
Tested By : Sunny
Model Number : LINK MUSIC
Test Mode : Tx mode
Antenna/Distance : 2018 HF 907/3m/HORIZONTAL

Data: 49

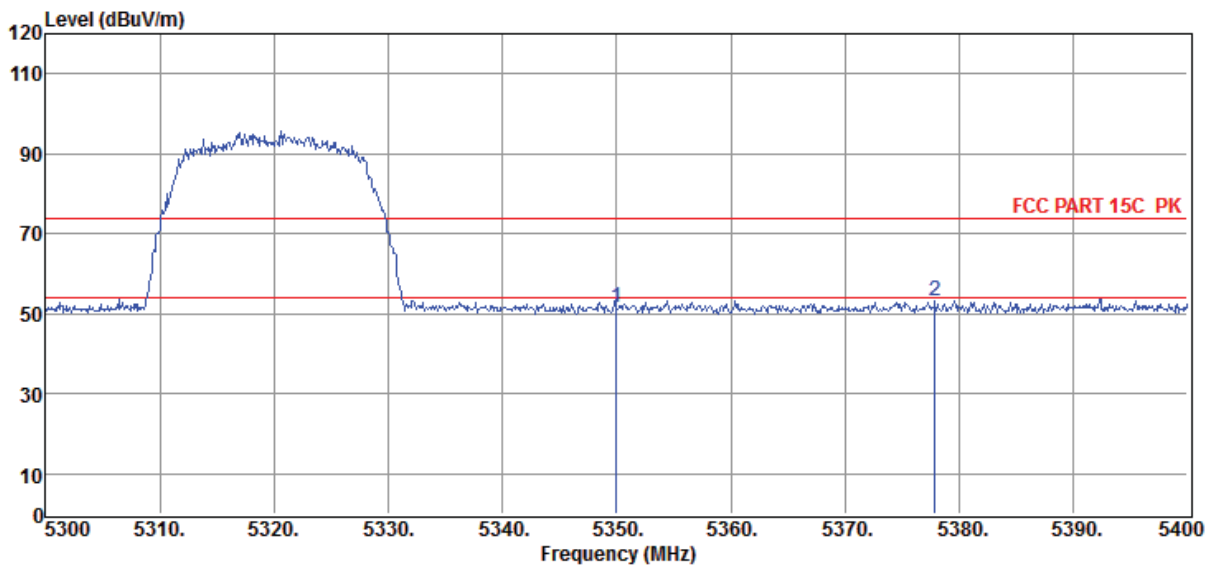

Item (Mark)	Freq. (MHz)	Read Level (dBμV)	Antenna Factor (dB/m)	PRM Factor (dB)	Cable Loss (dB)	Result Level (dBμV/m)	Limit Line (dBμV/m)	Over Limit (dB)	Detector	Polarization
1	5350.00	50.96	34.18	44.13	10.48	51.49	74.00	-22.51	Peak	HORIZONTAL
2	5377.90	52.72	34.21	44.12	10.48	53.29	74.00	-20.71	Peak	HORIZONTAL

- Note: 1. Result Level = Read Level + Antenna Factor + Cable loss - PRM Factor.
 2. If Peak Result complies with AV limit, AV Result is deemed to comply with AV limit.
 3. Test setup: RBW: 1 MHz, VBW: 3 MHz, Sweep time: auto.

TR-4-E-009 Radiated Emission Test Result

Test Site : DDT 3m Chamber 1#
Test Date : 2019-04-11
EUT : WIRELESS SPEAKER
Power Supply : AC 120V/60Hz
Condition : Temp:24.5°C, Humi:55%, Press:100.1kPa
Memo : 11a 5320MHz
Antenna/Distance : 2018 HF 907/3m/VERTICAL
Tested By : Sunny
Model Number : LINK MUSIC
Test Mode : Tx mode
Data: 50

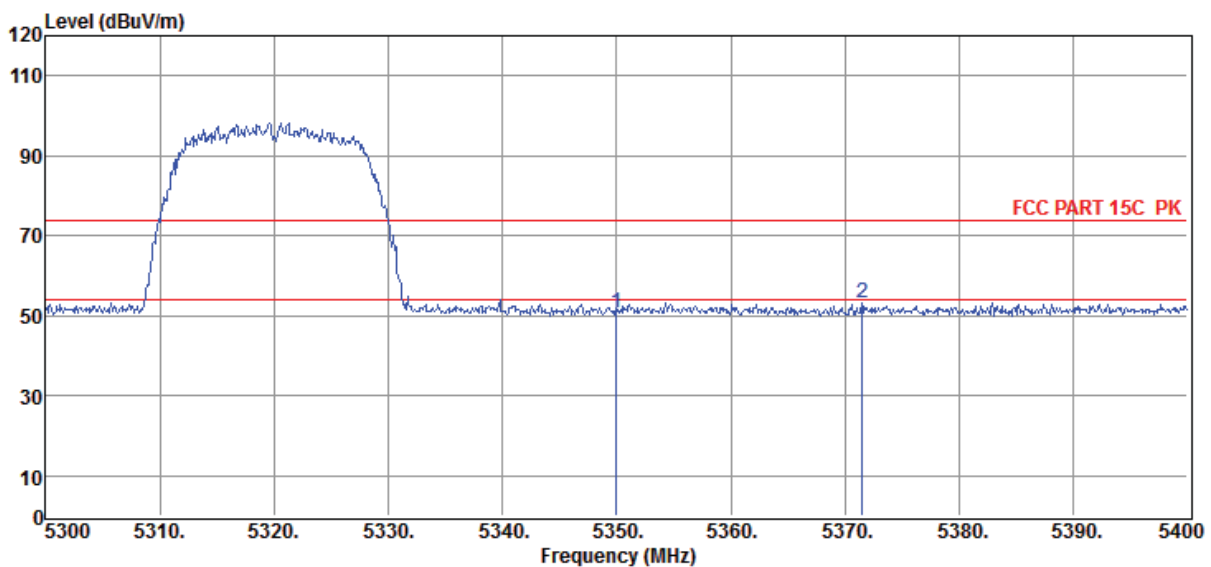

Item (Mark)	Freq. (MHz)	Read Level (dBμV)	Antenna Factor (dB/m)	PRM Factor (dB)	Cable Loss (dB)	Result Level (dBμV/m)	Limit Line (dBμV/m)	Over Limit (dB)	Detector	Polarization
1	5350.00	50.00	34.18	44.13	10.48	50.53	74.00	-23.47	Peak	VERTICAL
2	5371.50	52.58	34.20	44.12	10.48	53.14	74.00	-20.86	Peak	VERTICAL

Note: 1. Result Level = Read Level + Antenna Factor + Cable loss - PRM Factor.
 2. If Peak Result complies with AV limit, AV Result is deemed to comply with AV limit.
 3. Test setup: RBW: 1 MHz, VBW: 3 MHz, Sweep time: auto.

TR-4-E-009 Radiated Emission Test Result

Test Site : DDT 3m Chamber 1#
Test Date : 2019-04-11
EUT : WIRELESS SPEAKER
Power Supply : AC 120V/60Hz
Condition : Temp:24.5°C, Humi:55%, Press:100.1kPa
Memo : 11a 5500MHz
Antenna/Distance : 2018 HF 907/3m/HORIZONTAL
Tested By : Sunny
Model Number : LINK MUSIC
Test Mode : Tx mode
Data: 51

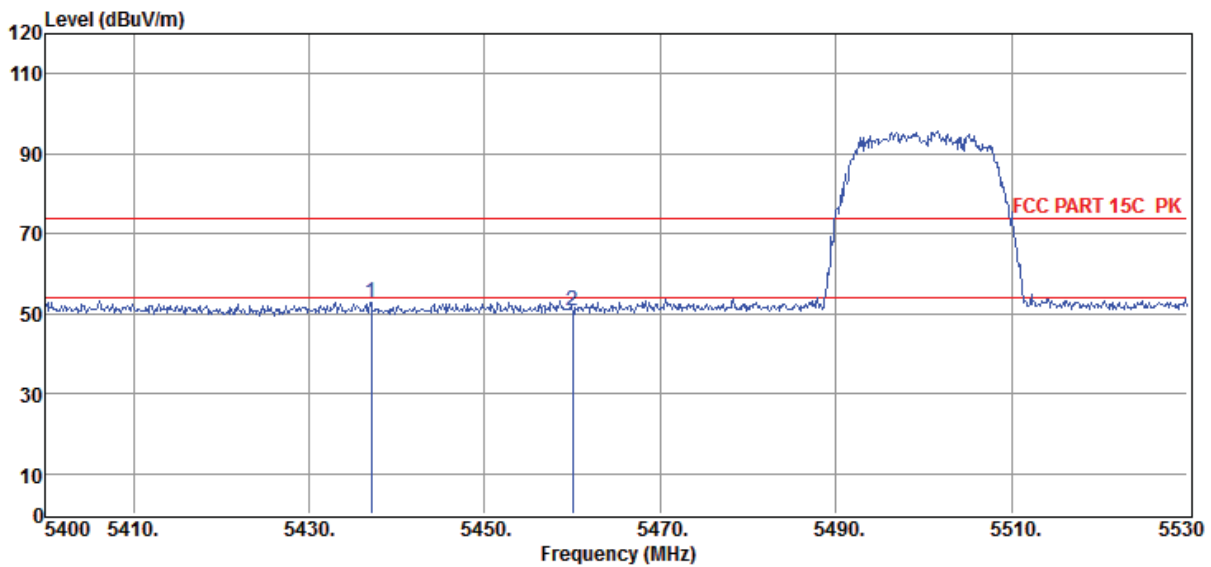

Item (Mark)	Freq. (MHz)	Read Level (dBμV)	Antenna Factor (dB/m)	PRM Factor (dB)	Cable Loss (dB)	Result Level (dBμV/m)	Limit Line (dBμV/m)	Over Limit (dB)	Detector	Polarization
1	5437.05	51.96	34.25	44.11	10.64	52.74	74.00	-21.26	Peak	HORIZONTAL
2	5460.00	49.76	34.27	44.10	10.74	50.67	74.00	-23.33	Peak	HORIZONTAL

- Note: 1. Result Level = Read Level + Antenna Factor + Cable loss - PRM Factor.
 2. If Peak Result complies with AV limit, AV Result is deemed to comply with AV limit.
 3. Test setup: RBW: 1 MHz, VBW: 3 MHz, Sweep time: auto.

TR-4-E-009 Radiated Emission Test Result

Test Site : DDT 3m Chamber 1#
Test Date : 2019-04-11
EUT : WIRELESS SPEAKER
Power Supply : AC 120V/60Hz
Condition : Temp:24.5°C, Humi:55%, Press:100.1kPa
Memo : 11a 5500MHz
D:\2019 RE1# Report Data\Q20190411 GGEC LinkMusic\RF.EM6
Tested By : Sunny
Model Number : LINK MUSIC
Test Mode : Tx mode
Antenna/Distance : 2018 HF 907/3m/VERTICAL

Data: 52

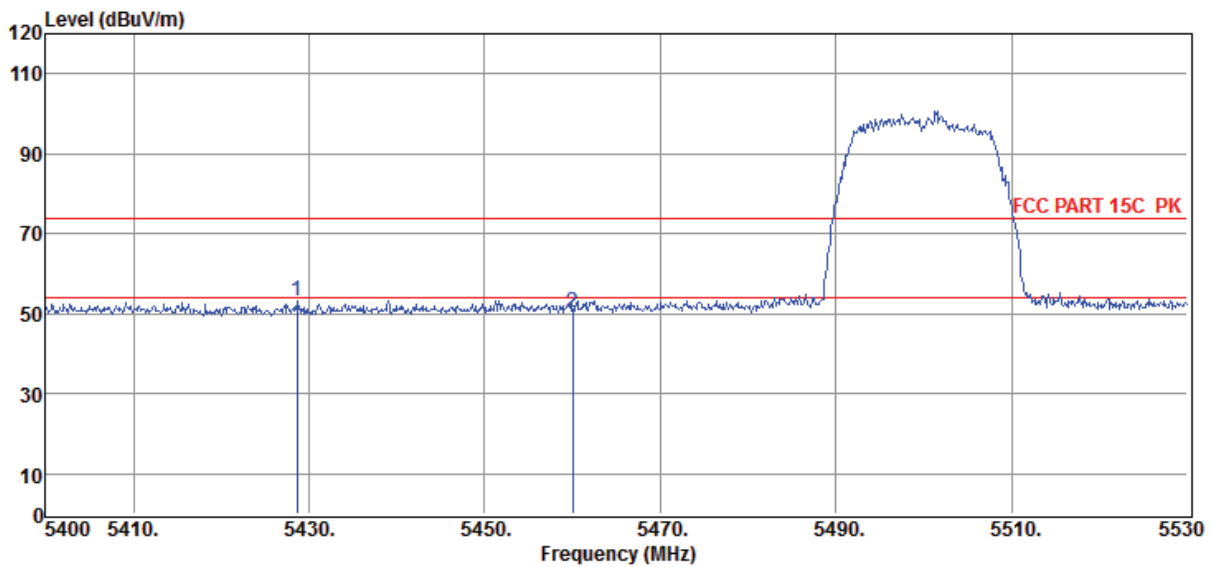

Item (Mark)	Freq. (MHz)	Read Level (dBμV)	Antenna Factor (dB/m)	PRM Factor (dB)	Cable Loss (dB)	Result Level (dBμV/m)	Limit Line (dBμV/m)	Over Limit (dB)	Detector	Polarization
1	5428.60	52.60	34.25	44.11	10.60	53.34	74.00	-20.66	Peak	VERTICAL
2	5460.00	49.43	34.27	44.10	10.74	50.34	74.00	-23.66	Peak	VERTICAL

- Note: 1. Result Level = Read Level + Antenna Factor + Cable loss - PRM Factor.
 2. If Peak Result complies with AV limit, AV Result is deemed to comply with AV limit.
 3. Test setup: RBW: 1 MHz, VBW: 3 MHz, Sweep time: auto.

TR-4-E-009 Radiated Emission Test Result

Test Site : DDT 3m Chamber 1# D:\2019 RE1# Report Data\Q20190411 GGEC LinkMusic\RF.EM6
Test Date : 2019-04-11 **Tested By** : Sunny
EUT : WIRELESS SPEAKER **Model Number** : LINK MUSIC
Power Supply : AC 120V/60Hz **Test Mode** : Tx mode
Condition : Temp:24.5°C, Humi:55%, Press:100.1kPa **Antenna/Distance** : 2018 HF 907/3m/HORIZONTAL
Memo : 11n20 5180MHz

Data: 53

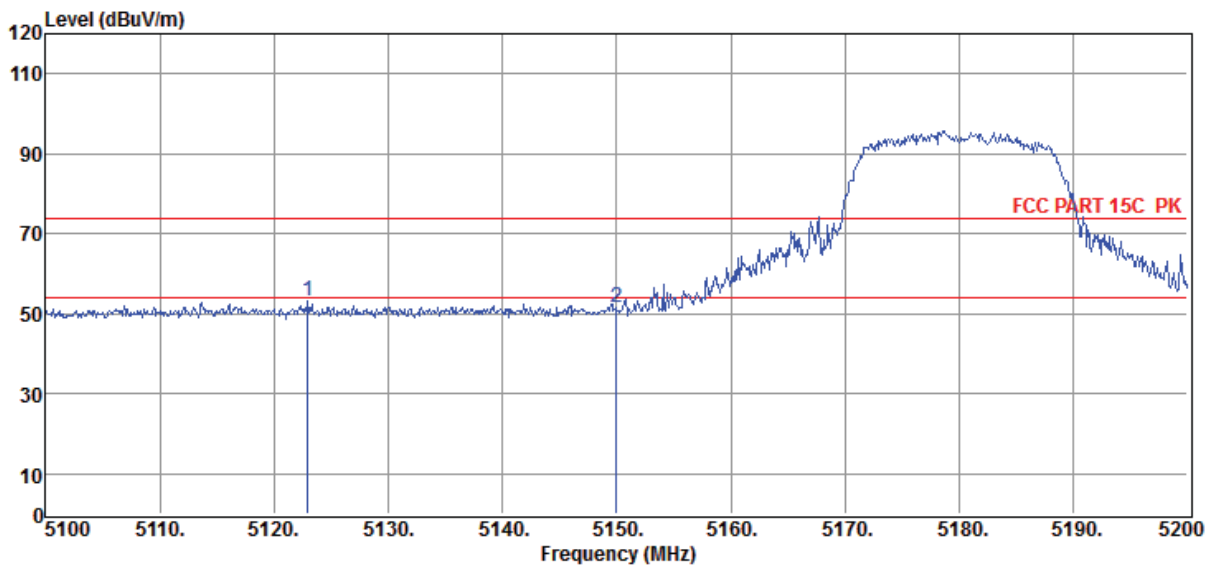

Item (Mark)	Freq. (MHz)	Read Level (dBμV)	Antenna Factor (dB/m)	PRM Factor (dB)	Cable Loss (dB)	Result Level (dBμV/m)	Limit Line (dBμV/m)	Over Limit (dB)	Detector	Polarization
1	5123.00	53.20	34.00	44.17	10.32	53.35	74.00	-20.65	Peak	HORIZONTAL
2	5150.00	51.30	34.02	44.17	10.36	51.51	74.00	-22.49	Peak	HORIZONTAL

- Note: 1. Result Level = Read Level + Antenna Factor + Cable loss - PRM Factor.
 2. If Peak Result complies with AV limit, AV Result is deemed to comply with AV limit.
 3. Test setup: RBW: 1 MHz, VBW: 3 MHz, Sweep time: auto.

TR-4-E-009 Radiated Emission Test Result

Test Site : DDT 3m Chamber 1# D:\2019 RE1# Report Data\Q20190411 GGEC LinkMusic\RF.EM6
Test Date : 2019-04-11 **Tested By** : Sunny
EUT : WIRELESS SPEAKER **Model Number** : LINK MUSIC
Power Supply : AC 120V/60Hz **Test Mode** : Tx mode
Condition : Temp:24.5°C, Humi:55%, Press:100.1kPa **Antenna/Distance** : 2018 HF 907/3m/VERTICAL
Memo : 11n20 5180MHz

Data: 54

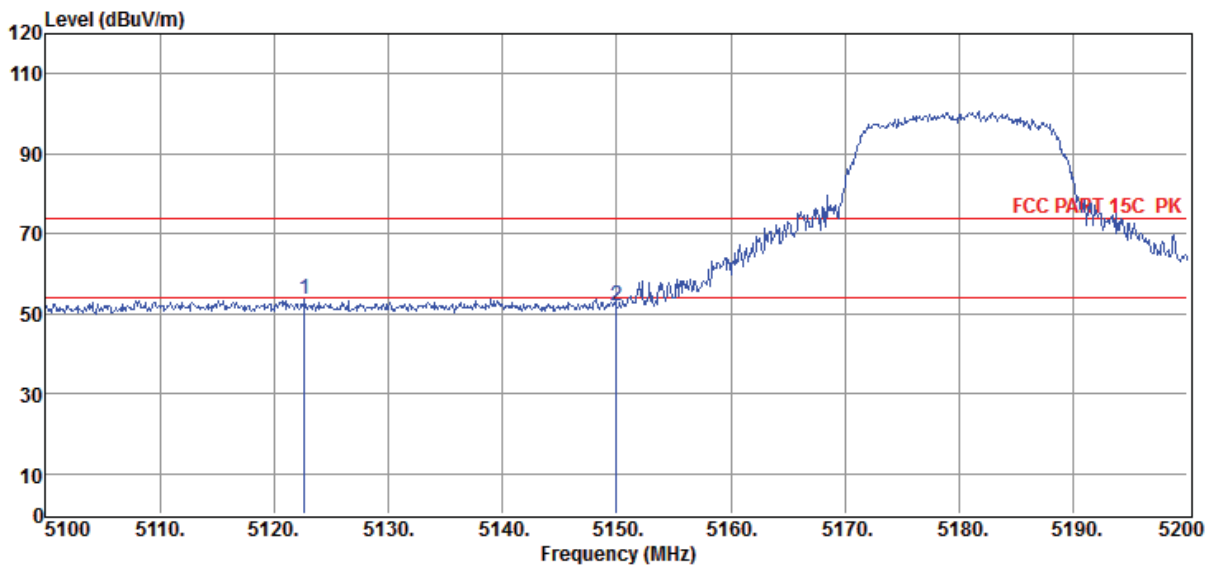

Item (Mark)	Freq. (MHz)	Read Level (dBμV)	Antenna Factor (dB/m)	PRM Factor (dB)	Cable Loss (dB)	Result Level (dBμV/m)	Limit Line (dBμV/m)	Over Limit (dB)	Detector	Polarization
1	5122.70	53.39	34.00	44.17	10.32	53.54	74.00	-20.46	Peak	VERTICAL
2	5150.00	51.78	34.02	44.17	10.36	51.99	74.00	-22.01	Peak	VERTICAL

- Note: 1. Result Level = Read Level + Antenna Factor + Cable loss - PRM Factor.
 2. If Peak Result complies with AV limit, AV Result is deemed to comply with AV limit.
 3. Test setup: RBW: 1 MHz, VBW: 3 MHz, Sweep time: auto.

TR-4-E-009 Radiated Emission Test Result

Test Site : DDT 3m Chamber 1# D:\2019 RE1# Report Data\Q20190411 GGEC LinkMusic\RF.EM6
Test Date : 2019-04-11 **Tested By** : Sunny
EUT : WIRELESS SPEAKER **Model Number** : LINK MUSIC
Power Supply : AC 120V/60Hz **Test Mode** : Tx mode
Condition : Temp:24.5°C, Humi:55%, Press:100.1kPa **Antenna/Distance** : 2018 HF 907/3m/HORIZONTAL
Memo : 11n20 5320MHz

Data: 55

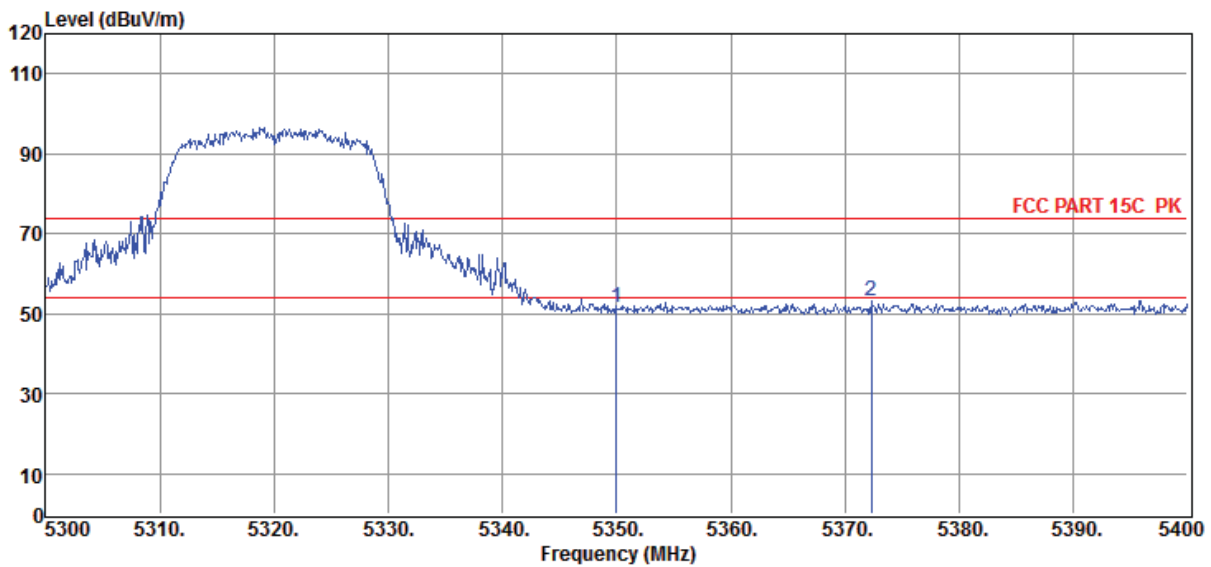

Item (Mark)	Freq. (MHz)	Read Level (dBµV)	Antenna Factor (dB/m)	PRM Factor (dB)	Cable Loss (dB)	Result Level (dBµV/m)	Limit Line (dBµV/m)	Over Limit (dB)	Detector	Polarization
1	5350.00	51.11	34.18	44.13	10.48	51.64	74.00	-22.36	Peak	HORIZONTAL
2	5372.30	52.54	34.20	44.12	10.48	53.10	74.00	-20.90	Peak	HORIZONTAL

- Note: 1. Result Level = Read Level + Antenna Factor + Cable loss - PRM Factor.
 2. If Peak Result complies with AV limit, AV Result is deemed to comply with AV limit.
 3. Test setup: RBW: 1 MHz, VBW: 3 MHz, Sweep time: auto.

TR-4-E-009 Radiated Emission Test Result

Test Site : DDT 3m Chamber 1#
Test Date : 2019-04-11
EUT : WIRELESS SPEAKER
Power Supply : AC 120V/60Hz
Condition : Temp:24.5°C, Humi:55%, Press:100.1kPa
Memo : 11n20 5320MHz
D:\2019 RE1# Report Data\Q20190411 GGEC LinkMusic\RF.EM6
Tested By : Sunny
Model Number : LINK MUSIC
Test Mode : Tx mode
Antenna/Distance : 2018 HF 907/3m/VERTICAL

Data: 56

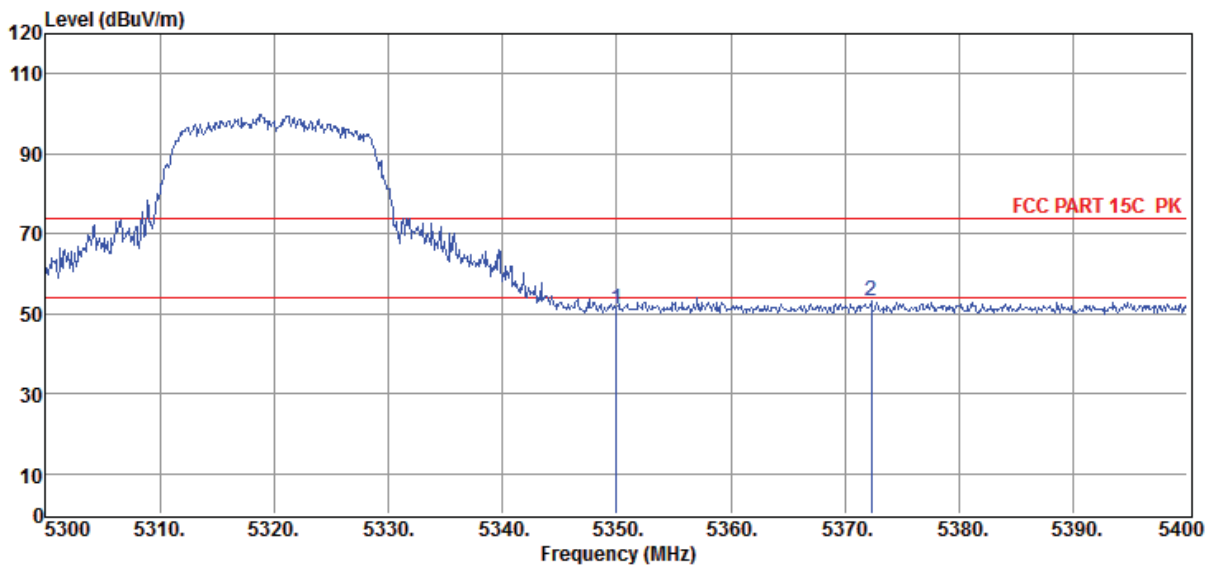

Item (Mark)	Freq. (MHz)	Read Level (dBμV)	Antenna Factor (dB/m)	PRM Factor (dB)	Cable Loss (dB)	Result Level (dBμV/m)	Limit Line (dBμV/m)	Over Limit (dB)	Detector	Polarization
1	5350.00	50.78	34.18	44.13	10.48	51.31	74.00	-22.69	Peak	VERTICAL
2	5372.30	52.74	34.20	44.12	10.48	53.30	74.00	-20.70	Peak	VERTICAL

- Note: 1. Result Level = Read Level + Antenna Factor + Cable loss - PRM Factor.
 2. If Peak Result complies with AV limit, AV Result is deemed to comply with AV limit.
 3. Test setup: RBW: 1 MHz, VBW: 3 MHz, Sweep time: auto.

TR-4-E-009 Radiated Emission Test Result

Test Site : DDT 3m Chamber 1# D:\2019 RE1# Report Data\Q20190411 GGEC LinkMusic\RF.EM6
Test Date : 2019-04-11 **Tested By** : Sunny
EUT : WIRELESS SPEAKER **Model Number** : LINK MUSIC
Power Supply : AC 120V/60Hz **Test Mode** : Tx mode
Condition : Temp:24.5°C, Humi:55%, Press:100.1kPa **Antenna/Distance** : 2018 HF 907/3m/HORIZONTAL
Memo : 11n20 5500MHz

Data: 57

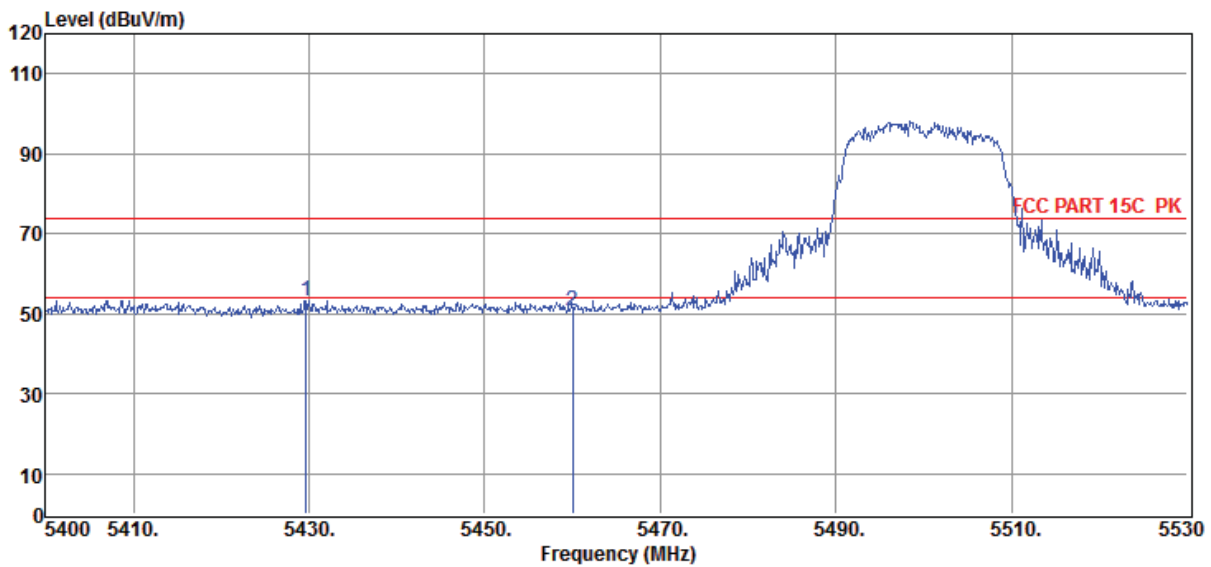

Item (Mark)	Freq. (MHz)	Read Level (dBμV)	Antenna Factor (dB/m)	PRM Factor (dB)	Cable Loss (dB)	Result Level (dBμV/m)	Limit Line (dBμV/m)	Over Limit (dB)	Detector	Polarization
1	5429.64	52.64	34.25	44.11	10.61	53.39	74.00	-20.61	Peak	HORIZONTAL
2	5460.00	49.69	34.27	44.10	10.74	50.60	74.00	-23.40	Peak	HORIZONTAL

- Note: 1. Result Level = Read Level + Antenna Factor + Cable loss - PRM Factor.
 2. If Peak Result complies with AV limit, AV Result is deemed to comply with AV limit.
 3. Test setup: RBW: 1 MHz, VBW: 3 MHz, Sweep time: auto.

TR-4-E-009 Radiated Emission Test Result

Test Site : DDT 3m Chamber 1#
Test Date : 2019-04-11
EUT : WIRELESS SPEAKER
Power Supply : AC 120V/60Hz
Condition : Temp:24.5°C, Humi:55%, Press:100.1kPa
Memo : 11n20 5500MHz
Antenna/Distance : 2018 HF 907/3m/VERTICAL
Tested By : Sunny
Model Number : LINK MUSIC
Test Mode : Tx mode
Link : D:\2019 RE1# Report Data\Q20190411 GGEC LinkMusic\RF.EM6

Data: 58

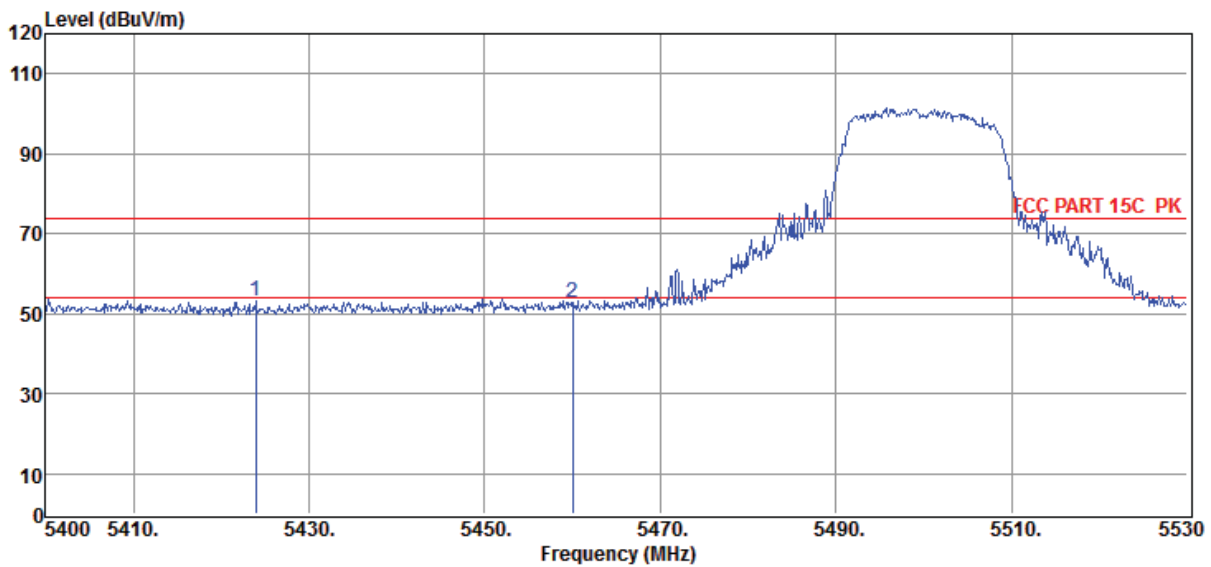

Item (Mark)	Freq. (MHz)	Read Level (dBuV)	Antenna Factor (dB/m)	PRM Factor (dB)	Cable Loss (dB)	Result Level (dBuV/m)	Limit Line (dBuV/m)	Over Limit (dB)	Detector	Polarization
1	5423.92	52.35	34.24	44.11	10.58	53.06	74.00	-20.94	Peak	VERTICAL
2	5460.00	51.80	34.27	44.10	10.74	52.71	74.00	-21.29	Peak	VERTICAL

- Note: 1. Result Level = Read Level + Antenna Factor + Cable loss - PRM Factor.
 2. If Peak Result complies with AV limit, AV Result is deemed to comply with AV limit.
 3. Test setup: RBW: 1 MHz, VBW: 3 MHz, Sweep time: auto.

TR-4-E-009 Radiated Emission Test Result

Test Site : DDT 3m Chamber 1# D:\2019 RE1# Report Data\Q20190411 GGEC LinkMusic\RF.EM6
Test Date : 2019-04-11 **Tested By** : Sunny
EUT : WIRELESS SPEAKER **Model Number** : LINK MUSIC
Power Supply : AC 120V/60Hz **Test Mode** : Tx mode
Condition : Temp:24.5°C, Humi:55%, Press:100.1kPa **Antenna/Distance** : 2018 HF 907/3m/HORIZONTAL
Memo : 11n40 5190MHz

Data: 59

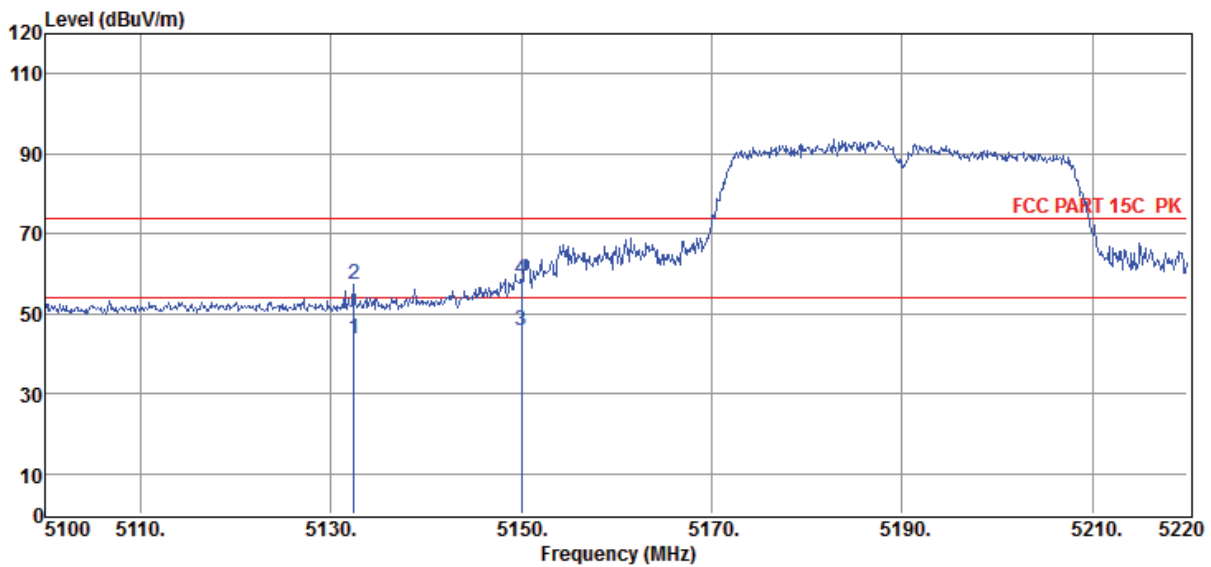

Item (Mark)	Freq. (MHz)	Read Level (dBμV)	Antenna Factor (dB/m)	PRM Factor dB	Cable Loss dB	Result Level (dBμV/m)	Limit Line (dBμV/m)	Over Limit (dB)	Detector	Polarization
1	5132.40	43.46	34.01	44.17	10.34	43.64	54.00	-10.36	Average	HORIZONTAL
2	5132.40	57.04	34.01	44.17	10.34	57.22	74.00	-16.78	Peak	HORIZONTAL
3	5150.00	45.66	34.02	44.17	10.36	45.87	54.00	-8.13	Average	HORIZONTAL
4	5150.00	58.34	34.02	44.17	10.36	58.55	74.00	-15.45	Peak	HORIZONTAL

Note: 1. Result Level = Read Level + Antenna Factor + Cable loss - PRM Factor.
 2. If Peak Result complies with AV limit, AV Result is deemed to comply with AV limit.
 3. Test setup: RBW: 1 MHz, VBW: 3 MHz, Sweep time: auto.

TR-4-E-009 Radiated Emission Test Result

Test Site : DDT 3m Chamber 1#
Test Date : 2019-04-11
EUT : WIRELESS SPEAKER
Power Supply : AC 120V/60Hz
Condition : Temp:24.5°C, Humi:55%, Press:100.1kPa
Memo : 11n40 5190MHz
D:\2019 RE1# Report Data\Q20190411 GSEC LinkMusic\RF.EM6
Tested By : Sunny
Model Number : LINK MUSIC
Test Mode : Tx mode
Antenna/Distance : 2018 HF 907/3m/VERTICAL

Data: 60

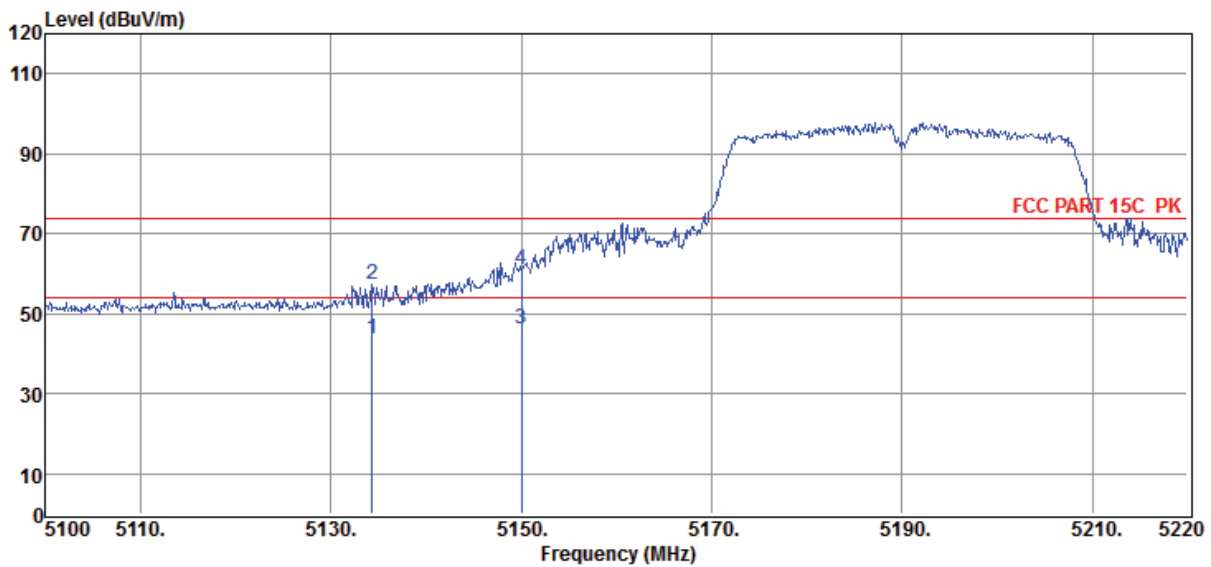

Item (Mark)	Freq. (MHz)	Read Level (dBμV)	Antenna Factor (dB/m)	PRM Factor (dB)	Cable Loss (dB)	Result Level (dBμV/m)	Limit Line (dBμV/m)	Over Limit (dB)	Detector	Polarization
1	5134.32	43.57	34.01	44.17	10.34	43.75	54.00	-10.25	Average	VERTICAL
2	5134.32	57.25	34.01	44.17	10.34	57.43	74.00	-16.57	Peak	VERTICAL
3	5150.00	45.88	34.02	44.17	10.36	46.09	54.00	-7.91	Average	VERTICAL
4	5150.00	60.64	34.02	44.17	10.36	60.85	74.00	-13.15	Peak	VERTICAL

Note: 1. Result Level = Read Level + Antenna Factor + Cable loss - PRM Factor.
 2. If Peak Result complies with AV limit, AV Result is deemed to comply with AV limit.
 3. Test setup: RBW: 1 MHz, VBW: 3 MHz, Sweep time: auto.

TR-4-E-009 Radiated Emission Test Result

Test Site : DDT 3m Chamber 1#
Test Date : 2019-04-11
EUT : WIRELESS SPEAKER
Power Supply : AC 120V/60Hz
Condition : Temp:24.5°C, Humi:55%, Press:100.1kPa
Memo : 11n40 5310MHz
D:\2019 RE1# Report Data\Q20190411 GSEC LinkMusic\RF.EM6
Tested By : Sunny
Model Number : LINK MUSIC
Test Mode : Tx mode
Antenna/Distance : 2018 HF 907/3m/HORIZONTAL

Data: 61

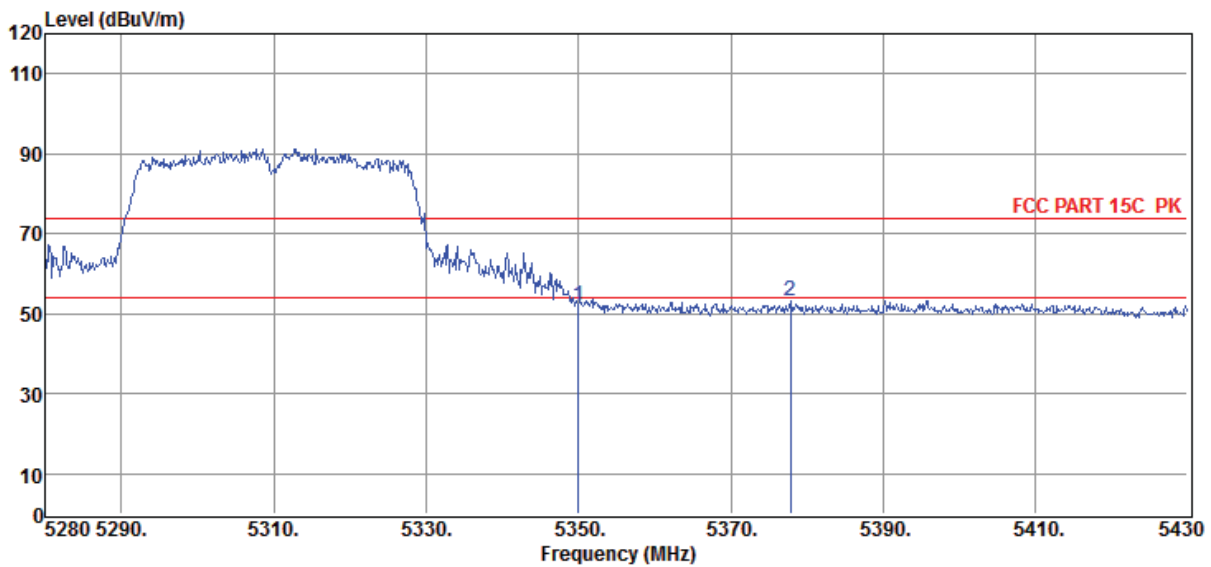

Item (Mark)	Freq. (MHz)	Read Level (dBμV)	Antenna Factor (dB/m)	PRM Factor (dB)	Cable Loss (dB)	Result Level (dBμV/m)	Limit Line (dBμV/m)	Over Limit (dB)	Detector	Polarization
1	5350.00	51.42	34.18	44.13	10.48	51.95	74.00	-22.05	Peak	HORIZONTAL
2	5377.80	52.67	34.21	44.12	10.48	53.24	74.00	-20.76	Peak	HORIZONTAL

- Note: 1. Result Level = Read Level + Antenna Factor + Cable loss - PRM Factor.
 2. If Peak Result complies with AV limit, AV Result is deemed to comply with AV limit.
 3. Test setup: RBW: 1 MHz, VBW: 3 MHz, Sweep time: auto.

TR-4-E-009 Radiated Emission Test Result

Test Site : DDT 3m Chamber 1#
Test Date : 2019-04-11
EUT : WIRELESS SPEAKER
Power Supply : AC 120V/60Hz
Condition : Temp:24.5°C, Humi:55%, Press:100.1kPa
Memo : 11n40 5310MHz
D:\2019 RE1# Report Data\Q20190411 GGEC LinkMusic\RF.EM6
Tested By : Sunny
Model Number : LINK MUSIC
Test Mode : Tx mode
Antenna/Distance : 2018 HF 907/3m/VERTICAL

Data: 62

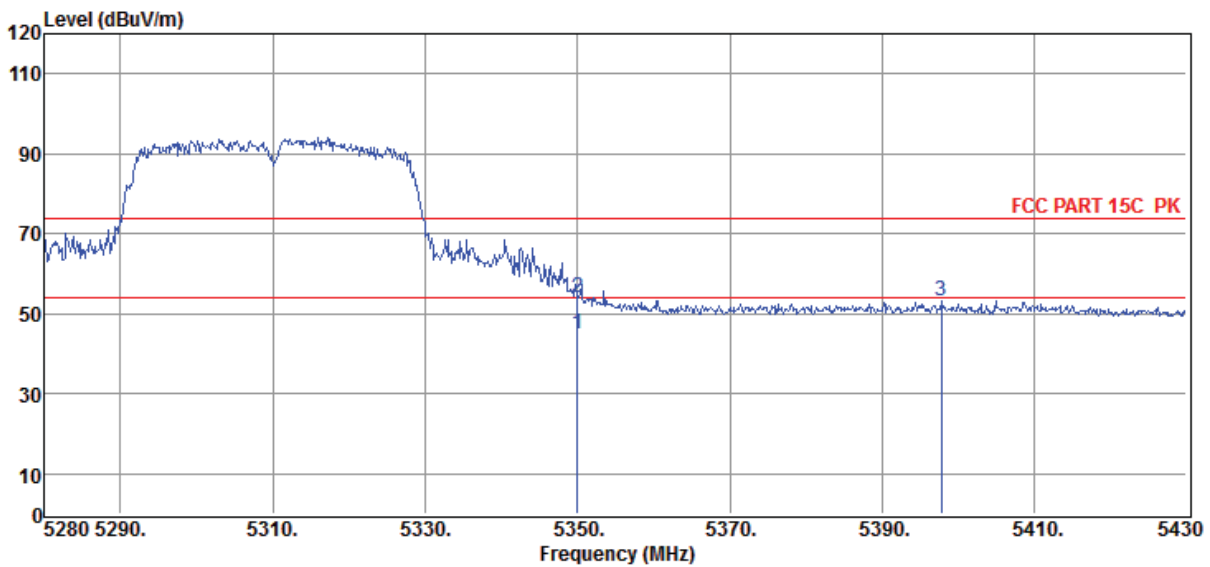

Item (Mark)	Freq. (MHz)	Read Level (dBμV)	Antenna Factor (dB/m)	PRM Factor dB	Cable Loss dB	Result Level (dBμV/m)	Limit Line (dBμV/m)	Over Limit (dB)	Detector	Polarization
1	5350.00	44.47	34.18	44.13	10.48	45.00	54.00	-9.00	Average	VERTICAL
2	5350.00	53.36	34.18	44.13	10.48	53.89	74.00	-20.11	Peak	VERTICAL
3	5397.75	52.54	34.22	44.12	10.48	53.12	74.00	-20.88	Peak	VERTICAL

- Note: 1. Result Level = Read Level + Antenna Factor + Cable loss - PRM Factor.
 2. If Peak Result complies with AV limit, AV Result is deemed to comply with AV limit.
 3. Test setup: RBW: 1 MHz, VBW: 3 MHz, Sweep time: auto.

TR-4-E-009 Radiated Emission Test Result

Test Site : DDT 3m Chamber 1#
Test Date : 2019-04-11
EUT : WIRELESS SPEAKER
Power Supply : AC 120V/60Hz
Condition : Temp:24.5°C, Humi:55%, Press:100.1kPa
Memo : 11n40 5510MHz
Antenna/Distance : 2018 HF 907/3m/HORIZONTAL
Tested By : Sunny
Model Number : LINK MUSIC
Test Mode : Tx mode
Link : D:\2019 RE1# Report Data\Q20190411 GSEC LinkMusic\RF.EM6

Data: 63

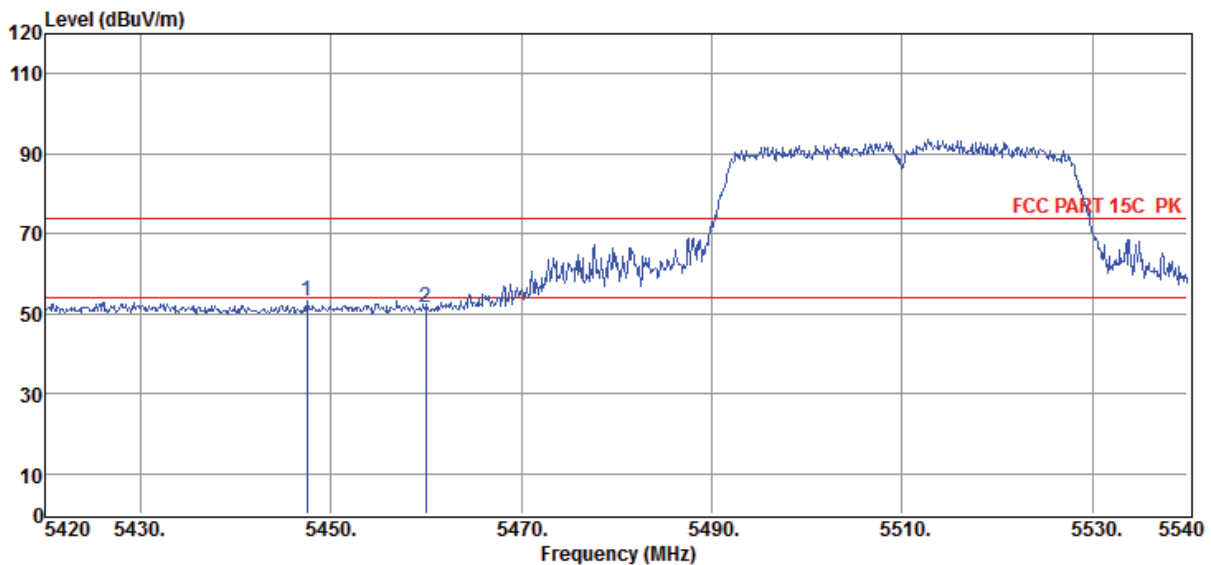

Item (Mark)	Freq. (MHz)	Read Level (dBμV)	Antenna Factor (dB/m)	PRM Factor (dB)	Cable Loss (dB)	Result Level (dBμV/m)	Limit Line (dBμV/m)	Over Limit (dB)	Detector	Polarization
1	5447.48	52.33	34.26	44.11	10.68	53.16	74.00	-20.84	Peak	HORIZONTAL
2	5460.00	50.76	34.27	44.10	10.74	51.67	74.00	-22.33	Peak	HORIZONTAL

- Note: 1. Result Level = Read Level + Antenna Factor + Cable loss - PRM Factor.
 2. If Peak Result complies with AV limit, AV Result is deemed to comply with AV limit.
 3. Test setup: RBW: 1 MHz, VBW: 3 MHz, Sweep time: auto.

TR-4-E-009 Radiated Emission Test Result

Test Site : DDT 3m Chamber 1#
Test Date : 2019-04-11
EUT : WIRELESS SPEAKER
Power Supply : AC 120V/60Hz
Condition : Temp:24.5°C, Humi:55%, Press:100.1kPa
Memo : 11n40 5510MHz

D:\2019 RE1# Report Data\Q20190411 GGEC LinkMusic\RF.EM6
Tested By : Sunny
Model Number : LINK MUSIC
Test Mode : Tx mode
Antenna/Distance : 2018 HF 907/3m/VERTICAL

Data: 64

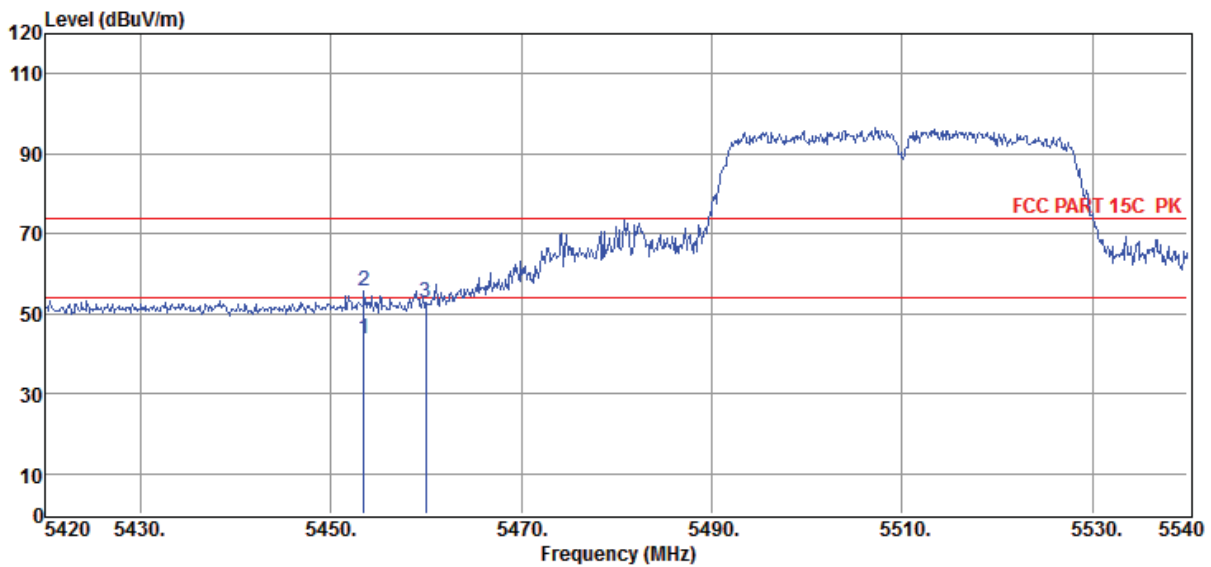

Item (Mark)	Freq. (MHz)	Read Level (dBμV)	Antenna Factor (dB/m)	PRM Factor (dB)	Cable Loss (dB)	Result Level (dBμV/m)	Limit Line (dBμV/m)	Over Limit (dB)	Detector	Polarization
1	5453.48	42.76	34.26	44.10	10.71	43.63	54.00	-10.37	Average	VERTICAL
2	5453.48	54.90	34.26	44.10	10.71	55.77	74.00	-18.23	Peak	VERTICAL
3	5460.00	51.79	34.27	44.10	10.74	52.70	74.00	-21.30	Peak	VERTICAL

Note: 1. Result Level = Read Level + Antenna Factor + Cable loss - PRM Factor.
 2. If Peak Result complies with AV limit, AV Result is deemed to comply with AV limit.
 3. Test setup: RBW: 1 MHz, VBW: 3 MHz, Sweep time: auto.

TR-4-E-009 Radiated Emission Test Result

Test Site : DDT 3m Chamber 1# D:\2019 RE1# Report Data\Q20190411 GGEC LinkMusic\RF.EM6
Test Date : 2019-04-11 **Tested By** : Sunny
EUT : WIRELESS SPEAKER **Model Number** : LINK MUSIC
Power Supply : AC 120V/60Hz **Test Mode** : Tx mode
Condition : Temp:24.5°C, Humi:55%, Press:100.1kPa **Antenna/Distance** : 2018 HF 907/3m/HORIZONTAL
Memo : 11ac20 5180MHz

Data: 65

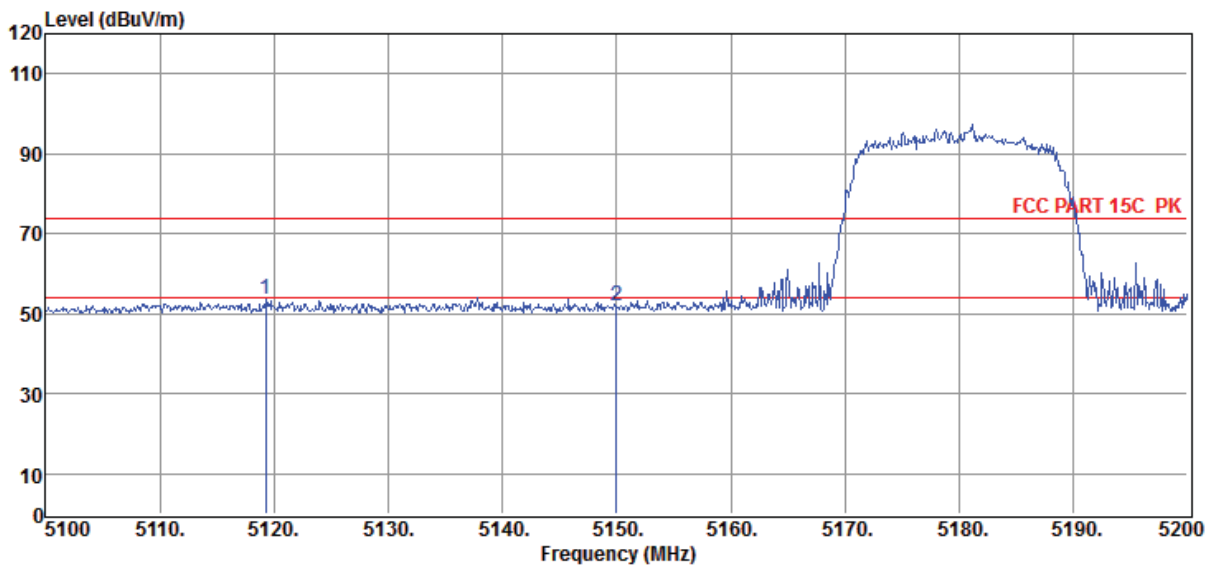

Item (Mark)	Freq. (MHz)	Read Level (dBμV)	Antenna Factor (dB/m)	PRM Factor (dB)	Cable Loss (dB)	Result Level (dBμV/m)	Limit Line (dBμV/m)	Over Limit (dB)	Detector	Polarization
1	5119.30	53.29	34.00	44.17	10.32	53.44	74.00	-20.56	Peak	HORIZONTAL
2	5150.00	51.93	34.02	44.17	10.36	52.14	74.00	-21.86	Peak	HORIZONTAL

- Note: 1. Result Level = Read Level + Antenna Factor + Cable loss - PRM Factor.
 2. If Peak Result complies with AV limit, AV Result is deemed to comply with AV limit.
 3. Test setup: RBW: 1 MHz, VBW: 3 MHz, Sweep time: auto.

TR-4-E-009 Radiated Emission Test Result

Test Site : DDT 3m Chamber 1#
Test Date : 2019-04-11
EUT : WIRELESS SPEAKER
Power Supply : AC 120V/60Hz
Condition : Temp:24.5°C, Humi:55%, Press:100.1kPa
Memo : 11ac20 5180MHz

D:\2019 RE1# Report Data\Q20190411 GGEC LinkMusic\RF.EM6
Tested By : Sunny
Model Number : LINK MUSIC
Test Mode : Tx mode
Antenna/Distance : 2018 HF 907/3m/VERTICAL

Data: 66

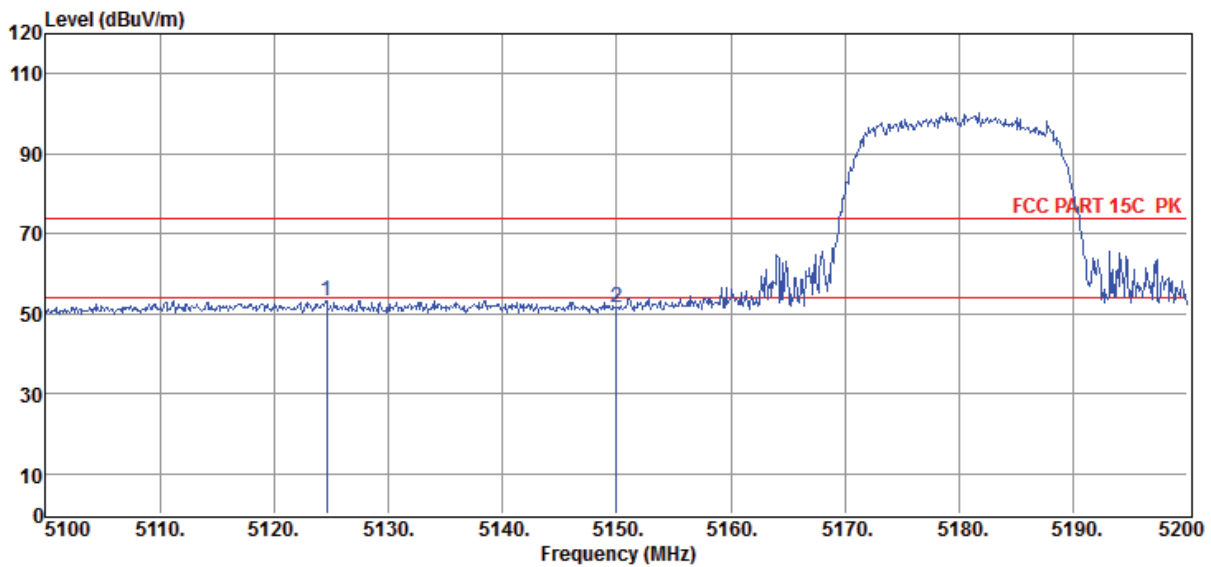

Item (Mark)	Freq. (MHz)	Read Level (dBμV)	Antenna Factor (dB/m)	PRM Factor (dB)	Cable Loss (dB)	Result Level (dBμV/m)	Limit Line (dBμV/m)	Over Limit (dB)	Detector	Polarization
1	5124.60	53.14	34.00	44.17	10.32	53.29	74.00	-20.71	Peak	VERTICAL
2	5150.00	51.46	34.02	44.17	10.36	51.67	74.00	-22.33	Peak	VERTICAL

- Note: 1. Result Level = Read Level + Antenna Factor + Cable loss - PRM Factor.
 2. If Peak Result complies with AV limit, AV Result is deemed to comply with AV limit.
 3. Test setup: RBW: 1 MHz, VBW: 3 MHz, Sweep time: auto.

TR-4-E-009 Radiated Emission Test Result

Test Site : DDT 3m Chamber 1# D:\2019 RE1# Report Data\Q20190411 GSEC LinkMusic\RF.EM6
Test Date : 2019-04-11 **Tested By** : Sunny
EUT : WIRELESS SPEAKER **Model Number** : LINK MUSIC
Power Supply : AC 120V/60Hz **Test Mode** : Tx mode
Condition : Temp:24.5°C, Humi:55%, Press:100.1kPa **Antenna/Distance** : 2018 HF 907/3m/HORIZONTAL
Memo : 11ac20 5320MHz

Data: 67

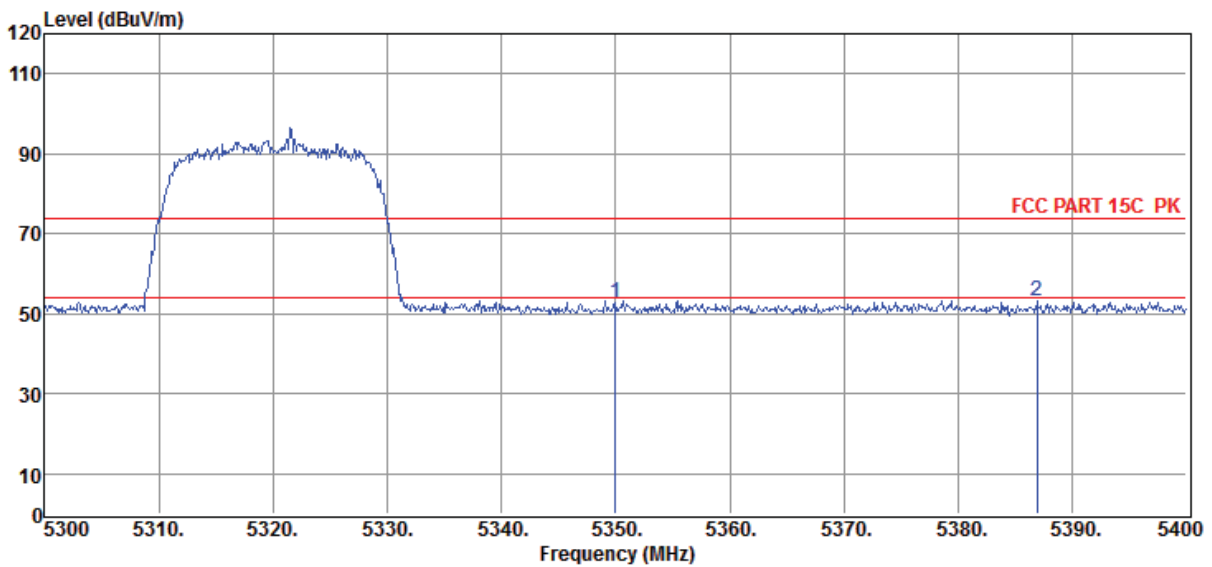

Item (Mark)	Freq. (MHz)	Read Level (dBµV)	Antenna Factor (dB/m)	PRM Factor (dB)	Cable Loss (dB)	Result Level (dBµV/m)	Limit Line (dBµV/m)	Over Limit (dB)	Detector	Polarization
1	5350.00	52.19	34.18	44.13	10.48	52.72	74.00	-21.28	Peak	HORIZONTAL
2	5386.90	52.57	34.21	44.12	10.48	53.14	74.00	-20.86	Peak	HORIZONTAL

- Note: 1. Result Level = Read Level + Antenna Factor + Cable loss - PRM Factor.
 2. If Peak Result complies with AV limit, AV Result is deemed to comply with AV limit.
 3. Test setup: RBW: 1 MHz, VBW: 3 MHz, Sweep time: auto.

TR-4-E-009 Radiated Emission Test Result

Test Site : DDT 3m Chamber 1#
Test Date : 2019-04-11
EUT : WIRELESS SPEAKER
Power Supply : AC 120V/60Hz
Condition : Temp:24.5°C, Humi:55%, Press:100.1kPa
Memo : 11ac20 5320MHz
Antenna/Distance : 2018 HF 907/3m/VERTICAL
Tested By : Sunny
Model Number : LINK MUSIC
Test Mode : Tx mode
Link : D:\2019 RE1# Report Data\Q20190411 GGEC LinkMusic\RF.EM6

Data: 68

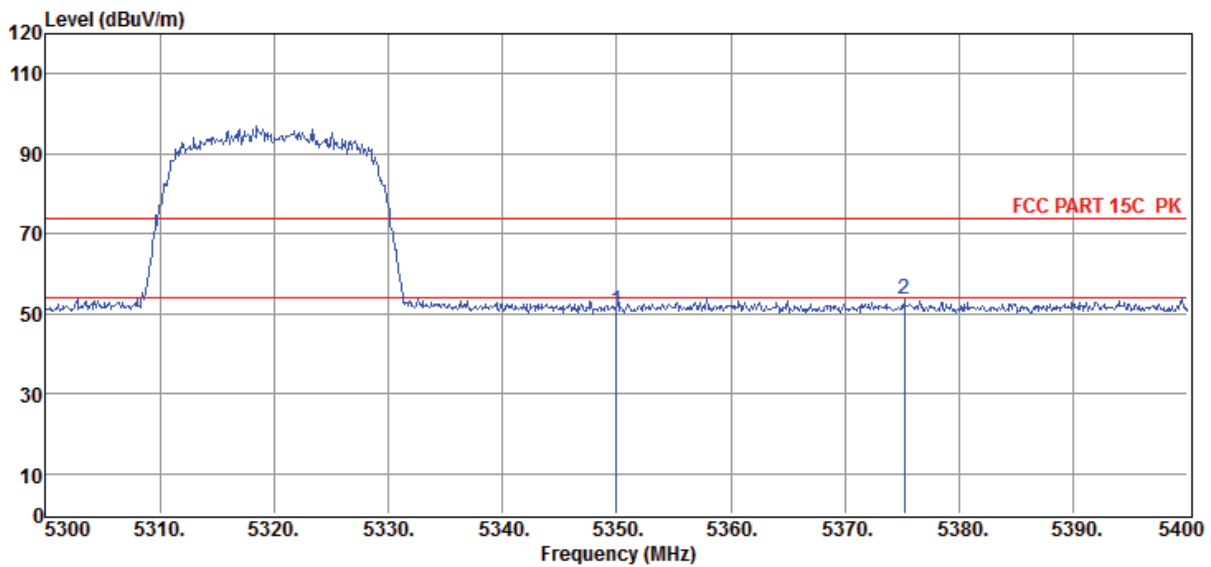

Item (Mark)	Freq. (MHz)	Read Level (dBμV)	Antenna Factor (dB/m)	PRM Factor (dB)	Cable Loss (dB)	Result Level (dBμV/m)	Limit Line (dBμV/m)	Over Limit (dB)	Detector	Polarization
1	5350.00	50.09	34.18	44.13	10.48	50.62	74.00	-23.38	Peak	VERTICAL
2	5375.20	52.94	34.20	44.12	10.48	53.50	74.00	-20.50	Peak	VERTICAL

Note: 1. Result Level = Read Level + Antenna Factor + Cable loss - PRM Factor.
 2. If Peak Result complies with AV limit, AV Result is deemed to comply with AV limit.
 3. Test setup: RBW: 1 MHz, VBW: 3 MHz, Sweep time: auto.

TR-4-E-009 Radiated Emission Test Result

Test Site : DDT 3m Chamber 1#
Test Date : 2019-04-11
EUT : WIRELESS SPEAKER
Power Supply : AC 120V/60Hz
Condition : Temp:24.5°C, Humi:55%, Press:100.1kPa
Memo : 11ac20 5500MHz
Antenna/Distance : 2018 HF 907/3m/HORIZONTAL
Tested By : Sunny
Model Number : LINK MUSIC
Test Mode : Tx mode
Data: 69

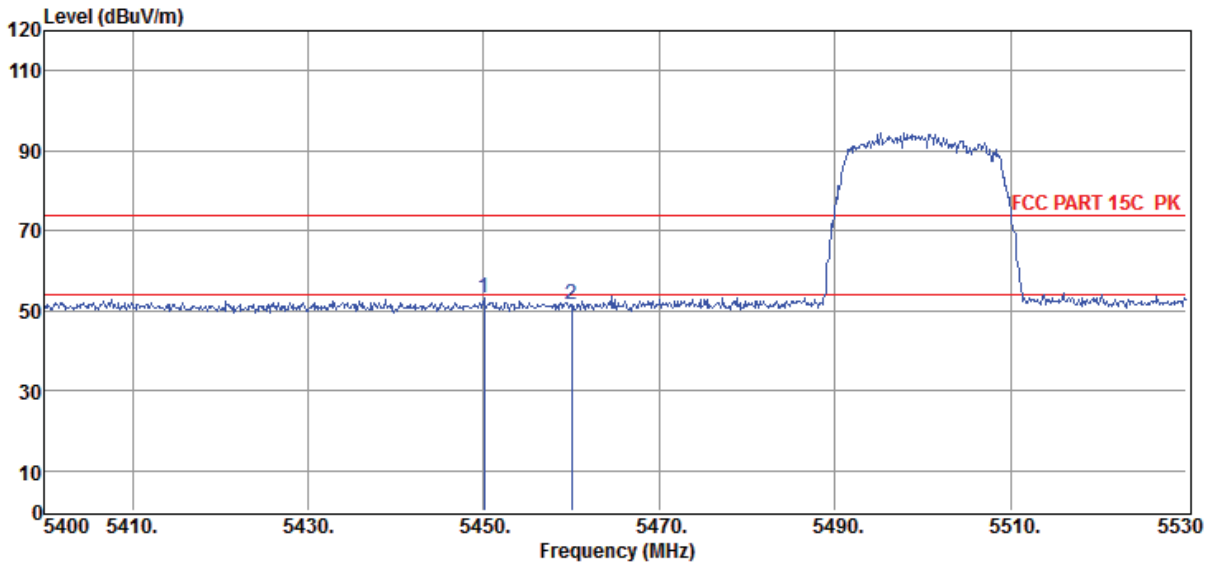

Item (Mark)	Freq. (MHz)	Read Level (dBμV)	Antenna Factor (dB/m)	PRM Factor (dB)	Cable Loss (dB)	Result Level (dBμV/m)	Limit Line (dBμV/m)	Over Limit (dB)	Detector	Polarization
1	5450.05	52.30	34.26	44.11	10.70	53.15	74.00	-20.85	Peak	HORIZONTAL
2	5460.00	50.44	34.27	44.10	10.74	51.35	74.00	-22.65	Peak	HORIZONTAL

Note: 1. Result Level = Read Level + Antenna Factor + Cable loss - PRM Factor.
 2. If Peak Result complies with AV limit, AV Result is deemed to comply with AV limit.
 3. Test setup: RBW: 1 MHz, VBW: 3 MHz, Sweep time: auto.

TR-4-E-009 Radiated Emission Test Result

Test Site : DDT 3m Chamber 1#
Test Date : 2019-04-11
EUT : WIRELESS SPEAKER
Power Supply : AC 120V/60Hz
Condition : Temp:24.5'C, Humi:55%, Press:100.1kPa
Memo : 11ac20 5500MHz
D:\2019 RE1# Report Data\Q20190411 GSEC LinkMusic\RF.EM6
Tested By : Sunny
Model Number : LINK MUSIC
Test Mode : Tx mode
Antenna/Distance : 2018 HF 907/3m/VERTICAL

Data: 70

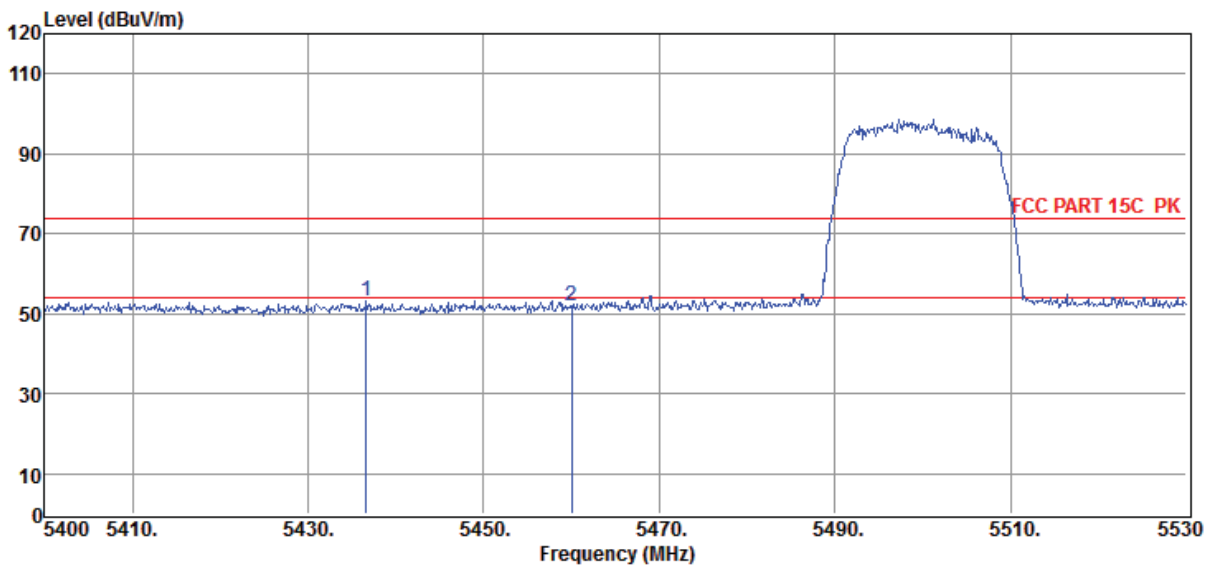

Item (Mark)	Freq. (MHz)	Read Level (dBμV)	Antenna Factor (dB/m)	PRM Factor (dB)	Cable Loss (dB)	Result Level (dBμV/m)	Limit Line (dBμV/m)	Over Limit (dB)	Detector	Polarization
1	5436.66	52.30	34.25	44.11	10.64	53.08	74.00	-20.92	Peak	VERTICAL
2	5460.00	51.08	34.27	44.10	10.74	51.99	74.00	-22.01	Peak	VERTICAL

- Note: 1. Result Level = Read Level + Antenna Factor + Cable loss - PRM Factor.
 2. If Peak Result complies with AV limit, AV Result is deemed to comply with AV limit.
 3. Test setup: RBW: 1 MHz, VBW: 3 MHz, Sweep time: auto.

TR-4-E-009 Radiated Emission Test Result

Test Site : DDT 3m Chamber 1#
Test Date : 2019-04-11
EUT : WIRELESS SPEAKER
Power Supply : AC 120V/60Hz
Condition : Temp:24.5°C, Humi:55%, Press:100.1kPa
Memo : 11ac40 5190MHz

D:\2019 RE1# Report Data\Q20190411 GGEC LinkMusic\RF.EM6
Tested By : Sunny
Model Number : LINK MUSIC
Test Mode : Tx mode
Antenna/Distance : 2018 HF 907/3m/HORIZONTAL

Data: 71

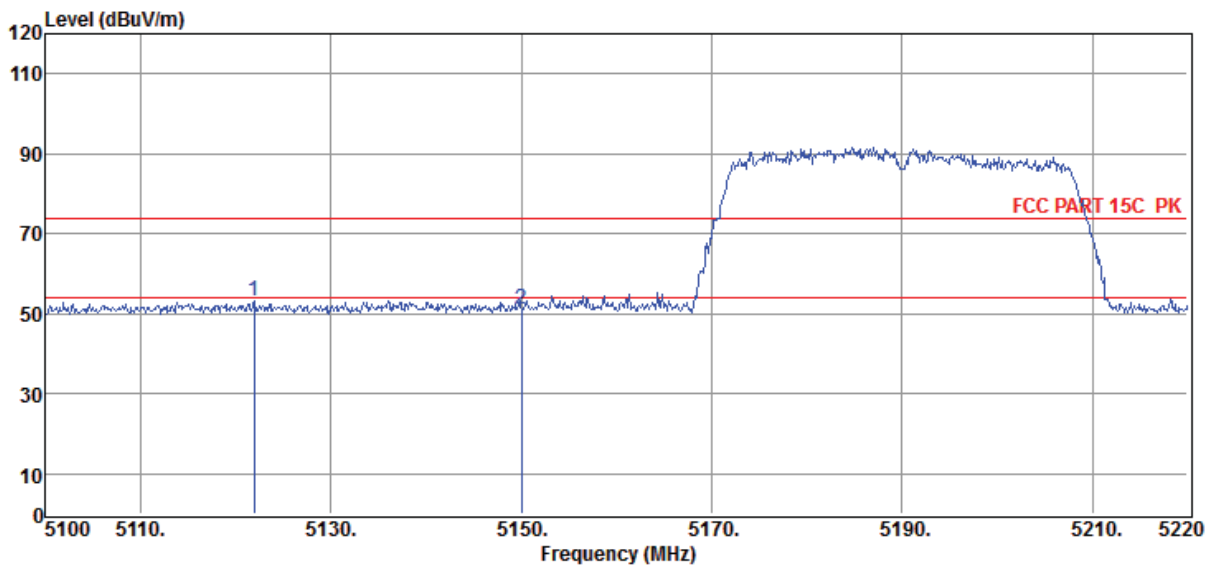

Item (Mark)	Freq. (MHz)	Read Level (dBuV)	Antenna Factor (dB/m)	PRM Factor (dB)	Cable Loss (dB)	Result Level (dBuV/m)	Limit Line (dBuV/m)	Over Limit (dB)	Detector	Polarization
1	5121.96	53.03	34.00	44.17	10.32	53.18	74.00	-20.82	Peak	HORIZONTAL
2	5150.00	51.01	34.02	44.17	10.36	51.22	74.00	-22.78	Peak	HORIZONTAL

- Note: 1. Result Level = Read Level + Antenna Factor + Cable loss - PRM Factor.
 2. If Peak Result complies with AV limit, AV Result is deemed to comply with AV limit.
 3. Test setup: RBW: 1 MHz, VBW: 3 MHz, Sweep time: auto.

TR-4-E-009 Radiated Emission Test Result

Test Site : DDT 3m Chamber 1# D:\2019 RE1# Report Data\Q20190411 GGEC LinkMusic\RF.EM6
Test Date : 2019-04-11 **Tested By** : Sunny
EUT : WIRELESS SPEAKER **Model Number** : LINK MUSIC
Power Supply : AC 120V/60Hz **Test Mode** : Tx mode
Condition : Temp:24.5°C, Humi:55%, Press:100.1kPa **Antenna/Distance** : 2018 HF 907/3m/VERTICAL
Memo : 11ac40 5190MHz

Data: 72

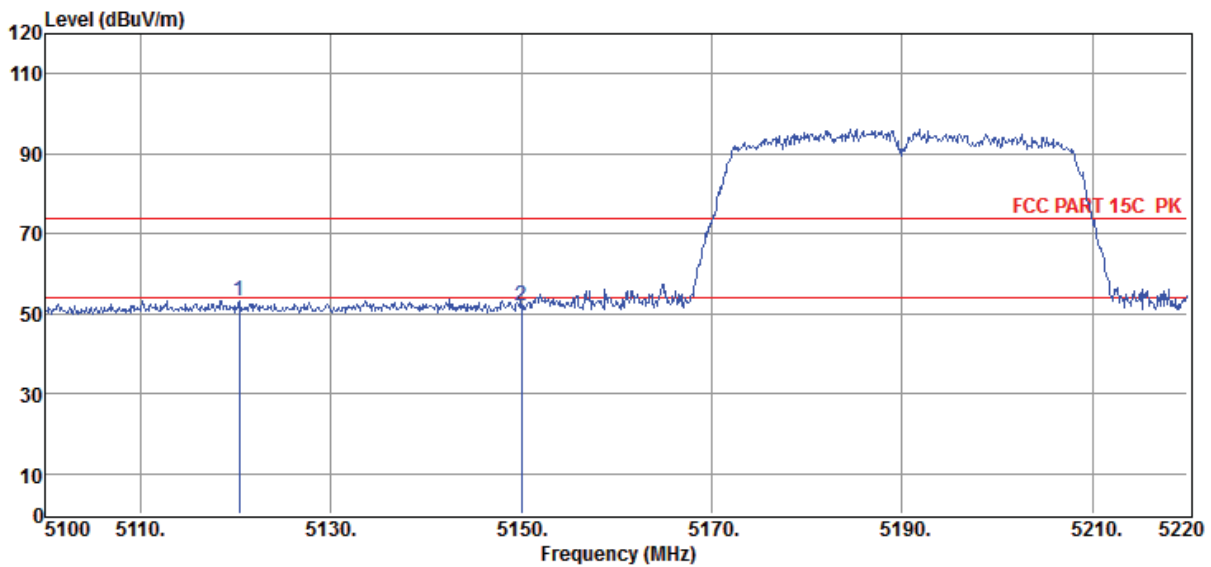

Item (Mark)	Freq. (MHz)	Read Level (dBuV)	Antenna Factor (dB/m)	PRM Factor (dB)	Cable Loss (dB)	Result Level (dBuV/m)	Limit Line (dBuV/m)	Over Limit (dB)	Detector	Polarization
1	5120.40	53.24	34.00	44.17	10.32	53.39	74.00	-20.61	Peak	VERTICAL
2	5150.00	51.70	34.02	44.17	10.36	51.91	74.00	-22.09	Peak	VERTICAL

- Note: 1. Result Level = Read Level + Antenna Factor + Cable loss - PRM Factor.
 2. If Peak Result complies with AV limit, AV Result is deemed to comply with AV limit.
 3. Test setup: RBW: 1 MHz, VBW: 3 MHz, Sweep time: auto.

TR-4-E-009 Radiated Emission Test Result

Test Site : DDT 3m Chamber 1# D:\2019 RE1# Report Data\Q20190411 GGEC LinkMusic\RF.EM6
Test Date : 2019-04-11 **Tested By** : Sunny
EUT : WIRELESS SPEAKER **Model Number** : LINK MUSIC
Power Supply : AC 120V/60Hz **Test Mode** : Tx mode
Condition : Temp:24.5°C, Humi:55%, Press:100.1kPa **Antenna/Distance** : 2018 HF 907/3m/HORIZONTAL
Memo : 11ac40 5310MHz

Data: 73

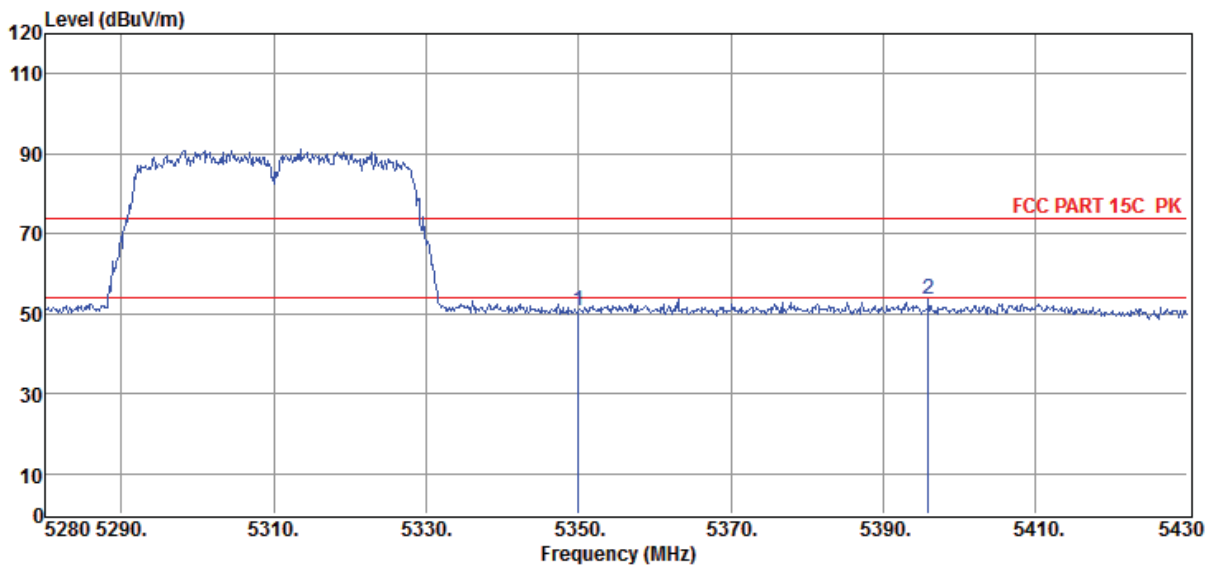

Item (Mark)	Freq. (MHz)	Read Level (dBμV)	Antenna Factor (dB/m)	PRM Factor (dB)	Cable Loss (dB)	Result Level (dBμV/m)	Limit Line (dBμV/m)	Over Limit (dB)	Detector	Polarization
1	5350.00	50.35	34.18	44.13	10.48	50.88	74.00	-23.12	Peak	HORIZONTAL
2	5395.95	53.04	34.22	44.12	10.48	53.62	74.00	-20.38	Peak	HORIZONTAL

- Note: 1. Result Level = Read Level + Antenna Factor + Cable loss - PRM Factor.
 2. If Peak Result complies with AV limit, AV Result is deemed to comply with AV limit.
 3. Test setup: RBW: 1 MHz, VBW: 3 MHz, Sweep time: auto.

TR-4-E-009 Radiated Emission Test Result

Test Site : DDT 3m Chamber 1#
Test Date : 2019-04-11
EUT : WIRELESS SPEAKER
Power Supply : AC 120V/60Hz
Condition : Temp:24.5°C, Humi:55%, Press:100.1kPa
Memo : 11ac40 5310MHz

D:\2019 RE1# Report Data\Q20190411 GSEC LinkMusic\RF.EM6
Tested By : Sunny
Model Number : LINK MUSIC
Test Mode : Tx mode
Antenna/Distance : 2018 HF 907/3m/VERTICAL

Data: 74

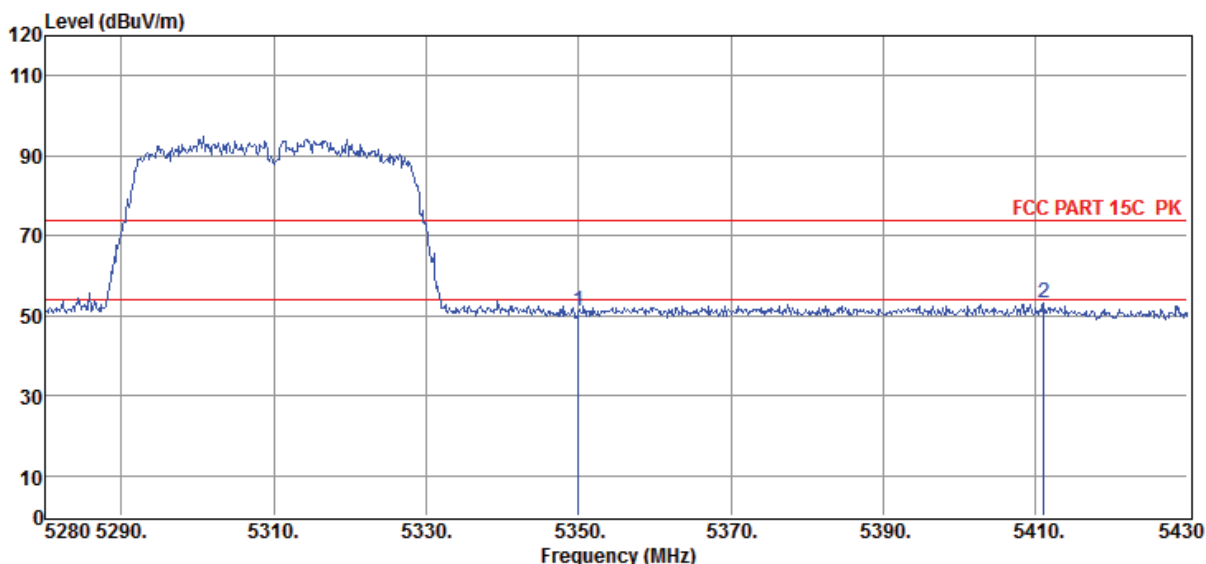

Item (Mark)	Freq. (MHz)	Read Level (dBμV)	Antenna Factor (dB/m)	PRM Factor (dB)	Cable Loss (dB)	Result Level (dBμV/m)	Limit Line (dBμV/m)	Over Limit (dB)	Detector	Polarization
1	5350.00	50.60	34.18	44.13	10.48	51.13	74.00	-22.87	Peak	VERTICAL
2	5411.10	52.64	34.23	44.11	10.53	53.29	74.00	-20.71	Peak	VERTICAL

- Note: 1. Result Level = Read Level + Antenna Factor + Cable loss - PRM Factor.
 2. If Peak Result complies with AV limit, AV Result is deemed to comply with AV limit.
 3. Test setup: RBW: 1 MHz, VBW: 3 MHz, Sweep time: auto.

TR-4-E-009 Radiated Emission Test Result

Test Site : DDT 3m Chamber 1#
Test Date : 2019-04-11
EUT : WIRELESS SPEAKER
Power Supply : AC 120V/60Hz
Condition : Temp:24.5°C, Humi:55%, Press:100.1kPa
Memo : 11ac40 5510MHz

D:\2019 RE1# Report Data\Q20190411 GGEC LinkMusic\RF.EM6
Tested By : Sunny
Model Number : LINK MUSIC
Test Mode : Tx mode
Antenna/Distance : 2018 HF 907/3m/HORIZONTAL

Data: 75

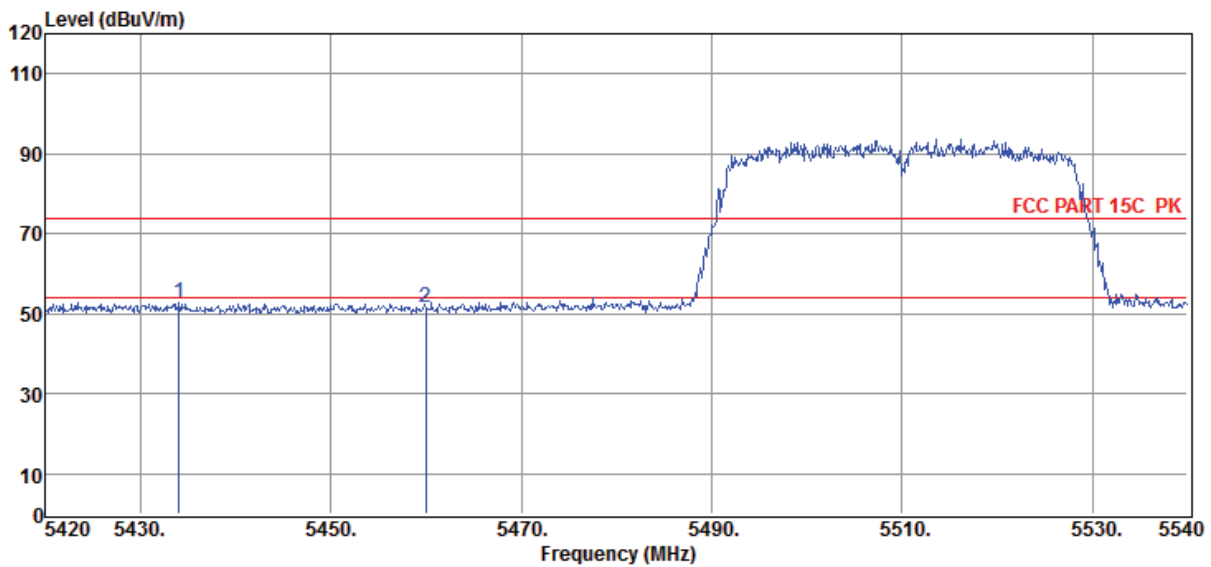

Item (Mark)	Freq. (MHz)	Read Level (dBμV)	Antenna Factor (dB/m)	PRM Factor (dB)	Cable Loss (dB)	Result Level (dBμV/m)	Limit Line (dBμV/m)	Over Limit (dB)	Detector	Polarization
1	5434.04	51.91	34.25	44.11	10.63	52.68	74.00	-21.32	Peak	HORIZONTAL
2	5460.00	50.74	34.27	44.10	10.74	51.65	74.00	-22.35	Peak	HORIZONTAL

- Note: 1. Result Level = Read Level + Antenna Factor + Cable loss - PRM Factor.
 2. If Peak Result complies with AV limit, AV Result is deemed to comply with AV limit.
 3. Test setup: RBW: 1 MHz, VBW: 3 MHz, Sweep time: auto.

TR-4-E-009 Radiated Emission Test Result

Test Site : DDT 3m Chamber 1#
Test Date : 2019-04-11
EUT : WIRELESS SPEAKER
Power Supply : AC 120V/60Hz
Condition : Temp:24.5°C, Humi:55%, Press:100.1kPa
Memo : 11ac40 5510MHz

D:\2019 RE1# Report Data\Q20190411 GGEC LinkMusic\RF.EM6
Tested By : Sunny
Model Number : LINK MUSIC
Test Mode : Tx mode
Antenna/Distance : 2018 HF 907/3m/VERTICAL

Data: 76

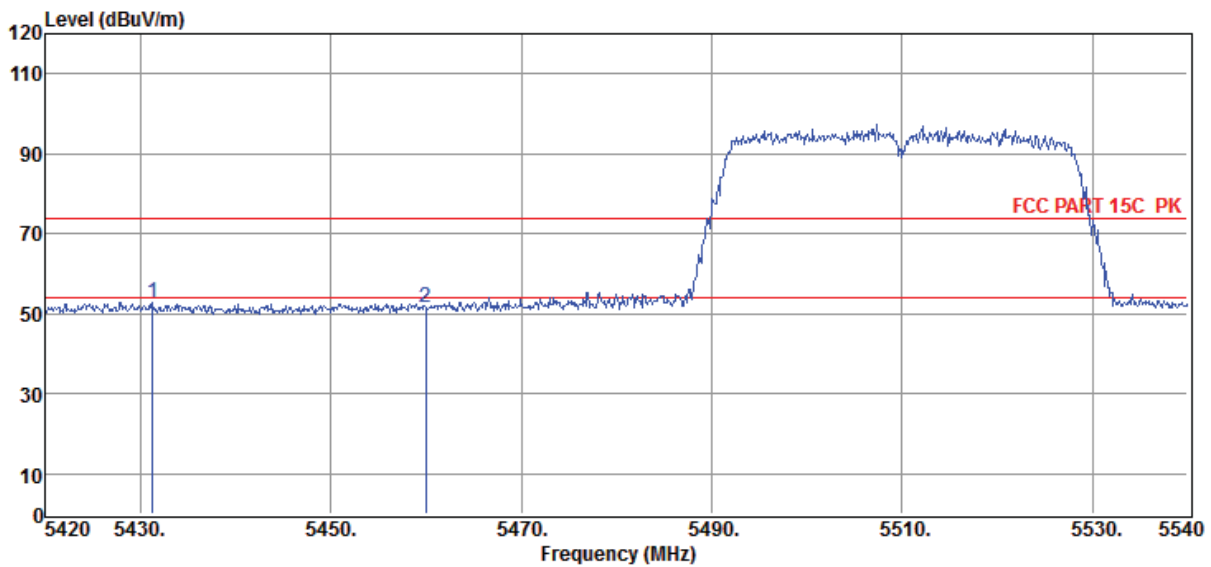

Item (Mark)	Freq. (MHz)	Read Level (dBμV)	Antenna Factor (dB/m)	PRM Factor (dB)	Cable Loss (dB)	Result Level (dBμV/m)	Limit Line (dBμV/m)	Over Limit (dB)	Detector	Polarization
1	5431.28	51.90	34.25	44.11	10.61	52.65	74.00	-21.35	Peak	VERTICAL
2	5460.00	50.53	34.27	44.10	10.74	51.44	74.00	-22.56	Peak	VERTICAL

- Note: 1. Result Level = Read Level + Antenna Factor + Cable loss - PRM Factor.
 2. If Peak Result complies with AV limit, AV Result is deemed to comply with AV limit.
 3. Test setup: RBW: 1 MHz, VBW: 3 MHz, Sweep time: auto.

TR-4-E-009 Radiated Emission Test Result

Test Site : DDT 3m Chamber 1# D:\2019 RE1# Report Data\Q20190411 GGEC LinkMusic\RF.EM6
Test Date : 2019-04-11 **Tested By** : Sunny
EUT : WIRELESS SPEAKER **Model Number** : LINK MUSIC
Power Supply : AC 120V/60Hz **Test Mode** : Tx mode
Condition : Temp:24.5°C, Humi:55%, Press:100.1kPa **Antenna/Distance** : 2018 HF 907/3m/HORIZONTAL
Memo : 11ac80 5210MHz

Data: 77

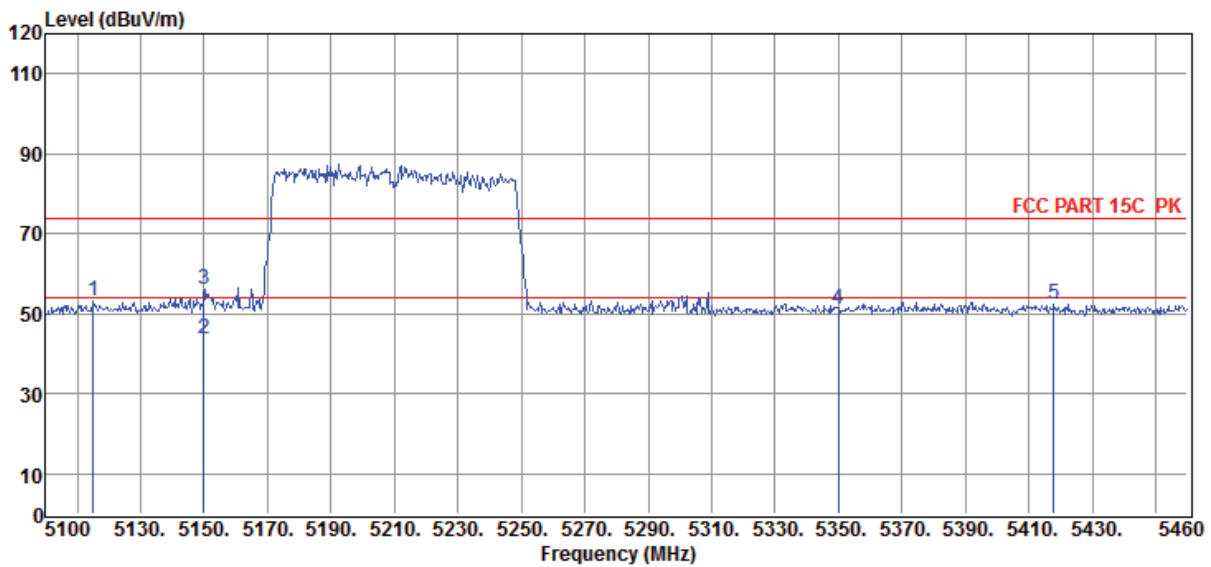

Item (Mark)	Freq. (MHz)	Read Level (dBμV)	Antenna Factor (dB/m)	PRM Factor dB	Cable Loss dB	Result Level (dBμV/m)	Limit Line (dBμV/m)	Over Limit (dB)	Detector	Polarization
1	5115.12	53.00	34.00	44.18	10.31	53.13	74.00	-20.87	Peak	HORIZONTAL
2	5150.00	43.47	34.02	44.17	10.36	43.68	54.00	-10.32	Average	HORIZONTAL
3	5150.00	55.91	34.02	44.17	10.36	56.12	74.00	-17.88	Peak	HORIZONTAL
4	5350.00	50.42	34.18	44.13	10.48	50.95	74.00	-23.05	Peak	HORIZONTAL
5	5417.88	51.77	34.24	44.11	10.56	52.46	74.00	-21.54	Peak	HORIZONTAL

Note: 1. Result Level = Read Level + Antenna Factor + Cable loss - PRM Factor.
 2. If Peak Result complies with AV limit, AV Result is deemed to comply with AV limit.
 3. Test setup: RBW: 1 MHz, VBW: 3 MHz, Sweep time: auto.

TR-4-E-009 Radiated Emission Test Result

Test Site : DDT 3m Chamber 1# D:\2019 RE1# Report Data\Q20190411 GGEC LinkMusic\RF.EM6
Test Date : 2019-04-11 **Tested By** : Sunny
EUT : WIRELESS SPEAKER **Model Number** : LINK MUSIC
Power Supply : AC 120V/60Hz **Test Mode** : Tx mode
Condition : Temp:24.5°C, Humi:55%, Press:100.1kPa **Antenna/Distance** : 2018 HF 907/3m/VERTICAL
Memo : 11ac80 5210MHz

Data: 78

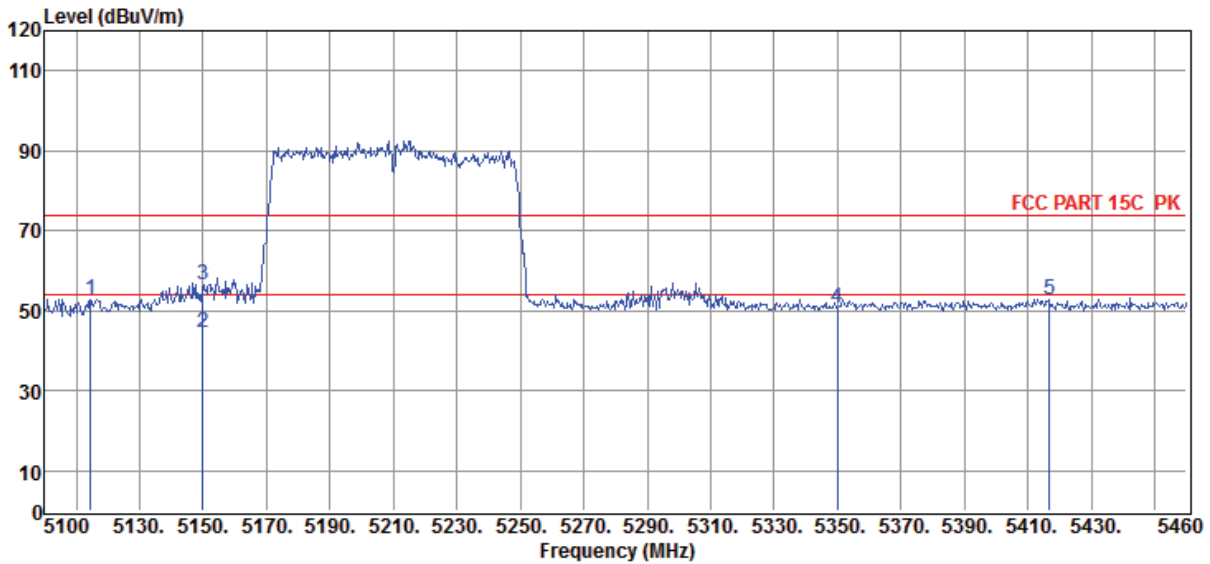

Item (Mark)	Freq. (MHz)	Read Level (dBμV)	Antenna Factor (dB/m)	PRM Factor (dB)	Cable Loss (dB)	Result Level (dBμV/m)	Limit Line (dBμV/m)	Over Limit (dB)	Detector	Polarization
1	5114.40	52.60	33.99	44.18	10.31	52.72	74.00	-21.28	Peak	VERTICAL
2	5150.00	44.40	34.02	44.17	10.36	44.61	54.00	-9.39	Average	VERTICAL
3	5150.00	56.11	34.02	44.17	10.36	56.32	74.00	-17.68	Peak	VERTICAL
4	5350.00	50.17	34.18	44.13	10.48	50.70	74.00	-23.30	Peak	VERTICAL
5	5416.80	52.03	34.24	44.11	10.55	52.71	74.00	-21.29	Peak	VERTICAL

Note: 1. Result Level = Read Level + Antenna Factor + Cable loss - PRM Factor.
 2. If Peak Result complies with AV limit, AV Result is deemed to comply with AV limit.
 3. Test setup: RBW: 1 MHz, VBW: 3 MHz, Sweep time: auto.

TR-4-E-009 Radiated Emission Test Result

Test Site : DDT 3m Chamber 1# D:\2019 RE1# Report Data\Q20190411 GGEC LinkMusic\RF.EM6
Test Date : 2019-04-11 **Tested By** : Sunny
EUT : WIRELESS SPEAKER **Model Number** : LINK MUSIC
Power Supply : AC 120V/60Hz **Test Mode** : Tx mode
Condition : Temp:24.5°C, Humi:55%, Press:100.1kPa **Antenna/Distance** : 2018 HF 907/3m/HORIZONTAL
Memo : 11ac80 5290MHz

Data: 79

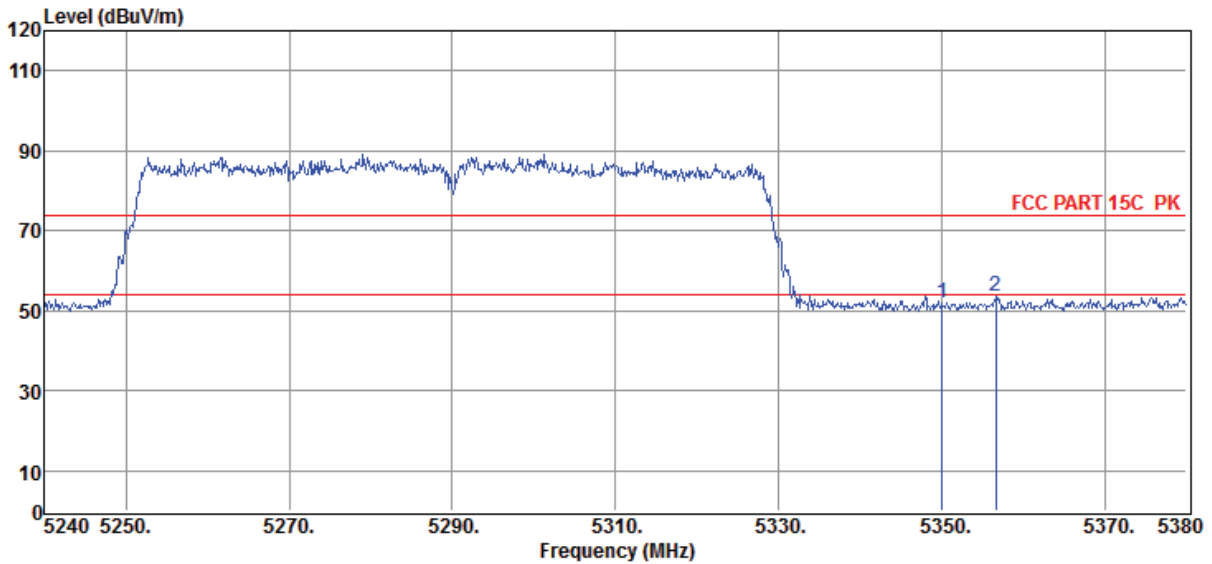

Item (Mark)	Freq. (MHz)	Read Level (dBuV)	Antenna Factor (dB/m)	PRM Factor (dB)	Cable Loss (dB)	Result Level (dBuV/m)	Limit Line (dBuV/m)	Over Limit (dB)	Detector	Polarization
1	5350.00	51.62	34.18	44.13	10.48	52.15	74.00	-21.85	Peak	HORIZONTAL
2	5356.62	53.06	34.19	44.12	10.48	53.61	74.00	-20.39	Peak	HORIZONTAL

Note: 1. Result Level = Read Level + Antenna Factor + Cable loss - PRM Factor.
 2. If Peak Result complies with AV limit, AV Result is deemed to comply with AV limit.
 3. Test setup: RBW: 1 MHz, VBW: 3 MHz, Sweep time: auto.

TR-4-E-009 Radiated Emission Test Result

Test Site : DDT 3m Chamber 1#
Test Date : 2019-04-11
EUT : WIRELESS SPEAKER
Power Supply : AC 120V/60Hz
Condition : Temp:24.5°C, Humi:55%, Press:100.1kPa
Memo : 11ac80 5290MHz

D:\2019 RE1# Report Data\Q20190411 GGEC LinkMusic\RF.EM6
Tested By : Sunny
Model Number : LINK MUSIC
Test Mode : Tx mode
Antenna/Distance : 2018 HF 907/3m/VERTICAL

Data: 80

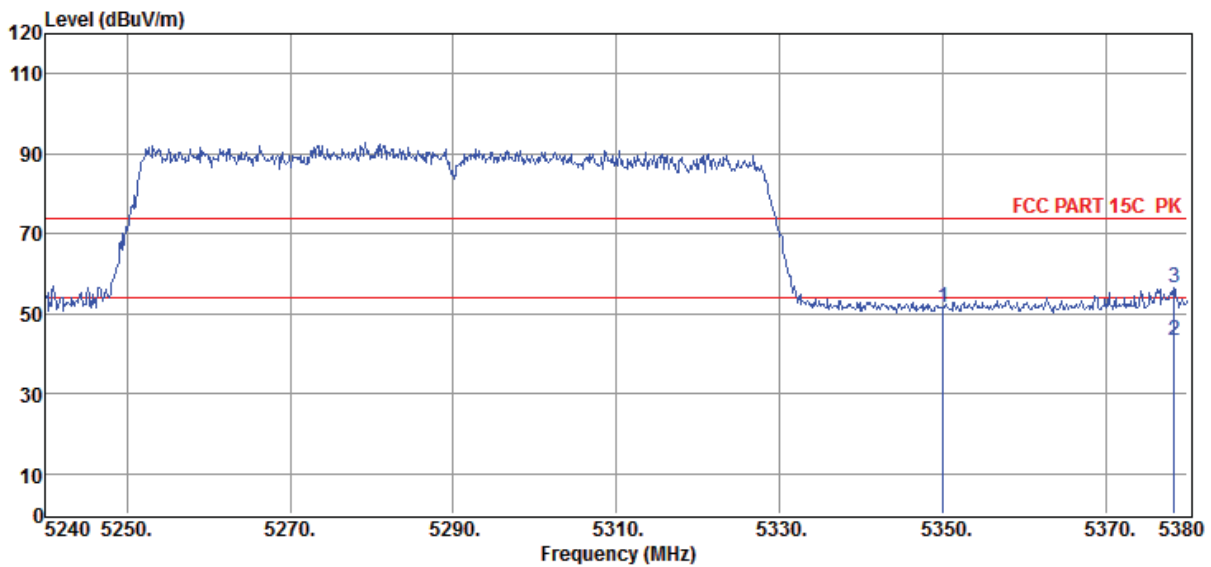

Item (Mark)	Freq. (MHz)	Read Level (dBμV)	Antenna Factor (dB/m)	PRM Factor dB	Cable Loss dB	Result Level (dBμV/m)	Limit Line (dBμV/m)	Over Limit (dB)	Detector	Polarization
1	5350.00	51.00	34.18	44.13	10.48	51.53	74.00	-22.47	Peak	VERTICAL
2	5378.32	42.53	34.21	44.12	10.48	43.10	54.00	-10.90	Average	VERTICAL
3	5378.32	56.12	34.21	44.12	10.48	56.69	74.00	-17.31	Peak	VERTICAL

- Note: 1. Result Level = Read Level + Antenna Factor + Cable loss - PRM Factor.
 2. If Peak Result complies with AV limit, AV Result is deemed to comply with AV limit.
 3. Test setup: RBW: 1 MHz, VBW: 3 MHz, Sweep time: auto.

TR-4-E-009 Radiated Emission Test Result

Test Site : DDT 3m Chamber 1# D:\2019 RE1# Report Data\Q20190411 GGEC LinkMusic\RF.EM6
Test Date : 2019-04-11 **Tested By** : Sunny
EUT : WIRELESS SPEAKER **Model Number** : LINK MUSIC
Power Supply : AC 120V/60Hz **Test Mode** : Tx mode
Condition : Temp:24.5°C, Humi:55%, Press:100.1kPa **Antenna/Distance** : 2018 HF 907/3m/HORIZONTAL
Memo : 11ac80 5530MHz

Data: 81

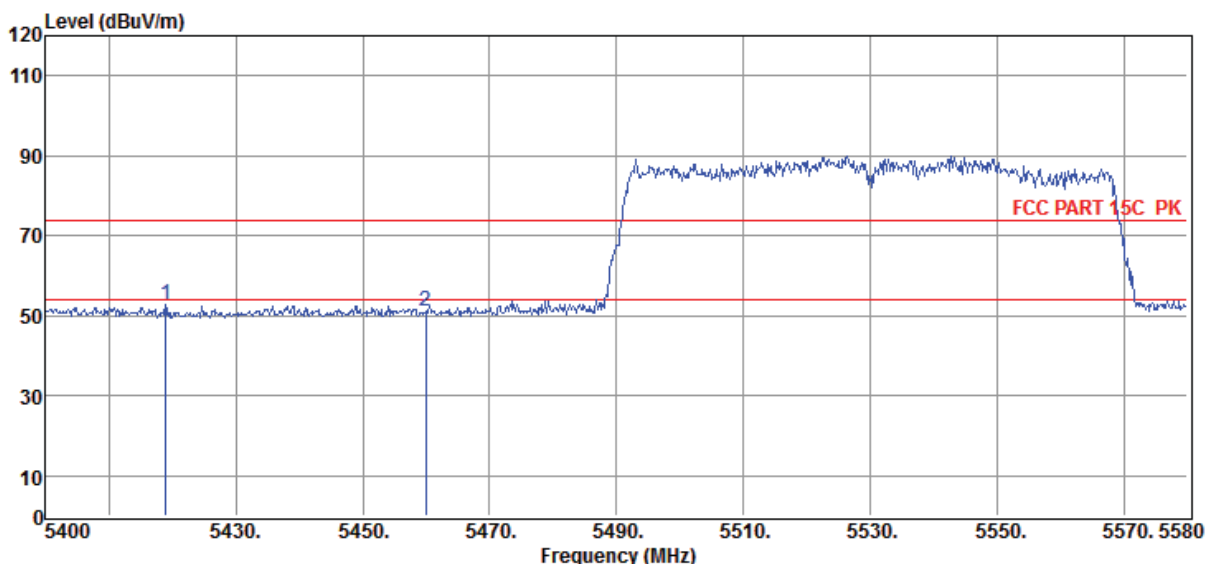

Item (Mark)	Freq. (MHz)	Read Level (dBμV)	Antenna Factor (dB/m)	PRM Factor (dB)	Cable Loss (dB)	Result Level (dBμV/m)	Limit Line (dBμV/m)	Over Limit (dB)	Detector	Polarization
1	5418.90	51.96	34.24	44.11	10.56	52.65	74.00	-21.35	Peak	HORIZONTAL
2	5460.00	50.10	34.27	44.10	10.74	51.01	74.00	-22.99	Peak	HORIZONTAL

- Note: 1. Result Level = Read Level + Antenna Factor + Cable loss - PRM Factor.
 2. If Peak Result complies with AV limit, AV Result is deemed to comply with AV limit.
 3. Test setup: RBW: 1 MHz, VBW: 3 MHz, Sweep time: auto.

TR-4-E-009 Radiated Emission Test Result

Test Site : DDT 3m Chamber 1#
Test Date : 2019-04-11
EUT : WIRELESS SPEAKER
Power Supply : AC 120V/60Hz
Condition : Temp:24.5°C, Humi:55%, Press:100.1kPa
Memo : 11ac80 5530MHz
Data: 82

D:\2019 RE1# Report Data\Q20190411 GSEC LinkMusic\RF.EM6
Tested By : Sunny
Model Number : LINK MUSIC
Test Mode : Tx mode
Antenna/Distance : 2018 HF 907/3m/VERTICAL

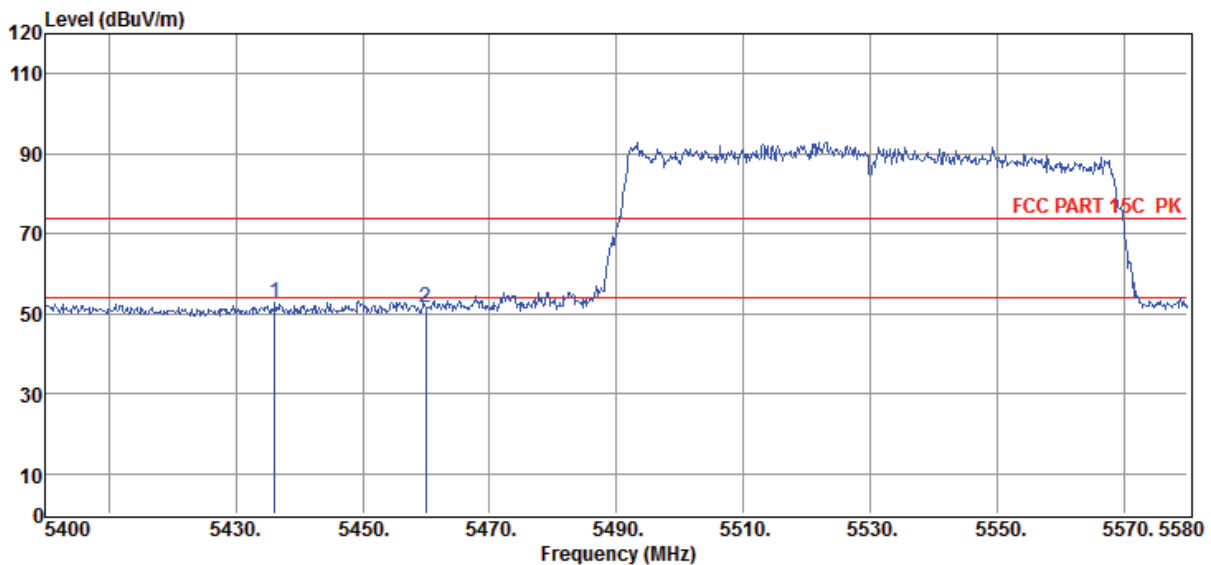

Item (Mark)	Freq. (MHz)	Read Level (dBμV)	Antenna Factor (dB/m)	PRM Factor (dB)	Cable Loss (dB)	Result Level (dBμV/m)	Limit Line (dBμV/m)	Over Limit (dB)	Detector	Polarization
1	5436.18	51.86	34.25	44.11	10.64	52.64	74.00	-21.36	Peak	VERTICAL
2	5460.00	50.55	34.27	44.10	10.74	51.46	74.00	-22.54	Peak	VERTICAL

Note: 1. Result Level = Read Level + Antenna Factor + Cable loss - PRM Factor.
 2. If Peak Result complies with AV limit, AV Result is deemed to comply with AV limit.
 3. Test setup: RBW: 1 MHz, VBW: 3 MHz, Sweep time: auto.

11A ANT1 5745

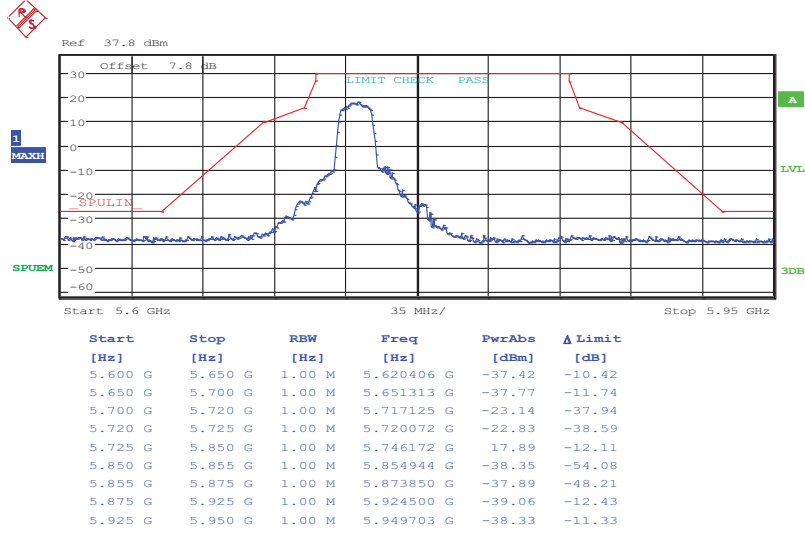

Date: 28.APR.2019 16:06:45

11A ANT2 5745

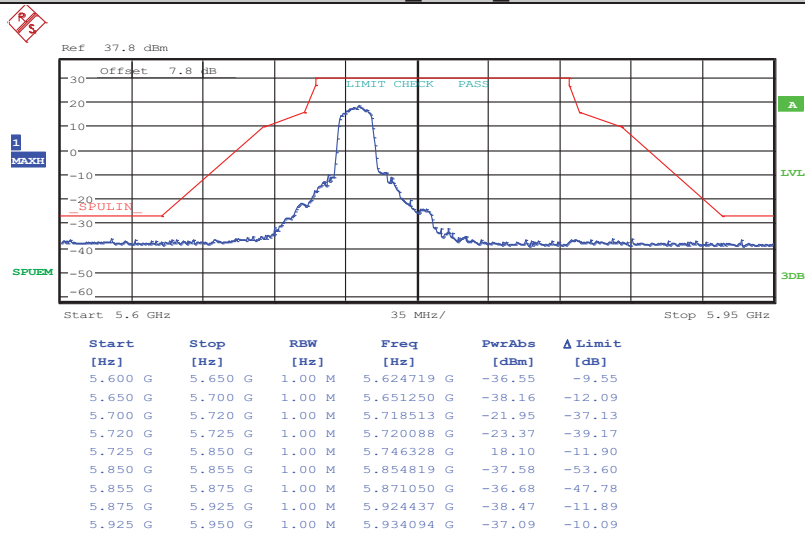

Date: 28.APR.2019 16:25:19

11A ANT1 5785

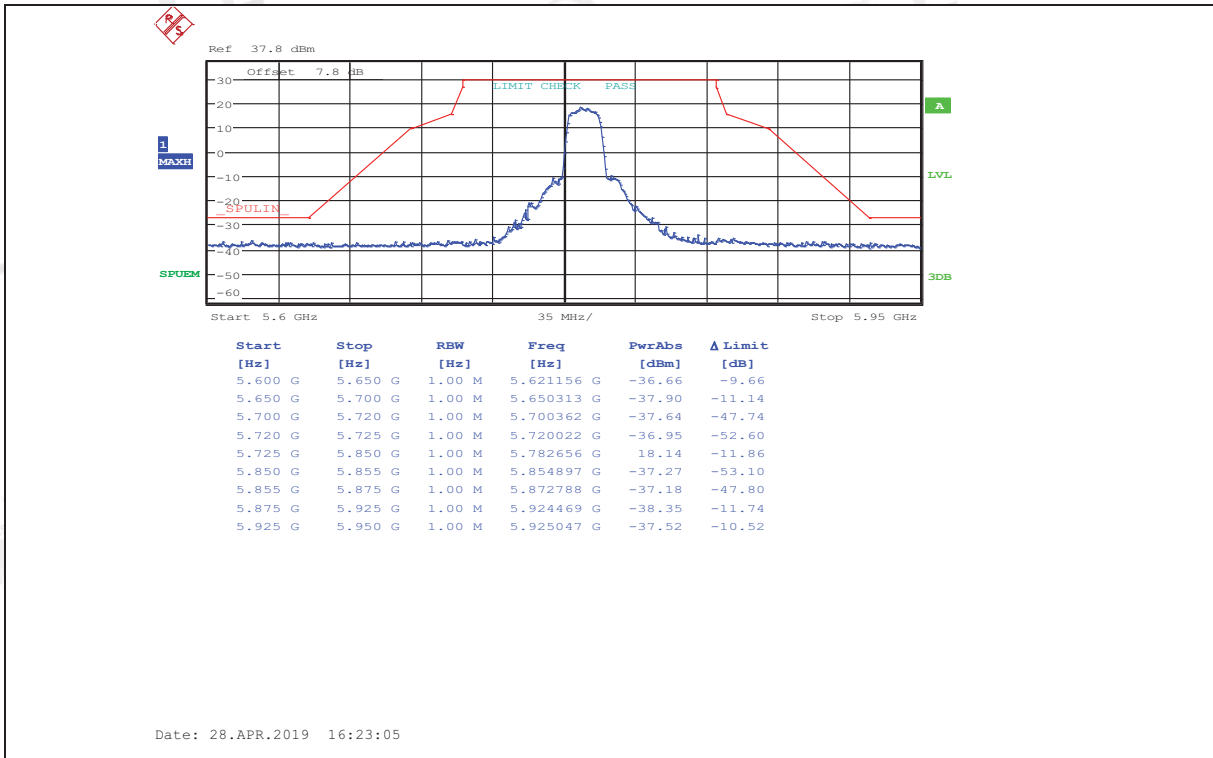

11A_ANT2_5785

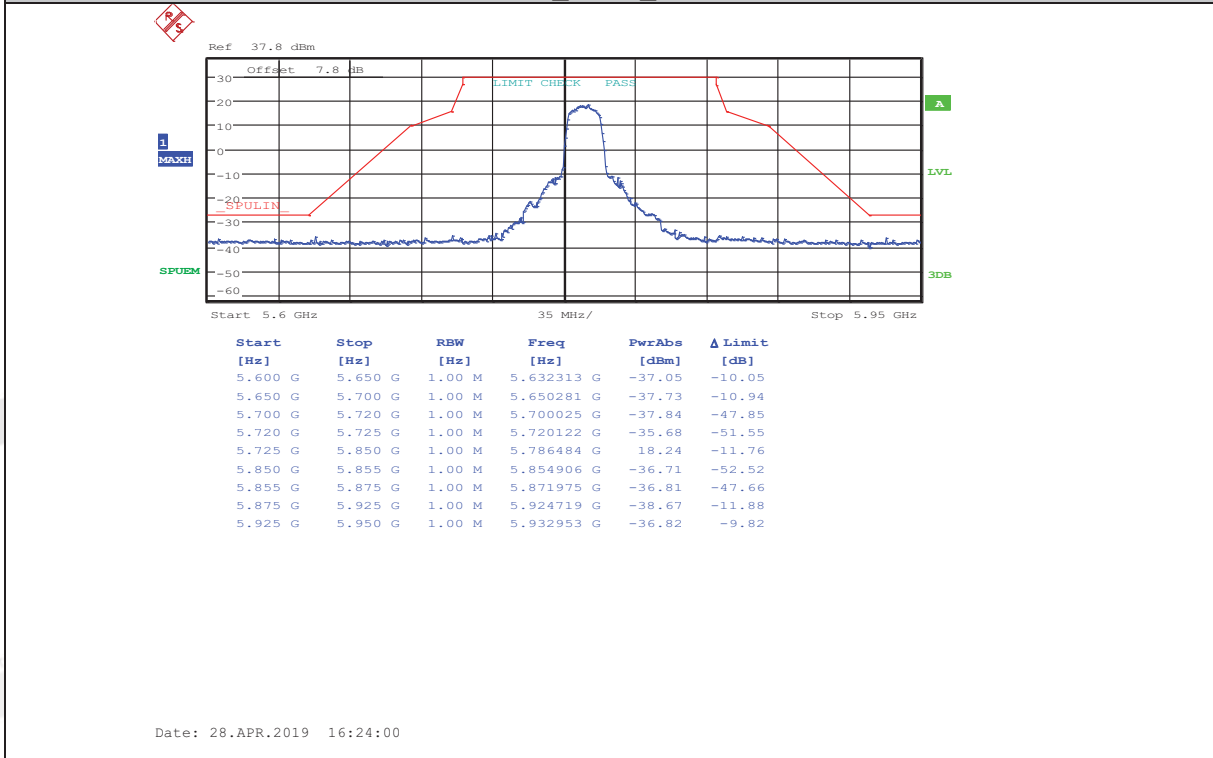

11A_ANT1_5825

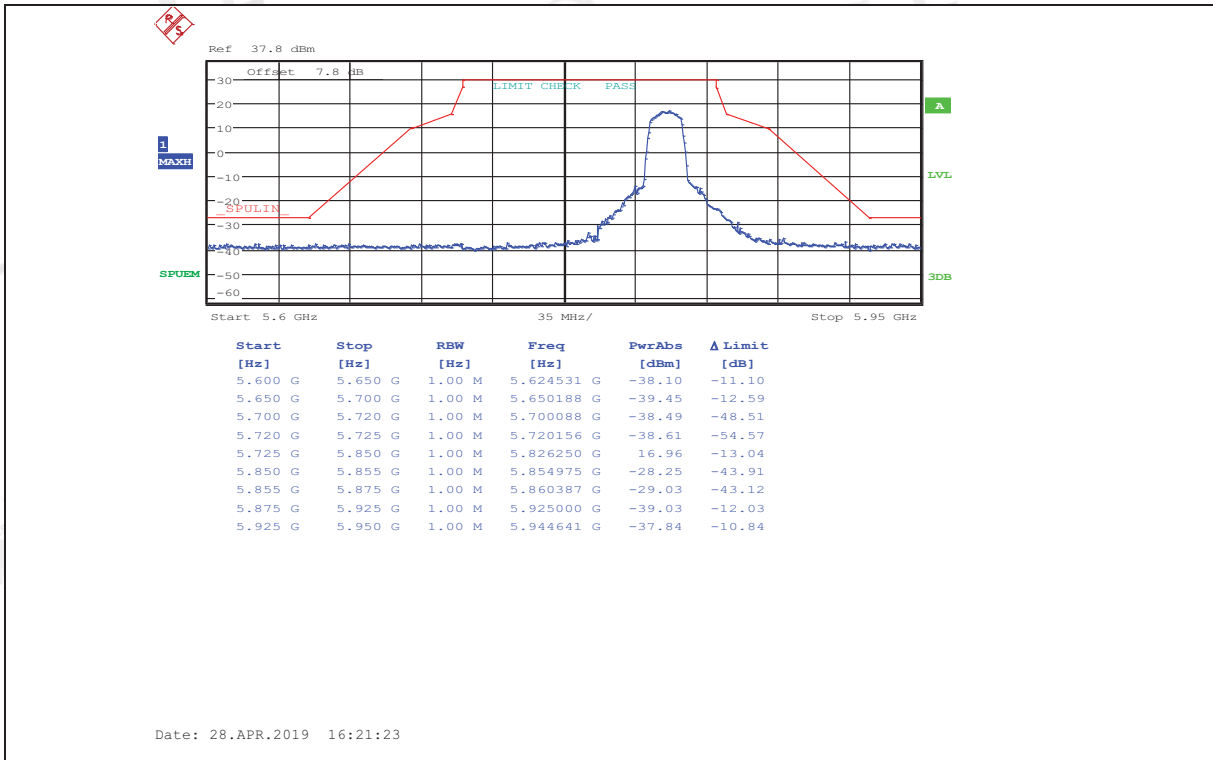

11A_ANT2_5825

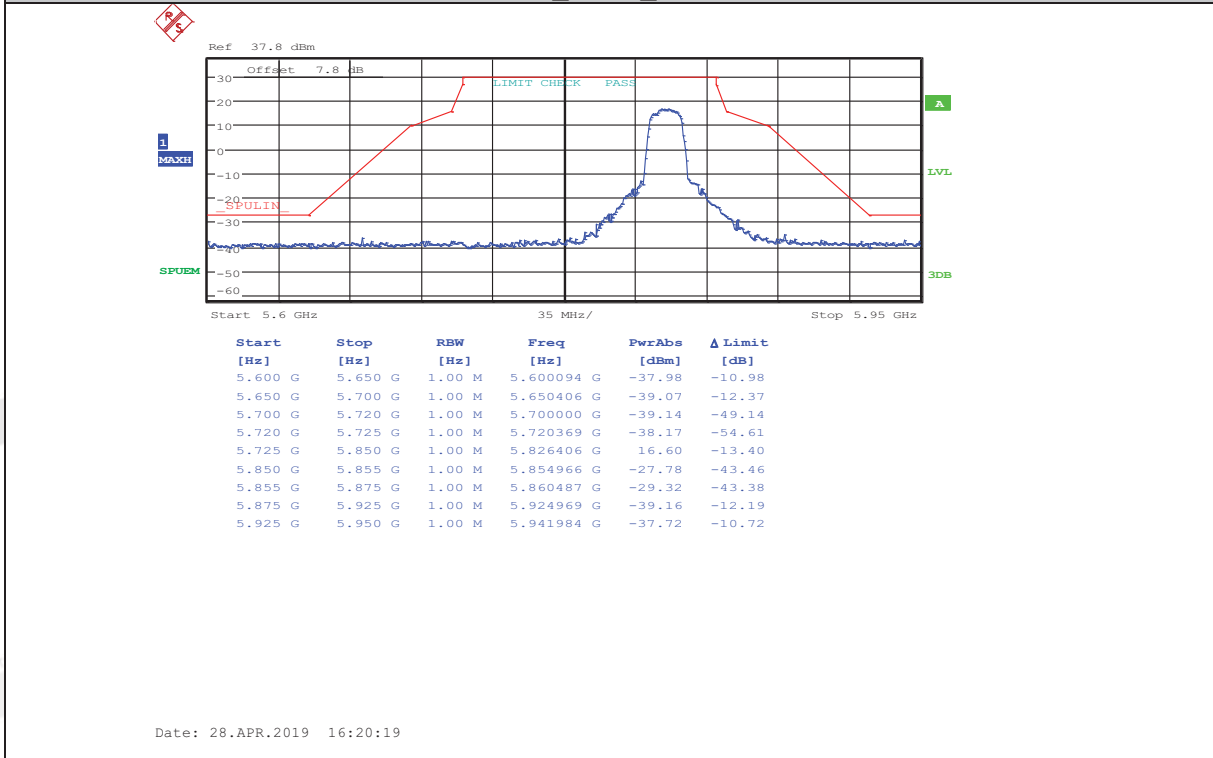

11N20_ANT1_5745

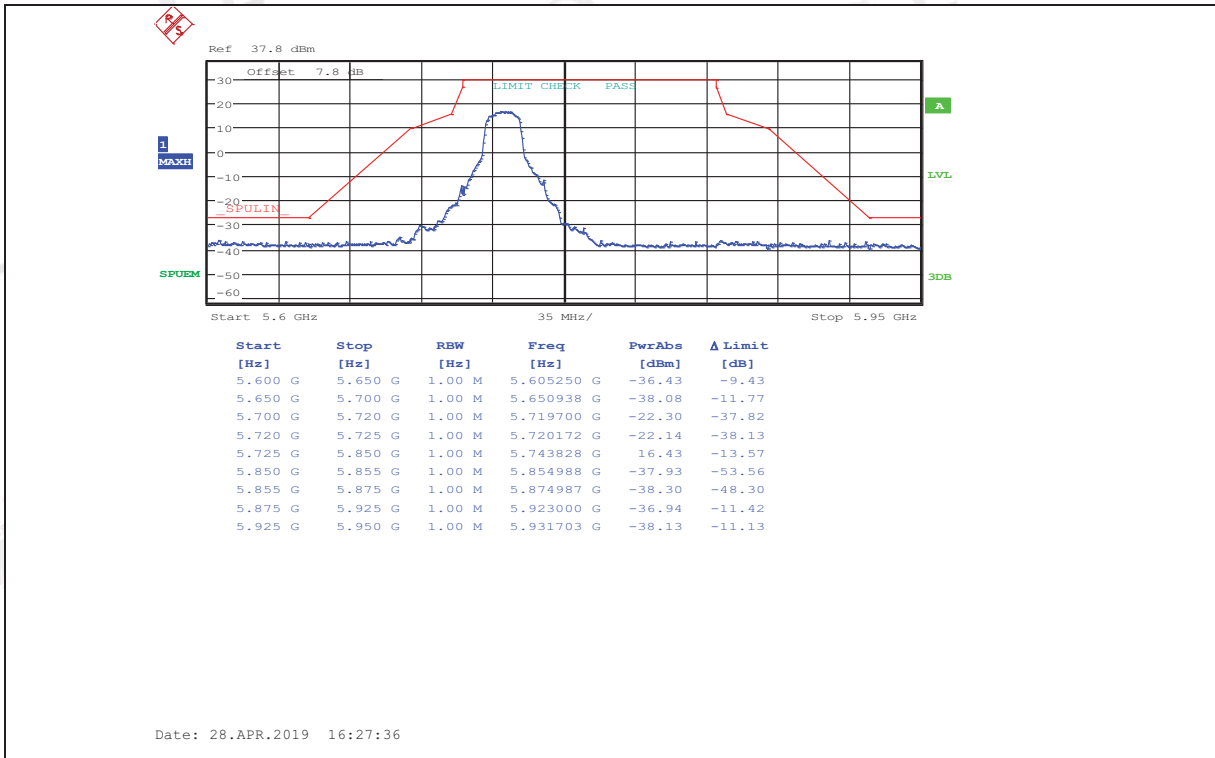

11N20_ANT2_5745

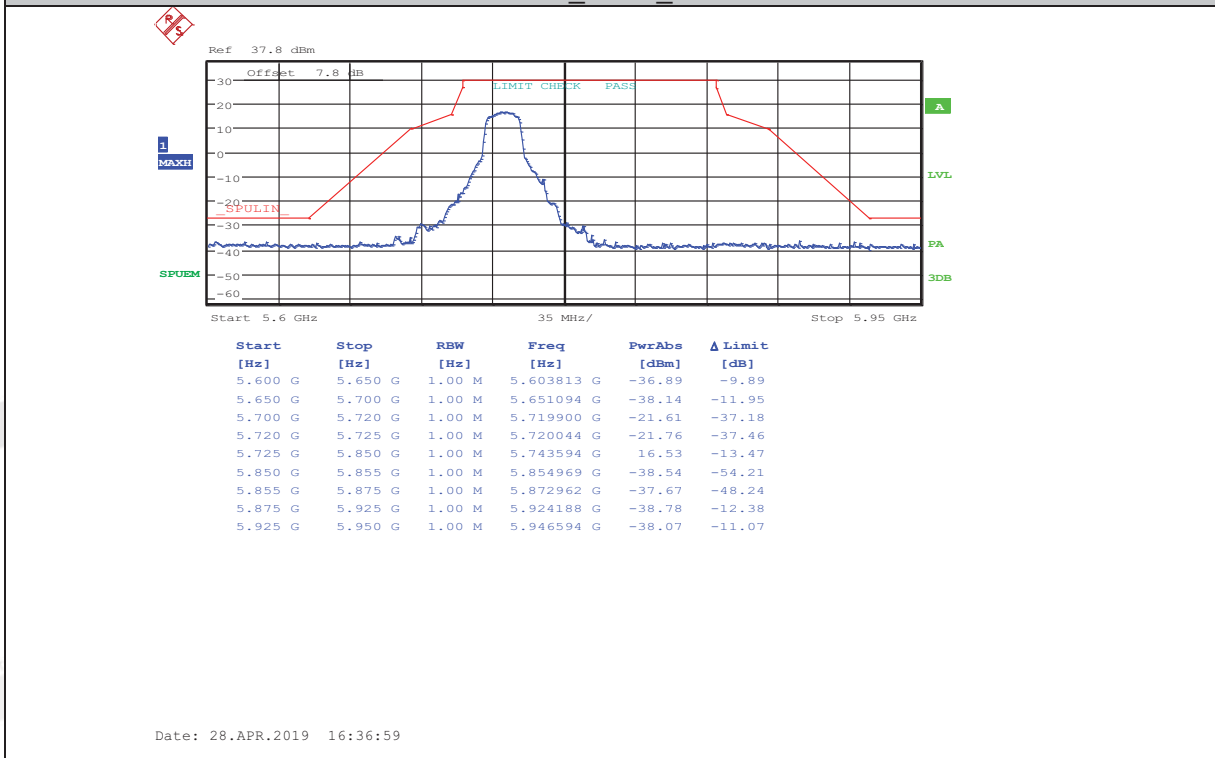

11N20_ANT1_5785

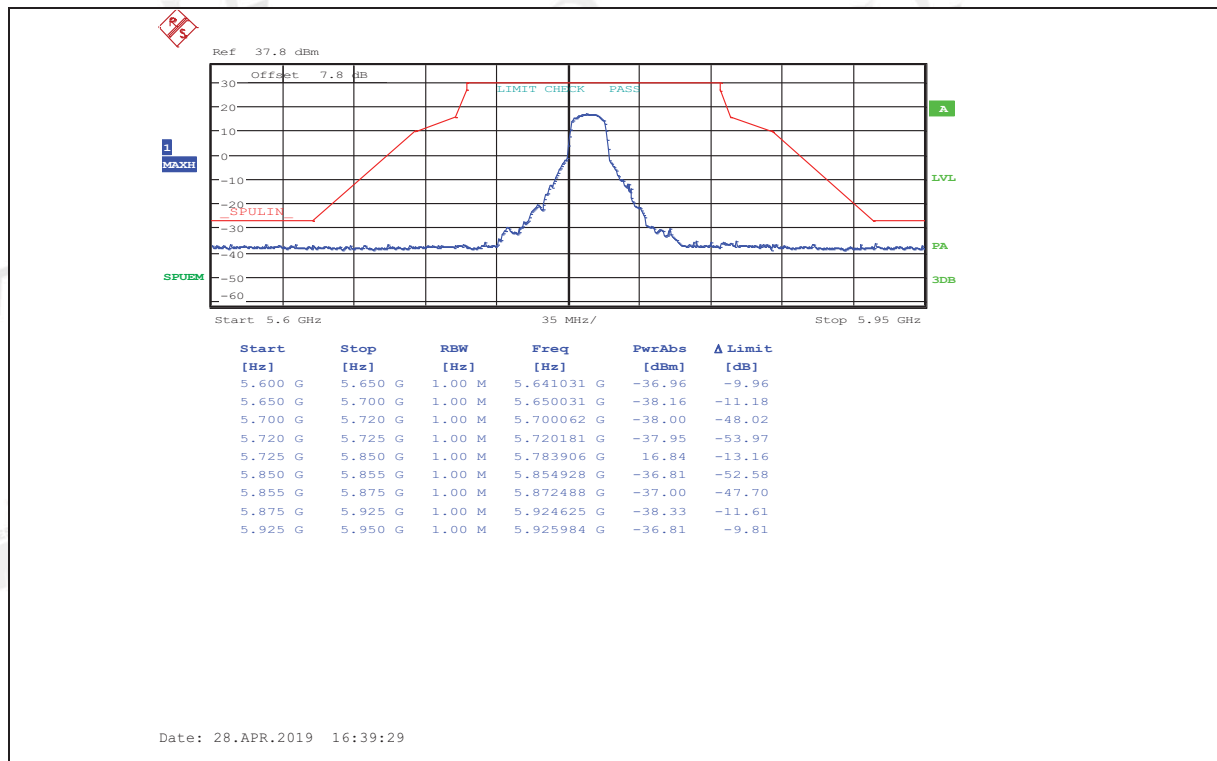

11N20_ANT2_5785

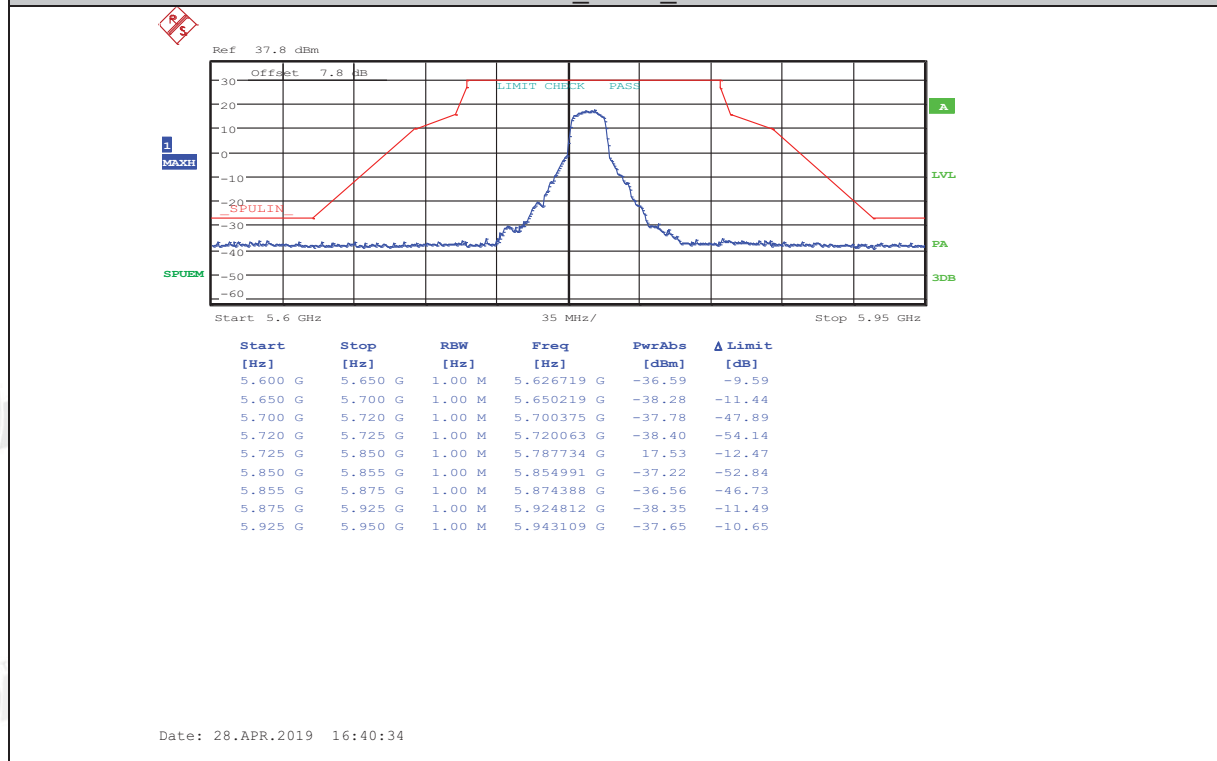

11N20_ANT1_5825

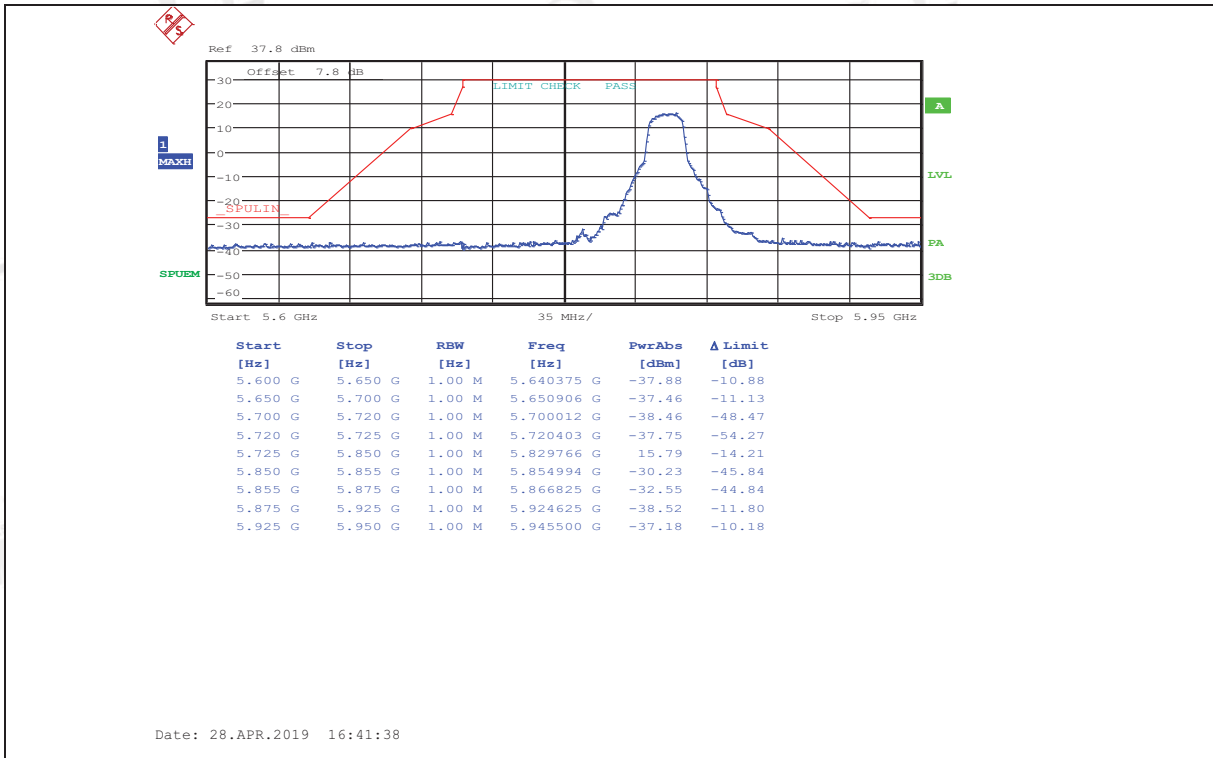

11N20_ANT1_5825

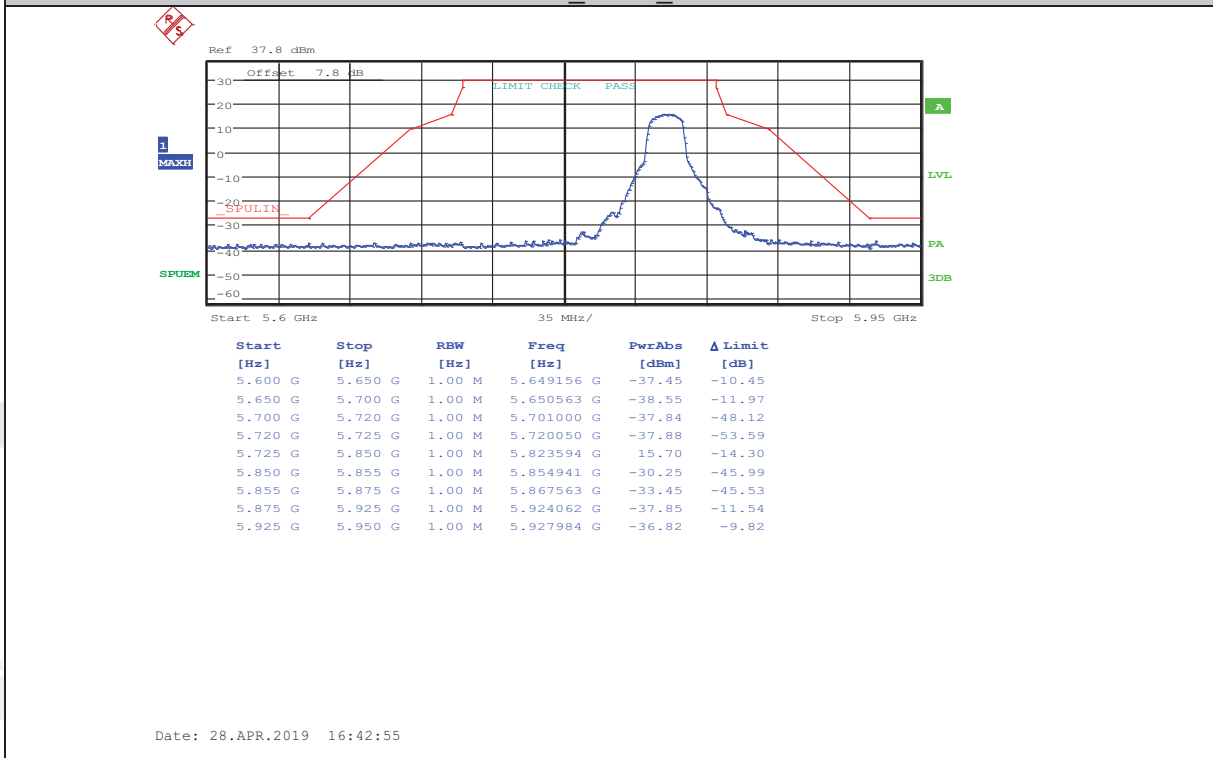

11N40_ANT1_5755

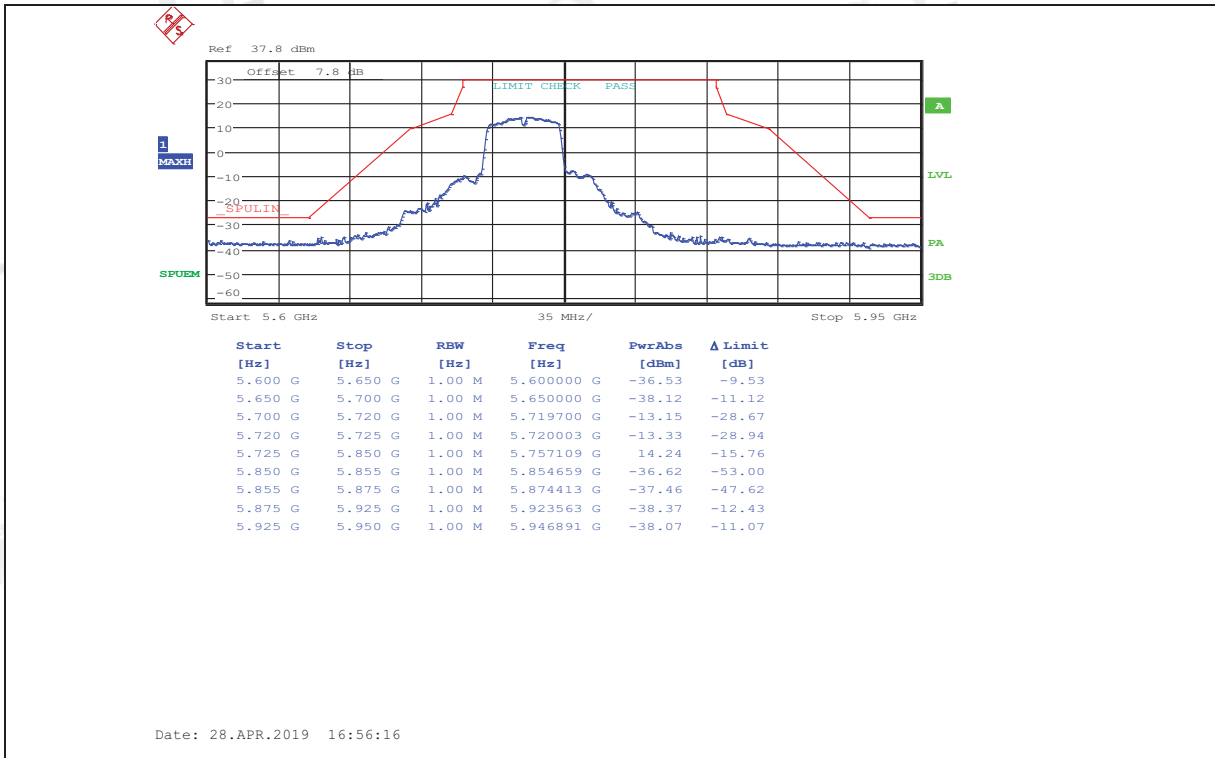

11N40_ANT2_5755

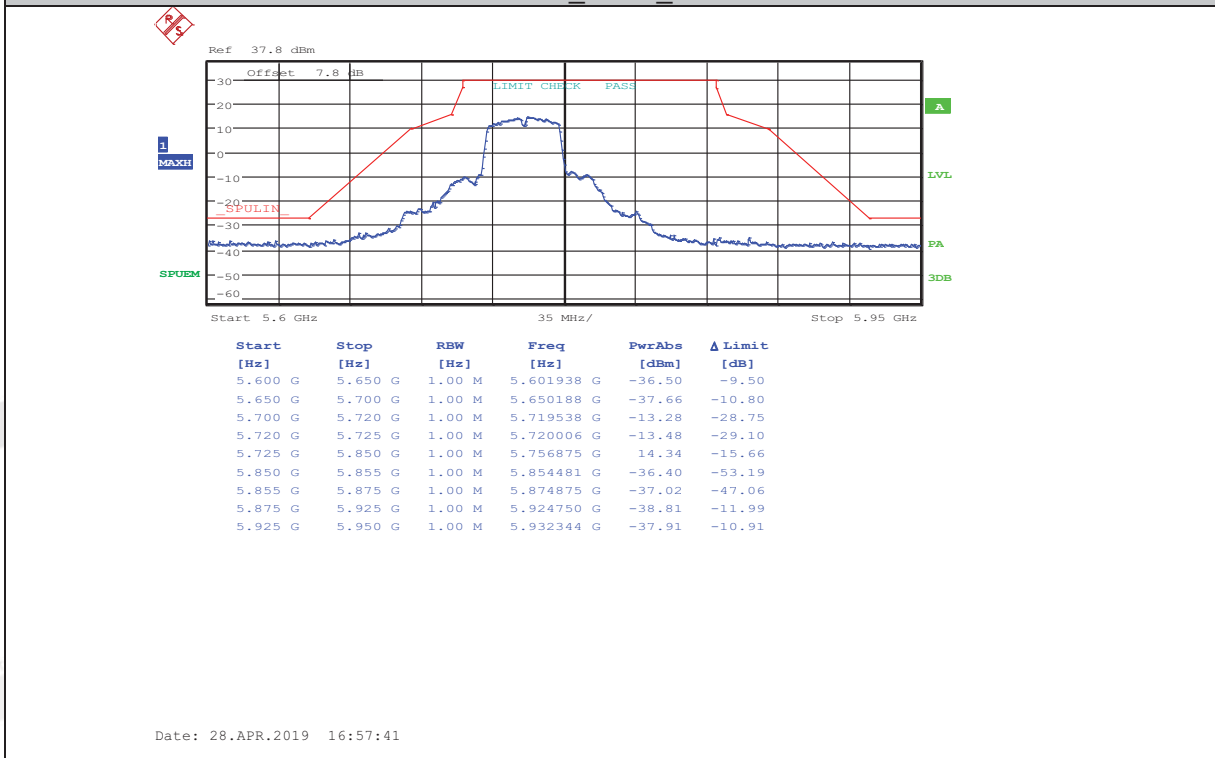

11N40_ANT1_5795

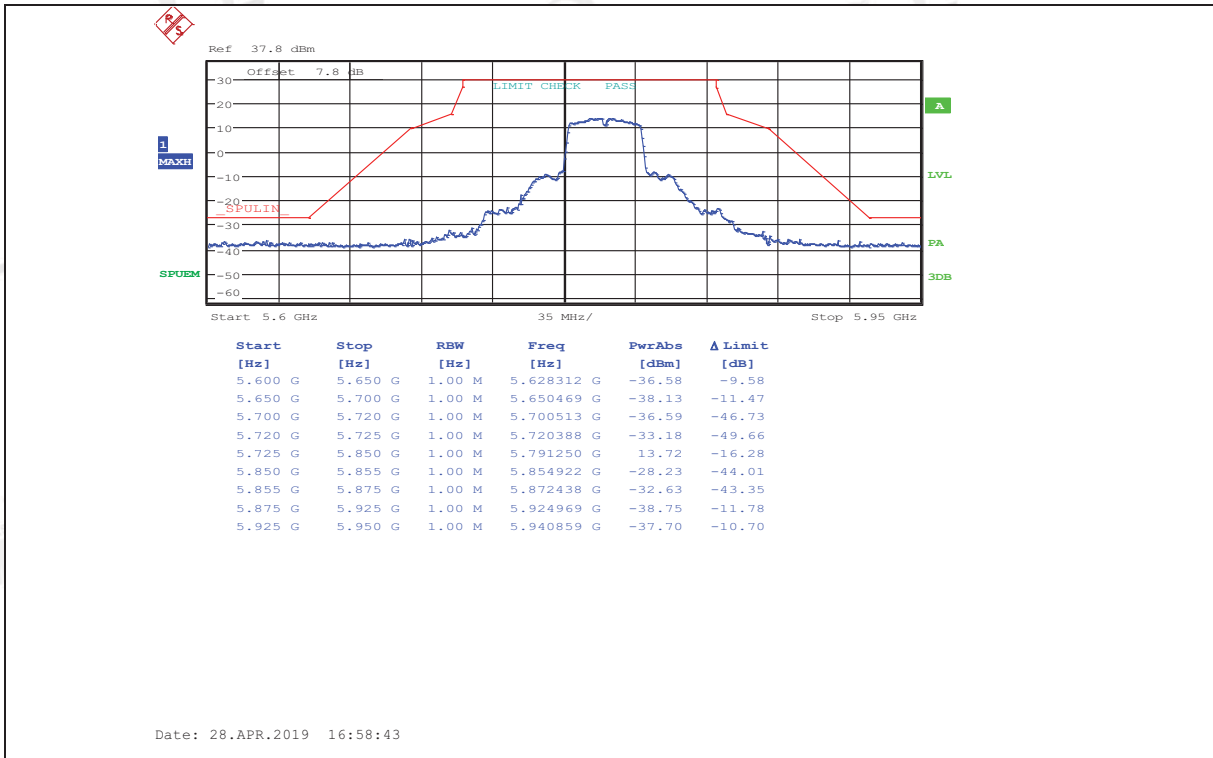

11N40_ANT2_5795

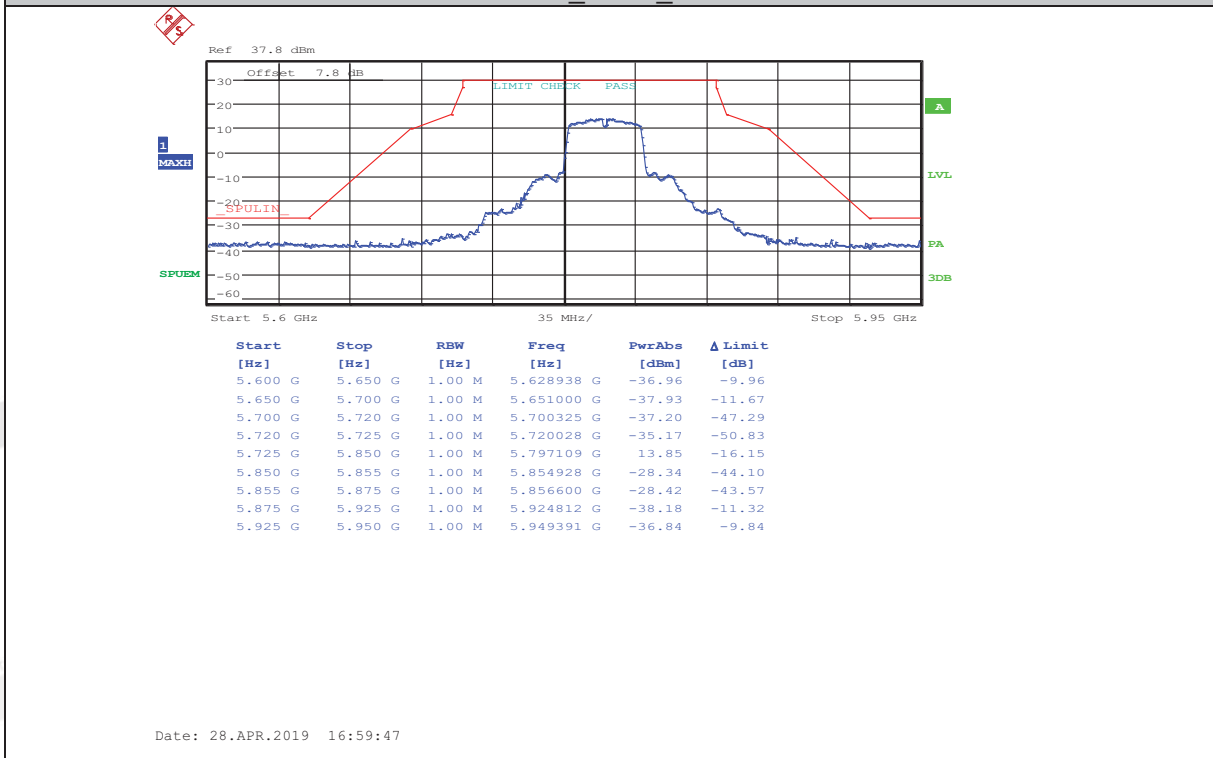

11AC20_ANT1_5745

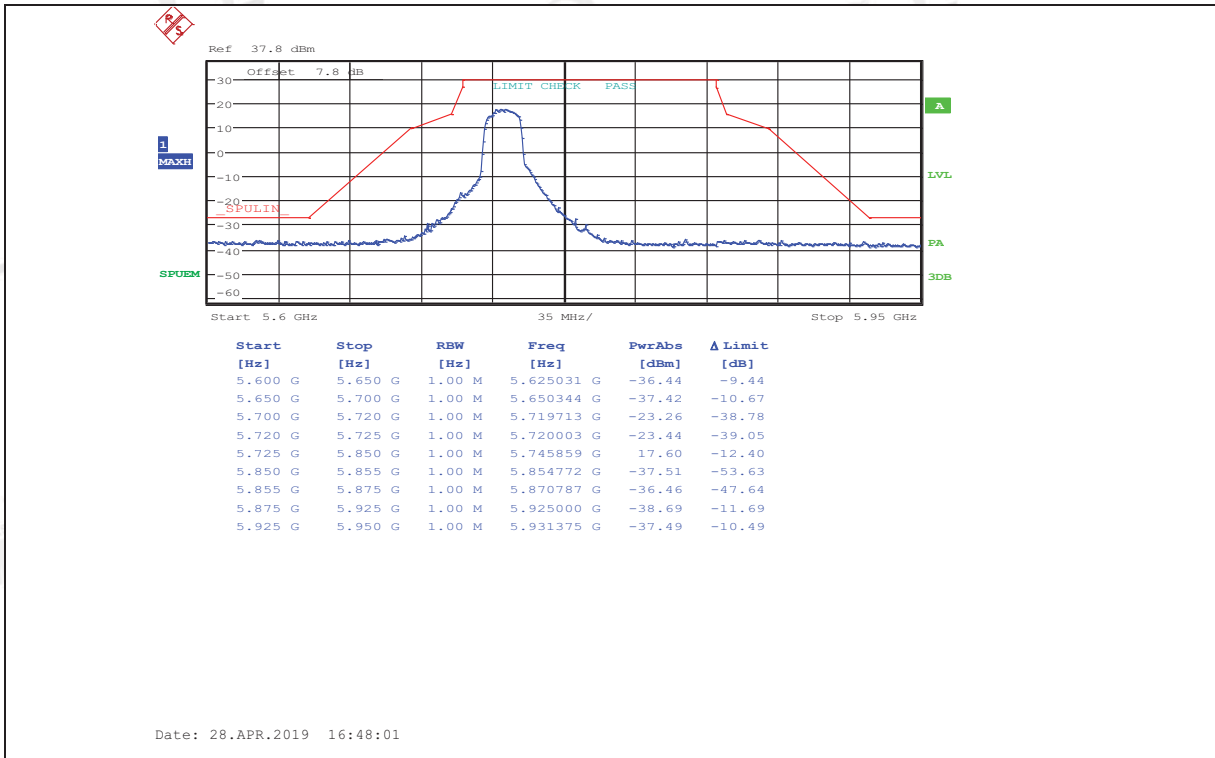

11AC20_ANT2_5745

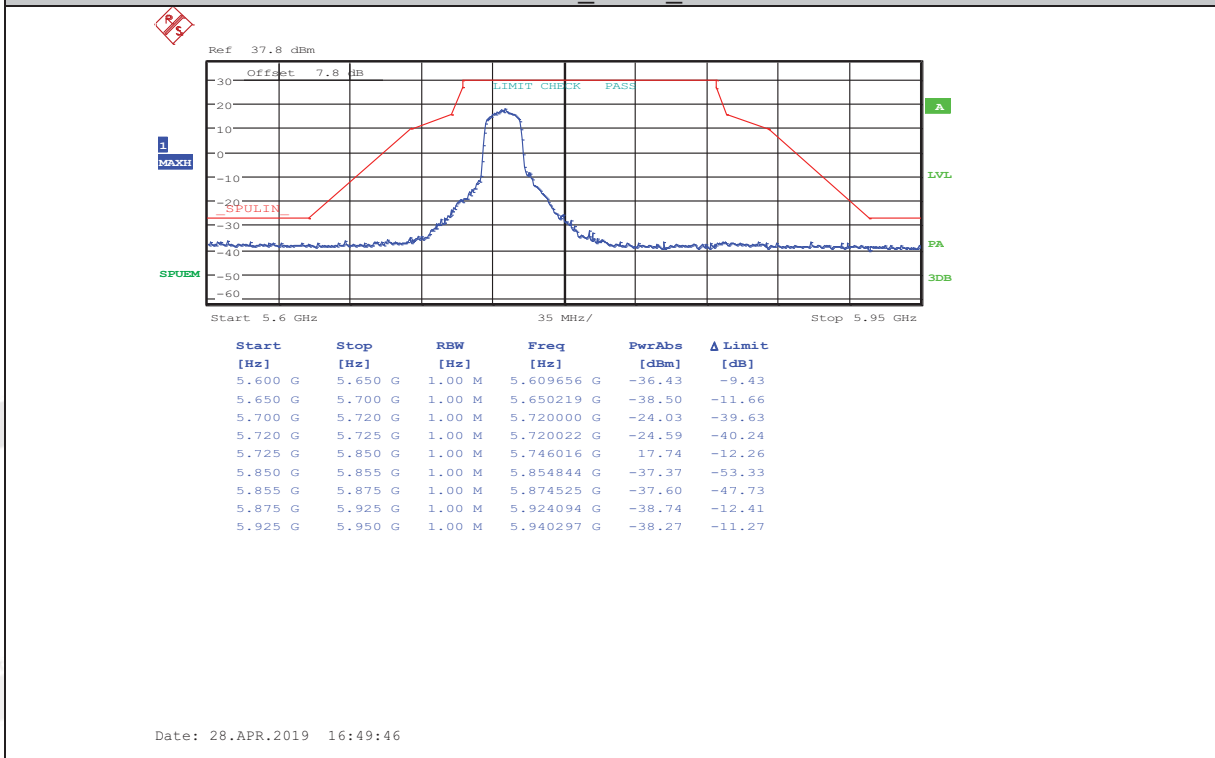

11AC20_ANT1_5785

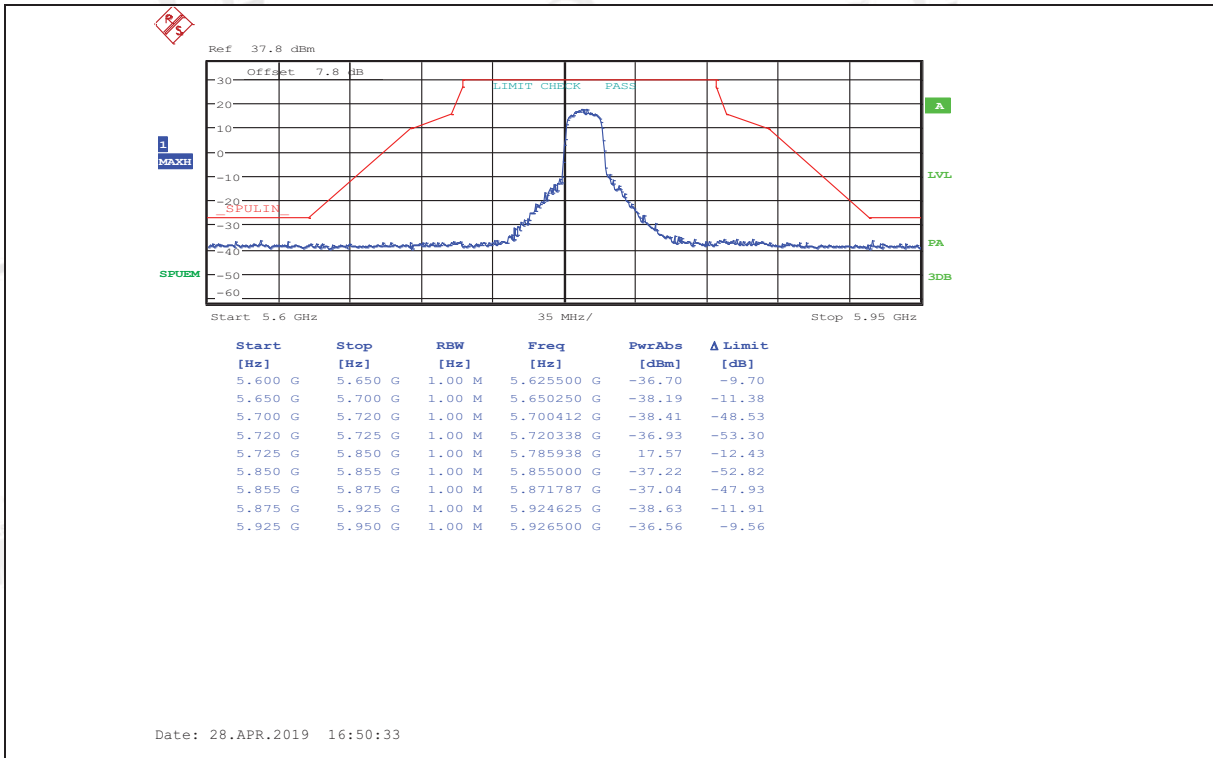

11AC20_ANT2_5785

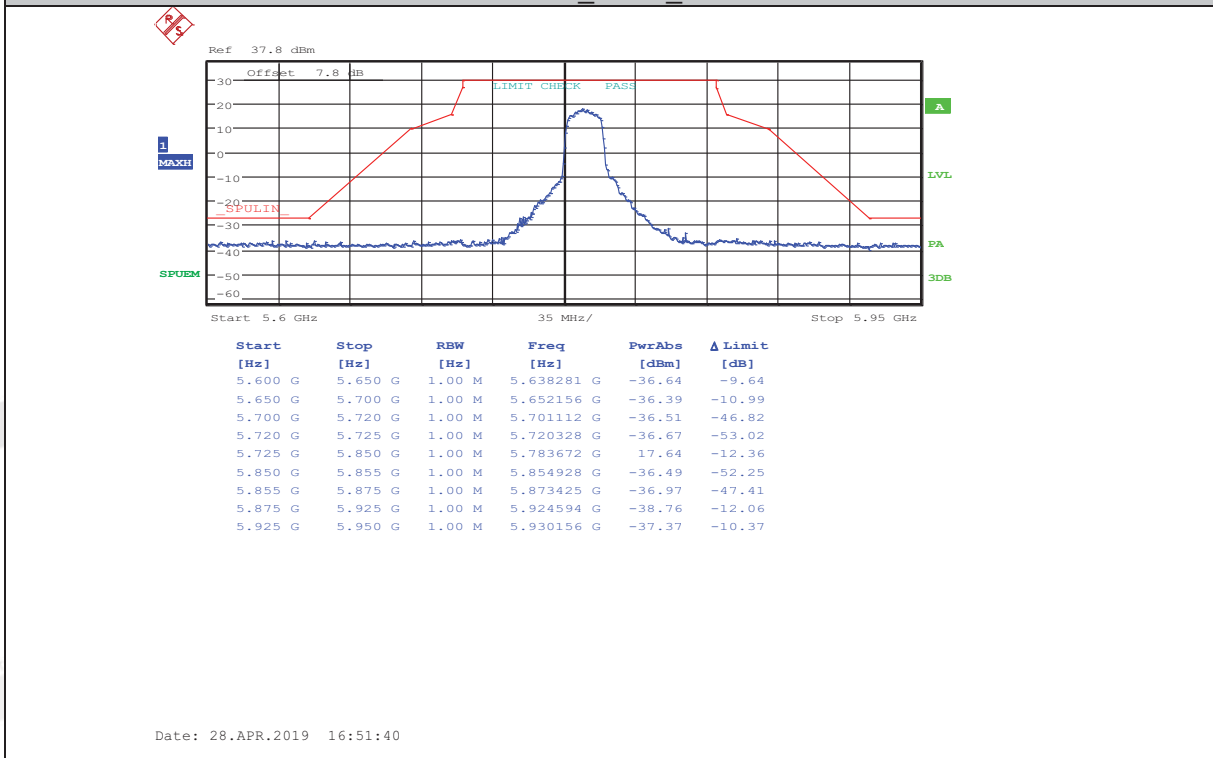

11AC20_ANT1_5825

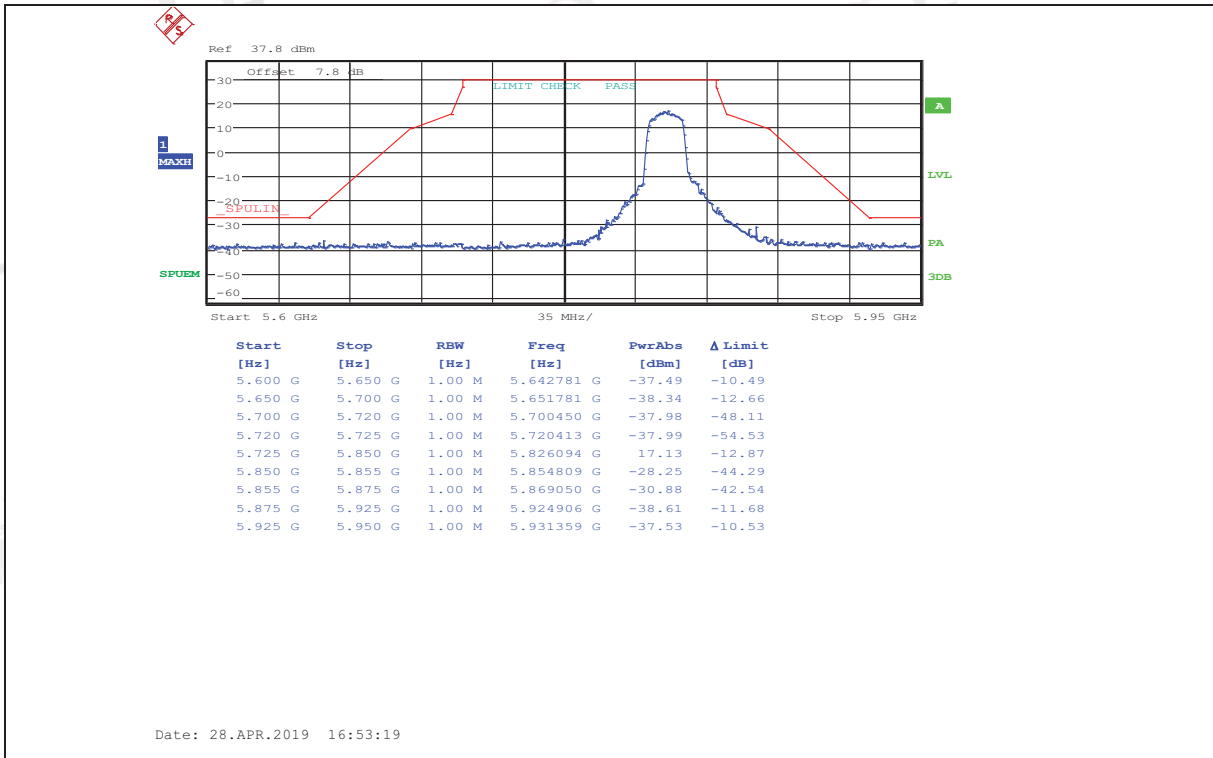

11AC20_ANT2_5825

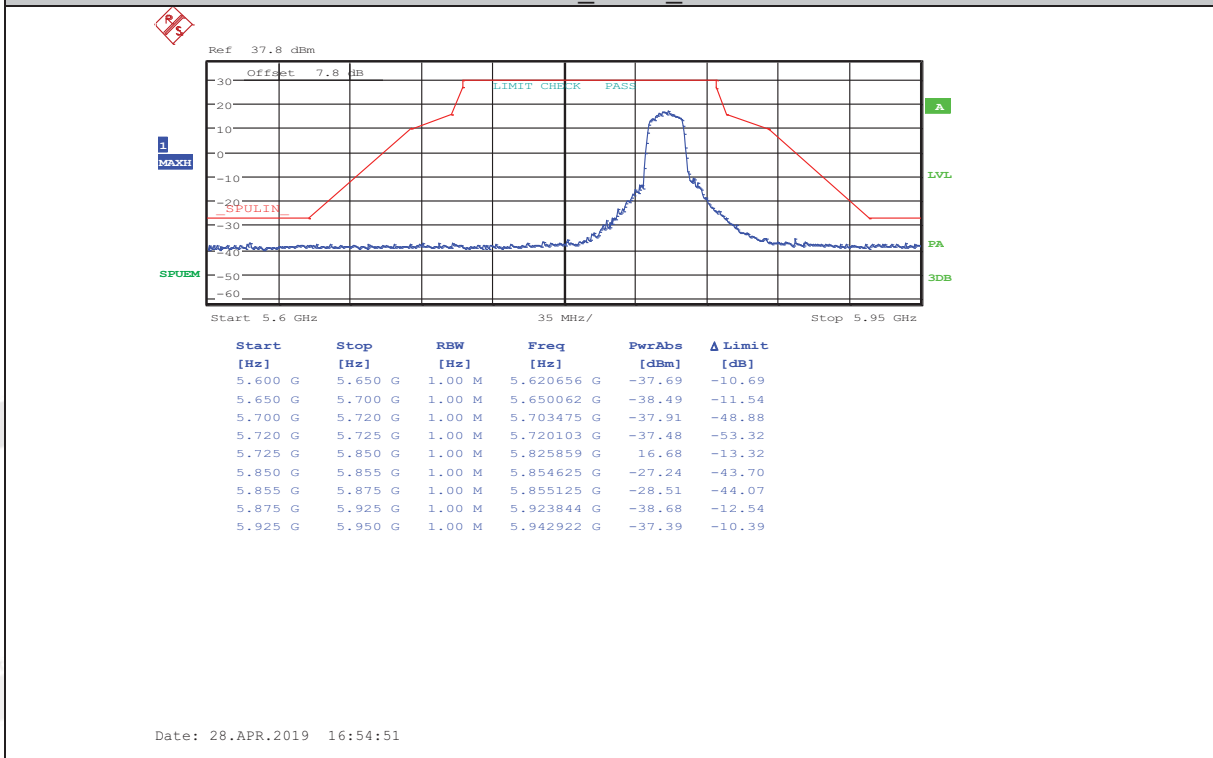

11AC40_ANT1_5755

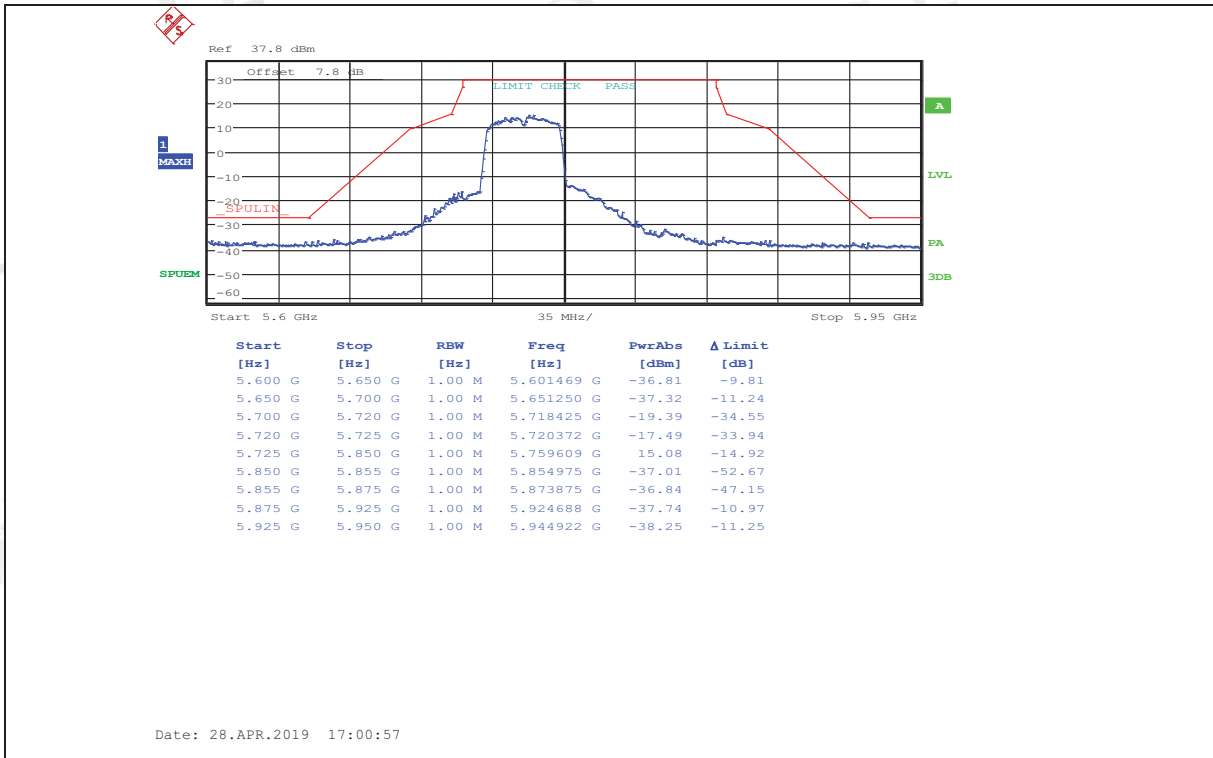

11AC40_ANT2_5755

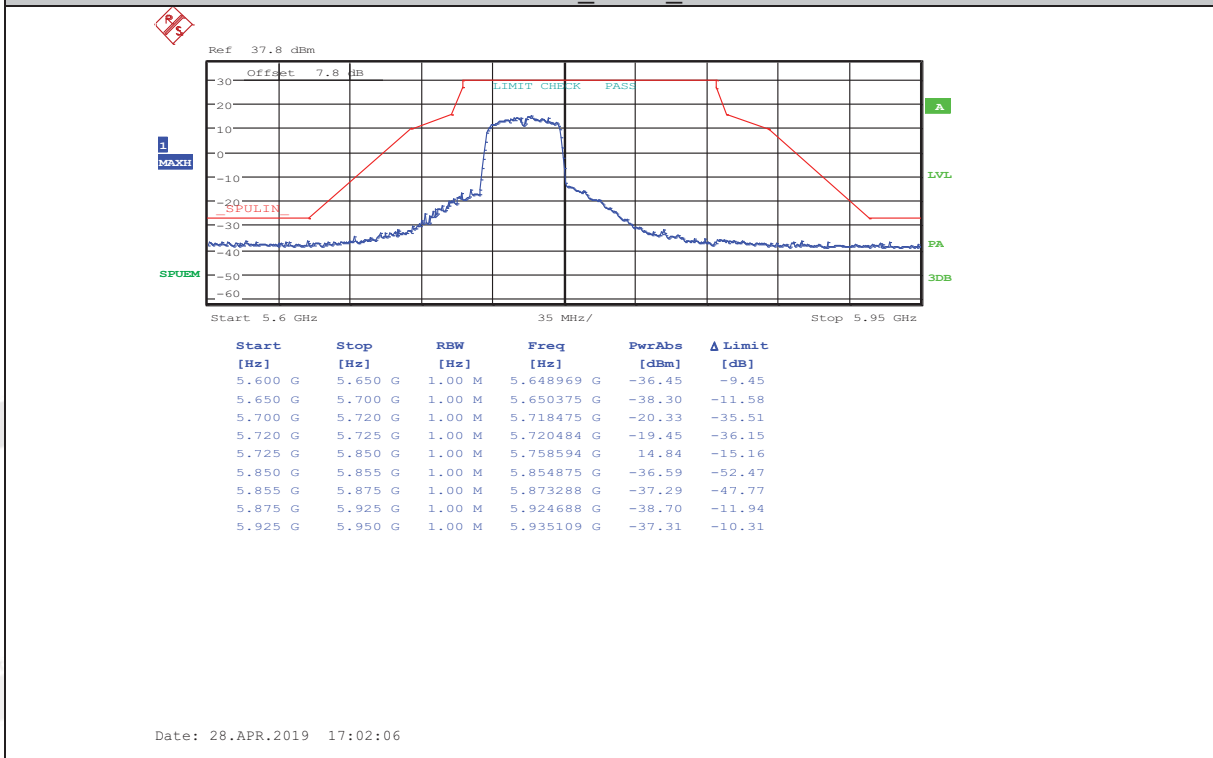

11AC40_ANT1_5795

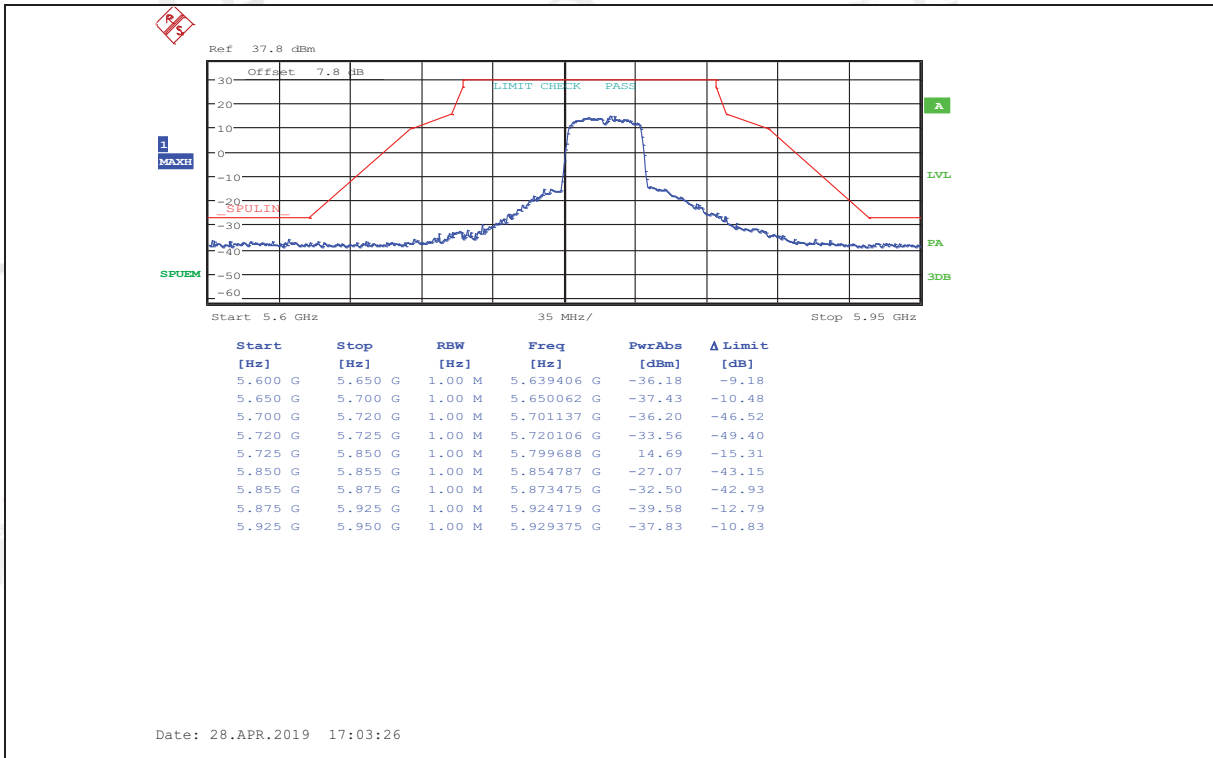

11AC40_ANT2_5795

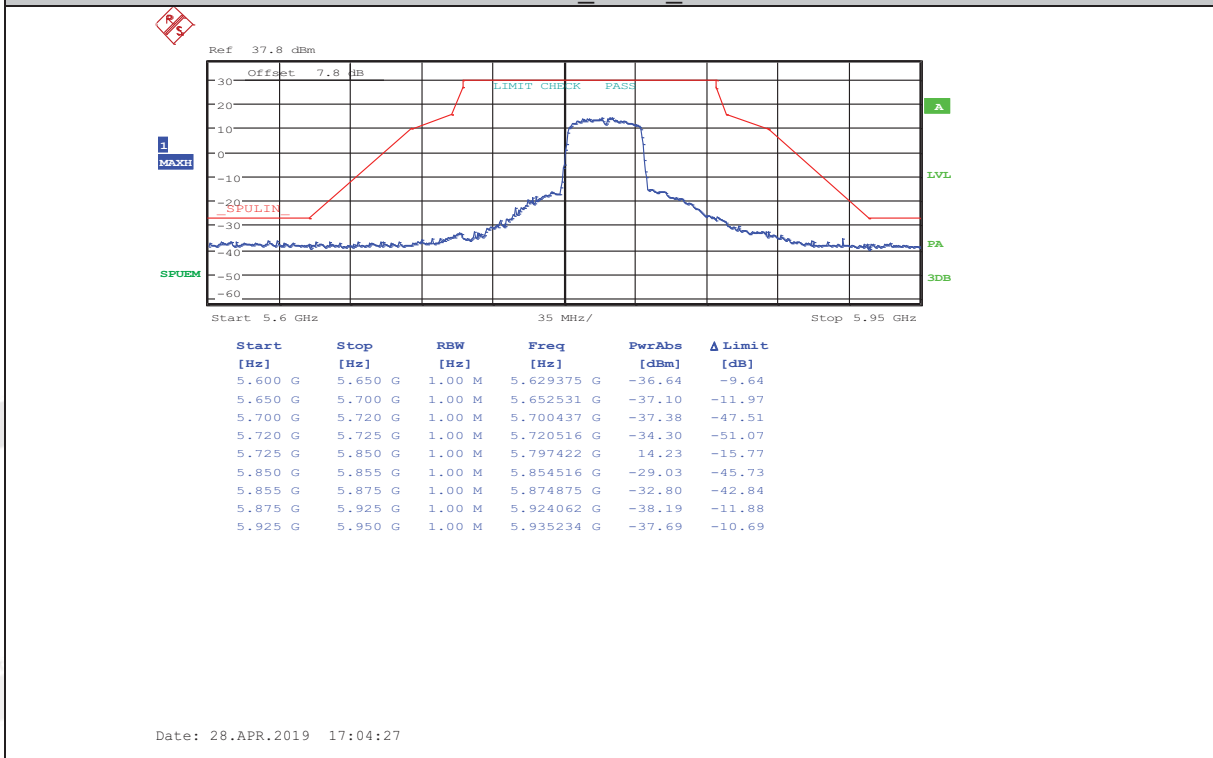

11AC80_ANT1_5775

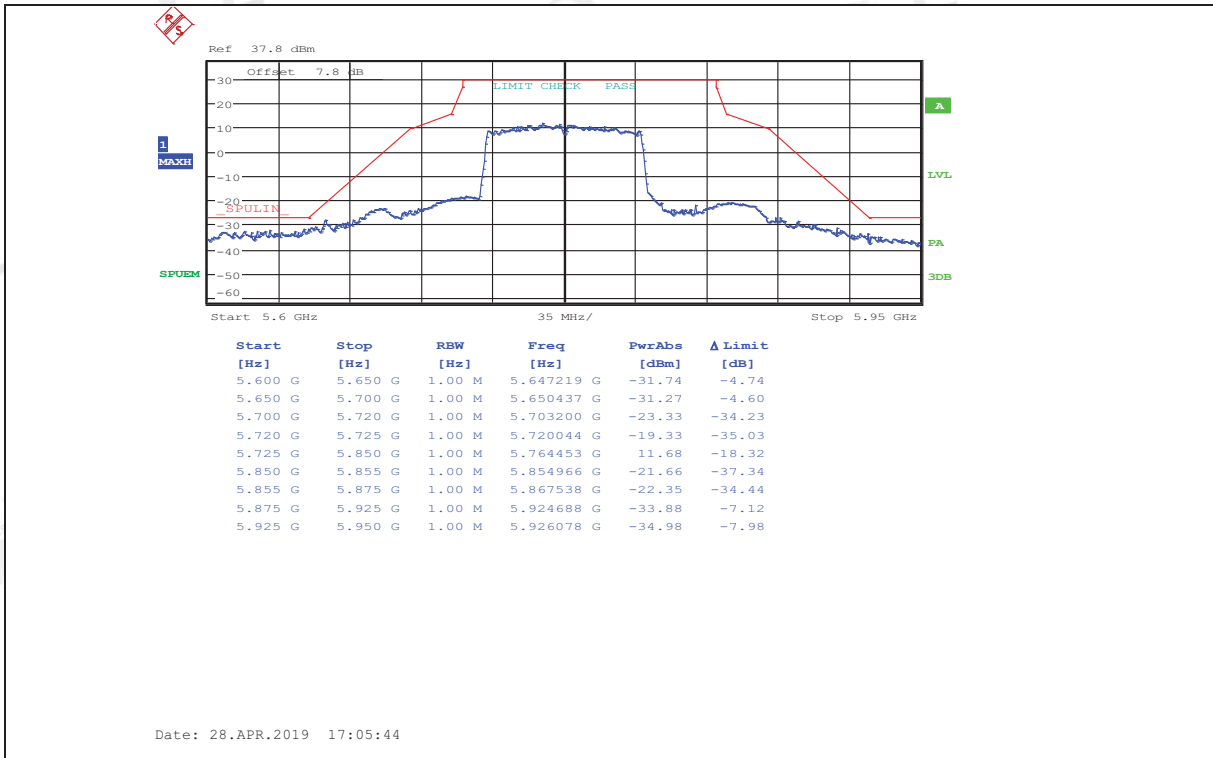

11AC80_ANT2_5775

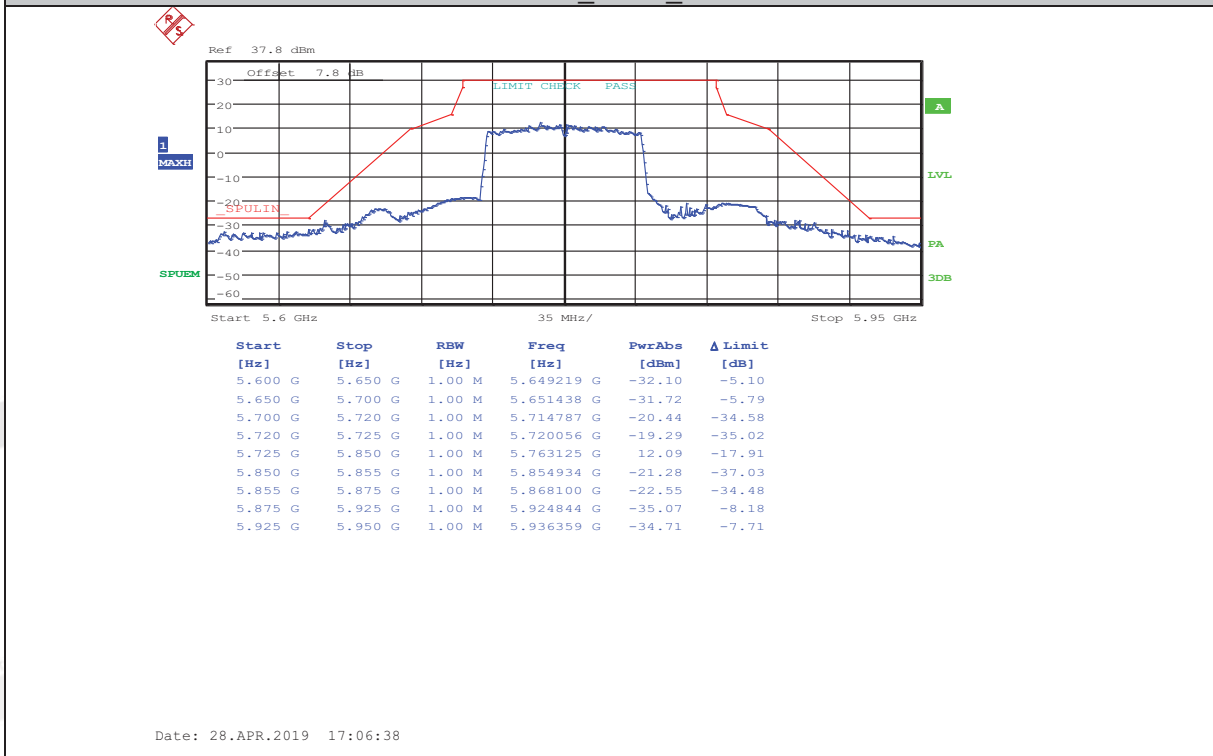

10. Power Line Conducted Emission

10.1. Block diagram of test setup

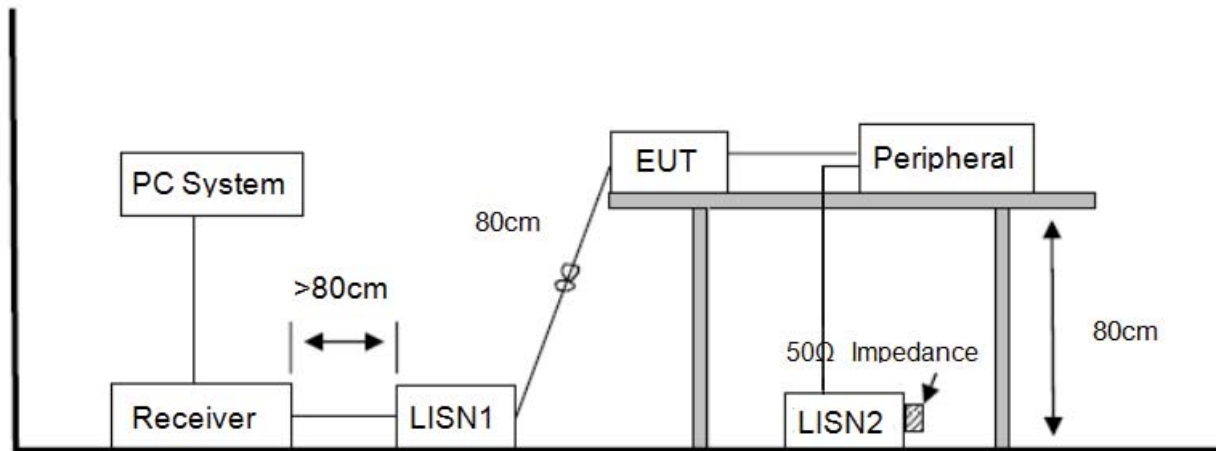

10.2. Power Line Conducted Emission Limits (Class B)

Frequency	Quasi-Peak Level dB(μ V)	Average Level dB(μ V)
150 kHz ~ 500 kHz	66 ~ 56*	56 ~ 46*
500 kHz ~ 5 MHz	56	46
5 MHz ~ 30 MHz	60	50

Note 1: * Decreasing linearly with logarithm of frequency.

Note 2: The lower limit shall apply at the transition frequencies.

10.3. Test Procedure

The EUT and Support equipment, if needed, were put placed on a non-metallic table, 80cm above the ground plane.

Configuration EUT to simulate typical usage as described in clause 2.3 and test equipment as described in clause 10.2 of this report.

All I/O cables were positioned to simulate typical actual usage as per ANSI C63.4.

All support equipment power received from a second LISN.

Emissions were measured on each current carrying line of the EUT using an EMI Test Receiver connected to the LISN powering the EUT.

The Receiver scanned from 150 kHz to 30MHz for emissions in each of the test modes.

During the above scans, the emissions were maximized by cable manipulation.

The test mode(s) described in clause 2.3 were scanned during the preliminary test.

After the preliminary scan, we found the test mode producing the highest emission level.

The EUT configuration and worst cable configuration of the above highest emission levels were recorded for reference of the final test.

EUT and support equipment were set up on the test bench as per the configuration with highest emission level in the preliminary test.

A scan was taken on both power lines, Neutral and Line, recording at least the six highest emissions.

Emission frequency and amplitude were recorded into a computer in which correction factors were used to calculate the emission level and compare reading to the applicable limit.

The test data of the worst-case condition(s) was recorded.

The bandwidth of test receiver is set at 9 kHz.

10.4. Test Result

PASS. (See below detailed test result)

Note1: All emissions not reported below are too low against the prescribed limits.

Note2: "----" means peak detection; "----" means average detection

Note3: Pre-test AC conducted emission at both voltage AC 120V/60Hz and AC 240V/60Hz, recorded worse case (AC 240V/60Hz).

TR-4-E-010 Conducted Emission Test Result

Test Site : DDT 1# Shield Room D:\2019 CE report data\Q19032116-1E\RE.EM6
Test Date : 2019-04-25 **Tested By** : Alan
EUT : WIRELESS SPEAKER **Model Number** : LINK MUSIC
Power Supply : AC 240V/60Hz **Test Mode** : Tx mode
Condition : Temp:24.5°C, Humi:55%, Press:100.1KPa **LISN** : 2018 ENV216/NEUTRAL
Memo :

Data: 46

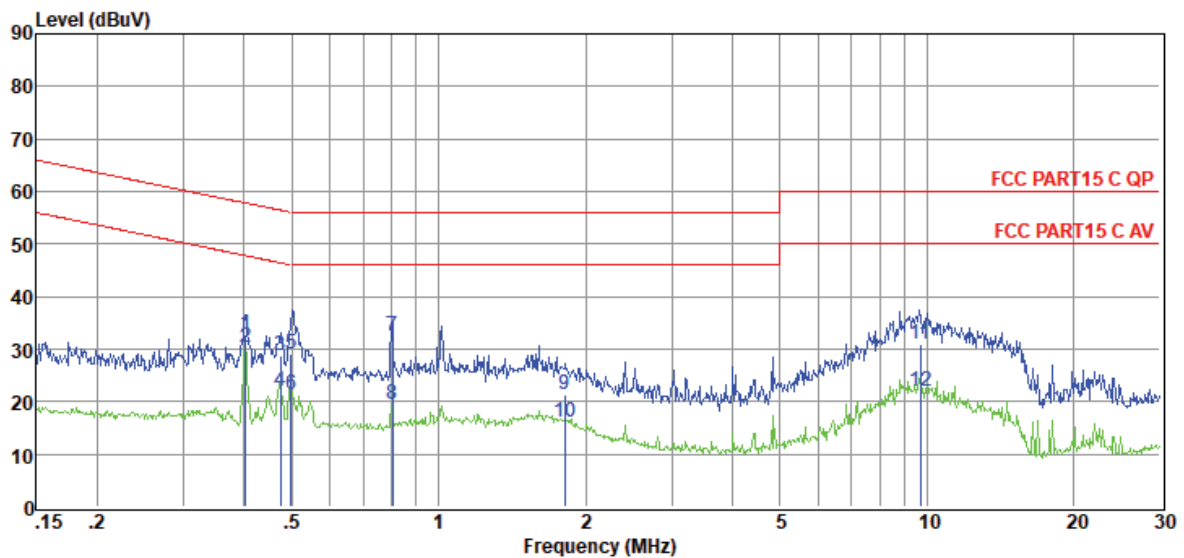

Item (Mark)	Freq. (MHz)	Read Level (dBμV)	LISN Factor (dB)	Cable Loss (dB)	Pulse Limiter Factor (dB)	Result Level (dBμV)	Limit Line (dBμV)	Over Limit (dB)	Detector	Phase
1	0.40	13.37	9.64	0.02	9.86	32.89	57.81	-24.92	QP	NEUTRAL
2	0.40	10.74	9.64	0.02	9.86	30.26	47.81	-17.55	Average	NEUTRAL
3	0.47	9.14	9.64	0.02	9.86	28.66	56.45	-27.79	QP	NEUTRAL
4	0.47	2.34	9.64	0.02	9.86	21.86	46.45	-24.59	Average	NEUTRAL
5	0.50	9.54	9.64	0.02	9.86	29.06	56.01	-26.95	QP	NEUTRAL
6	0.50	1.84	9.64	0.02	9.86	21.36	46.01	-24.65	Average	NEUTRAL
7	0.80	13.04	9.64	0.05	9.86	32.59	56.00	-23.41	QP	NEUTRAL
8	0.80	0.03	9.64	0.05	9.86	19.58	46.00	-26.42	Average	NEUTRAL
9	1.81	1.67	9.67	0.06	9.87	21.27	56.00	-34.73	QP	NEUTRAL
10	1.81	-3.52	9.67	0.06	9.87	16.08	46.00	-29.92	Average	NEUTRAL
11	9.71	11.10	9.80	0.11	9.90	30.91	60.00	-29.09	QP	NEUTRAL
12	9.71	2.03	9.80	0.11	9.90	21.84	50.00	-28.16	Average	NEUTRAL

- Note: 1. Result Level = Read Level + LISN Factor + Pulse Limiter Factor + Cable loss.
 2. If QP Result complies with AV limit, AV Result is deemed to comply with AV limit.
 3. Test setup: RBW: 200 Hz (9 kHz—150 kHz), 9 kHz (150 kHz—30 MHz).
 4. Step size: 80Hz (0.009MHz-0.15MHz), 4 kHz (0.15MHz-30MHz), Scan time: auto.

TR-4-E-010 Conducted Emission Test Result

Test Site : DDT 1# Shield Room D:\2019 CE report data\Q19032116-1E\RE.EM6
Test Date : 2019-04-25 **Tested By** : Alan
EUT : WIRELESS SPEAKER **Model Number** : LINK MUSIC
Power Supply : AC 240V/60Hz **Test Mode** : Tx mode
Condition : Temp:24.5°C, Humi:55%, Press:100.1KPa **LISN** : 2018 ENV216/LINE
Memo :

Data: 48

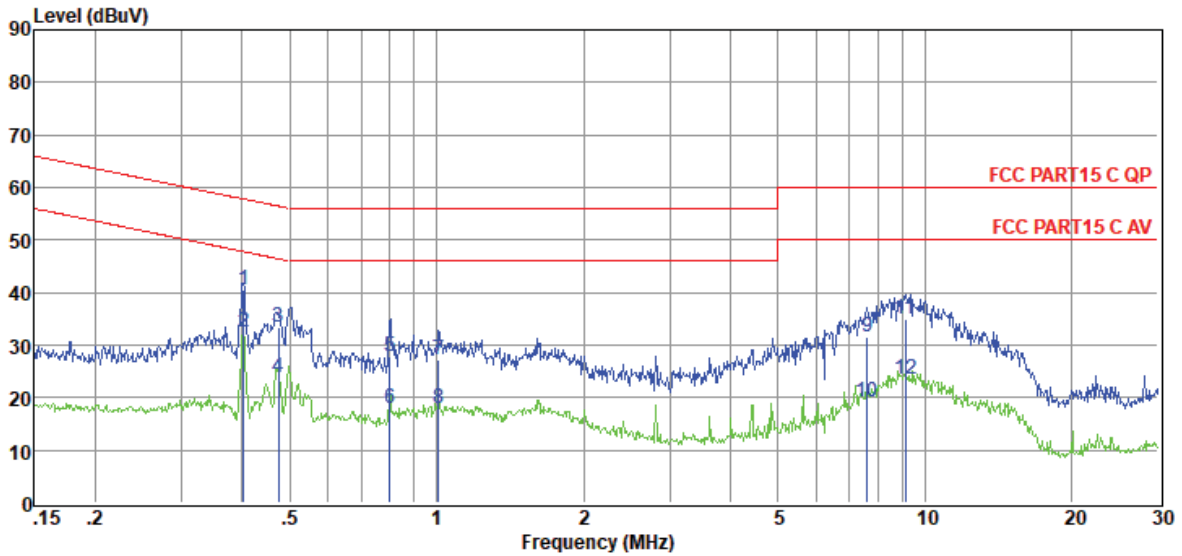

Item (Mark)	Freq. (MHz)	Read Level (dBμV)	LISN Factor (dB)	Cable Loss (dB)	Pulse Limiter Factor (dB)	Result Level (dBμV)	Limit Line (dBμV)	Over Limit (dB)	Detector	Phase
1	0.40	20.91	9.64	0.02	9.86	40.43	57.81	-17.38	QP	LINE
2	0.40	12.82	9.64	0.02	9.86	32.34	47.81	-15.47	Average	LINE
3	0.47	13.83	9.64	0.02	9.86	33.35	56.45	-23.10	QP	LINE
4	0.47	4.16	9.64	0.02	9.86	23.68	46.45	-22.77	Average	LINE
5	0.80	8.36	9.64	0.05	9.86	27.91	56.00	-28.09	QP	LINE
6	0.80	-1.58	9.64	0.05	9.86	17.97	46.00	-28.03	Average	LINE
7	1.01	7.50	9.64	0.10	9.87	27.11	56.00	-28.89	QP	LINE
8	1.01	-1.67	9.64	0.10	9.87	17.94	46.00	-28.06	Average	LINE
9	7.61	11.75	9.73	0.03	9.89	31.40	60.00	-28.60	QP	LINE
10	7.61	-0.44	9.73	0.03	9.89	19.21	50.00	-30.79	Average	LINE
11	9.11	15.11	9.76	0.08	9.90	34.85	60.00	-25.15	QP	LINE
12	9.11	3.77	9.76	0.08	9.90	23.51	50.00	-26.49	Average	LINE

- Note: 1. Result Level = Read Level + LISN Factor + Pulse Limiter Factor + Cable loss.
 2. If QP Result complies with AV limit, AV Result is deemed to comply with AV limit.
 3. Test setup: RBW: 200 Hz (9 kHz—150 kHz), 9 kHz (150 kHz—30 MHz).
 4. Step size: 80Hz (0.009MHz-0.15MHz), 4 kHz (0.15MHz-30MHz), Scan time: auto.

11. Antenna Requirements

11.1. Limit

For intentional device, according to FCC 47 CFR Section 15.203, an intentional radiator shall be designed to ensure that no antenna other than that furnished by the responsible party shall be used with the device. And according to FCC 47 CFR Section 15.247 (b), if transmitting antennas of directional gain greater than 6dBi are used, the power shall be reduced by the amount in dB that the directional gain of the antenna exceeds 6dBi.

11.2. Result

The antennas used for this product are integrated antenna and other than that furnished by the responsible party shall be used with the device, the maximum peak gain of the transmit antenna is 3.82 dBi.

12. Dynamic Frequency Selection

12.1. Applicability of DFS requirements

Table 1: Applicability of DFS Requirements Prior to Use of a Channel

Requirement	Operational Mode		
	<input type="checkbox"/> Master	<input checked="" type="checkbox"/> Client Without Radar Detection	<input type="checkbox"/> Client with Radar Detection
Non-Occupancy Period	Yes	Not required	Yes
DFS Detection Threshold	Yes	Not required	Yes
Channel Availability Check Time	Yes	Not required	Not required
U-NII Detection Bandwidth	Yes	Not required	Yes

Table 2: Applicability of DFS requirements during normal operation

Requirement	Operational Mode	
	<input type="checkbox"/> Master Device or Client with Radar Detection	<input checked="" type="checkbox"/> Client Without Radar Detection
DFS Detection Threshold	Yes	Not required
Channel Closing Transmission Time	Yes	Yes
Channel Move Time	Yes	Yes
U-NII Detection Bandwidth	Yes	Not required

Additional requirements for devices with multiple bandwidth modes	<input type="checkbox"/> Master Device or Client with Radar Detection	<input checked="" type="checkbox"/> Client Without Radar Detection
U-NII Detection Bandwidth and Statistical Performance Check	All BW modes must be tested	Not required
Channel Move Time and Channel Closing Transmission Time	Test using widest BW mode available	Test using the widest BW mode available for the link
All other tests	Any single BW mode	Not required

Note: Frequencies selected for statistical performance check should include several frequencies within the radar detection bandwidth and frequencies near the edge of the radar detection bandwidth. For 802.11 devices it is suggested to select frequencies in each of the bonded 20 MHz channels and the channel center frequency.

12.2. Limit

(1) DFS Detection Thresholds

Table 3: DFS Detection Thresholds for Master Devices and Client Devices with Radar Detection

Maximum Transmit Power	Value (See Notes 1, 2, and 3)
EIRP \geq 200 milliwatt	-64 dBm
EIRP < 200 milliwatt and power spectral density < 10 dBm/MHz	-62 dBm
EIRP < 200 milliwatt that do not meet the power spectral density requirement	-64 dBm

Note 1: This is the level at the input of the receiver assuming a 0 dBi receive antenna.

Note 2: Throughout these test procedures an additional 1 dB has been added to the amplitude of the test transmission waveforms to account for variations in measurement equipment. This will ensure that the test signal is at or above the detection threshold level to trigger a DFS response.

Note3: EIRP is based on the highest antenna gain. For MIMO devices refer to KDB Publication 662911 D01.

(2) DFS Response Requirements

Table 4: DFS Response Requirement Values

Parameter	Value
Non-occupancy period	Minimum 30 minutes
Channel Availability Check Time	60 seconds
Channel Move Time	10 seconds See Note 1.
Channel Closing Transmission Time	200 milliseconds + an aggregate of 60 milliseconds over remaining 10 second period. See Notes 1 and 2.
U-NII Detection Bandwidth	Minimum 100% of the U-NII 99% transmission power bandwidth. See Note 3.

Note 1: Channel Move Time and the Channel Closing Transmission Time should be performed with Radar Type 0. The measurement timing begins at the end of the Radar Type 0 burst.

Note 2: The Channel Closing Transmission Time is comprised of 200 milliseconds starting at the beginning of the Channel Move Time plus any additional intermittent control signals required facilitating a Channel move (an aggregate of 60 milliseconds) during the remainder of the 10 second period. The aggregate duration of control signals will not count quiet periods in between transmissions.

Note 3: During the U-NII Detection Bandwidth detection test, radar type 0 should be used. For each frequency step the minimum percentage of detection is 90 percent. Measurements are performed with no data traffic.

12.3. Parameters of radar test waveforms

This section provides the parameters for required test waveforms, minimum percentage of successful detections, and the minimum number of trials that must be used for determining DFS conformance. Step intervals of 0.1 microsecond for Pulse Width, 1 microsecond for PRI, 1 MHz for chirp width and 1 for the number of pulses will be utilized for the random determination of specific test waveforms.

Table 5 Short Pulse Radar Test Waveforms

Radar Type	Pulse Width (μsec)	PRI (μsec)	Number of Pulses	Minimum Percentage of Successful Detection	Minimum Number of Trials
0	1	1428	18	See Note 1	See Note 1
1	1	Test A	Roundup $\left\{ \left(\frac{1}{360} \right) \cdot \left(\frac{19 \cdot 10^6}{\text{PRI}_{\mu\text{sec}}} \right) \right\}$	60%	30
		Test B			
2	1-5	150-230	23-29	60%	30
3	6-10	200-500	16-18	60%	30
4	11-20	200-500	12-16	60%	30
Aggregate (Radar Types 1-4)				80%	120
Note 1: Short Pulse Radar Type 0 should be used for the detection bandwidth test, channel move time, and channel closing time tests.					
Test A: 15 unique PRI values randomly selected from the list of 23 PRI values in Table 5a					
Test B: 15 unique PRI values randomly selected within the range of 518-3066 μsec, with a minimum increment of 1 μsec, excluding PRI values selected in Test A					

A minimum of 30 unique waveforms are required for each of the Short Pulse Radar Types 2 through 4. If more than 30 waveforms are used for Short Pulse Radar Types 2 through 4, then each additional waveform must also be unique and not repeated from the previous waveforms. If more than 30 waveforms are used for Short Pulse Radar Type 1, then each additional waveform is generated with Test B and must also be unique and not repeated from the previous waveforms in Tests A or B. Test aggregate is average of the percentage of successful detections of short pulse radar types 1-4

12.4. Calibration of radar waveform

Radar Waveform Calibration Procedure:

- (1) A 50 ohm load is connected in place of the spectrum analyzer, and the spectrum analyzer is connected to place of the master
- (2) The interference Radar Detection Threshold Level is $-62\text{dBm} + 0\text{dBi} + 1\text{dB} = -61\text{dBm}$ that had been taken into account the output power range and antenna gain.
- (3) The following equipment setup was used to calibrate the conducted radar waveform. A vector signal generator was utilized to establish the test signal level for radar type 0. During this process there were no transmissions by either the master or client device. The spectrum analyzer was switched to the zero spans (time domain) at the frequency of the radar waveform generator. Peak detection was used. The spectrum analyzer resolution bandwidth (RBW) and video bandwidth (VBW) were set to 3 MHz. The spectrum analyzer had offset -1.0dB to compensate RF cable loss 1.0dB .
- (4) The vector signal generator amplitude was set so that the power level measured at the spectrum analyzer was $-62\text{dBm} + 0\text{dBi} + 1\text{dB} = -61\text{dBm}$. Capture the spectrum analyzer plots on short pulse radar waveform.

Conducted Calibration Setup:

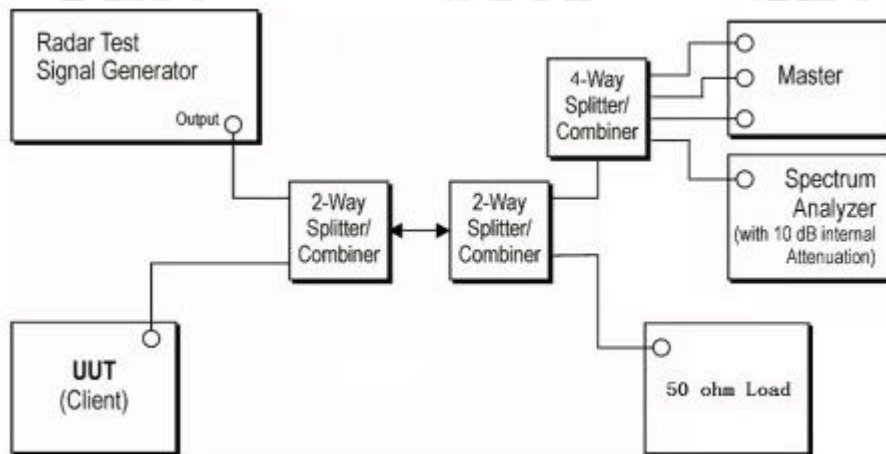

Note: 1. Use the software "Web" to set the frequency channel.

2. EUT is not support TPC and not with Radar detection.

Radar Waveform Calibration Result:

Radar Type 0

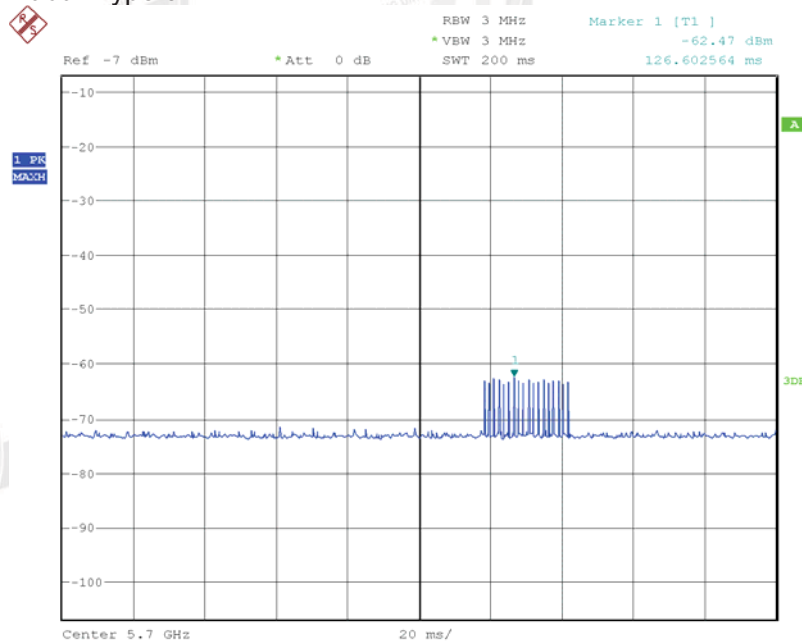

Trial List Table - FCC-13-22

Save Load Trigger Download All

Sample Rate 10 MHz

Trial List

	Trial Id	Radar Type	Pulse Width (us)	PRI (us)	Number of Pulses	Waveform Length (us)
Download	0	Type 0	1.0	1428.0	18	25704.0
Download	1	Type 0	1.0	1428.0	18	25704.0
Download	2	Type 0	1.0	1428.0	18	25704.0
Download	3	Type 0	1.0	1428.0	18	25704.0
Download	4	Type 0	1.0	1428.0	18	25704.0
Download	5	Type 0	1.0	1428.0	18	25704.0
Download	6	Type 0	1.0	1428.0	18	25704.0
Download	7	Type 0	1.0	1428.0	18	25704.0
Download	8	Type 0	1.0	1428.0	18	25704.0
Download	9	Type 0	1.0	1428.0	18	25704.0
Download	10	Type 0	1.0	1428.0	18	25704.0
Download	11	Type 0	1.0	1428.0	18	25704.0
Download	12	Type 0	1.0	1428.0	18	25704.0
Download	13	Type 0	1.0	1428.0	18	25704.0
Download	14	Type 0	1.0	1428.0	18	25704.0
Download	15	Type 0	1.0	1428.0	18	25704.0
Download	16	Type 0	1.0	1428.0	18	25704.0
Download	17	Type 0	1.0	1428.0	18	25704.0
Download	18	Type 0	1.0	1428.0	18	25704.0
Download	19	Type 0	1.0	1428.0	18	25704.0
Download	20	Type 0	1.0	1428.0	18	25704.0
Download	21	Type 0	1.0	1428.0	18	25704.0
Download	22	Type 0	1.0	1428.0	18	25704.0
Download	23	Type 0	1.0	1428.0	18	25704.0
Download	24	Type 0	1.0	1428.0	18	25704.0
Download	25	Type 0	1.0	1428.0	18	25704.0
Download	26	Type 0	1.0	1428.0	18	25704.0
Download	27	Type 0	1.0	1428.0	18	25704.0

12.5. Channel closing transmission time, channel move time and non-occupancy period

Block diagram of test setup Test Procedure:

- (1) The radar pulse generator is setup to provide a pulse at frequency that the master and client are operating. A type 0 radar pulse with a 1us pulse width and a 1428us PRI is used for the testing.
- (2) The vector signal generator is adjusted to provide the radar burst (18 pulses) at the level of approximately -61dBm at the antenna port of the master device.
- (3) A trigger is provided from the pulse generator to the DFS monitoring system in order to capture the traffic and the occurrence of the radar pulse.
- (4) EUT will associate with the master at channel. The file "iperf.exe" specified by the FCC is streamed from the PC 2 through the master and the client device to the PC 1 and played in full motion video using Test Software in order to properly load the network for the entire period of the test.
- (5) When radar burst with a level equal to the DFS Detection Threshold +1dB is generated on the operating channel of the U-NII device. At time T0 the radar waveform generator sends a burst of pulse of the radar waveform at Detection Threshold +1dB.
- (6) Observe the transmissions of the EUT at the end of the radar Burst on the Operating Channel. Measure and record the transmissions from the UUT during the observation time (Channel Move Time). One 15 seconds plot is reported for the Short Pulse Radar Type 0. The plot for the Short Pulse Radar Types start at the end of the radar burst. The Channel Move Time will be calculated based on the zoom in 600ms plot of the Short Pulse Radar Type.
- (7) Measurement of the aggregate duration of the Channel Closed Transmission Time method. With the
- (8) spectrum analyzer set to zero span tuned to the center frequency of the EUT operating channel at the radar simulated frequency, peak detection, and max hold, the dwell time per bin is given by: $Dwell (0.3ms) = S (12000ms) / B (4000)$; where Dwell is the dwell time per spectrum analyzer sampling bin, S is sweep time and B is the number of spectrum analyzer sampling bins. An upper bound of the aggregate duration of the intermittent control signals of Channel Closing Transmission Time is calculated by: $C (ms) = N \times Dwell (0.3ms)$; where C is the Closing Time, N is the number of spectrum analyzer sampling bins (intermittent control signals) showing a U-NII transmission and Dwell is the dwell time per bin.

Measurement the EUT for more than 30 minutes following the channel move time to verify that no transmission or beacons occur on this channel.

12.6. Test setup

Setup for Client with injection at the Master

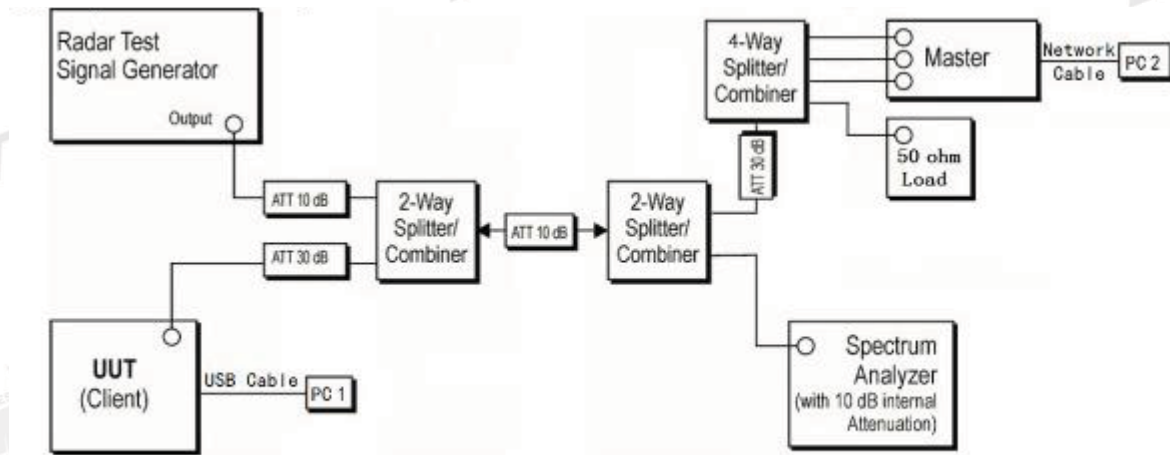

12.7. Test result

BW/Channel	Test Item	Test Result	Limit	Results
80M/5290MHz	Channel Move Time	5.181s	< 10s	pass
	Channel Closing Transmission Time	0.068s	< 0.26s	pass
80M/5530MHz	Channel Move Time	5.202s	< 10s	pass
	Channel Closing Transmission Time	0.065s	< 0.26s	pass

Test plots as follows:

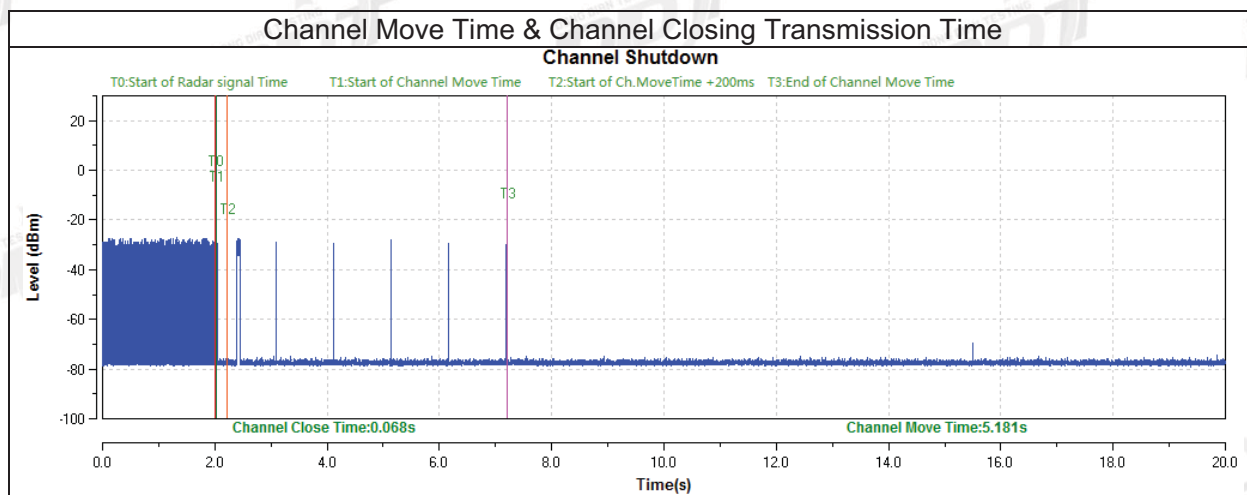

BW/Channel	Test Item	Test Result	Limit	Results
80M/5290MHz	Non-Occupancy Period	>30min	30min	pass
80M/5530MHz	Non-Occupancy Period	>30min	30min	pass

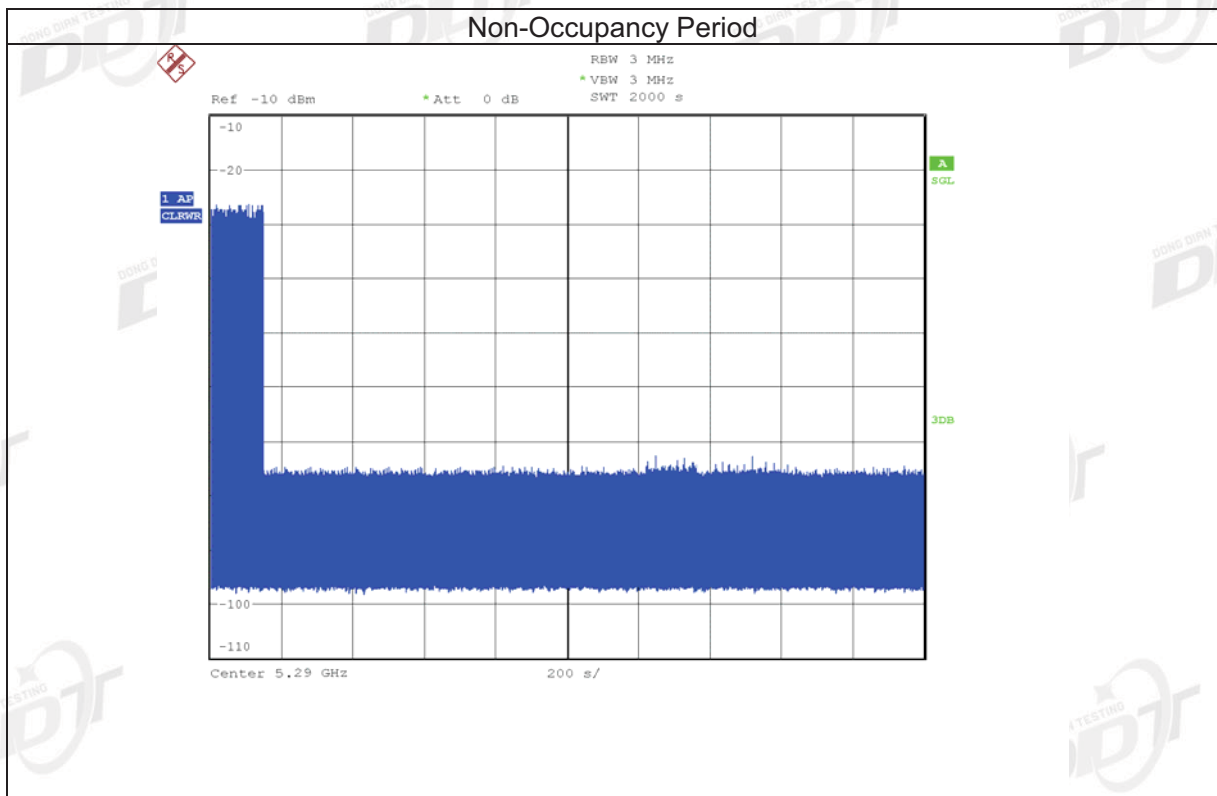
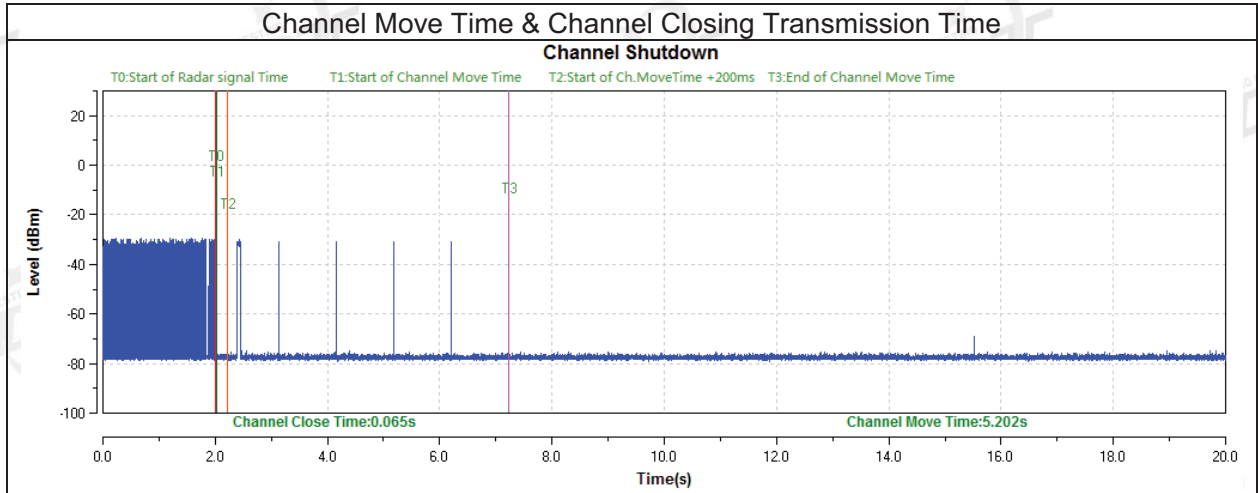

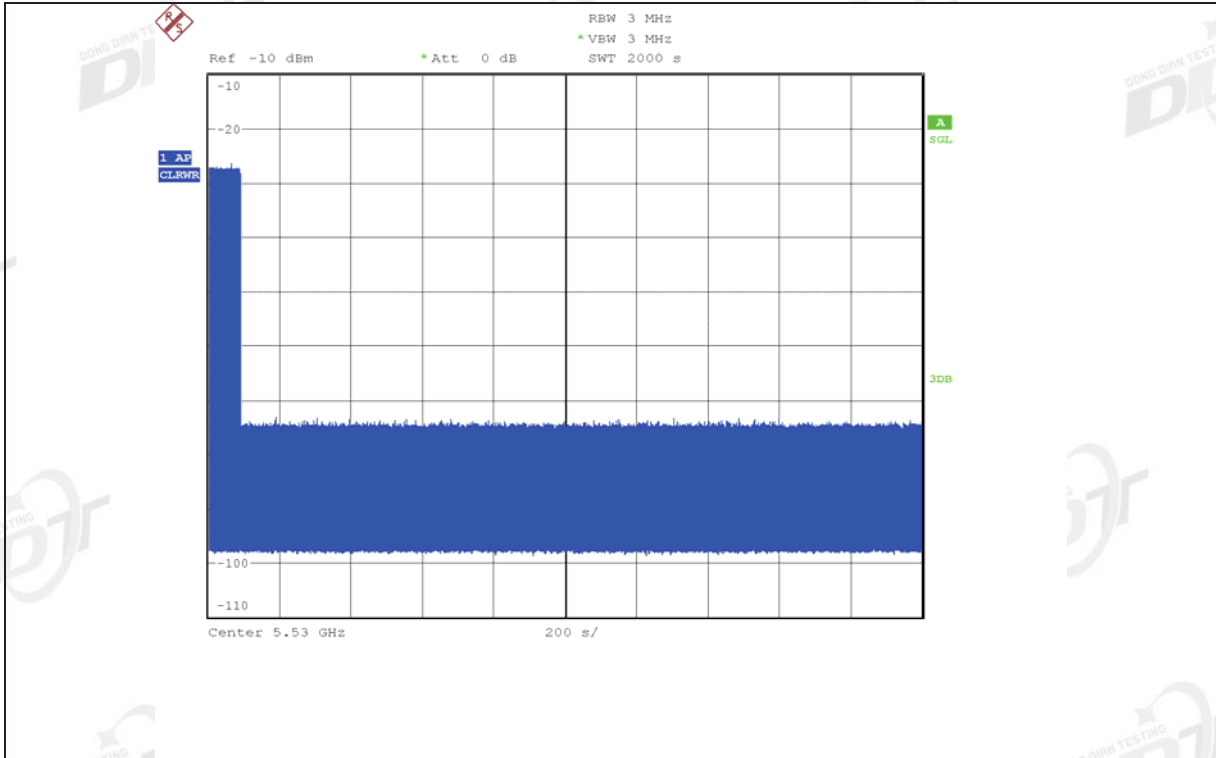

END OF REPORT