



FCC AND ISED CERTIFICATION TEST REPORT

Applicant	:	Harman International Industries, Inc.
Address of Applicant	:	8500 Balboa Boulevard, Northridge, CA 91329, UNITED STATES
Manufacturer	:	Harman International Industries, Inc.
Address of Manufacturer	:	8500 Balboa Boulevard, Northridge, CA 91329, UNITED STATES
Equipment under Test	:	PORTABLE BLUETOOTH SPEAKER
Model No.	:	GO4T
Trade Mark	:	JBL
FCC ID	:	APIJBLGO4T
IC	:	6132A-JBLGO4T
Test Standard(s)	:	FCC Rules and Regulations Part 15 Subpart C, RSS-247 Issue 3 August 2023, ANSI C63.10:2013, RSS-Gen Issue 5, Apr. 2018, Amendment 2 (February 2021)
Report No.	:	DDT-RE23090801-2E01
Issue Date	:	2023/10/26
Issue By	:	Guangdong Dongdian Testing Service Co., Ltd.
Address of Laboratory	:	Unit 2, Building 1, No. 17, Zongbu 2nd Road, Songshan Lake Park, Dongguan, Guangdong, China, 523808

REPORT

Table of Contents

	Test report declares.....	4
1.	Summary of Test Results.....	7
2.	General Test Information	8
2.1.	Description of EUT	8
2.2.	Accessories of EUT.....	9
2.3.	Assistant equipment used for test.....	9
2.4.	Block diagram of EUT configuration for test	9
2.5.	Deviations of test standard.....	10
2.6.	Test environment conditions	10
2.7.	Test laboratory	10
2.8.	Measurement uncertainty.....	11
3.	Equipment Used During Conductive Test.....	12
4.	20 dB Bandwidth	13
4.1.	Block diagram of test setup.....	13
4.2.	Limits	13
4.3.	Test procedure	13
4.4.	Test result.....	14
4.5.	Test graphs	15
5.	99% Bandwidth	17
5.1.	Block diagram of test setup.....	17
5.2.	Limits	17
5.3.	Test procedure	17
5.4.	Test Result	18
5.5.	Test Graphs.....	19
6.	Maximum Peak Output Power	21
6.1.	Block diagram of test setup.....	21
6.2.	Limits	21
6.3.	Test procedure	21
6.4.	Test Result	22
6.5.	Test graphs	23
7.	Carrier Frequency Separation.....	25
7.1.	Block diagram of test setup.....	25
7.2.	Limits	25
7.3.	Test procedure	25
7.4.	Test result.....	26
7.5.	Test graphs	27
8.	Dwell Time.....	28

8.1.	Block diagram of test setup.....	28
8.2.	Limits.....	28
8.3.	Test procedure.....	28
8.4.	Test result.....	29
8.5.	Test graphs.....	30
9.	Number of Hopping Channel.....	34
9.1.	Block diagram of test setup.....	34
9.2.	Limits.....	34
9.3.	Test procedure.....	34
9.4.	Test result.....	35
9.5.	Test graphs.....	36
10.	Band Edge Compliance (Conducted Method).....	37
10.1.	Block diagram of test setup.....	37
10.2.	Limit.....	37
10.3.	Test procedure.....	37
10.4.	Test result.....	38
10.5.	Test graphs.....	39
11.	RF Conducted Spurious Emissions.....	42
11.1.	Block diagram of test setup.....	42
11.2.	Limits.....	42
11.3.	Test procedure.....	42
11.4.	Test result.....	43
11.5.	Test graphs.....	44
12.	Duty cycle.....	50
12.1.	Block diagram of test setup.....	50
12.2.	Limit.....	50
12.3.	Test procedure.....	50
12.4.	Test result.....	51
12.5.	Test graphs.....	52
13.	Radiated Emission.....	54
13.1.	Test equipment.....	54
13.2.	Block diagram of test setup.....	55
13.3.	Limit.....	56
13.4.	Test procedure.....	58
13.5.	Test result.....	59
14.	Band Edge Compliance (Radiated Method).....	68
14.1.	Test equipment.....	68
14.2.	Block diagram of test setup.....	68

14.3.	Limit.....	68
14.4.	Test procedure	68
14.5.	Test result.....	69
15.	Power Line Conducted Emission.....	78
15.1.	Test equipment.....	78
15.2.	Block diagram of test setup.....	78
15.3.	Power line conducted emission limits	78
15.4.	Test procedure	78
15.5.	Test result.....	79
16.	Antenna Requirements	82
16.1.	Limit.....	82
16.2.	Result	82
17.	Test Setup Photograph	83
18.	Photos of the EUT	86

Test Report Declare

Applicant	:	Harman International Industries, Inc.
Address of Applicant	:	8500 Balboa Boulevard, Northridge, CA 91329, UNITED STATES
Equipment under Test	:	PORTABLE BLUETOOTH SPEAKER
Model No.	:	GO4T
Trade Mark	:	JBL
Manufacturer	:	Harman International Industries, Inc.
Address of Manufacturer	:	8500 Balboa Boulevard, Northridge, CA 91329, UNITED STATES

Test Standard Used:

FCC Rules and Regulations Part 15 Subpart C, RSS-247 Issue 3 August 2023.

Test Procedure Used:

ANSI C63.10:2013, RSS-Gen Issue 5, Apr. 2018, Amendment 2 (February 2021)

We Declare:

The equipment described above is tested by Guangdong Dongdian Testing Service Co., Ltd. and in the configuration tested the equipment complied with the standards specified above. The test results are contained in this test report and Guangdong Dongdian Testing Service Co., Ltd. is assumed of full responsibility for the accuracy and completeness of these tests.

After test and evaluation, our opinion is that the equipment provided for test compliance with the requirement of the above FCC&ISED standards.

Report No.:	DDT-RE23090801-2E01		
Date of Receipt:	2023/10/16	Date of Test:	2023/10/16 ~ 2023/10/26

Prepared By:

Bobo Chen

Bobo Chen/Engineer

Approved By:

Damon Hu

Damon Hu/EMC Manager

Note: This report applies to above tested sample only. This report shall not be reproduced in parts without written approval of Guangdong Dongdian Testing Service Co., Ltd.

Revision History

Rev.	Revisions	Issue Date	Revised By
---	Initial issue	2023/10/26	

1. Summary of Test Results

Description of Test Item	Standard	Result
Maximum Peak Output Power	FCC Part 15: 15.247(b)(1) RSS-247 Issue 3 clause 5.4(b)	Pass
20 dB Bandwidth	FCC Part 15: 15.247(a)(1) RSS-247 Issue 3 clause 5.1(a)	Pass
99% Bandwidth	RSS-Gen Issue 5 clause 6.7	Pass
Carrier Frequency Separation	FCC Part 15: 15.247(a)(1) RSS-247 Issue 3 clause 5.1(b)	Pass
Number of Hopping Channel	FCC Part 15: 15.247(a)(1)(iii) RSS-247 Issue 3 clause 5.1(d)	Pass
Dwell Time	FCC Part 15: 15.247(a)(1)(iii) RSS-247 Issue 3 clause 5.1(d)	Pass
RF Conducted Spurious Emissions	FCC Part 15: 15.247(d) RSS-247 Issue 3 clause 5.5	Pass
Radiated Emission	FCC Part 15: 15.205 FCC Part 15: 15.209 FCC Part 15: 15.247(d) RSS-247 Issue 3 clause 5.5 RSS-Gen Issue 5 clause 8.9 RSS-Gen Issue 5 clause 8.10	Pass
Band Edge Compliance	FCC Part 15: 15.205 FCC Part 15: 15.209 FCC Part 15: 15.247(d) RSS-247 Issue 3 clause 5.5 RSS-Gen Issue 5 clause 8.9 RSS-Gen Issue 5 clause 8.10	Pass
Power Line Conducted Emissions	FCC Part 15: 15.207(a) RSS-Gen Issue 5 clause 8.8	Pass
Antenna Requirement	FCC Part 15: 15.203 RSS-Gen Issue 5 clause 6.8	Pass
Note: Determining compliance based on the results of the compliance measurement, not taking into account measurement uncertainty.		

2. General Test Information

2.1. Description of EUT

EUT Name	: PORTABLE BLUETOOTH SPEAKER
Model Number	: GO4T
EUT Function Description	: Please reference user manual of this device
Power Supply	: DC 5V from external USB cable DC 3.8V built-in battery, 850mAh
Radio Specification	: Bluetooth V5.3 (BR/EDR/LE)
Operation Frequency	: 2402 MHz-2480 MHz
Modulation	: Bluetooth BR/EDR: GFSK, $\pi/4$ -DQPSK Bluetooth LE: GFSK
Sample Number	: S23090801-07 for conductive, S23090801-06 for radiation

Note 1: “☑” means to be chosen or applicable; “☐” means don’t to be chosen or not applicable; This note applies to entire report.

Note 2: This report only for Bluetooth BR/EDR.

Note 3: Antenna information:

Bluetooth Antenna information	
Antenna Type	: PCB Onboard copper antenna
Antenna Gain(dBi)	: 2.10

Note 4: Channel information:

Bluetooth BR/EDR Channel information					
Channel	Frequency (MHz)	Channel	Frequency (MHz)	Channel	Frequency (MHz)
0	2402	27	2429	54	2456
1	2403	28	2430	55	2457
2	2404	29	2431	56	2458
3	2405	30	2432	57	2459
4	2406	31	2433	58	2460
5	2407	32	2434	59	2461
6	2408	33	2435	60	2462
7	2409	34	2436	61	2463
8	2410	35	2437	62	2464
9	2411	36	2438	63	2465
10	2412	37	2439	64	2466
11	2413	38	2440	65	2467
12	2414	39	2441	66	2468
13	2415	40	2442	67	2469
14	2416	41	2443	68	2470

15	2417	42	2444	69	2471
16	2418	43	2445	70	2472
17	2419	44	2446	71	2473
18	2420	45	2447	72	2474
19	2421	46	2448	73	2475
20	2422	47	2449	74	2476
21	2423	48	2450	75	2477
22	2424	49	2451	76	2478
23	2425	50	2452	77	2479
24	2426	51	2453	78	2480
25	2427	52	2454		
26	2428	53	2455		

Note 5: The above EUT information is declared by manufacturer and for more detailed features description please refer to the manufacturer's specifications or User's Manual. The above Antenna information is declared by manufacturer and for more detailed features description please refer to the manufacturer's specifications, the laboratory shall not be held responsible.

2.2. Accessories of EUT

Description of Accessories	Manufacturer	Model number	Description	Remark
USB cable	Harman	N/A	Length: 0.3m	N/A

2.3. Assistant equipment used for test

Assistant equipment	Manufacturer	Model number	EMC Compliance	SN
NoteBook	Lenovo	Ryzen 5 PRO 3500U	N/A	00425-00000-00002-AA135
Adapter	SAMSUNG	EP-TA200	Input: 100-240~, 50/60Hz, 0.5A; Output: 9V/1.67A or 5V/2A	N/A

2.4. Block diagram of EUT configuration for test

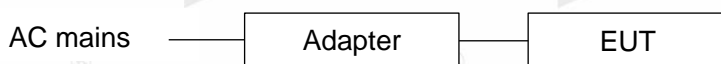

Test software: Authentication Tool V2.3.164.891.exe

The test software was used to control EUT work in Continuous Tx mode, and select test channel, wireless mode as below table.

The pathloss of external cable: 0.5 dB (According to the manufacturer's claims)

Tested mode, channel, information			
Mode	Setting Tx Power	Channel	Frequency (MHz)
GFSK hopping on Tx mode	Default	CH0 to CH78	2402 to 2480
$\pi/4$ -DQPSK hopping on Tx mode	Default	CH0 to CH78	2402 to 2480
GFSK hopping off Tx mode	Default	CH0	2402
	Default	CH39	2441
	Default	CH78	2480
$\pi/4$ -DQPSK hopping off Tx mode	Default	CH0	2402
	Default	CH39	2441
	Default	CH78	2480
Worst-case data rates were: GFSK mode: DH5, $\pi/4$ -DQPSK mode: 2DH5			

2.5. Deviations of test standard

No deviation.

2.6. Test environment conditions

During the measurement the environmental conditions were within the listed ranges:

Temperature range:	+15°C to +35 °C
Humidity range:	20% to 75%
Pressure range:	86 kPa to 106 kPa

Note: The specific temperature and humidity information of each test item refers to the temperature and humidity record in the corresponding test data.

2.7. Test laboratory

Guangdong Dongdian Testing Service Co., Ltd.

Add.: Unit 2, Building 1, No. 17, Zongbu 2nd Road, Songshan Lake Park, Dongguan, Guangdong, China, 523808

Tel.: +86-0769-38826678, <http://www.dgddt.com>, Email: ddt@dgddt.com.

CNAS Accreditation No. L6451; A2LA Accreditation Number: 3870.01

FCC Designation Number: CN1182, Test Firm Registration Number: 540522

Innovation, Science and Economic Development Canada Site Registration Number: 10288A

Conformity Assessment Body identifier: CN0048

VCCI facility registration number: C-20087, T-20088, R-20123, R-20155, G-20118

2.8. Measurement uncertainty

Test Item	Uncertainty
Bandwidth	1.1%
Peak Output Power (Conducted) (Spectrum analyzer)	0.86 dB (10 MHz ≤ f < 3.6 GHz);
	1.38 dB (3.6 GHz ≤ f < 8 GHz)
Peak Output Power (Conducted) (Power Sensor)	0.74 dB
Power Spectral Density	0.74 dB (10 MHz ≤ f < 3.6 GHz);
	1.38 dB (3.6 GHz ≤ f < 8 GHz)
Frequencies Stability	6.7 x 10 ⁻⁸ (Antenna couple method)
	5.5 x 10 ⁻⁸ (Conducted method)
Conducted spurious emissions	0.86 dB (10 MHz ≤ f < 3.6 GHz);
	1.40 dB (3.6 GHz ≤ f < 8 GHz)
	1.66 dB (8 GHz ≤ f < 26.5 GHz)
Uncertainty for radio frequency (RBW < 20 kHz)	3x10 ⁻⁸
Temperature	0.4 °C
Humidity	2 %
Uncertainty for Radiation Emission test (9 kHz – 30 MHz)	3.44 dB
Uncertainty for Radiation Emission test (30 MHz - 1 GHz)	4.70 dB (Antenna Polarize: V)
	4.84 dB (Antenna Polarize: H)
Uncertainty for Radiation Emission test (1 GHz - 40 GHz)	4.10 dB (1 - 6 GHz)
	4.40 dB (6 GHz - 18 GHz)
	3.54 dB (18 GHz - 26 GHz)
	4.30 dB (26 GHz - 40 GHz)
Uncertainty for Power line conduction emission test	3.34dB (150KHz-30MHz)
	3.72dB (9KHz-150KHz)

Note: This uncertainty represents an expanded uncertainty expressed at approximately the 95% confidence level using a coverage factor of k=2.

3. Equipment Used During Conductive Test

Equipment	Manufacturer	Model No.	Serial Number	Due Date
☑RF Connected Test (RF Measurement System 2#)				
SPECTRUM ANALYZER	R&S	FSU26	201124	2024/07/11
Power Sensor	R&S	NRP-Z22	101254	2024/07/11
Test Software	Tonscend	JS1120-3	Ver.3.2.22	N/A

4. 20 dB Bandwidth

4.1. Block diagram of test setup

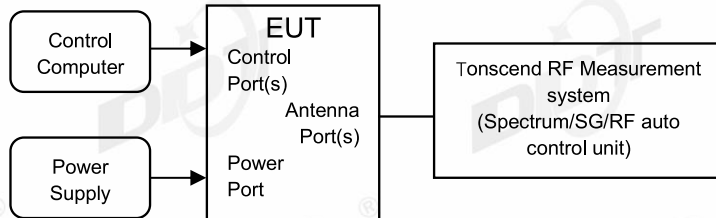

4.2. Limits

Intentional radiators operating under the alternative provisions to the general emission limits, as contained in § 15.217 through 15.257 and in Subpart E of this part, must be designed to ensure that the 20 dB bandwidth of the emission, or whatever bandwidth may otherwise be specified in the specific rule section under which the equipment operates, is contained within the frequency band designated in the rule section under which the equipment is operated.

4.3. Test procedure

- (1) The test according to ANSI C63.10-2013 clause 6.9.2.
- (2) Connect EUT's antenna output to spectrum analyzer by RF cable, the path loss was compensated to the results
- (3) Set the EUT as maximum power setting and enable the EUT transmit continuously
- (4) Use the following spectrum analyzer settings for the 20 dB bandwidth measurement:

RBW:	1% to 5% of the OBW
VBW:	approximately three times RBW
Span:	between 2 times and 5 times the OBW
Detector Mode:	Peak
Sweep time:	Auto
Trace mode:	Max hold
- (5) Measure and record the results in the report.

4.4. Test result

Test Site:	RF 2#	Test Date:	2023.10.18-2023.10.18
Ambient Condition:	26.2 °C,47.2 %RH	Test Engineer:	Zoe
Equipment under Test	PORTABLE BLUETOOTH SPEAKER	Model No.:	GO4T
Sample Number	S23090801-07	Test Power Supply:	Battery

Test Mode	Antenna	Frequency [MHz]	20dB EBW[MHz]
DH5	Ant1	2402	0.94
		2441	0.95
		2480	0.95
2DH5	Ant1	2402	1.30
		2441	1.28
		2480	1.29

4.5. Test graphs

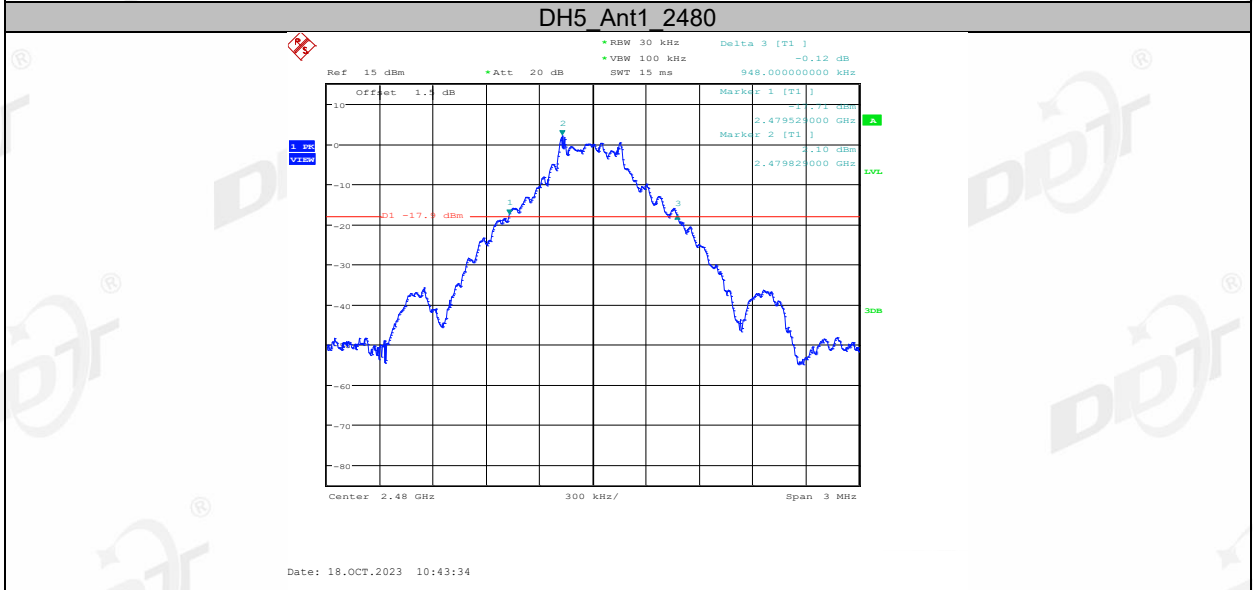
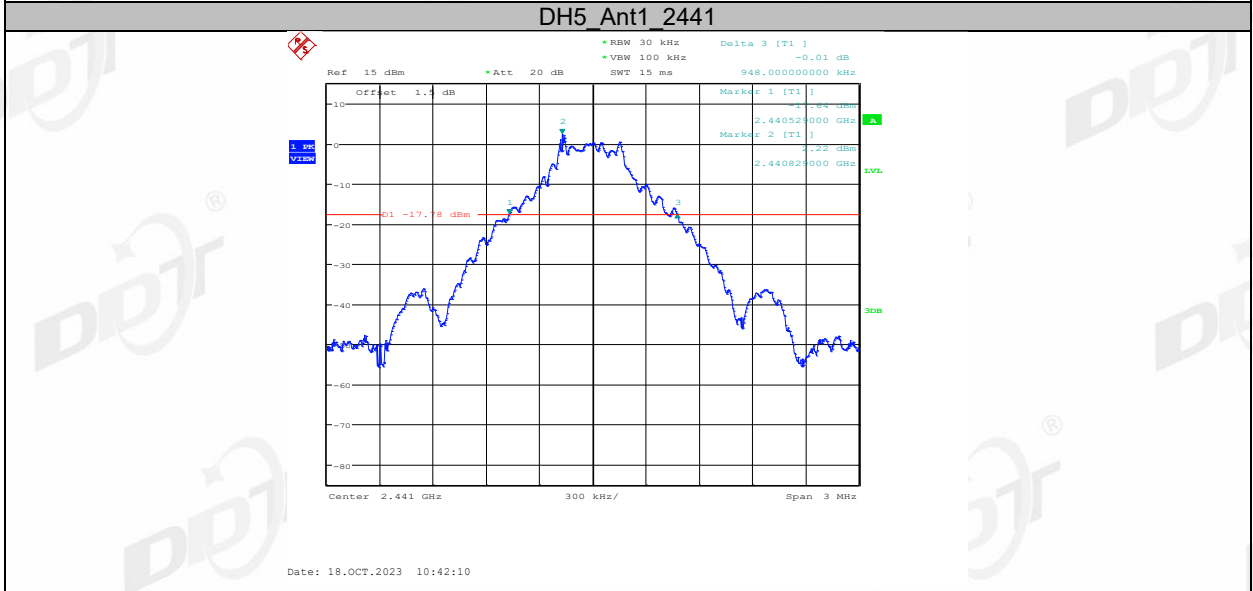
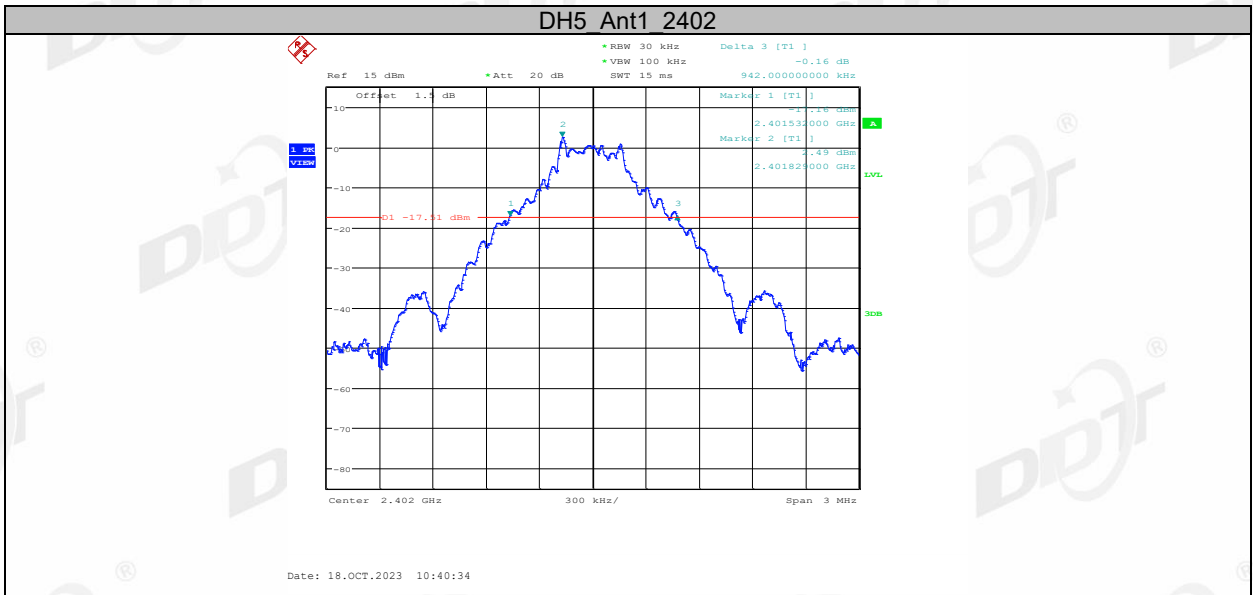

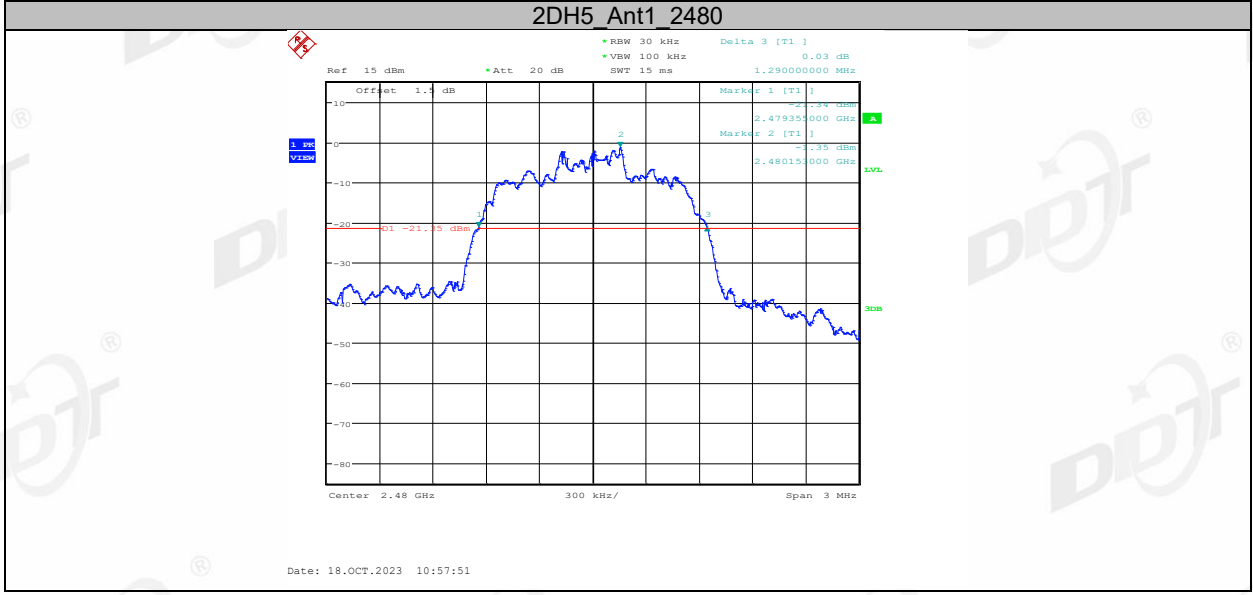
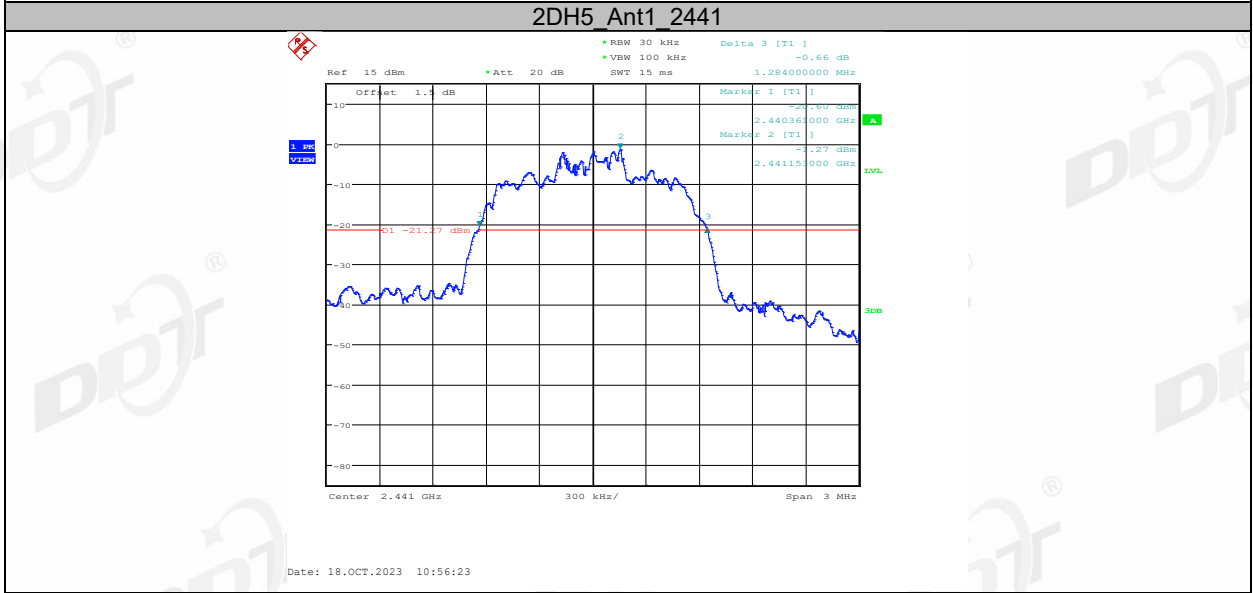
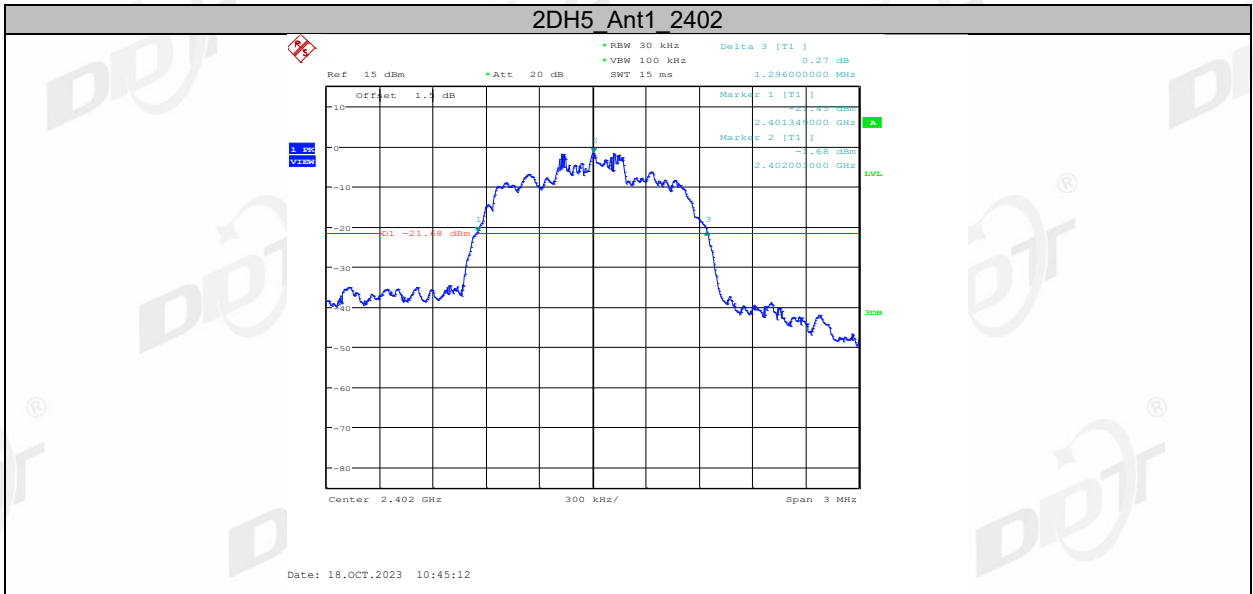

5. 99% Bandwidth

5.1. Block diagram of test setup

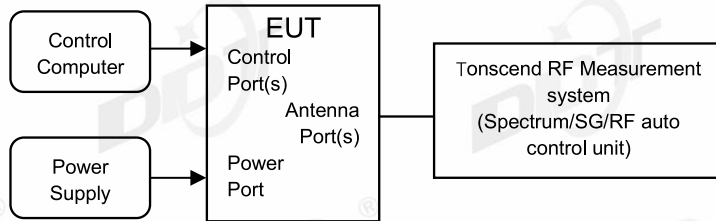

5.2. Limits

Just for Report.

5.3. Test procedure

- (1) The test according to ANSI C63.10-2013 clause 6.9.3.
- (2) Connect EUT's antenna output to spectrum analyzer by RF cable, the path loss was compensated to the results
- (3) Set the EUT as maximum power setting and enable the EUT transmit continuously
- (4) Use the following spectrum analyzer settings for the 99% bandwidth measurement:

RBW:	1% to 5% of the OBW
VBW:	approximately three times RBW
Span:	between 1.5 times and 5.0 times the OBW
Detector Mode:	Peak
Sweep time:	Auto
Trace mode:	Max hold
- (5) Measure and record the results in the report.

5.4. Test Result

Test Site:	RF 2#	Test Date:	2023.10.18-2023.10.18
Ambient Condition:	26.2 °C,47.2 %RH	Test Engineer:	Zoe
Equipment under Test	PORTABLE BLUETOOTH SPEAKER	Model No.:	GO4T
Sample Number	S23090801-07	Test Power Supply:	Battery

Test Mode	Antenna	Frequency [MHz]	OCB [MHz]	FL[MHz]	FH[MHz]
DH5	Ant1	2402	0.903	2401.5410	2402.4440
		2441	0.909	2440.5380	2441.4470
		2480	0.906	2479.5380	2480.4440
2DH5	Ant1	2402	1.173	2401.4000	2402.5730
		2441	1.173	2440.4000	2441.5730
		2480	1.173	2479.4000	2480.5730

5.5. Test Graphs

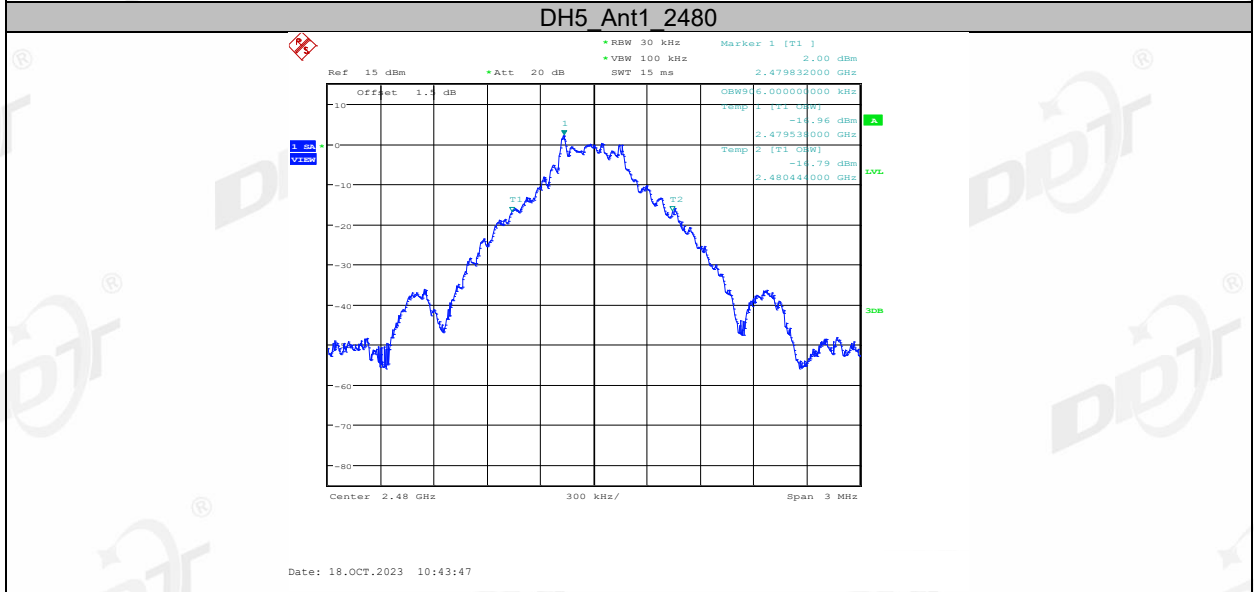
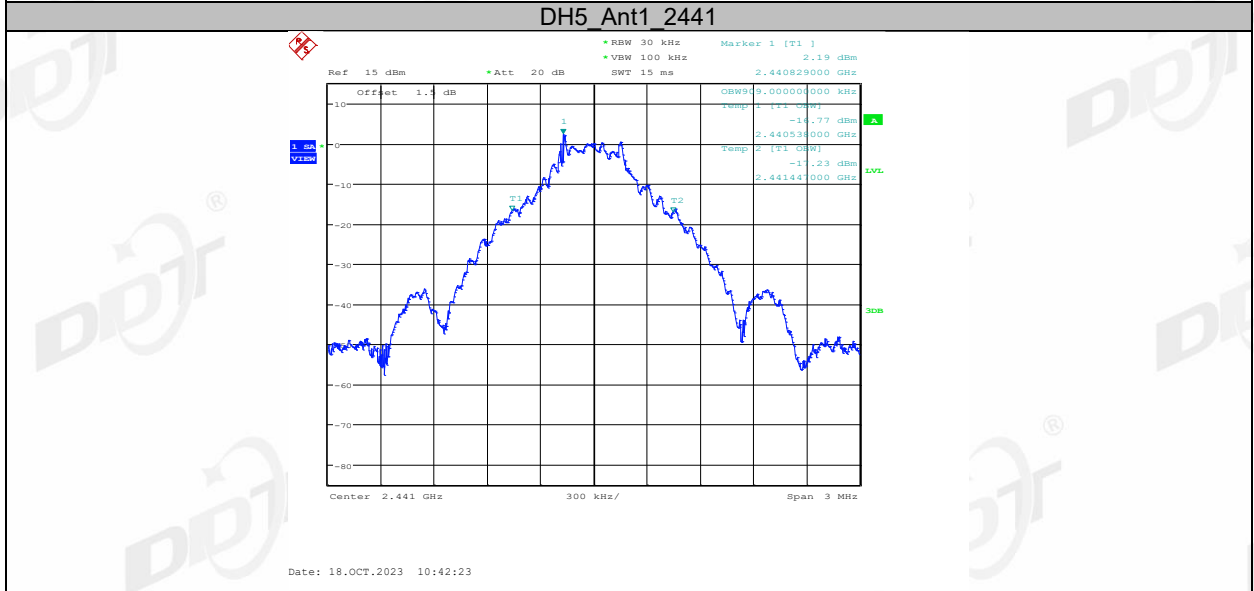
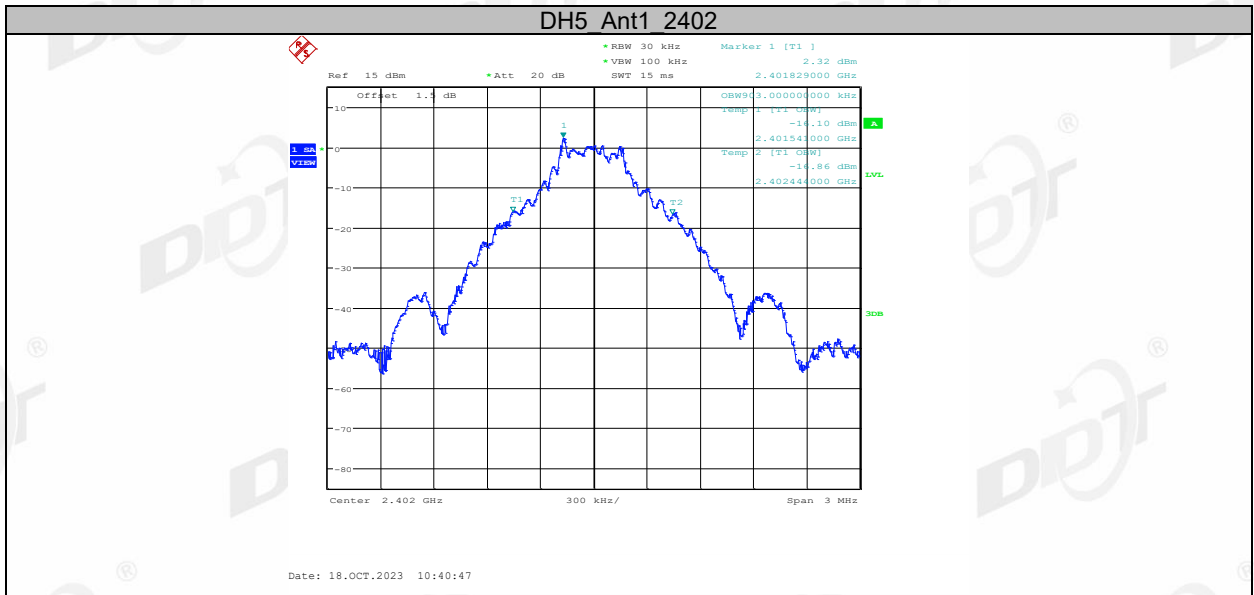

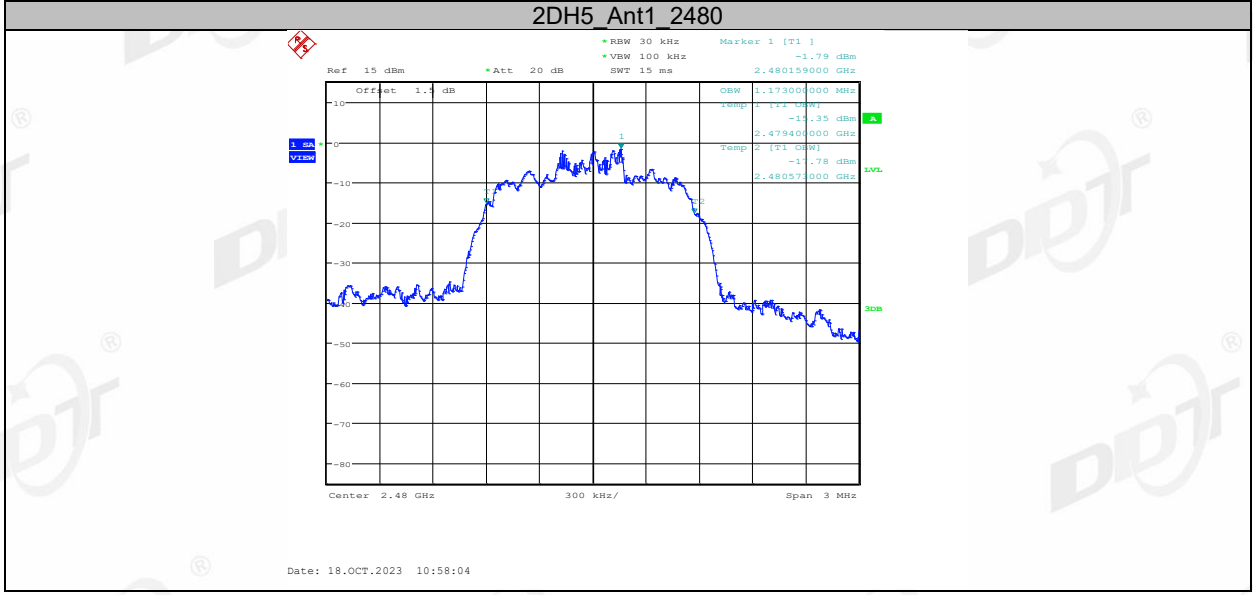
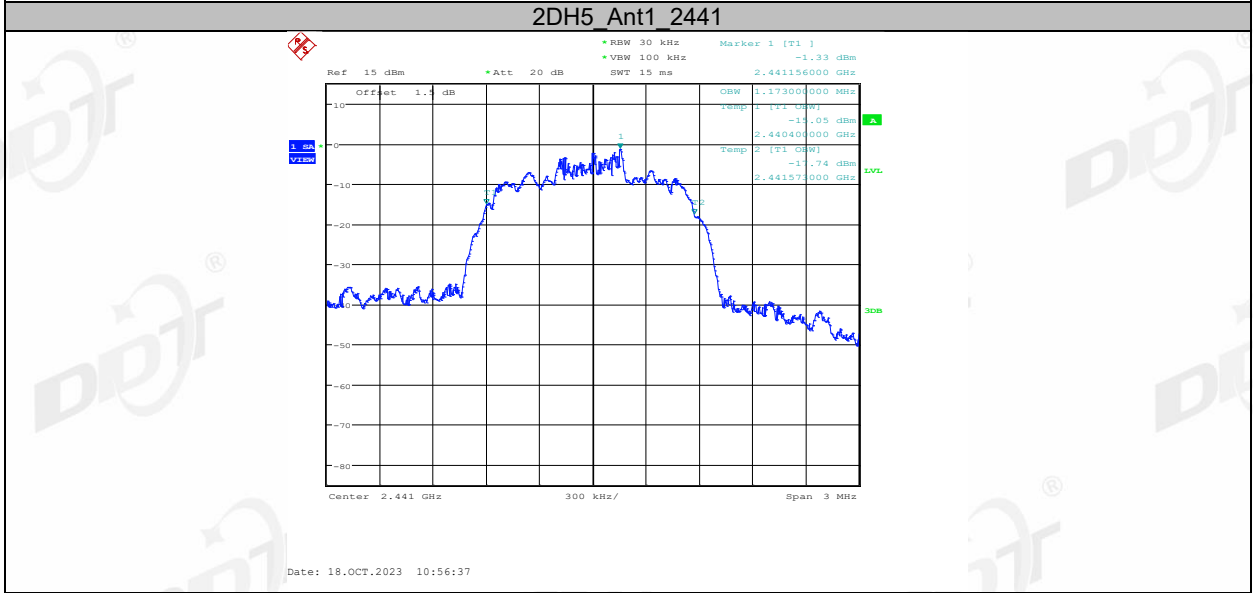
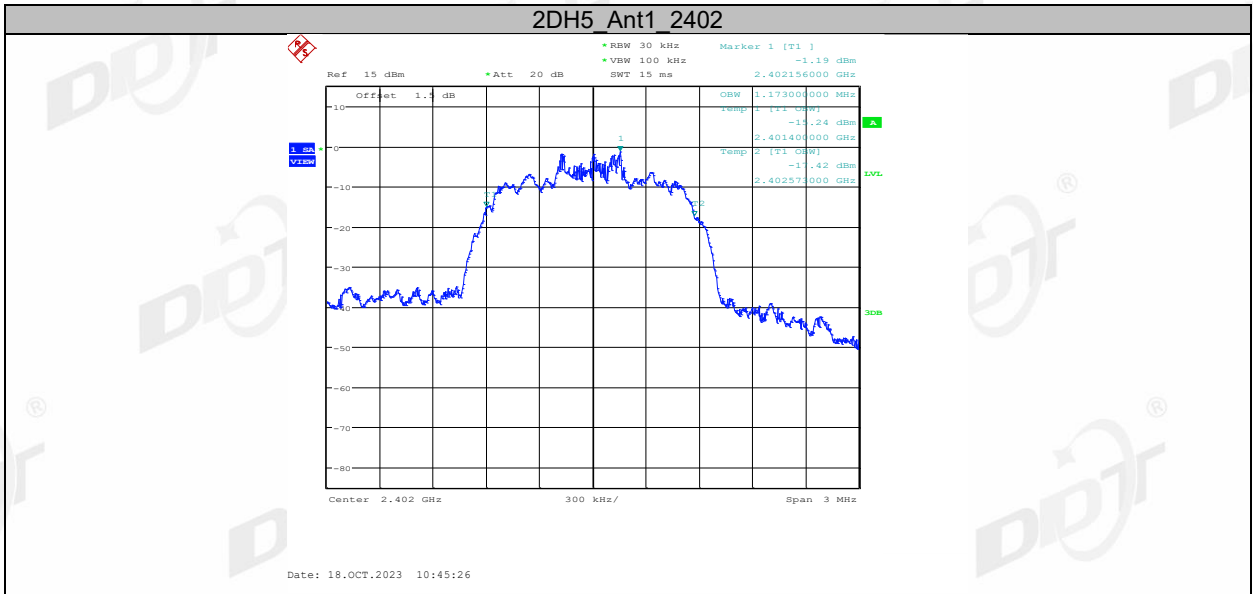

6. Maximum Peak Output Power

6.1. Block diagram of test setup

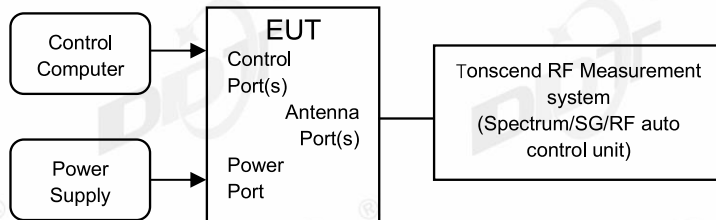

6.2. Limits

For frequency hopping systems operating in the 2400-2483.5 MHz band employing at least 75 non-overlapping hopping channels, and all frequency hopping systems in the 5725-5850 MHz band: 1 watt. For all other frequency hopping systems in the 2400-2483.5 MHz band: 0.125 watts, the e.i.r.p shall not exceed 4W.

6.3. Test procedure

- (1) The test according to ANSI C63.10-2013 clause 7.8.5.
- (2) Connect EUT's antenna output to spectrum analyzer by RF cable, the path loss was compensated to the results.
- (3) Set the EUT as maximum power setting and enable the EUT transmit continuously.
- (4) Use the following spectrum analyzer settings for the maximum peak output power measurement:

RBW:	> 20 dB bandwidth of the emission being measured.
VBW:	$VBW \geq RBW$.
Span:	Approximately five times the 20 dB bandwidth, centered on a hopping channel.
Detector Mode:	Peak
Sweep time:	Auto
Trace mode:	Max hold
- (5) Use the marker-to-peak function to set the marker to the peak of the emission and record the results in the report.

6.4. Test Result

Test Site:	RF 2#	Test Date:	2023.10.18-2023.10.18
Ambient Condition:	26.2 °C,47.2 %RH	Test Engineer:	Zoe
Equipment under Test	PORTABLE BLUETOOTH SPEAKER	Model No.:	GO4T
Sample Number	S23090801-07	Test Power Supply:	Battery

Test Mode	Antenna	Frequency [MHz]	Conducted Peak Power[dBm]	Conducted Limit[dBm]	EIRP[dBm]	EIRP Limit[dBm]	Verdict
DH5	Ant1	2402	4.02	≤20.97	6.12	≤30	PASS
		2441	3.76	≤20.97	5.86	≤30	PASS
		2480	3.67	≤20.97	5.77	≤30	PASS
2DH5	Ant1	2402	2.86	≤20.97	4.96	≤30	PASS
		2441	2.60	≤20.97	4.70	≤30	PASS
		2480	2.57	≤20.97	4.67	≤30	PASS

6.5. Test graphs

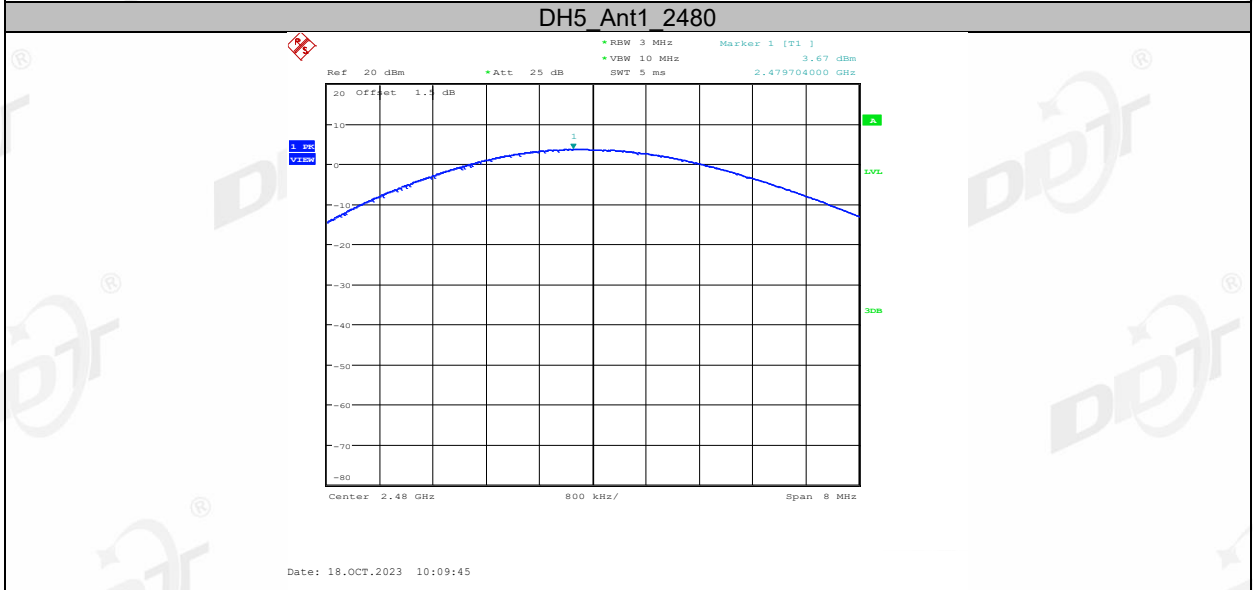
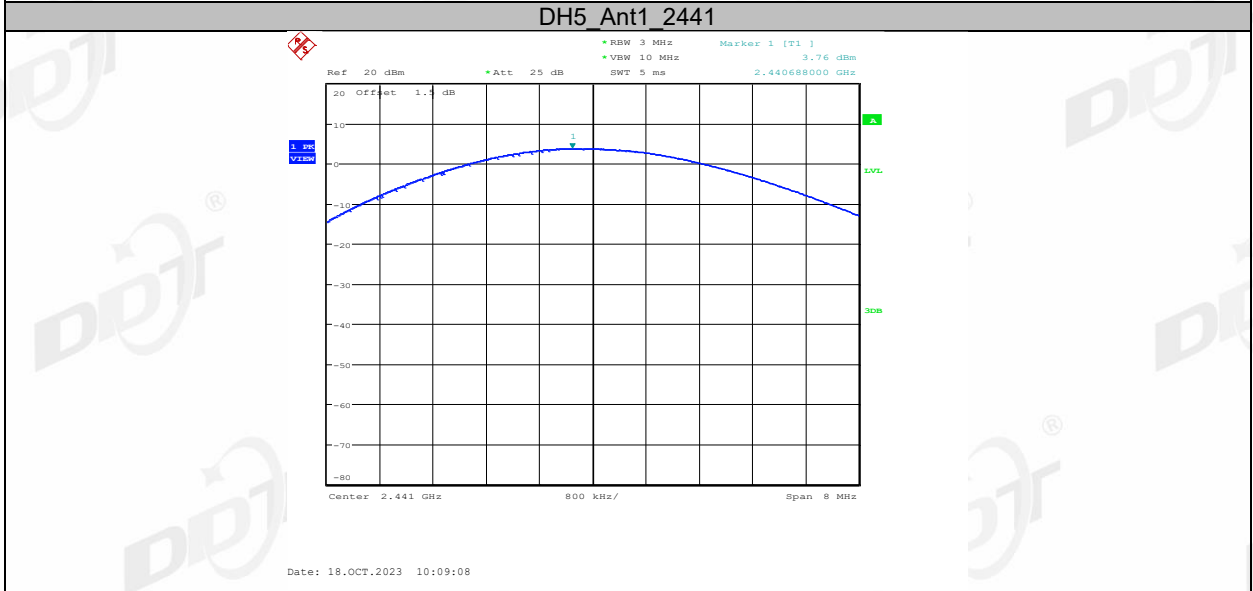
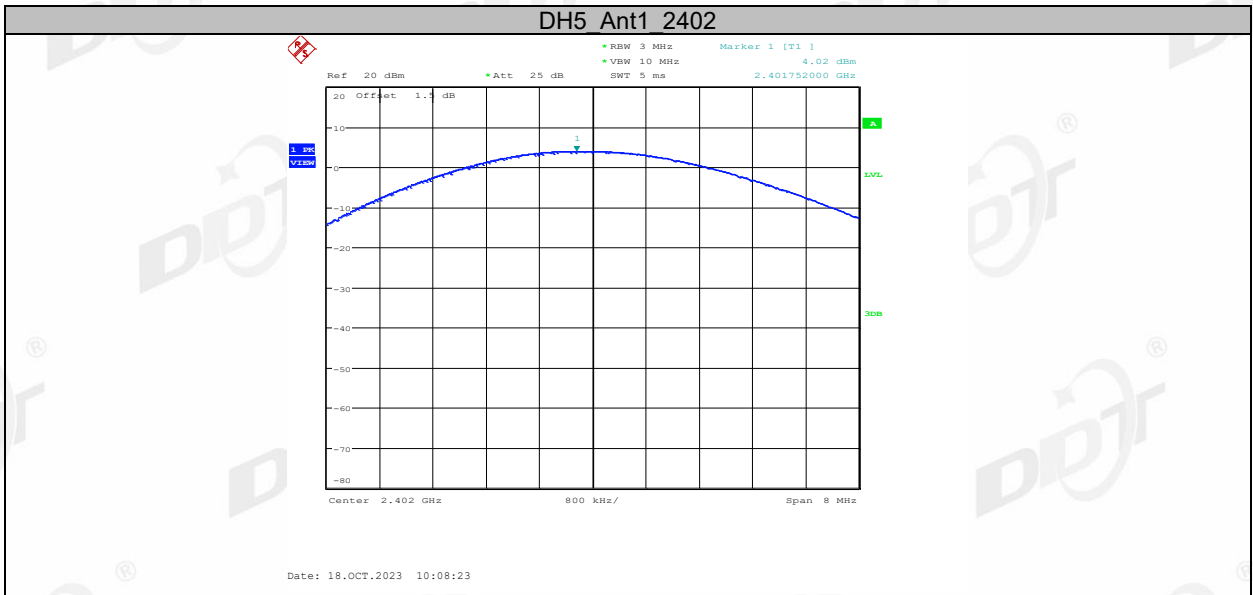

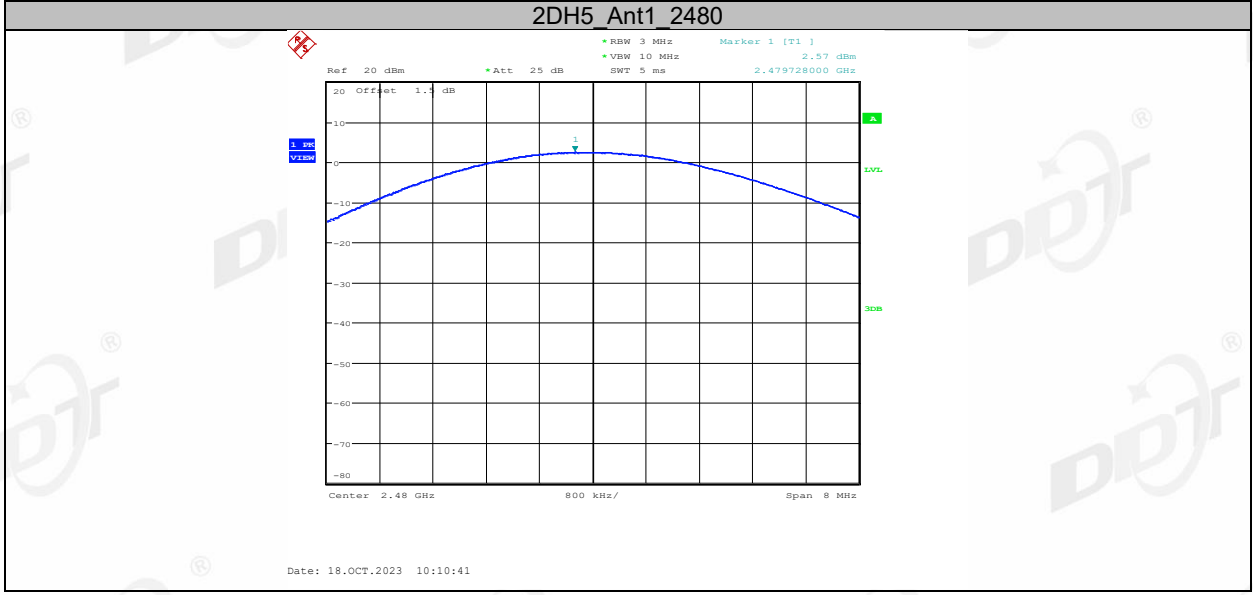
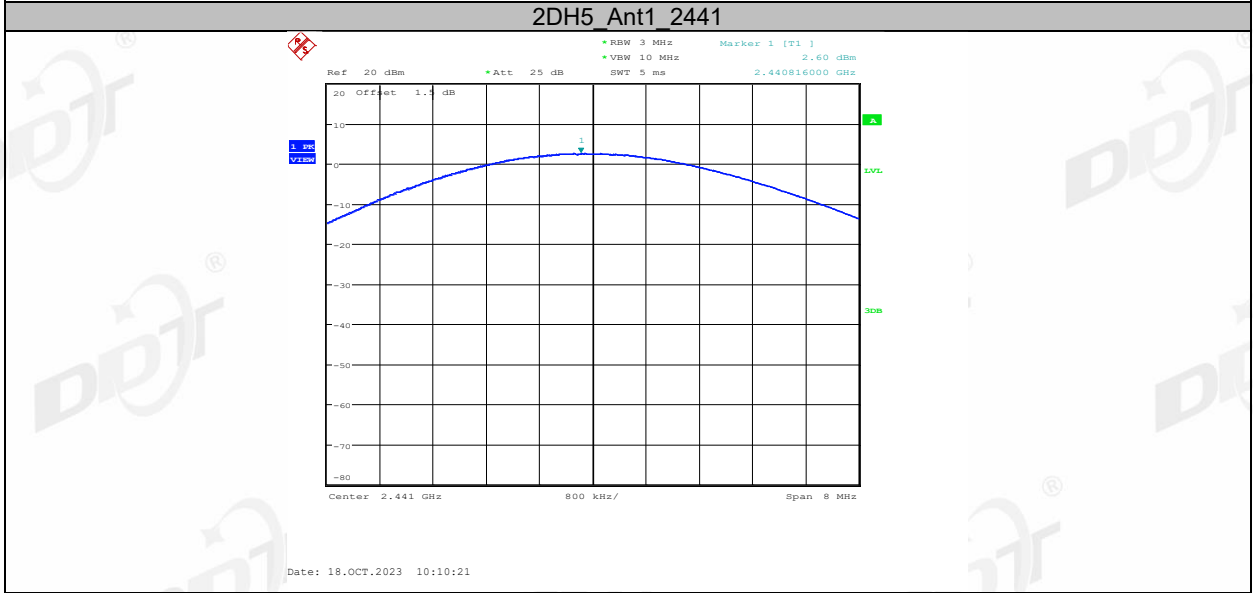
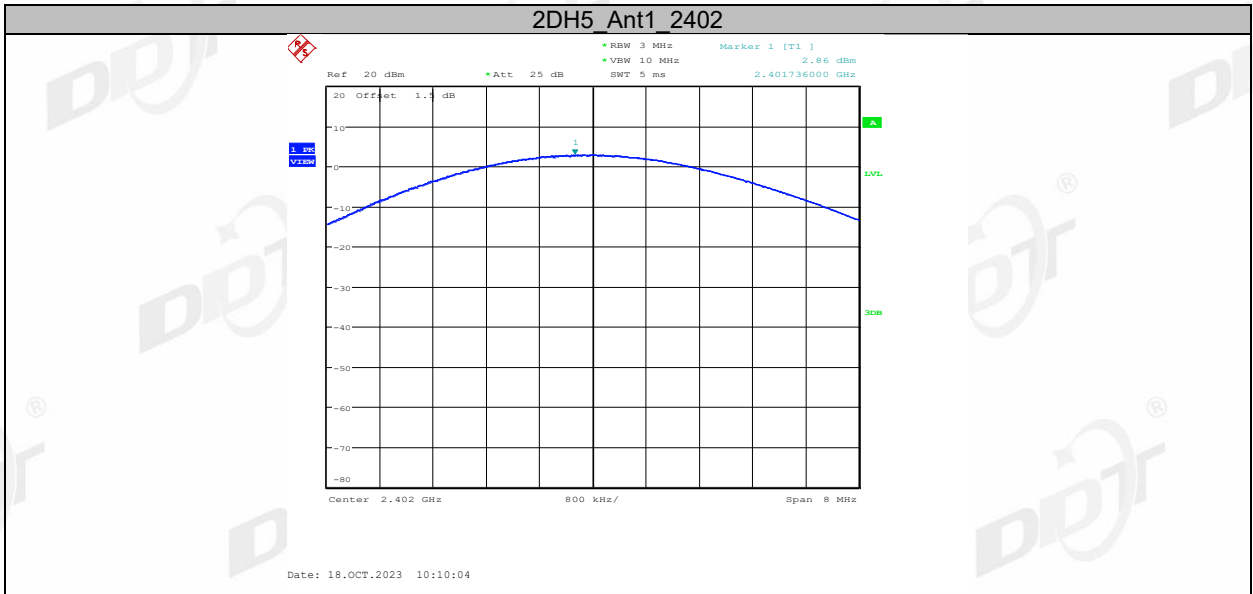

7. Carrier Frequency Separation

7.1. Block diagram of test setup

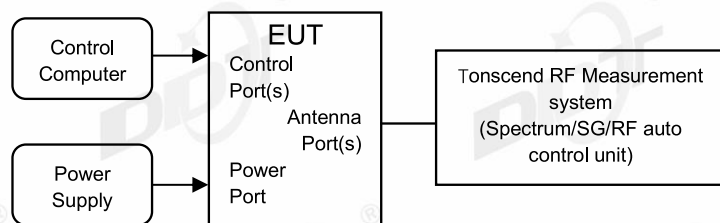

7.2. Limits

Frequency hopping systems shall have hopping channel carrier frequencies separated by a minimum of 25 kHz or the 20 dB bandwidth of the hopping channel, whichever is greater. Alternatively, frequency hopping systems operating in the 2400-2483.5 MHz band may have hopping channel carrier frequencies that are separated by 25 kHz or two-thirds of the 20 dB bandwidth of the hopping channel, whichever is greater, provided the systems operate with an output power no greater than 125 mW.

7.3. Test procedure

- (1) The test according to ANSI C63.10-2013 clause 7.8.2.
- (2) Connect EUT's antenna output to spectrum analyzer by RF cable, the path loss was compensated to the results.
- (3) Set the EUT as maximum power setting and enable the EUT transmit continuously.
- (4) Use the following spectrum analyzer settings for the maximum peak output power measurement:

RBW:	approximately 30% of the channel spacing
VBW:	$VBW \geq RBW$.
Span:	Wide enough to capture the peaks of two adjacent channels.
Detector Mode:	Peak
Sweep time:	Auto
Trace mode:	Max hold
- (5) Use the marker-delta function to determine the separation between the peaks of the adjacent channels and record the results in the report.

7.4. Test result

Test Site:	RF 2#	Test Date:	2023.10.18-2023.10.18
Ambient Condition:	26.2 °C,47.2 %RH	Test Engineer:	Zoe
Equipment under Test	PORTABLE BLUETOOTH SPEAKER	Model No.:	GO4T
Sample Number	S23090801-07	Test Power Supply:	Battery

Test Mode	Antenna	Frequency [MHz]	Result [MHz]	Limit [MHz]	Verdict
DH5	Ant1	Hop	0.994	≥0.633	PASS
2DH5	Ant1	Hop	0.994	≥0.867	PASS

7.5. Test graphs



8. Dwell Time

8.1. Block diagram of test setup

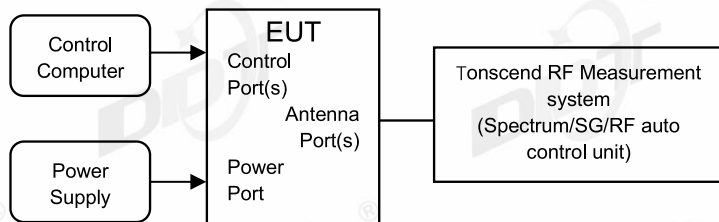

8.2. Limits

The average time of occupancy on any channel shall not be greater than 0.4 seconds within a period of 0.4 seconds multiplied by the number of hopping channels employed.

8.3. Test procedure

- (1) The test according to ANSI C63.10-2013 clause 7.8.4.
- (2) Connect EUT's antenna output to spectrum analyzer by RF cable, the path loss was compensated to the results.
- (3) Set the EUT as maximum power setting and enable the EUT transmit continuously.
- (4) Use the following spectrum analyzer settings for the maximum peak output power measurement:

RBW:	≤ channel spacing and where possible RBW should be set $\gg 1 / T$
VBW:	$VBW \geq RBW$.
Span:	Zero span, centered on a hopping channel.
Detector Mode:	Peak
Sweep time:	Auto
Trace mode:	Clear Write.

Measure and record the results in the report.

- (5) The test period: $T = 0.4 \text{ Second/Channel} \times 79 \text{ Channel} = 31.6 \text{ s}$
- (6) Measure the hopping number and on time of each pulse with spectrum analyzer in zero span set, and calculate dwell time with formula $\text{Dwell time} = \text{total hops} * \text{pulse's on time}$.

8.4. Test result

Test Site:	RF 2#	Test Date:	2023.10.18-2023.10.18
Ambient Condition:	26.2 °C,47.2 %RH	Test Engineer:	Zoe
Equipment under Test	PORTABLE BLUETOOTH SPEAKER	Model No.:	GO4T
Sample Number	S23090801-07	Test Power Supply:	Battery

Test Mode	Antenna	Frequency [MHz]	BurstWidth [ms]	TotalHops [Num]	Result[s]	Limit[s]	Verdict
DH1	Ant1	Hop	0.370	315	0.117	≤0.4	PASS
DH3	Ant1	Hop	1.650	157	0.259	≤0.4	PASS
DH5	Ant1	Hop	2.900	110	0.319	≤0.4	PASS
2DH1	Ant1	Hop	0.380	318	0.121	≤0.4	PASS
2DH3	Ant1	Hop	1.640	159	0.261	≤0.4	PASS
2DH5	Ant1	Hop	2.880	105	0.302	≤0.4	PASS

8.5. Test graphs

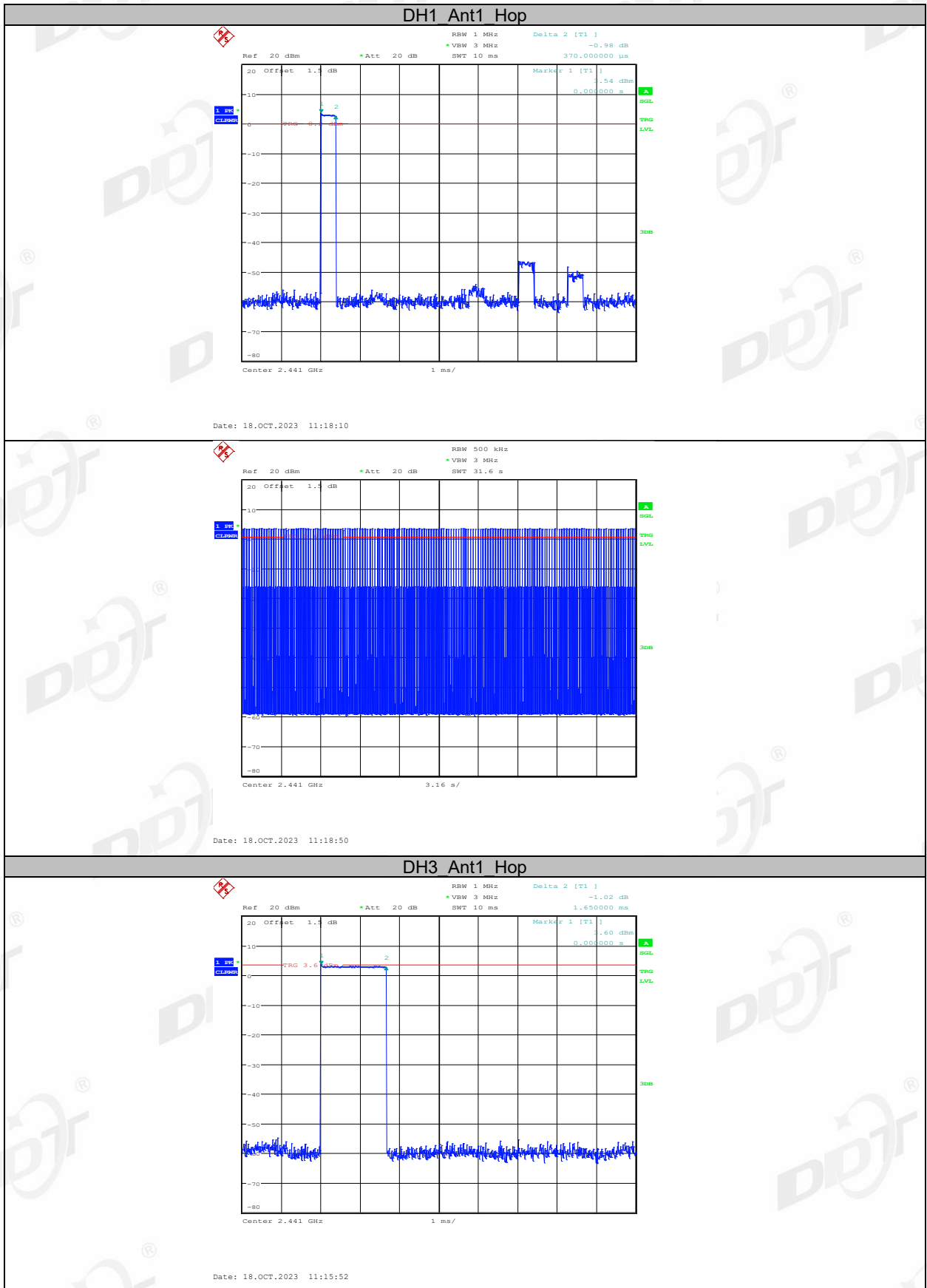

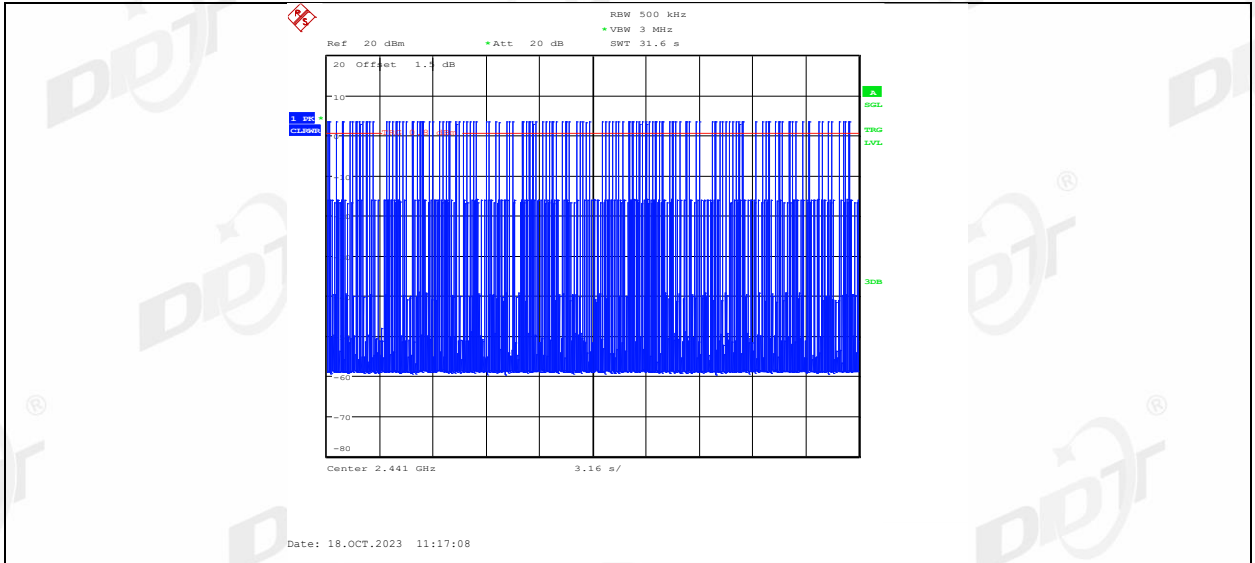

DH5_Ant1_Hop

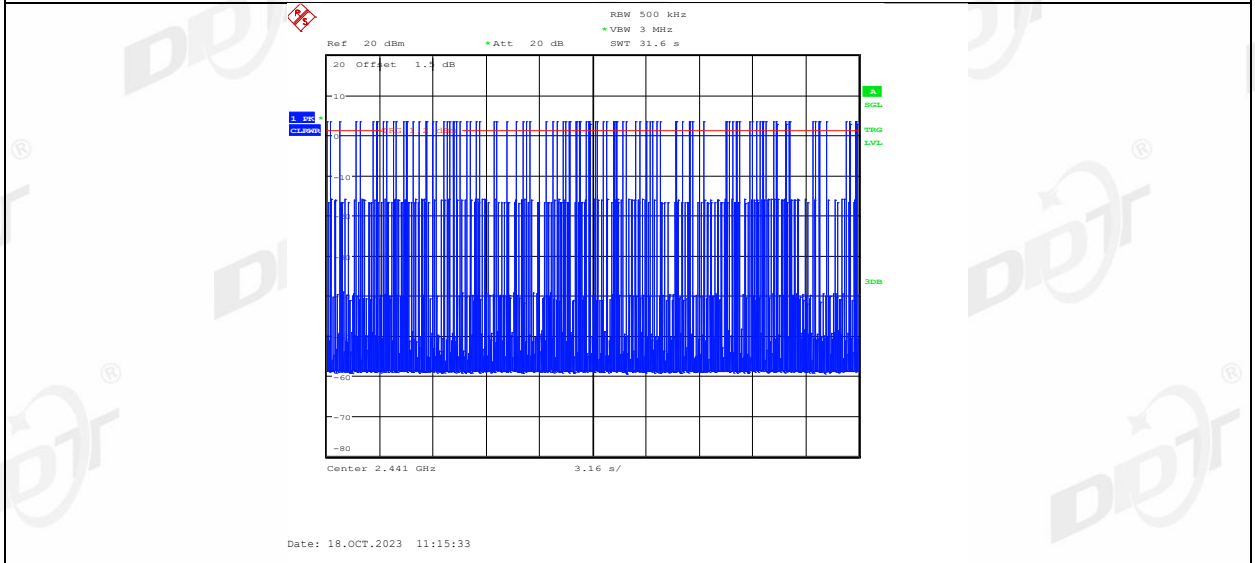
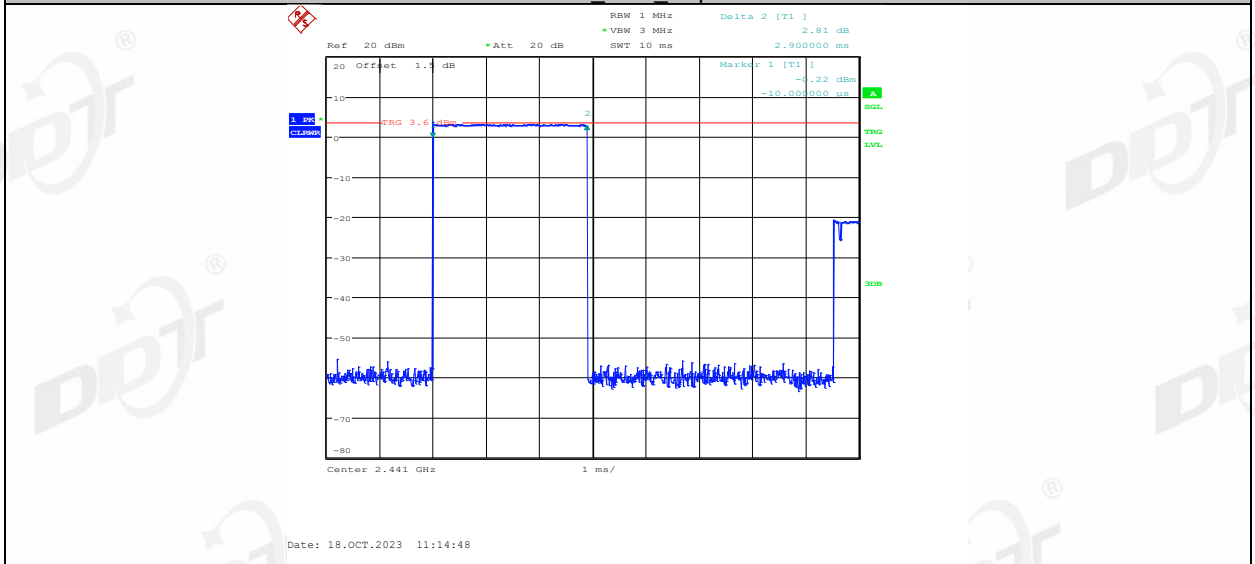

2DH1_Ant1_Hop

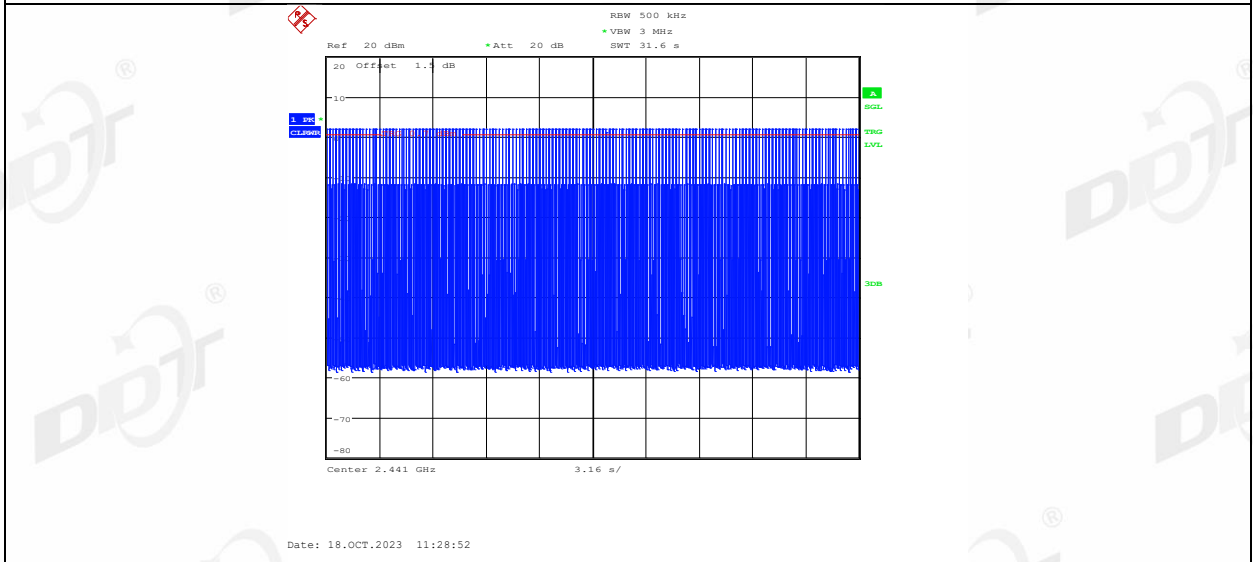
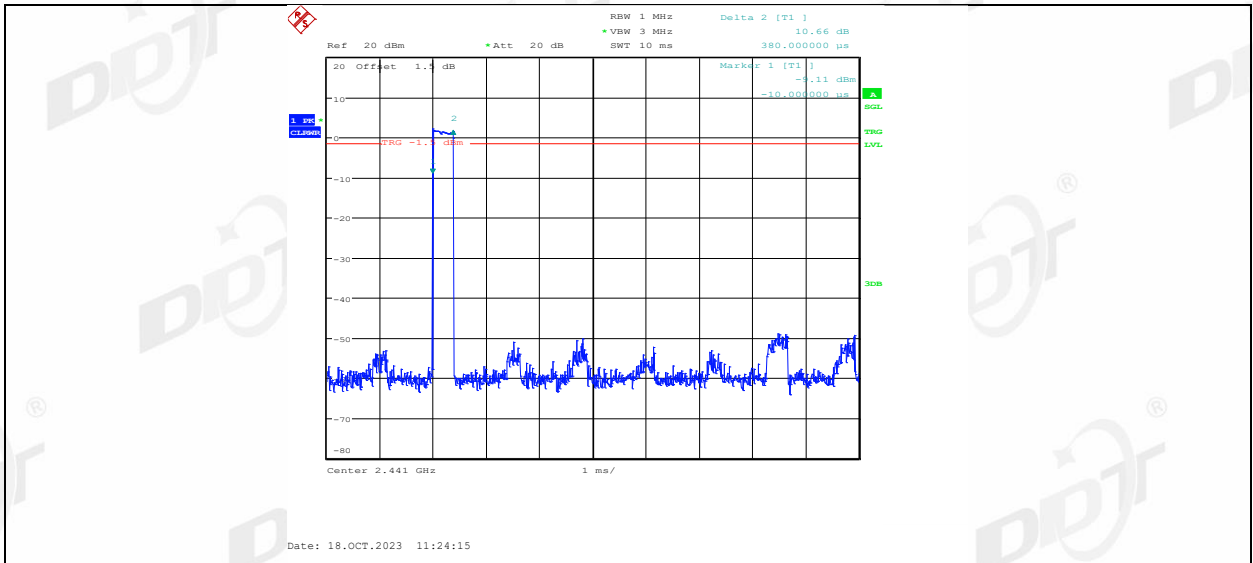

2DH3_Ant1_Hop

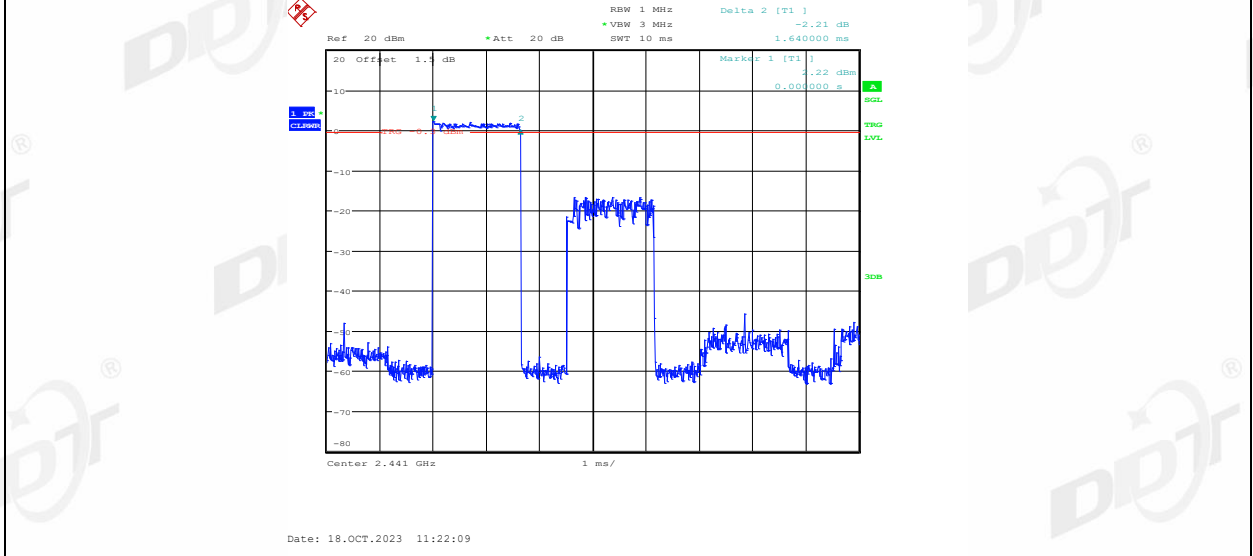

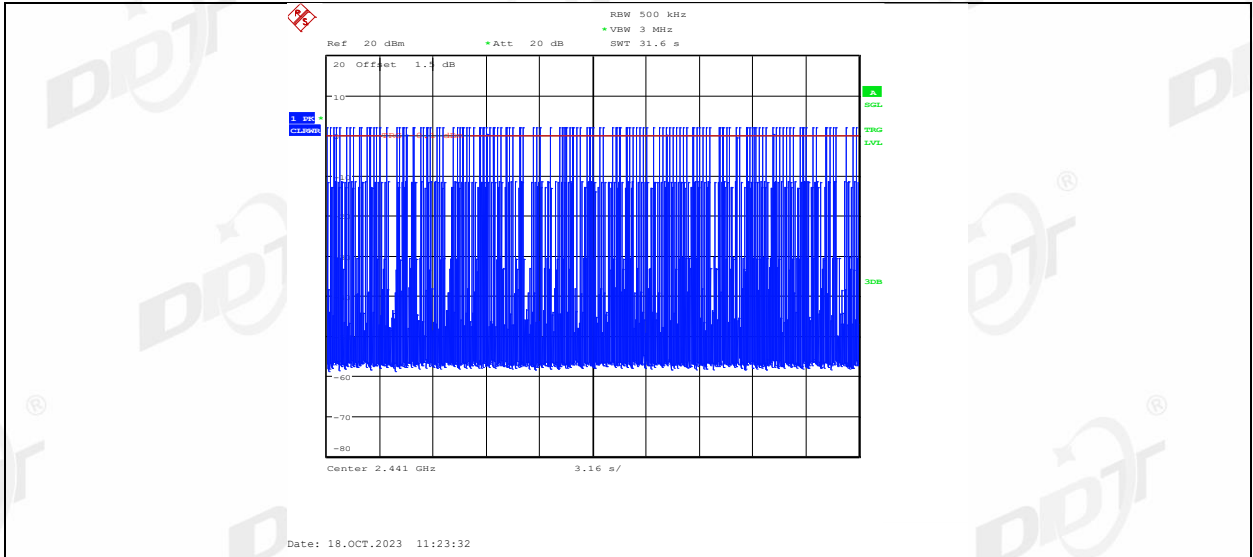

2DH5_Ant1_Hop

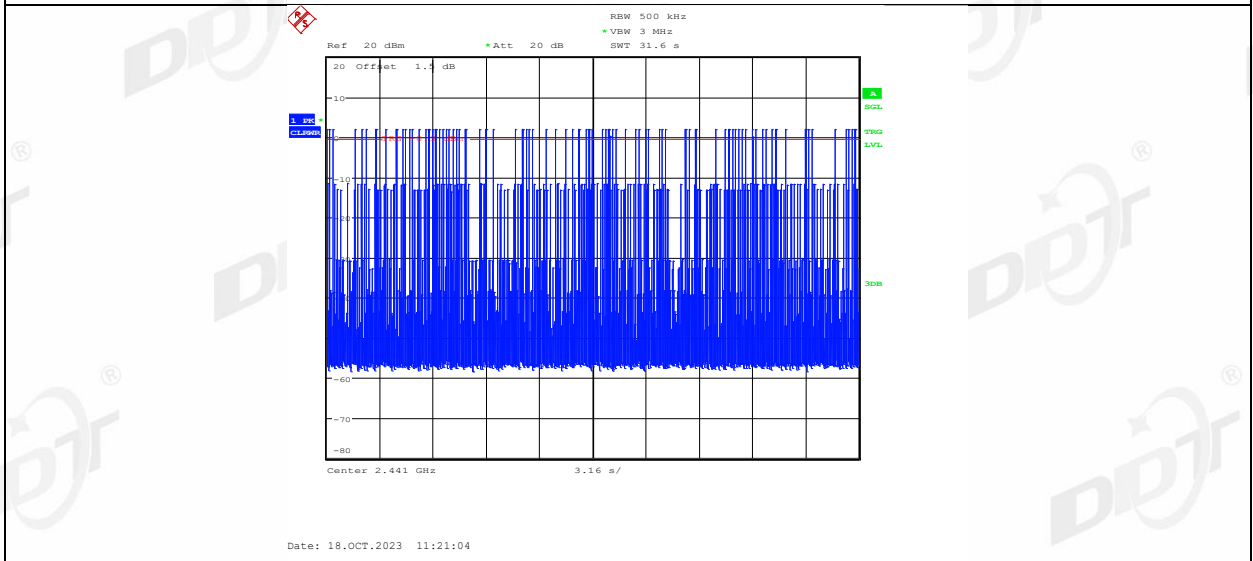
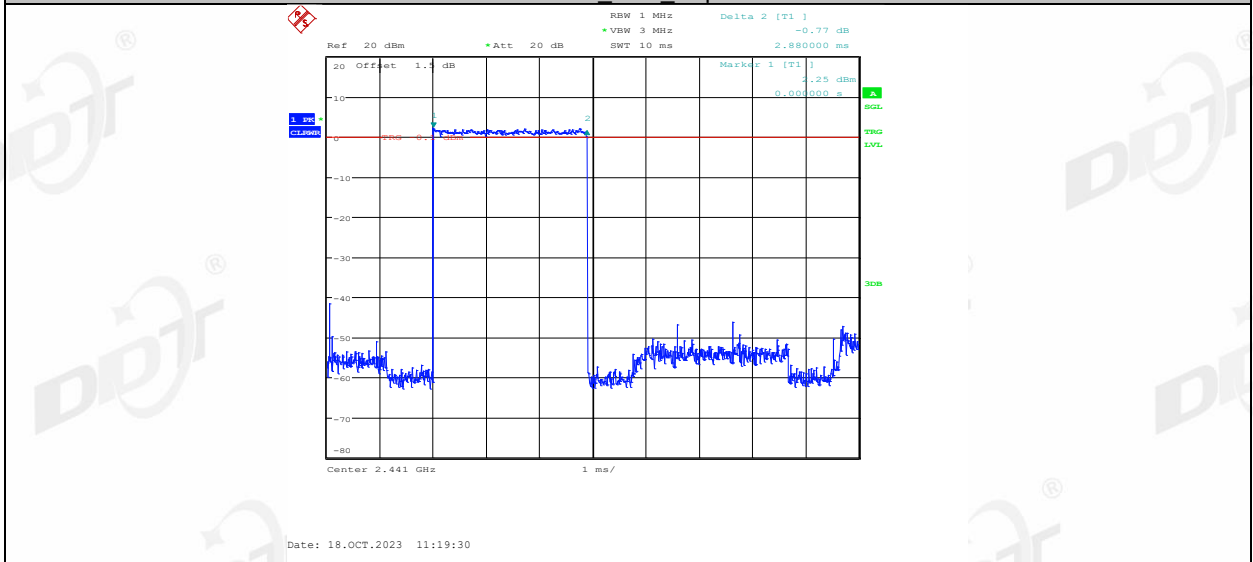

9. Number of Hopping Channel

9.1. Block diagram of test setup

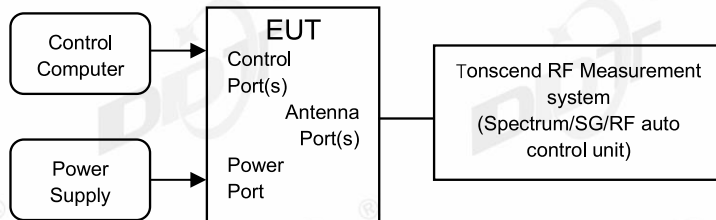

9.2. Limits

Frequency hopping systems in the 2400-2483.5 MHz band shall use at least 15 channels.

9.3. Test procedure

- (1) The test according to ANSI C63.10-2013 clause 7.8.3.
- (2) Connect EUT's antenna output to spectrum analyzer by RF cable, the path loss was compensated to the results.
- (3) Set the EUT as maximum power setting and enable the EUT transmit continuously.
- (4) Use the following spectrum analyzer settings for the maximum peak output power measurement:

RBW:	RBW to less than 30% of the channel spacing or the 20 dB bandwidth, whichever is smaller.
VBW:	VBW \geq RBW.
Span:	The frequency band of operation
Detector Mode:	Peak
Sweep time:	Auto
Trace mode:	Max hold

- (5) Measure and record the results in the report.
- (5) Measure the hopping number and record the results in the report.

9.4. Test result

Test Site:	RF 2#	Test Date:	2023.10.18-2023.10.18
Ambient Condition:	26.2 °C,47.2 %RH	Test Engineer:	Zoe
Equipment under Test	PORTABLE BLUETOOTH SPEAKER	Model No.:	GO4T
Sample Number	S23090801-07	Test Power Supply:	Battery

Test Mode	Antenna	Frequency [MHz]	Result [Num]	Limit [Num]	Verdict
DH5	Ant1	Hop	79	≥15	PASS
2DH5	Ant1	Hop	79	≥15	PASS

9.5. Test graphs

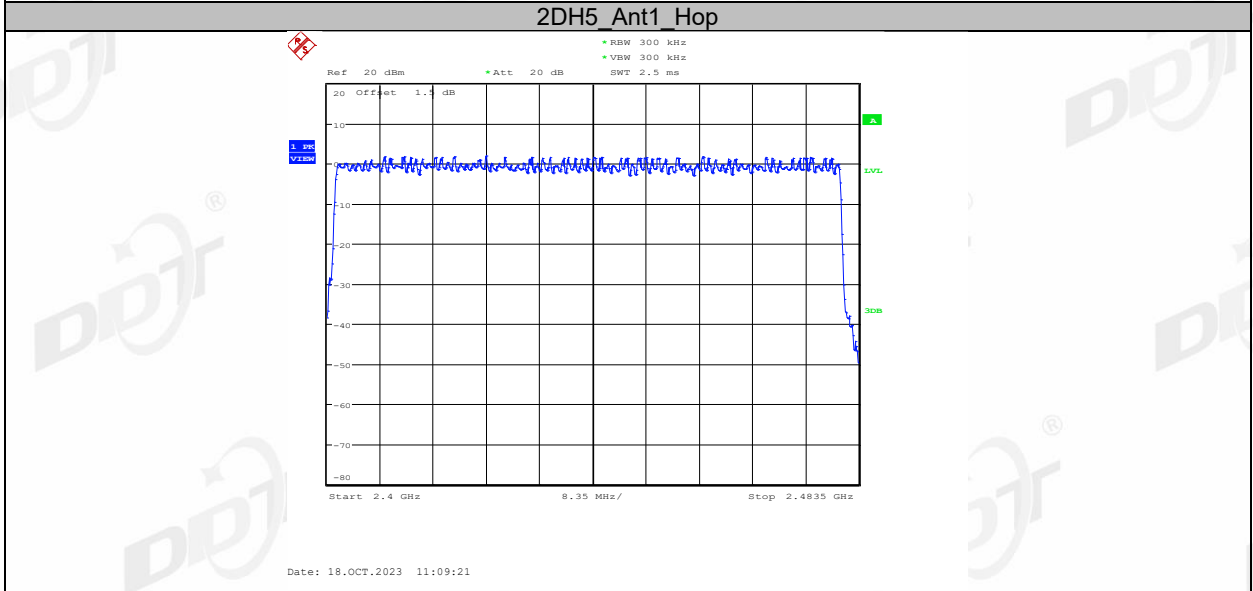
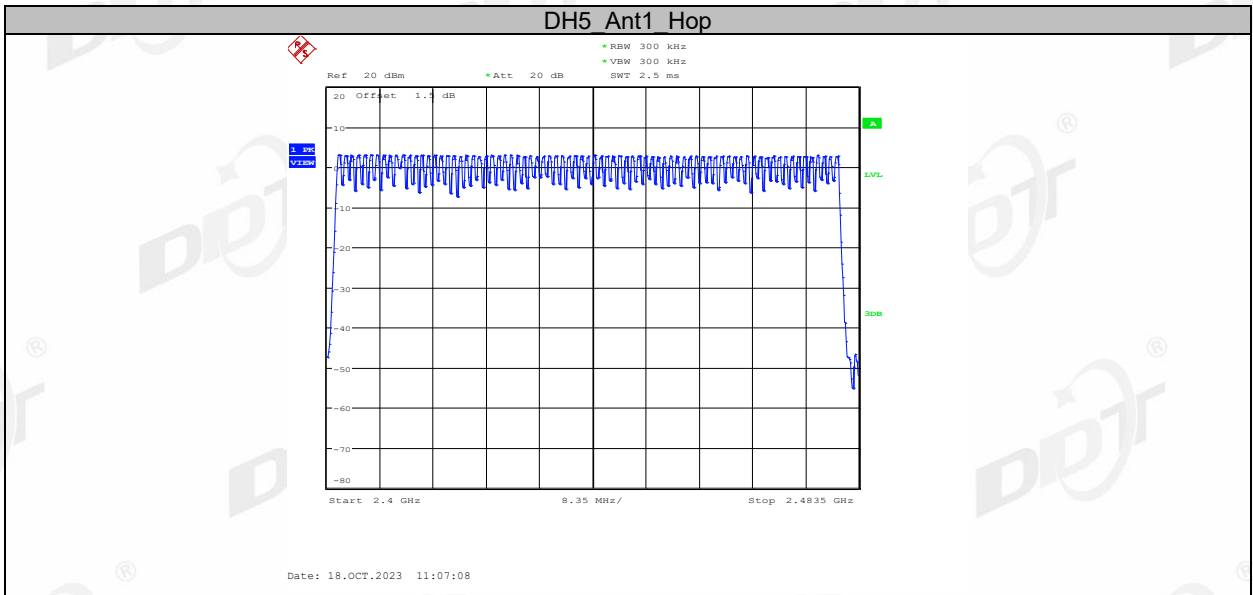

10. Band Edge Compliance (Conducted Method)

10.1. Block diagram of test setup

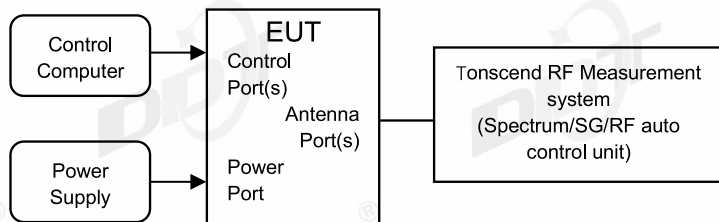

10.2. Limit

All restriction band should comply with 15.209, other emission should be at least 20dB below the fundamental.

10.3. Test procedure

- (1) Connect EUT's antenna output to spectrum analyzer by RF cable.
- (2) Establish a reference level by using the following procedure:

RBW:	100 kHz
VBW:	300 kHz
Span	Encompass frequency range to be measured
Detector Mode:	Peak
Sweep time:	Auto
Trace mode	Max hold

- (3) Allow the trace to stabilize, use the peak marker function to determine the maximum peak power level to establish the reference level.
- (4) Then mark the maximum amplitude of all unwanted emissions outside of the authorized frequency band.

10.4. Test result

Test Site:	RF 2#	Test Date:	2023.10.18-2023.10.18
Ambient Condition:	26.2 °C,47.2 %RH	Test Engineer:	Zoe
Equipment under Test	PORTABLE BLUETOOTH SPEAKER	Model No.:	GO4T
Sample Number	S23090801-07	Test Power Supply:	Battery

Mode	Freq. (MHz)	Verdict
GFSK	Hopping off 2402	Pass
	Hopping off 2480	Pass
	Hopping on	Pass
$\pi/4$ -DQPSK	Hopping off 2402	Pass
	Hopping off 2480	Pass
	Hopping on	Pass

10.5. Test graphs

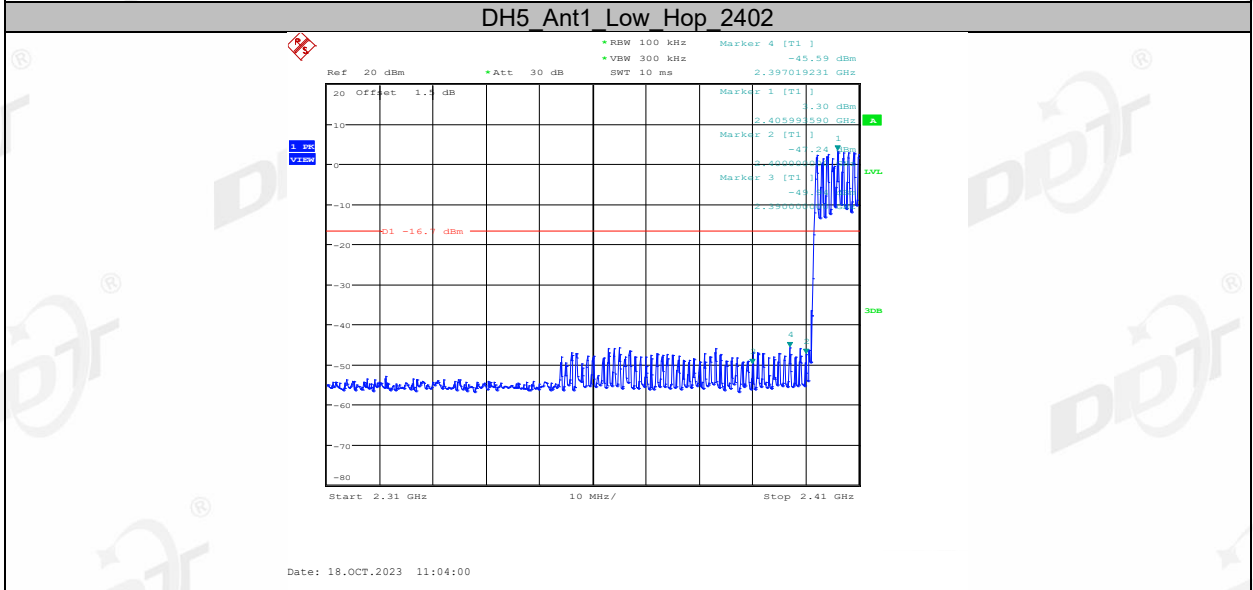
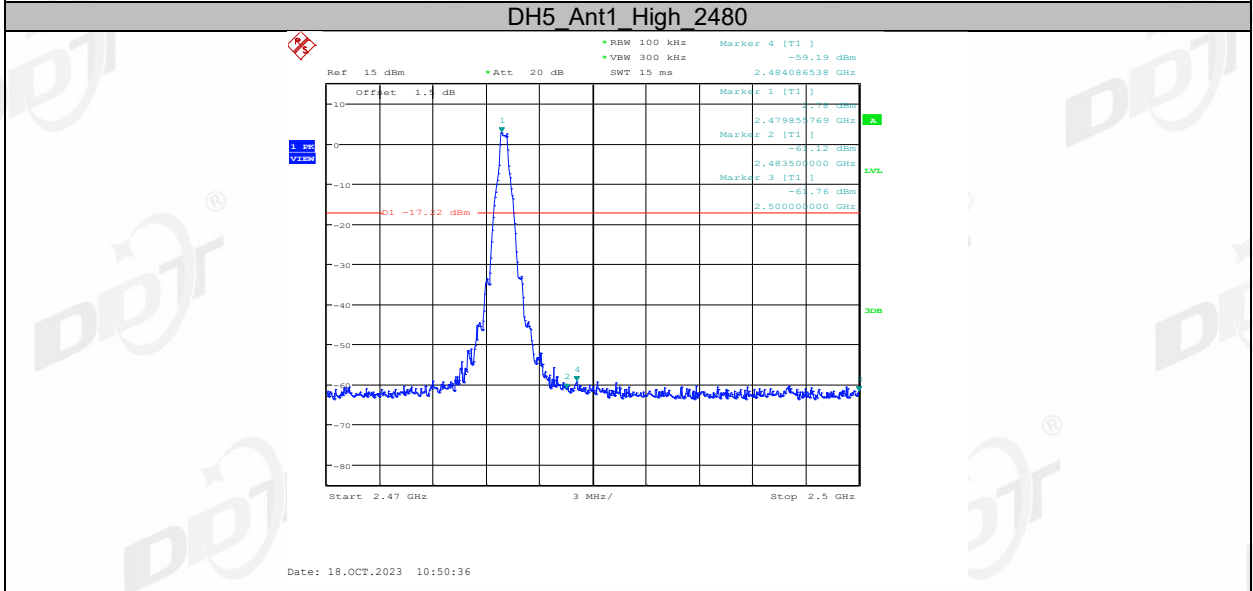
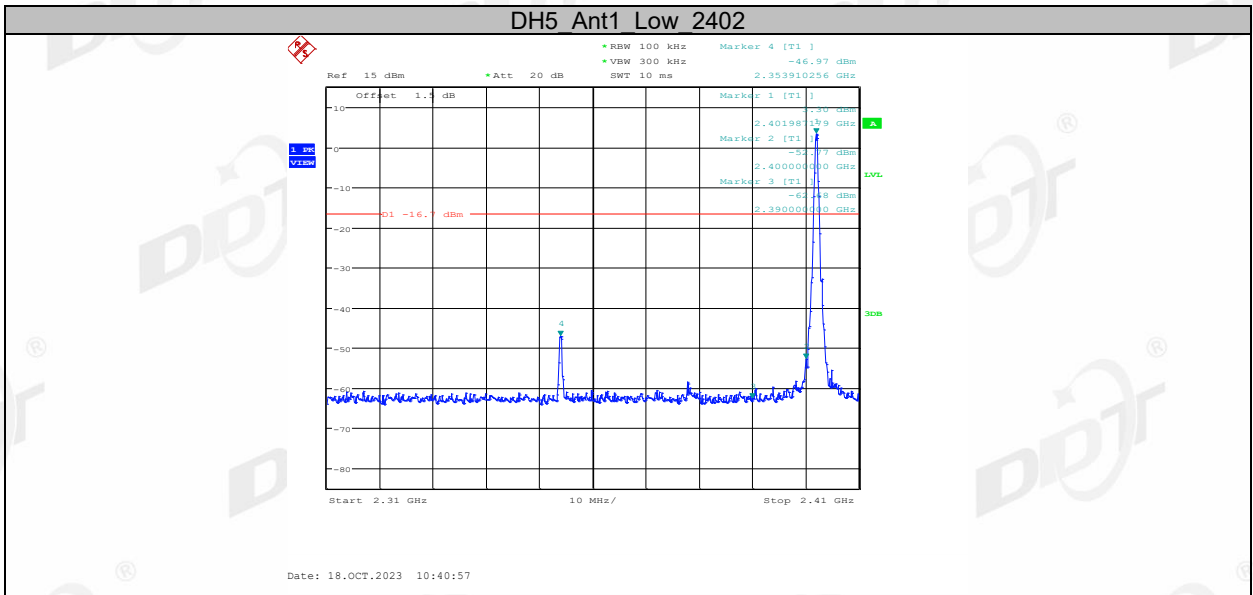

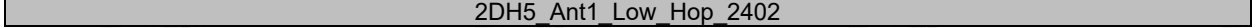
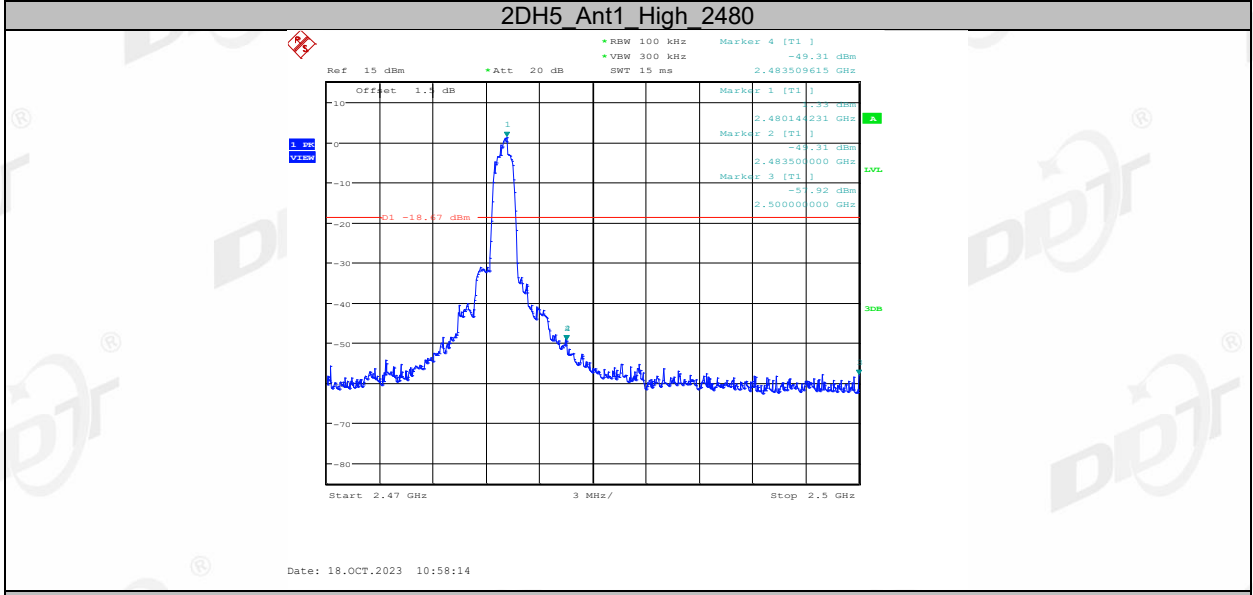
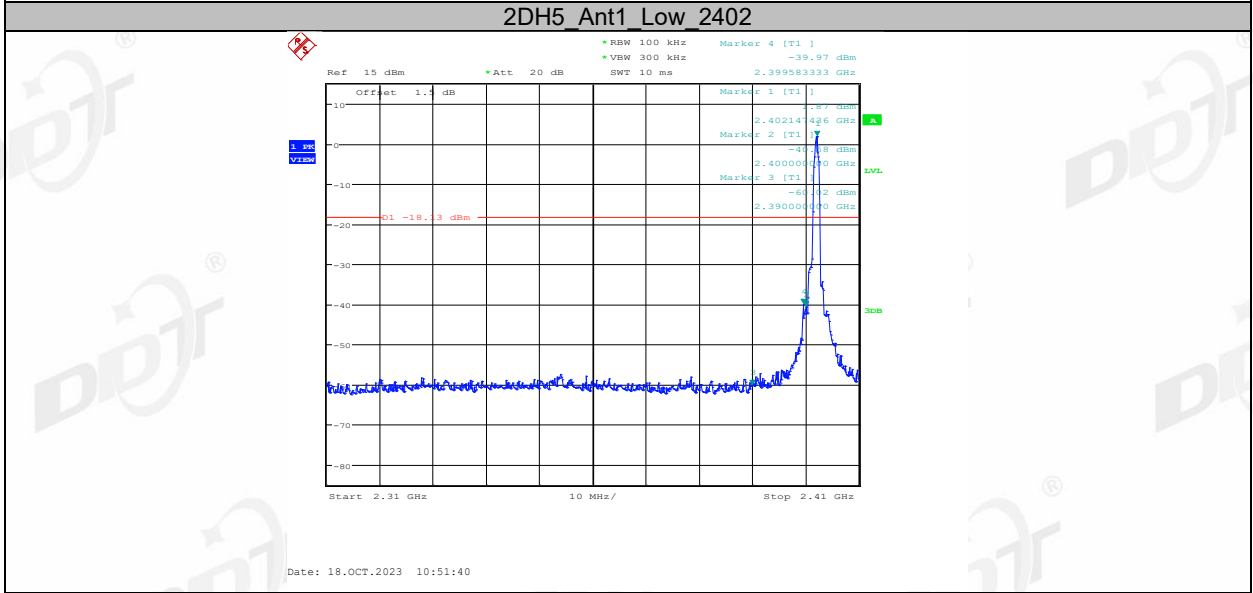
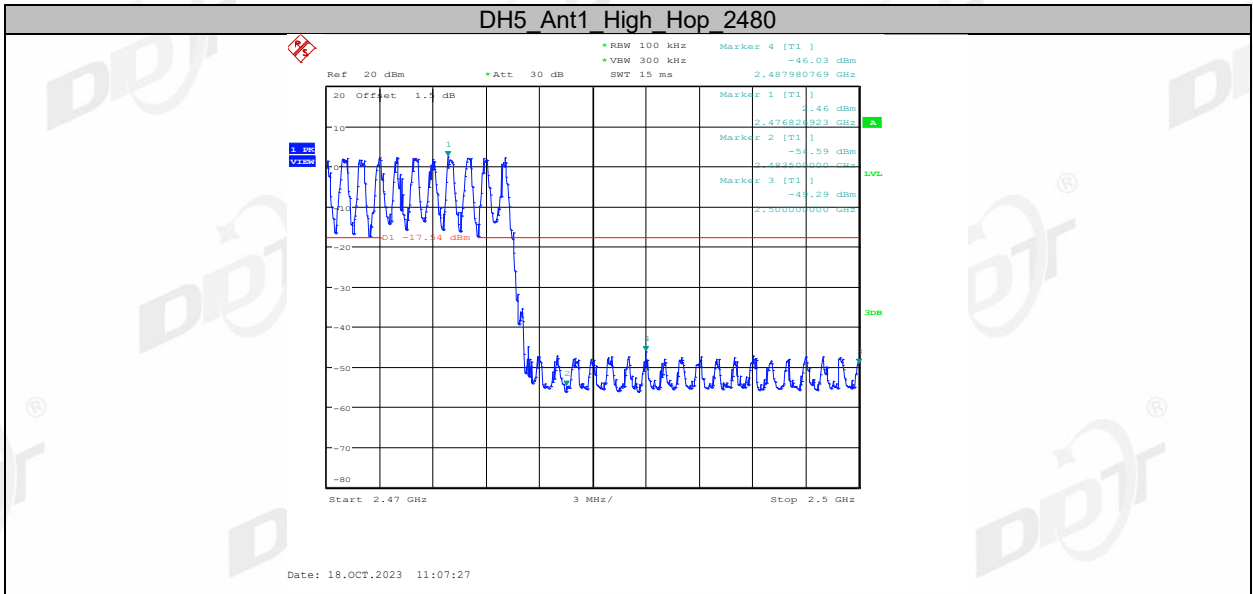

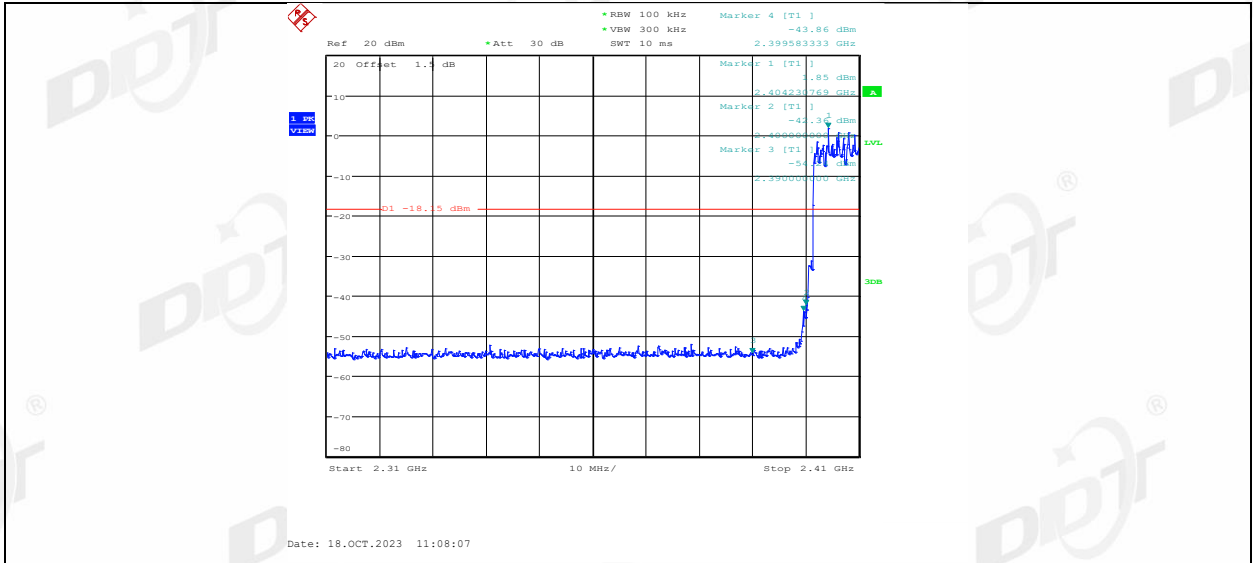

2DH5 Ant1 High Hop 2480

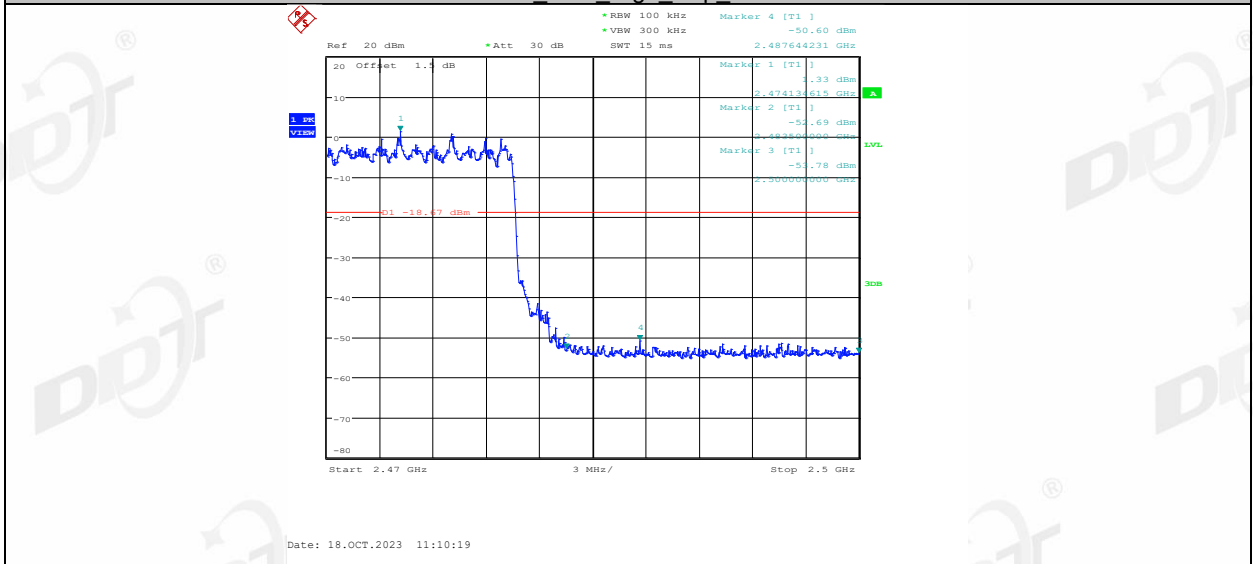

11. RF Conducted Spurious Emissions

11.1. Block diagram of test setup

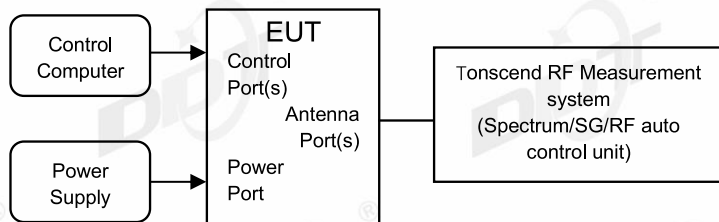

11.2. Limits

In any 100 kHz bandwidth outside the frequency bands in which the spread spectrum intentional radiator is operating, the radio frequency power that is produced by the intentional radiator shall be at least 20 dB below that in the 100 kHz bandwidth within the band that contains the highest level of the desired power.

11.3. Test procedure

- (1) Connect EUT's antenna output to spectrum analyzer by RF cable.
- (2) Establish a reference level by using the following procedure:

Center frequency	Test frequency
RBW:	100 kHz
VBW:	300 kHz
Span	Wide enough to capture the peak level of the in-band emission
Detector Mode:	Peak
Sweep time:	Auto
Trace mode	Max hold

- (3) Allow the trace to stabilize, use the peak marker function to determine the maximum peak power level to establish the reference level.
- (4) Set the spectrum analyzer as follows:

RBW:	100 kHz
VBW:	300 kHz
Span	Encompass frequency range to be measured
Number of measurement points	$\geq \text{Span}/\text{RBW}$
Detector Mode:	Peak
Sweep time:	Auto
Trace mode	Max hold

Allow the trace to stabilize, use the peak marker function to determine the maximum amplitude of all unwanted emissions outside of the authorized frequency band

11.4. Test result

Test Site:	RF 2#	Test Date:	2023.10.18-2023.10.18
Ambient Condition:	26.2 °C,47.2 %RH	Test Engineer:	Zoe
Equipment under Test	PORTABLE BLUETOOTH SPEAKER	Model No.:	GO4T
Sample Number:	#samplenumbr	Test Power Supply:	Battery

Mode	Freq. (MHz)	Verdict
GFSK	Hopping off 2402	Pass
	Hopping off 2441	Pass
	Hopping off 2480	Pass
$\pi/4$ -DQPSK	Hopping off 2402	Pass
	Hopping off 2441	Pass
	Hopping off 2480	Pass

11.5. Test graphs

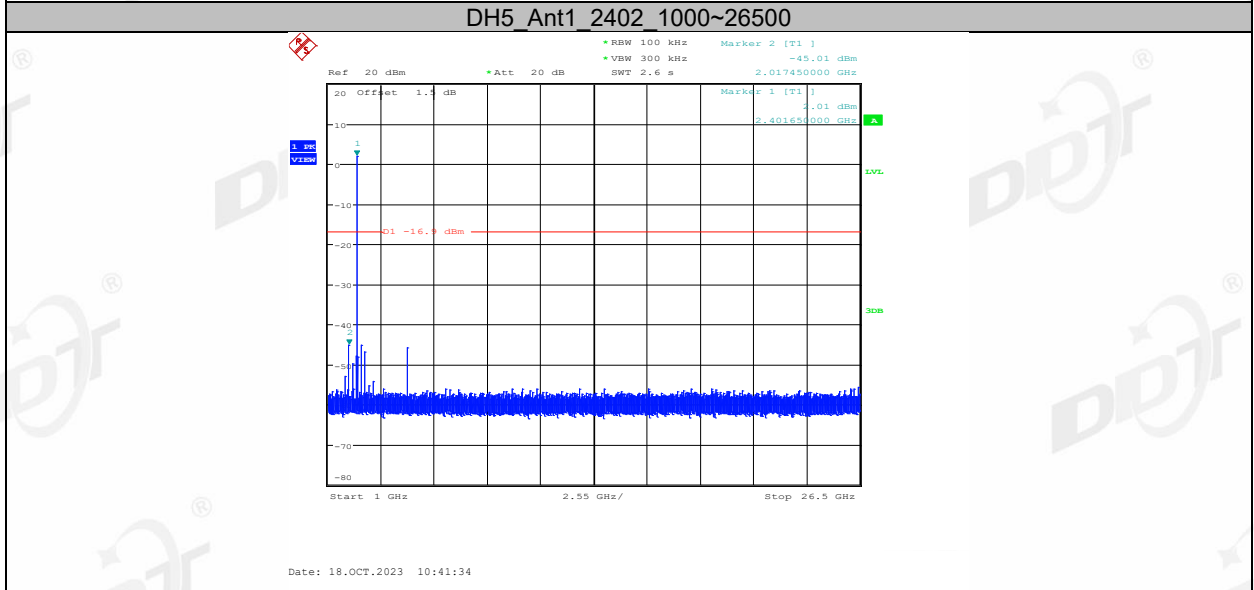
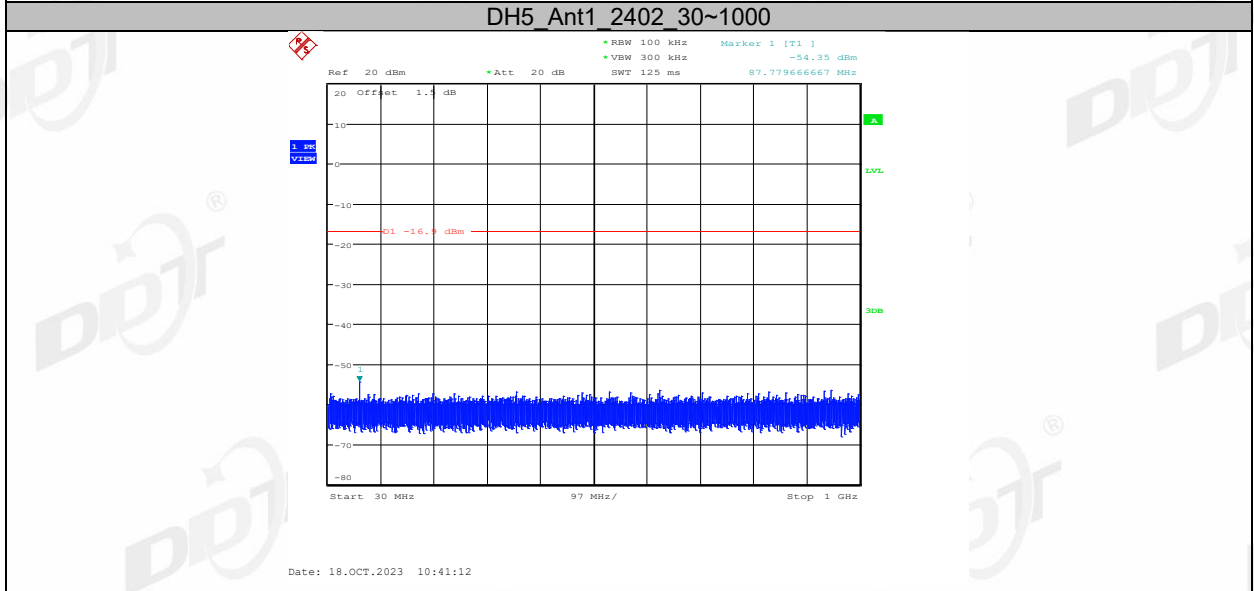
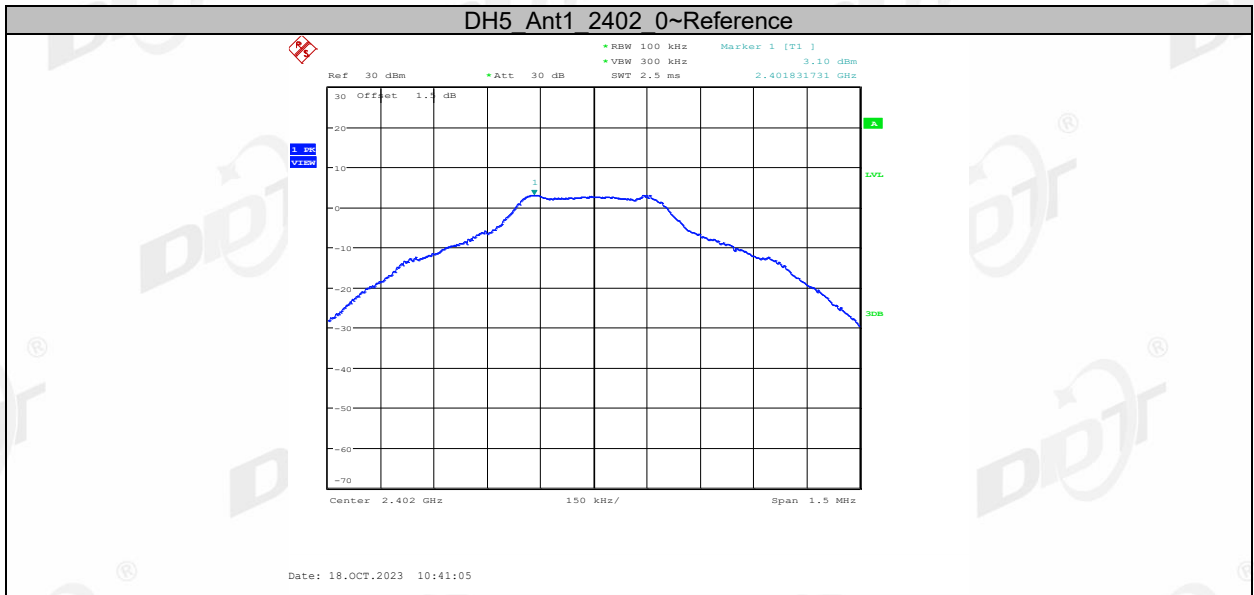

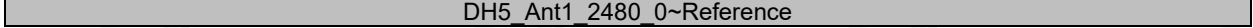
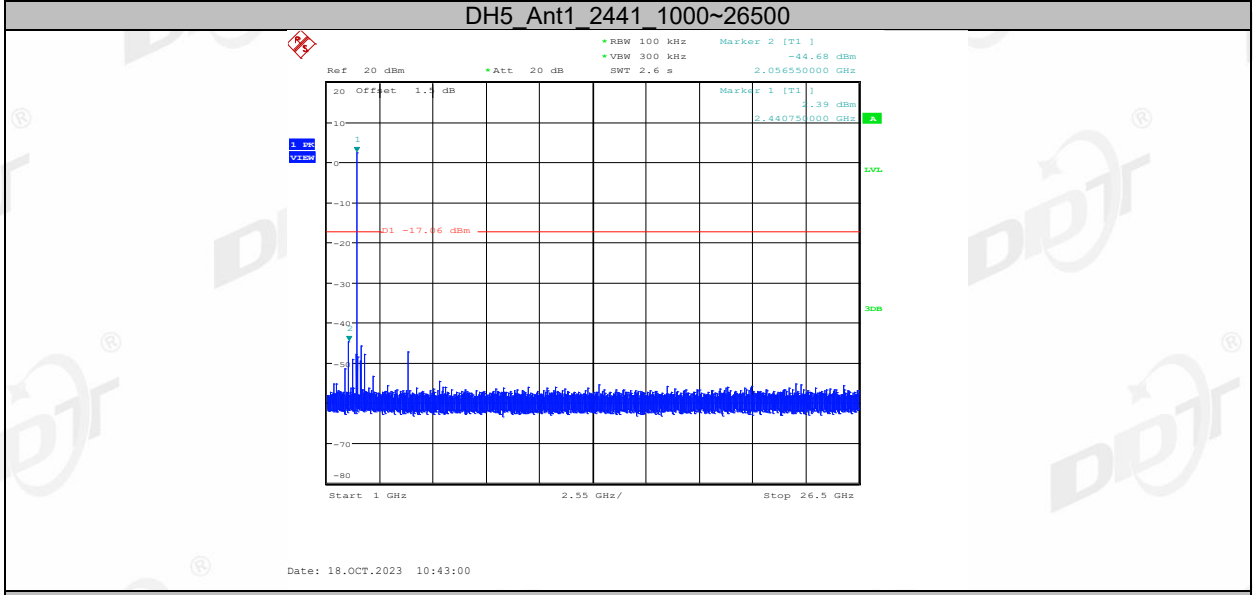
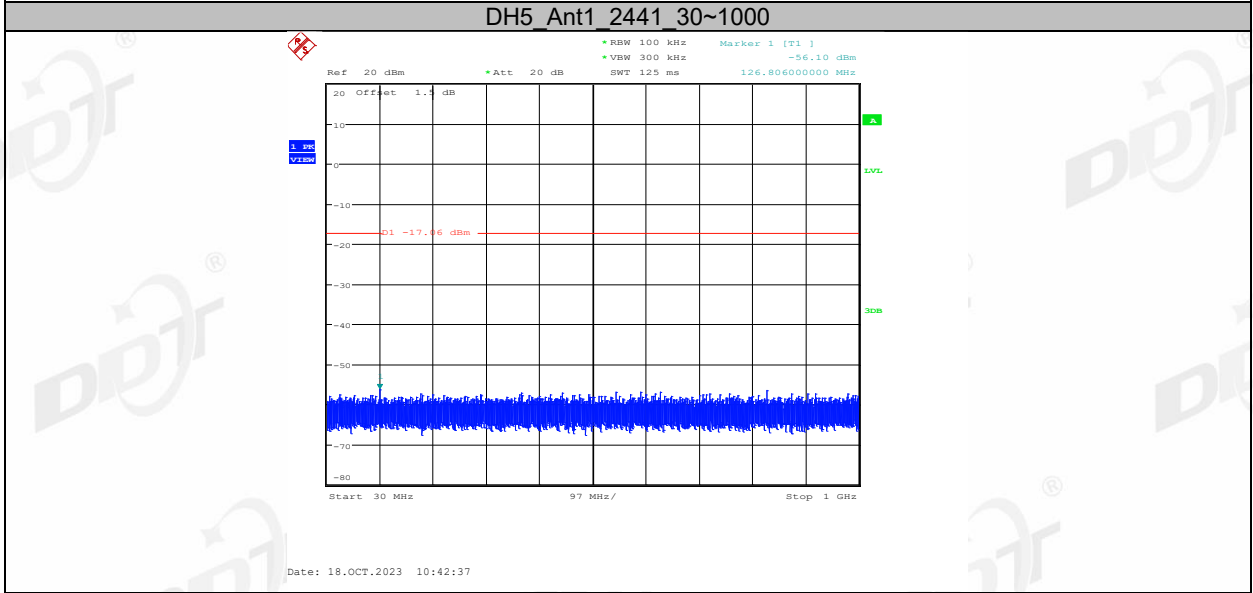
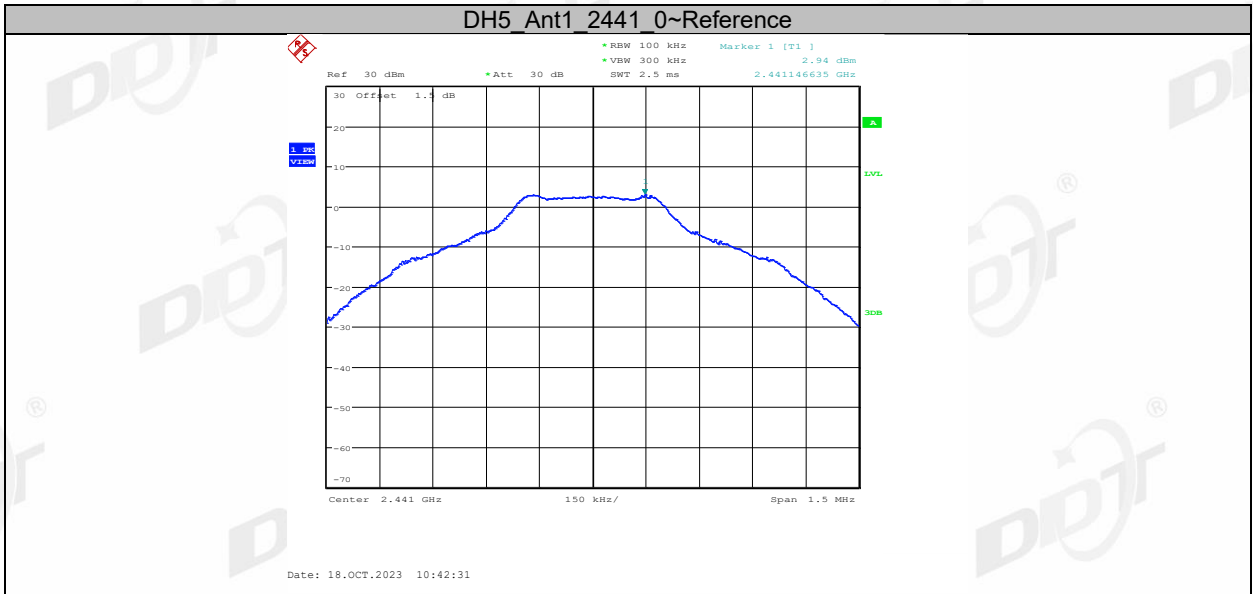

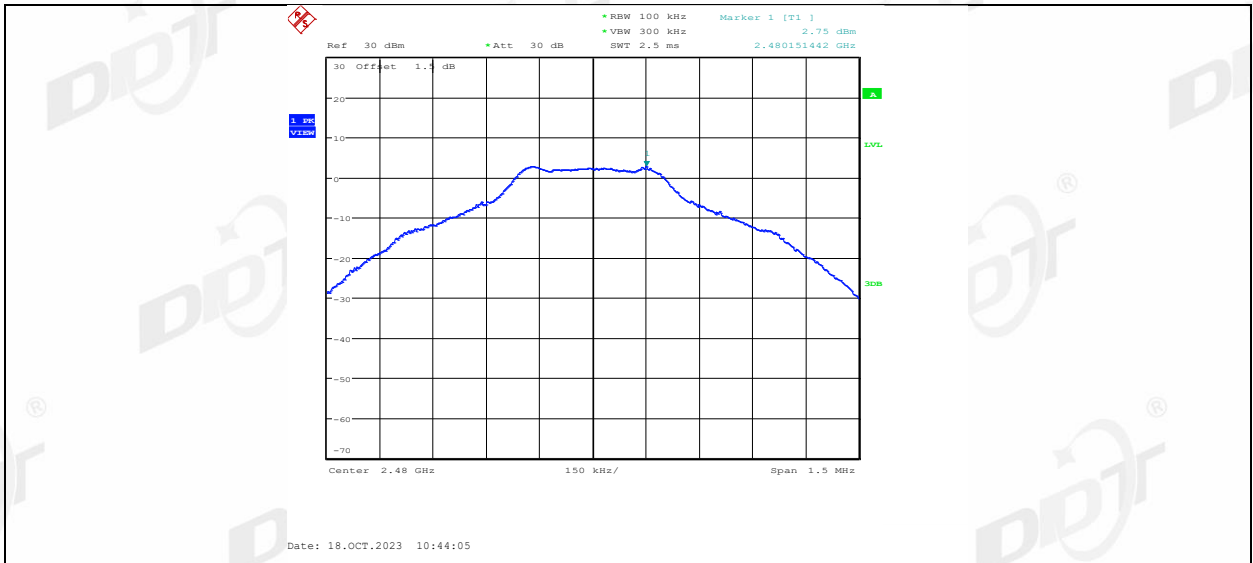

DH5_Ant1_2480_30~1000

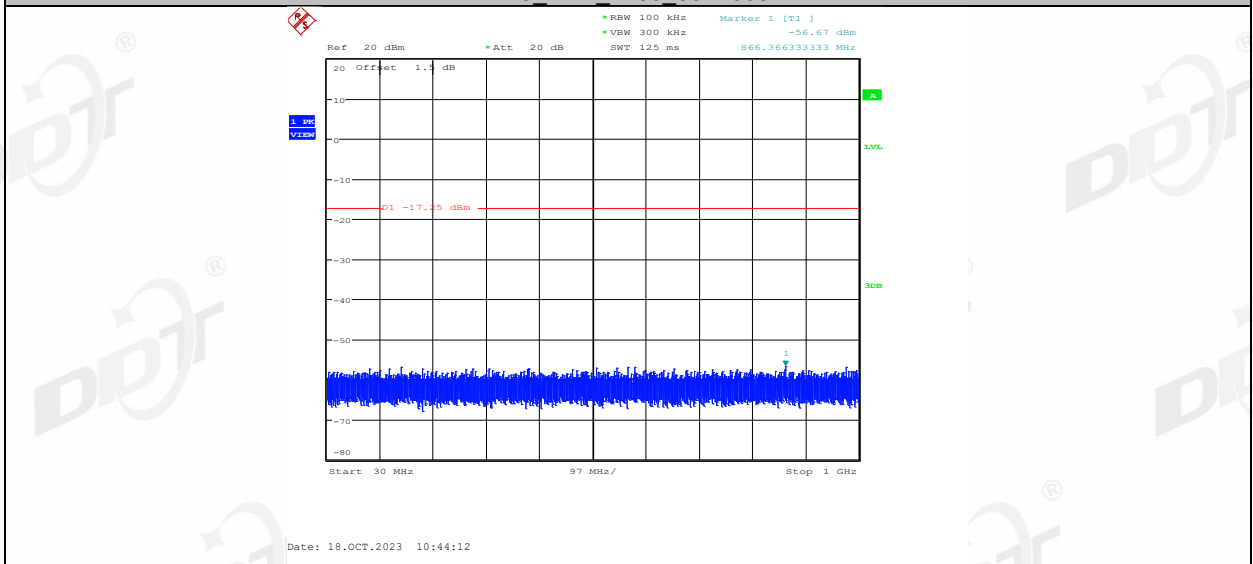

DH5_Ant1_2480_1000~26500

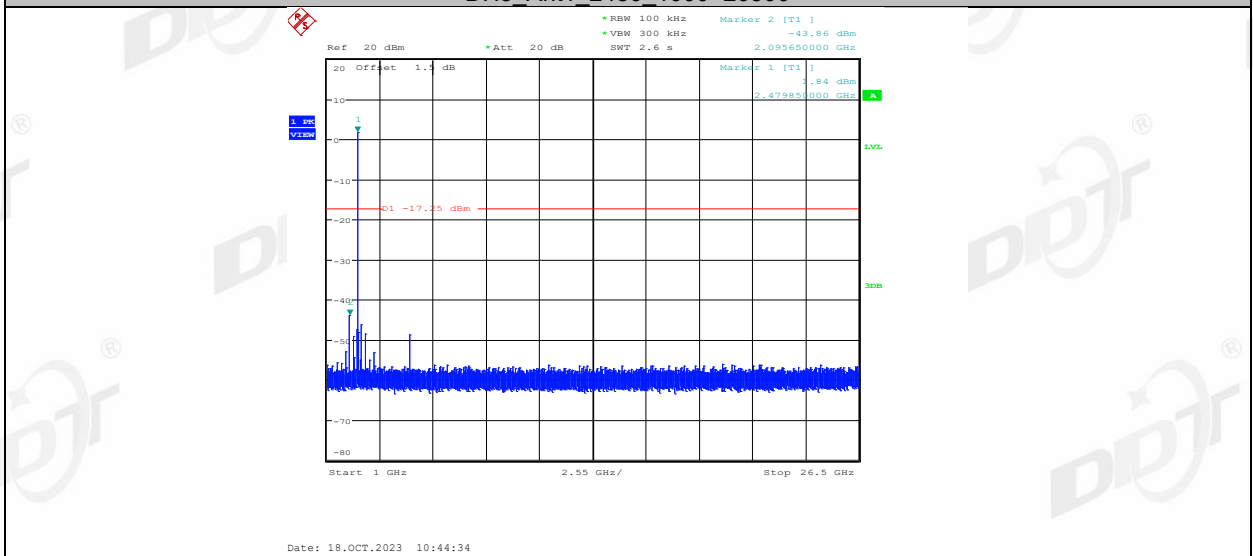

2DH5_Ant1_2402_0~Reference

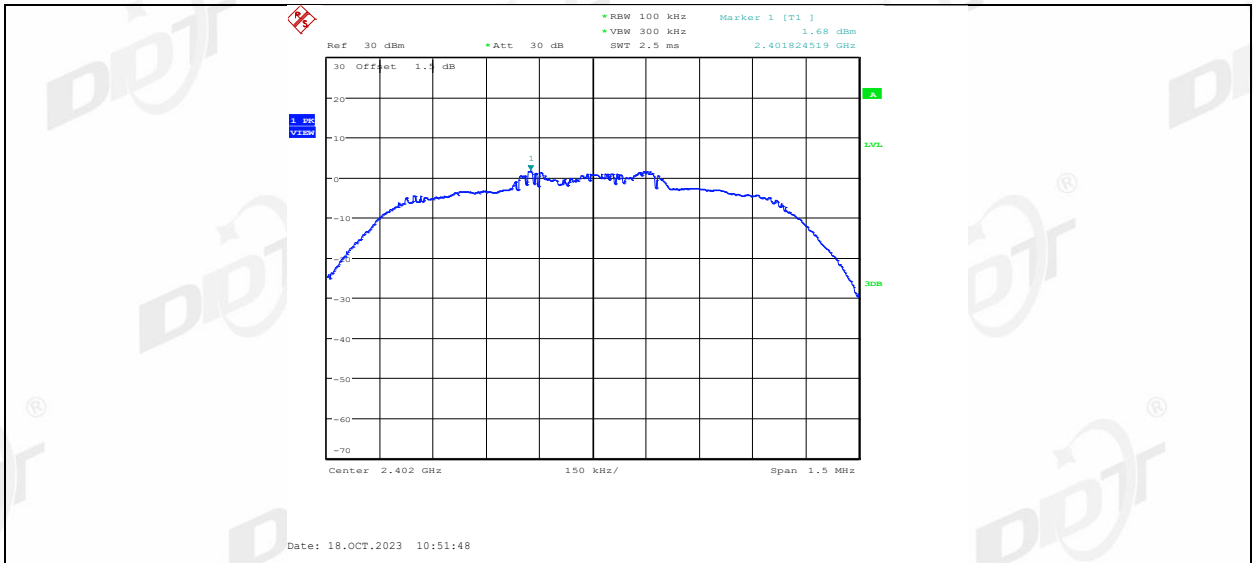

2DH5_Ant1_2402_30~1000

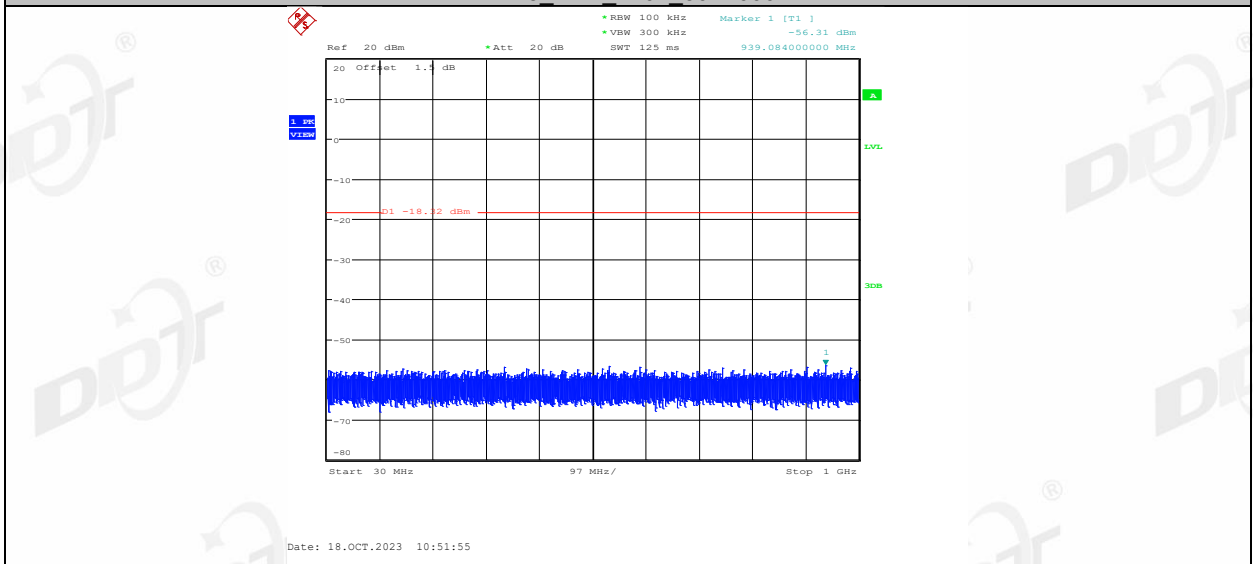

2DH5_Ant1_2402_1000~26500

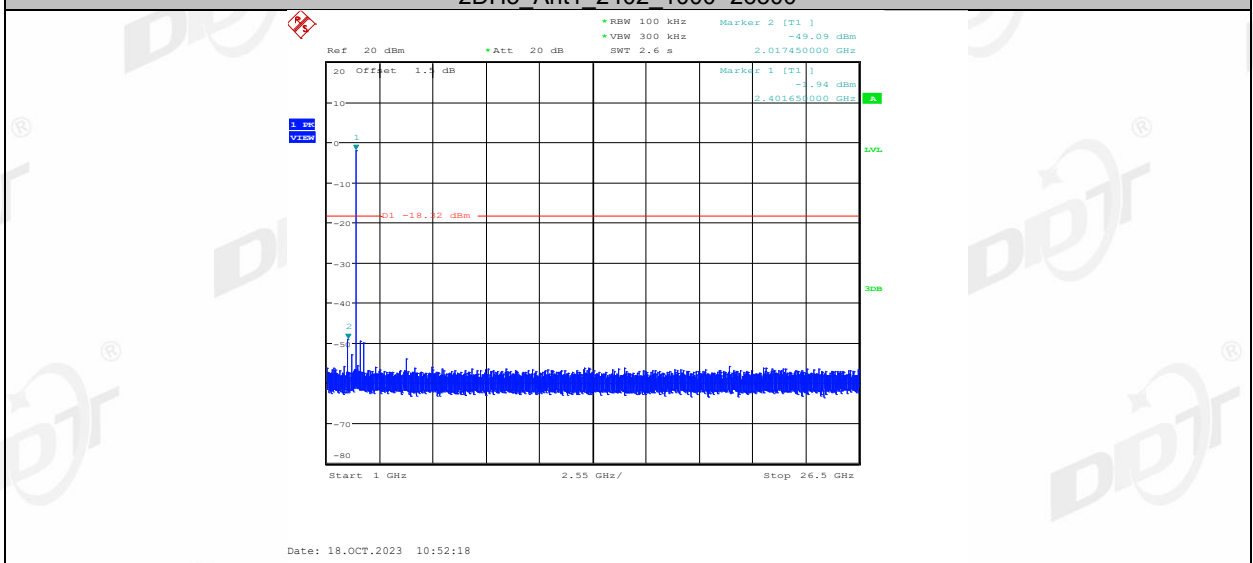

2DH5_Ant1_2441_0~Reference

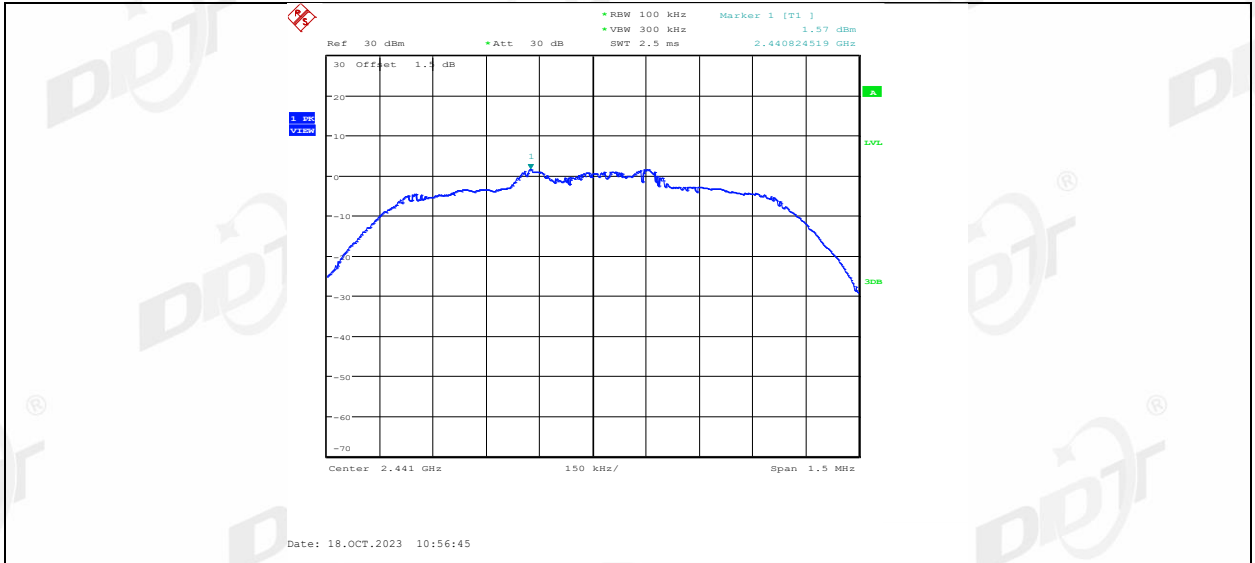

2DH5 Ant1 2441 30~1000

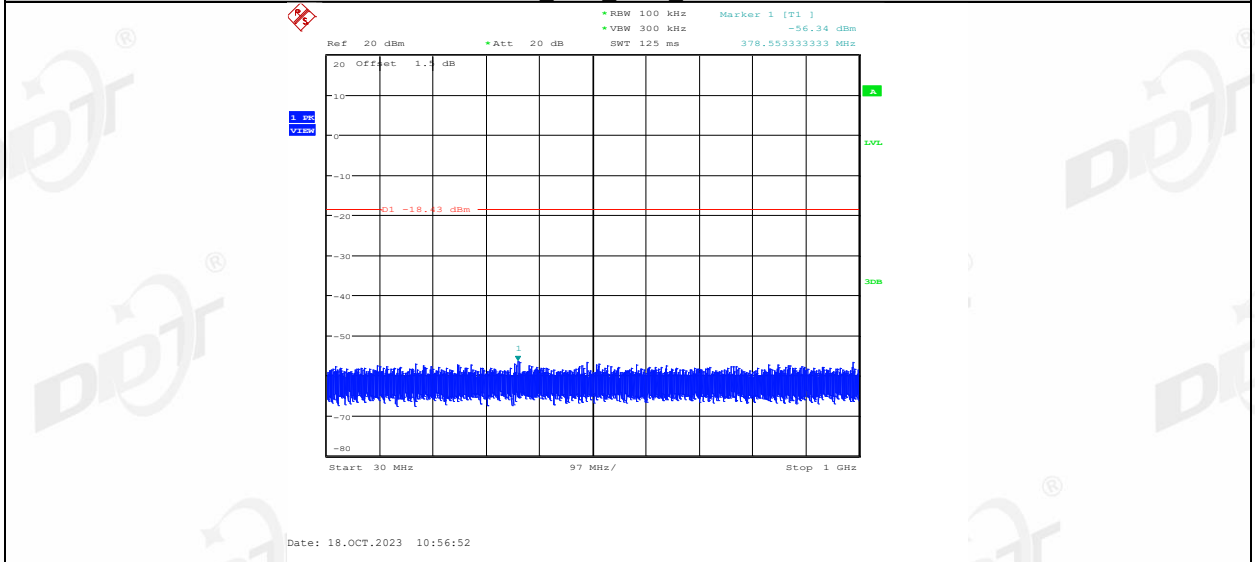

2DH5 Ant1 2441 1000~26500

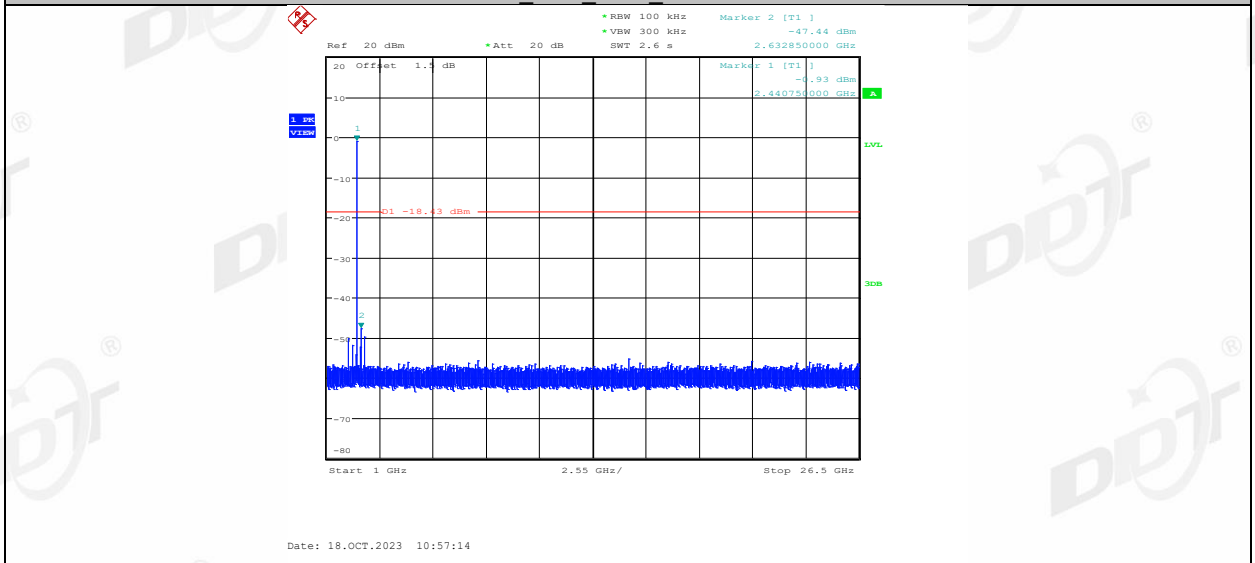

2DH5 Ant1 2480 0~Reference

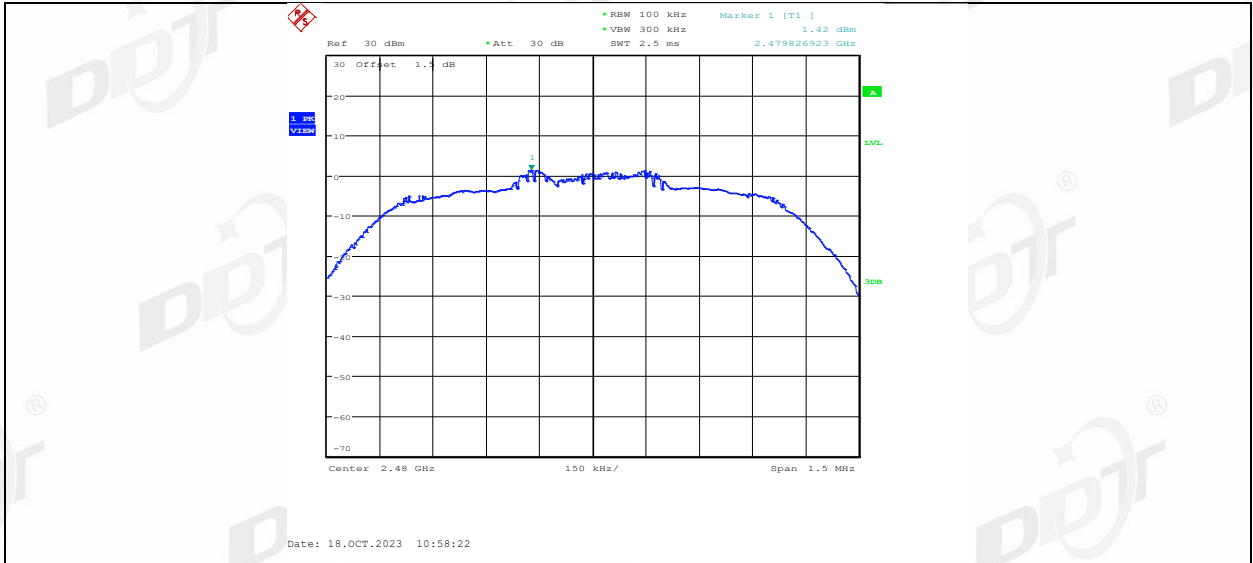

2DH5 Ant1 2480 30~1000

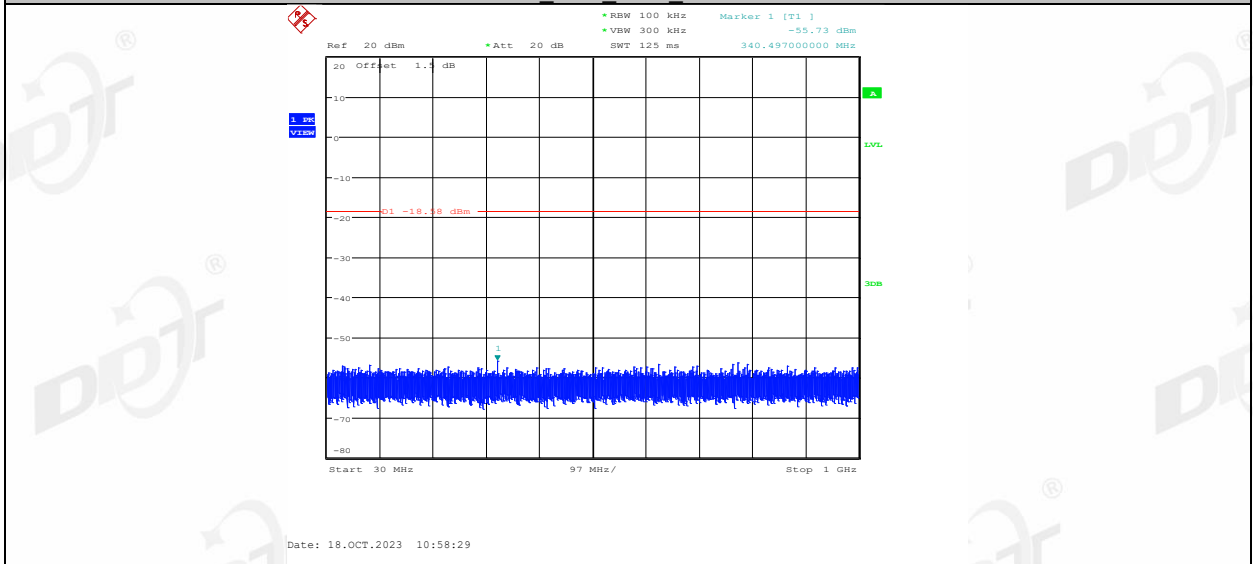

2DH5 Ant1 2480 1000~26500

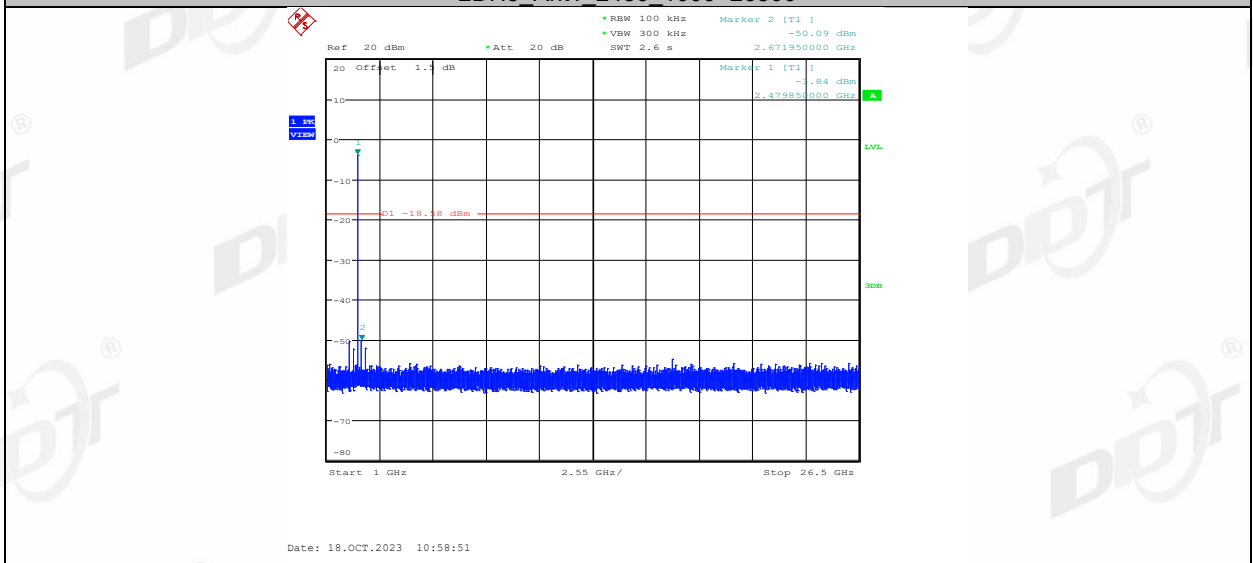

12. Duty cycle

12.1. Block diagram of test setup

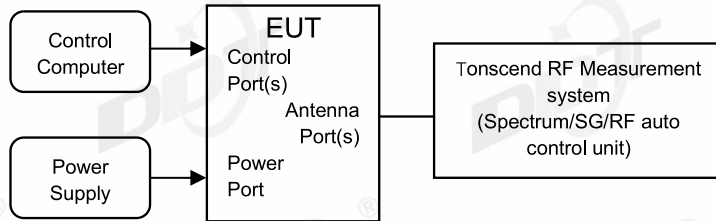

12.2. Limit

Just for Report.

12.3. Test procedure

- (1) Connected the EUT's antenna port to the Spectrum Analyzer by suitable attenuator, The cable loss and attenuator loss have been put into spectrum analyzer as amplitude offset.

set the Spectrum Analyzer as below:

Centre Frequency: The centre frequency of the middle hopping channel.

Resolution BW: 10 MHz.

Video BW: 10 MHz.

Span: Zero span.

Detector: Peak.

Trace Mode: Clear Write.

Sweep: Video Trigger

- (2) When the trace is complete, measure the sending time of 1 burst and the duty cycle of 1 burst cycle.

- (3) Calculate dwell time follow below formula:

Duty cycle= Pulse's on time / Burst cycle

12.4. Test result

Test Site:	RF 2#	Test Date:	2023.10.18-2023.10.18
Ambient Condition:	26.2 °C,47.2 %RH	Test Engineer:	Zoe
Equipment under Test	PORTABLE BLUETOOTH SPEAKER	Model No.:	GO4T
Sample Number	S23090801-07	Test Power Supply:	Battery

Test Mode	Antenna	Frequency [MHz]	ON Time [ms]	Period [ms]	Duty Cycle [%]	Duty Cycle Factor[dB]
DH5	Ant1	2402	2.92	3.76	77.66	1.10
		2441	2.92	3.76	77.66	1.10
		2480	2.91	3.76	77.39	1.11
2DH5	Ant1	2402	2.90	3.76	77.13	1.13
		2441	2.91	3.76	77.39	1.11
		2480	2.90	3.76	77.13	1.13

12.5. Test graphs

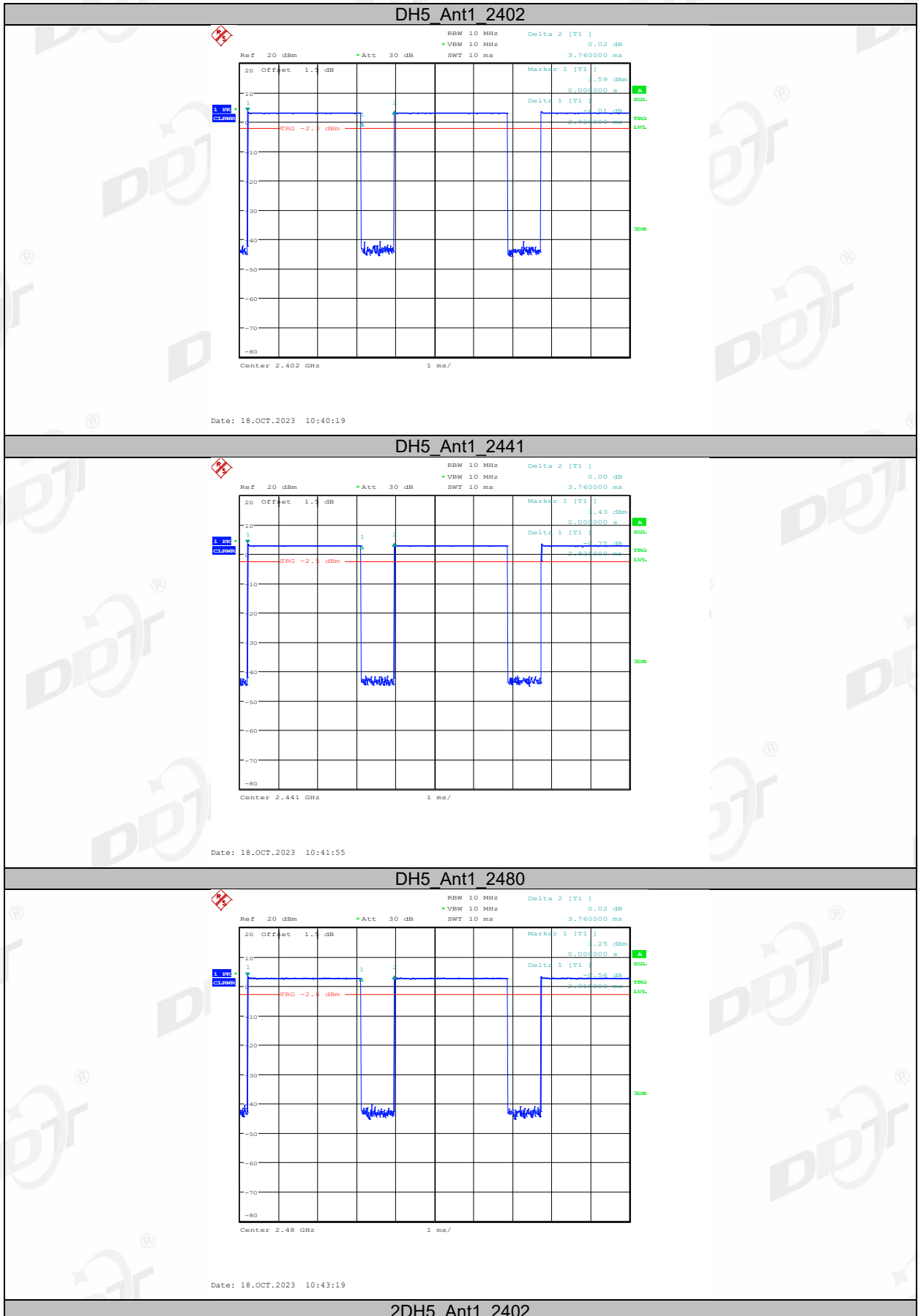

2DH5_Ant1_2402

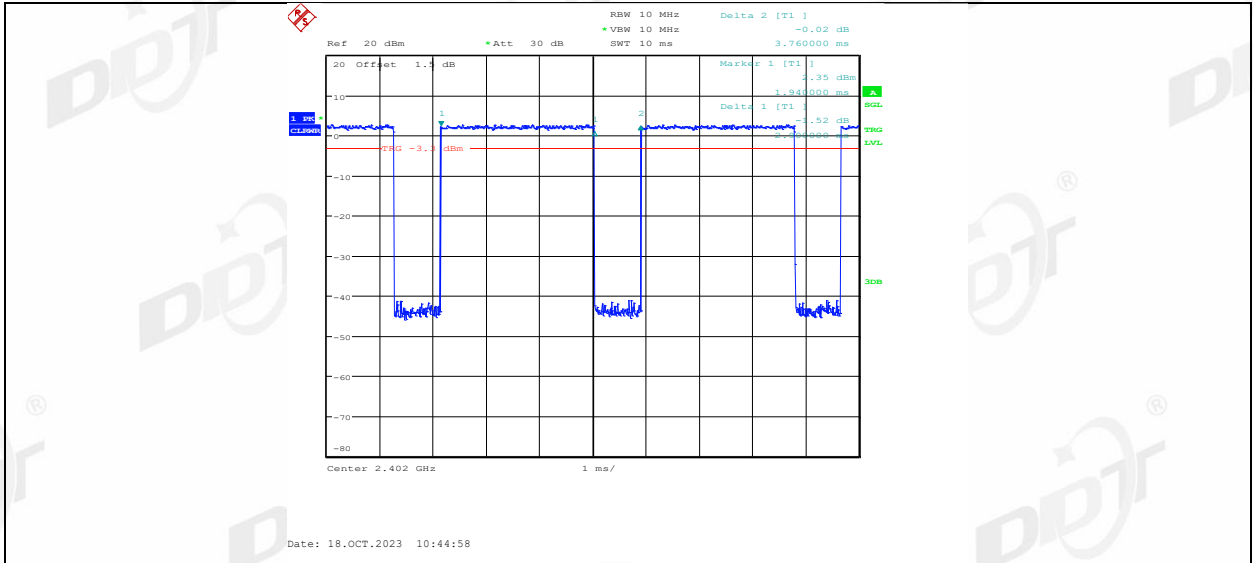

2DH5_Ant1_2441

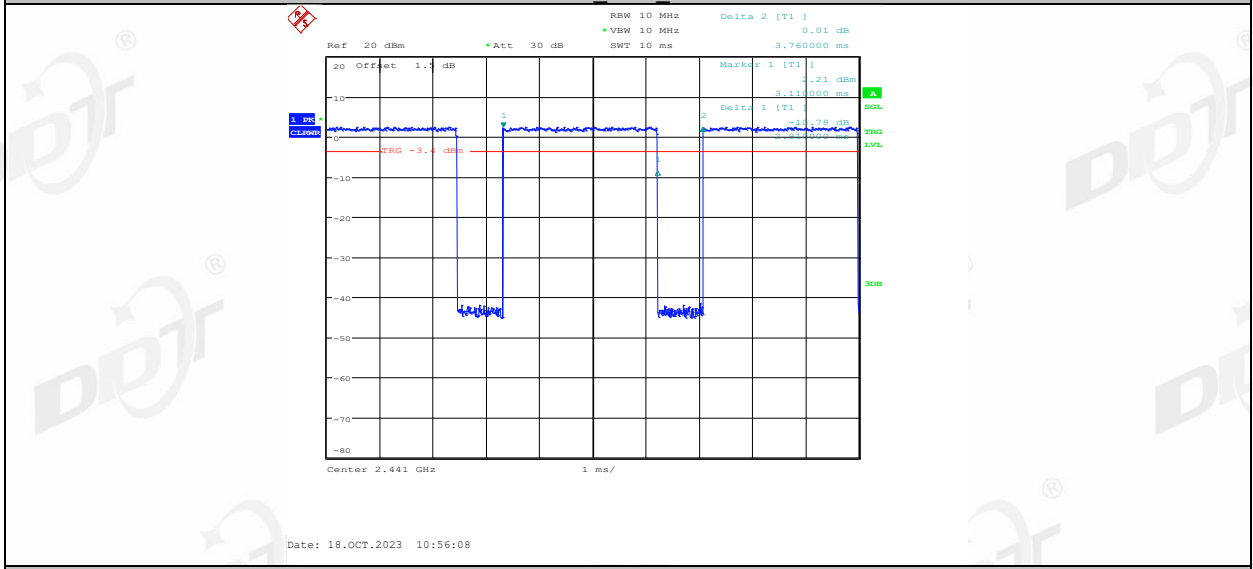

2DH5_Ant1_2480

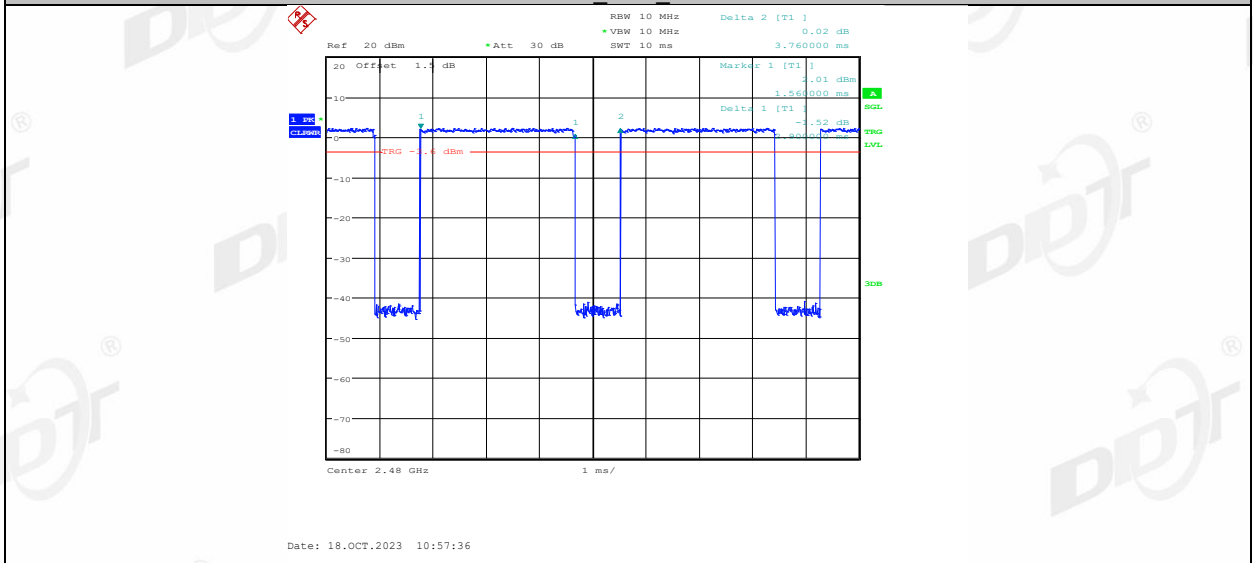

13. Radiated Emission

13.1. Test equipment

Equipment	Manufacturer	Model No.	Serial Number	Due Date
☑Radiation 3#Chamber				
EMI TEST RECEIVER	R&S	ESU26	100472	2024/04/22
PSA Series Spectrum Analyzer	Agilent	E4447A	MY50180031	2024/04/22
Active Loop Antenna	Schwarzbeck	FMZB-1519	1519-038	2024/09/10
Trilog Broadband Antenna	Schwarzbeck	VULB 9163	01429	2024/07/11
Double Ridged Horn Antenna	Schwarzbeck	BBHA 9120 D	02468	2024/09/17
Broad Band Horn Antenna	Schwarzbeck	BBHA 9170	790	2024/04/25
Pre-amplifier	COM-POWER	PAM-118A	18040084	2024/07/14
Pre-amplifier	COM-POWER	PAM-840A	461369	2024/04/26
RE Cable	N/A	W23.02 CP1-X2 + W23.09 AP1-X8+ JCT26S-NJ-NJ- 1.5M	4.5M+8M+1.5 M	2024/04/20
RF Cable	Yuhu	JCTB810-NJ-NJ- 9M+ ZT26S- SMAJ-SMAJ-1M	21123964	2024/04/22
Band Reject Filter(2400-2500 MHz)	REBES	BRM50702	G555	N/A
Band Reject Filter(5150-5880 MHz)	REBES	BRM50716	G392	N/A
High Pass Filter(8000-25000 MHz)	XB	XBLBQ-GTA67	210820-2-3	N/A
Test Software	Tonscend	JS32-RE	V 5.0.0.1	N/A

13.2. Block diagram of test setup

In 3 m Anechoic Chamber, test setup diagram for 9 kHz- 30 MHz:

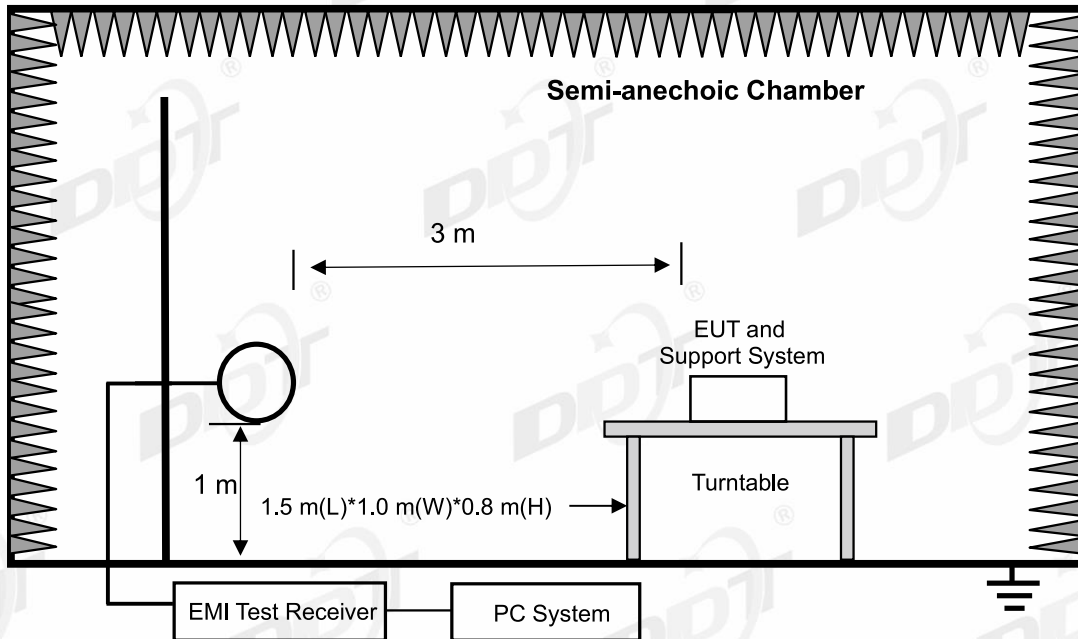

In 3 m Anechoic Chamber, test setup diagram for 30 MHz - 1 GHz:

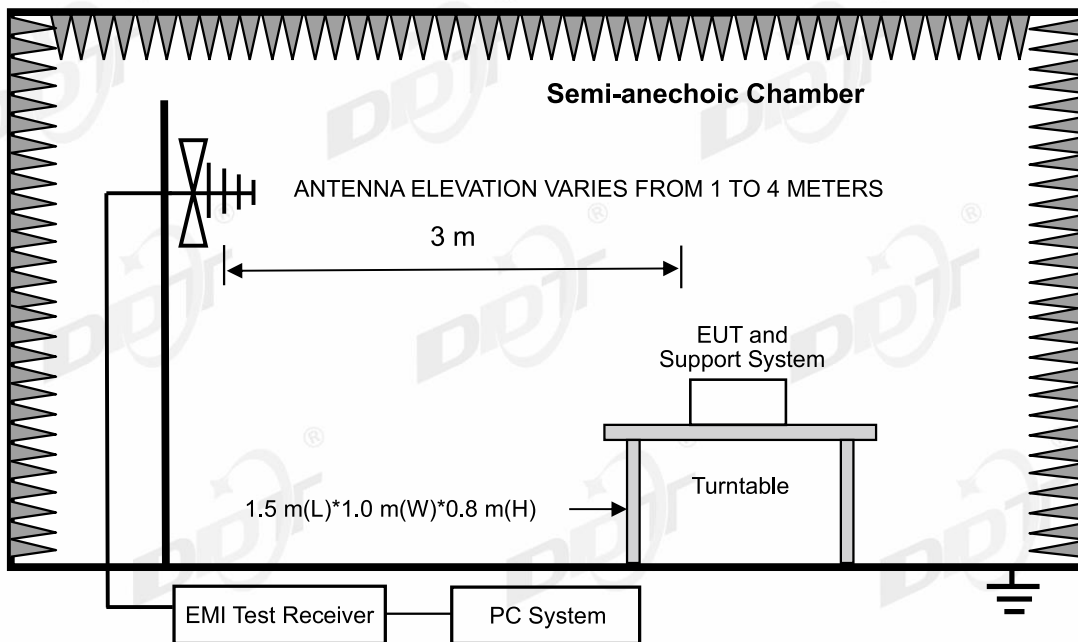

In 3 m Anechoic Chamber, test setup diagram for frequency above 1 GHz:

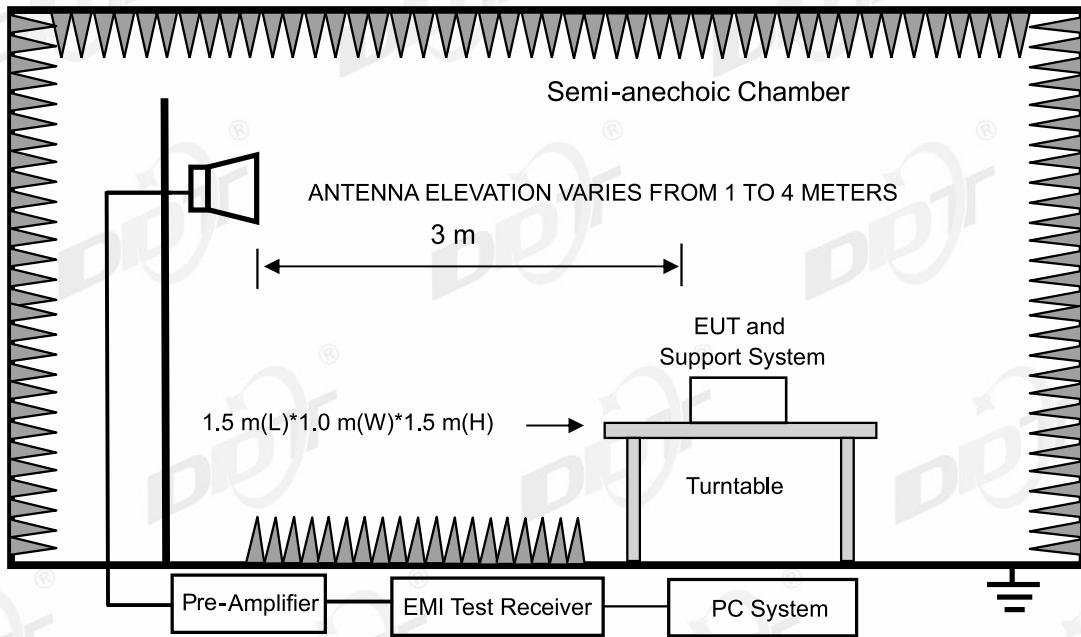

Note: Install an appropriate filter at the input of the measurement system power amplifier. This filter can attenuate the fundamental emission of the EUT and allow an accurate measurement of the associated harmonics and spurious emissions. The filter had been characterized, and the attenuation loss factors had been accounted for in the measurement results.

13.3. Limit

(1) FCC 15.205 Restricted frequency band

MHz	MHz	MHz	GHz
0.090-0.110	16.42-16.423	399.9-410	4.5-5.15
10.495-0.505	16.69475-16.69525	608-614	5.35-5.46
2.1735-2.1905	16.80425-16.80475	960-1240	7.25-7.75
4.125-4.128	25.5-25.67	1300-1427	8.025-8.5
4.1772&4.17775	37.5-38.25	1435-1626.5	9.0-9.2
4.2072&4.20775	73-74.6	1645.5-1646.5	9.3-9.5
6.215-6.218	74.8-75.2	1660-1710	10.6-12.7
6.26775-6.26825	108-121.94	1718.8-1722.2	13.25-13.4
6.31175-6.31225	123-138	2200-2300	14.47-14.5
8.291-8.294	149.9-150.05	2310-2390	15.35-16.2
8.362-8.366	156.52475-156.52525	2483.5-2500	17.7-21.4
8.37625-8.38675	156.7-156.9	2690-2900	22.01-23.12
8.41425-8.41475	162.0125-167.17	3260-3267	23.6-24.0
12.29-12.293	167.72-173.2	3332-3339	31.2-31.8
12.51975-12.52025	240-285	3345.8-3358	36.43-36.5

12.57675-12.57725	322-335.4	3600-4400	(²)
13.36-13.41			

¹Until February 1, 1999, this restricted band shall be 0.490-0.510 MHz

²Above 38.6

RSS-Gen section 8.10 Restricted frequency bands*

MHz	MHz	MHz	GHz
0.090-0.110	12.51975-12.52025	240-285	3.5-4.4
0.495-0.505	12.57675-12.57725	322-335.4	4.5-5.15
2.1735-2.1905	13.36-13.41	399.9-410	5.35-5.46
3.020-3.026	16.42-16.423	608-614	7.25-7.75
4.125-4.128	16.69475-16.69525	960-1427	8.025-8.5
4.1772&4.17775	16.80425-16.80475	1435-1626.5	9.0-9.2
4.2072&4.20775	25.5-25.67	1645.5-1646.5	9.3-9.5
5.677-5.683	37.5-38.25	1660-1710	10.6-12.7
6.215-6.218	73-74.6	1718.8-1722.2	13.25-13.4
6.26775-6.26825	74.8-75.2	2200-2300	14.47-14.5
6.31175-6.31225	108-138	2310-2390	15.35-16.2
8.291-8.294	149.9-150.05	2483.5-2500	17.7-21.4
8.362-8.366	156.52475-156.52525	2655-2900	22.01-23.12
8.37625-8.38675	156.7-156.9	3260-3267	23.6-24.0
8.41425-8.41475	162.0125-167.17	3332-3339	31.2-31.8
12.29-12.293	167.72-173.2	3345.8-3358	36.43-36.5
			Above 38.6

* Certain frequency bands listed in table and in bands above 38.6 GHz are designated for licence-exempt applications. These frequency bands and the requirements that apply to related devices are set out in the 200 and 300 series of RSSs.

(2) FCC 15.209 Limit & RSS-Gen section 8.9 Limit

FREQUENCY MHz	DISTANCE Meters	FIELD STRENGTHS LIMIT	
		$\mu\text{V}/\text{m}$	$\text{dB}(\mu\text{V})/\text{m}$
0.009 ~ 0.490	300	2400/F(kHz)	67.6-20log(F)
0.490 ~ 1.705	30	24000/F(kHz)	87.6-20log(F)
1.705 ~ 30.0	30	30	29.54
30 ~ 88	3	100	40.0
88 ~ 216	3	150	43.5
216 ~ 960	3	200	46.0
960 ~ 1000	3	500	54.0
Above 1000	3	74.0 dB(μV)/m (Peak) 54.0 dB(μV)/m (Average)	

Note: (1) The emission limits shown in the above table are based on measurements employing a CISPR QP detector except for the frequency bands 9 - 90 kHz, 110 - 490 kHz and above 1000 MHz, radiated emissions limits in these three bands are based on measurements employing an average detector.

(2) At frequencies below 30 MHz, measurement may be performed at a distance closer than that specified, and the limit at closer measurement distance can be extrapolated by below formula:

$$\text{Limit}_{3m}(\text{dBuV/m}) = \text{Limit}_{30m}(\text{dBuV/m}) + 40\text{Log}(30m/3m)$$

(3) Limit for this EUT

The emissions appearing within 15.205 restricted frequency bands shall not exceed the limits shown in 15.209, and the emissions appearing within RSS-Gen section 8.10 Restricted frequency bands shall not exceed the limits shown in RSS-Gen section 8.9, all the other emissions shall be at least 20 dB below the fundamental emissions or comply with 15.209 limits and RSS-Gen section 8.9 limits.

13.4. Test procedure

- (1) EUT was placed on a non-metallic table, 80 cm above the ground plane inside a semi-anechoic chamber for below 1G and 150 cm above the ground plane inside a fully-anechoic chamber for above 1G.
- (2) Test antenna was located 3 m from the EUT on an adjustable mast, and the antenna used as below table.

Test frequency range	Test antenna used	Test antenna distance
9 kHz - 30 MHz	Active Loop antenna	3 m
30 MHz - 1 GHz	Trilog Broadband Antenna	3 m
1 GHz - 18 GHz	Double Ridged Horn Antenna(1 GHz-18 GHz)	3 m
18 GHz - 40 GHz	Horn Antenna(18 GHz-40 GHz)	1 m

According ANSI C63.10:2013 clause 6.4.6 and 6.5.3, for measurements below 30 MHz, Antenna was located 3 m from EUT, the loop antenna was positioned in three antenna orientations (parallel, perpendicular, and round-parallel), for each measurement antenna alignment, the EUT shall be rotated through 0° to 360° on a turntable, and the lowest height of the magnetic antenna shall be 1 m above the ground. For measurement above 30MHz, the trilog Broadband Antenna or Horn Antenna was located 3m from EUT, Measurements were made with the antenna positioned in both the horizontal and vertical planes of Polarization, and the measurement antenna was varied from 1 m to 4 m. in height above the reference ground plane to obtain the maximum signal strength.

(3) Below pre-scan procedure was first performed in order to find prominent frequency spectrum radiated emissions from 9 kHz to 25 GHz:

(a) Scanning the peak frequency spectrum with the antenna specified in step (3), and the EUT was rotated 360 degree, the antenna height was varied from 1 m to 4 m (Except loop antenna, it's fixed 1 m above ground.)

(b) Change work frequency or channel of device if practicable.

(c) Change modulation type of device if practicable.

(d) Change power supply range from 85% to 115% of the rated supply voltage

(e) Rotated EUT though three orthogonal axes to determine the attitude of EUT arrangement

produces highest emissions.

Spectrum frequency from 9 kHz to 25 GHz (tenth harmonic of fundamental frequency) was investigated, and no any obvious emission were detected from 18 GHz to 25 GHz, so below final test was performed with frequency range from 9 kHz to 18 GHz.

(4) For final emissions measurements at each frequency of interest, the EUT was rotated and the antenna height was varied between 1 m and 4 m in order to maximize the emission. Measurements in both horizontal and vertical polarities were made and the data was recorded. In order to find the maximum emission, the relative positions of equipment and all of the interface cables were changed according to ANSI C63.10:2013 on Radiated Emission test.

(5) The emissions from 9 kHz to 1 GHz were measured based on CISPR QP detector except for the frequency bands 9 - 90 kHz, 110 - 490 kHz, for emissions from 9 kHz - 90 kHz, 110 kHz - 490 kHz and above 1 GHz were measured based on average detector, for emissions above 1 GHz, peak emissions also be measured and need comply with Peak limit.

(6) The emissions from 9 kHz to 1 GHz, QP or average values were measured with EMI receiver with below RBW.

Frequency band	RBW
9 kHz - 150 kHz	200 Hz
150 kHz - 30 MHz	9 kHz
30 MHz - 1 GHz	120 kHz

(7) For emissions above 1GHz, both Peak and Average level were measured with Spectrum Analyzer, and the RBW is set at 1 MHz, VBW is set at 3 MHz for Peak measure; According ANSI C63.10:2013 clause 4.1.4.2.2 procedure for average measure.

(8) For portable device, X axis, Y axis, Z axis are tested, and worse setup is reported.

13.5. Test result

Pass. (See below detailed test result)

All the emissions except fundamental emission from 9 kHz to 25 GHz were comply with 15.209 limits and RSS-Gen section 8.9 limits.

Note1: According exploratory test, the emission levels are 20 dB below the limit detected from 9 kHz to 30 MHz and 18 GHz to 25 GHz, so the final test was performed with frequency range from 30 MHz to 18 GHz and recorded in below.

Note2: 30 MHz ~ 25 GHz: (Scan with GFSK and $\pi/4$ -DQPSK, the worst case is GFSK Mode)

Note3: For emissions below 1 GHz, according exploratory explorer test, when change Tx mode and channel, have no distinct influence on emissions level, so for emissions below 1 GHz, the final test was only performed with EUT working in GFSK, Tx 2402 MHz mode.

Note4: For emissions above 1 GHz. If peak results comply with AV limit, AV Result is deemed to comply with AV limit.

Radiated Emission Test Result (below 1 GHz) TR-4-E-009 Radiated Emission Test Result

Test Date: 2023-10-19 **Tested By:** Bairong
EUT: PORTABLE BLUETOOTH SPEAKER **Model Number:** GO4T
Test Mode: Tx mode **Power Supply:** Battery
Condition: Temp:22.8°C;Humi:54.4% **Test Site:** DDT 3# Chamber
File Path: d:\ts\2023 report data\Q23090801-2E GO4T\FCC BELOW 1G\20231019-210014_H
Memo: Sample Number: S23090801-06

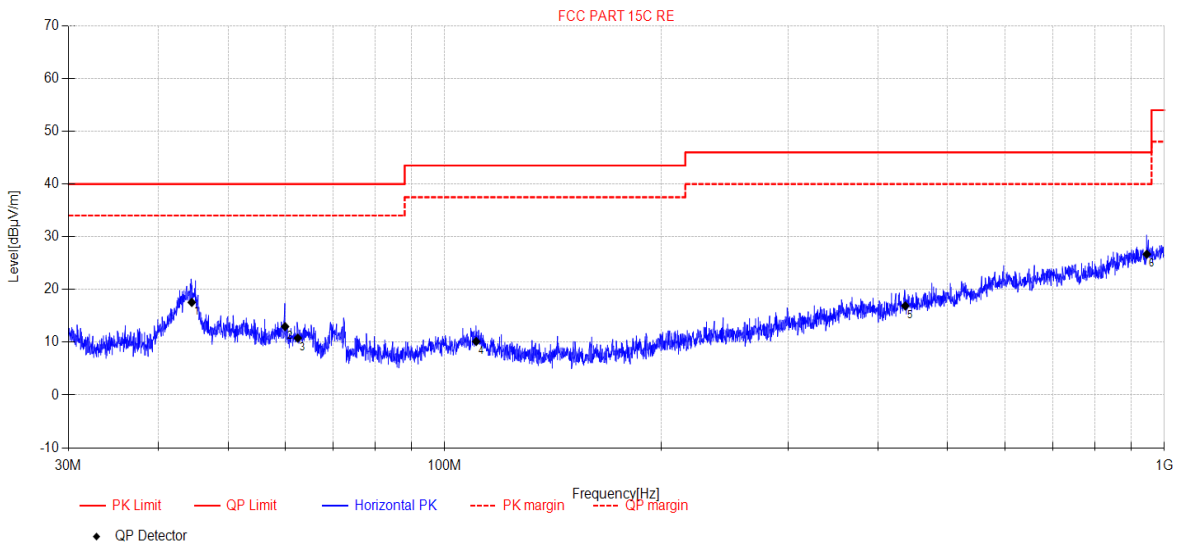

Data List										
NO.	Freq. [MHz]	Reading [dBµV/m]	Antenna Factor [dB]	Cable Loss [dB]	AMP [dB]	Result [dBµV/m]	Limit [dBµV/m]	Margin [dB]	Detector	Polarity
1	44.52	30.58	13.10	4.66	-30.78	17.56	40.00	22.44	QP	Horizontal
2	60.02	26.05	12.79	4.76	-30.63	12.97	40.00	27.03	QP	Horizontal
3	62.51	24.03	12.60	4.77	-30.62	10.78	40.00	29.22	QP	Horizontal
4	110.62	23.92	11.98	5.12	-30.87	10.15	43.50	33.35	QP	Horizontal
5	436.58	24.11	16.03	6.78	-30.03	16.89	46.00	29.11	QP	Horizontal
6	945.45	25.17	21.61	8.50	-28.59	26.69	46.00	19.31	QP	Horizontal

Note:

1. Result Level = Reading + Cable loss + Antenna Factor + AMP
2. If Peak Result complies with QP limit, QP Result is deemed to comply with QP limit.
3. Test setup: RBW: 120 kHz, VBW: 300 kHz, Sweep time: auto.

TR-4-E-009 Radiated Emission Test Result

Test Date: 2023-10-19 **Tested By:** Bairong
EUT: PORTABLE BLUETOOTH SPEAKER **Model Number:** GO4T
Test Mode: Tx mode **Power Supply:** Battery
Condition: Temp:22.8°C;Humi:54.4% **Test Site:** DDT 3# Chamber
File Path: d:\ts\2023 report data\Q23090801-2E GO4T\FCC BELOW 1G\20231019-210028_V
Memo: Sample Number: S23090801-06

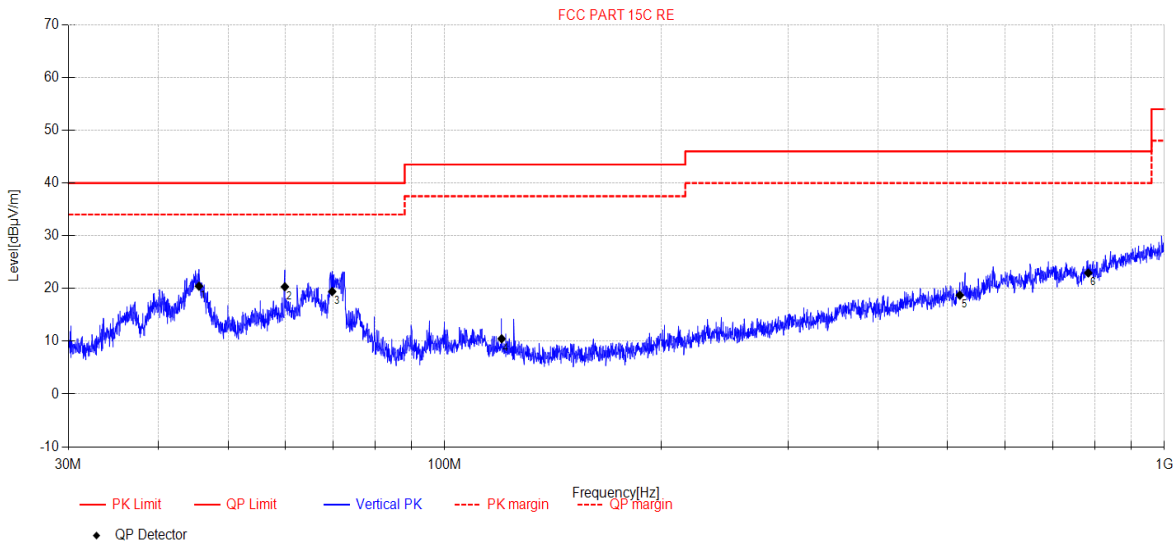

Data List										
NO.	Freq. [MHz]	Reading [dBµV/m]	Antenna Factor [dB]	Cable Loss [dB]	AMP [dB]	Result [dBµV/m]	Limit [dBµV/m]	Margin [dB]	Detector	Polarity
1	45.56	33.85	12.69	4.67	-30.77	20.44	40.00	19.56	QP	Vertical
2	59.98	33.4	12.79	4.76	-30.63	20.32	40.00	19.68	QP	Vertical
3	69.78	35.25	9.95	4.79	-30.57	19.42	40.00	20.58	QP	Vertical
4	119.99	26.14	10.00	5.17	-30.84	10.47	43.50	33.03	QP	Vertical
5	519.86	25.22	16.40	7.01	-29.90	18.73	46.00	27.27	QP	Vertical
6	784.03	25.96	18.94	7.94	-29.90	22.94	46.00	23.06	QP	Vertical

Note:

1. Result Level = Reading + Cable loss + Antenna Factor + AMP
2. If Peak Result complies with QP limit, QP Result is deemed to comply with QP limit.
3. Test setup: RBW: 120 kHz, VBW: 300 kHz, Sweep time: auto.

Radiated Emission Test Result (above 1 GHz)

TR-4-E-009 Radiated Emission Test Result

Test Date: 2023-10-18 **Tested By:** Bairong
EUT: PORTABLE BLUETOOTH SPEAKER **Model Number:** GO4T
Test Mode: DH5 TX 2402MHz **Power Supply:** Battery
Condition: Temp:22.8°C;Humi:54.4% **Test Site:** DDT 3# Chamber
File Path: d:\ts\2023 report data\Q23090801-2E GO4T\FCC ABOVE 1G\1
Memo: Sample Number: S23090801-06

Test Graph

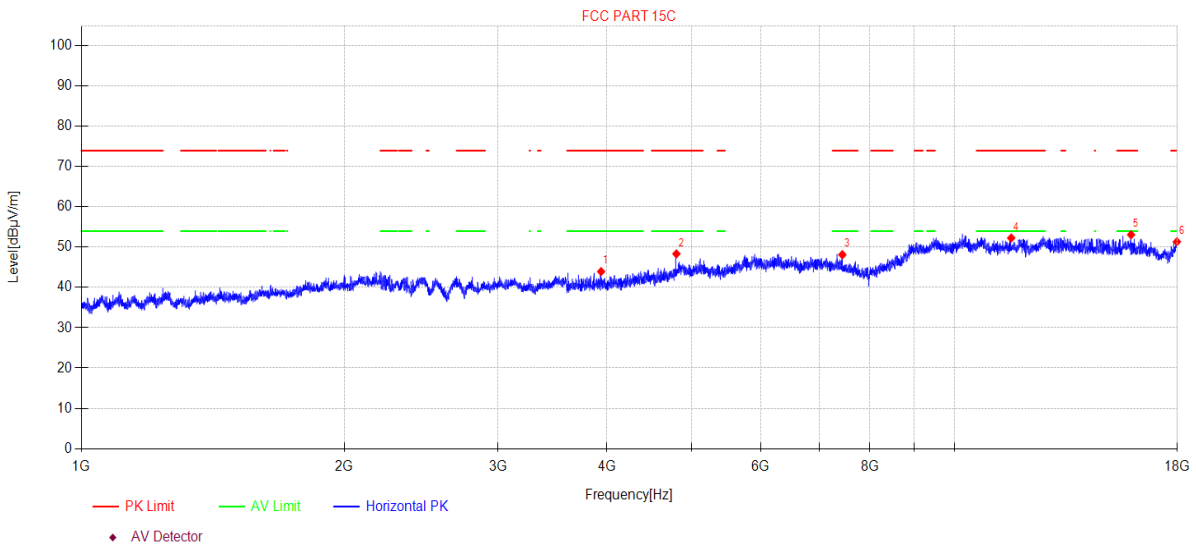

Data List										
NO.	Freq. [MHz]	Reading [dBµV/m]	Cable loss [dB]	Antenna Factor [dB]	AMP [dB]	Level [dBµV/m]	Limit [dBµV/m]	Margin [dB]	Detector	Polarity
1	3938.37	47.40	5.84	31.12	-40.41	43.95	74.00	30.05	PK	Horizontal
2	4803.36	48.44	7.47	32.59	-40.15	48.35	74.00	25.65	PK	Horizontal
3	7440.02	45.69	7.64	36.62	-41.80	48.15	74.00	25.85	PK	Horizontal
4	11614.28	42.47	10.20	39.00	-39.38	52.29	74.00	21.71	PK	Horizontal
5	15933.28	38.77	15.58	38.07	-39.32	53.10	74.00	20.90	PK	Horizontal
6	17979.20	38.31	13.11	42.30	-42.35	51.37	74.00	22.63	PK	Horizontal

Note:

1. Level = Reading + Cable loss + Antenna Factor + AMP
2. If Peak Result complies with AV limit, AV Result is deemed to comply with AV limit.
3. Test setup: RBW: 1 MHz, VBW: 3 MHz, Sweep time: auto.

TR-4-E-009 Radiated Emission Test Result

Test Date: 2023-10-18 **Tested By:** Bairong
EUT: PORTABLE BLUETOOTH SPEAKER **Model Number:** GO4T
Test Mode: DH5 TX 2402MHz **Power Supply:** Battery
Condition: Temp:22.8°C;Humi:54.4% **Test Site:** DDT 3# Chamber
File Path: d:\ts\2023 report data\Q23090801-2E GO4T\FCC ABOVE 1G2
Memo: Sample Number: S23090801-06

Test Graph

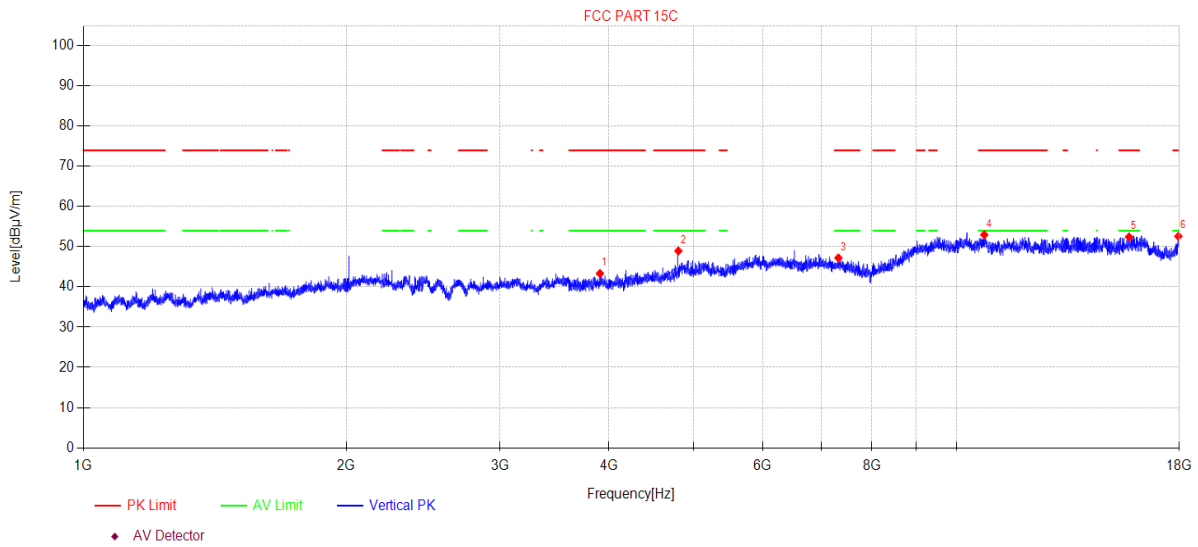

Data List										
NO.	Freq. [MHz]	Reading [dBµV/m]	Cable loss [dB]	Antenna Factor [dB]	AMP [dB]	Level [dBµV/m]	Limit [dBµV/m]	Margin [dB]	Detector	Polarity
1	3905.50	46.72	5.83	31.19	-40.39	43.35	74.00	30.65	PK	Vertical
2	4803.36	49.06	7.47	32.59	-40.15	48.97	74.00	25.03	PK	Vertical
3	7324.81	44.26	7.63	36.85	-41.51	47.23	74.00	26.77	PK	Vertical
4	10761.09	43.11	9.48	39.40	-39.00	52.99	74.00	21.01	PK	Vertical
5	15763.81	38.48	14.81	38.37	-39.22	52.44	74.00	21.56	PK	Vertical
6	17953.24	39.67	13.07	42.17	-42.30	52.61	74.00	21.39	PK	Vertical

Note:

1. Level = Reading + Cable loss + Antenna Factor + AMP
2. If Peak Result complies with AV limit, AV Result is deemed to comply with AV limit.
3. Test setup: RBW: 1 MHz, VBW: 3 MHz, Sweep time: auto.

TR-4-E-009 Radiated Emission Test Result

Test Date: 2023-10-19 **Tested By:** Bairong
EUT: PORTABLE BLUETOOTH SPEAKER **Model Number:** GO4T
Test Mode: DH5 TX 2441MHz **Power Supply:** Battery
Condition: Temp:22.8°C;Humi:54.4% **Test Site:** DDT 3# Chamber
File Path: d:\ts\2023 report data\Q23090801-2E GO4T\FCC ABOVE 1G3
Memo: Sample Number: S23090801-06

Test Graph

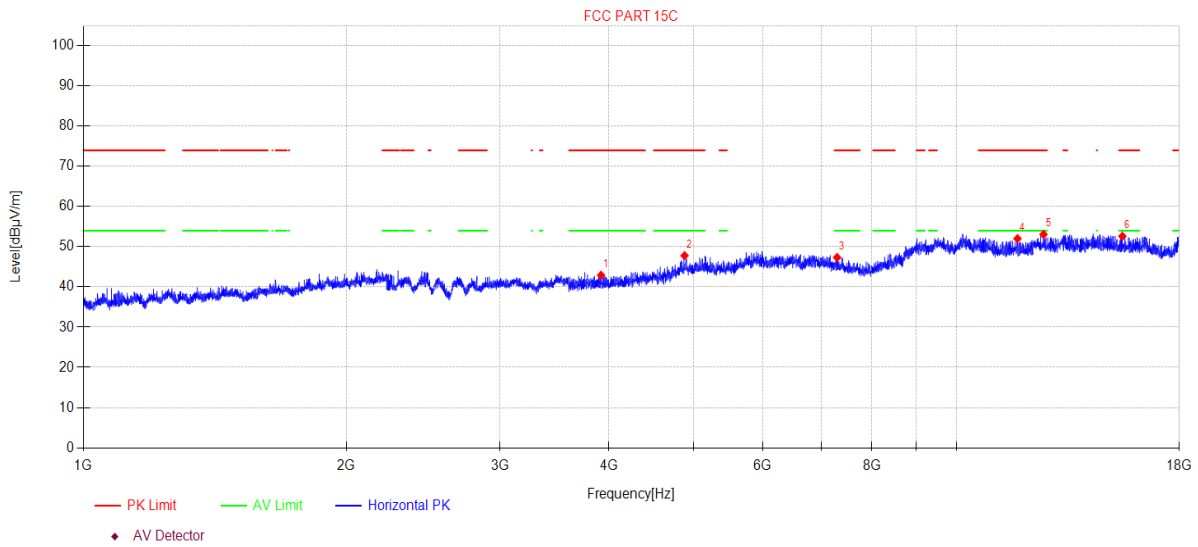

Data List										
NO.	Freq. [MHz]	Reading [dBµV/m]	Cable loss [dB]	Antenna Factor [dB]	AMP [dB]	Level [dBµV/m]	Limit [dBµV/m]	Margin [dB]	Detector	Polarity
1	3916.80	46.32	5.83	31.17	-40.40	42.92	74.00	31.08	PK	Horizontal
2	4881.73	46.99	7.63	33.29	-40.12	47.79	74.00	26.21	PK	Horizontal
3	7299.45	44.27	7.63	36.90	-41.45	47.35	74.00	26.65	PK	Horizontal
4	11745.93	42.21	10.31	38.95	-39.44	52.03	74.00	21.97	PK	Horizontal
5	12582.29	42.94	10.54	39.40	-39.79	53.09	74.00	20.91	PK	Horizontal
6	15492.82	39.30	13.58	38.81	-39.06	52.63	74.00	21.37	PK	Horizontal

Note:

1. Level = Reading + Cable loss + Antenna Factor + AMP
2. If Peak Result complies with AV limit, AV Result is deemed to comply with AV limit.
3. Test setup: RBW: 1 MHz, VBW: 3 MHz, Sweep time: auto.

TR-4-E-009 Radiated Emission Test Result

Test Date: 2023-10-19 **Tested By:** Bairong
EUT: PORTABLE BLUETOOTH SPEAKER **Model Number:** GO4T
Test Mode: DH5 TX 2441MHz **Power Supply:** Battery
Condition: Temp:22.8°C;Humi:54.4% **Test Site:** DDT 3# Chamber
File Path: d:\ts\2023 report data\Q23090801-2E GO4T\FCC ABOVE 1G4
Memo: Sample Number: S23090801-06

Test Graph

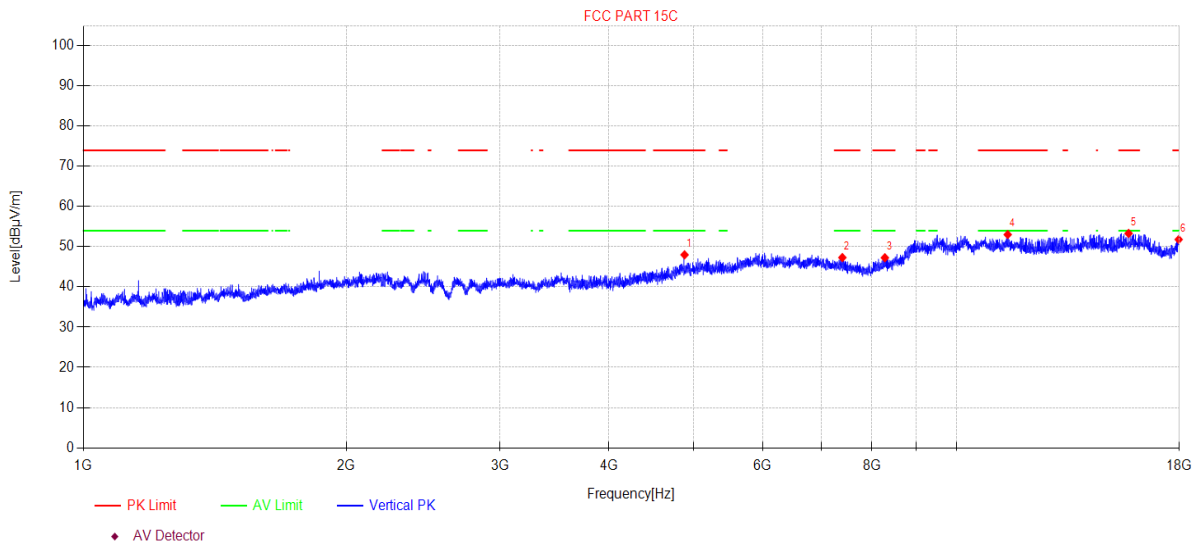

Data List										
NO.	Freq. [MHz]	Reading [dBµV/m]	Cable loss [dB]	Antenna Factor [dB]	AMP [dB]	Level [dBµV/m]	Limit [dBµV/m]	Margin [dB]	Detector	Polarity
1	4881.73	47.20	7.63	33.29	-40.12	48.00	74.00	26.00	PK	Vertical
2	7401.42	44.67	7.64	36.70	-41.70	47.31	74.00	26.69	PK	Vertical
3	8279.70	44.02	7.97	37.26	-41.97	47.28	74.00	26.72	PK	Vertical
4	11447.65	43.03	10.05	39.25	-39.30	53.03	74.00	20.97	PK	Vertical
5	15745.60	39.40	14.73	38.41	-39.21	53.33	74.00	20.67	PK	Vertical
6	17968.81	38.81	13.09	42.24	-42.33	51.81	74.00	22.19	PK	Vertical

Note:

1. Level = Reading + Cable loss + Antenna Factor + AMP
2. If Peak Result complies with AV limit, AV Result is deemed to comply with AV limit.
3. Test setup: RBW: 1 MHz, VBW: 3 MHz, Sweep time: auto.

TR-4-E-009 Radiated Emission Test Result

Test Date: 2023-10-18 **Tested By:** Bairong
EUT: PORTABLE BLUETOOTH SPEAKER **Model Number:** GO4T
Test Mode: DH5 TX 2480MHz **Power Supply:** Battery
Condition: Temp:22.8°C;Humi:54.4% **Test Site:** DDT 3# Chamber
File Path: d:\ts\2023 report data\Q23090801-2E GO4T\FCC ABOVE 1G5
Memo: Sample Number: S23090801-06

Test Graph

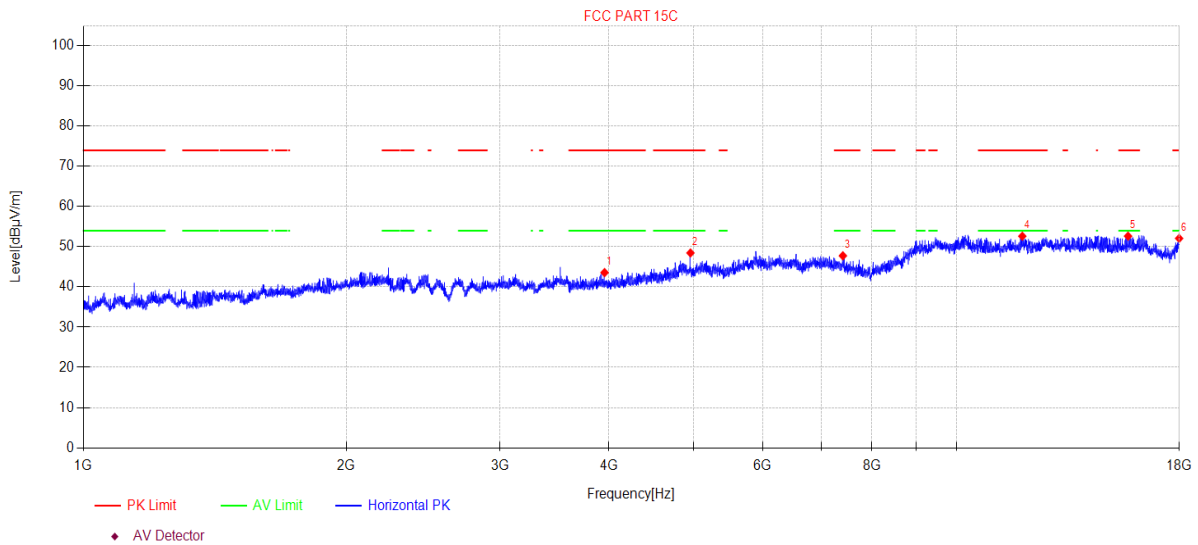

Data List										
NO.	Freq. [MHz]	Reading [dBμV/m]	Cable loss [dB]	Antenna Factor [dB]	AMP [dB]	Level [dBμV/m]	Limit [dBμV/m]	Margin [dB]	Detector	Polarity
1	3953.19	47.07	5.84	31.09	-40.42	43.58	74.00	30.42	PK	Horizontal
2	4958.51	47.66	7.79	33.12	-40.10	48.47	74.00	25.53	PK	Horizontal
3	7412.12	45.17	7.64	36.68	-41.73	47.76	74.00	26.24	PK	Horizontal
4	11896.25	42.79	10.45	38.90	-39.51	52.63	74.00	21.37	PK	Horizontal
5	15722.86	38.77	14.62	38.45	-39.19	52.65	74.00	21.35	PK	Horizontal
6	17989.60	38.99	13.12	42.35	-42.38	52.08	74.00	21.92	PK	Horizontal

Note:

1. Level = Reading + Cable loss + Antenna Factor + AMP
2. If Peak Result complies with AV limit, AV Result is deemed to comply with AV limit.
3. Test setup: RBW: 1 MHz, VBW: 3 MHz, Sweep time: auto.

TR-4-E-009 Radiated Emission Test Result

Test Date: 2023-10-18 **Tested By:** Bairong
EUT: PORTABLE BLUETOOTH SPEAKER **Model Number:** GO4T
Test Mode: DH5 TX 2480MHz **Power Supply:** Battery
Condition: Temp:22.8°C;Humi:54.4% **Test Site:** DDT 3# Chamber
File Path: d:\ts\2023 report data\Q23090801-2E GO4T\FCC ABOVE 1G6
Memo: Sample Number: S23090801-06

Test Graph

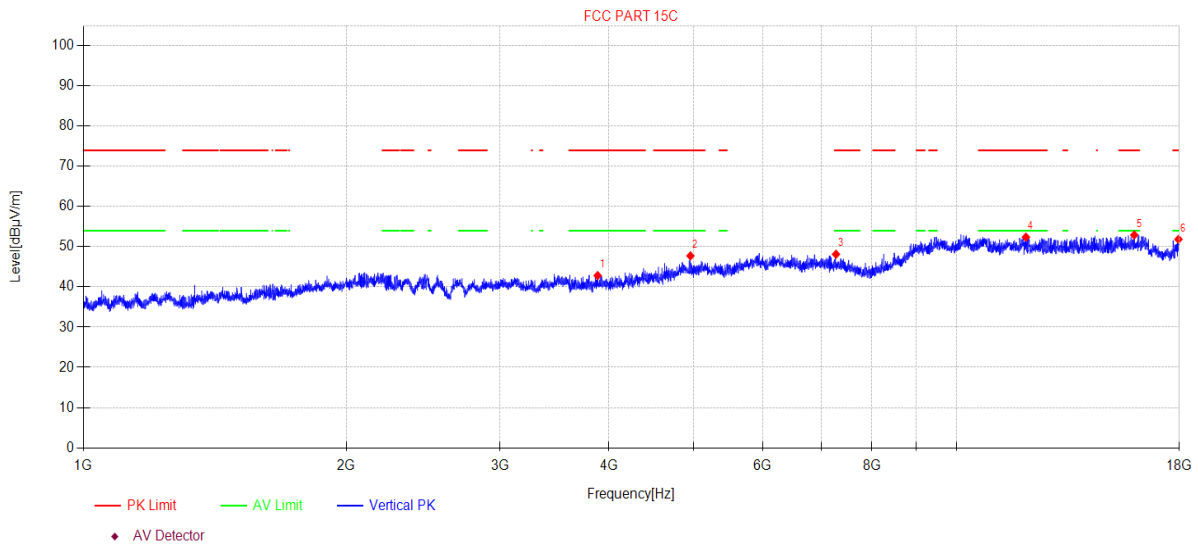

Data List										
NO.	Freq. [MHz]	Reading [dBμV/m]	Cable loss [dB]	Antenna Factor [dB]	AMP [dB]	Level [dBμV/m]	Limit [dBμV/m]	Margin [dB]	Detector	Polarity
1	3881.87	46.31	5.82	31.09	-40.38	42.84	74.00	31.16	PK	Vertical
2	4958.51	46.93	7.79	33.12	-40.10	47.74	74.00	26.26	PK	Vertical
3	7278.38	45.05	7.63	36.86	-41.40	48.14	74.00	25.86	PK	Vertical
4	12010.25	42.21	10.54	39.21	-39.56	52.40	74.00	21.60	PK	Vertical
5	15984.02	38.45	15.81	38.02	-39.35	52.93	74.00	21.07	PK	Vertical
6	17958.43	38.89	13.08	42.19	-42.31	51.85	74.00	22.15	PK	Vertical

Note:

1. Level = Reading + Cable loss + Antenna Factor + AMP
2. If Peak Result complies with AV limit, AV Result is deemed to comply with AV limit.
3. Test setup: RBW: 1 MHz, VBW: 3 MHz, Sweep time: auto.

14. Band Edge Compliance (Radiated Method)

14.1. Test equipment

Equipment	Manufacturer	Model No.	Serial Number	Due Date
☑Radiation 3#Chamber				
EMI TEST RECEIVER	R&S	ESU26	100472	2024/04/22
Double Ridged Horn Antenna	Schwarzbeck	BBHA 9120 D	02468	2024/09/17
RF Cable	Yuhu	JCTB810-NJ-NJ-9M+ ZT26S-SMAJ-SMAJ-1M	21123964	2024/04/22
Test Software	Tonscend	JS32-RE	V 5.0.0.1	N/A

14.2. Block diagram of test setup

In 3 m Anechoic Chamber, test setup diagram for frequency above 1 GHz:

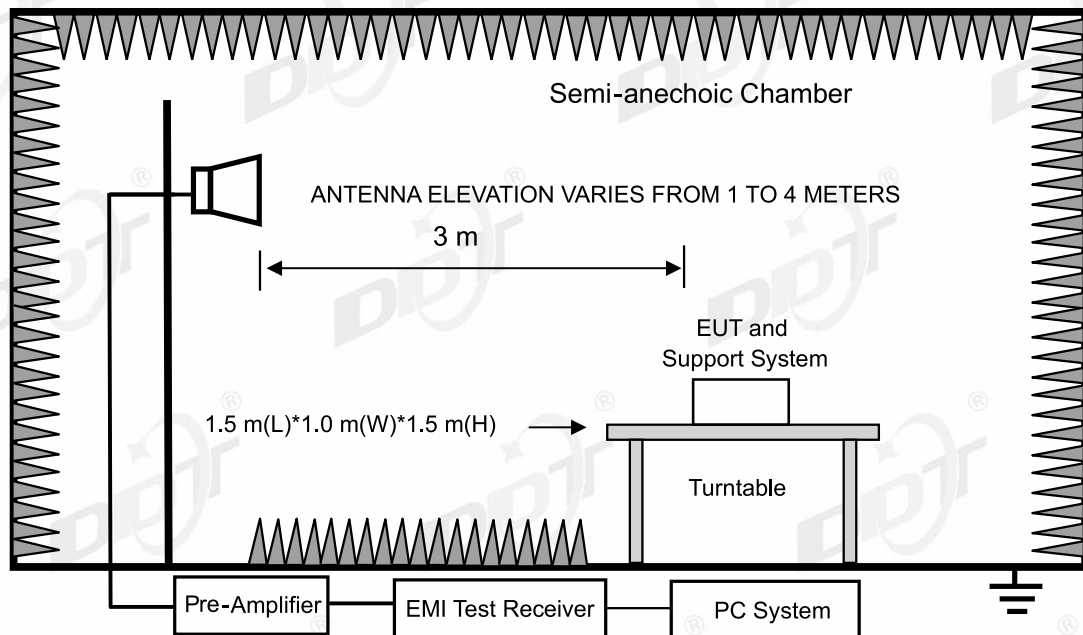

14.3. Limit

All restriction band should comply with 15.209 and RSS-Gen section 8.9 limits, other emission should be at least 20 dB below the fundamental.

14.4. Test procedure

Same with Radiated Emission except change investigated frequency range.

Remark: All restriction band have been tested, and only the worst case is shown in report.

14.5. Test result

Pass. (See below detailed test result)

Remark: hopping on and hopping off mode all have been test, hopping off mode is worse and reported only. Scan with all mode, the worst case is recorded in this report.

TR-4-E-009 Radiated Emission Test Result

Test Date: 2023-10-19 **Tested By:** Bairong
EUT: Portable Bluetooth Speaker **Model Number:** GO4T
Test Mode: DH5 TX 2402MHz **Power Supply:** Battery
Condition: Temp:22.8°C;Humi:54.4% **Test Site:** DDT 3# Chamber
File Path: d:\ts\2023 report data\Q23090801-2E GO4T\FCC ABOVE 1G\9
Memo: Sample Number: S23090801-06

Test Graph

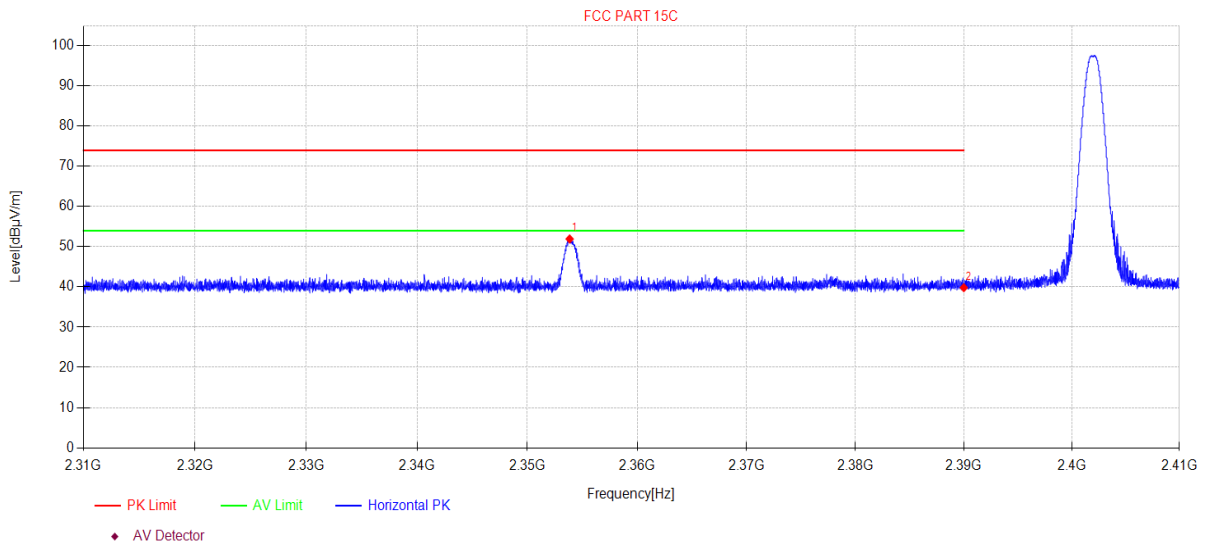

Data List										
NO.	Freq. [MHz]	Reading [dBµV/m]	Cable loss [dB]	Antenna Factor [dB]	AMP [dB]	Level [dBµV/m]	Limit [dBµV/m]	Margin [dB]	Detector	Polarity
1	2353.85	58.99	3.84	27.12	-38.01	51.94	74.00	22.06	PK	Horizontal
2	2390.00	46.80	3.87	27.26	-38.11	39.82	74.00	34.18	PK	Horizontal

Note:

1. Level = Reading + Cable loss + Antenna Factor + AMP
2. If Peak Result complies with AV limit, AV Result is deemed to comply with AV limit.
3. Test setup: RBW: 1 MHz, VBW: 3 MHz, Sweep time: auto.

TR-4-E-009 Radiated Emission Test Result

Test Date: 2023-10-19 **Tested By:** Bairong
EUT: Portable Bluetooth Speaker **Model Number:** GO4T
Test Mode: DH5 TX 2402MHz **Power Supply:** Battery
Condition: Temp:22.8°C;Humi:54.4% **Test Site:** DDT 3# Chamber
File Path: d:\ts\2023 report data\Q23090801-2E GO4T\FCC ABOVE 1G\10
Memo: Sample Number: S23090801-06

Test Graph

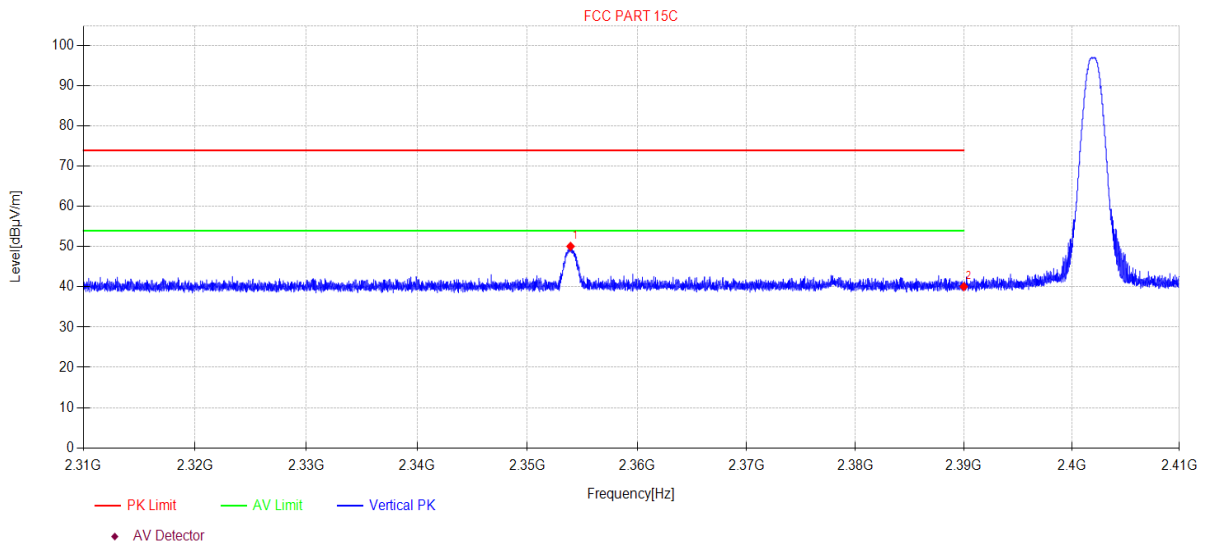

Data List										
NO.	Freq. [MHz]	Reading [dBµV/m]	Cable loss [dB]	Antenna Factor [dB]	AMP [dB]	Level [dBµV/m]	Limit [dBµV/m]	Margin [dB]	Detector	Polarity
1	2353.93	57.15	3.84	27.12	-38.01	50.10	74.00	23.90	PK	Vertical
2	2390.00	47.06	3.87	27.26	-38.11	40.08	74.00	33.92	PK	Vertical

Note:

1. Level = Reading + Cable loss + Antenna Factor + AMP
2. If Peak Result complies with AV limit, AV Result is deemed to comply with AV limit.
3. Test setup: RBW: 1 MHz, VBW: 3 MHz, Sweep time: auto.

TR-4-E-009 Radiated Emission Test Result

Test Date: 2023-10-18 **Tested By:** Bairong
EUT: Portable Bluetooth Speaker **Model Number:** GO4T
Test Mode: DH5 TX 2480MHz **Power Supply:** Battery
Condition: Temp:22.8°C;Humi:54.4% **Test Site:** DDT 3# Chamber
File Path: d:\ts\2023 report data\Q23090801-2E GO4T\FCC ABOVE 1G7
Memo: Sample Number: S23090801-06

Test Graph

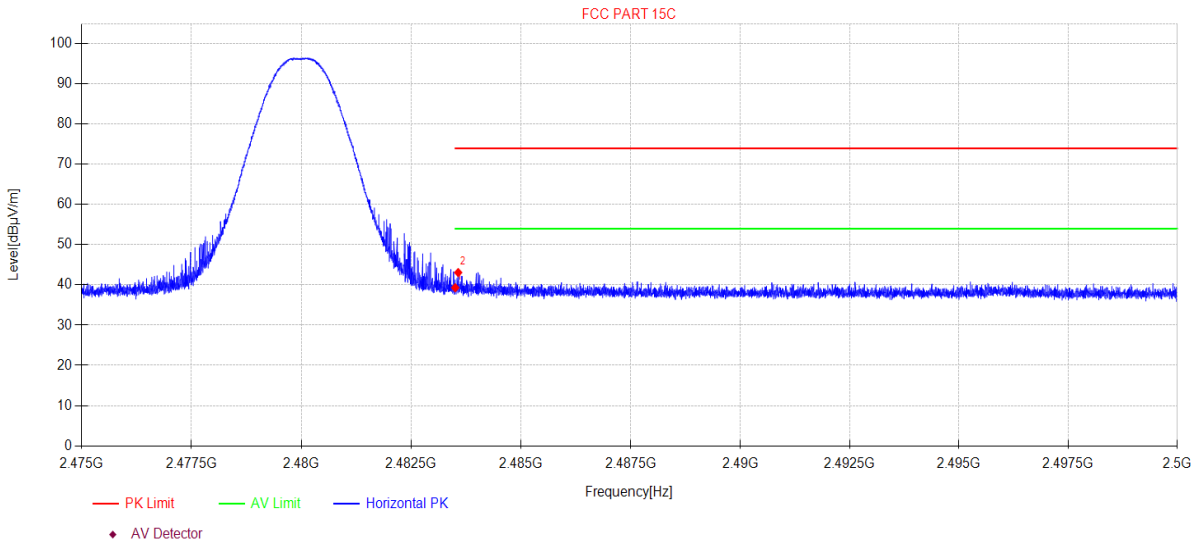

Data List										
NO.	Freq. [MHz]	Reading [dBµV/m]	Cable loss [dB]	Antenna Factor [dB]	AMP [dB]	Level [dBµV/m]	Limit [dBµV/m]	Margin [dB]	Detector	Polarity
1	2483.50	46.23	3.94	27.53	-38.38	39.32	74.00	34.68	PK	Horizontal
2	2483.57	50.00	3.94	27.53	-38.38	43.09	74.00	30.91	PK	Horizontal

Note:

1. Level = Reading + Cable loss + Antenna Factor + AMP
2. If Peak Result complies with AV limit, AV Result is deemed to comply with AV limit.
3. Test setup: RBW: 1 MHz, VBW: 3 MHz, Sweep time: auto.

TR-4-E-009 Radiated Emission Test Result

Test Date: 2023-10-18 **Tested By:** Bairong
EUT: Portable Bluetooth Speaker **Model Number:** GO4T
Test Mode: DH5 TX 2480MHz **Power Supply:** Battery
Condition: Temp:22.8°C;Humi:54.4% **Test Site:** DDT 3# Chamber
File Path: d:\ts\2023 report data\Q23090801-2E GO4T\FCC ABOVE 1G8
Memo: Sample Number: S23090801-06

Test Graph

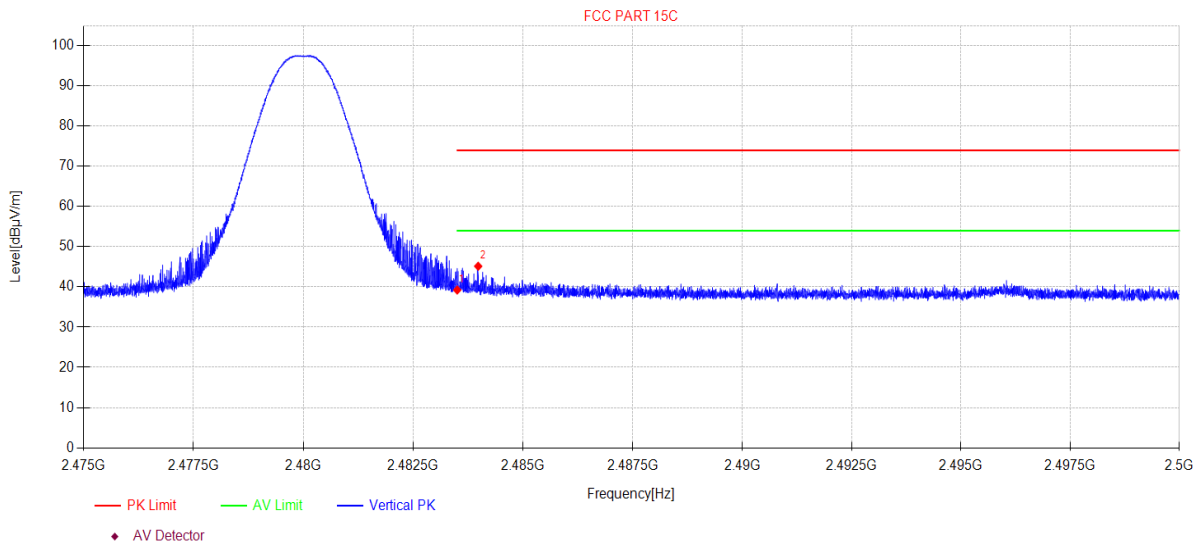

Data List										
NO.	Freq. [MHz]	Reading [dBµV/m]	Cable loss [dB]	Antenna Factor [dB]	AMP [dB]	Level [dBµV/m]	Limit [dBµV/m]	Margin [dB]	Detector	Polarity
1	2483.50	46.16	3.94	27.53	-38.38	39.25	74.00	34.75	PK	Vertical
2	2483.98	52.06	3.94	27.54	-38.38	45.16	74.00	28.84	PK	Vertical

Note:

1. Level = Reading + Cable loss + Antenna Factor + AMP
2. If Peak Result complies with AV limit, AV Result is deemed to comply with AV limit.
3. Test setup: RBW: 1 MHz, VBW: 3 MHz, Sweep time: auto.

TR-4-E-009 Radiated Emission Test Result

Test Date: 2023-10-19 **Tested By:** Bairong
EUT: Portable Bluetooth Speaker **Model Number:** GO4T
Test Mode: 2DH5 TX 2402MHz **Power Supply:** Battery
Condition: Temp:22.8°C;Humi:54.4% **Test Site:** DDT 3# Chamber
File Path: d:\ts\2023 report data\Q23090801-2E GO4T\FCC ABOVE 1G\11
Memo: Sample Number: S23090801-06

Test Graph

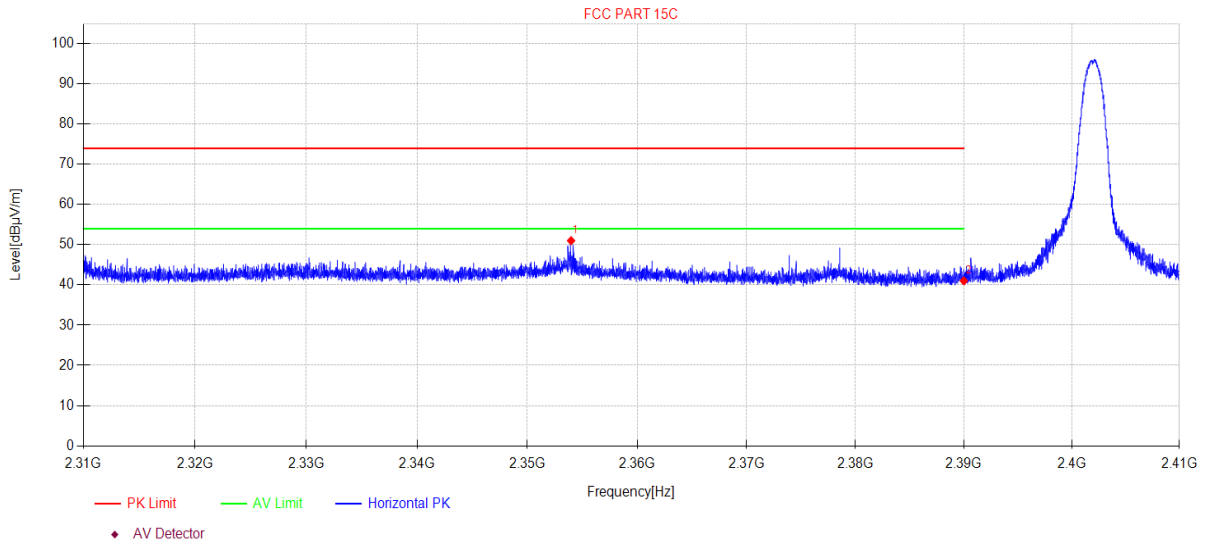

Data List										
NO.	Freq. [MHz]	Reading [dBµV/m]	Cable loss [dB]	Antenna Factor [dB]	AMP [dB]	Level [dBµV/m]	Limit [dBµV/m]	Margin [dB]	Detector	Polarity
1	2353.98	58.07	3.84	27.12	-38.01	51.02	74.00	22.98	PK	Horizontal
2	2390.00	48.01	3.87	27.26	-38.11	41.03	74.00	32.97	PK	Horizontal

Note:

1. Level = Reading + Cable loss + Antenna Factor + AMP
2. If Peak Result complies with AV limit, AV Result is deemed to comply with AV limit.
3. Test setup: RBW: 1 MHz, VBW: 3 MHz, Sweep time: auto.

TR-4-E-009 Radiated Emission Test Result

Test Date: 2023-10-19 **Tested By:** Bairong
EUT: Portable Bluetooth Speaker **Model Number:** GO4T
Test Mode: 2DH5 TX 2402MHz **Power Supply:** Battery
Condition: Temp:22.8°C;Humi:54.4% **Test Site:** DDT 3# Chamber
File Path: d:\ts\2023 report data\Q23090801-2E GO4T\FCC ABOVE 1G\12
Memo: Sample Number: S23090801-06

Test Graph

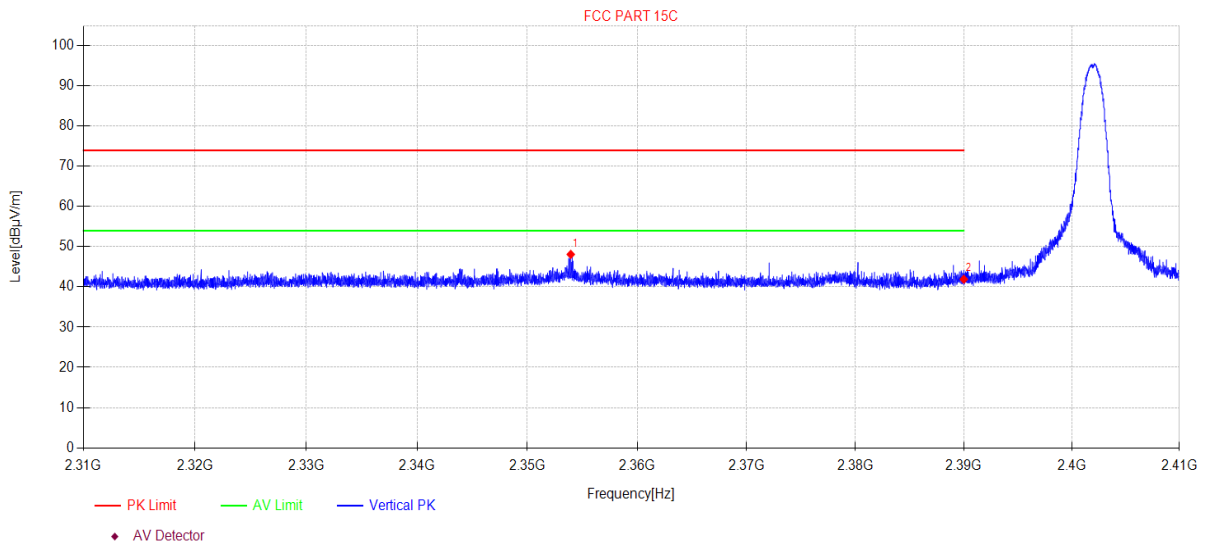

Data List										
NO.	Freq. [MHz]	Reading [dBµV/m]	Cable loss [dB]	Antenna Factor [dB]	AMP [dB]	Level [dBµV/m]	Limit [dBµV/m]	Margin [dB]	Detector	Polarity
1	2353.95	55.15	3.84	27.12	-38.01	48.10	74.00	25.90	PK	Vertical
2	2390.00	48.90	3.87	27.26	-38.11	41.92	74.00	32.08	PK	Vertical

Note:

1. Level = Reading + Cable loss + Antenna Factor + AMP
2. If Peak Result complies with AV limit, AV Result is deemed to comply with AV limit.
3. Test setup: RBW: 1 MHz, VBW: 3 MHz, Sweep time: auto.

TR-4-E-009 Radiated Emission Test Result

Test Date: 2023-10-19 **Tested By:** Bairong
EUT: Portable Bluetooth Speaker **Model Number:** GO4T
Test Mode: 2DH5 TX 2480MHz **Power Supply:** Battery
Condition: Temp:22.8°C;Humi:54.4% **Test Site:** DDT 3# Chamber
File Path: d:\ts\2023 report data\Q23090801-2E GO4T\FCC ABOVE 1G\15
Memo: Sample Number: S23090801-06

Test Graph

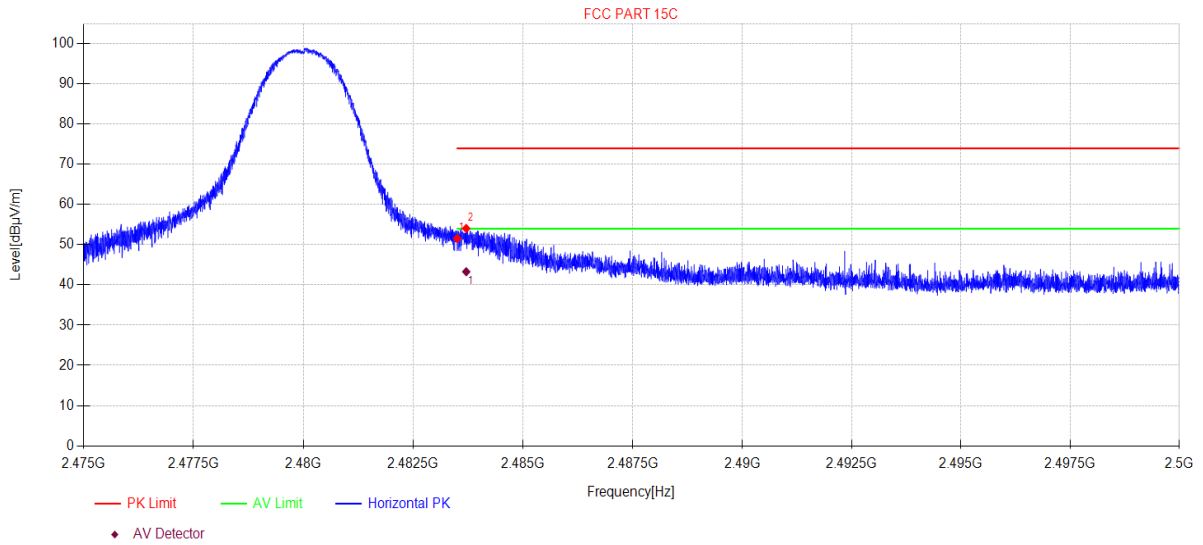

Data List										
NO.	Freq. [MHz]	Reading [dBµV/m]	Cable loss [dB]	Antenna Factor [dB]	AMP [dB]	Level [dBµV/m]	Limit [dBµV/m]	Margin [dB]	Detector	Polarity
1	2483.50	58.46	3.94	27.53	-38.38	51.55	74.00	22.45	PK	Horizontal
2	2483.71	60.97	3.94	27.53	-38.38	54.06	74.00	19.94	PK	Horizontal

Data List										
NO.	Freq. [MHz]	Reading [dBµV/m]	Cable loss [dB]	Antenna Factor [dB]	AMP [dB]	Level [dBµV/m]	Limit [dBµV/m]	Margin [dB]	Detector	Polarity
1	2483.71	50.21	3.94	27.53	-38.38	43.30	54.00	10.70	AV	Horizontal

Note:

- Level = Reading + Cable loss + Antenna Factor + AMP
- If Peak Result complies with AV limit, AV Result is deemed to comply with AV limit.
- Test setup: RBW: 1 MHz, VBW: 3 MHz, Sweep time: auto.

TR-4-E-009 Radiated Emission Test Result

Test Date: 2023-10-19 **Tested By:** Bairong
EUT: Portable Bluetooth Speaker **Model Number:** GO4T
Test Mode: 2DH5 TX 2480MHz **Power Supply:** Battery
Condition: Temp:22.8°C;Humi:54.4% **Test Site:** DDT 3# Chamber
File Path: d:\ts\2023 report data\Q23090801-2E GO4T\FCC ABOVE 1G\16
Memo: Sample Number: S23090801-06

Test Graph

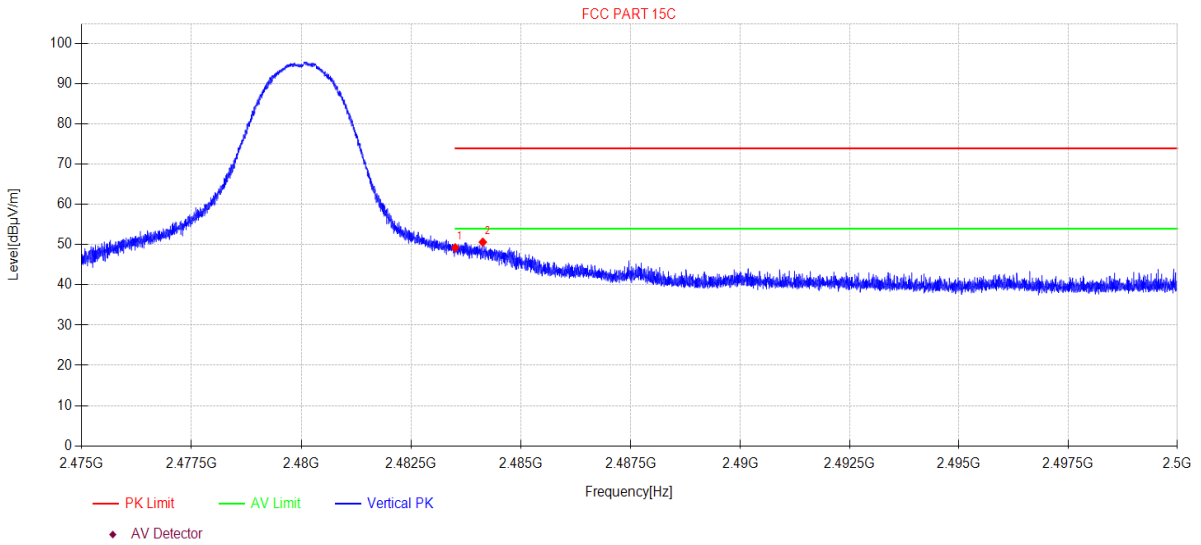

Data List										
NO.	Freq. [MHz]	Reading [dBµV/m]	Cable loss [dB]	Antenna Factor [dB]	AMP [dB]	Level [dBµV/m]	Limit [dBµV/m]	Margin [dB]	Detector	Polarity
1	2483.50	56.18	3.94	27.53	-38.38	49.27	74.00	24.73	PK	Vertical
2	2484.13	57.56	3.94	27.54	-38.38	50.66	74.00	23.34	PK	Vertical

Note:

1. Level = Reading + Cable loss + Antenna Factor + AMP
2. If Peak Result complies with AV limit, AV Result is deemed to comply with AV limit.
3. Test setup: RBW: 1 MHz, VBW: 3 MHz, Sweep time: auto.

15. Power Line Conducted Emission

15.1. Test equipment

Equipment	Manufacturer	Model No.	Serial Number	Due Date
☑Power Line Conducted Emissions Test 1#				
Test Receiver	R&S	ESCI	100551	2024/07/10
LISN 1	R&S	ENV216	101109	2024/07/10
LISN 2	R&S	ESH2-Z5	100309	2024/07/11
Pulse Limiter	R&S	ESH3-Z2	101242	2024/07/14
CE Cable 1	HUBSER	N/A	W10.01	2024/07/14
Test software	Audix	E3	V 6.11111b	N/A

15.2. Block diagram of test setup

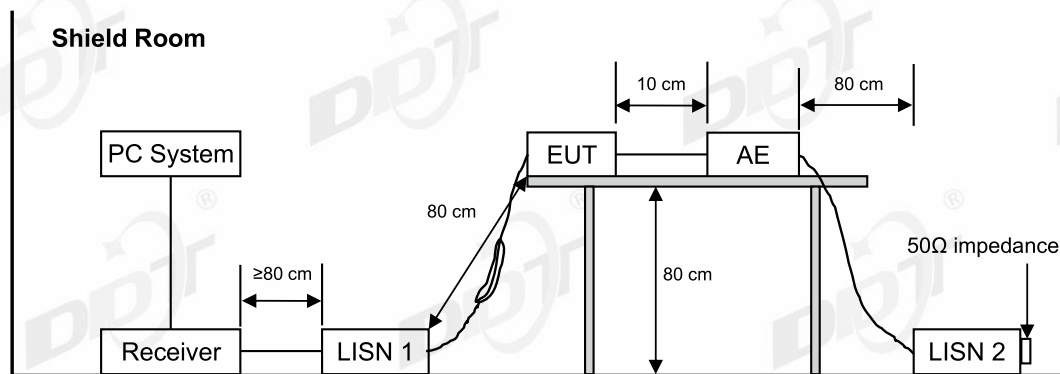

15.3. Power line conducted emission limits

Frequency	Quasi-Peak Level dB(μV)	Average Level dB(μV)
150 kHz ~ 500 kHz	66 ~ 56*	56 ~ 46*
500 kHz ~ 5 MHz	56	46
5 MHz ~ 30 MHz	60	50

Note 1: * Decreasing linearly with logarithm of frequency.

Note 2: The lower limit shall apply at the transition frequencies.

15.4. Test procedure

The EUT and Support equipment, if needed, were put placed on a non-metallic table, 80cm above the ground plane.

All support equipment power received from a second LISN.

Emissions were measured on each current carrying line of the EUT using an EMI Test Receiver

connected to the LISN powering the EUT.

The Receiver scanned from 150 kHz to 30 MHz for emissions in each of the test modes.

During the above scans, the emissions were maximized by cable manipulation.

The test mode(s) described in clause 2.4 were scanned during the preliminary test.

After the preliminary scan, we found the test mode producing the highest emission level.

The EUT configuration and worse cable configuration of the above highest emission levels were recorded for reference of the final test.

EUT and support equipment were set up on the test bench as per the configuration with highest emission level in the preliminary test.

A scan was taken on both power lines, Neutral and Line, recording at least the six highest emissions.

Emission frequency and amplitude were recorded into a computer in which correction factors were used to calculate the emission level and compare reading to the applicable limit.

The test data of the worst-case condition(s) was recorded.

The bandwidth of test receiver is set at 9 kHz.

15.5. Test result

Pass. (See below detailed test result)

Note1: All emissions not reported below are too low against the prescribed limits.

Note2: “-----” means Peak detection; “-----” means Average detection.

Note3: Pre-test AC conducted emission at both voltage AC 120V/60Hz and AC 240V/50Hz, recorded the worst case.

TR-4-E-010 Conducted Emission Test Result

Test Site : DDT 1# Shield Room **D:\2023 CE report data\Q23090801-2E\FCC CE.EM6**
Test Date : 2023-10-20 **Tested By** : Junchang Du
EUT : PORTABLE BLUETOOTH SPEAKER **Model Number** : GO4T
Power Supply : AC 120V/60Hz **Test Mode** : Tx mode
Condition : TEMP:23.4°C, RH:52.6% **LISN** : 2023 1# ENV216/NEUTRAL
Memo :

Data: 2

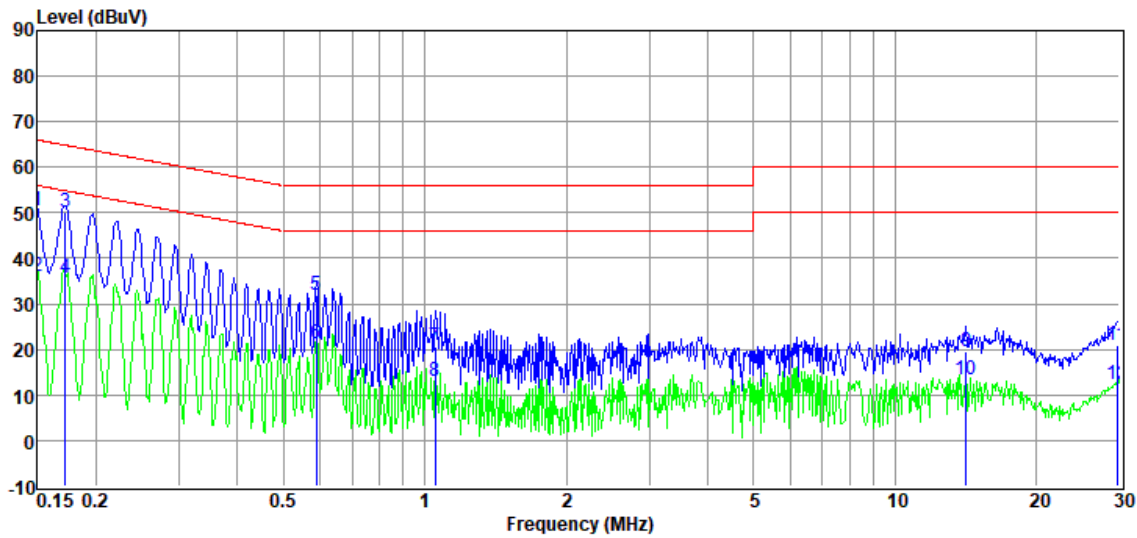

Item (Mark)	Freq. (MHz)	Read Level (dBμV)	LISN Factor (dB)	Cable Loss (dB)	Pulse Limiter Factor (dB)	Result Level (dBμV)	Limit Line (dBμV)	Over Limit (dB)	Detector	Phase
1	0.15	30.12	9.83	0.92	9.68	50.55	66.00	-15.45	QP	NEUTRAL
2	0.15	15.55	9.83	0.92	9.68	35.98	56.00	-20.02	Average	NEUTRAL
3	0.17	29.65	9.88	0.92	9.68	50.13	64.86	-14.73	QP	NEUTRAL
4	0.17	15.12	9.88	0.92	9.68	35.60	54.86	-19.26	Average	NEUTRAL
5	0.59	11.42	9.82	0.82	9.72	31.78	56.00	-24.22	QP	NEUTRAL
6	0.59	0.95	9.82	0.82	9.72	21.31	46.00	-24.69	Average	NEUTRAL
7	1.05	0.29	9.75	0.67	9.73	20.44	56.00	-35.56	QP	NEUTRAL
8	1.05	-7.10	9.75	0.67	9.73	13.05	46.00	-32.95	Average	NEUTRAL
9	14.14	-0.27	9.77	0.25	9.87	19.62	60.00	-40.38	QP	NEUTRAL
10	14.14	-6.59	9.77	0.25	9.87	13.30	50.00	-36.70	Average	NEUTRAL
11	29.68	0.28	10.11	0.51	9.91	20.81	60.00	-39.19	QP	NEUTRAL
12	29.68	-8.16	10.11	0.51	9.91	12.37	50.00	-37.63	Average	NEUTRAL

Note:

1. Result Level = Read Level + LISN Factor + Pulse Limiter Factor + Cable loss.
2. If QP Result complies with AV limit, AV Result is deemed to comply with AV limit.
3. Test setup: RBW: 200 Hz (9 kHz—150 kHz), 9 kHz (150 kHz—30 MHz).
4. Step size: 80Hz (0.009MHz-0.15MHz), 4 kHz (0.15MHz-30MHz), Scan time: auto.

TR-4-E-010 Conducted Emission Test Result

Test Site : DDT 1# Shield Room D:\2023 CE report data\Q23090801-2E\FCC CE.EM6
Test Date : 2023-10-20 **Tested By** : Junchang Du
EUT : PORTABLE BLUETOOTH SPEAKER **Model Number** : GO4T
Power Supply : AC 120V/60Hz **Test Mode** : Tx mode
Condition : TEMP:23.4°C, RH:52.6% **LISN** : 2023 1# ENV216/LINE
Memo :

Data: 4

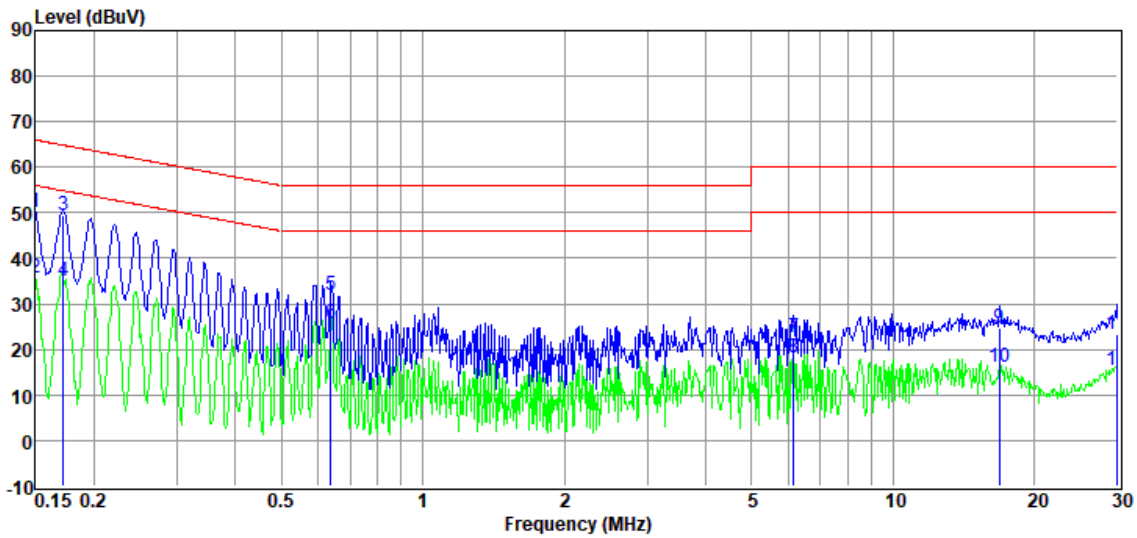

Item (Mark)	Freq. (MHz)	Read Level (dBμV)	LISN Factor (dB)	Cable Loss (dB)	Pulse Limiter Factor (dB)	Result Level (dBμV)	Limit Line (dBμV)	Over Limit (dB)	Detector	Phase
1	0.15	29.54	9.85	0.92	9.68	49.99	66.00	-16.01	QP	LINE
2	0.15	15.17	9.85	0.92	9.68	35.62	56.00	-20.38	Average	LINE
3	0.17	28.94	9.74	0.92	9.68	49.28	64.86	-15.58	QP	LINE
4	0.17	14.73	9.74	0.92	9.68	35.07	54.86	-19.79	Average	LINE
5	0.64	11.59	9.77	0.80	9.72	31.88	56.00	-24.12	QP	LINE
6	0.64	5.32	9.77	0.80	9.72	25.61	46.00	-20.39	Average	LINE
7	6.15	2.55	9.70	0.48	9.80	22.53	60.00	-37.47	QP	LINE
8	6.15	-1.65	9.70	0.48	9.80	18.33	50.00	-31.67	Average	LINE
9	16.84	4.49	9.83	0.34	9.90	24.56	60.00	-35.44	QP	LINE
10	16.84	-3.92	9.83	0.34	9.90	16.15	50.00	-33.85	Average	LINE
11	29.84	2.71	10.20	0.50	9.91	23.32	60.00	-36.68	QP	LINE
12	29.84	-5.33	10.20	0.50	9.91	15.28	50.00	-34.72	Average	LINE

Note:

1. Result Level = Read Level + LISN Factor + Pulse Limiter Factor + Cable loss.
2. If QP Result complies with AV limit, AV Result is deemed to comply with AV limit.
3. Test setup: RBW: 200 Hz (9 kHz—150 kHz), 9 kHz (150 kHz—30 MHz).
4. Step size: 80Hz (0.009MHz-0.15MHz), 4 kHz (0.15MHz-30MHz), Scan time: auto.

16. Antenna Requirements

16.1. Limit

For intentional device, according to FCC 47 CFR Section 15.203, an intentional radiator shall be designed to ensure that no antenna other than that furnished by the responsible party shall be used with the device. And according to FCC 47 CFR Section 15.247 (b), if transmitting antennas of directional gain greater than 6 dBi are used, the power shall be reduced by the amount in dB that the directional gain of the antenna exceeds 6 dBi.

For intentional device, according to RSS-Gen issue 5 section 6.8.

The applicant for equipment certification shall provide a list of all antenna types that may be used with the transmitter, where applicable (i.e. for transmitters with detachable antenna), indicating the maximum permissible antenna gain (in dBi) and the required impedance for each antenna. The test report shall demonstrate the compliance of the transmitter with the limit for maximum equivalent isotropically radiated power (e.i.r.p.) specified in the applicable RSS, when the transmitter is equipped with any antenna type, selected from this list.

16.2. Result

The antenna used for this product as Antenna information described in section 2.1 of the report, and there is no other antenna than that furnished by the responsible party shall be used with the device.

18. Photos of the EUT

Please refer to DDT-Q23090801-1E Appendix I.

END OF REPORT