

Right side:

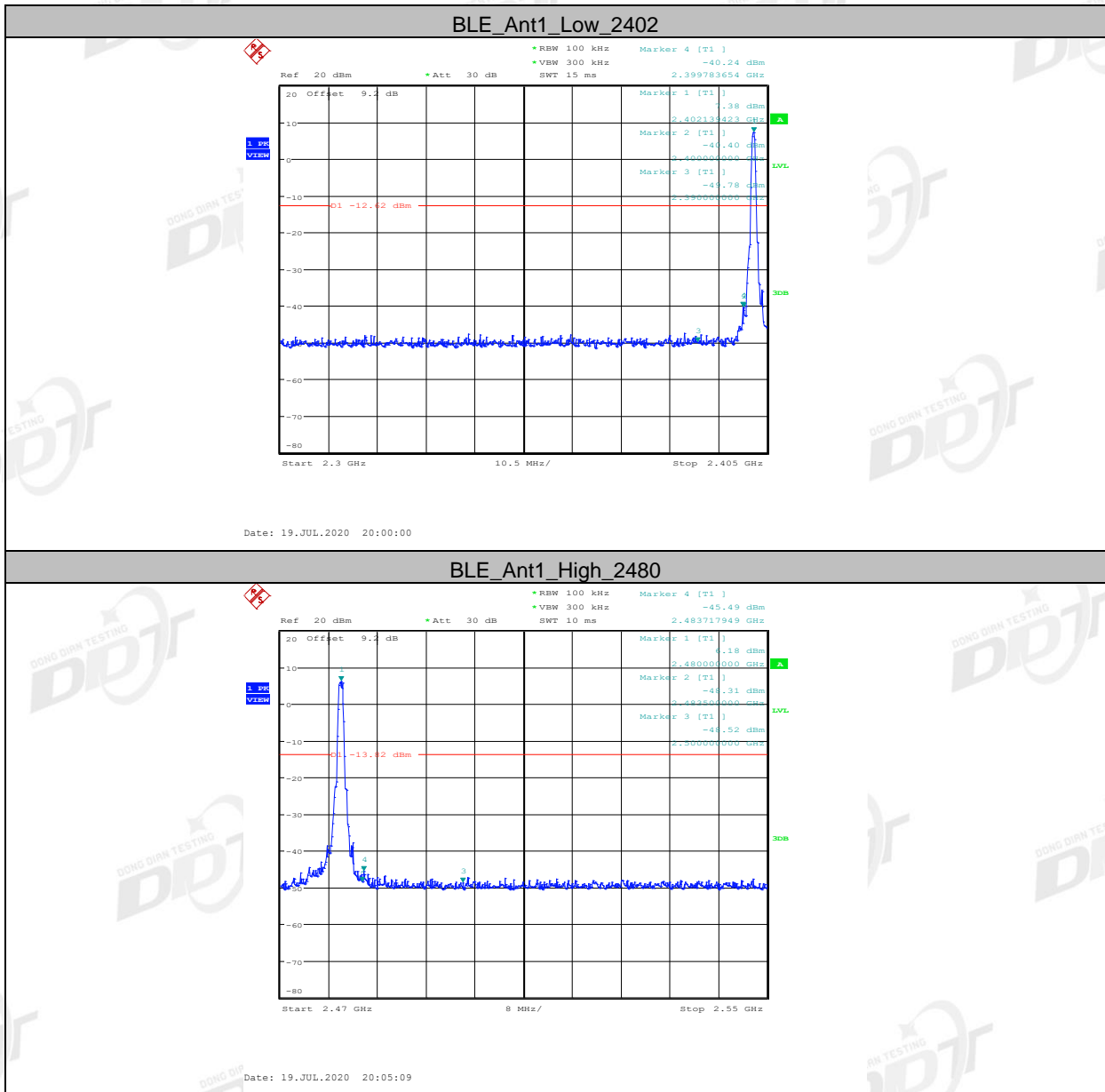

## 8. Radiated Emission

### 8.1. Block diagram of test setup

In 3 m Anechoic Chamber, test setup diagram for 9 kHz - 30 MHz:

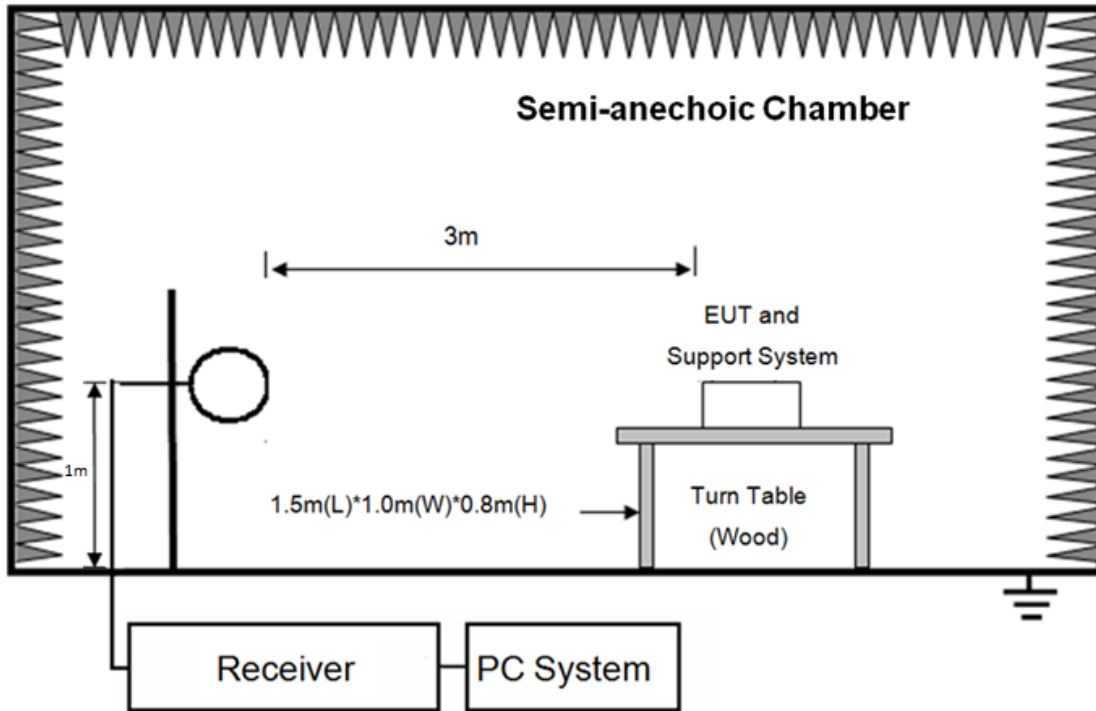

In 3 m Anechoic Chamber, test setup diagram for 30 MHz - 1 GHz:

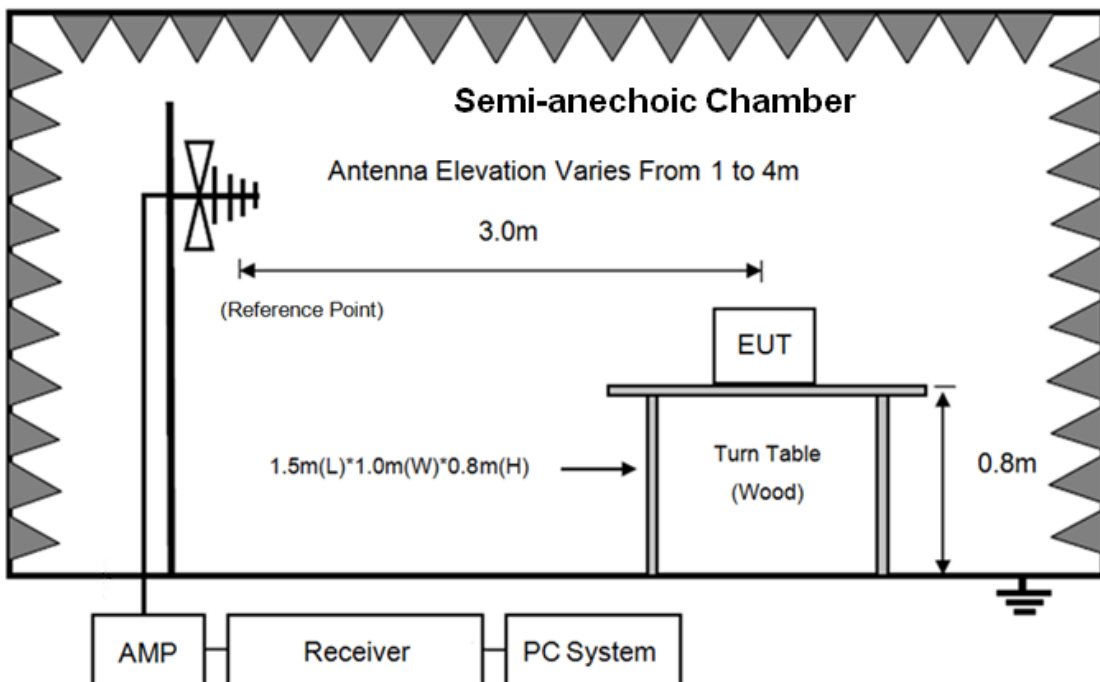

In 3 m Anechoic Chamber, test setup diagram for frequency above 1 GHz:

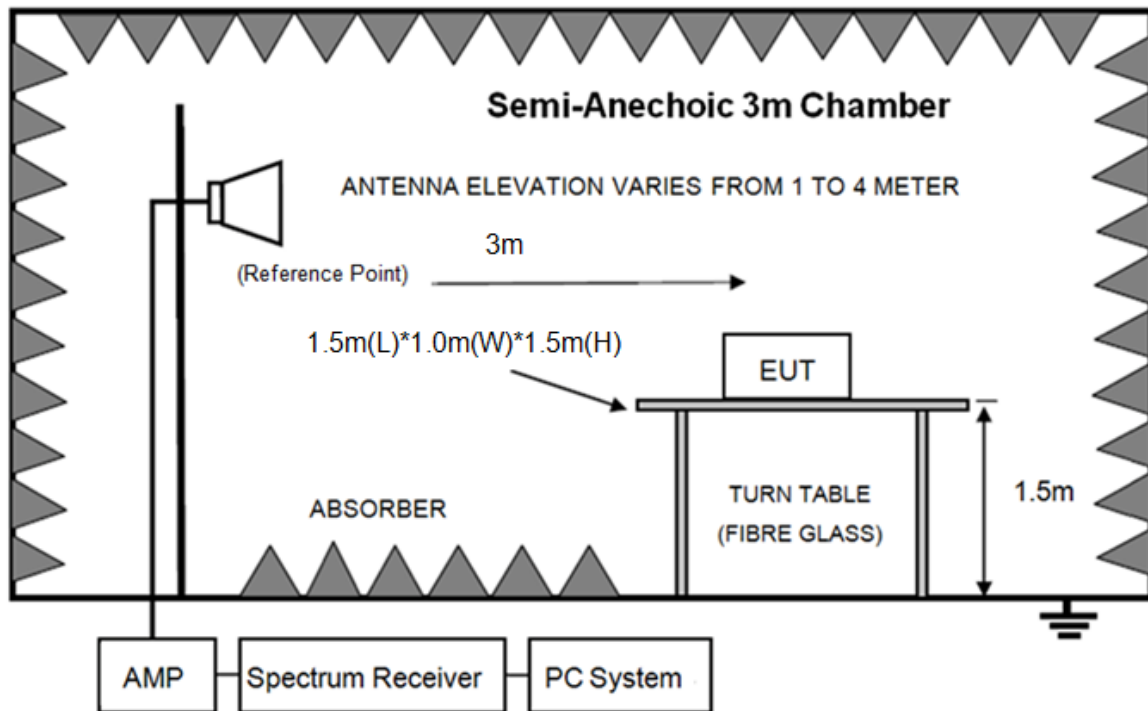

Note: For harmonic emissions test an appropriate high pass filter was inserted in the input port of AMP.

## 8.2. Limit

### 8.2.1 FCC 15.205 Restricted frequency band

MHz	MHz	MHz	GHz
0.090-0.110	16.42-16.423	399.9-410	4.5-5.15
<sup>1</sup> 0.495-0.505	16.69475-16.69525	608-614	5.35-5.46
2.1735-2.1905	16.80425-16.80475	960-1240	7.25-7.75
4.125-4.128	25.5-25.67	1300-1427	8.025-8.5
4.1772&4.17775	37.5-38.25	1435-1626.5	9.0-9.2
4.2072&4.20775	73-74.6	1645.5-1646.5	9.3-9.5
6.215-6.218	74.8-75.2	1660-1710	10.6-12.7
6.26775-6.26825	108-121.94	1718.8-1722.2	13.25-13.4
6.31175-6.31225	123-138	2200-2300	14.47-14.5
8.291-8.294	149.9-150.05	2310-2390	15.35-16.2
8.362-8.366	156.52475-156.52525	2483.5-2500	17.7-21.4
8.37625-8.38675	156.7-156.9	2690-2900	22.01-23.12
8.41425-8.41475	162.0125-167.17	3260-3267	23.6-24.0
12.29-12.293	167.72-173.2	3332-3339	31.2-31.8
12.51975-12.52025	240-285	3345.8-3358	36.43-36.5
12.57675-12.57725	322-335.4	3600-4400	( <sup>2</sup> )
13.36-13.41			

<sup>1</sup>Until February 1, 1999, this restricted band shall be 0.490-0.510 MHz.

<sup>2</sup>Above 38.6

## 8.2.2 FCC 15.209 Limit.

FREQUENCY MHz	DISTANCE Meters	FIELD STRENGTHS LIMIT	
		$\mu\text{V}/\text{m}$	$\text{dB}(\mu\text{V})/\text{m}$
0.009 ~ 0.490	300	2400/F(kHz)	67.6-20log(F)
0.490 ~ 1.705	30	24000/F(kHz)	87.6-20log(F)
1.705 ~ 30.0	30	30	29.54
30 ~ 88	3	100	40.0
88 ~ 216	3	150	43.5
216 ~ 960	3	200	46.0
960 ~ 1000	3	500	54.0
Above 1000	3	74.0 dB( $\mu\text{V}$ )/m (Peak) 54.0 dB( $\mu\text{V}$ )/m (Average)	

Note: (1) The emission limits shown in the above table are based on measurements employing a CISPR QP detector except for the frequency bands 9 - 90 kHz, 110 - 490 kHz and above 1000 MHz. Radiated emissions limits in these three bands are based on measurements employing an average detector.

(2) At frequencies below 30 MHz, measurement may be performed at a distance closer than that specified, and the limit at closer measurement distance can be extrapolated by below formula:

$$\text{Limit}_{3\text{m}}(\text{dB}\mu\text{V}/\text{m}) = \text{Limit}_{30\text{m}}(\text{dB}\mu\text{V}/\text{m}) + 40\text{Log}(30\text{m}/3\text{m})$$

## 8.2.3 Limit for this EUT

All the emissions appearing within 15.205 restricted frequency bands shall not exceed the limits shown in 15.209, all the other emissions shall be at least 20 dB below the fundamental emissions or comply with 15.209 limits.

## 8.3. Test Procedure

- (1) EUT was placed on a non-metallic table, 80 cm above the ground plane inside a semi-anechoic chamber for below 1 G and 150 cm above the ground plane inside a semi-anechoic chamber for above 1 G.
- (2) Test antenna was located 3 m from the EUT on an adjustable mast, and the antenna used as below table.

Test frequency range	Test antenna used	Test antenna distance
9 kHz - 30 MHz	Active Loop antenna	3 m
30 MHz - 1 GHz	Trilog Broadband Antenna	3 m
1 GHz - 18 GHz	Double Ridged Horn Antenna (1 GHz - 18 GHz)	3 m
18 GHz - 40 GHz	Horn Antenna (18 GHz - 40 GHz)	1 m

According ANSI C63.10:2013 clause 6.4.4.2 and 6.5.3, for measurements below 30 MHz, the loop antenna was positioned with its plane vertical from the EUT and rotated about its vertical axis for maximum response at each azimuth position around the EUT. And the loop antenna also is positioned with its plane horizontal at the specified distance from the EUT. The center of the

loop is 1 m above the ground. For measurement above 30 MHz, the Trilog Broadband Antenna or Horn Antenna was located 3 m from EUT, Measurements were made with the antenna positioned in both the horizontal and vertical planes of Polarization, and the measurement antenna was varied from 1 m to 4 m. in height above the reference ground plane to obtain the maximum signal strength.

(3) Below pre-scan procedure was first performed in order to find prominent frequency spectrum radiated emissions from 9 kHz to 25 GHz:

(a) Scanning the peak frequency spectrum with the antenna specified in step (3), and the EUT was rotated 360 degree, the antenna height was varied from 1 m to 4 m (Except loop antenna, it's fixed 1 m above ground.)

(b) Change work frequency or channel of device if practicable.

(c) Change modulation type of device if practicable.

(d) Change power supply range from 85% to 115% of the rated supply voltage

(e) Rotated EUT though three orthogonal axes to determine the attitude of EUT arrangement produces highest emissions.

Spectrum frequency from 9 kHz to 25 GHz (tenth harmonic of fundamental frequency) was investigated, and no any obvious emission were detected from 9 kHz to 30 MHz and 18 GHz to 25 GHz, so below final test was performed with frequency range from 30 MHz to 18 GHz.

(4) For final emissions measurements at each frequency of interest, the EUT was rotated and the antenna height was varied between 1 m and 4 m in order to maximize the emission. Measurements in both horizontal and vertical polarities were made and the data was recorded. In order to find the maximum emission, the relative positions of equipments and all of the interface cables were changed according to ANSI C63.10:2013 on Radiated Emission test.

(5) The emissions from 9 kHz to 1 GHz were measured based on CISPR QP detector except for the frequency bands 9 - 90 kHz, 110 - 490 kHz, for emissions from 9 kHz - 90 kHz, 110 kHz - 490 kHz and above 1 GHz were measured based on average detector, for emissions above 1 GHz, peak emissions also be measured and need comply with Peak limit.

(6) The emissions from 9 kHz to 1 GHz, QP or average values were measured with EMI receiver with below RBW

Frequency band	RBW
9 kHz - 150 kHz	200 Hz
150 kHz - 30 MHz	9 kHz
30 MHz - 1 GHz	120 kHz

(7) For emissions above 1 GHz, both Peak and Average level were measured with Spectrum Analyzer, and the RBW is set at 1 MHz, VBW is set at 3 MHz for Peak measure; According ANSI C63.10:2013 clause 4.1.4.2.2 procedure for average measure.

(8) X axis, Y axis, Z axis are tested, and worse setup X axis is reported.

#### 8.4. Test result

Pass. (See below detailed test result)

All the emissions except fundamental emission from 9 kHz to 25 GHz were comply with 15.209 limit.

Note1: According exploratory test, the emission levels are 20 dB below the limit detected from 9 kHz to 30 MHz and 18 GHz to 25 GHz, so the final test was performed with frequency range from 30 MHz to 18 GHz and recorded in below.

Note2: For emissions below 1 GHz, according exploratory explorer test, when change Tx mode and channel, have no distinct influence on emissions level, so for emissions below 1 GHz, the final test was only performed with EUT working in right side GFSK, Tx 2440 MHz mode.

Note3: For emissions above 1 GHz. If peak results comply with AV limit, AV Result is deemed to comply with AV limit.

## Radiated Emission test (below 1 GHz) TR-4-E-009 Radiated Emission Test Result

Test Site : DDT 3m Chamber 1#	D:\2020 RE 1# Report data\Q20053003-1E\FCC BELOW1G.EM6
Test Date : 2020-07-16	Tested By : Ella
EUT : BLUETOOTH HEADSET	Model Number : FREEII
Power Supply : Battery	Test Mode : Tx mode
Condition : Temp:24.5°C,Humi:55%,Press:100.1kPa	Antenna/Distance : 2019 VULB 9163 1#/3m/VERTICAL
Memo :	

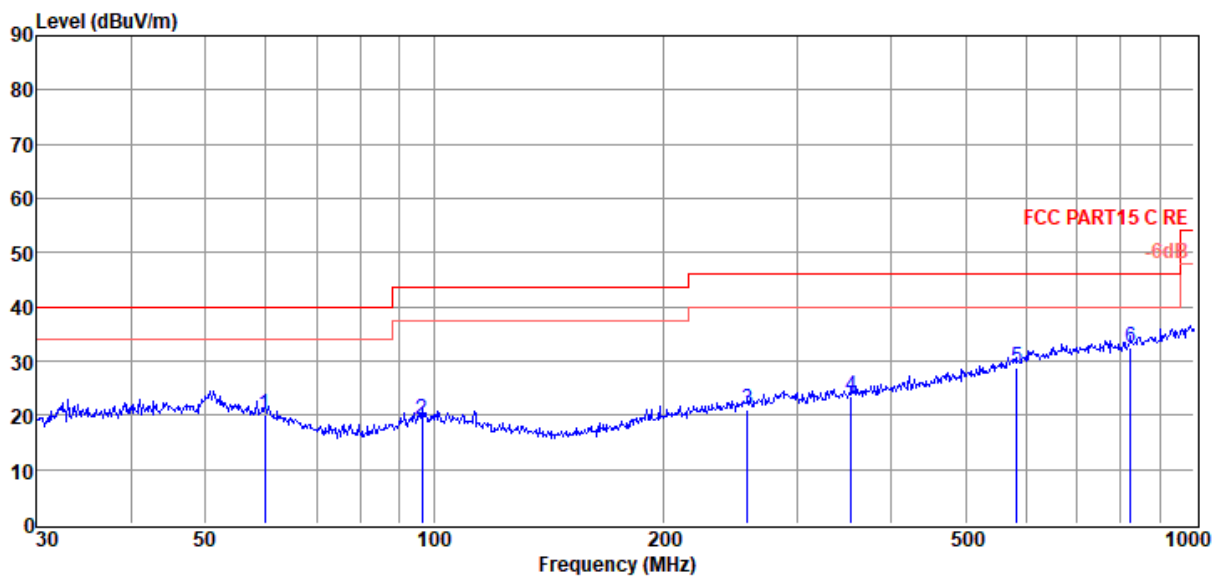

Item (Mark)	Freq. (MHz)	Read Level (dBμV)	Antenna Factor (dB/m)	Cable Loss dB	Result Level (dBμV/m)	Limit Line (dBμV/m)	Over Limit (dB)	Detector	Polarization
1	59.86	3.06	13.02	4.09	20.17	40.00	-19.83	QP	VERTICAL
2	96.44	3.36	11.56	4.38	19.30	43.50	-24.20	QP	VERTICAL
3	258.33	2.69	13.10	5.33	21.12	46.00	-24.88	QP	VERTICAL
4	354.18	2.79	14.79	5.77	23.35	46.00	-22.65	QP	VERTICAL
5	584.79	3.17	18.92	6.68	28.77	46.00	-17.23	QP	VERTICAL
6	824.60	4.16	20.98	7.45	32.59	46.00	-13.41	QP	VERTICAL

- Note: 1. Result Level = Read Level + Antenna Factor + Cable loss.  
 2. If Peak Result complies with QP limit, QP Result is deemed to comply with QP limit.  
 3. Test setup: RBW: 120 kHz, VBW: 300 kHz, Sweep time: auto.

## TR-4-E-009 Radiated Emission Test Result

**Test Site** : DDT 3m Chamber 1#

D:\2020 RE 1# Report data\Q20053003-1\FCC  
BELOW1G.EM6

**Test Date** : 2020-07-16

**Tested By** : Ella

**EUT** : BLUETOOTH HEADSET

**Model Number** : FREEII

**Power Supply** : Battery

**Test Mode** : Tx mode

**Condition** : Temp:24.5°C,Humi:55%,Press:100.1kPa

**Antenna/Distance** : 2019 VULB 9163 1#/3m/HORIZONTAL

**Memo** :

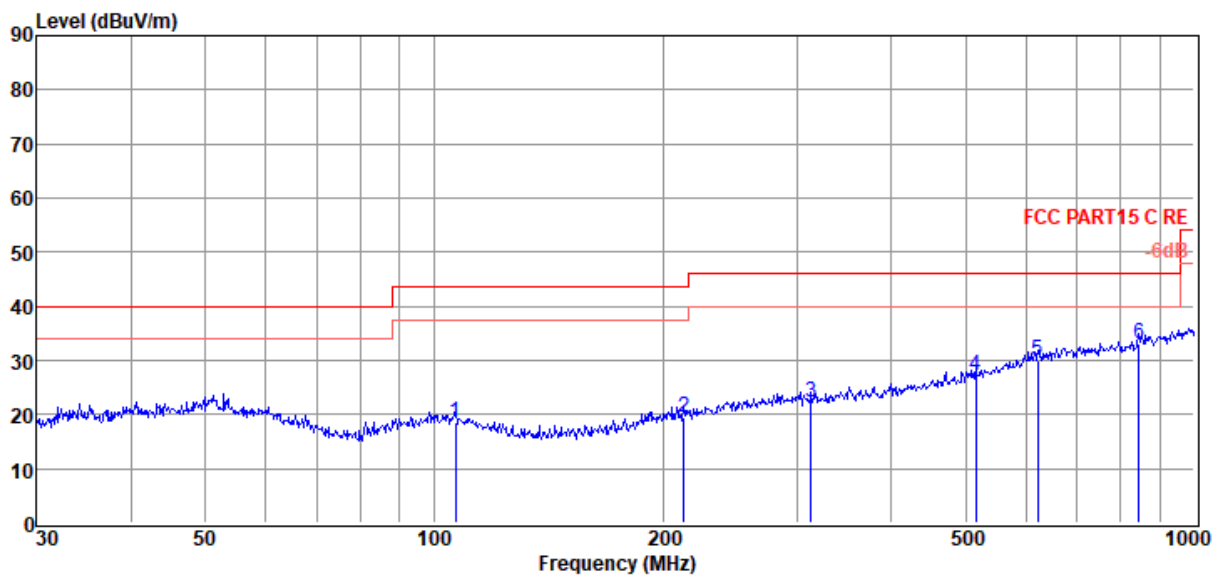

Item (Mark)	Freq. (MHz)	Read Level (dBμV)	Antenna Factor (dB/m)	Cable Loss dB	Result Level (dBμV/m)	Limit Line (dBμV/m)	Over Limit (dB)	Detector	Polarization
1	106.76	2.62	11.49	4.46	18.57	43.50	-24.93	QP	HORIZONTAL
2	213.02	2.55	11.82	5.10	19.47	43.50	-24.03	QP	HORIZONTAL
3	313.28	2.30	14.28	5.59	22.17	46.00	-23.83	QP	HORIZONTAL
4	515.44	3.14	17.53	6.41	27.08	46.00	-18.92	QP	HORIZONTAL
5	622.89	3.68	19.37	6.82	29.87	46.00	-16.13	QP	HORIZONTAL
6	845.09	4.33	21.21	7.52	33.06	46.00	-12.94	QP	HORIZONTAL

Note: 1. Result Level = Read Level + Antenna Factor + Cable loss.

2. If Peak Result complies with QP limit, QP Result is deemed to comply with QP limit.

3. Test setup: RBW: 120 kHz, VBW: 300 kHz, Sweep time: auto.



**Radiated Emission test (above 1 GHz)**

Freq. (MHz)	Read level (dB $\mu$ V)	Antenna Factor (dB/m)	PRM Factor (dB)	Cable Loss (dB)	Result Level (dB $\mu$ V/m)	Limit (dB $\mu$ V/m)	Margin (dB)	Detector type	Polarization
Tx mode 2402 MHz									
3601.00	50.46	29.56	43.68	5.26	41.60	74.00	-32.40	Peak	HORIZONTAL
4791.00	63.79	32.21	43.49	6.15	58.66	74.00	-15.34	Peak	HORIZONTAL
4804.00	53.06	32.23	43.48	6.16	47.97	54.00	-6.03	Average	HORIZONTAL
7885.00	43.63	37.84	42.82	8.56	47.21	74.00	-26.79	Peak	HORIZONTAL
9925.00	43.31	39.44	42.41	9.32	49.66	74.00	-24.34	Peak	HORIZONTAL
11540.00	44.19	39.65	42.32	9.98	51.50	74.00	-22.50	Peak	HORIZONTAL
14379.00	41.40	40.82	40.26	11.20	53.16	74.00	-20.84	Peak	HORIZONTAL
4804.00	59.09	32.23	43.48	6.16	54.00	74.00	-20.00	Peak	VERTICAL
4804.00	48.96	32.23	43.48	6.16	43.87	54.00	-10.13	Average	VERTICAL
7681.00	44.19	37.55	42.84	8.33	47.23	74.00	-26.77	Peak	VERTICAL
9636.00	44.10	39.21	42.47	9.10	49.94	74.00	-24.06	Peak	VERTICAL
11795.00	43.80	39.35	42.31	10.29	51.13	74.00	-22.87	Peak	VERTICAL
13920.00	41.14	40.80	40.37	10.91	52.48	74.00	-21.52	Peak	VERTICAL
15620.00	41.85	38.86	40.14	11.57	52.14	74.00	-21.86	Peak	VERTICAL
Tx mode 2440 MHz									
2479.00	51.30	27.66	43.25	4.12	39.83	74.00	-34.17	Peak	HORIZONTAL
4876.00	58.64	32.33	43.46	6.20	53.71	74.00	-20.29	Peak	HORIZONTAL
7681.00	43.78	37.55	42.84	8.33	46.82	74.00	-27.18	Peak	HORIZONTAL
10469.00	42.83	40.16	42.37	9.34	49.96	74.00	-24.04	Peak	HORIZONTAL
12849.00	43.47	39.30	41.41	10.67	52.03	74.00	-21.97	Peak	HORIZONTAL
16249.00	42.05	39.50	40.09	11.77	53.23	74.00	-20.77	Peak	HORIZONTAL
4880.00	52.18	32.33	43.46	6.20	47.25	74.00	-26.75	Peak	VERTICAL
8055.00	44.72	37.97	42.79	8.69	48.59	74.00	-25.41	Peak	VERTICAL
9296.00	44.14	38.94	42.53	8.83	49.38	74.00	-24.62	Peak	VERTICAL
12169.00	43.84	38.93	42.12	10.57	51.22	74.00	-22.78	Peak	VERTICAL
13801.00	41.66	40.66	40.49	10.88	52.71	74.00	-21.29	Peak	VERTICAL
15076.00	41.35	39.85	40.19	11.64	52.65	74.00	-21.35	Peak	VERTICAL
Tx mode 2480 MHz									
3720.00	50.54	29.87	43.72	5.39	42.08	74.00	-31.92	Peak	HORIZONTAL
4960.00	52.30	32.44	43.43	6.25	47.56	74.00	-26.44	Peak	HORIZONTAL
7936.00	44.44	37.91	42.81	8.62	48.16	74.00	-25.84	Peak	HORIZONTAL
11574.00	43.90	39.61	42.32	10.02	51.21	74.00	-22.79	Peak	HORIZONTAL
13461.00	43.32	40.25	40.81	10.80	53.56	74.00	-20.44	Peak	HORIZONTAL
14940.00	40.94	40.10	40.20	11.61	52.45	74.00	-21.55	Peak	HORIZONTAL
4960.00	49.10	32.44	43.43	6.25	44.36	74.00	-29.64	Peak	VERTICAL
7936.00	44.19	37.91	42.81	8.62	47.91	74.00	-26.09	Peak	VERTICAL
10146.00	43.51	39.70	42.39	9.37	50.19	74.00	-23.81	Peak	VERTICAL
11540.00	45.04	39.65	42.32	9.98	52.35	74.00	-21.65	Peak	VERTICAL
13444.00	42.44	40.22	40.83	10.80	52.63	74.00	-21.37	Peak	VERTICAL
15620.00	41.32	38.86	40.14	11.57	51.61	74.00	-22.39	Peak	VERTICAL
Verdict: Pass									

Note: 1. Scan with all side, the worst case is right side recorded in this report.

2. Result Level = Read Level + Antenna Factor + Cable loss - PRM Factor.
3. For emissions above 1GHz. If peak results comply with AV limit, AV Result is deemed to comply with AV limit.

## 9. RF Conducted Spurious Emissions

### 9.1. Block diagram of test setup

Same as section 4.1

### 9.2. Limits

In any 100 kHz bandwidth outside the frequency bands in which the spread spectrum intentional radiator is operating, the radio frequency power that is produced by the intentional radiator shall be at least 20 dB below that in the 100 kHz bandwidth within the band that contains the highest level of the desired power.

### 9.3. Test procedure

- (1) Connect EUT's antenna output to spectrum analyzer by RF cable.
- (2) Establish a reference level by using the following procedure:

Center frequency	Test frequency
RBW:	100 kHz
VBW:	300 kHz
Span	Wide enough to capture the peak level of the in-band emission
Detector Mode:	Peak
Sweep time:	auto
Trace mode	Max hold

- (3) Allow the trace to stabilize, use the peak marker function to determine the maximum peak power level to establish the reference level.

- (4) Set the spectrum analyzer as follows:

RBW:	100 kHz
VBW:	300 kHz
Span	Encompass frequency range to be measured
Number of measurement points	$\geq \text{span}/\text{RBW}$
Detector Mode:	Peak
Sweep time:	auto
Trace mode	Max hold

- (5) Allow the trace to stabilize, use the peak marker function to determine the maximum amplitude of all unwanted emissions outside of the authorized frequency band

### 9.4. Test result

Mode	Freq. (MHz)	Verdict
GFSK	2402	Pass
	2440	Pass
	2480	Pass

### 9.5. Original test data

Left side:



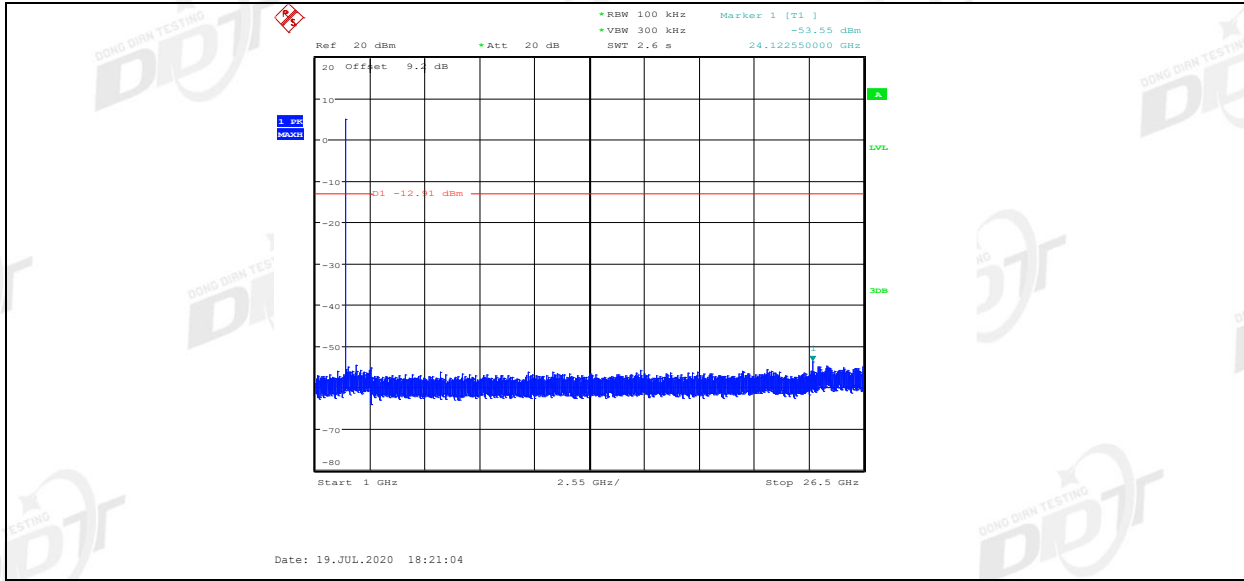

BLE\_Ant1\_2440\_0~Reference



BLE\_Ant1\_2440\_30~1000

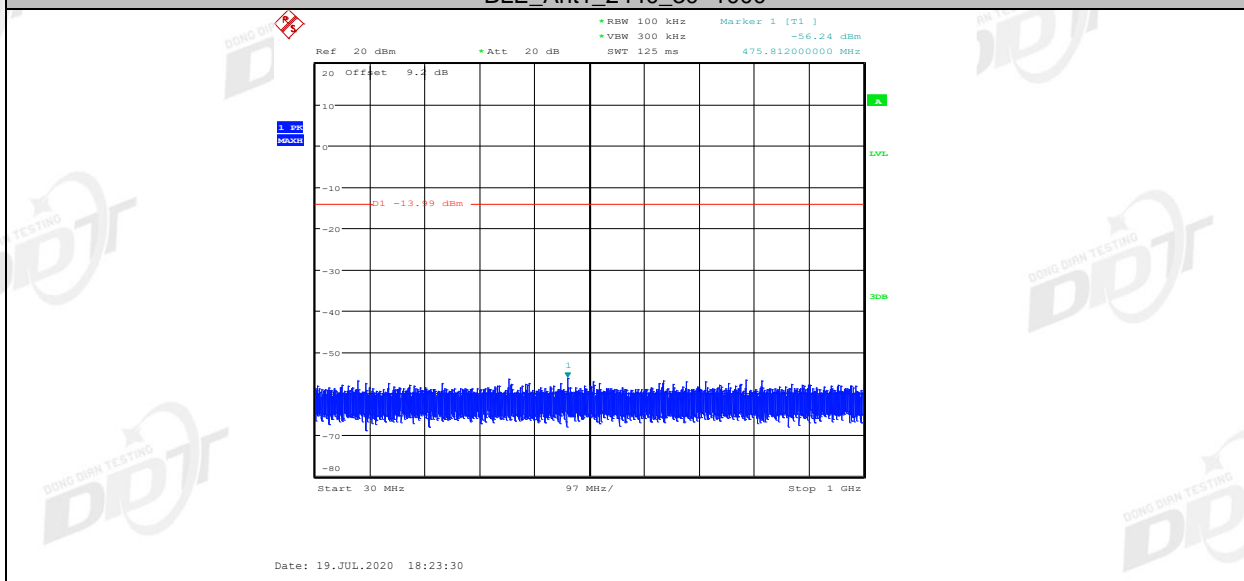

BLE\_Ant1\_2440\_1000~26500

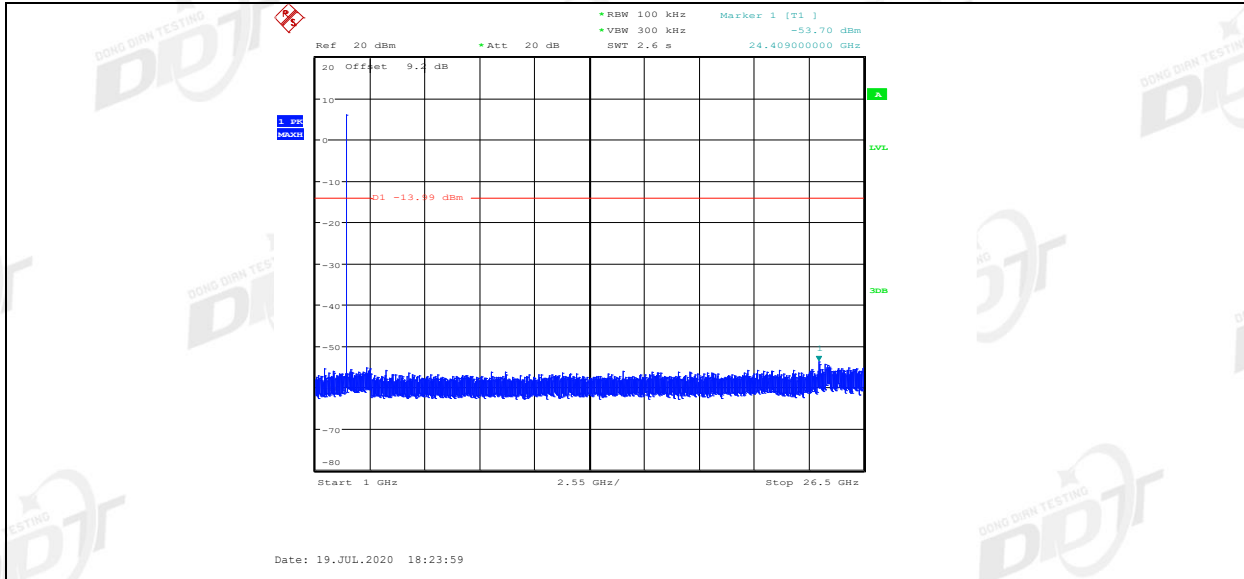

BLE\_Ant1\_2480\_0~Reference



BLE\_Ant1\_2480\_30~1000

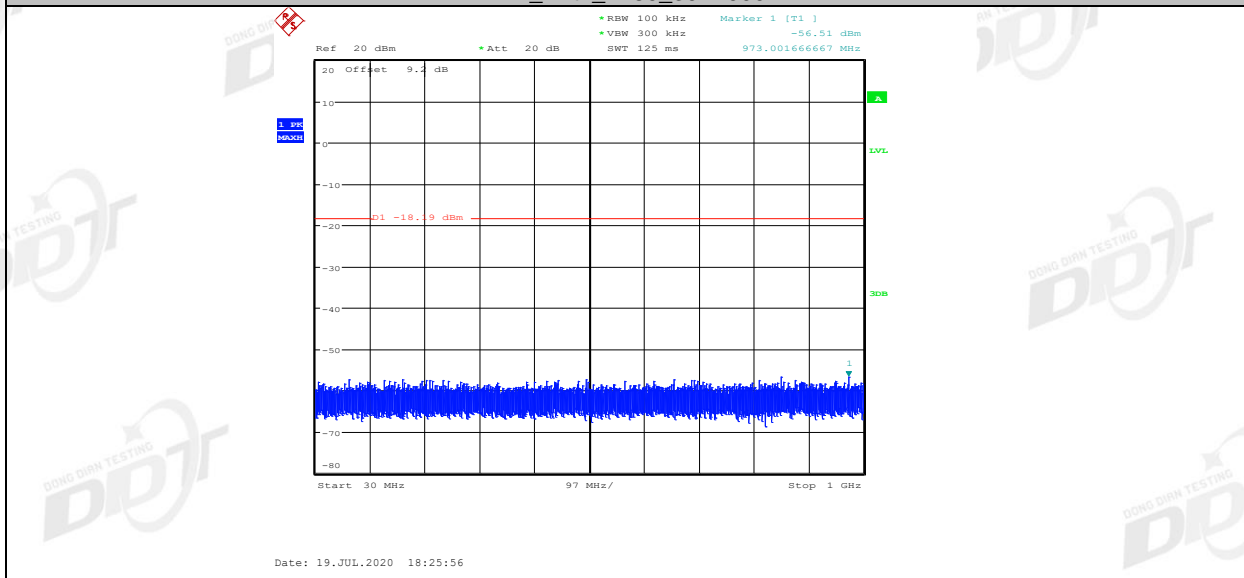

BLE\_Ant1\_2480\_1000~26500

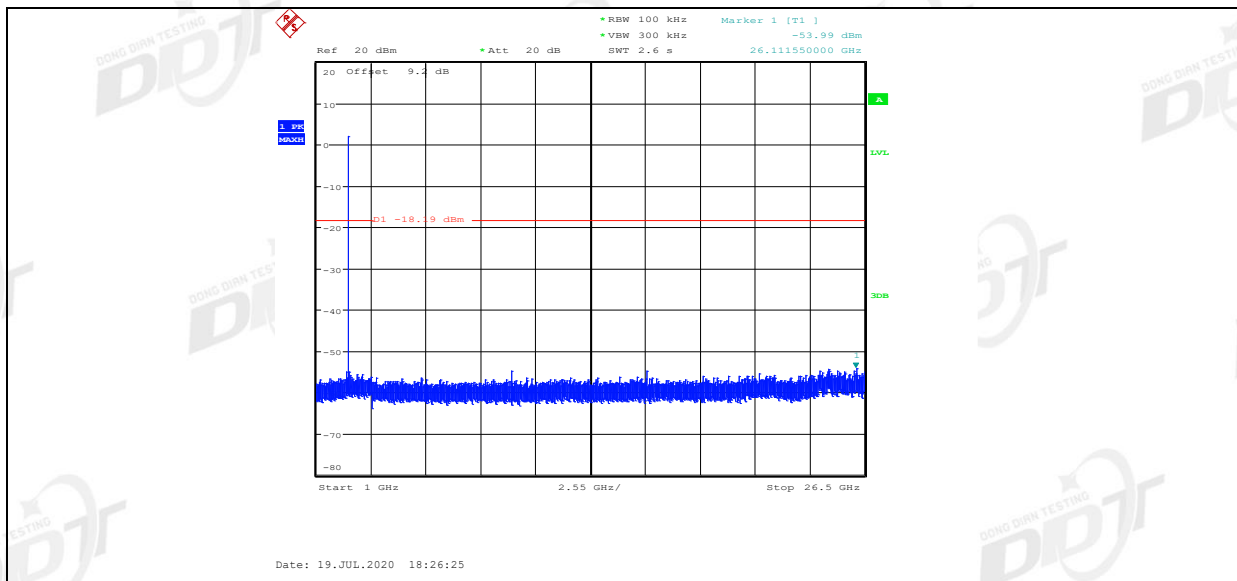

Right side:

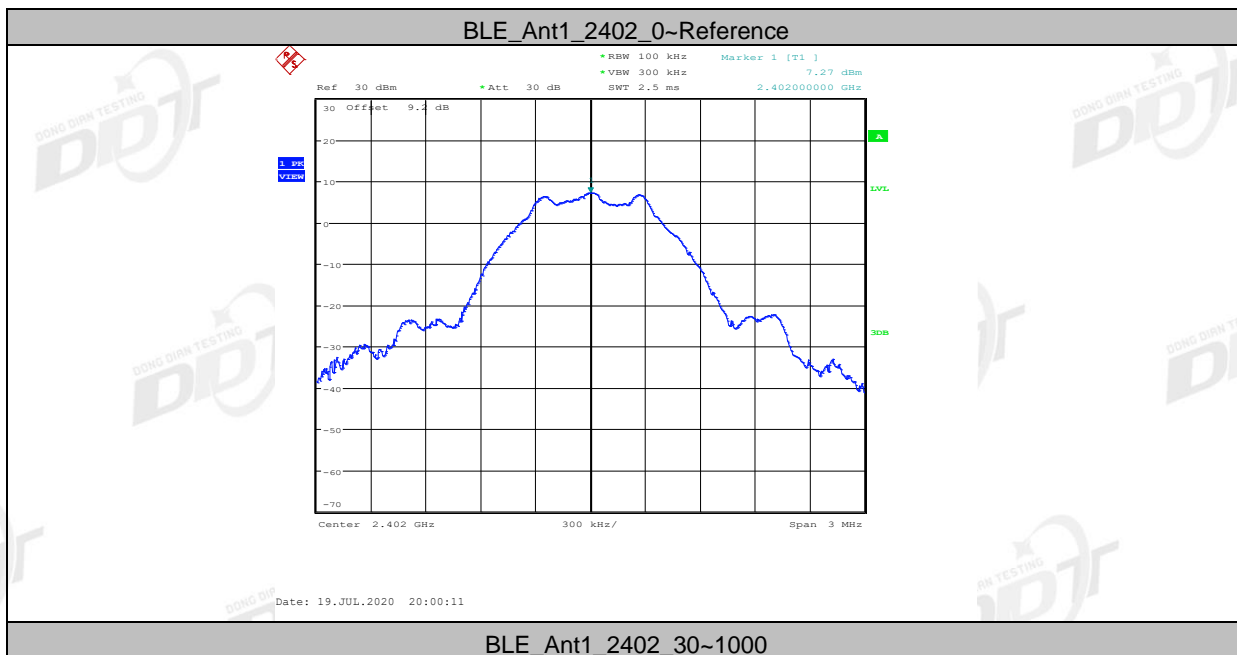

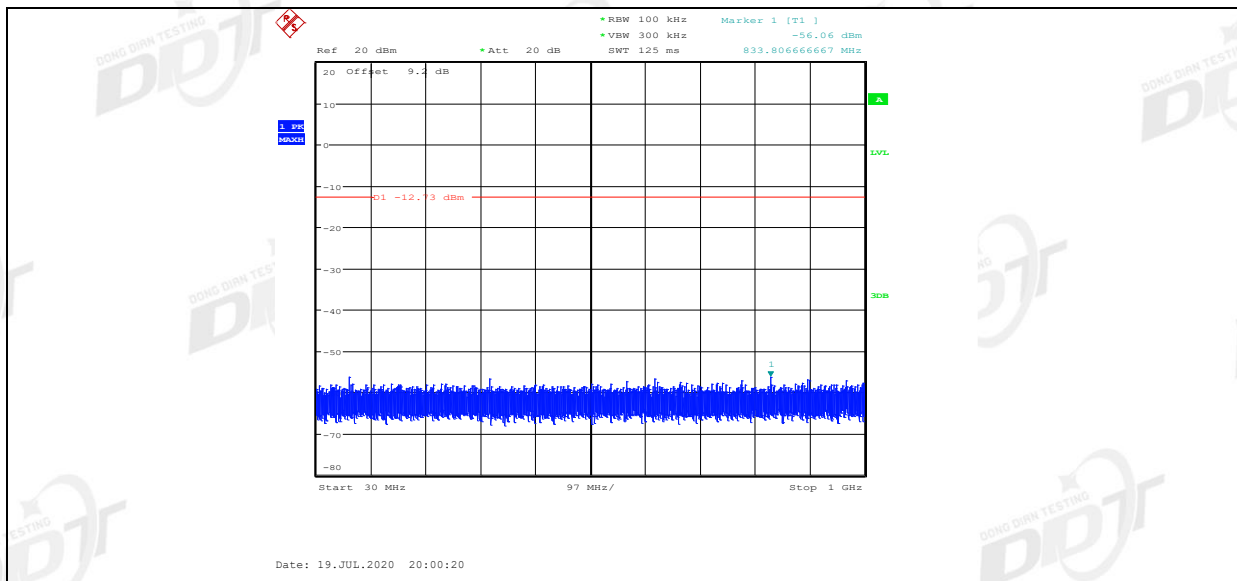

BLE\_Ant1\_2402\_1000~26500

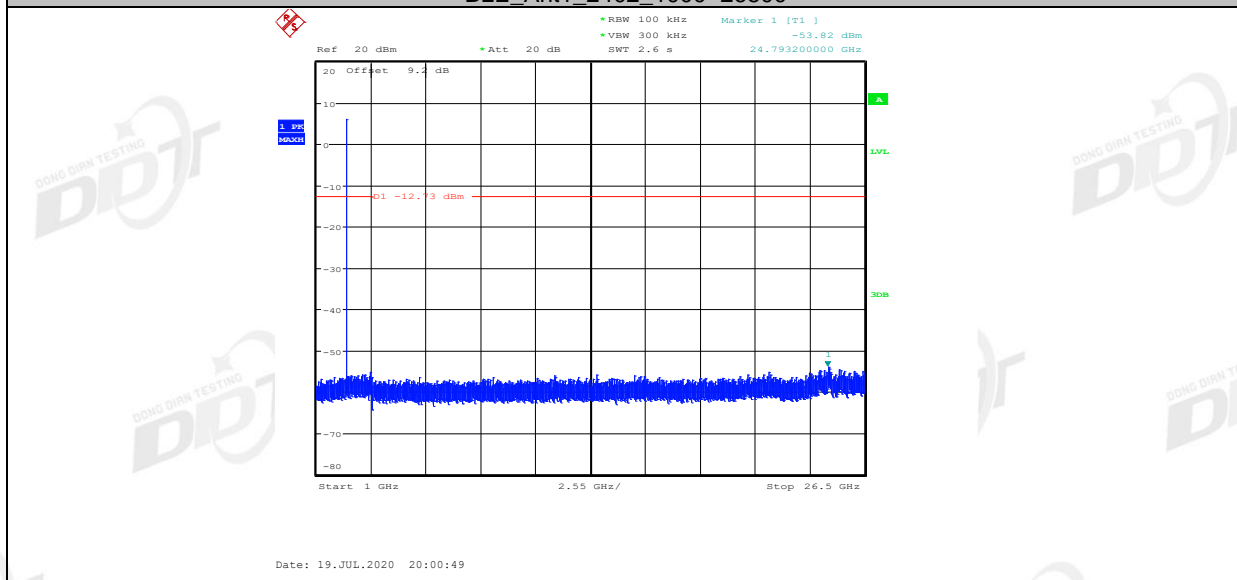

BLE\_Ant1\_2440\_0-Reference

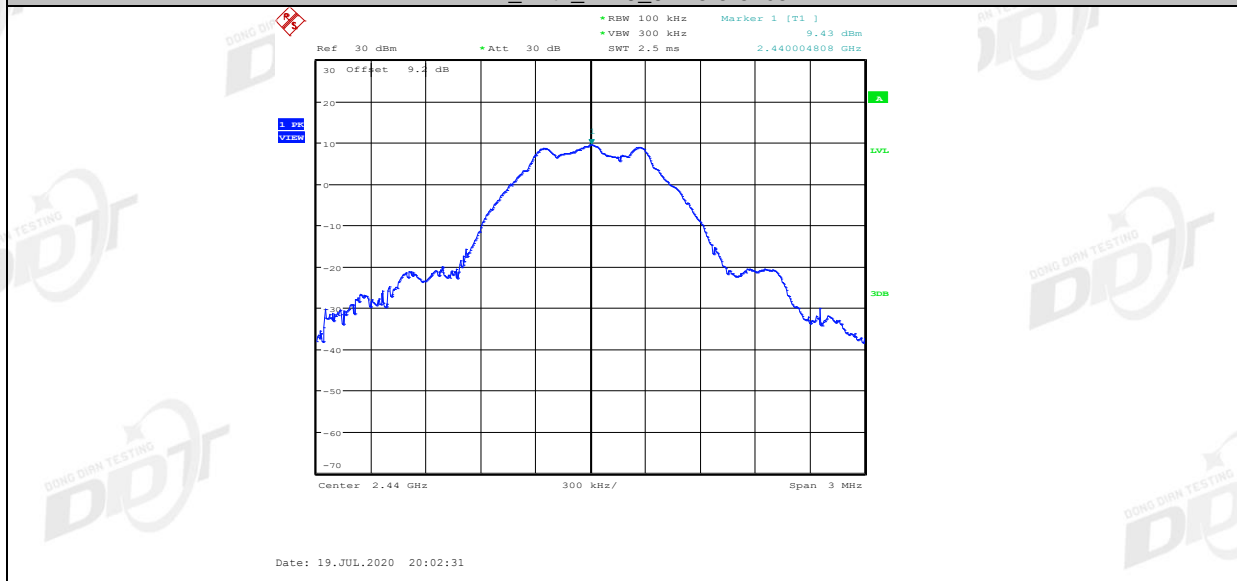

BLE\_Ant1\_2440\_30~1000

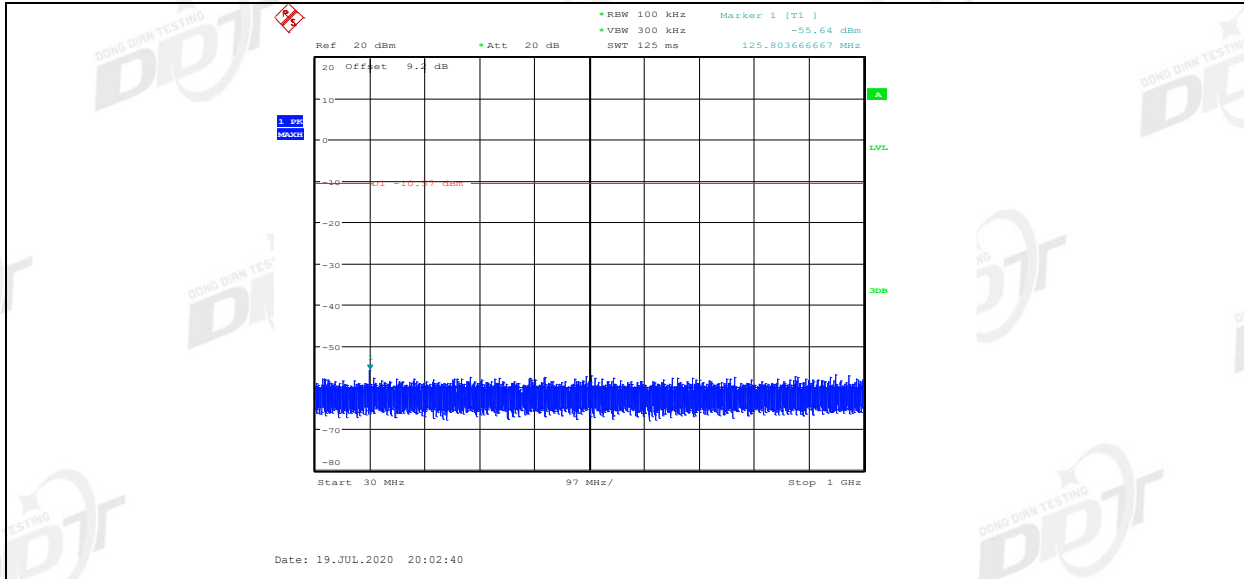

BLE\_Ant1\_2440\_1000~26500

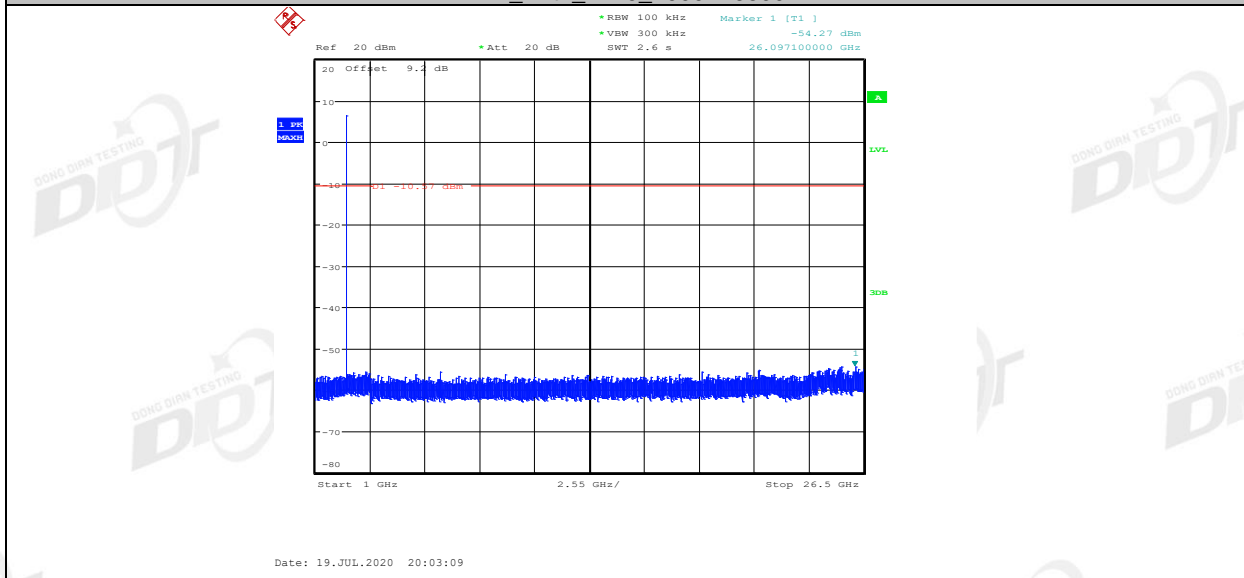

BLE\_Ant1\_2480\_0-Reference

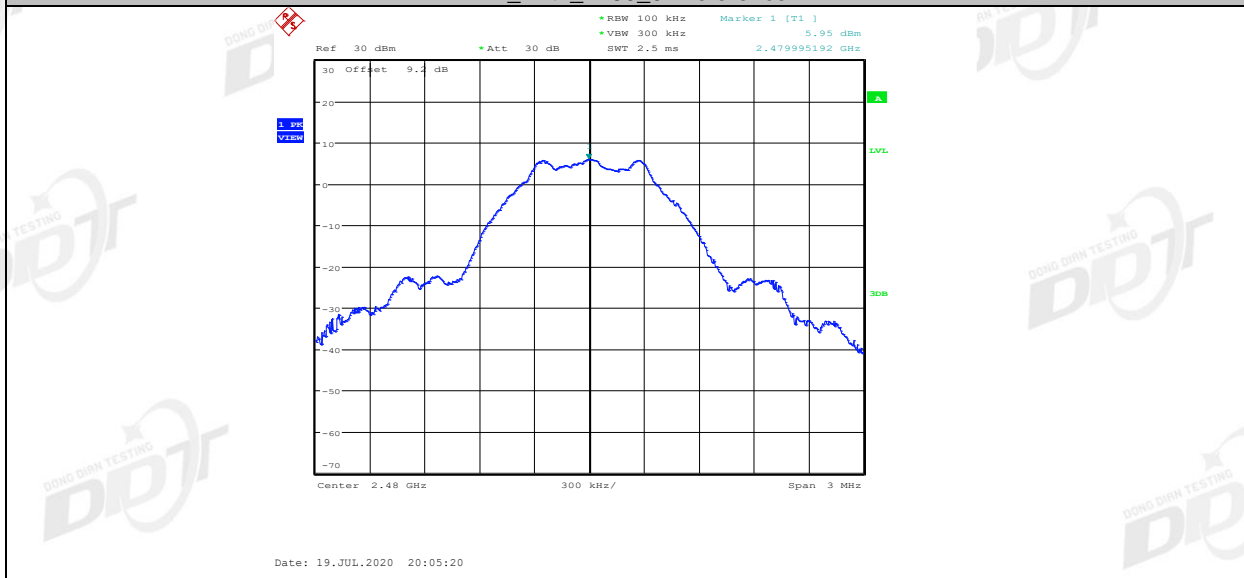

BLE\_Ant1\_2480\_30~1000



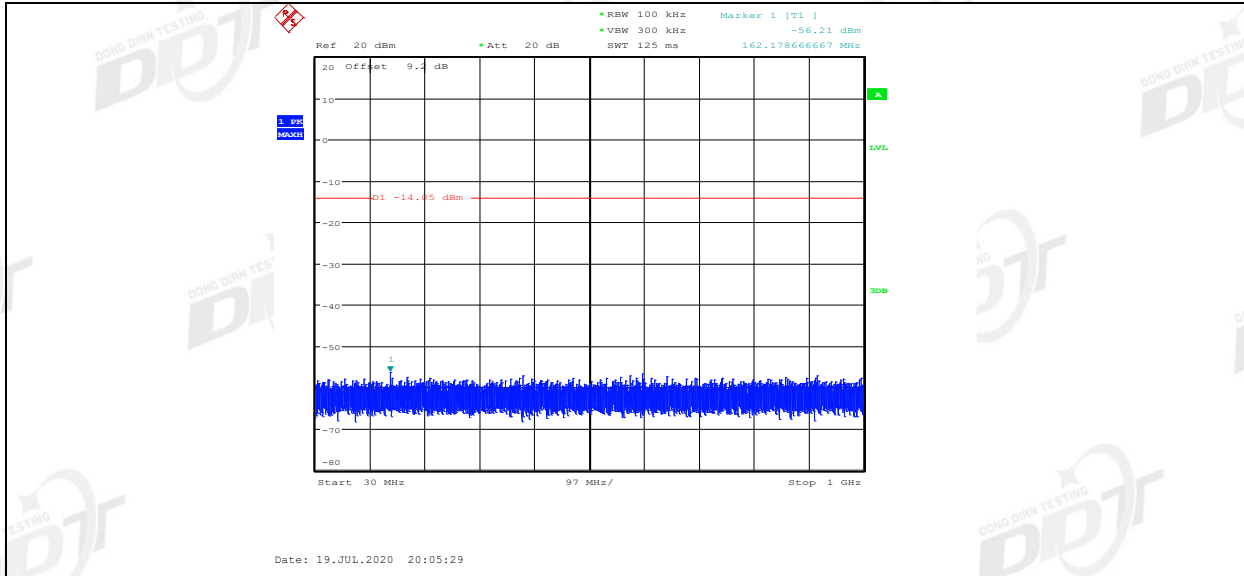

BLE\_Ant1\_2480\_1000~26500

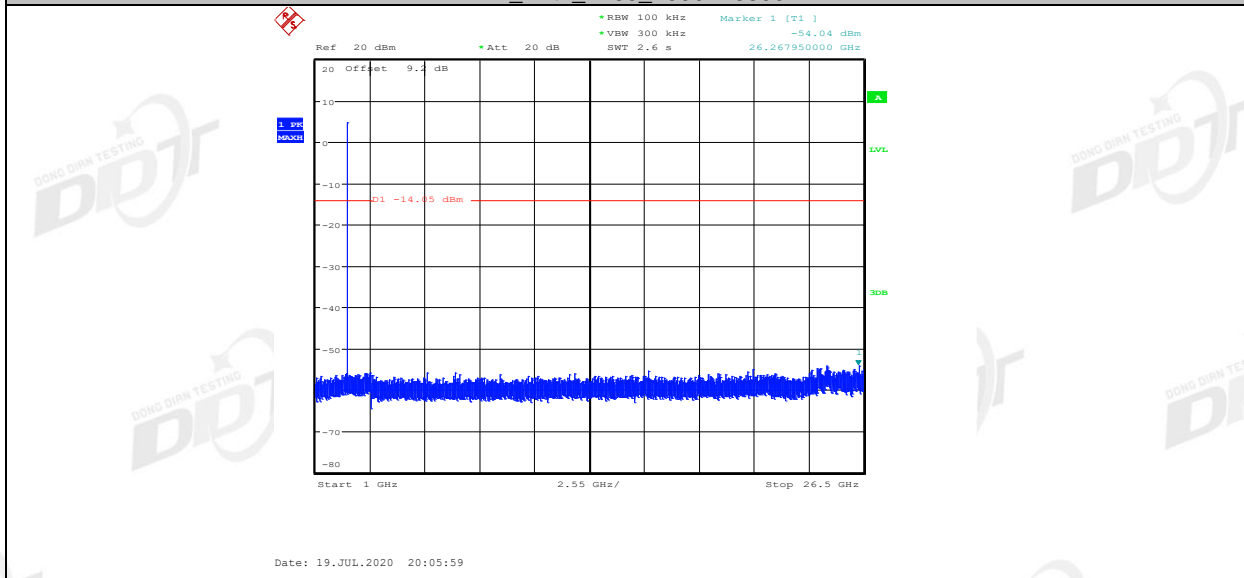

## 10. Emissions in Restricted Frequency Bands

### 10.1. Block diagram of test setup

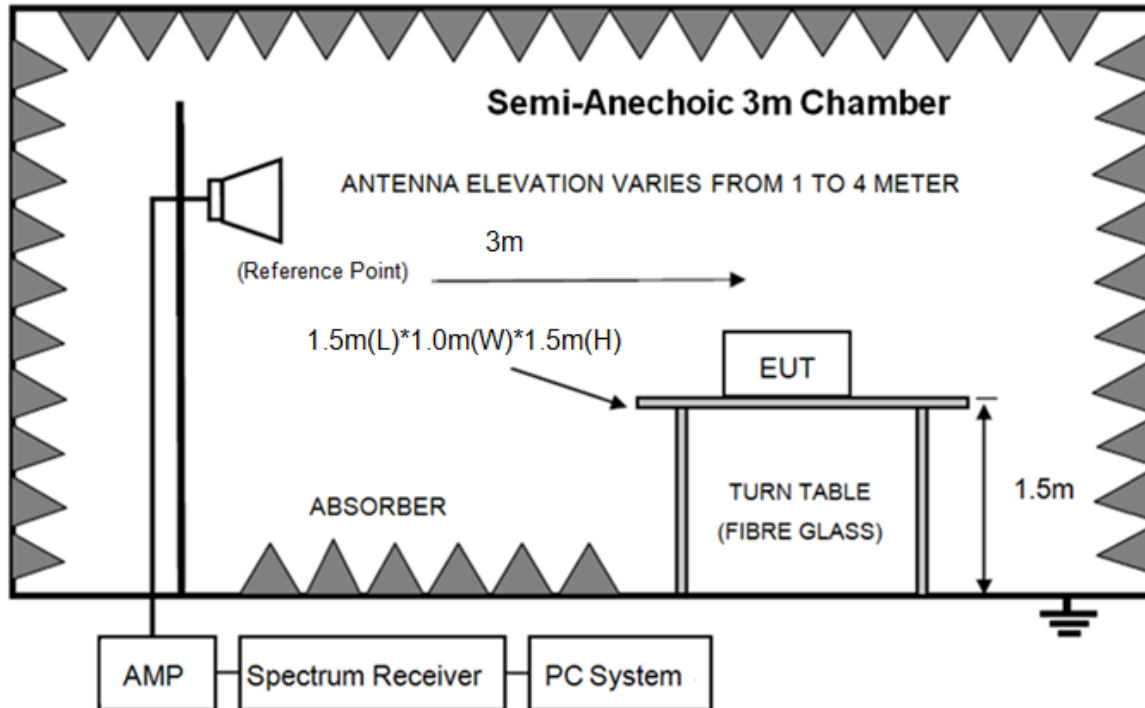

### 10.2. Limit

All restriction band should comply with 15.209, other emission should be at least 20 dB below the fundamental.

### 10.3. Test procedure

Same with clause 8.3 except change investigated frequency range from 2310 MHz to 2410 MHz and 2470 MHz to 2500 MHz.

Remark: All restriction band have been tested, and only the worst case is shown in report.

### 10.4. Test result

Pass. (See below detailed test result)

Note: Scan with all side, the worst case is left side recorded in this report.

# TR-4-E-009 Radiated Emission Test Result

**Test Site** : DDT 3m Chamber 2#

E:\2020 RE2# Report Data\Y20200507-1 FREE I\FCC ABOVE1G.EM6

**Test Date** : 2020-07-16

**Tested By** : Ella

**EUT** : BLUETOOTH HEADSET

**Model Number** : FREEII

**Power Supply** : Battery

**Test Mode** : Tx mode

**Condition** : Temp:24.5°C,Humi:55%,Press:100.1kPa

**Antenna/Distance** : 2019 BBHA9120D/3m/VERTICAL

**Memo** :

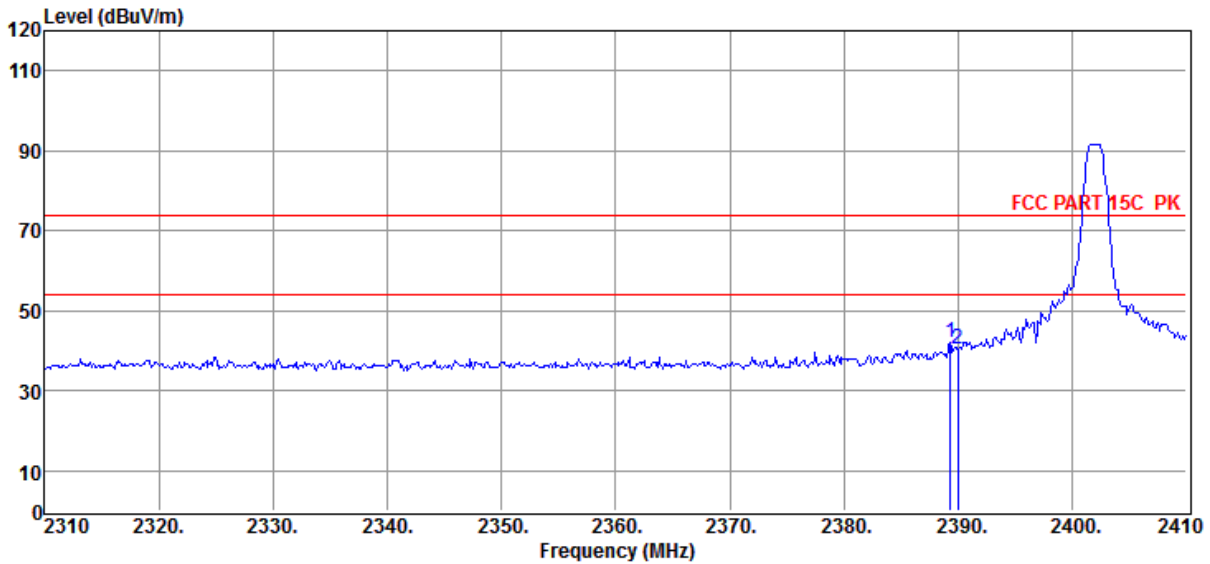

Item (Mark)	Freq. (MHz)	Read Level (dBμV)	Antenna Factor (dB/m)	PRM Factor (dB)	Cable Loss (dB)	Result Level (dBμV/m)	Limit Line (dBμV/m)	Over Limit (dB)	Detector	Polarization
1	2389.30	53.89	27.48	43.21	4.03	42.19	74.00	-31.81	Peak	VERTICAL
2	2390.00	52.11	27.48	43.21	4.03	40.41	74.00	-33.59	Peak	VERTICAL

Note: 1. Result Level = Read Level + Antenna Factor + Cable loss - PRM Factor.

2. If Peak Result complies with AV limit, AV Result is deemed to comply with AV limit.

3. Test setup: RBW: 1 MHz, VBW: 3 MHz, Sweep time: auto.

# TR-4-E-009 Radiated Emission Test Result

**Test Site** : DDT 3m Chamber 2# E:\2020 RE2# Report Data\Y20200507-1 FREE I\FCC ABOVE1G.EM6  
**Test Date** : 2020-07-16 **Tested By** : Ella  
**EUT** : BLUETOOTH HEADSET **Model Number** : FREEII  
**Power Supply** : Battery **Test Mode** : Tx mode  
**Condition** : Temp:24.5°C,Humi:55%,Press:100.1kPa **Antenna/Distance** : 2019 BBHA9120D/3m/HORIZONTAL  
**Memo** :

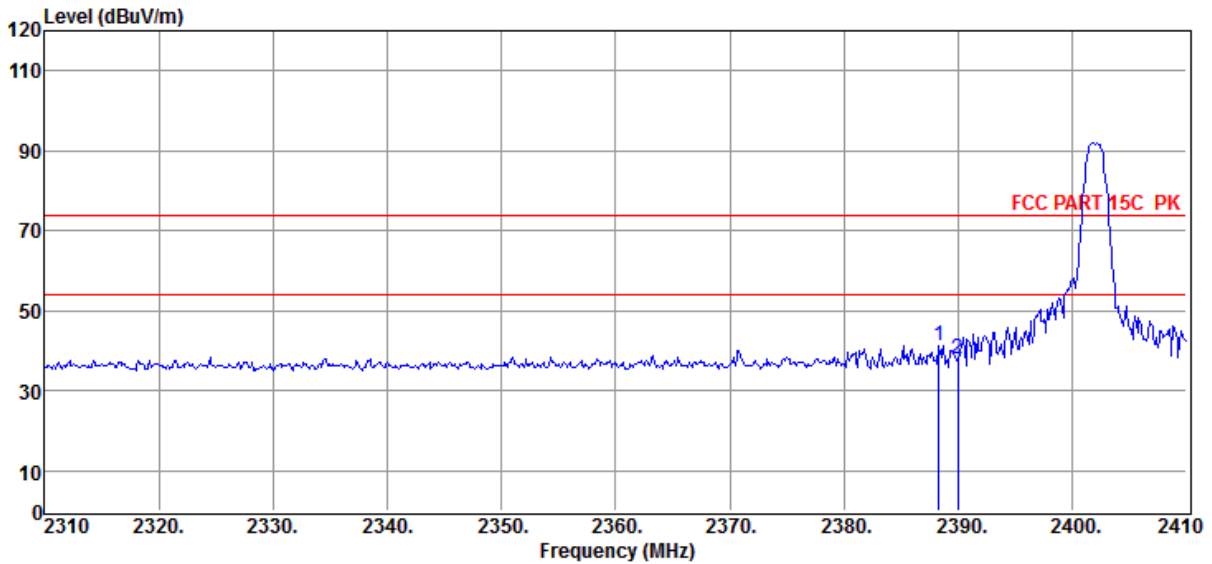

Item (Mark)	Freq. (MHz)	Read Level (dBμV)	Antenna Factor (dB/m)	PRM Factor (dB)	Cable Loss (dB)	Result Level (dBμV/m)	Limit Line (dBμV/m)	Over Limit (dB)	Detector	Polarization
1	2388.30	52.97	27.48	43.20	4.03	41.28	74.00	-32.72	Peak	HORIZONTAL
2	2390.00	49.67	27.48	43.21	4.03	37.97	74.00	-36.03	Peak	HORIZONTAL

- Note: 1. Result Level = Read Level + Antenna Factor + Cable loss - PRM Factor.  
 2. If Peak Result complies with AV limit, AV Result is deemed to comply with AV limit.  
 3. Test setup: RBW: 1 MHz, VBW: 3 MHz, Sweep time: auto.

## TR-4-E-009 Radiated Emission Test Result

**Test Site** : DDT 3m Chamber 2#

E:\2020 RE2# Report Data\Y20200507-1 FREE I\FCC ABOVE1G.EM6

**Test Date** : 2020-07-16

**Tested By** : Ella

**EUT** : BLUETOOTH HEADSET

**Model Number** : FREEII

**Power Supply** : Battery

**Test Mode** : Tx mode

**Condition** : Temp:24.5°C,Humi:55%,Press:100.1kPa

**Antenna/Distance** : 2019 BBHA9120D/3m/HORIZONTAL

**Memo** :

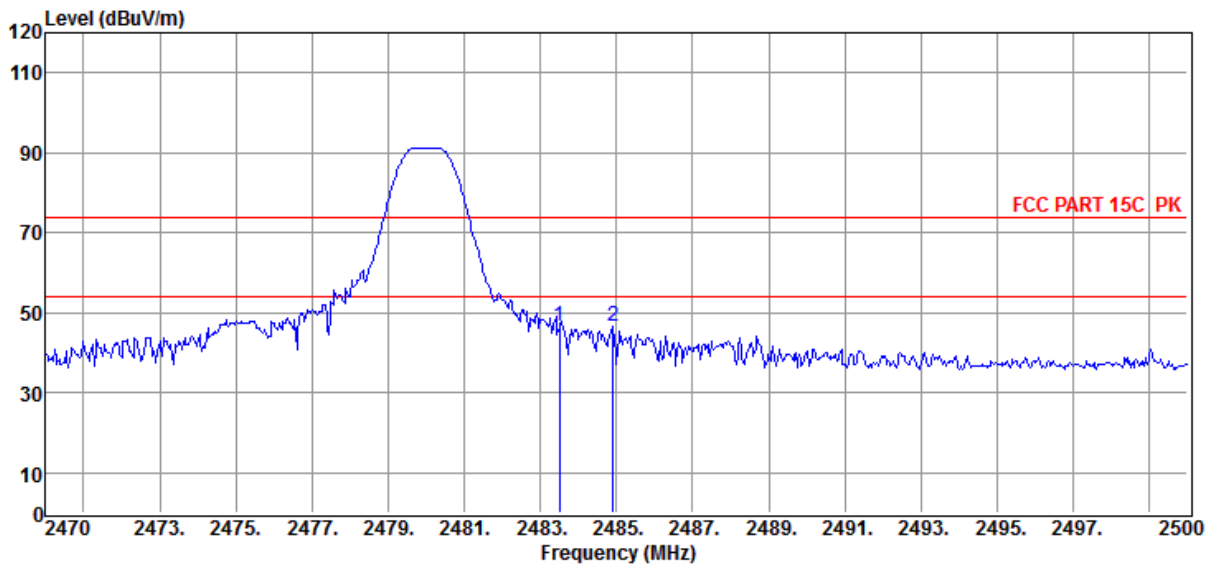

Item (Mark)	Freq. (MHz)	Read Level (dB $\mu$ V)	Antenna Factor (dB/m)	PRM Factor dB	Cable Loss dB	Result Level (dB $\mu$ V/m)	Limit Line (dB $\mu$ V/m)	Over Limit (dB)	Detector	Polarization
1	2483.50	58.09	27.67	43.25	4.12	46.63	74.00	-27.37	Peak	HORIZONTAL
2	2484.91	58.16	27.67	43.25	4.13	46.71	74.00	-27.29	Peak	HORIZONTAL

Note: 1. Result Level = Read Level + Antenna Factor + Cable loss - PRM Factor.

2. If Peak Result complies with AV limit, AV Result is deemed to comply with AV limit.

3. Test setup: RBW: 1 MHz, VBW: 3 MHz, Sweep time: auto.

## TR-4-E-009 Radiated Emission Test Result

**Test Site** : DDT 3m Chamber 2#

E:\2020 RE2# Report Data\Y20200507-1 FREE I\FCC ABOVE1G.EM6

**Test Date** : 2020-07-16

**Tested By** : Ella

**EUT** : BLUETOOTH HEADSET

**Model Number** : FREEII

**Power Supply** : Battery

**Test Mode** : Tx mode

**Condition** : Temp:24.5°C,Humi:55%,Press:100.1kPa

**Antenna/Distance** : 2019 BBHA9120D/3m/VERTICAL

**Memo** :

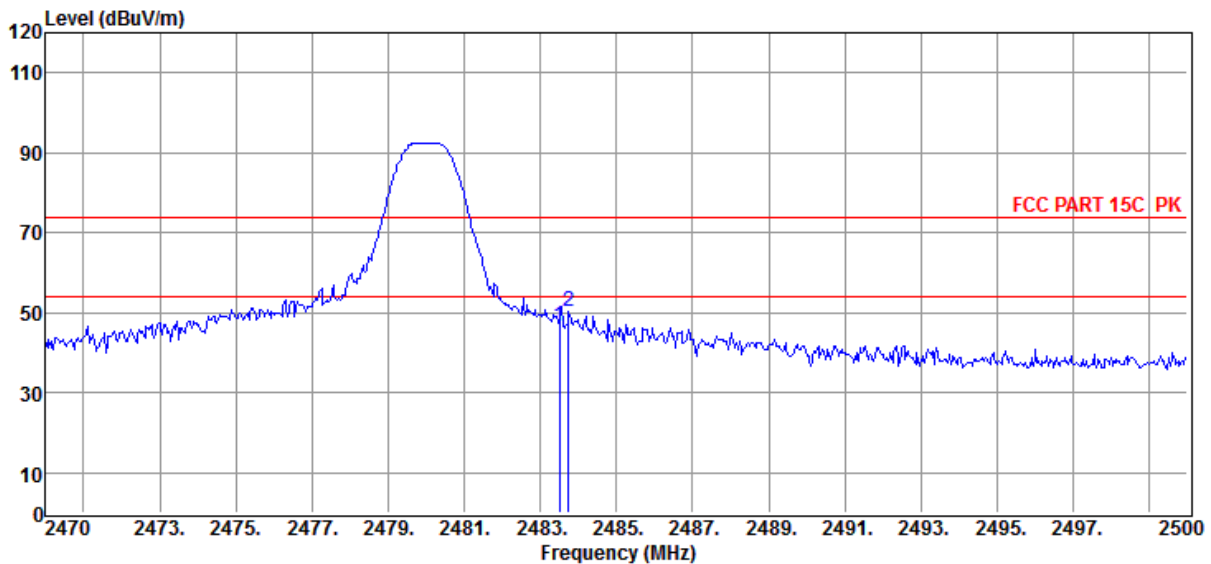

Item (Mark)	Freq. (MHz)	Read Level (dB $\mu$ V)	Antenna Factor (dB/m)	PRM Factor dB	Cable Loss dB	Result Level (dB $\mu$ V/m)	Limit Line (dB $\mu$ V/m)	Over Limit (dB)	Detector	Polarization
1	2483.50	57.88	27.67	43.25	4.12	46.42	74.00	-27.58	Peak	VERTICAL
2	2483.74	61.93	27.67	43.25	4.12	50.47	74.00	-23.53	Peak	VERTICAL

Note: 1. Result Level = Read Level + Antenna Factor + Cable loss - PRM Factor.

2. If Peak Result complies with AV limit, AV Result is deemed to comply with AV limit.

3. Test setup: RBW: 1 MHz, VBW: 3 MHz, Sweep time: auto

## 11. Power Line Conducted Emission

### 11.1. Block diagram of test setup

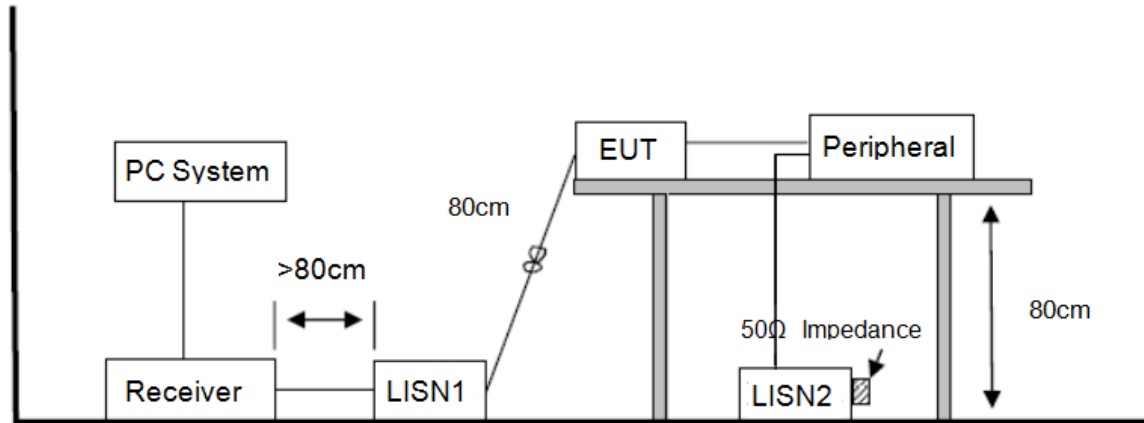

### 11.2. Power line conducted emission limits

Frequency	Quasi-Peak Level dB( $\mu$ V)	Average Level dB( $\mu$ V)
150 kHz ~ 500 kHz	66 ~ 56*	56 ~ 46*
500 kHz ~ 5 MHz	56	46
5 MHz ~ 30 MHz	60	50

Note 1: \* Decreasing linearly with logarithm of frequency.

Note 2: The lower limit shall apply at the transition frequencies.

### 11.3. Test procedure

The EUT and Support equipment, if needed, were put placed on a non-metallic table, 80 cm above the ground plane.

Configuration EUT to simulate typical usage as described in clause 2.4 and test equipment as described in clause 10.2 of this report.

All I/O cables were positioned to simulate typical actual usage as per ANSI C63.10.

All support equipment power received from a second LISN.

Emissions were measured on each current carrying line of the EUT using an EMI Test Receiver connected to the LISN powering the EUT.

The Receiver scanned from 150 kHz to 30 MHz for emissions in each of the test modes.

During the above scans, the emissions were maximized by cable manipulation.

The test mode(s) described in clause 2.4 were scanned during the preliminary test.

After the preliminary scan, we found the test mode producing the highest emission level.

The EUT configuration and worse cable configuration of the above highest emission levels were recorded for reference of the final test.

EUT and support equipment were set up on the test bench as per the configuration with highest emission level in the preliminary test.

A scan was taken on both power lines, Neutral and Line, recording at least the six highest emissions.

Emission frequency and amplitude were recorded into a computer in which correction factors were used to calculate the emission level and compare reading to the applicable limit.

The test data of the worst-case condition(s) was recorded.

The bandwidth of test receiver is set at 9 kHz.

#### 11.4. Test result

##### Pass. (See below detailed test result)

Note1: All emissions not reported below are too low against the prescribed limits.

Note2: "----" means Peak detection; "----" means Average detection.

Note3: Pre-test AC conducted emission at both voltage AC 120V/60Hz and AC 240V/50Hz, recorded worse case.



# TR-4-E-010 Conducted Emission Test Result

**Test Site** : DDT 1# Shield Room D:\2020 CE report data\Y20200529-1\CE.EM6  
**Test Date** : 2020-06-01 **Tested By** : Bote Huang  
**EUT** : BLUETOOTH HEADSET **Model Number** : FREEII  
**Power Supply** : AC 240V/50Hz **Test Mode** : Tx mode  
**Condition** : TEMP:24.5℃, RH:55%,  
**LISN** : 2019 ENV216 1#/NEUTRAL  
 BP:101.4kPa  
**Memo** :

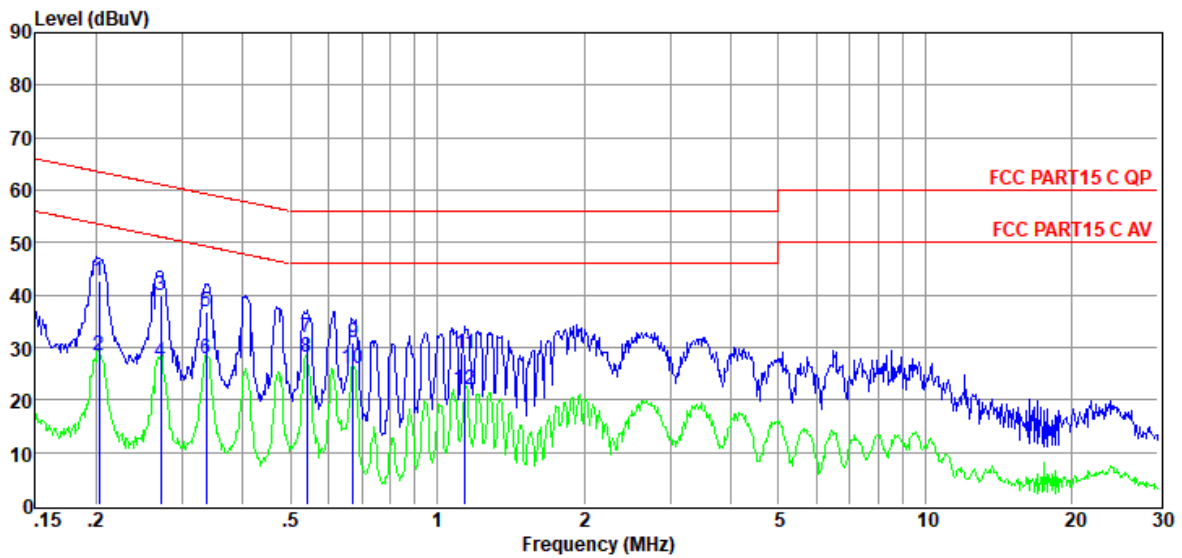

Item	Freq.	Read Level	LISN Factor	Cable Loss	Pulse Limiter Factor	Result Level	Limit Line	Over Limit	Detector	Phase
(Mark)	(MHz)	(dBμV)	(dB)	(dB)	(dB)	(dBμV)	(dBμV)	(dB)		
1	0.20	23.19	9.60	0.02	9.86	42.67	63.49	-20.82	QP	NEUTRAL
2	0.20	8.92	9.60	0.02	9.86	28.40	53.49	-25.09	Average	NEUTRAL
3	0.27	20.31	9.60	0.02	9.86	39.79	61.07	-21.28	QP	NEUTRAL
4	0.27	7.81	9.60	0.02	9.86	27.29	51.07	-23.78	Average	NEUTRAL
5	0.34	17.22	9.60	0.02	9.86	36.70	59.31	-22.61	QP	NEUTRAL
6	0.34	8.33	9.60	0.02	9.86	27.81	49.31	-21.50	Average	NEUTRAL
7	0.54	12.52	9.60	0.02	9.86	32.00	56.00	-24.00	QP	NEUTRAL
8	0.54	8.68	9.60	0.02	9.86	28.16	46.00	-17.84	Average	NEUTRAL
9	0.67	11.51	9.60	0.03	9.86	31.00	56.00	-25.00	QP	NEUTRAL
10	0.67	6.60	9.60	0.03	9.86	26.09	46.00	-19.91	Average	NEUTRAL
11	1.14	9.23	9.60	0.03	9.86	28.72	56.00	-27.28	QP	NEUTRAL
12	1.14	2.35	9.60	0.03	9.86	21.84	46.00	-24.16	Average	NEUTRAL

- Note: 1. Result Level = Read Level + LISN Factor + Pulse Limiter Factor + Cable loss.  
 2. If QP Result complies with AV limit, AV Result is deemed to comply with AV limit.  
 3. Test setup: RBW: 200 Hz (9 kHz—150 kHz), 9 kHz (150 kHz—30 MHz).  
 4. Step size: 80Hz (0.009MHz-0.15MHz), 4 kHz (0.15MHz-30MHz), Scan time: auto.

# TR-4-E-010 Conducted Emission Test Result

**Test Site** : DDT 1# Shield Room D:\2020 CE report data\Y20200529-1\CE.EM6  
**Test Date** : 2020-06-01 **Tested By** : Bote Huang  
**EUT** : BLUETOOTH HEADSET **Model Number** : FREEII  
**Power Supply** : AC 240V/50Hz **Test Mode** : Tx mode  
**Condition** : TEMP:24.5°C, RH:55%,  
**LISN** : 2019 ENV216 1#/LINE  
 BP:101.4kPa  
**Memo** :

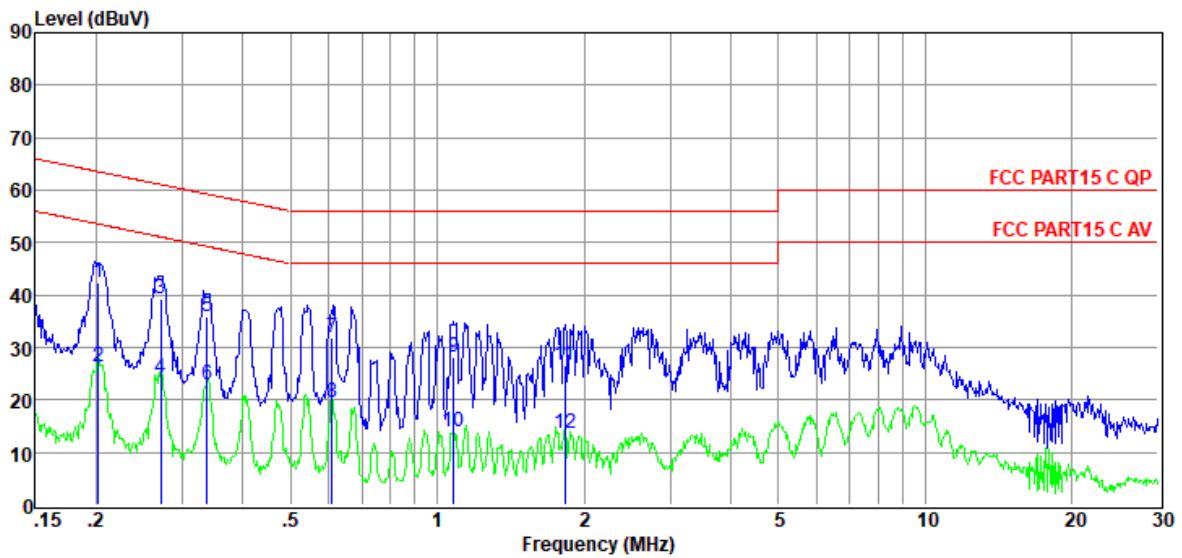

Item	Freq.	Read Level	LISN Factor	Cable Loss	Pulse Limiter Factor	Result Level	Limit Line	Over Limit	Detector	Phase
(Mark)	(MHz)	(dBμV)	(dB)	(dB)	(dB)	(dBμV)	(dBμV)	(dB)		
1	0.20	22.88	9.60	0.02	9.86	42.36	63.54	-21.18	QP	LINE
2	0.20	6.81	9.60	0.02	9.86	26.29	53.54	-27.25	Average	LINE
3	0.27	19.87	9.60	0.02	9.86	39.35	61.07	-21.72	QP	LINE
4	0.27	4.71	9.60	0.02	9.86	24.19	51.07	-26.88	Average	LINE
5	0.34	16.44	9.60	0.02	9.86	35.92	59.27	-23.35	QP	LINE
6	0.34	3.49	9.60	0.02	9.86	22.97	49.27	-26.30	Average	LINE
7	0.61	12.27	9.60	0.03	9.86	31.76	56.00	-24.24	QP	LINE
8	0.61	-0.15	9.60	0.03	9.86	19.34	46.00	-26.66	Average	LINE
9	1.08	8.80	9.60	0.03	9.86	28.29	56.00	-27.71	QP	LINE
10	1.08	-5.46	9.60	0.03	9.86	14.03	46.00	-31.97	Average	LINE
11	1.83	7.24	9.60	0.05	9.86	26.75	56.00	-29.25	QP	LINE
12	1.83	-5.88	9.60	0.05	9.86	13.63	46.00	-32.37	Average	LINE

- Note: 1. Result Level = Read Level + LISN Factor + Pulse Limiter Factor + Cable loss.  
 2. If QP Result complies with AV limit, AV Result is deemed to comply with AV limit.  
 3. Test setup: RBW: 200 Hz (9 kHz—150 kHz), 9 kHz (150 kHz—30 MHz).  
 4. Step size: 80Hz (0.009MHz-0.15MHz), 4 kHz (0.15MHz-30MHz), Scan time: auto.

## 12. Antenna Requirements

### 12.1. Limit

For intentional device, according to FCC 47 CFR Section 15.203, an intentional radiator shall be designed to ensure that no antenna other than that furnished by the responsible party shall be used with the device. And according to FCC 47 CFR Section 15.247 (b), if transmitting antennas of directional gain greater than 6 dBi are used, the power shall be reduced by the amount in dB that the directional gain of the antenna exceeds 6 dBi.

### 12.2. Result

The left side antenna used for this product is LDS antenna and right side is LDS antenna and that no antenna other than that furnished by the responsible party shall be used with the device, the maximum peak gain of the left side transmit antenna is -2.29 dBi and right side is -2.62 dBi.

**END OF REPORT**