

SAR TEST REPORT

Report No.: DDT-B22040806-1E01

Applicant	:	Harman International Industries, Inc.
Applicant Address	:	8500 Balboa Boulevard, Northridge, CA 91329, UNITED STATES
Equipment Under Test	:	Portable Bluetooth Speaker
Model No.	:	FLIP ESSENTIAL 2
Trade Mark	:	JBL
FCC ID	:	APIJBLFLIPETL2
IC ID	:	6132A-JBLFLIPETL2
Manufacturer	:	Harman International Industries, Inc.
Manufacturer Address	:	8500 Balboa Boulevard, Northridge, CA 91329, UNITED STATES

Issued By: Tianjin Dongdian Testing Service Co., Ltd.

Address: Building D-1, No. 19, Weisi Road, Microelectronics Industrial Park,
Development Area, Tianjin, China

Tel: +86-22-58038033, **E-mail:** ddt@ddt.com, <http://www.ddttest.com>

REPORT

Table of Contents

1.	Summary of Test Results.....	6
1.1.	Max SAR results.....	6
1.2.	RF exposure limits	6
2.	General Test Information	7
2.1.	Description of EUT	7
2.2.	RF Channel Information.....	7
2.3.	Accessories of EUT.....	8
2.4.	Assistant equipment used for test.....	8
2.5.	Block diagram of EUT configuration for test.....	8
2.6.	Test environment conditions	8
2.7.	Test laboratory	9
3.	SAR Measurements System Configuration	10
3.1.	The SAR Measurement System	10
3.2.	Isotropic E-field Probe EX3DV4.....	11
3.3.	SAM Twin Phantom	12
3.4.	ELI Phantom.....	12
3.5.	Data Acquisition Electronics (DAE).....	13
3.6.	Device Holder for Transmitters	13
4.	Measurement procedure	14
4.1.	Scanning procedure	14
5.	RF Exposure Conditions	16
5.1.	test sides	16
5.2.	Standalone SAR Test Exclusion Considerations.....	16
6.	SAR System Verification Procedure	18
6.1.	Tissue Simulate Liquid	18
6.1.1.	Recipes for Tissue Simulate Liquid.....	18
6.1.2.	Measurement for Tissue Simulate Liquid	18
6.2.	SAR System Validation	19
6.2.1.	Justification for Extended SAR Dipole Calibrations.....	20
6.2.2.	Validation Test Setup Photograph	21
6.2.3.	Summary System Validation Result(s)	21
6.2.4.	Detailed System Validation Results	21
7.	Equipment list.....	22
8.	Measurement Uncertainty.....	23
9.	Test results and Measurement Data.....	24
9.1.	RF conducted Power.....	24

9.2.	Measurement of SAR Data	24
9.2.1.	SAR Result of Bluetooth BDR+EDR	24
10.	Appendix	25

Test Report Declare

Applicant	:	Harman International Industries, Inc.
Address	:	8500 Balboa Boulevard, Northridge, CA 91329, UNITED STATES
Equipment under Test	:	Portable Bluetooth Speaker
Model No.	:	FLIP ESSENTIAL 2
Trade Mark	:	JBL
Manufacturer	:	Harman International Industries, Inc.
Address	:	8500 Balboa Boulevard, Northridge, CA 91329, UNITED STATES

Test Standard Used:

IEEE Std. 1528-2013; IEC/IEEE 62209-1528:2020

FCC Rules and Regulations: 47 CFR § 2.1093; § 1.1310

ISED Rules and Regulations: RSS-102 Issue5, Mar. 2015

Test Procedure Used:

KDB447498 D01 v06, KDB 865664 D01 v01r04, KDB 865664 D02 v01r02,

We Declare:

The equipment described above is tested by Tianjin Dongdian Testing Service Co., Ltd and in the configuration tested the equipment complied with the standards specified above. The test results are contained in this test report and Tianjin Dongdian Testing Service Co., Ltd is assumed of full responsibility for the accuracy and completeness of these tests.

After test and evaluation, our opinion is that the equipment provided for test compliance with the requirement of the above FCC and ISED standards.

Report No:	DDT-B22040806-1E01		
Date of Receipt:	Apr. 11, 2022	Date of Test:	Apr. 21, 2022 ~ Apr. 21, 2022

Prepared By:

Sunny Zhang

Sunny Zhang / Engineer

Approved By:

Leon Li

Leon Li / RF Manager



Note: This report applies to above tested sample only. This report shall not be reproduced in parts without written approval of Tianjin Dongdian Testing Service Co., Ltd.

The report must not be used by the client to claim product certification, approval, or endorsement by NVLAP, NIST, or any agency of the U.S. Government.

Revision History

Rev.	Revisions	Issue Date	Revised By
---	Initial issue	Apr. 22, 2022	

1. Summary of Test Results

1.1. Max SAR results

Band	Test Position	Test mode	Max SAR1g (W/kg)	SAR1g limit (W/kg)	Verdict
Bluetooth	Body	BDR+EDR	0.0223	1.6	Pass

1.2. RF exposure limits

Human Exposure	Uncontrolled Environment General Population	Controlled Environment Occupational
Spatial Average SAR** (Whole Body)	0.08 W/kg	0.40 W/kg
Spatial Peak SAR* (Brain*Trunk)	1.60 W/kg	8.00 W/kg
Spatial Peak SAR*** (Hands/Feet/Ankle/Wrist)	4.00 W/kg	20.00 W/kg

Notes:

- 1) The Spatial Peak value of the SAR averaged over any 1 gram of tissue (defined as a tissue volume in the shape of a cube) and over the appropriate averaging time
- 2) The Spatial Average value of the SAR averaged over the whole body.
- 3) The Spatial Peak value of the SAR averaged over any 10 grams of tissue (defined as a tissue volume in the shape of a cube) and over the appropriate averaging time.
- 4) Uncontrolled Environments are defined as locations where there is the exposure of individuals who have no knowledge or control of their exposure.
- 5) Controlled Environments are defined as locations where there is exposure that may be incurred by persons who are aware of the potential for exposure, (i.e. as a result of employment or occupation.)

2. General Test Information

2.1. Description of EUT

EUT Description	: Portable Bluetooth Speaker
Model Number	: FLIP ESSENTIAL 2
Trade Mark	: JBL
Serial Number	: N/A
Hardware Version	: DV2
Software Version	: BT 1.1 MCU 1.4
Sample Type	: Portable Device
Radio Specification	: Bluetooth V5.1
Frequency Range	: 2402-2480MHz
Modulation	: GFSK, $\pi/4$ -DQPSK, 8DPSK
Data Rate	: 1Mbps, 2Mbps, 3Mbps
Antenna Type	: Fixed Internal Antenna
Antenna Gain	: 2.29dBi
Power Supply	: DC 5V from extranal AC Adapter DC 3.6V built-in battery

Note: EUT is the abbreviation of equipment under test.

2.2. RF Channel Information

Channel Information					
Channel	Frequency (MHz)	Channel	Frequency (MHz)	Channel	Frequency (MHz)
0	2402	27	2429	54	2456
1	2403	28	2430	55	2457
2	2404	29	2431	56	2458
3	2405	30	2432	57	2459
4	2406	31	2433	58	2460
5	2407	32	2434	59	2461
6	2408	33	2435	60	2462
7	2409	34	2436	61	2463
8	2410	35	2437	62	2464
9	2411	36	2438	63	2465
10	2412	37	2439	64	2466
11	2413	38	2440	65	2467
12	2414	39	2441	66	2468
13	2415	40	2442	67	2469
14	2416	41	2443	68	2470
15	2417	42	2444	69	2471
16	2418	43	2445	70	2472
17	2419	44	2446	71	2473
18	2420	45	2447	72	2474
19	2421	46	2448	73	2475
20	2422	47	2449	74	2476
21	2423	48	2450	75	2477
22	2424	49	2451	76	2478
23	2425	50	2452	77	2479

24	2426	51	2453	78	2480
25	2427	52	2454		
26	2428	53	2455		

2.3. Accessories of EUT

Description of Accessories	Manufacturer	Model number	Description	Remark
USB cable	Harman International Industries, Inc.	N/A	Length: 120mm	N/A

2.4. Assistant equipment used for test

Assistant equipment	Manufacturer	Model number	EMC Compliance	SN
Notebook	Lenovo Beijing Co. Ltd.	ThinkPad T450	FCC/CE	SL10H72009

2.5. Block diagram of EUT configuration for test



Test software: FCCTestTool.exe

2.6. Test environment conditions

During the measurement the environmental conditions were within the listed ranges:

Condition	Normal Condition	Extreme Condition
Pressure range	86-106KPa	N/A
Relative Humidity	30-75%	N/A
Temperature(°C)	22°C-25°C	N/A
Voltage(V)	3.6V	N/A

2.7. Test laboratory

Tianjin Dongdian Testing Service Co., Ltd.

Address: Building D-1, No. 19, Weisi Road, Microelectronics Industrial Park Development Area, Tianjin, China., 300385

Tel: +86-22-58038033, <http://www.ddttest.com>, Email: ddt@dgddt.com

NVLAP (National Voluntary Laboratory Accreditation Program) CODE: 500036-0

CNAS (China National Accreditation Service for Conformity Assessment) CODE: L13402

FCC Designation Number: CN5004; FCC Test Firm Registration Number: 368676

ISED (Innovation, Science and Economic Development Canada) Company Number: 27768

Conformity Assessment Body Identifier: CN0125

VCCI Facility Registration Number: C-20089, T-20093, R-20125, G-20122

3. SAR Measurements System Configuration

3.1. The SAR Measurement System

This SAR Measurement System uses a Computer-controlled 3-D stepper motor system (SPEAG DASY5 professional system). A E-field probe is used to determine the internal electric fields. The SAR can be obtained from the equation $SAR = \sigma (|E|^2) / \rho$ where σ and ρ are the conductivity and mass density of the tissue-Simulate.

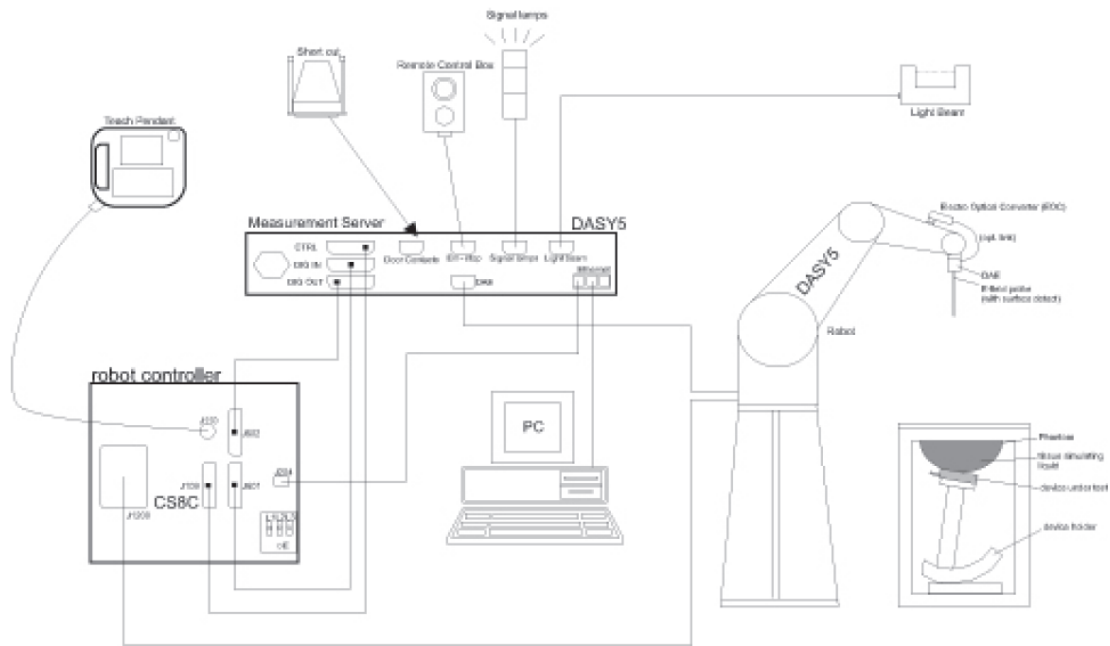

The DASY5 system for performing compliance tests consists of the following items: [®]

- A standard high precision 6-axis robot (Stabile RX family) with controller, teach pendant and software. An arm extension for accommodation the data acquisition electronics (DAE).
- An isotropic E-field probe optimized and calibrated for usage in tissue simulating liquid. The probe is equipped with an optical surface detector system.
- A data acquisition electronics (DAE) which performs the signal amplification, signal multiplexing, AD-conversion, offset measurements, mechanical surface detection, collision detection, etc. The unit is battery powered with standard or rechargeable batteries. The signal is optically transmitted to the EOC.
- The Electro-optical converter (EOC) performs the conversion between optical and electrical of the signals for the digital communication to DAE and for the analog signal from the optical surface detection. The EOC is connected to the measurement server.

- The function of the measurement server is to perform the time critical tasks such as signal filtering, control of the robot operation and fast movement interrupts.
- A probe alignment unit which improves the (absolute) accuracy of the probe positioning.
- A computer operating Windows 7.
- DASY52 software.
- Remote control with teach pendant and additional circuitry for robot safety such as warning lamps, etc.
- The SAM twin phantom enabling testing left-hand, right-hand and Body Worn usage.
- The device holder for handheld mobile phones.
- Tissue simulating liquid mixed according to the given recipes.
- Validation dipole kits allowing to validating the proper functioning of the system.

3.2. Isotropic E-field Probe EX3DV4

	<p>• Symmetrical design with triangular core Built-in shielding against static charges PEEK enclosure material (resistant to organic solvents, e.g., DGBE)</p>
Calibration	ISO/IEC 17025 calibration service available.
Frequency	10 MHz to > 6 GHz Linearity: ± 0.2 dB (30 MHz to 6 GHz)
Directivity	± 0.3 dB in TSL (rotation around probe axis) ± 0.5 dB in TSL (rotation normal to probe axis)
Dynamic Range	10 μ W/g to > 100 mW/g Linearity: ± 0.2 dB (noise: typically < 1 μ W/g)
Dimensions	Overall length: 337 mm (Tip: 20 mm) Tip diameter: 2.5 mm (Body: 12 mm) Typical distance from probe tip to dipole centers: 1 mm
Application	High precision dosimetric measurements in any exposure scenario (e.g., very strong gradient fields); the only probe that enables compliance testing for frequencies up to 6 GHz with precision of better 30%.
Compatibility	DASY3, DASY4, DASY52 SAR and higher, EASY4/MRI

3.3. SAM Twin Phantom

Material	Vinylester, glass fiber reinforced (VE-GF)	
Liquid Compatibility	Compatible with all SPEAG tissue simulating liquids (incl. DGBE type)	
Shell Thickness	2 ± 0.2 mm (6 ± 0.2 mm at ear point)	
Dimensions (incl. Wooden Support)	Length: 1000 mm Width: 500 mm Height: adjustable feet	
Filling Volume	approx. 25 liters	
Wooden Support	SPEAG standard phantom table	
<p>The shell corresponds to the specifications of the Specific Anthropomorphic Mannequin (SAM) phantom defined in IEEE 1528 and IEC 62209-1. It enables the dosimetric evaluation of left and right hand phone usage as well as body mounted usage at the flat phantom region. A cover prevents evaporation of the liquid.</p> <p>Reference markings on the phantom allow the complete setup of all predefined phantom positions and measurement grids by teaching three points with the robot.</p> <p>Twin SAM V5.0 has the same shell geometry and is manufactured from the same material as Twin SAM V4.0, but has reinforced top structure.</p>		

3.4. ELI Phantom

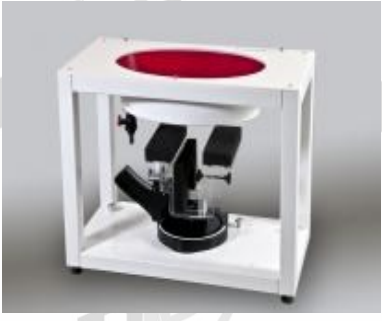
Material	Vinylester, glass fiber reinforced (VE-GF)	
Liquid Compatibility	Compatible with all SPEAG tissue simulating liquids (incl. DGBE type)	
Shell Thickness	2 ± 0.2 mm (bottom plate)	
Dimensions	Major axis: 600 mm Minor axis: 400 mm	
Filling Volume	approx. 30 liters	
Wooden Support	SPEAG standard phantom table	
<p>Phantom for compliance testing of handheld and body-mounted wireless devices in the frequency range of 30 MHz to 6 GHz. ELI is fully compatible with the IEC 62209-2 standard and all known tissue simulating liquids.</p> <p>ELI has been optimized regarding its performance and can be integrated into our standard phantom tables. A cover prevents evaporation of the liquid. Reference markings on the phantom allow installation of the complete setup, including all predefined phantom positions and measurement grids, by teaching three points. The phantom is compatible with all SPEAG dosimetric probes and dipoles.</p> <p>ELI V5.0 has the same shell geometry and is manufactured from the same material as ELI4, but has reinforced top structure.</p>		

3.5. Data Acquisition Electronics (DAE)

Model	DAE4	
Construction	Signal amplifier, multiplexer, A/D converter and control logic. Serial optical link for communication with DASY4/5 embedded system (fully remote controlled). Two step probe touch detector for mechanical surface detection and emergency robot stop.	
Measurement Range	-100 to +300 mV (16 bit resolution and two range settings: 4mV, 400mV)	
Input Offset Voltage	< 5 μ V (with auto zero)	
Input Bias Current	< 50 f A	
Dimensions	60 x 60 x 68 mm	



3.6. Device Holder for Transmitters



The DASY device holder is designed to cope with different positions given in the standard. It has two scales for the device rotation (with respect to the body axis) and the device inclination (with respect to the line between the ear reference points). The rotation centres for both scales are the ear reference point (ERP). Thus the device needs no repositioning when changing the angles.

The DASY device holder has been made out of low-loss POM material having the following dielectric parameters: relative permittivity $\epsilon=3$ and loss tangent $\delta=0.02$. The amount of dielectric material has been reduced in the closest vicinity of the device, since measurements have suggested that the influence of the clamp on the test results could thus be lowered.

4. MEASUREMENT PROCEDURE

4.1. Scanning procedure

Step 1: Power reference measurement

The “reference” and “drift” measurements are located at the beginning and end of the batch process. They measure the field drift at one single point in the liquid over the complete procedure.

Step 2: Area scan

The SAR distribution at the exposed side of the head was measured at a distance of 4mm from the inner surface of the shell. The area covered the entire dimension of the head and the horizontal grid spacing was 15mm*15mm or 12mm*12mm or 10mm*10mm. Based on the area scan data, the area of the maximum absorption was determined by spline interpolation.

Step 3: Zoom scan

Around this point, a volume of 30mm*30mm*30mm (fine resolution volume scan, zoom scan) was assessed by measuring 5x5x7 points ($\leq 2\text{GHz}$) and 7x7x7 points ($\geq 2\text{GHz}$). On this basis of this data set, the spatial peak SAR value was evaluated with the following procedure:

The data at the surface was extrapolated, since the centre of the dipoles is 2.0mm away from the tip of the probe and the distance between the surface and the lowest measuring point is 1.2mm.

(This can be variable. Refer to the probe specification). The extrapolation was based on a least square algorithm. A polynomial of the fourth order was calculated through the points in z-axis.

This polynomial was then used to evaluate the points between the surface and the probe tip. The maximum interpolated value was searched with a straight-forward algorithm. Around this

maximum the SAR values averaged over the spatial volumes (1g or 10g) were computed using the 3D-Spline interpolation algorithm. The volume was integrated with the trapezoidal algorithm.

One thousand points were interpolated to calculate the average. All neighbouring volumes were evaluated until no neighboring volume with a higher average value was found.

The area and zoom scan resolutions specified in the table below must be applied to the SAR measurements. Probe boundary effect error compensation is required for measurements with the probe tip closer than half a probe tip diameter to the phantom surface. Both the probe tip diameter and sensor offset distance must satisfy measurement protocols; to ensure probe boundary effect errors are minimized and the higher fields closest to the phantom surface can be correctly measured and extrapolated to the phantom surface for computing 1-g SAR. Tolerances of the post-processing algorithms must be verified by the test laboratory for the scan resolutions used in the SAR measurements, according to the reference distribution functions specified in IEEE 1528-2013.

		≤ 3 GHz	> 3 GHz
Maximum distance from closest measurement point (geometric center of probe sensors) to phantom surface		5 mm \pm 1 mm	$\frac{1}{2} \cdot \delta \cdot \ln(2)$ mm \pm 0.5 mm
Maximum probe angle from probe axis to phantom surface normal at the measurement location		$30^\circ \pm 1^\circ$	$20^\circ \pm 1^\circ$
Maximum area scan spatial resolution: Δx_{Area} , Δy_{Area}		≤ 2 GHz: ≤ 15 mm 2 – 3 GHz: ≤ 12 mm	3 – 4 GHz: ≤ 12 mm 4 – 6 GHz: ≤ 10 mm
		When the x or y dimension of the test device, in the measurement plane orientation, is smaller than the above, the measurement resolution must be \leq the corresponding x or y dimension of the test device with at least one measurement point on the test device.	
Maximum zoom scan spatial resolution: Δx_{Zoom} , Δy_{Zoom}		≤ 2 GHz: ≤ 8 mm 2 – 3 GHz: ≤ 5 mm*	3 – 4 GHz: ≤ 5 mm* 4 – 6 GHz: ≤ 4 mm*
Maximum zoom scan spatial resolution, normal to phantom surface	uniform grid: $\Delta z_{Zoom}(n)$	≤ 5 mm	3 – 4 GHz: ≤ 4 mm 4 – 5 GHz: ≤ 3 mm 5 – 6 GHz: ≤ 2 mm
	graded grid $\Delta z_{Zoom}(1)$: between 1 st two points closest to phantom surface	≤ 4 mm	3 – 4 GHz: ≤ 3 mm 4 – 5 GHz: ≤ 2.5 mm 5 – 6 GHz: ≤ 2 mm
	$\Delta z_{Zoom}(n>1)$: between subsequent points	$\leq 1.5 \cdot \Delta z_{Zoom}(n-1)$ mm	
Minimum zoom scan volume	x, y, z	≥ 30 mm	3 – 4 GHz: ≥ 28 mm 4 – 5 GHz: ≥ 25 mm 5 – 6 GHz: ≥ 22 mm
Note: δ is the penetration depth of a plane-wave at normal incidence to the tissue medium; see IEEE Std 1528-2013 for details.			
* When zoom scan is required and the <i>reported</i> SAR from the <i>area scan based 1-g SAR estimation</i> procedures of KDB Publication 447498 is ≤ 1.4 W/kg, ≤ 8 mm, ≤ 7 mm and ≤ 5 mm zoom scan resolution may be applied, respectively, for 2 GHz to 3 GHz, 3 GHz to 4 GHz and 4 GHz to 6 GHz.			

Step 4: Power reference measurement (drift)

The Power Drift Measurement job measures the field at the same location as the most recent power reference measurement job within the same procedure, and with the same settings. The indicated drift is mainly the variation of the DUT's output power and should vary max. $\pm 5\%$

Step 5: Z-Scan (FCC only)

The Z scan measures points along a vertical straight line. The line runs along the Z-axis of a one-dimensional grid. In order to get a reasonable extrapolation the extrapolated distance should not be greater than the step size in Z-direction.

5. RF EXPOSURE CONDITIONS

5.1. test sides

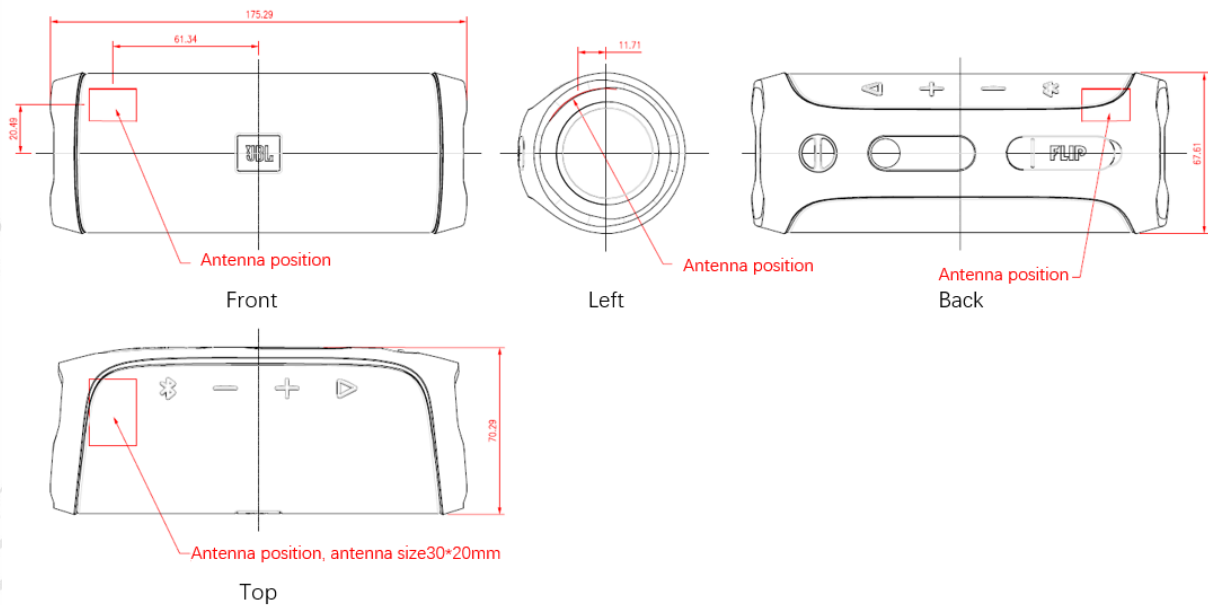

SAR test sides						
Body						
Band	Back	Front	Top	Bottom	Left	Right
BDR+EDR	√	×	√	×	×	×

Note: The SAR test distance is 0mm(body)

5.2. Standalone SAR Test Exclusion Considerations

According to RSS-102, the SAR test exclusion threshold for 2450MHz at 5mm test separation distances is 4mW.

Frequency (MHz)	Exemption Limits (mW)				
	At separation distance of ≤5 mm	At separation distance of 10 mm	At separation distance of 15 mm	At separation distance of 20 mm	At separation distance of 25 mm
≤300	71 mW	101 mW	132 mW	162 mW	193 mW
450	52 mW	70 mW	88 mW	106 mW	123 mW
835	17 mW	30 mW	42 mW	55 mW	67 mW
1900	7 mW	10 mW	18 mW	34 mW	60 mW
2450	4 mW	7 mW	15 mW	30 mW	52 mW
3500	2 mW	6 mW	16 mW	32 mW	55 mW
5800	1 mW	6 mW	15 mW	27 mW	41 mW

Frequency (MHz)	Exemption Limits (mW)				
	At separation distance of 30 mm	At separation distance of 35 mm	At separation distance of 40 mm	At separation distance of 45 mm	At separation distance of ≥50 mm
≤300	223 mW	254 mW	284 mW	315 mW	345 mW
450	141 mW	159 mW	177 mW	195 mW	213 mW
835	80 mW	92 mW	105 mW	117 mW	130 mW
1900	99 mW	153 mW	225 mW	316 mW	431 mW
2450	83 mW	123 mW	173 mW	235 mW	309 mW
3500	86 mW	124 mW	170 mW	225 mW	290 mW
5800	56 mW	71 mW	85 mW	97 mW	106 mW

Standalone 1-g head or body SAR evaluation by measurement or numerical simulation is not required when the corresponding SAR Exclusion Threshold condition, listed below, is satisfied.

The 1-g SAR test exclusion threshold for 100 MHz to 6 GHz at test separation distances ≤ 50 mm are determined by:

$[(\text{max. power of channel, including tune-up tolerance, mW}) / (\text{min. test separation distance, mm})] \cdot [\sqrt{f(\text{GHz})}] \leq 3.0$ for 1-g SAR, where

f(GHz) is the RF channel transmit frequency in GHz

Power and distance are rounded to the nearest mW and mm before calculation

The result is rounded to one decimal place for comparison

According to the KDB447498, the SAR test exclusion threshold for 2450MHz at 5mm test separation distances is 3mW.

Frequency (MHz)	Distance (mm)									
	5	10	15	20	25	30	35	40	45	50
300	39	65	88	110	129	148	166	184	201	217
450	22	44	67	89	112	135	158	180	203	226
835	9	25	44	66	90	116	145	175	207	240
1900	3	12	26	44	66	92	122	157	195	236
2450	3	10	22	38	59	83	111	143	179	219
3600	2	8	18	32	49	71	96	125	158	195
5800	1	6	14	25	40	58	80	106	136	169

6. SAR SYSTEM VERIFICATION PROCEDURE

6.1. Tissue Simulate Liquid

6.1.1. Recipes for Tissue Simulate Liquid

The following tables give the recipes for tissue simulating liquids to be used in different frequency bands :

Ingredients (% by weight)	Frequency (MHz)							
	450		835		1800-2000		2300-2700	
Tissue Type	Head	Body	Head	Body	Head	Body	Head	Body
Water	38.56	51.16	40.30	50.75	55.24	70.17	55.00	68.53
Salt (NaCl)	3.95	1.49	1.38	0.94	0.31	0.39	0.2	0.1
Sucrose	56.32	46.78	57.90	48.21	0	0	0	0
HEC	0.98	0.52	0.24	0	0	0	0	0
Bactericide	0.19	0.05	0.18	0.10	0	0	0	0
Tween	0	0	0	0	44.45	29.44	44.80	31.37

Salt: 99% Pure Sodium Chloride
 Water: De-ionized, 16 MΩ⁺ resistivity
 Tween: Polyoxyethylene (20) sorbitan monolaurate

Sucrose: 98% Pure Sucrose
 HEC: Hydroxyethyl Cellulose

6.1.2. Measurement for Tissue Simulate Liquid

The dielectric properties for this Tissue Simulate Liquids were measured by using the Agilent Model 85070E Dielectric Probe in conjunction with Agilent E5071C Network Analyzer (300 KHz-8500 MHz). The Conductivity (σ) and Permittivity (ρ) are listed in Table 1. For the SAR measurement given in this report. The temperature variation of the Tissue Simulate Liquids was 22±2°C.

Tissue Type	Measured Frequency (MHz)	Target Tissue (±5%)		Measured Tissue		Liquid Temp. (°C)	Measured Date
		ϵ_r	σ (S/m)	ϵ_r	σ (S/m)		
2450 head	2402MHz	39.29 (37.33~41.25)	1.76 (1.67~1.85)	38.20	1.82	21.0	2022/4/21
	2441MHz	39.22 (37.26~41.18)	1.79 (1.70~1.88)	38.00	1.86	21.0	2022/4/21
	2450MHz	39.20 (37.24~41.16)	1.80 (1.71~1.89)	37.97	1.88	21.0	2022/4/21
	2480MHz	39.16 (37.20~41.12)	1.83 (1.74~1.92)	37.70	1.90	21.0	2022/4/21

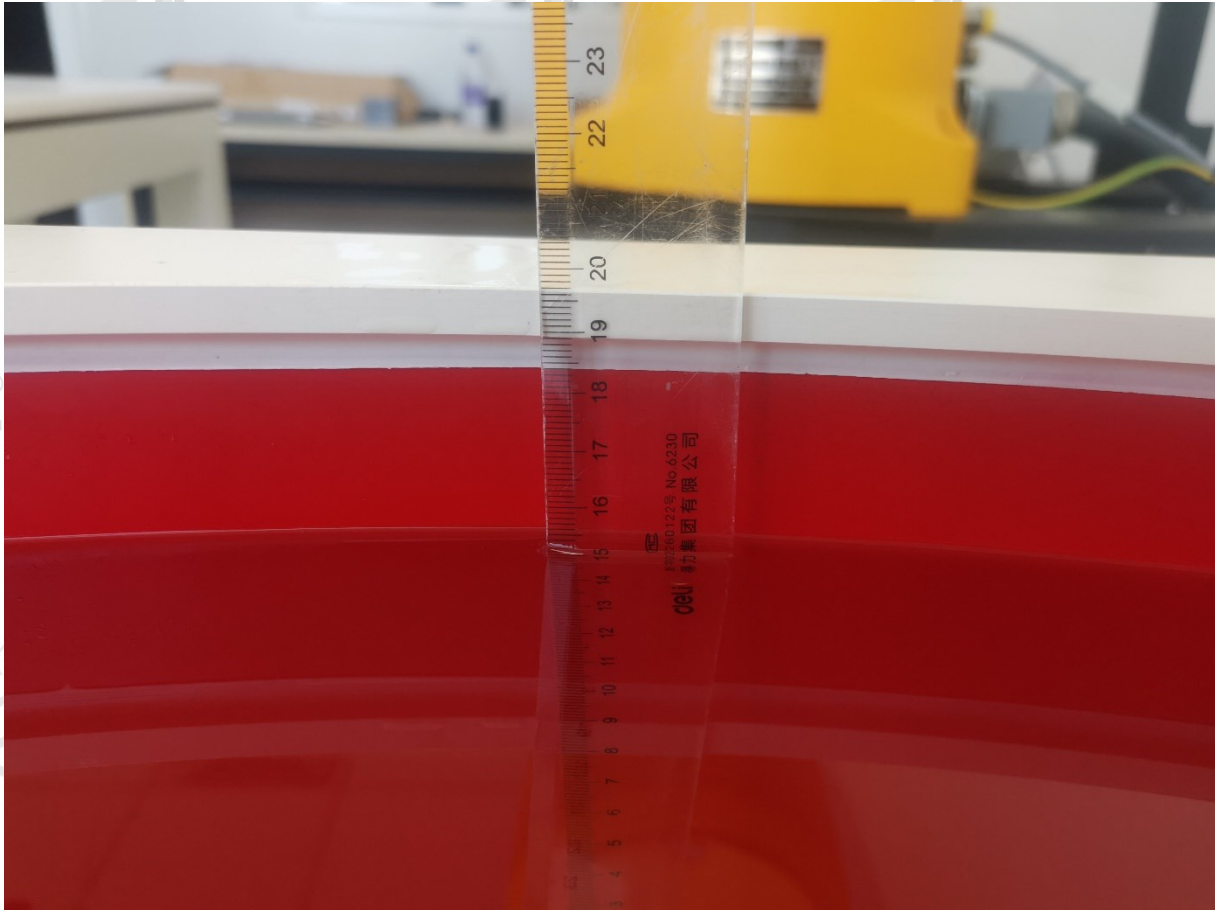

6.2. SAR System Validation

The microwave circuit arrangement for system verification is sketched in bellow figure. The daily system accuracy verification occurs within the flat section of the SAM phantom. A SAR measurement was performed to see if the measured SAR was within +/- 10% from the target SAR values. The tests were conducted on the same days as the measurement of the EUT. The obtained results from the system accuracy verification are displayed in the table 5 (A power level of 250mw was input to the dipole antenna). During the tests, the ambient temperature of the laboratory was in the range $22\pm 2^{\circ}\text{C}$, the relative humidity was in the range 60% and the liquid depth above the ear reference points was above 15 cm in all the cases. It is seen that the system is operating within its specification, as the results are within acceptable tolerance of the reference values.

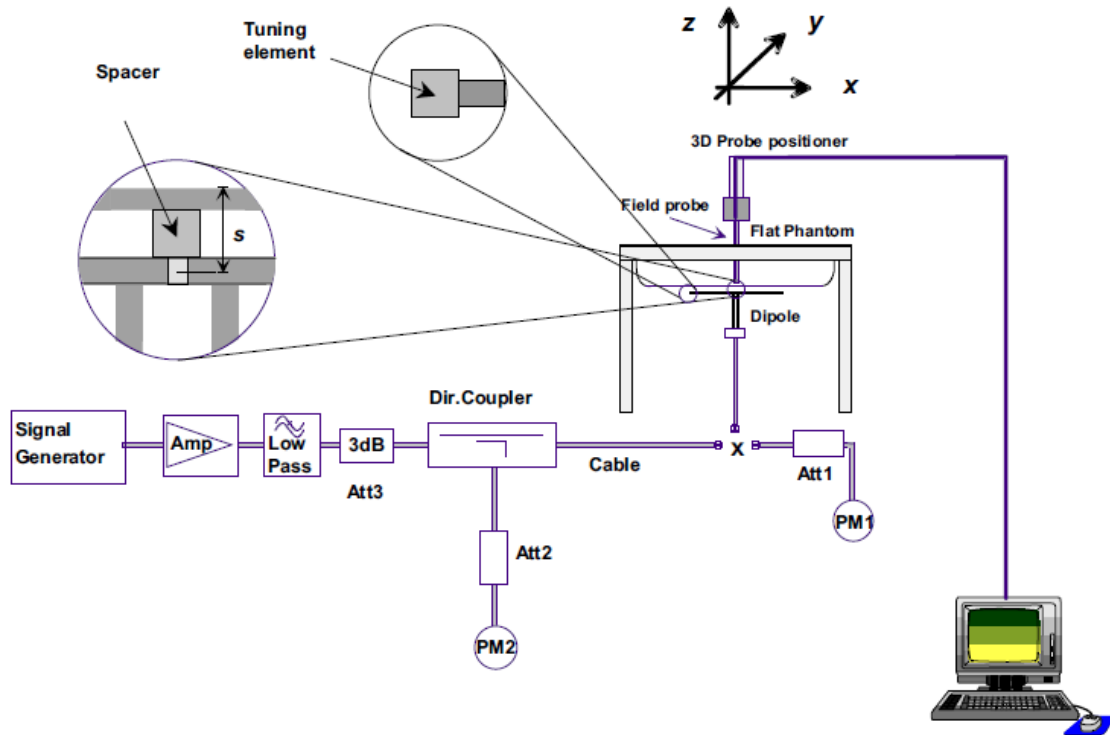

6.2.1. Justification for Extended SAR Dipole Calibrations

1) Referring to KDB865664 D01 requirements for dipole calibration, instead of the typical annual calibration recommended by measurement standards, longer calibration intervals of up to three years may be considered when it is demonstrated that the SAR target, impedance and return loss of a dipole have remain stable according to the following requirements. Each measured dipole is expected to evaluate with the following criteria at least on annual interval in Appendix C.

- a) There is no physical damage on the dipole;
- b) System check with specific dipole is within 10% of calibrated value;
- c) Return-loss is within 10% of calibrated measurement;
- d) Impedance is within 5Ω from the previous measurement.

2) Network analyzer probe calibration against air, distilled water and a shorting block performed before measuring liquid parameters.

6.2.2. Validation Test Setup Photograph

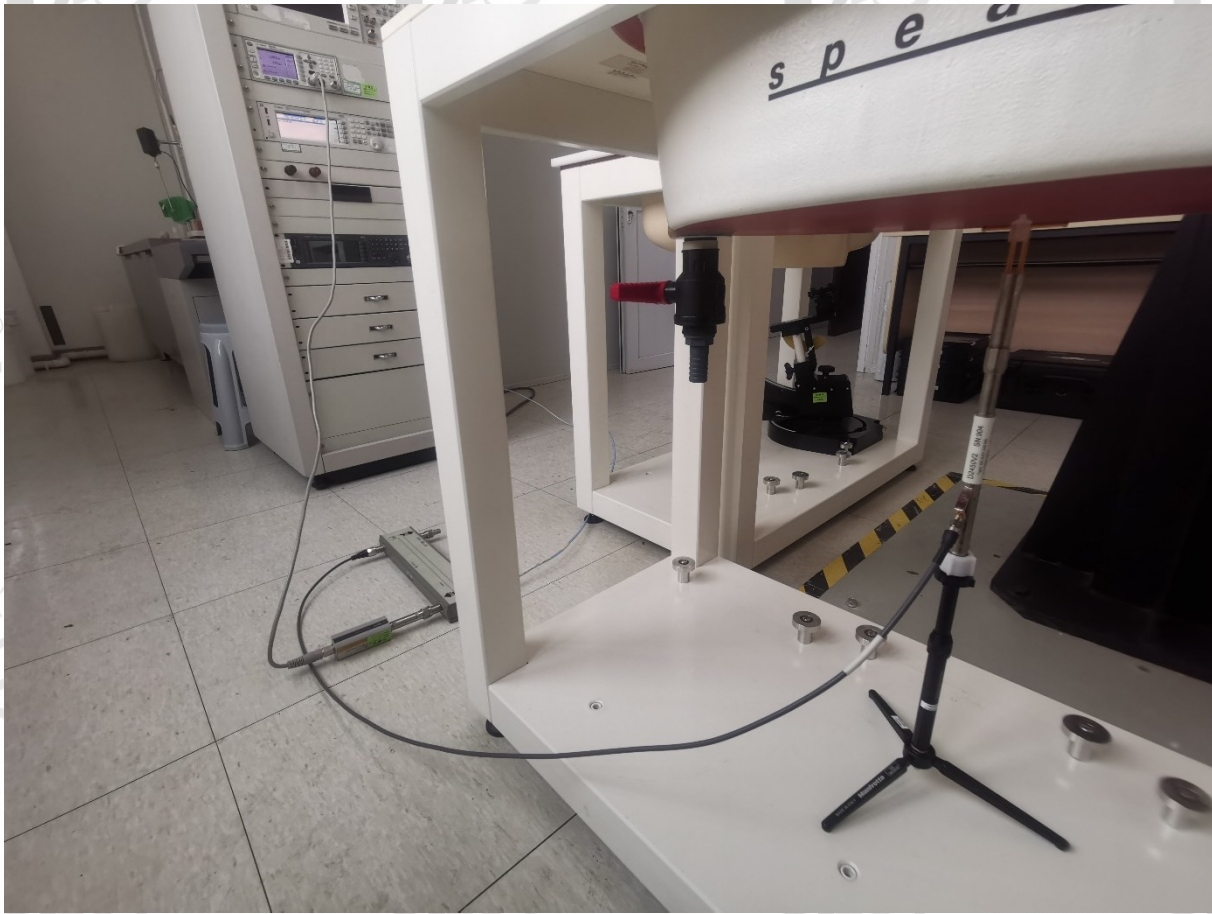

6.2.3. Summary System Validation Result(s)

Validation Kit	Measured SAR 250mW	Measured SAR normalized to 1w)	Target SAR (normalized to 1w) (±10%)	Liquid Temp. (°C)	Measured Date
	1g (W/kg)	1g (W/kg)	1-g(W/kg)		
D2450V2	13.00	52.00	53.1 (47.79~58.41)	21.0	2022/4/21

6.2.4. Detailed System Validation Results

See the Appendix A.

7. EQUIPMENT LIST

Test Platform	SPEAG DASY5 Professional				
Location	SAR room				
Description	SAR Test System (Frequency range 300MHz-6GHz)				
Equipment	Manufacturer	Model	Serial Number	Calibration Date	Due date of calibration
Robot	Staubli	TX90 XL	F12/5N3XC/A/01	NCR	NCR
SAM twin Phantom	SPEAG	SAM	1752	NCR	NCR
DAE	SPEAG	DAE4	1366	2022-01-21	2023-01-20
SAR test Probe	SPEAG	EX3DV4	3906	2022-02-27	2023-02-26
Validation Kits	SPEAG	D2450V2	904	2022-01-26	2025-01-25
Agilent Network Analyzer	Agilent	E5071C	MY46316792	2022-02-16	2023-02-15
Dielectric Probe Kit	Agilent	85070E	85070-20037	NCR	NCR
0.1G-2Ghz DUAL DIRECTIONAL COUPLER	Agilent	778D	MY52180233	NCR	NCR
Signal Generator	Agilent	N5182A	MY50143288	2022-03-07	2023-03-06
Preamplifier	Mini-Circuits	ZHL-42W	QA1240001	NCR	NCR
Preamplifier	Mini-Circuits	ZVE-8G+	926701231	NCR	NCR
EPM Series Power Meter	Agilent	N1914A	MY53040013	2022-02-16	2023-02-15
Power Sensor	Agilent	8481H	MY52490005	2022-02-16	2023-02-15
Attenuator	Agilent	8491A 3dB	MY52460179	NCR	NCR
Attenuator	Agilent	8491A 10dB	MY52460275	NCR	NCR
Humidity and Temperature Indicator	Anymetre	JR900	#4	2022-02-09	2023-02-08

8. MEASUREMENT UNCERTAINTY

Uncertainty Component	probability distribution	Contains the factor	Standard uncertainty U_i	C1(1g)	C1(10g)
Sensitivity of probe	N	1	±6.55%	1	1
Isotropy of the probe	R	$\sqrt{3}$	±1.08%	1	1
Linearity of the probe	R	$\sqrt{3}$	±0.35%	1	1
Coupling effect between probe and dielectric boundary	R	$\sqrt{3}$	±0.46%	1	1
The detection limit of the system	R	$\sqrt{3}$	±0.14%	1	1
Errors in electronic reading equipment	N	1	±0.35%	1	1
Measure the response time of the equipment	R	$\sqrt{3}$	0	1	1
Measure the integral time of the equipment	R	$\sqrt{3}$	±1.50%	1	1
Data post-processing algorithm	R	$\sqrt{3}$	±0.58%	1	1
Electromagnetic environment disturbance	R	$\sqrt{3}$	±1.73%	1	1
the positioning accuracy of the probe	R	$\sqrt{3}$	±0.87%	1	1
The positioning accuracy of the probe tip relative to the model surface	R	$\sqrt{3}$	±1.67%	1	1
Manufacturing tolerances for models	R	$\sqrt{3}$	±2.31%	1	1
Deviation of measured liquid conductivity from target value	R	$\sqrt{3}$	±2.89%	0.64	0.43
Liquid conductivity test system accuracy	N	1	±2.5%	0.64	0.43
The deviation between the measured permittivity of liquid and the target value	R	$\sqrt{3}$	±2.89%	0.6	0.49
Test precision of liquid permittivity test system	N	1	±2.5%	0.6	0.49
The disturbance of the positioning fixture	N	1	±5.2%	1	1
Accuracy of sample positioning	N	1	±4.6%	1	1
The output power of the tested sample drifts	R	$\sqrt{3}$	±2.89%	1	1
Combined standard uncertainty	Uc(1g)=11.3%, Uc(10g)=11.0%				
Expanded uncertainty(95% confidence interval) k=2	U(1g)=22.6%, U(10g)=22%				

9. TEST RESULTS AND MEASUREMENT DATA

9.1. RF conducted Power

Bluetooth BDR+EDR					
Average conducted power					
Mode	Channel	Frequency (MHz)	Power (dBm)	Duty-Cycle	Max. Tune-up Power (dBm)
DH5	0	2402	1.54	0.77	3
	39	2441	2.44	0.77	3
	78	2480	2.31	0.77	3
2DH5	0	2402	2.90	0.77	4
	39	2441	3.52	0.77	4
	78	2480	3.37	0.77	4
3DH5	0	2402	2.99	0.77	4
	39	2441	3.52	0.77	4
	78	2480	3.42	0.77	4

Note:

1. The output power of the device was set to transmit at maximum power for all test.
2. The maximum output power mode 2DH5 and 3DH5, select the 3DH5 as the primary mode to test SAR.

9.2. Measurement of SAR Data

9.2.1. SAR Result of Bluetooth BDR+EDR

Test position	Test mode	Test Ch./Freq.	Duty Cycle	SAR 1-g (W/kg)	Power drift (dB)	Conducted power (dBm)	Max. Tune-up Power (dBm)	Scaled factor	Scaled SAR 1g (W/kg)	Liquid Temp.	SAR limit 1g (W/kg)
Body Test data											
Top	3DH5	39/2441	0.77	0.0140	-0.12	3.52	4	1.4505	0.0203	21.0	1.6
Back	3DH5	39/2441	0.77	0.0024	0.14	3.52	4	1.4505	0.0035	21.0	1.6
Top	3DH5	0/2402	0.77	0.0120	0.11	2.99	4	1.6387	0.0197	21.0	1.6
Top	3DH5	78/2480	0.77	0.0150	-0.06	3.42	4	1.4843	0.0223	21.0	1.6

Note:

- 1) The maximum Scaled SAR value is marked in bold. Graph Results refer to Appendix B
- 2) If the reported (scaled) SAR measured at the middle channel or highest output power channel for each test configuration is ≤ 0.8 W/kg then testing at the other channels is not required for such test configuration(s).

10. APPENDIX

Appendix A: System Validation Plots

Appendix B: Highest Test Plots

Appendix C: Calibration Certification

Appendix D: Test setup photograph

END REPORT