

FCC AND IC CERTIFICATION TEST REPORT

FOR

Applicant	:	Harman International Industries, Inc.
Address	:	8500 Balboa Boulevard, Northridge, CA 91329, UNITED STATES
Equipment under Test	:	PORTABLE BLUETOOTH SPEAKER
Model No.	:	FLIP5
Trade Mark	:	JBL
FCC ID	:	APIJBLFLIP5
IC	:	6132A-JBLFLIP5
Manufacturer	:	Harman International Industries, Inc.
Address	:	8500 Balboa Boulevard, Northridge, CA 91329, UNITED STATES

Issued By: Dongguan Dongdian Testing Service Co., Ltd.

Add: No. 17, Zongbu Road 2, Songshan Lake Sci&Tech, Industry Park, Dongguan
City, Guangdong Province, China, 523808

Tel: +86-0769-38826678, **E-mail:** ddt@dgddt.com, <http://www.dgddt.com>

TABLE OF CONTENTS

	Test report declares.....	4
1.	Summary of test results	5
2.	General test information.....	6
2.1.	Description of EUT	6
2.2.	Accessories of EUT.....	6
2.3.	Assistant equipment used for test.....	8
2.4.	Block diagram of EUT configuration for test	8
2.5.	Test environment conditions	8
2.6.	Deviations of test standard.....	8
2.7.	Test laboratory	9
2.8.	Measurement uncertainty.....	9
3.	Equipment used during test	10
4.	20dB Bandwidth and 99% Bandwidth.....	12
4.1.	Block diagram of test setup.....	12
4.2.	Limits	12
4.3.	Test Procedure.....	12
4.4.	Test Result	12
4.5.	Original test data	13
5.	Radiated emission.....	16
5.1.	Block diagram of test setup.....	16
5.2.	Limit.....	17
5.3.	Test Procedure.....	18
5.4.	Test result.....	19
6.	Band Edge Compliance	45
6.1.	Block diagram of test setup.....	45
6.2.	Limit.....	45
6.3.	Test Procedure.....	45
6.4.	Test result.....	45
7.	Power Line Conducted Emission.....	54
7.1.	Block diagram of test setup.....	54
7.2.	Power Line Conducted Emission Limits	54
7.3.	Test Procedure.....	54
7.4.	Test Result	55
8.	Antenna Requirements	74
8.1.	Limit.....	74
8.2.	Result.....	74

TEST REPORT DECLARE

Applicant	:	Harman International Industries, Inc.
Address	:	8500 Balboa Boulevard, Northridge, CA 91329, UNITED STATES
Equipment under Test	:	PORTABLE BLUETOOTH SPEAKER
Model No.	:	FLIP5
Trade mark	:	JBL
Manufacturer	:	Harman International Industries, Inc.
Address	:	8500 Balboa Boulevard, Northridge, CA 91329, UNITED STATES

Test Standard Used:

FCC Rules and Regulations Part 15 Subpart C, RSS-210 Issue 9 August 2016.

Test procedure used:

ANSI C63.10:2013, RSS-Gen Issue 5, Apr. 2018.

We Declare:

The equipment described above is tested by Dongguan Dongdian Testing Service Co., Ltd. and in the configuration tested the equipment complied with the standards specified above. The test results are contained in this test report and Dongguan Dongdian Testing Service Co., Ltd. is assumed of full responsibility for the accuracy and completeness of these tests.

After test and evaluation, our opinion is that the equipment provided for test compliance with the requirement of the above FCC&IC standards.

Report No:	DDT-R18112311-9E6		
Date of Receipt:	Jan. 11, 2019	Date of Test:	Jan. 11, 2019 ~ Feb. 23, 2019
	Mar. 18, 2019		Mar. 18, 2019~ Mar. 22, 2019
	Nov. 01, 2019		Nov. 01, 2019~ Dec. 25, 2019

Prepared By:

Ella Gong
Ella Gong/Engineer

Approved By:

Damon Hu/EMC Manager

Note: This report applies to above tested sample only. This report shall not be reproduced in parts without written approval of Dongguan Dongdian Testing Service Co., Ltd.

Revision history

Rev.	Revisions	Issue Date	Revised By
---	Initial issue	Feb. 23, 2019	
Rev. 01	There are new battery models added in this report base on the original report, this change doesn't influence the RF performance, based exploratory test, there is no significant difference between different batteries, after the preliminary scan, the worst case power line conducted and radiated emission (below 1GHz) were tested and updated in this report.	Mar. 22, 2019	Ella Gong
Rev. 02	This report updated appearance keypad and added battery cell factory based on the original report, this change doesn't influence the RF performance, so only power line conducted and radiated emission (below 1GHz) were tested and updated in this report.	Dec. 25, 2019	Ella Gong

1. Summary of test results

The EUT have been tested according to the applicable standards as referenced below.		
Description of Test Item	Standard	Results
20dB Bandwidth and 99% Bandwidth	FCC Part 15: 15.215 ANSI C63.10:2013 RSS-210 Issue 9 RSS-Gen Issue 5	PASS
Radiated Emission	FCC Part 15: 15.209 FCC Part 15: 15.249 ANSI C63.10:2013 RSS-210 Issue 9 RSS-Gen Issue 5	PASS
Band Edge Compliance	FCC Part 15: 15.205 FCC Part 15: 15.249 ANSI C63.10:2013 RSS-210 Issue 9 RSS-Gen Issue 5	PASS
Power Line Conducted Emission	FCC Part 15: 15.207 ANSI C63.10:2013 RSS-Gen Issue 5	PASS
Antenna requirement	FCC Part 15: 15.203 RSS-Gen Issue 5	PASS

2. General test information

2.1. Description of EUT

EUT* Name	: PORTABLE BLUETOOTH SPEAKER
Model Number	: FLIP5
EUT function description	: Please reference user manual of this device
Power supply	: DC 5V from external AC Adapter : DC 3.6V 4800mAh Polymer Li-ion built-in battery
Operation frequency	: 2407MHz-2475MHz
Modulation	: GFSK, $\pi/4$ -DQPSK, 8DPSK
Antenna Type	: FPC antenna, maximum PK gain: 2.12 dBi
Sample Type	: Series production

Note: EUT is the ab. of equipment under test.

EUT channels and frequencies list:

Channel information					
Channel	Frequency	Channel	Frequency	Channel	Frequency
5	2407MHz	28	2430MHz	51	2453MHz
6	2408MHz	29	2431MHz	52	2454MHz
7	2409MHz	30	2432MHz	53	2455MHz
8	2410MHz	31	2433MHz	54	2456MHz
9	2411MHz	32	2434MHz	55	2457MHz
10	2412MHz	33	2435MHz	56	2458MHz
11	2413MHz	34	2436MHz	57	2459MHz
12	2414MHz	35	2437MHz	58	2460MHz
13	2415MHz	36	2438MHz	59	2461MHz
14	2416MHz	37	2439MHz	60	2462MHz
15	2417MHz	38	2440MHz	61	2463MHz
16	2418MHz	39	2441MHz	62	2464MHz
17	2419MHz	40	2442MHz	63	2465MHz
18	2420MHz	41	2443MHz	64	2466MHz
19	2421MHz	42	2444MHz	65	2467MHz
20	2422MHz	43	2445MHz	66	2468MHz
21	2423MHz	44	2446MHz	67	2469MHz
22	2424MHz	45	2447MHz	68	2470MHz
23	2425MHz	46	2448MHz	69	2471MHz
24	2426MHz	47	2449MHz	70	2472MHz
25	2427MHz	48	2450MHz	71	2473MHz
26	2428MHz	49	2451MHz	72	2474MHz
27	2429MHz	50	2452MHz	73	2475MHz

2.2. Accessories of EUT

Description of Accessories	Manufacturer	Model number	Parameter	Remark
Built-in Battery	ICON ENERGY SYSTEM (SHENZHEN) CO., LTD.	ID1060-A	DC 3.6V, 4800mAh, 17.28Wh	Alternative for factory 1
Built-in	ICON ENERGY	ID1060-B	DC 3.6V,	

Battery	SYSTEM (SHENZHEN) CO., LTD.		4800mAh, 17.28Wh	
Built-in Battery	Sunwoda Electronic Co., Ltd.	SUN-INTE-1521INR19/66-2 With Cell: 49-364800-1BAT2-A	DC 3.6V, 4800mAh, 17.28Wh	
Built-in Battery	Sunwoda Electronic Co., Ltd.	SUN-INTE-1521INR19/66-2 With Cell: 49-364800-BAT2-A	DC 3.6V, 4800mAh, 17.28Wh	
Built-in Battery	ICON ENERGY SYSTEM (SHENZHEN) CO., LTD.	ID1060-A	DC 3.6V, 4800mAh, 17.28Wh	Alternative for factory 2
Built-in Battery	ICON ENERGY SYSTEM (SHENZHEN) CO., LTD.	ID1060-B	DC 3.6V, 4800mAh, 17.28Wh	
Built-in Battery	Sunwoda Electronic Co., Ltd.	SUN-INTE-1521INR19/66-2 With Cell: 49-364800-1BAT2-A	DC 3.6V, 4800mAh, 17.28Wh	
Built-in Battery	Sunwoda Electronic Co., Ltd.	SUN-INTE-1521INR19/66-2 With Cell: 49-364800-BAT2-A	DC 3.6V, 4800mAh, 17.28Wh	Alternative for factory 3
Built-in Battery	Sunwoda Electronic Co., Ltd.	SUN-INTE-1521INR19/66-2 With Cell: 49-364800-1BAT2-A	DC 3.6V, 4800mAh, 17.28Wh	
USB cable	Harman	N/A	N/A	Length: 1.2m, unshielded

New Battery information:

Description of Accessories	Manufacturer	Model number	Description	Remark
Built-in Battery	ICON ENERGY SYSTEM (SHENZHEN) CO., LTD	IAA031NA	DC 3.6V, 4800mAh, 17.28Wh	Alternative for factory 1
Built-in Battery	ICON ENERGY SYSTEM (SHENZHEN) CO., LTD	IAA031NA	DC 3.6V, 4800mAh, 17.28Wh	Alternative for factory 2
Built-in Battery	SUNWODA Electronic Co., Ltd	SUN-INTE-276	DC3.6V, 4800mAh, 17.28Wh	Alternative for factory 3
Built-in Battery	Guangzhou Great power Energy & Technology Co., LTD.	GSP-1S2P-F5A	DC3.6V, 4800mAh, 17.28Wh	
Built-in Battery	Guangzhou Great power	GSP-1S2P-F5B	DC3.6V, 4800mAh,	

	Energy & Technology Co., LTD.		17.28Wh	
--	-------------------------------	--	---------	--

2.3. Assistant equipment used for test

Assistant equipment	Manufacturer	Model number	Serial No.	Other
Notebook	DELL	Latitude D610	FCC DOC	00045-534-136-300

2.4. Block diagram of EUT configuration for test

Tx Mode:

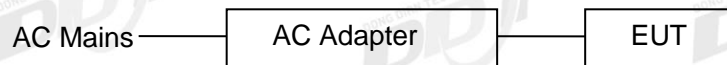

Test software: FCCTool.exe

The test software was used to control EUT work in Continuous Tx mode, and select test channel, wireless mode as below table.

:

Tested mode, channel, information		
Mode	Channel	Frequency (MHz)
GFSK Tx mode	CH5	2407
	CH39	2441
	CH73	2475
$\pi/4$ -DQPSK	CH5	2407
	CH39	2441
	CH73	2475
8DPSK Tx mode	CH5	2407
	CH39	2441
	CH73	2475

2.5. Test environment conditions

During the measurement the environmental conditions were within the listed ranges:

Temperature range:	21-25°C
Humidity range:	40-75%
Pressure range:	86-106kPa

2.6. Deviations of test standard

No Deviation.

2.7. Test laboratory

Dongguan Dongdian Testing Service Co., Ltd

Add: No. 17, Zongbu Road 2, Songshan Lake Sci&Tech, Industry Park, Dongguan City, Guangdong Province, China, 523808

Tel: +86-0769-38826678, <http://www.dgddt.com>, Email: ddt@dgddt.com

CNAS Accreditation No. L6451; A2LA Accreditation No. 3870.01

Designation Number: CN1182; Test Firm Registration Number: 540522

Industry Canada site registration number: 10288A-1

2.8. Measurement uncertainty

Test Item	Uncertainty
Bandwidth	1.1%
Peak Output Power (Conducted) (Spectrum analyzer)	0.86dB (10 MHz ≤ f < 3.6GHz);
	1.38dB (3.6GHz ≤ f < 8GHz)
Peak Output Power (Conducted) (Power Sensor)	0.74dB
Power Spectral Density	0.74dB (10 MHz ≤ f < 3.6GHz);
	1.38dB (3.6GHz ≤ f < 8GHz)
Conducted spurious emissions	0.86dB (10 MHz ≤ f < 3.6GHz);
	1.40dB (3.6GHz ≤ f < 8GHz)
	1.66dB (8GHz ≤ f < 22GHz)
Uncertainty for radio frequency (RBW<20kHz)	3×10^{-8}
Temperature	0.4°C
Humidity	2%
Uncertainty for Radiation Emission test (30MHz-1GHz)	4.70 dB (Antenna Polarize: V)
	4.84 dB (Antenna Polarize: H)
Uncertainty for Radiation Emission test (1GHz-18GHz)	4.10dB(1-6GHz)
	4.40dB (6GHz-18Gz)
Uncertainty for Power line conduction emission test	3.32dB (150kHz-30MHz)
Note: This uncertainty represents an expanded uncertainty expressed at approximately the 95% confidence level using a coverage factor of k=2.	

3. Equipment used during test

Equipment	Manufacturer	Model No.	Serial No.	Last Cal.	Cal. Interval
RF Connected Test (Tonscend RF Measurement System)					
Spectrum analyzer	R&S	FSU26	200071	Oct. 12, 2018	1 Year
Wideband Radio Communication tester	R&S	CMW500	117491	Jun. 29, 2018	1 Year
Vector Signal Generator	Agilent	E8267D	US49060192	Oct. 12, 2018	1 Year
Vector Signal Generator	Agilent	N5182A	MY48180737	Jun. 29, 2018	1 Year
Power Sensor	Agilent	U2021XA	MY55150010	Oct. 21, 2018	1 Year
Power Sensor	Agilent	U2021XA	MY55150011	Oct. 23, 2018	1 Year
DC Power Source	MATRIS	MPS-3005L-3	D813058W	Aug. 18, 2018	1 Year
Attenuator	Mini-Circuits	BW-S10W2	101109	Aug. 18, 2018	1 Year
RF Cable	Micable	C10-01-01-1	100309	Oct. 21, 2018	1 Year
Temp&Humi Programmable	ZHIXIANG	ZXGDJS-150L	ZX170110-A	Oct. 21, 2018	1 Year
Test Software	JS Tonscend	JS1120-3	Ver.2.7	N/A	N/A
Radiation 1#chamber					
EMI Test Receiver	R&S	ESU8	100316	Oct. 12, 2018	1 Year
Spectrum analyzer	Agilent	E4447A	MY50180031	Jun. 29, 2018	1 Year
Trilog Broadband Antenna	Schwarzbeck	VULB9163	9163-462	Nov. 09, 2018	1 Year
Active Loop antenna	Schwarzbeck	FMZB-1519	1519-038	Oct. 20, 2018	1 Year
Double Ridged Horn Antenna	R&S	HF907	100276	Nov. 16, 2018	1 Year
Broad Band Horn Antenna	Schwarzbeck	BBHA 9170	790	Oct. 25, 2018	1 Year
Pre-amplifier	A.H.	PAM-0118	360	Oct. 12, 2018	1 Year
Pre-amplifier	TERA-MW	TRLA-0040 G35	101303	Oct. 12, 2018	1 Year
RF Cable	HUBSER	CP-X2+ CP-X1	W11.03+ W12.02	Oct. 21, 2018	1 Year
RF Cable	N/A	SMAJ-SMAJ -1M+ 11M	17070133+17070131	Nov. 08, 2018	1 Year
MI Cable	HUBSER	C10-01-01-1 M	1091629	Oct. 21, 2018	1 Year
Test software	Audix	E3	V 6.11111b	N/A	N/A
Power Line Conducted Emissions Test					
EMI Test Receiver	R&S	ESU8	100316	Oct. 21, 2018	1 Year
LISN 1	R&S	ENV216	101109	Oct. 21, 2018	1 Year
LISN 2	R&S	ESH2-Z5	100309	Oct. 21, 2018	1 Year
Pulse Limiter	R&S	ESH3-Z2	101242	Oct. 21, 2018	1 Year
CE Cable 1	HUBSER	N/A	W10.01	Oct. 21, 2018	1 Year
Test software	Audix	E3	V 6.11111b	N/A	N/A

Equipment	Manufacturer	Model No.	Serial No.	Last Cal.	Cal. Interval
RF Connected Test (Tonscend RF Measurement System)					
Spectrum analyzer	R&S	FSU26	200071	Sep. 29, 2019	1 Year
Wideband Radio Communication tester	R&S	CMW500	117491	Jun. 25, 2019	1 Year
Vector Signal Generator	Agilent	E8267D	US49060192	Sep. 29, 2019	1 Year
Vector Signal Generator	Agilent	N5182A	MY48180737	Jun. 25, 2019	1 Year
Power Sensor	Agilent	U2021XA	MY55150010	Jun. 28, 2019	1 Year
Power Sensor	Agilent	U2021XA	MY55150011	Jun. 28, 2019	1 Year
DC Power Source	MATRIS	MPS-3005L-3	D813058W	Jun. 25, 2019	1 Year
RF Cable	Micable	C10-01-01-1	100309	Sep. 29, 2019	1 Year
Temp&Humi Programmable	ZHIXIANG	ZXGDJS-150L	ZX170110-A	Sep. 29, 2019	1 Year
Test Software	JS Tonscend	JS1120-3	Ver.2.7	N/A	N/A
Radiation 1#chamber					
EMI Test Receiver	R&S	ESU8	100316	Sep. 29, 2019	1 Year
Spectrum analyzer	Agilent	E4447A	MY50180031	Jun. 25, 2019	1 Year
Trilog Broadband Antenna	Schwarzbeck	VULB9163	9163-462	Nov. 15, 2019	1 Year
Active Loop antenna	Schwarzbeck	FMZB-1519	1519-038	Sep. 29, 2019	1 Year
Double Ridged Horn Antenna	R&S	HF907	100276	Nov. 15, 2019	1 Year
Broad Band Horn Antenna	Schwarzbeck	BBHA 9170	790	Sep. 29, 2019	1 Year
Pre-amplifier	A.H.	PAM-0118	360	Sep. 29, 2019	1 Year
Pre-amplifier	TERA-MW	TRLA-0040 G35	101303	Sep. 29, 2019	1 Year
RF Cable	HUBSER	CP-X2+ CP-X1	W11.03+ W12.02	Sep. 29, 2019	1 Year
RF Cable	N/A	SMAJ-SMAJ -1M+ 11M	17070133+17070131	Sep. 29, 2019	1 Year
MI Cable	HUBSER	C10-01-01-1 M	1091629	Sep. 29, 2019	1 Year
Test software	Audix	E3	V 6.11111b	N/A	N/A
Power Line Conducted Emissions Test					
EMI Test Receiver	R&S	ESU8	100316	Sep. 29, 2019	1 Year
LISN 1	R&S	ENV216	101109	Sep. 29, 2019	1 Year
LISN 2	R&S	ESH2-Z5	100309	Sep. 29, 2019	1 Year
Pulse Limiter	R&S	ESH3-Z2	101242	Sep. 29, 2019	1 Year
CE Cable 1	HUBSER	N/A	W10.01	Sep. 29, 2019	1 Year
Test software	Audix	E3	V 6.11111b	N/A	N/A

4. 20dB Bandwidth and 99% Bandwidth

4.1. Block diagram of test setup

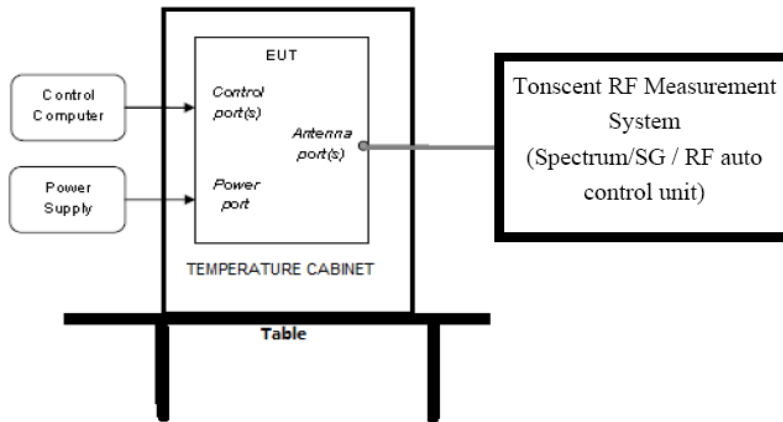

4.2. Limits

Intentional radiators operating under the alternative provisions to the general emission limits, as contained in § 15.217 through 15.257 and in Subpart E of this part, must be designed to ensure that the 20dB bandwidth of the emission, or whatever bandwidth may otherwise be specified in the specific rule section under which the equipment operates, is contained within the frequency band designated in the rule section under which the equipment is operated.

4.3. Test Procedure

(1) Connect EUT's antenna output to spectrum analyzer by RF cable.

(2) Set the spectrum analyzer as follows:

RBW:	30kHz
VBW:	100kHz
Detector Mode:	Peak
Sweep time:	auto
Trace mode	Max hold

(3) Allow the trace to stabilize, measure the 20dB and 99% bandwidth of signal.

4.4. Test Result

Test Mode	Freq. (MHz)	99% bandwidth Result (MHz)	20dB bandwidth Result (MHz)	Conclusion
GFSK	2407	0.923	1.061	PASS
	2441	0.923	1.058	PASS
	2475	0.923	1.042	PASS
$\pi/4$ -DQPSK	2407	1.176	1.311	PASS
	2441	1.173	1.321	PASS
	2475	1.179	1.317	PASS
8DPSK	2407	1.176	1.304	PASS
	2441	1.179	1.298	PASS

	2475	1.173	1.301	PASS
--	------	-------	-------	------

4.5. Original test data

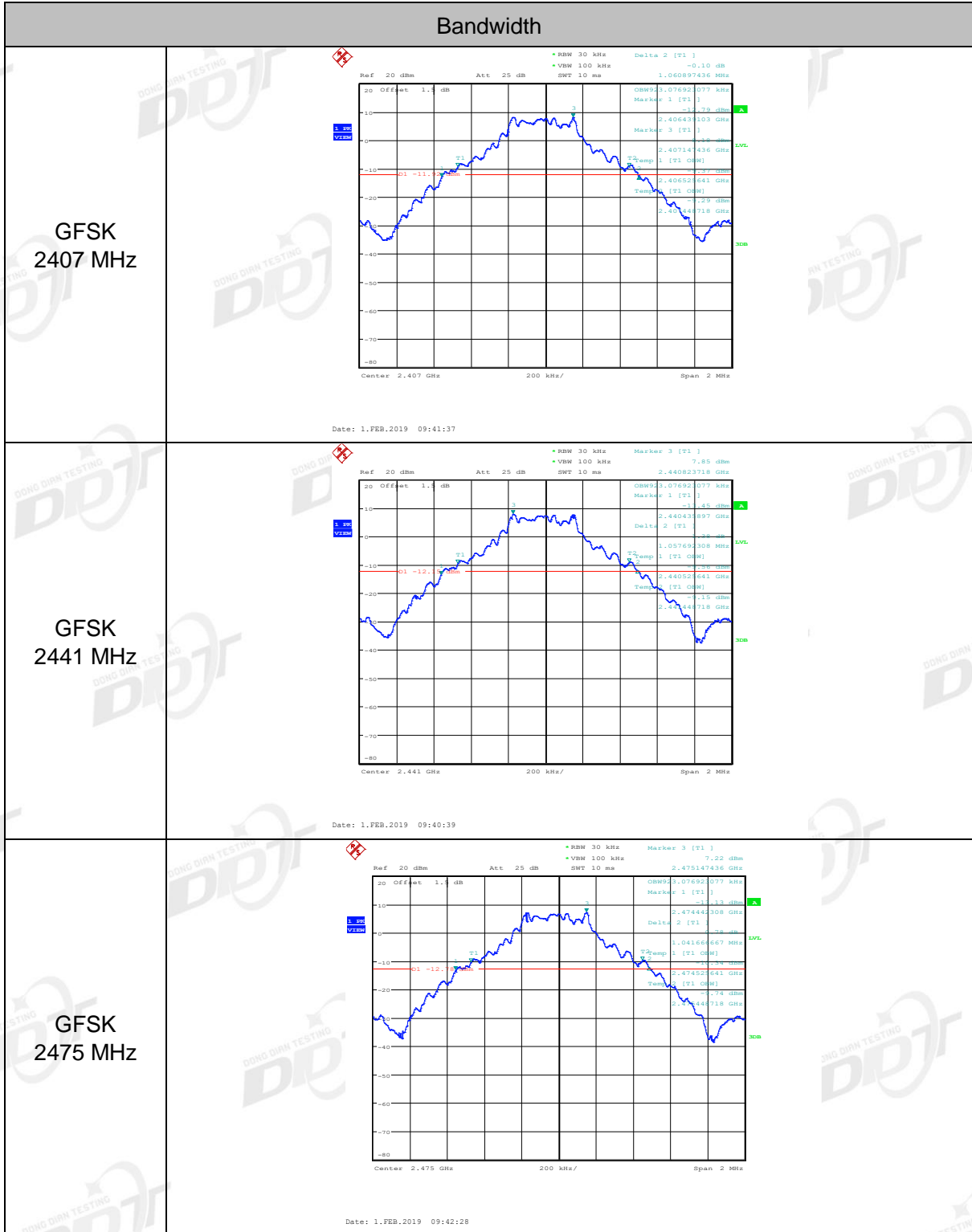

$\pi/4$ -DQPSK
2407 MHz

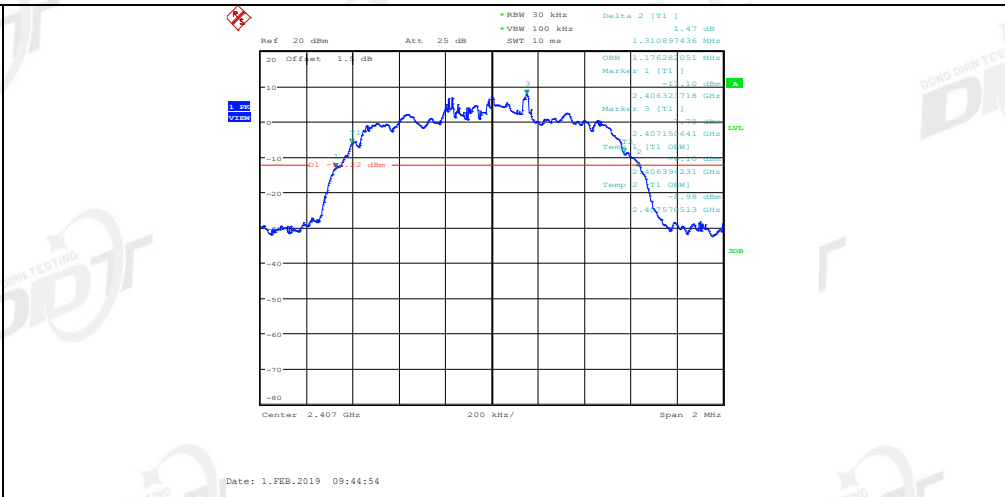

$\pi/4$ -DQPSK
2441 MHz

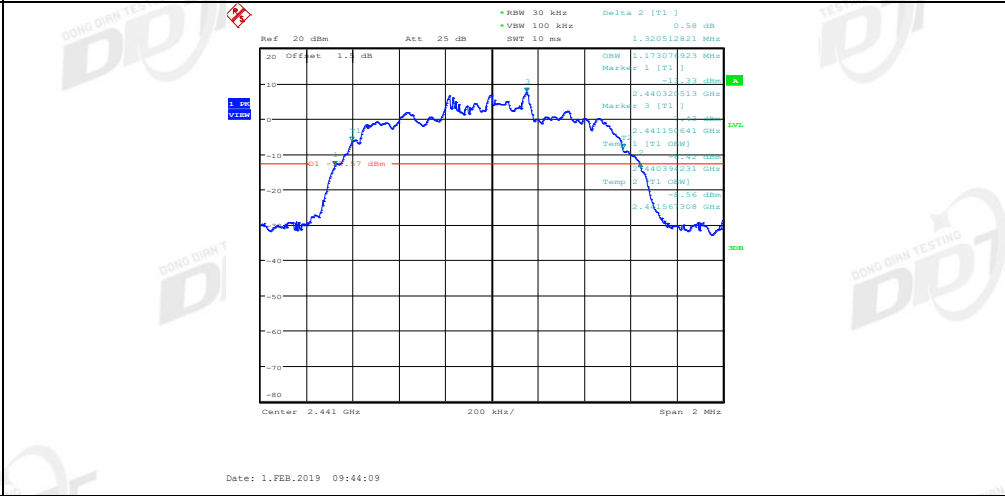

$\pi/4$ -DQPSK
2475 MHz

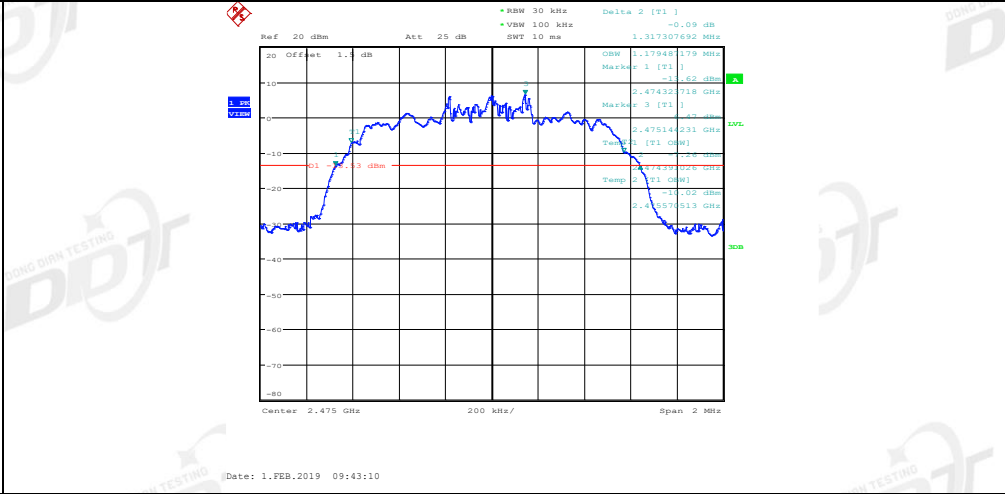

8DPSK
2407 MHz

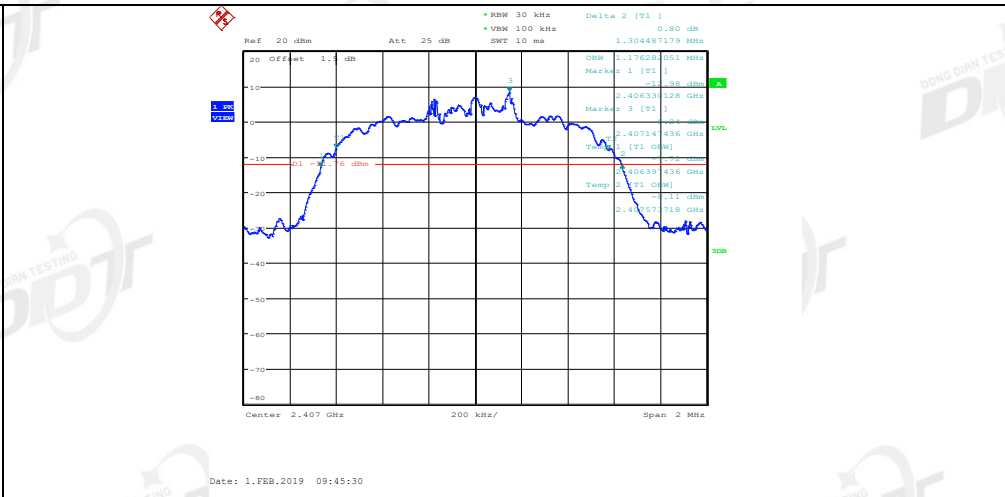

8DPSK
2441 MHz

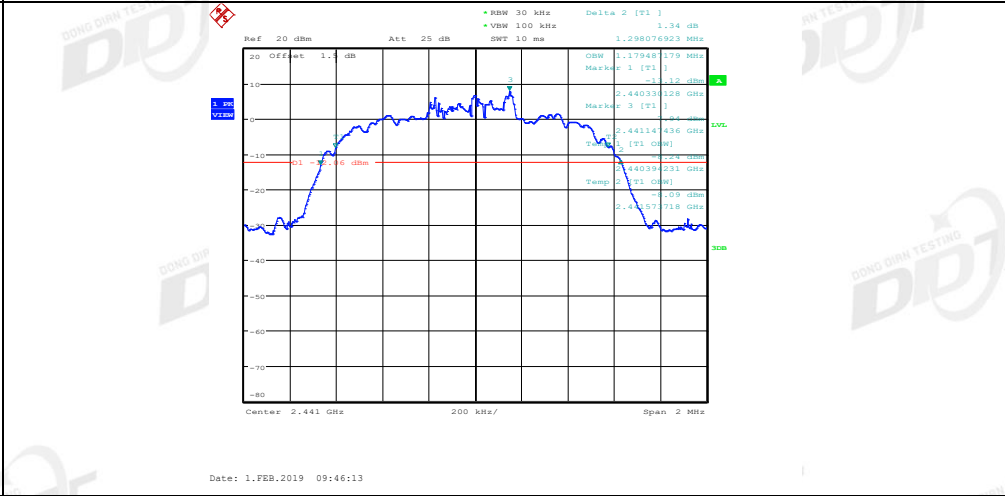

8DPSK
2475 MHz

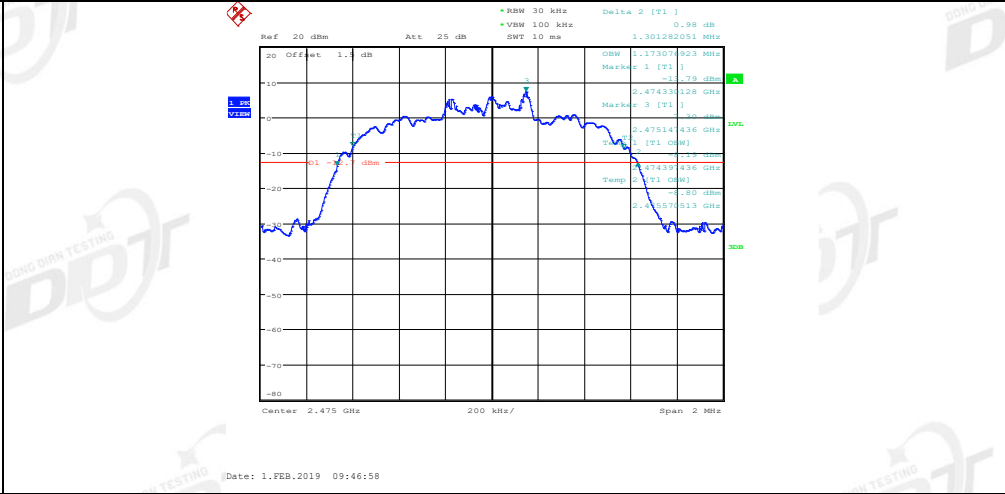

5. Radiated emission

5.1. Block diagram of test setup

In 3m Anechoic Chamber Test Setup Diagram for 9kHz-30MHz

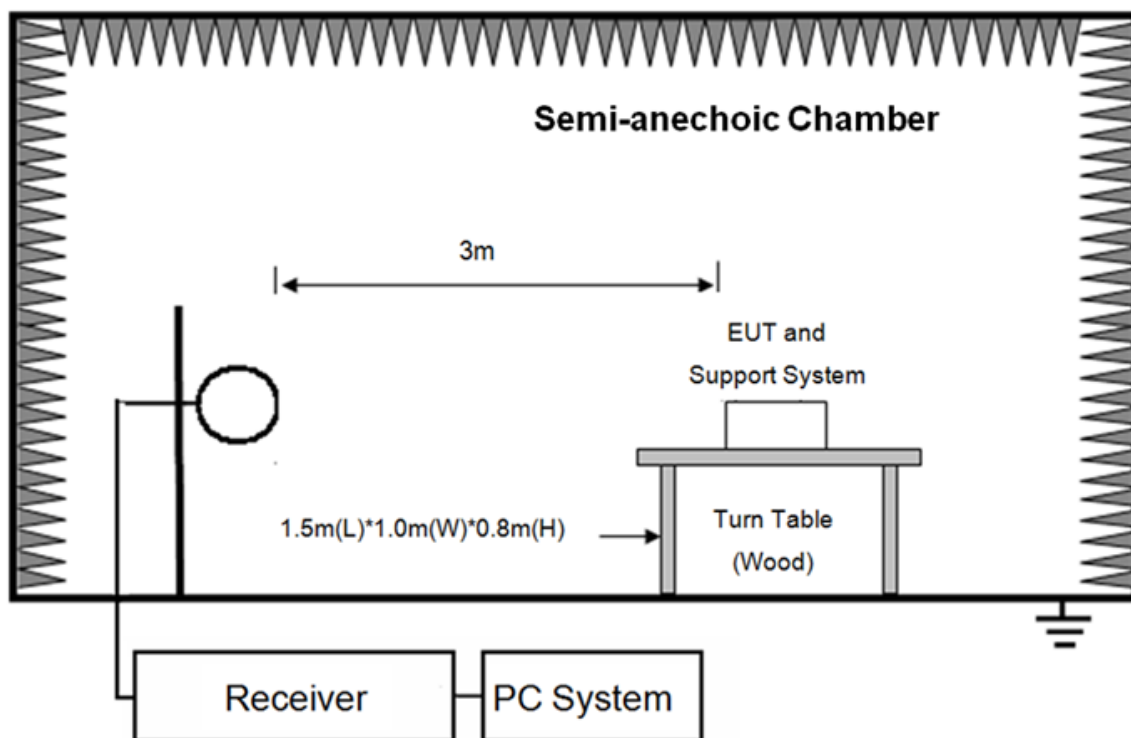

In 3m Anechoic Chamber Test Setup Diagram for 30MHz-1GHz

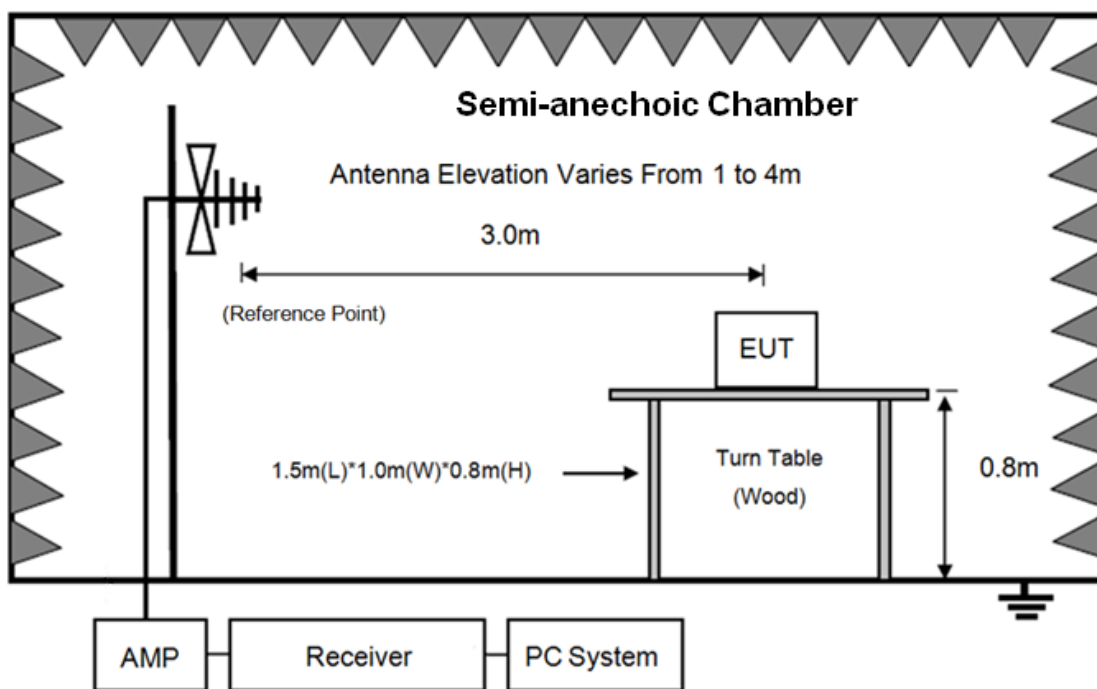

In 3m Anechoic Chamber Test Setup Diagram for frequency above 1GHz

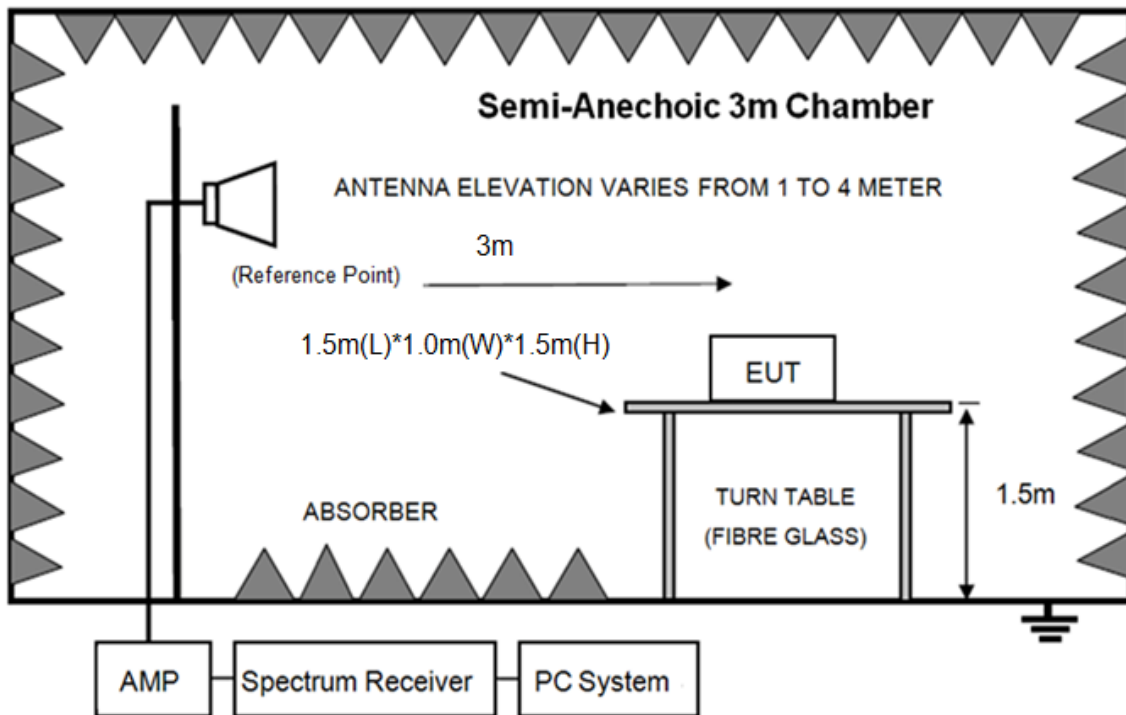

Note: For harmonic emissions test an appropriate high pass filter was inserted in the input port of AMP.

5.2. Limit

FREQUENCY MHz	DISTANCE Meters	FIELD STRENGTHS LIMIT	
		$\mu\text{V}/\text{m}$	$\text{dB}(\mu\text{V})/\text{m}$
30 ~ 88	3	100	40.0
88 ~ 216	3	150	43.5
216 ~ 960	3	200	46.0
960 ~ 1000	3	500	54.0
Above 1000MHz	3	74.0 $\text{dB}(\mu\text{V})/\text{m}$ (Peak) 54.0 $\text{dB}(\mu\text{V})/\text{m}$ (Average)	
Field Strength of Fundamental emission for 2.4GHz-2.4835GHz	3	94.0 $\text{dB}(\mu\text{V})/\text{m}$ (Average) 114.0 $\text{dB}(\mu\text{V})/\text{m}$ (Peak)	
Field Strength of Harmonics	3	74.0 $\text{dB}(\mu\text{V})/\text{m}$ (Peak) 54.0 $\text{dB}(\mu\text{V})/\text{m}$ (Average)	

Remark:

- (1) Emission level $\text{dB}\mu\text{V} = 20 \log$ Emission level $\mu\text{V}/\text{m}$
- (2) The smaller limit shall apply at the cross point between two frequency bands.
- (3) Distance is the distance in meters between the measuring instrument, antenna and the closest point of any part of the device or system.
- (4) The emission limits shown in the above table are based on measurements employing a CISPR quasi-peak detector except for the frequency bands 9-90 kHz, 110-490 kHz and above 1000MHz, radiated emission limits in these three bands are based on measurements employing an average detector.

5.3. Test Procedure

- (1) EUT was placed on a non-metallic table, 80 cm above the ground plane inside a semi-anechoic chamber.
- (2) Setup EUT and assistant system according clause 2.3 and 4.2
- (3) Test antenna was located 3m from the EUT on an adjustable mast. Below pre-scan procedure was first performed in order to find prominent radiated emissions.
 - (a) Change work frequency or channel of device if practicable.
 - (b) Change modulation type of device if practicable.
 - (c) Change power supply range from 85% to 115% of the rated supply voltage
 - (d) Rotated EUT though three orthogonal axes to determine the attitude of EUT arrangement produces highest emissions
- (4) Spectrum frequency from 9kHz to 25GHz (tenth harmonic of fundamental frequency) was investigated, and no any obvious emission were detected from 9kHz to 30MHz and 18GHz to 25GHz, so below final test was performed with frequency range from 30MHz to 18GHz.
- (5) For final emissions measurements at each frequency of interest, the EUT were rotated and the antenna height was varied between 1m and 4m in order to maximize the emission. Measurements in both horizontal and vertical polarities were made and the data was recorded. In order to find the maximum emission, the relative positions of equipments and all of the interface cables were changed according to ANSI C63.10 2013 on Radiated Emission test.
- (6) For emissions from 30MHz to 1GHz, Quasi-Peak values were measured with EMI Receiver and the bandwidth of Receiver is 120 kHz.
- (7) For emissions above 1GHz, both Peak and Average level were measured with Spectrum Analyzer, and the RBW is set at 1MHz, VBW is set at 3MHz for Peak measure; RBW is set at 1MHz, VBW is set at 10Hz for Average measure. Peak detector is used for both PK and AV test.
- (8) For fundamental frequency test, set spectrum analyzer's RBW=3MHz, VBW=10MHz. peak detector for PK, RMS detector for AV, Read the Level in spectrum analyzer and record.

5.4. Test result

PASS. (See below detailed test result)

All the emissions except fundamental emission from 9kHz to 25GHz were comply with 15.209 limit.

Note1: According exploratory test no any obvious emission was detected from 9kHz to 30MHz and 18GHz to 25GHz, so the final test was performed with frequency range from 30MHz to 18GHz and recorded in below.

Note2: For emissions below 1GHz, according exploratory explorer test, when change Tx mode and channel, have no distinct influence on emissions level, so for emissions below 1GHz, the final test was only performed with EUT working in GFSK, Tx 2407MHz mode.

Note3: For emissions above 1GHz. If peak results comply with AV limit, AV Result is deemed to comply with AV limit.

Field Strength of the Fundamental Signal

Factory 1:

Peak value:

Mode	Freq. (MHz)	Read level (dB μ V)	Antenna Factor (dB/m)	PRM Factor(dB)	Cable Loss (dB)	Result Level (dB μ V/m)	Limit (dB μ V/m)	Margin (dB)	Polarization
GFSK	2407.00	113.09	29.13	44.18	4.59	102.63	114.00	-11.37	HORIZONTAL
GFSK	2407.00	112.13	29.13	44.18	4.59	101.67	114.00	-12.33	VERTICAL
GFSK	2441.00	112.00	29.19	44.20	4.72	101.71	114.00	-12.29	HORIZONTAL
GFSK	2441.00	109.70	29.19	44.20	4.72	99.41	114.00	-14.59	VERTICAL
GFSK	2475.00	110.69	29.25	44.21	4.86	100.59	114.00	-13.41	HORIZONTAL
GFSK	2475.00	109.75	29.26	44.21	4.86	99.66	114.00	-14.34	VERTICAL
$\pi/4$ -DQPSK	2407.00	110.05	29.13	44.18	4.59	99.59	114.00	-14.41	HORIZONTAL
$\pi/4$ -DQPSK	2407.00	92.31	29.13	44.18	4.59	81.85	114.00	-32.15	VERTICAL
$\pi/4$ -DQPSK	2441.00	109.33	29.19	44.20	4.72	99.04	114.00	-14.96	HORIZONTAL
$\pi/4$ -DQPSK	2441.00	96.08	29.19	44.20	4.72	85.79	114.00	-28.21	VERTICAL
$\pi/4$ -DQPSK	2475.00	107.11	29.25	44.21	4.86	97.01	114.00	-16.99	HORIZONTAL
$\pi/4$ -DQPSK	2475.00	108.05	29.26	44.21	4.86	97.96	114.00	-16.04	VERTICAL
8DPSK	2407.00	108.16	29.13	44.18	4.59	97.70	114.00	-16.30	HORIZONTAL
8DPSK	2407.00	92.04	29.13	44.18	4.59	81.58	114.00	-32.42	VERTICAL
8DPSK	2441.00	96.55	29.19	44.20	4.72	86.26	114.00	-27.74	HORIZONTAL
8DPSK	2441.00	96.55	29.19	44.20	4.72	86.26	114.00	-27.74	VERTICAL
8DPSK	2475.00	106.39	29.25	44.21	4.86	96.29	114.00	-17.71	HORIZONTAL
8DPSK	2475.00	107.20	29.26	44.21	4.86	97.11	114.00	-16.89	VERTICAL

Average value:

Mode	Freq. (MHz)	Read level (dB μ V)	Antenna Factor (dB/m)	PRM Factor(dB)	Cable Loss (dB)	Result Level (dB μ V/m)	Limit (dB μ V/m)	Margin (dB)	Polarization
GFSK	2407.00	97.79	29.13	44.18	4.59	87.33	94.00	-6.67	HORIZONTAL
GFSK	2407.00	96.85	29.13	44.18	4.59	86.39	94.00	-7.61	VERTICAL
GFSK	2441.00	96.48	29.19	44.20	4.72	86.19	94.00	-7.81	HORIZONTAL
GFSK	2441.00	94.88	29.19	44.20	4.72	84.59	94.00	-9.41	VERTICAL
GFSK	2475.00	95.91	29.25	44.21	4.86	85.81	94.00	-8.19	HORIZONTAL
GFSK	2475.00	95.23	29.26	44.21	4.86	85.14	94.00	-8.86	VERTICAL
$\pi/4$ -DQPSK	2407.00	93.13	29.13	44.18	4.59	82.67	94.00	-11.33	HORIZONTAL
$\pi/4$ -DQPSK	2407.00	78.87	29.13	44.18	4.59	68.41	94.00	-25.59	VERTICAL
$\pi/4$ -DQPSK	2441.00	92.40	29.19	44.20	4.72	82.11	94.00	-11.89	HORIZONTAL
$\pi/4$ -DQPSK	2441.00	82.42	29.19	44.20	4.72	72.13	94.00	-21.87	VERTICAL
$\pi/4$ -DQPSK	2475.00	90.60	29.25	44.21	4.86	80.50	94.00	-13.50	HORIZONTAL
$\pi/4$ -DQPSK	2475.00	84.08	29.26	44.21	4.86	73.99	94.00	-20.01	VERTICAL
8DPSK	2407.00	98.52	29.13	44.18	4.59	88.06	94.00	-5.94	HORIZONTAL
8DPSK	2407.00	85.21	29.13	44.18	4.59	74.75	94.00	-19.25	VERTICAL
8DPSK	2441.00	86.52	29.19	44.20	4.72	76.23	94.00	-17.77	HORIZONTAL
8DPSK	2441.00	86.52	29.19	44.20	4.72	76.23	94.00	-17.77	VERTICAL
8DPSK	2475.00	94.52	29.25	44.21	4.86	84.42	94.00	-9.58	HORIZONTAL
8DPSK	2475.00	87.52	29.26	44.21	4.86	77.43	94.00	-16.57	VERTICAL

Result: Pass

Factory 2:
Peak value:

Mode	Freq. (MHz)	Read level (dB μ V)	Antenna Factor (dB/m)	PRM Factor(dB)	Cable Loss (dB)	Result Level (dB μ V/m)	Limit (dB μ V/m)	Margin (dB)	Polarization
GFSK	2407.00	109.65	29.13	44.18	4.59	99.19	114.00	-14.81	HORIZONTAL
GFSK	2407.00	109.43	29.13	44.18	4.59	98.97	114.00	-15.03	VERTICAL
GFSK	2441.00	109.89	29.19	44.20	4.72	99.60	114.00	-14.40	HORIZONTAL
GFSK	2441.00	107.84	29.19	44.20	4.72	97.55	114.00	-16.45	VERTICAL
GFSK	2475.00	108.95	29.25	44.21	4.86	98.85	114.00	-15.15	HORIZONTAL
GFSK	2475.00	104.95	29.26	44.21	4.86	94.86	114.00	-19.14	VERTICAL
$\pi/4$ -DQPSK	2407.00	109.66	29.13	44.18	4.59	99.20	114.00	-14.80	HORIZONTAL
$\pi/4$ -DQPSK	2407.00	109.61	29.13	44.18	4.59	99.15	114.00	-14.85	VERTICAL
$\pi/4$ -DQPSK	2441.00	110.07	29.19	44.20	4.72	99.78	114.00	-14.22	HORIZONTAL
$\pi/4$ -DQPSK	2441.00	108.11	29.19	44.20	4.72	97.82	114.00	-16.18	VERTICAL
$\pi/4$ -DQPSK	2475.00	109.18	29.26	44.21	4.86	99.09	114.00	-14.91	HORIZONTAL
$\pi/4$ -DQPSK	2475.00	105.31	29.25	44.21	4.86	95.21	114.00	-18.79	VERTICAL
8DPSK	2407.00	109.90	29.13	44.18	4.59	99.44	114.00	-14.56	HORIZONTAL
8DPSK	2407.00	109.90	29.13	44.18	4.59	99.44	114.00	-14.56	VERTICAL
8DPSK	2441.00	110.36	29.19	44.20	4.72	100.07	114.00	-13.93	HORIZONTAL
8DPSK	2441.00	107.76	29.19	44.20	4.72	97.47	114.00	-16.53	VERTICAL
8DPSK	2475.00	109.51	29.25	44.21	4.86	99.41	114.00	-14.59	HORIZONTAL
8DPSK	2475.00	105.48	29.25	44.21	4.86	95.38	114.00	-18.62	VERTICAL

Average value:

Mode	Freq. (MHz)	Read level (dB μ V)	Antenna Factor (dB/m)	PRM Factor(dB)	Cable Loss (dB)	Result Level (dB μ V/m)	Limit (dB μ V/m)	Margin (dB)	Polarization
GFSK	2407.00	94.92	29.13	44.18	4.59	84.46	94.00	-9.54	HORIZONTAL
GFSK	2407.00	94.98	29.13	44.18	4.59	84.52	94.00	-9.48	VERTICAL
GFSK	2441.00	95.12	29.19	44.20	4.72	84.83	94.00	-9.17	HORIZONTAL
GFSK	2441.00	95.19	29.19	44.20	4.72	84.90	94.00	-9.10	VERTICAL
GFSK	2475.00	93.81	29.25	44.21	4.86	83.71	94.00	-10.29	HORIZONTAL
GFSK	2475.00	90.96	29.26	44.21	4.86	80.87	94.00	-13.13	VERTICAL
$\pi/4$ -DQPSK	2407.00	92.53	29.13	44.18	4.59	82.07	94.00	-11.93	HORIZONTAL
$\pi/4$ -DQPSK	2407.00	92.70	29.13	44.18	4.59	82.24	94.00	-11.76	VERTICAL
$\pi/4$ -DQPSK	2441.00	93.03	29.19	44.20	4.72	82.74	94.00	-11.26	HORIZONTAL
$\pi/4$ -DQPSK	2441.00	91.38	29.19	44.20	4.72	81.09	94.00	-12.91	VERTICAL
$\pi/4$ -DQPSK	2475.00	92.26	29.26	44.21	4.86	82.17	94.00	-11.83	HORIZONTAL
$\pi/4$ -DQPSK	2475.00	90.25	29.25	44.21	4.86	80.15	94.00	-13.85	VERTICAL
8DPSK	2407.00	92.54	29.13	44.18	4.59	82.08	94.00	-11.92	HORIZONTAL
8DPSK	2407.00	89.74	29.13	44.18	4.59	79.28	94.00	-14.72	VERTICAL
8DPSK	2441.00	91.87	29.19	44.20	4.72	81.58	94.00	-12.42	HORIZONTAL
8DPSK	2441.00	87.86	29.19	44.20	4.72	77.57	94.00	-16.43	VERTICAL
8DPSK	2475.00	87.59	29.25	44.21	4.86	77.49	94.00	-16.51	HORIZONTAL
8DPSK	2475.00	83.66	29.25	44.21	4.86	73.56	94.00	-20.44	VERTICAL

Result: Pass

Note: Result Level = Read Level + Antenna Factor + Cable loss - PRM Factor

Factory 3:
Peak value:

Mode	Freq. (MHz)	Read level (dB μ V)	Antenna Factor (dB/m)	PRM Factor(dB)	Cable Loss (dB)	Result Level (dB μ V/m)	Limit (dB μ V/m)	Margin (dB)	Polarization
GFSK	2407.00	111.87	29.13	44.18	4.59	101.41	114.00	-12.59	HORIZONTAL
GFSK	2407.00	108.32	29.13	44.18	4.59	97.86	114.00	-16.14	VERTICAL
GFSK	2441.00	113.68	29.19	44.20	4.72	103.39	114.00	-10.61	HORIZONTAL
GFSK	2441.00	107.45	29.19	44.20	4.72	97.16	114.00	-16.84	VERTICAL
GFSK	2475.00	113.70	29.25	44.21	4.86	103.60	114.00	-10.40	HORIZONTAL
GFSK	2475.00	109.73	29.25	44.21	4.86	99.63	114.00	-14.37	VERTICAL
$\pi/4$ -DQPSK	2407.00	113.17	29.13	44.18	4.59	102.71	114.00	-11.29	HORIZONTAL
$\pi/4$ -DQPSK	2407.00	108.26	29.13	44.18	4.59	97.80	114.00	-16.20	VERTICAL
$\pi/4$ -DQPSK	2441.00	114.10	29.19	44.20	4.72	103.81	114.00	-10.19	HORIZONTAL
$\pi/4$ -DQPSK	2441.00	107.52	29.19	44.20	4.72	97.23	114.00	-16.77	VERTICAL
$\pi/4$ -DQPSK	2475.00	114.24	29.25	44.21	4.86	104.14	114.00	-9.86	HORIZONTAL
$\pi/4$ -DQPSK	2475.00	106.24	29.26	44.21	4.86	96.15	114.00	-17.85	VERTICAL
8DPSK	2407.00	113.55	29.13	44.18	4.59	103.09	114.00	-10.91	HORIZONTAL
8DPSK	2407.00	108.73	29.13	44.18	4.59	98.27	114.00	-15.73	VERTICAL
8DPSK	2441.00	112.27	29.19	44.20	4.72	101.98	114.00	-12.02	HORIZONTAL
8DPSK	2441.00	107.56	29.19	44.20	4.72	97.27	114.00	-16.73	VERTICAL
8DPSK	2475.00	113.08	29.25	44.21	4.86	102.98	114.00	-11.02	HORIZONTAL
8DPSK	2475.00	110.21	29.25	44.21	4.86	100.11	114.00	-13.89	VERTICAL

Average value:

Mode	Freq. (MHz)	Read level (dB μ V)	Antenna Factor (dB/m)	PRM Factor(dB)	Cable Loss (dB)	Result Level (dB μ V/m)	Limit (dB μ V/m)	Margin (dB)	Polarization
GFSK	2407.00	97.73	29.13	44.18	4.59	87.27	94.00	-6.73	HORIZONTAL
GFSK	2407.00	93.19	29.13	44.18	4.59	82.73	94.00	-11.27	VERTICAL
GFSK	2441.00	97.11	29.19	44.20	4.72	86.82	94.00	-7.18	HORIZONTAL
GFSK	2441.00	93.30	29.19	44.20	4.72	83.01	94.00	-10.99	VERTICAL
GFSK	2475.00	98.29	29.25	44.21	4.86	88.19	94.00	-5.81	HORIZONTAL
GFSK	2475.00	92.31	29.25	44.21	4.86	82.21	94.00	-13.13	VERTICAL
$\pi/4$ -DQPSK	2407.00	95.90	29.13	44.18	4.59	85.44	94.00	-8.56	HORIZONTAL
$\pi/4$ -DQPSK	2407.00	91.72	29.13	44.18	4.59	81.26	94.00	-12.74	VERTICAL
$\pi/4$ -DQPSK	2441.00	96.07	29.19	44.20	4.72	85.78	94.00	-8.22	HORIZONTAL
$\pi/4$ -DQPSK	2441.00	91.02	29.19	44.20	4.72	80.73	94.00	-13.27	VERTICAL
$\pi/4$ -DQPSK	2475.00	96.25	29.25	44.21	4.86	86.15	94.00	-7.85	HORIZONTAL
$\pi/4$ -DQPSK	2475.00	89.97	29.26	44.21	4.86	79.88	94.00	-14.12	VERTICAL
8DPSK	2407.00	95.61	29.13	44.18	4.59	85.15	94.00	-8.85	HORIZONTAL
8DPSK	2407.00	91.08	29.13	44.18	4.59	80.62	94.00	-13.38	VERTICAL
8DPSK	2441.00	96.35	29.19	44.20	4.72	86.06	94.00	-7.94	HORIZONTAL
8DPSK	2441.00	90.80	29.19	44.20	4.72	80.51	94.00	-13.49	VERTICAL
8DPSK	2475.00	95.20	29.25	44.21	4.86	85.10	94.00	-8.90	HORIZONTAL
8DPSK	2475.00	90.16	29.25	44.21	4.86	80.06	94.00	-13.94	VERTICAL

Result: Pass

Note: Result Level = Read Level + Antenna Factor + Cable loss - PRM Factor.

Radiated Emission test (below 1GHz)

TR-4-E-009 Radiated Emission Test Result

Test Site : DDT 3m Chamber 1#
Test Date : 2019-01-14
EUT : PORTABLE BLUETOOTH SPEAKER
Power Supply : Battery
Condition : Temp:24.5°C,Humi:55%,Press:100.1kPa
Memo : Original battery (Factory 1)

D:\2018 RE1# Report Data\Q18112311-1E FLIP5\FCC BELOW1G.EM6
Tested By : Talent
Model Number : FLIP5
Test Mode : Tx mode
Antenna/Distance : 2018 VULB 9163 1#/3m/HORIZONTAL

Data: 5

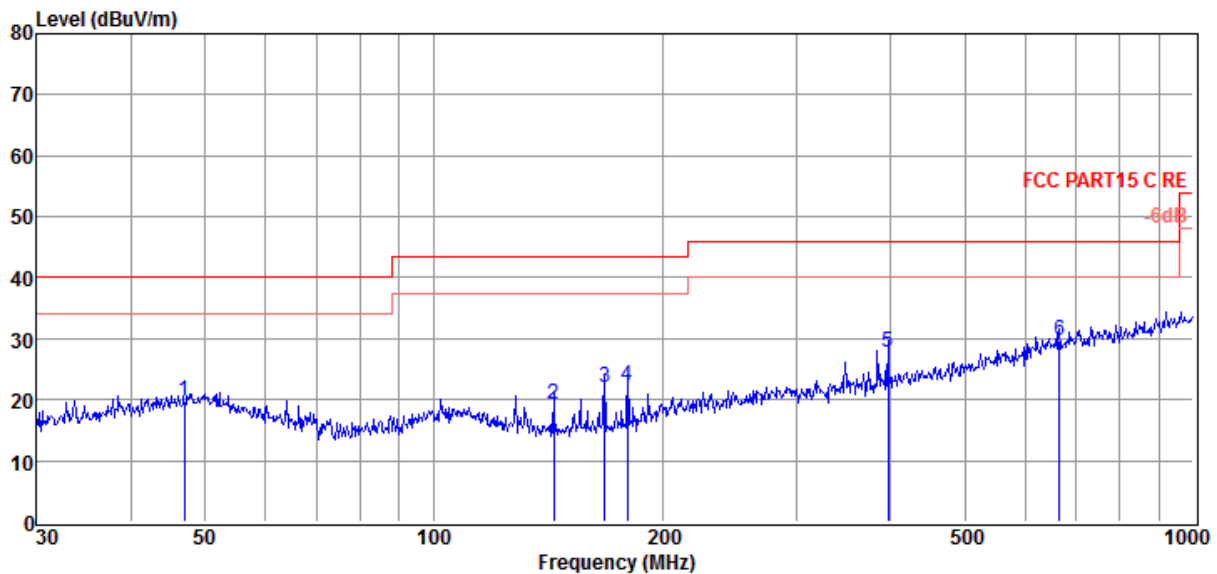

Item (Mark)	Freq. (MHz)	Read Level (dBμV)	Antenna Factor (dB/m)	Cable Loss (dB)	Result Level (dBμV/m)	Limit Line (dBμV/m)	Over Limit (dB)	Detector	Polarization
1	47.00	1.62	14.27	3.84	19.73	40.00	-20.27	QP	HORIZONTAL
2	143.83	6.20	8.58	4.47	19.25	43.50	-24.25	QP	HORIZONTAL
3	167.82	8.45	8.88	4.65	21.98	43.50	-21.52	QP	HORIZONTAL
4	180.02	7.81	9.70	4.73	22.24	43.50	-21.26	QP	HORIZONTAL
5	396.24	6.60	15.55	5.50	27.65	46.00	-18.35	QP	HORIZONTAL
6	665.80	3.72	19.58	6.28	29.58	46.00	-16.42	QP	HORIZONTAL

Note: 1. Result Level = Read Level + Antenna Factor + Cable loss.

2. If Peak Result complies with QP limit, QP Result is deemed to comply with QP limit.

3. Test setup: RBW: 120 kHz, VBW: 300 kHz, Sweep time: auto.

TR-4-E-009 Radiated Emission Test Result

Test Site : DDT 3m Chamber 1#
Test Date : 2019-01-14
EUT : PORTABLE BLUETOOTH SPEAKER
Power Supply : Battery
Condition : Temp:24.5°C,Humi:55%,Press:100.1kPa
Memo : Original battery (Factory 1)

D:\2018 RE1# Report Data\Q18112311-1E FLIP5\FCC BELOW1G.EM6
Tested By : Talent
Model Number : FLIP5
Test Mode : Tx mode
Antenna/Distance : 2018 VULB 9163 1#/3m/VERTICAL

Data: 6

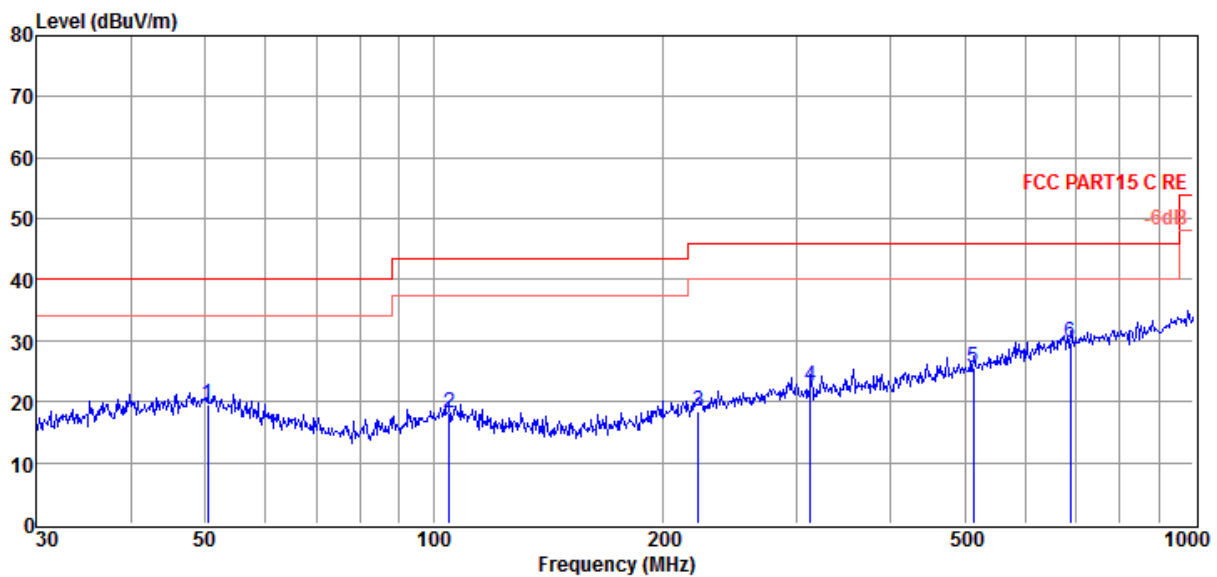

Item (Mark)	Freq. (MHz)	Read Level (dB μ V)	Antenna Factor (dB/m)	Cable Loss (dB)	Result Level (dB μ V/m)	Limit Line (dB μ V/m)	Over Limit (dB)	Detector	Polarization
1	50.41	1.14	14.46	3.87	19.47	40.00	-20.53	QP	VERTICAL
2	104.90	2.11	11.75	4.23	18.09	43.50	-25.41	QP	VERTICAL
3	222.95	1.43	12.10	4.90	18.43	46.00	-27.57	QP	VERTICAL
4	313.28	3.00	14.24	5.23	22.47	46.00	-23.53	QP	VERTICAL
5	513.63	2.44	17.31	5.86	25.61	46.00	-20.39	QP	VERTICAL
6	689.56	3.34	19.94	6.35	29.63	46.00	-16.37	QP	VERTICAL

Note: 1. Result Level = Read Level + Antenna Factor + Cable loss.

2. If Peak Result complies with QP limit, QP Result is deemed to comply with QP limit.

3. Test setup: RBW: 120 kHz, VBW: 300 kHz, Sweep time: auto.

TR-4-E-009 Radiated Emission Test Result

Test Site : DDT 3m Chamber 1#
Test Date : 2019-02-15
EUT : PORTABLE BLUETOOTH SPEAKER
Power Supply : Battery
Condition : Temp:24.5°C,Humi:55%,Press:100.1kPa
Memo : Original battery (Factory 2)

D:\2018 RE1# Report Data\Q18112311-1E FLIP5\FCC BELOW1G.EM6
Tested By : Talent
Model Number : FLIP5
Test Mode : Tx mode
Antenna/Distance : 2018 VULB 9163 1#/3m/VERTICAL

Data: 11

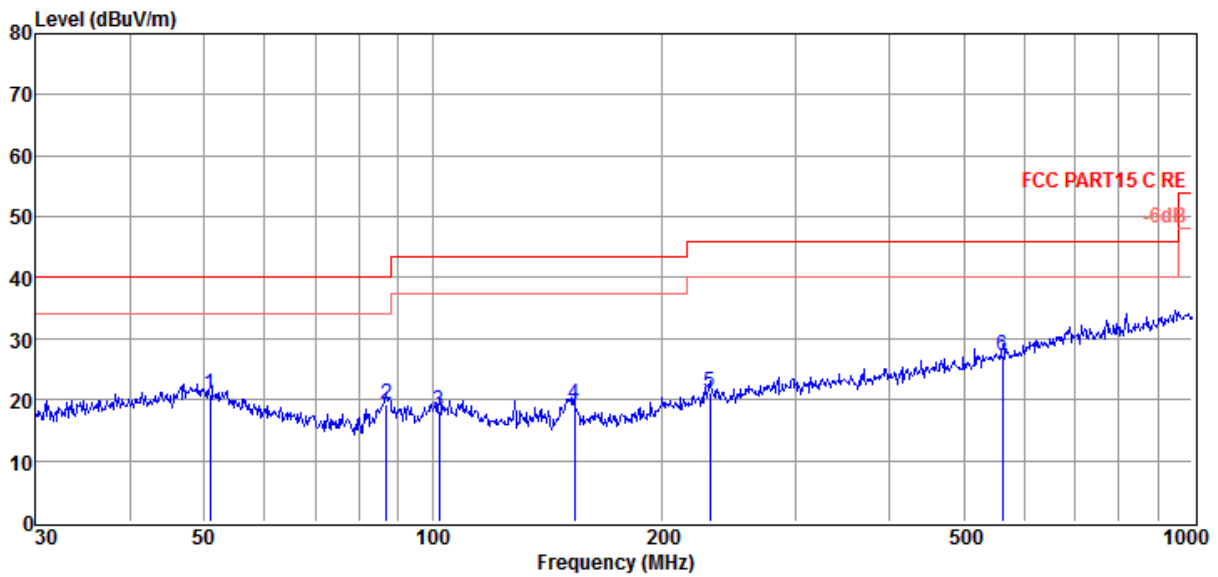

Item (Mark)	Freq. (MHz)	Read Level (dBμV)	Antenna Factor (dB/m)	Cable Loss (dB)	Result Level (dBμV/m)	Limit Line (dBμV/m)	Over Limit (dB)	Detector	Polarization
1	50.94	2.71	14.27	3.88	20.86	40.00	-19.14	QP	VERTICAL
2	86.81	5.45	9.66	4.13	19.24	40.00	-20.76	QP	VERTICAL
3	102.00	2.11	11.72	4.22	18.05	43.50	-25.45	QP	VERTICAL
4	153.74	6.02	8.55	4.55	19.12	43.50	-24.38	QP	VERTICAL
5	231.72	3.84	12.34	4.93	21.11	46.00	-24.89	QP	VERTICAL
6	562.66	3.26	18.01	5.99	27.26	46.00	-18.74	QP	VERTICAL

Note: 1. Result Level = Read Level + Antenna Factor + Cable loss.
 2. If Peak Result complies with QP limit, QP Result is deemed to comply with QP limit.
 3. Test setup: RBW: 120 kHz, VBW: 300 kHz, Sweep time: auto.

TR-4-E-009 Radiated Emission Test Result

Test Site : DDT 3m Chamber 1# D:\2018 RE1# Report Data\Q18112311-1E FLIP5\FCC BELOW1G.EM6
Test Date : 2019-02-15 **Tested By** : Talent
EUT : PORTABLE BLUETOOTH SPEAKER **Model Number** : FLIP5
Power Supply : Battery **Test Mode** : Tx mode
Condition : Temp:24.5°C,Humi:55%,Press:100.1kPa **Antenna/Distance** : 2018 VULB 9163 1#/3m/HORIZONTAL
Memo : Original battery (Factory 2)

Data: 12

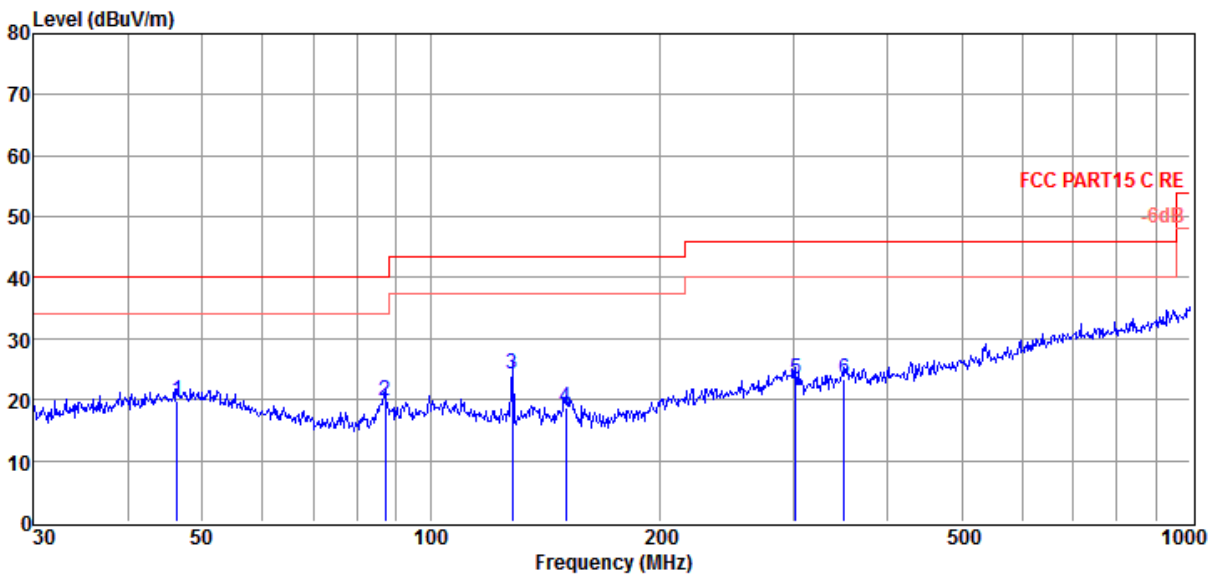

Item (Mark)	Freq. (MHz)	Read Level (dBμV)	Antenna Factor (dB/m)	Cable Loss (dB)	Result Level (dBμV/m)	Limit Line (dBμV/m)	Over Limit (dB)	Detector	Polarization
1	46.34	1.79	14.19	3.84	19.82	40.00	-20.18	QP	HORIZONTAL
2	87.11	5.91	9.70	4.13	19.74	40.00	-20.26	QP	HORIZONTAL
3	128.11	10.27	9.54	4.34	24.15	43.50	-19.35	QP	HORIZONTAL
4	150.54	5.78	8.42	4.52	18.72	43.50	-24.78	QP	HORIZONTAL
5	302.48	4.09	14.05	5.19	23.33	46.00	-22.67	QP	HORIZONTAL
6	350.48	3.10	14.86	5.35	23.31	46.00	-22.69	QP	HORIZONTAL

Note: 1. Result Level = Read Level + Antenna Factor + Cable loss.
 2. If Peak Result complies with QP limit, QP Result is deemed to comply with QP limit.
 3. Test setup: RBW: 120 kHz, VBW: 300 kHz, Sweep time: auto

TR-4-E-009 Radiated Emission Test Result

Test Site : DDT 3m Chamber 1#
Test Date : 2019-02-19
EUT : PORTABLE BLUETOOTH SPEAKER
Power Supply : Battery
Condition : Temp:24.5°C,Humi:55%,Press:100.1kPa
Memo : Original battery (Factory 3)

D:\2018 RE1# Report Data\Q18112311-5E FLIP5\FCC BELOW1G.EM6
Tested By : Talent
Model Number : FLIP5
Test Mode : Tx mode
Antenna/Distance : 2018 VULB 9163 1#/3m/HORIZONTAL

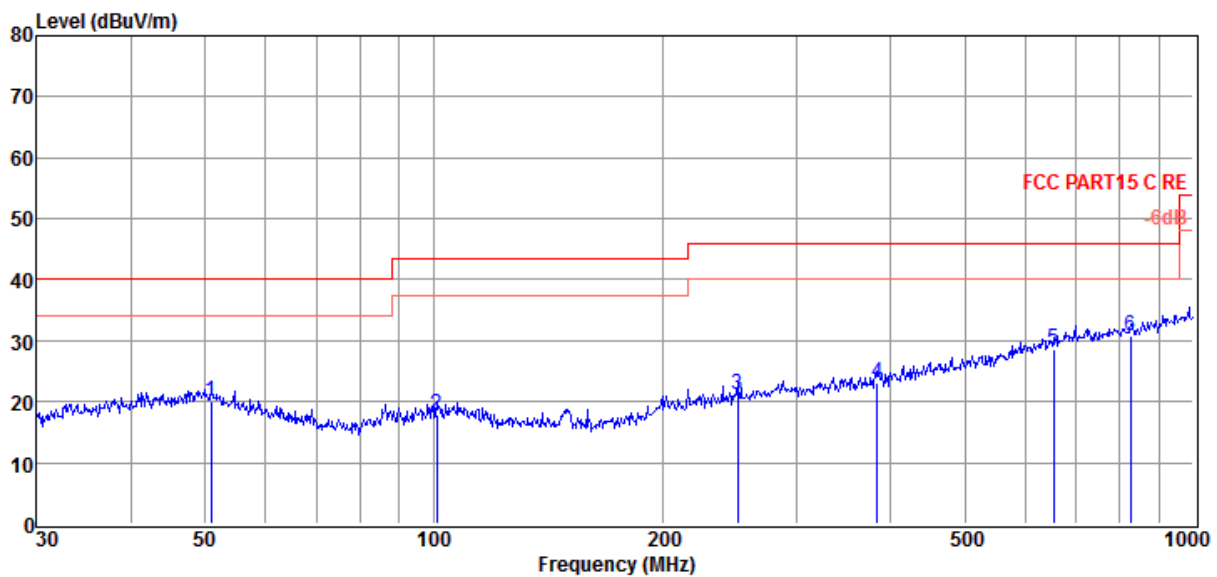

Item (Mark)	Freq. (MHz)	Read Level (dB μ V)	Antenna Factor (dB/m)	Cable Loss (dB)	Result Level (dB μ V/m)	Limit Line (dB μ V/m)	Over Limit (dB)	Detector	Polarization
1	50.94	1.99	14.27	3.88	20.14	40.00	-19.86	QP	HORIZONTAL
2	100.93	2.03	11.71	4.21	17.95	43.50	-25.55	QP	HORIZONTAL
3	251.18	3.24	12.86	5.01	21.11	46.00	-24.89	QP	HORIZONTAL
4	383.93	2.29	15.37	5.45	23.11	46.00	-22.89	QP	HORIZONTAL
5	654.23	2.96	19.40	6.25	28.61	46.00	-17.39	QP	HORIZONTAL
6	827.49	3.17	20.99	6.66	30.82	46.00	-15.18	QP	HORIZONTAL

Note: 1. Result Level = Read Level + Antenna Factor + Cable loss.

2. If Peak Result complies with QP limit, QP Result is deemed to comply with QP limit.

3. Test setup: RBW: 120 kHz, VBW: 300 kHz, Sweep time: auto.

TR-4-E-009 Radiated Emission Test Result

Test Site : DDT 3m Chamber 1#
Test Date : 2019-02-19
EUT : PORTABLE BLUETOOTH SPEAKER
Power Supply : Battery
Condition : Temp:24.5°C,Humi:55%,Press:100.1kPa
Memo : Original battery (Factory 3)

D:\2018 RE1# Report Data\Q18112311-5E FLIP5\FCC BELOW1G.EM6
Tested By : Talent
Model Number : FLIP5
Test Mode : Tx mode
Antenna/Distance : 2018 VULB 9163 1#/3m/VERTICAL

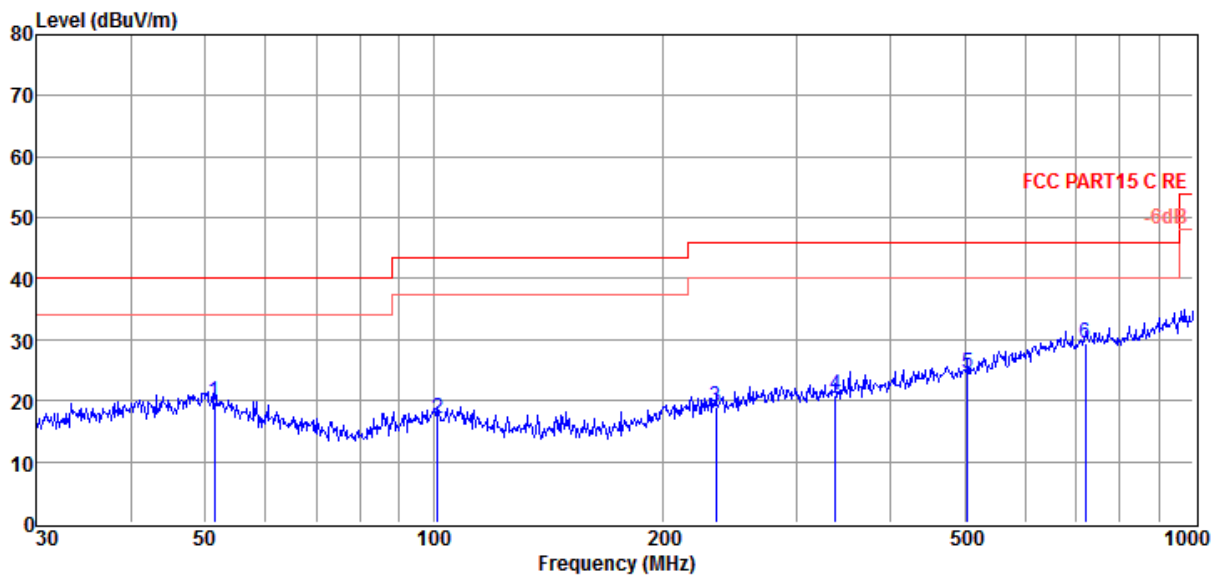

Item (Mark)	Freq. (MHz)	Read Level (dB μ V)	Antenna Factor (dB/m)	Cable Loss (dB)	Result Level (dB μ V/m)	Limit Line (dB μ V/m)	Over Limit (dB)	Detector	Polarization
1	51.48	1.71	14.09	3.88	19.68	40.00	-20.32	QP	VERTICAL
2	101.29	1.14	11.71	4.21	17.06	43.50	-26.44	QP	VERTICAL
3	234.99	1.63	12.43	4.94	19.00	46.00	-27.00	QP	VERTICAL
4	338.40	0.94	14.67	5.32	20.93	46.00	-25.07	QP	VERTICAL
5	504.71	1.56	17.17	5.84	24.57	46.00	-21.43	QP	VERTICAL
6	721.73	2.73	20.24	6.44	29.41	46.00	-16.59	QP	VERTICAL

Note: 1. Result Level = Read Level + Antenna Factor + Cable loss.

2. If Peak Result complies with QP limit, QP Result is deemed to comply with QP limit.

3. Test setup: RBW: 120 kHz, VBW: 300 kHz, Sweep time: auto.

TR-4-E-009 Radiated Emission Test Result

Test Site : DDT 3m Chamber 1#
Test Date : 2019-03-21
EUT : PORTABLE BLUETOOTH SPEAKER
Power Supply : Battery
Condition : Temp:24.5°C,Humi:55%,Press:100.1kPa
Memo : New battery model
D:\2018 RE1# Report Data\Q18112311-10E FLIP5\FCC BELOW1G.EM6
Tested By : Talent
Model Number : FLIP5
Test Mode : Tx mode
Antenna/Distance : 2018 VULB 9163 1#/3m/VERTICAL

Data: 19

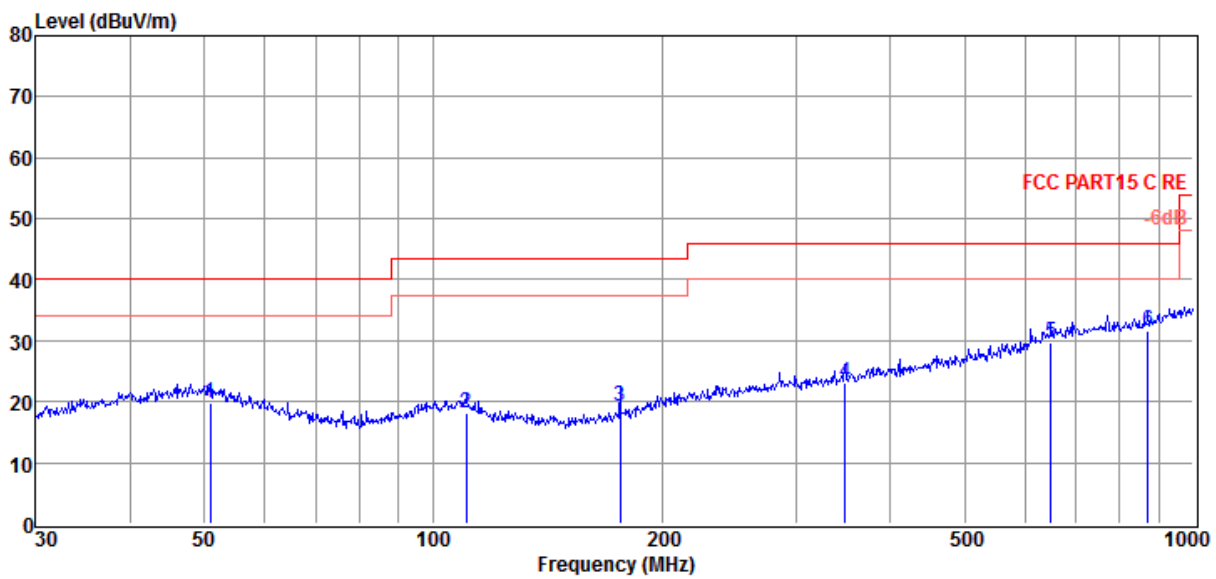

Item (Mark)	Freq. (MHz)	Read Level (dBμV)	Antenna Factor (dB/m)	Cable Loss (dB)	Result Level (dBμV/m)	Limit Line (dBμV/m)	Over Limit (dB)	Detector	Polarization
1	50.94	1.71	14.27	3.88	19.86	40.00	-20.14	QP	VERTICAL
2	110.57	2.29	11.68	4.26	18.23	43.50	-25.27	QP	VERTICAL
3	176.27	5.24	9.41	4.71	19.36	43.50	-24.14	QP	VERTICAL
4	348.03	2.80	14.83	5.35	22.98	46.00	-23.02	QP	VERTICAL
5	649.66	4.15	19.33	6.24	29.72	46.00	-16.28	QP	VERTICAL
6	872.18	3.39	21.43	6.80	31.62	46.00	-14.38	QP	VERTICAL

- Note: 1. Result Level = Read Level + Antenna Factor + Cable loss.
 2. If Peak Result complies with QP limit, QP Result is deemed to comply with QP limit.
 3. Test setup: RBW: 120 kHz, VBW: 300 kHz, Sweep time: auto.

TR-4-E-009 Radiated Emission Test Result

Test Site : DDT 3m Chamber 1#

D:\2018 RE1# Report Data\Q18112311-1E FLIP5\FCC
BELOW1G.EM6

Test Date : 2019-03-21

Tested By : Talent

EUT : PORTABLE BLUETOOTH SPEAKER

Model Number : FLIP5

Power Supply : Battery

Test Mode : Tx mode

Condition : Temp:24.5°C,Humi:55%,Press:100.1kPa

Antenna/Distance : 2018 VULB 9163 1#/3m/HORIZONTAL

Memo : New battery model

Data: 20

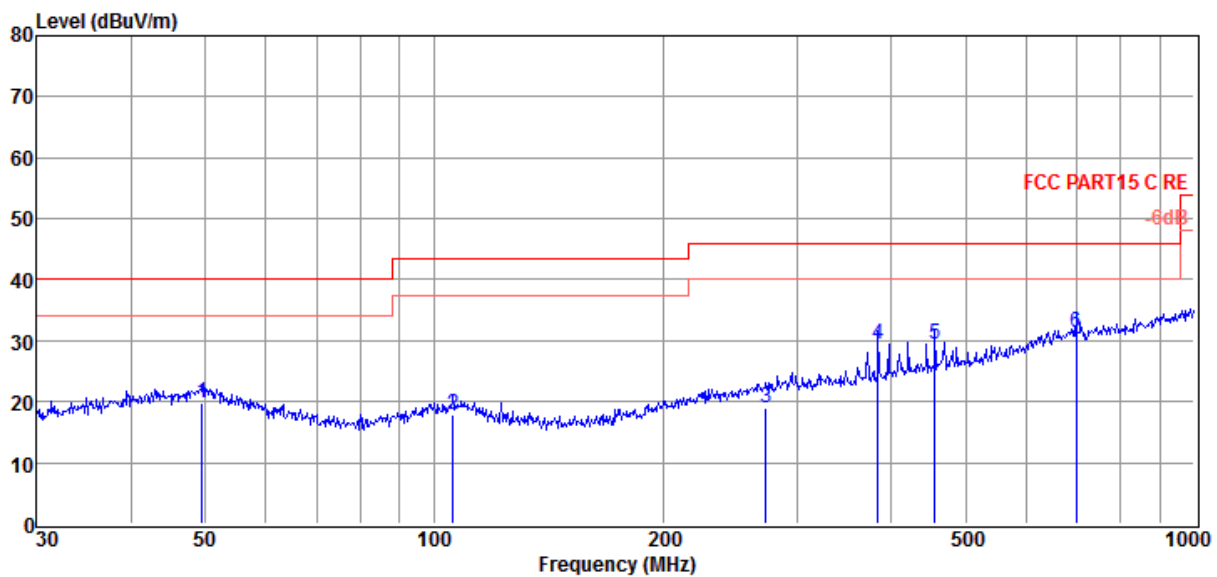

Item (Mark)	Freq. (MHz)	Read Level (dB μ V)	Antenna Factor (dB/m)	Cable Loss (dB)	Result Level (dB μ V/m)	Limit Line (dB μ V/m)	Over Limit (dB)	Detector	Polarization
1	49.53	1.50	14.55	3.86	19.91	40.00	-20.09	QP	HORIZONTAL
2	106.01	1.89	11.76	4.24	17.89	43.50	-25.61	QP	HORIZONTAL
3	273.23	0.60	13.40	5.09	19.09	46.00	-26.91	QP	HORIZONTAL
4	383.93	8.67	15.37	5.45	29.49	46.00	-16.51	QP	HORIZONTAL
5	455.91	7.33	16.48	5.69	29.50	46.00	-16.50	QP	HORIZONTAL
6	699.31	4.84	20.09	6.38	31.31	46.00	-14.69	QP	HORIZONTAL

Note: 1. Result Level = Read Level + Antenna Factor + Cable loss.

2. If Peak Result complies with QP limit, QP Result is deemed to comply with QP limit.

3. Test setup: RBW: 120 kHz, VBW: 300 kHz, Sweep time: auto.

TR-4-E-009 Radiated Emission Test Result

Test Site : DDT 3m Chamber 1# D:\2019 RE1# Report Data\Q19103116-7E TCL 三星电池\FCC BELOW 1G.EM6
Test Date : 2019-12-22 **Tested By** : Jacky
EUT : PORTABLE BLUETOOTH SPEAKER **Model Number** : FLIP5
Power Supply : Battery **Test Mode** : Tx mode
Condition : Temp:24.5'C,Humi:55%,Press:100.1kPa **Antenna/Distance** : 2019 VULB 9163 1#/3m/HORIZONTAL
Memo : IAA031NA (Factory 1)

Data: 11

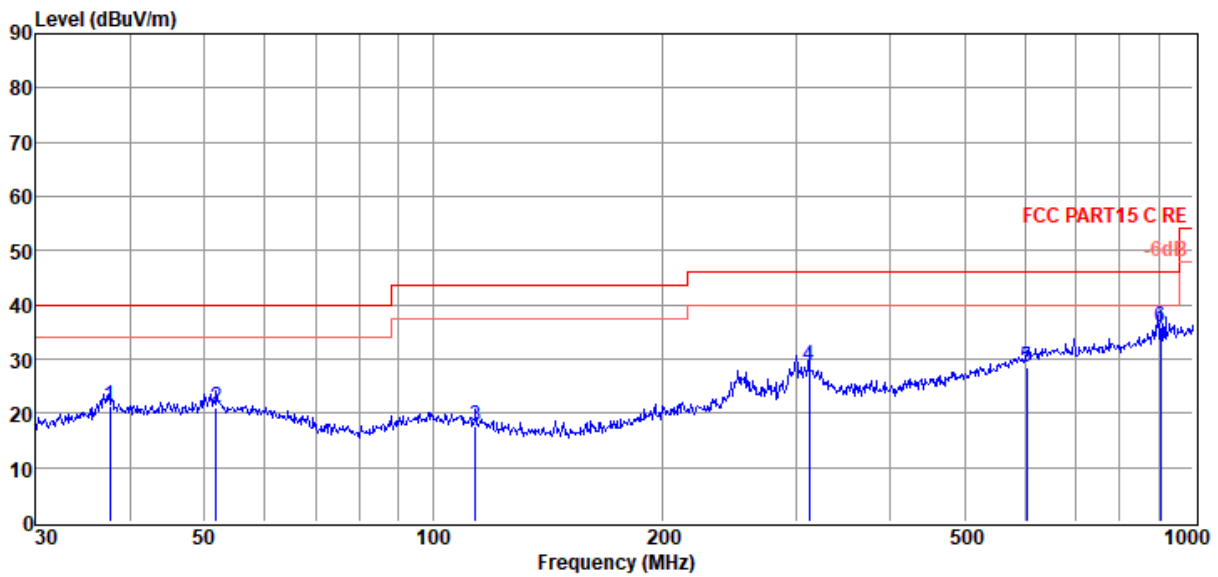

Item (Mark)	Freq. (MHz)	Read Level (dBuV)	Antenna Factor (dB/m)	Cable Loss (dB)	Result Level (dBuV/m)	Limit Line (dBuV/m)	Over Limit (dB)	Detector	Polarization
1	37.55	4.45	13.15	3.88	21.48	40.00	-18.52	QP	HORIZONTAL
2	51.84	3.13	13.96	4.01	21.10	40.00	-18.90	QP	HORIZONTAL
3	113.71	2.34	10.73	4.51	17.58	43.50	-25.92	QP	HORIZONTAL
4	312.18	9.04	14.27	5.58	28.89	46.00	-17.11	QP	HORIZONTAL
5	603.54	2.61	19.23	6.75	28.59	46.00	-17.41	QP	HORIZONTAL
6	906.48	6.27	21.87	7.71	35.85	46.00	-10.15	QP	HORIZONTAL

- Note: 1. Result Level = Read Level + Antenna Factor + Cable loss.
 2. If Peak Result complies with QP limit, QP Result is deemed to comply with QP limit.
 3. Test setup: RBW: 120 kHz, VBW: 300 kHz, Sweep time: auto.

TR-4-E-009 Radiated Emission Test Result

Test Site : DDT 3m Chamber 1#

D:\2019 RE1# Report Data\Q19103116-7E TCL 三星电池\FCC
BELOW 1G.EM6

Test Date : 2019-12-22

Tested By : Jacky

EUT : PORTABLE BLUETOOTH SPEAKER

Model Number : FLIP5

Power Supply : Battery

Test Mode : Tx mode

Condition : Temp:24.5°C,Humi:55%,Press:100.1kPa

Antenna/Distance : 2019 VULB 9163 1#/3m/VERTICAL

Memo : IAA031NA (Factory 1)

Data: 12

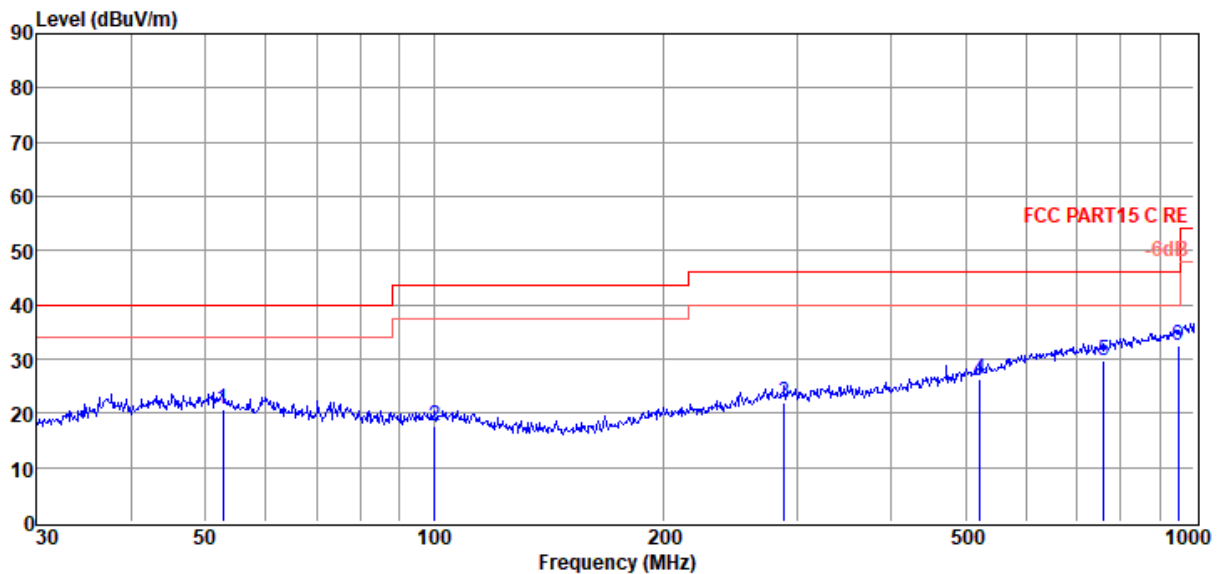

Item (Mark)	Freq. (MHz)	Read Level (dBuV)	Antenna Factor (dB/m)	Cable Loss (dB)	Result Level (dBuV/m)	Limit Line (dBuV/m)	Over Limit (dB)	Detector	Polarization
1	52.76	2.85	13.85	4.02	20.72	40.00	-19.28	QP	VERTICAL
2	100.23	1.19	11.89	4.41	17.49	43.50	-26.01	QP	VERTICAL
3	289.00	2.75	13.85	5.47	22.07	46.00	-23.93	QP	VERTICAL
4	522.72	2.31	17.69	6.44	26.44	46.00	-19.56	QP	VERTICAL
5	760.70	2.14	20.40	7.26	29.80	46.00	-16.20	QP	VERTICAL
6	952.09	2.22	22.33	7.84	32.39	46.00	-13.61	QP	VERTICAL

Note: 1. Result Level = Read Level + Antenna Factor + Cable loss.

2. If Peak Result complies with QP limit, QP Result is deemed to comply with QP limit.

3. Test setup: RBW: 120 kHz, VBW: 300 kHz, Sweep time: auto.

TR-4-E-009 Radiated Emission Test Result

Test Site : DDT 3m Chamber 1#
Test Date : 2019-12-19
EUT : PORTABLE BLUETOOTH SPEAKER
Power Supply : Battery
Condition : Temp:24.5'C,Humi:55%,Press:100.1kPa
Memo : IAA031NA (Factory 2)

Tested By : Jacky
Model Number : FLIP5
Test Mode : Tx mode
Antenna/Distance : 2018 VULB 9163 1#/3m/VERTICAL

D:\2019 RE1# Report Data\Q19103116-4E 国光 三星电池\fcc
 below 1G.EM6

Data: 1

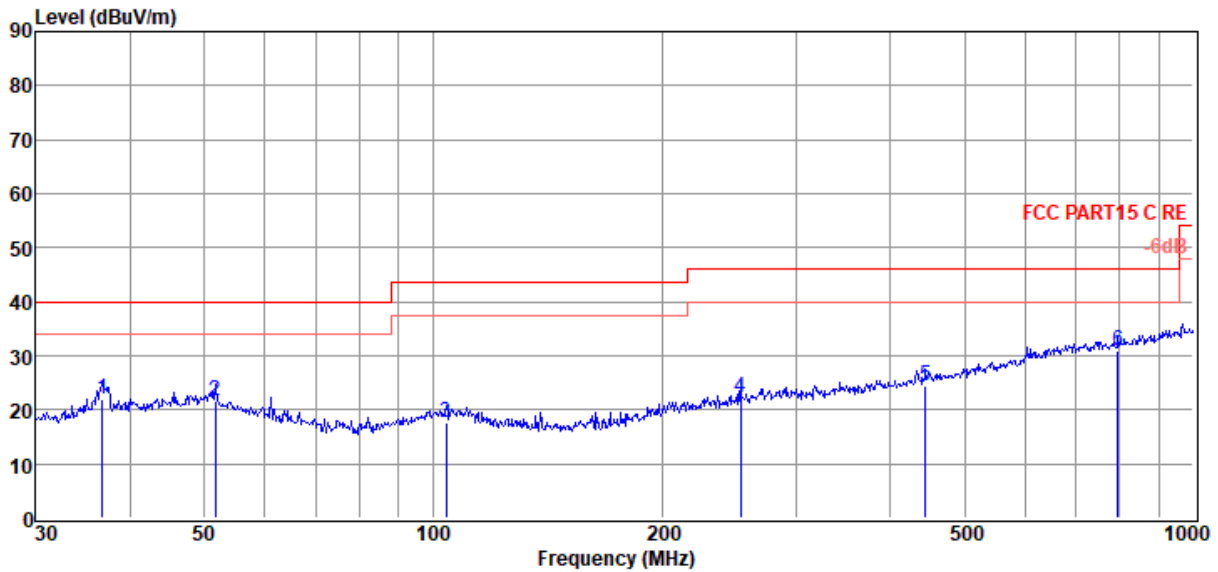

Item (Mark)	Freq. (MHz)	Read Level (dBμV)	Antenna Factor (dB/m)	Cable Loss (dB)	Result Level (dBμV/m)	Limit Line (dBμV/m)	Over Limit (dB)	Detector	Polarization
1	36.77	5.47	12.73	3.73	21.93	40.00	-18.07	QP	VERTICAL
2	51.66	3.72	14.03	3.88	21.63	40.00	-18.37	QP	VERTICAL
3	104.17	1.66	11.74	4.23	17.63	43.50	-25.87	QP	VERTICAL
4	253.84	4.27	12.93	5.02	22.22	46.00	-23.78	QP	VERTICAL
5	444.85	2.41	16.31	5.66	24.38	46.00	-21.62	QP	VERTICAL
6	796.18	3.58	20.68	6.60	30.86	46.00	-15.14	QP	VERTICAL

- Note: 1. Result Level = Read Level + Antenna Factor + Cable loss.
 2. If Peak Result complies with QP limit, QP Result is deemed to comply with QP limit.
 3. Test setup: RBW: 120 kHz, VBW: 300 kHz, Sweep time: auto.

TR-4-E-009 Radiated Emission Test Result

Test Site : DDT 3m Chamber 1#

D:\2019 RE1# Report Data\Q19103116-4E 国光 三星电池\fcc
below 1G.EM6

Test Date : 2019-12-19

Tested By : Jacky

EUT : PORTABLE BLUETOOTH SPEAKER

Model Number : FLIP5

Power Supply : Battery

Test Mode : Tx mode

Condition : Temp:24.5°C,Humi:55%,Press:100.1kPa

Antenna/Distance : 2018 VULB 9163 1#/3m/HORIZONTAL

Memo : IAA031NA (Factory 2)

Data: 2

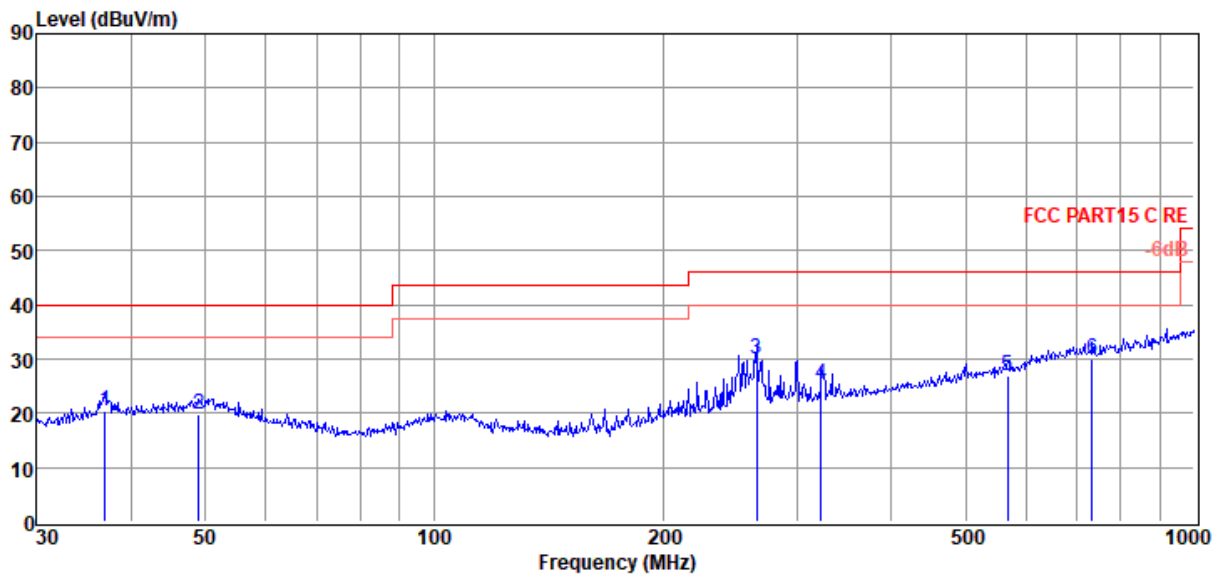

Item (Mark)	Freq. (MHz)	Read Level (dB μ V)	Antenna Factor (dB/m)	Cable Loss dB	Result Level (dB μ V/m)	Limit Line (dB μ V/m)	Over Limit (dB)	Detector	Polarization
1	36.90	3.98	12.75	3.73	20.46	40.00	-19.54	QP	HORIZONTAL
2	49.01	1.31	14.49	3.86	19.66	40.00	-20.34	QP	HORIZONTAL
3	265.68	11.59	13.22	5.06	29.87	46.00	-16.13	QP	HORIZONTAL
4	323.32	5.74	14.42	5.27	25.43	46.00	-20.57	QP	HORIZONTAL
5	568.61	2.72	18.09	6.00	26.81	46.00	-19.19	QP	HORIZONTAL
6	734.49	3.16	20.32	6.47	29.95	46.00	-16.05	QP	HORIZONTAL

Note: 1. Result Level = Read Level + Antenna Factor + Cable loss.

2. If Peak Result complies with QP limit, QP Result is deemed to comply with QP limit.

3. Test setup: RBW: 120 kHz, VBW: 300 kHz, Sweep time: auto.

TR-4-E-009 Radiated Emission Test Result

Test Site : DDT 3m Chamber 1# **D:\2019 RE1# Report Data\Q19103116-1E\fcc below 1G.EM6**
Test Date : 2019-12-19 **Tested By** : Jacky
EUT : PORTABLE BLUETOOTH SPEAKER **Model Number** : FLIP5
Power Supply : Battery **Test Mode** : TX mode
Condition : Temp:24.5°C,Humi:55%,Press:100.1kPa **Antenna/Distance** : 2018 VULB 9163 1#/3m/VERTICAL
Memo : SUN-INTE-276 (Factory 3)

Data: 5

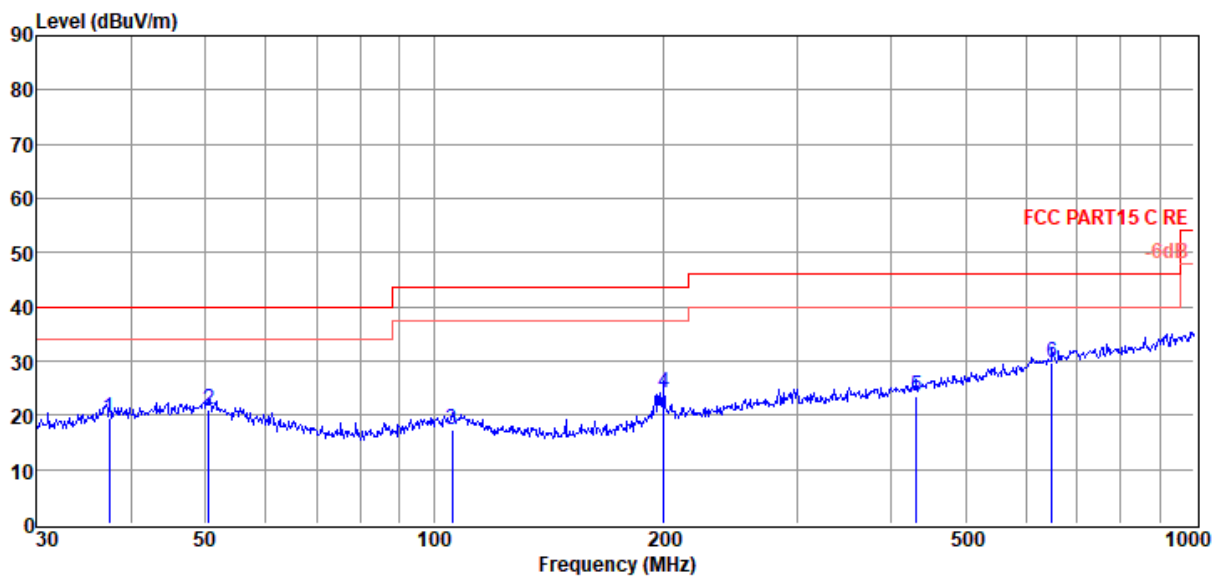

Item (Mark)	Freq. (MHz)	Read Level (dBμV)	Antenna Factor (dB/m)	Cable Loss (dB)	Result Level (dBμV/m)	Limit Line (dBμV/m)	Over Limit (dB)	Detector	Polarization
1	37.42	2.97	12.87	3.74	19.58	40.00	-20.42	QP	VERTICAL
2	50.59	2.68	14.40	3.87	20.95	40.00	-19.05	QP	VERTICAL
3	105.64	1.40	11.76	4.23	17.39	43.50	-26.11	QP	VERTICAL
4	200.69	8.04	11.42	4.81	24.27	43.50	-19.23	QP	VERTICAL
5	431.03	1.90	16.10	5.61	23.61	46.00	-22.39	QP	VERTICAL
6	649.66	4.01	19.33	6.24	29.58	46.00	-16.42	QP	VERTICAL

Note: 1. Result Level = Read Level + Antenna Factor + Cable loss.

2. If Peak Result complies with QP limit, QP Result is deemed to comply with QP limit.

3. Test setup: RBW: 120 kHz, VBW: 300 kHz, Sweep time: auto.

TR-4-E-009 Radiated Emission Test Result

Test Site : DDT 3m Chamber 1# **D:\2019 RE1# Report Data\Q19103116-1E\fcc below 1G.EM6**
Test Date : 2019-12-19 **Tested By** : Jacky
EUT : PORTABLE BLUETOOTH SPEAKER **Model Number** : FLIP5
Power Supply : Battery **Test Mode** : TX mode
Condition : Temp:24.5°C,Humi:55%,Press:100.1kPa **Antenna/Distance** : 2018 VULB 9163 1#/3m/HORIZONTAL
Memo : SUN-INTE-276 (Factory 3)

Data: 6

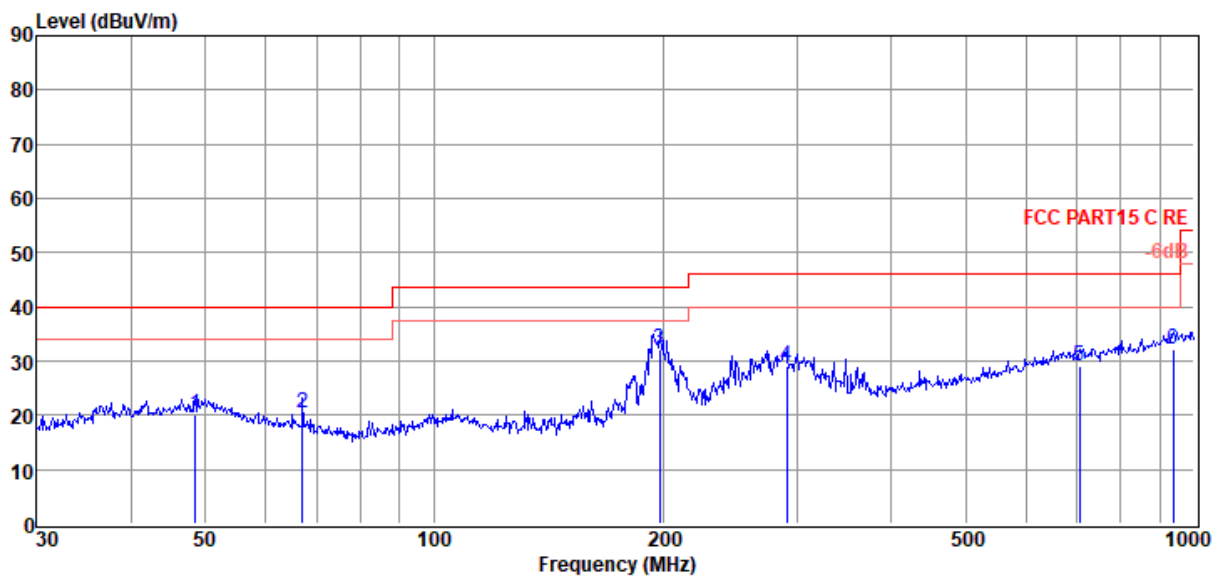

Item (Mark)	Freq. (MHz)	Read Level (dBμV)	Antenna Factor (dB/m)	Cable Loss (dB)	Result Level (dBμV/m)	Limit Line (dBμV/m)	Over Limit (dB)	Detector	Polarization
1	48.50	1.72	14.44	3.86	20.02	40.00	-19.98	QP	HORIZONTAL
2	67.20	6.33	10.00	4.00	20.33	40.00	-19.67	QP	HORIZONTAL
3	197.89	16.24	11.11	4.80	32.15	43.50	-11.35	QP	HORIZONTAL
4	291.04	10.03	13.81	5.15	28.99	46.00	-17.01	QP	HORIZONTAL
5	706.70	2.63	20.14	6.40	29.17	46.00	-16.83	QP	HORIZONTAL
6	938.83	3.11	22.14	7.06	32.31	46.00	-13.69	QP	HORIZONTAL

Note: 1. Result Level = Read Level + Antenna Factor + Cable loss.

2. If Peak Result complies with QP limit, QP Result is deemed to comply with QP limit.

3. Test setup: RBW: 120 kHz, VBW: 300 kHz, Sweep time: auto.

TR-4-E-009 Radiated Emission Test Result

Test Site : DDT 3m Chamber 1#
Test Date : 2019-12-01
EUT : Bluetooth speaker
Power Supply : Battery
Condition : Temp:24.5°C,Humi:55%,Press:101.4kPa
Memo : GSP-1S2P-F5A (Factory 3)

D:\2019 RE1# Report Data\Q19102812-1E FLIP5\FCC BELOW 1G.EM6
Tested By : Jacky
Model Number : FLIP5
Test Mode : Tx mode
Antenna/Distance : 2018 VULB 9161/3m/VERTICAL

Data: 5

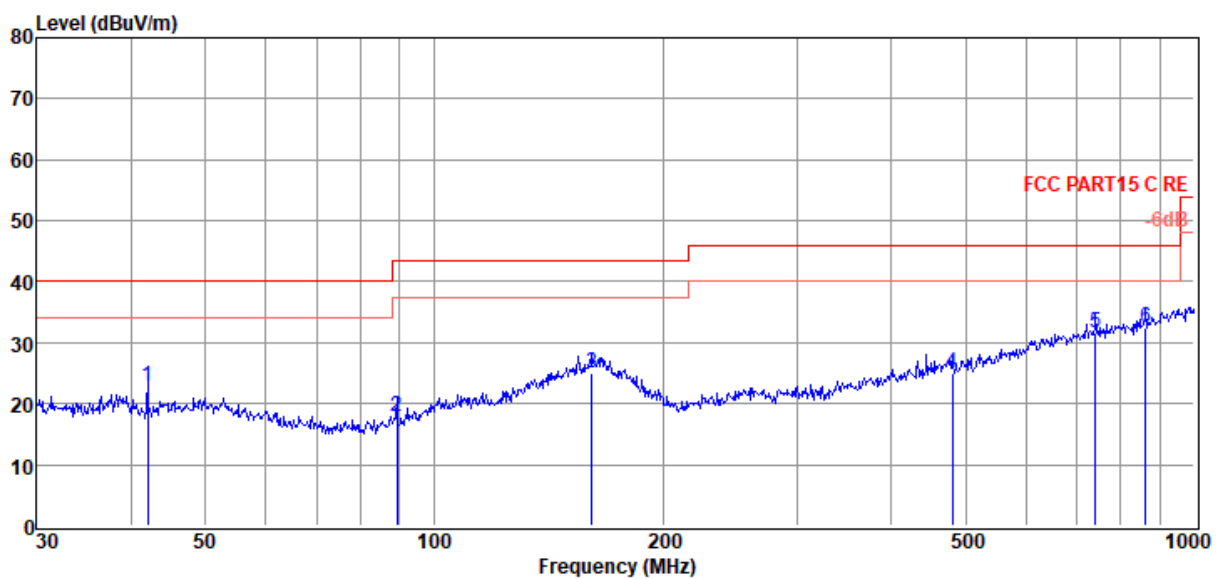

Item (Mark)	Freq. (MHz)	Read Level (dBμV)	Antenna Factor (dB/m)	Cable Loss (dB)	Result Level (dBμV/m)	Limit Line (dBμV/m)	Over Limit (dB)	Detector	Polarization
1	42.01	7.13	12.00	3.79	22.92	40.00	-17.08	QP	VERTICAL
2	89.28	3.89	9.92	4.14	17.95	43.50	-25.55	QP	VERTICAL
3	161.47	1.66	18.72	4.60	24.98	43.50	-18.52	QP	VERTICAL
4	480.53	2.29	16.98	5.76	25.03	46.00	-20.97	QP	VERTICAL
5	742.26	4.29	20.91	6.49	31.69	46.00	-14.31	QP	VERTICAL
6	863.06	3.82	21.79	6.77	32.38	46.00	-13.62	QP	VERTICAL

Note: 1. Result Level = Read Level + Antenna Factor + Cable loss.

2. If Peak Result complies with QP limit, QP Result is deemed to comply with QP limit.

3. Test setup: RBW: 120 kHz, VBW: 300 kHz, Sweep time: auto.

TR-4-E-009 Radiated Emission Test Result

Test Site : DDT 3m Chamber 1#
Test Date : 2019-12-01
EUT : Bluetooth speaker
Power Supply : Battery
Condition : Temp:24.5°C,Humi:55%,Press:101.4kPa
Memo : GSP-1S2P-F5A (Factory 3)

D:\2019 RE1# Report Data\Q19102812-1E FLIP5\FCC BELOW 1G.EM6
Tested By : Jacky
Model Number : FLIP5
Test Mode : Tx mode
Antenna/Distance : 2018 VULB 9161/3m/HORIZONTAL

Data: 6

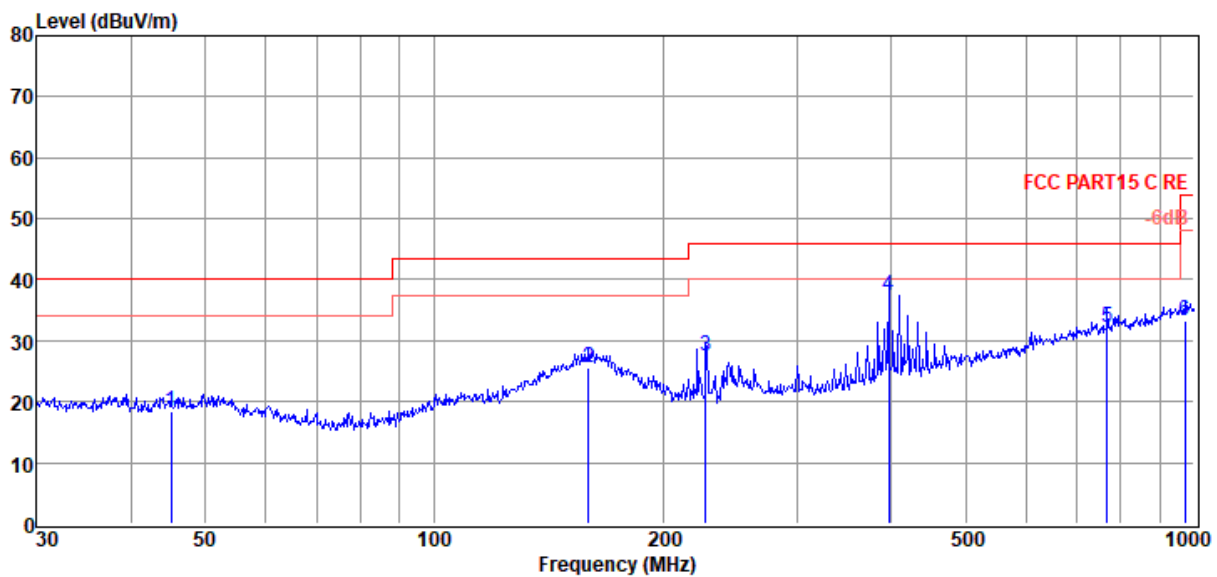

Item (Mark)	Freq. (MHz)	Read Level (dB μ V)	Antenna Factor (dB/m)	Cable Loss (dB)	Result Level (dB μ V/m)	Limit Line (dB μ V/m)	Over Limit (dB)	Detector	Polarization
1	45.06	1.84	12.63	3.82	18.29	40.00	-21.71	QP	HORIZONTAL
2	159.78	2.43	18.56	4.59	25.58	43.50	-17.92	QP	HORIZONTAL
3	227.69	10.24	12.46	4.91	27.61	46.00	-18.39	QP	HORIZONTAL
4	396.24	16.73	15.26	5.50	37.49	46.00	-8.51	QP	HORIZONTAL
5	768.75	4.82	20.76	6.54	32.12	46.00	-13.88	QP	HORIZONTAL
6	972.34	3.40	22.79	7.06	33.25	54.00	-20.75	QP	HORIZONTAL

Note: 1. Result Level = Read Level + Antenna Factor + Cable loss.

2. If Peak Result complies with QP limit, QP Result is deemed to comply with QP limit.

3. Test setup: RBW: 120 kHz, VBW: 300 kHz, Sweep time: auto.

TR-4-E-009 Radiated Emission Test Result

Test Site : DDT 3m Chamber 1#
Test Date : 2019-12-01
EUT : Bluetooth speaker
Power Supply : Battery
Condition : Temp:24.5°C,Humi:55%,Press:101.4kPa
Memo : GSP-1S2P-F5B (Factory 3)

D:\2019 RE1# Report Data\Q19102812-1E FLIP5\FCC BELOW 1G.EM6
Tested By : Jacky
Model Number : FLIP5
Test Mode : Tx mode
Antenna/Distance : 2018 VULB 9161/3m/HORIZONTAL

Data: 11

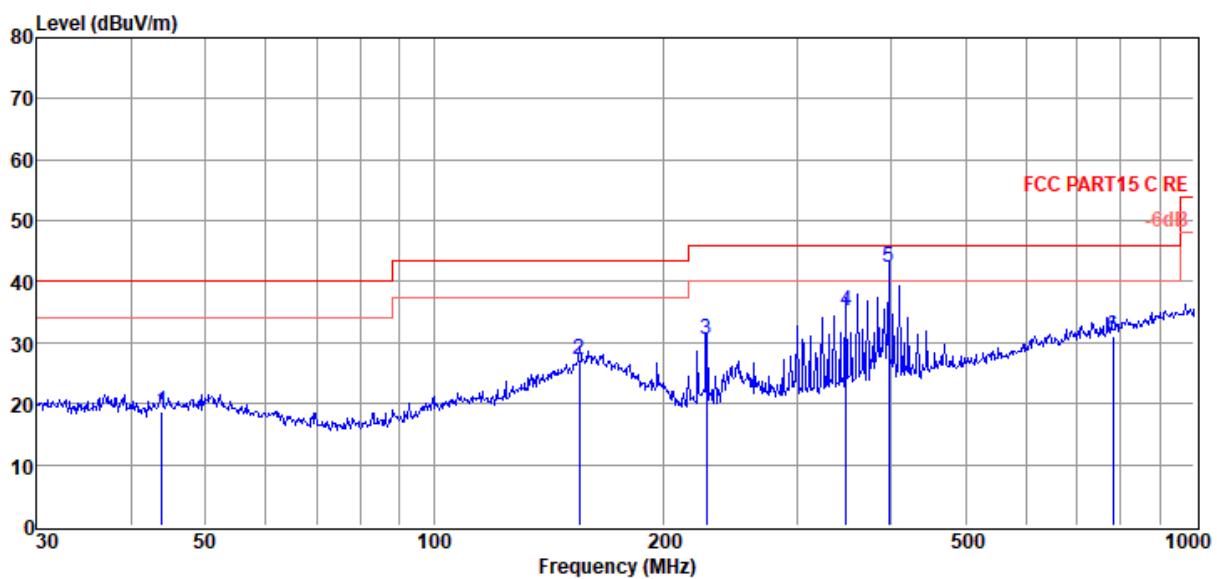

Item (Mark)	Freq. (MHz)	Read Level (dB μ V)	Antenna Factor (dB/m)	Cable Loss (dB)	Result Level (dB μ V/m)	Limit Line (dB μ V/m)	Over Limit (dB)	Detector	Polarization
1	43.81	1.99	12.82	3.81	18.62	40.00	-21.38	QP	HORIZONTAL
2	155.36	4.95	17.77	4.56	27.28	43.50	-16.22	QP	HORIZONTAL
3	228.49	13.10	12.51	4.91	30.52	46.00	-15.48	QP	HORIZONTAL
4	348.03	15.74	14.16	5.35	35.25	46.00	-10.75	QP	HORIZONTAL
5	396.24	21.67	15.26	5.50	42.43	46.00	-3.57	QP	HORIZONTAL
6	782.35	3.51	21.07	6.57	31.15	46.00	-14.85	QP	HORIZONTAL

Note: 1. Result Level = Read Level + Antenna Factor + Cable loss.

2. If Peak Result complies with QP limit, QP Result is deemed to comply with QP limit.

3. Test setup: RBW: 120 kHz, VBW: 300 kHz, Sweep time: auto.

TR-4-E-009 Radiated Emission Test Result

Test Site : DDT 3m Chamber 1#
Test Date : 2019-12-01
EUT : Bluetooth speaker
Power Supply : Battery
Condition : Temp:24.5°C,Humi:55%,Press:101.4kPa
Memo : GSP-1S2P-F5B (Factory 3)

D:\2019 RE1# Report Data\Q19102812-1E FLIP5\FCC BELOW 1G.EM6
Tested By : Jacky
Model Number : FLIP5
Test Mode : Tx mode
Antenna/Distance : 2018 VULB 9161/3m/VERTICAL

Data: 12

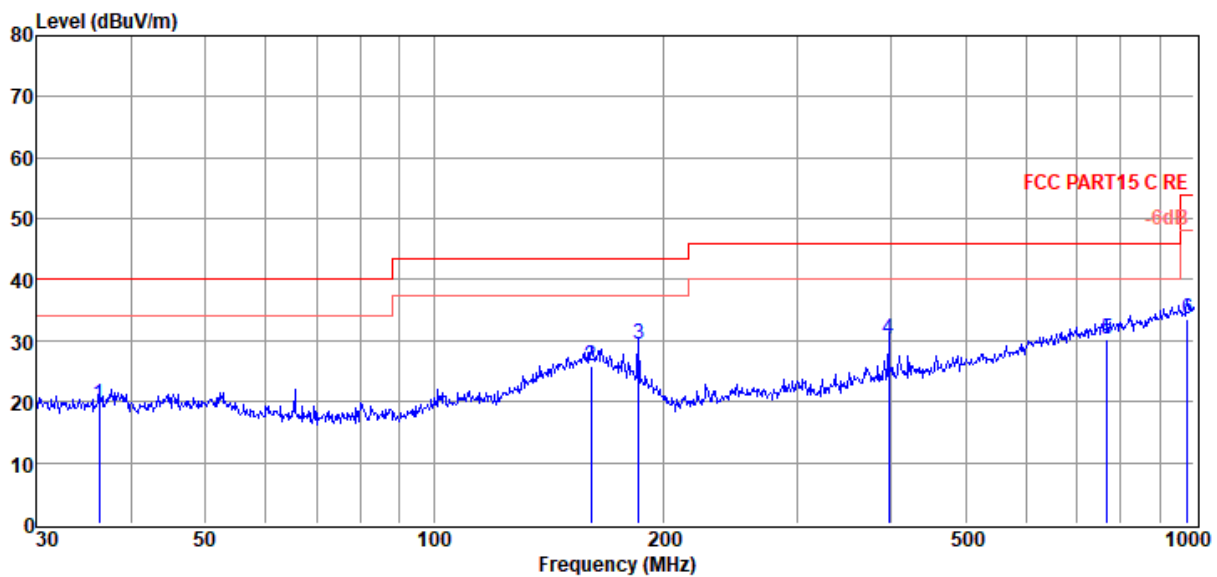

Item (Mark)	Freq. (MHz)	Read Level (dB μ V)	Antenna Factor (dB/m)	Cable Loss (dB)	Result Level (dB μ V/m)	Limit Line (dB μ V/m)	Over Limit (dB)	Detector	Polarization
1	36.25	3.18	12.66	3.72	19.56	40.00	-20.44	QP	VERTICAL
2	160.91	2.46	18.67	4.60	25.73	43.50	-17.77	QP	VERTICAL
3	185.79	9.54	15.16	4.75	29.45	43.50	-14.05	QP	VERTICAL
4	396.24	9.49	15.26	5.50	30.25	46.00	-15.75	QP	VERTICAL
5	768.75	3.01	20.76	6.54	30.31	46.00	-15.69	QP	VERTICAL
6	979.18	3.30	23.07	7.06	33.43	54.00	-20.57	QP	VERTICAL

Note: 1. Result Level = Read Level + Antenna Factor + Cable loss.

2. If Peak Result complies with QP limit, QP Result is deemed to comply with QP limit.

3. Test setup: RBW: 120 kHz, VBW: 300 kHz, Sweep time: auto.

Radiated Emission test (above 1GHz)

Factory 1:

Freq. (MHz)	Read level (dBμV)	Antenna Factor (dB/m)	PRM Factor (dB)	Cable Loss (dB)	Result Level (dBμV/m)	Limit (dBμV/m)	Margin (dB)	Detector type	Polarization
GFSK Tx mode 2407MHz									
3278.00	51.40	31.72	44.40	6.36	45.08	74.00	-28.92	Peak	HORIZONTAL
4026.00	48.83	32.94	44.39	9.00	46.38	74.00	-27.62	Peak	HORIZONTAL
4808.00	49.88	33.79	44.24	11.23	50.66	74.00	-23.34	Peak	HORIZONTAL
5437.00	49.07	34.25	44.11	10.64	49.85	74.00	-24.15	Peak	HORIZONTAL
5658.00	49.15	34.43	44.06	11.19	50.71	74.00	-23.29	Peak	HORIZONTAL
6185.00	48.75	34.93	43.90	12.14	51.92	74.00	-22.08	Peak	HORIZONTAL
3210.00	49.61	31.60	44.40	6.31	43.12	74.00	-30.88	Peak	VERTICAL
3737.00	49.85	32.49	44.40	7.68	45.62	74.00	-28.38	Peak	VERTICAL
4808.00	52.06	33.79	44.24	11.23	52.84	74.00	-21.16	Peak	VERTICAL
5471.00	48.92	34.28	44.10	10.79	49.89	74.00	-24.11	Peak	VERTICAL
5981.00	49.19	34.69	44.00	11.38	51.26	74.00	-22.74	Peak	VERTICAL
6593.00	48.34	35.36	43.71	12.04	52.03	74.00	-21.97	Peak	VERTICAL
GFSK Tx mode 2441MHz									
3227.00	49.28	31.63	44.40	6.32	42.83	74.00	-31.17	Peak	HORIZONTAL
3907.00	49.44	32.76	44.40	8.31	46.11	74.00	-27.89	Peak	HORIZONTAL
4587.00	49.39	33.65	44.28	9.80	48.56	74.00	-25.44	Peak	HORIZONTAL
5488.00	47.84	34.29	44.10	10.86	48.89	74.00	-25.11	Peak	HORIZONTAL
6236.00	48.57	34.99	43.88	12.12	51.80	74.00	-22.20	Peak	HORIZONTAL
6763.00	47.57	35.46	43.63	12.25	51.65	74.00	-22.35	Peak	HORIZONTAL
3210.00	49.45	31.60	44.40	6.31	42.96	74.00	-31.04	Peak	VERTICAL
3567.00	49.50	32.21	44.40	7.22	44.53	74.00	-29.47	Peak	VERTICAL
4111.00	48.34	33.06	44.38	9.28	46.30	74.00	-27.70	Peak	VERTICAL
4808.00	48.92	33.79	44.24	11.23	49.70	74.00	-24.30	Peak	VERTICAL
6049.00	47.84	34.76	43.97	11.32	49.95	74.00	-24.05	Peak	VERTICAL
6389.00	48.05	35.17	43.80	12.04	51.46	74.00	-22.54	Peak	VERTICAL
GFSK Tx mode 2475MHz									
3414.00	49.30	31.95	44.40	6.81	43.66	74.00	-30.34	Peak	HORIZONTAL
3907.00	49.41	32.76	44.40	8.31	46.08	74.00	-27.92	Peak	HORIZONTAL
4621.00	47.92	33.68	44.27	9.82	47.15	74.00	-26.85	Peak	HORIZONTAL
5352.00	49.40	34.19	44.13	10.48	49.94	74.00	-24.06	Peak	HORIZONTAL
6015.00	48.03	34.72	43.99	11.35	50.11	74.00	-23.89	Peak	HORIZONTAL
7154.00	46.98	35.69	43.45	12.73	51.95	74.00	-22.05	Peak	HORIZONTAL
3499.00	49.64	32.10	44.40	7.04	44.38	74.00	-29.62	Peak	VERTICAL
4468.00	47.42	33.56	44.30	9.93	46.61	74.00	-27.39	Peak	VERTICAL
4774.00	47.79	33.77	44.24	11.01	48.33	74.00	-25.67	Peak	VERTICAL
5556.00	47.60	34.35	44.08	11.06	48.93	74.00	-25.07	Peak	VERTICAL
5947.00	48.50	34.66	44.01	11.39	50.54	74.00	-23.46	Peak	VERTICAL
6712.00	47.94	35.43	43.65	12.10	51.82	74.00	-22.18	Peak	VERTICAL
Result: Pass									

Factory 2:

Freq. (MHz)	Read level (dBμV)	Antenna Factor (dB/m)	PRM Factor (dB)	Cable Loss (dB)	Result Level (dBμV/m)	Limit (dBμV/m)	Margin (dB)	Detector type	Polarization
GFSK Tx mode 2407MHz									
3618.00	48.92	32.30	44.40	7.33	44.15	74.00	-29.85	Peak	HORIZONTAL
4791.00	47.29	33.78	44.24	11.23	48.06	74.00	-25.94	Peak	HORIZONTAL
6032.00	47.19	34.74	43.98	11.33	49.28	74.00	-24.72	Peak	HORIZONTAL
6406.00	49.16	35.19	43.80	12.06	52.61	74.00	-21.39	Peak	HORIZONTAL
7868.00	46.89	36.20	43.15	13.70	53.64	74.00	-20.36	Peak	HORIZONTAL
9296.00	41.65	36.98	43.77	14.62	49.48	54.00	-4.52	Average	HORIZONTAL
9296.00	46.65	36.98	43.77	14.62	54.48	74.00	-19.52	Peak	HORIZONTAL
3448.00	49.61	32.01	44.40	6.90	44.12	74.00	-29.88	Peak	VERTICAL
4723.00	47.46	33.74	44.25	10.35	47.30	74.00	-26.70	Peak	VERTICAL
6219.00	47.11	34.97	43.89	12.20	50.39	74.00	-23.61	Peak	VERTICAL
7477.00	42.31	35.89	43.31	13.14	48.03	54.00	-5.97	Average	VERTICAL
7477.00	48.31	35.89	43.31	13.14	54.03	74.00	-19.97	Peak	VERTICAL
7834.00	43.23	36.17	43.17	13.61	49.84	54.00	-4.16	Average	VERTICAL
7834.00	48.23	36.17	43.17	13.61	54.84	74.00	-19.16	Peak	VERTICAL
9245.00	42.25	36.95	43.75	14.75	50.20	54.00	-3.80	Average	VERTICAL
9245.00	47.25	36.95	43.75	14.75	55.20	74.00	-18.80	Peak	VERTICAL
GFSK Tx mode 2441MHz									
3567.00	49.11	32.21	44.40	7.22	44.14	74.00	-29.86	Peak	HORIZONTAL
4791.00	47.46	33.78	44.24	11.23	48.23	74.00	-25.77	Peak	HORIZONTAL
6168.00	47.16	34.91	43.91	11.97	50.13	74.00	-23.87	Peak	HORIZONTAL
7324.00	48.36	35.80	43.38	12.78	53.56	74.00	-20.44	Peak	HORIZONTAL
7715.00	47.92	36.08	43.21	13.09	53.88	74.00	-20.12	Peak	HORIZONTAL
9517.00	44.09	37.12	43.88	14.67	52.00	54.00	-2.00	Average	HORIZONTAL
9517.00	47.78	37.12	43.88	14.67	55.69	74.00	-18.31	Peak	HORIZONTAL
4009.00	47.62	32.91	44.40	8.93	45.06	74.00	-28.94	Peak	VERTICAL
5573.00	48.69	34.36	44.08	11.11	50.08	74.00	-23.92	Peak	VERTICAL
6729.00	46.72	35.44	43.64	12.15	50.67	74.00	-23.33	Peak	VERTICAL
7919.00	46.55	36.24	43.13	13.85	53.51	74.00	-20.49	Peak	VERTICAL
8497.00	46.39	36.80	43.37	14.05	53.87	74.00	-20.13	Peak	VERTICAL
9398.00	41.26	37.05	43.82	14.89	49.38	54.00	-4.62	Average	VERTICAL
9398.00	46.26	37.05	43.82	14.89	54.38	74.00	-19.62	Peak	VERTICAL
GFSK Tx mode 2475MHz									
4094.00	47.56	33.04	44.38	9.29	45.51	74.00	-28.49	Peak	HORIZONTAL
5811.00	47.04	34.55	44.04	11.43	48.98	74.00	-25.02	Peak	HORIZONTAL
6763.00	47.24	35.46	43.63	12.25	51.32	74.00	-22.68	Peak	HORIZONTAL
7970.00	46.75	36.28	43.11	14.00	53.92	74.00	-20.08	Peak	HORIZONTAL
8956.00	46.58	36.80	43.61	14.19	53.96	74.00	-20.04	Peak	HORIZONTAL
9347.00	41.60	37.02	43.80	14.75	49.57	54.00	-4.43	Average	HORIZONTAL
9347.00	46.60	37.02	43.80	14.75	54.57	74.00	-19.43	Peak	HORIZONTAL
4009.00	47.60	32.91	44.40	8.93	45.04	74.00	-28.96	Peak	VERTICAL
5182.00	47.22	34.05	44.16	10.40	47.51	74.00	-26.49	Peak	VERTICAL
5726.00	47.60	34.49	44.05	11.26	49.30	74.00	-24.70	Peak	VERTICAL

6950.00	46.67	35.57	43.54	12.48	51.18	74.00	-22.82	Peak	VERTICAL
8310.00	46.14	36.61	43.27	13.37	52.85	74.00	-21.15	Peak	VERTICAL
9364.00	42.45	37.03	43.81	14.80	50.47	54.00	-3.53	Average	VERTICAL
9364.00	46.45	37.03	43.81	14.80	54.47	74.00	-19.53	Peak	VERTICAL
Result: Pass									

Factory 3:

Freq. (MHz)	Read level (dBμV)	Antenna Factor (dB/m)	PRM Factor (dB)	Cable Loss (dB)	Result Level (dBμV/m)	Limit (dBμV/m)	Margin (dB)	Detector type	Polarization
GFSK Tx mode 2407MHz									
3312.00	50.47	31.78	44.40	6.43	44.28	74.00	-29.72	Peak	HORIZONTAL
4621.00	46.87	33.68	44.27	9.82	46.10	74.00	-27.90	Peak	HORIZONTAL
5692.00	48.20	34.46	44.06	11.20	49.80	74.00	-24.20	Peak	HORIZONTAL
6797.00	47.33	35.48	43.61	12.35	51.55	74.00	-22.45	Peak	HORIZONTAL
7392.00	47.15	35.84	43.35	13.05	52.69	74.00	-21.31	Peak	HORIZONTAL
8854.00	46.45	36.80	43.55	14.02	53.72	74.00	-20.28	Peak	HORIZONTAL
3312.00	50.47	31.78	44.40	6.43	44.28	74.00	-29.72	Peak	HORIZONTAL
3533.00	48.79	32.16	44.40	7.13	43.68	74.00	-30.32	Peak	VERTICAL
4808.00	47.49	33.79	44.24	11.23	48.27	74.00	-25.73	Peak	VERTICAL
6236.00	47.47	34.99	43.88	12.12	50.70	74.00	-23.30	Peak	VERTICAL
7307.00	47.70	35.79	43.38	12.71	52.82	74.00	-21.18	Peak	VERTICAL
7817.00	46.70	36.16	43.17	13.57	53.26	74.00	-20.74	Peak	VERTICAL
8854.00	46.15	36.80	43.55	14.02	53.42	74.00	-20.58	Peak	VERTICAL
GFSK Tx mode 2441MHz									
4519.00	47.35	33.61	44.29	9.99	46.66	74.00	-27.34	Peak	HORIZONTAL
5726.00	49.20	34.49	44.05	11.26	50.90	74.00	-23.10	Peak	HORIZONTAL
6729.00	49.04	35.44	43.64	12.15	52.99	74.00	-21.01	Peak	HORIZONTAL
7749.00	46.86	36.10	43.20	13.26	53.02	74.00	-20.98	Peak	HORIZONTAL
8480.00	45.63	36.78	43.36	13.97	53.02	74.00	-20.98	Peak	HORIZONTAL
8922.00	46.32	36.80	43.59	14.05	53.58	74.00	-20.42	Peak	HORIZONTAL
3992.00	47.44	32.89	44.40	8.84	44.77	74.00	-29.23	Peak	VERTICAL
5029.00	48.28	33.92	44.19	10.06	48.07	74.00	-25.93	Peak	VERTICAL
6695.00	46.92	35.42	43.66	12.07	50.75	74.00	-23.25	Peak	VERTICAL
8123.00	46.25	36.43	43.17	13.44	52.95	74.00	-21.05	Peak	VERTICAL
8854.00	46.55	36.80	43.55	14.02	53.82	74.00	-20.18	Peak	VERTICAL
9517.00	44.95	37.12	43.88	14.67	52.86	74.00	-21.14	Peak	VERTICAL
GFSK Tx mode 2475MHz									
3975.00	46.48	32.86	44.40	8.74	43.68	74.00	-30.32	Peak	HORIZONTAL
4995.00	47.54	33.90	44.20	9.96	47.20	74.00	-26.80	Peak	HORIZONTAL
6015.00	47.55	34.72	43.99	11.35	49.63	74.00	-24.37	Peak	HORIZONTAL
6933.00	47.94	35.56	43.55	12.43	52.38	74.00	-21.62	Peak	HORIZONTAL
7834.00	46.10	36.17	43.17	13.61	52.71	74.00	-21.29	Peak	HORIZONTAL
8429.00	46.33	36.73	43.33	13.71	53.44	74.00	-20.56	Peak	HORIZONTAL
3805.00	46.84	32.60	44.40	8.11	43.15	74.00	-30.85	Peak	VERTICAL
5267.00	46.31	34.12	44.14	10.46	46.75	74.00	-27.25	Peak	VERTICAL
6185.00	46.18	34.93	43.90	12.14	49.35	74.00	-24.65	Peak	VERTICAL

7358.00	47.26	35.82	43.36	12.91	52.63	74.00	-21.37	Peak	VERTICAL
8429.00	46.21	36.73	43.33	13.71	53.32	74.00	-20.68	Peak	VERTICAL
9177.00	44.13	36.91	43.72	14.75	52.07	74.00	-21.93	Peak	VERTICAL
Result: Pass									

Note 1: Result Level = Read Level + Antenna Factor + Cable loss - PRM Factor.

2: For emissions above 1GHz. If peak results comply with AV limit, AV Result is deemed to comply with AV limit.

6. Band Edge Compliance

6.1. Block diagram of test setup

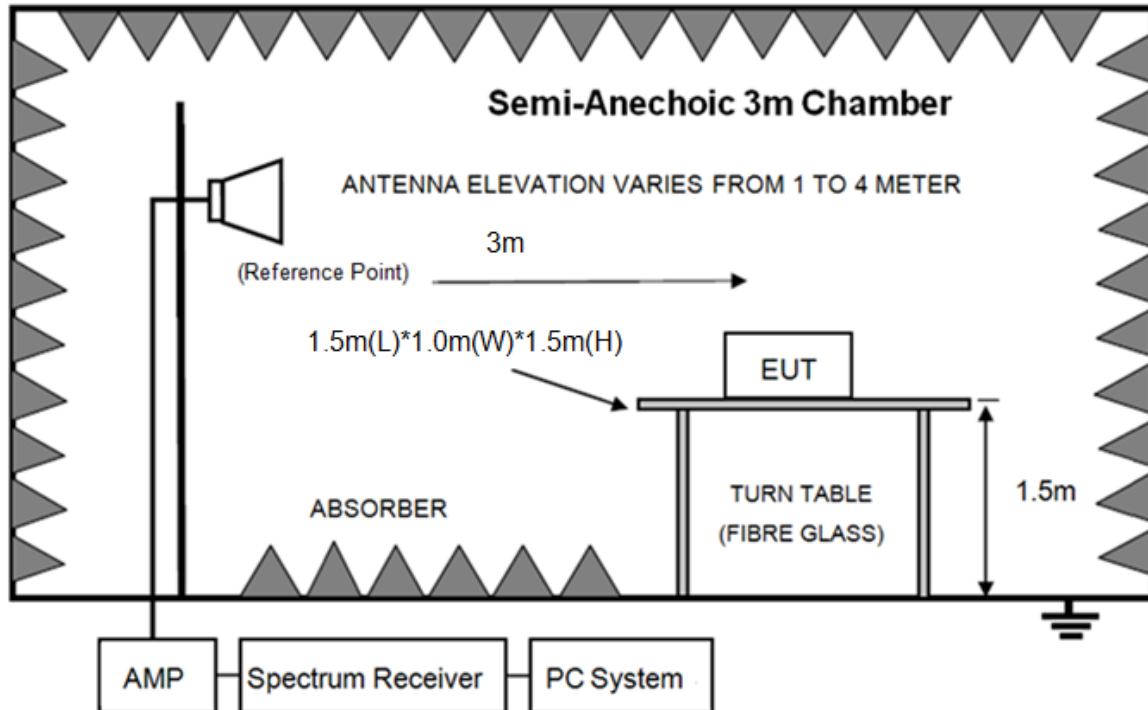

6.2. Limit

All the lower and upper band-edges emissions appearing within 2310MHz to 2390MHz and 2483.5MHz to 2500MHz restricted frequency bands shall not exceed the limits shown in 15.209, all the other emissions outside operation frequency band 2400MHz to 2483.5MHz and 5725MHz to 5850MHz shall be at least 20dB below the fundamental emissions, or comply with 15.209 limits.

6.3. Test Procedure

Same with clause 8.3 except change investigated frequency range from 2310MHz to 2410MHz and 2470MHz to 2500MHz.

Remark: All restriction band have been tested, and only the worst case is shown in report.

6.4. Test result

PASS. (See below detailed test result)

TR-4-E-009 Radiated Emission Test Result

Test Site : DDT 3m Chamber 1# **D:\2018 RE1# Report Data\Q18112311-1E FLIP5\FCC ABOVE1G.EM6**
Test Date : 2019-01-15 **Tested By** : Talent
EUT : PORTABLE BLUETOOTH SPEAKER **Model Number** : FLIP5
Power Supply : Battery **Test Mode** : Tx mode
Condition : Temp:24.5°C,Humi:55%,Press:100.1kPa **Antenna/Distance** : 2018 HF 907/3m/HORIZONTAL
Memo : DH5 2407

Data: 33

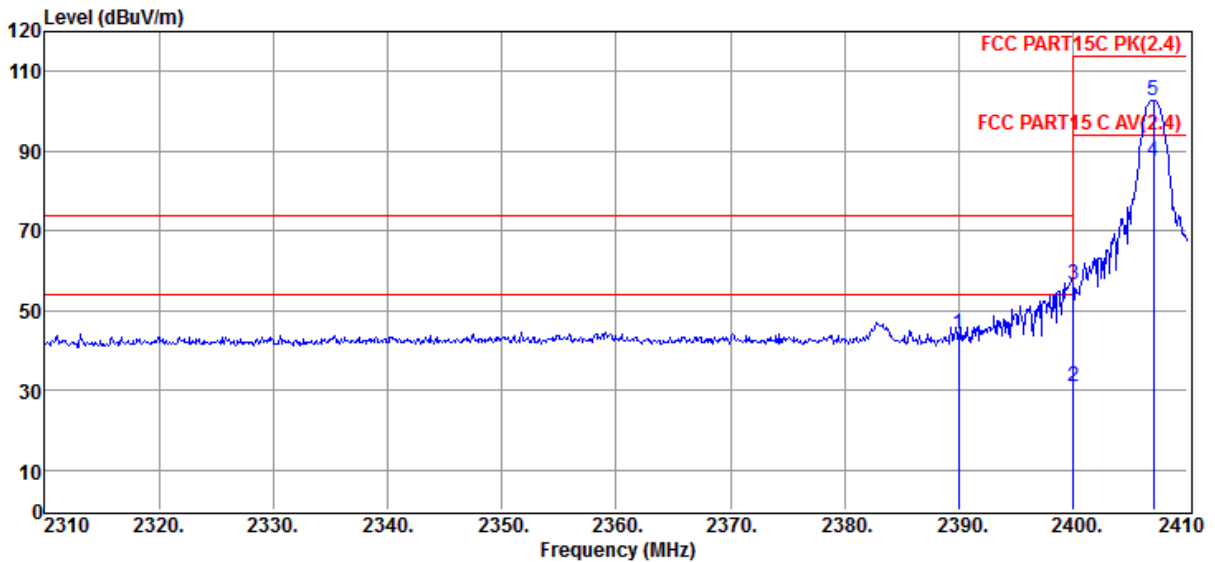

Item (Mark)	Freq. (MHz)	Read Level (dBμV)	Antenna Factor (dB/m)	PRM Factor (dB)	Cable Loss (dB)	Result Level (dBμV/m)	Limit Line (dBμV/m)	Over Limit (dB)	Detector	Polarization
1	2390.00	54.45	29.10	44.18	4.56	43.93	74.00	-30.07	Peak	HORIZONTAL
2	2400.00	41.63	29.12	44.18	4.56	31.13	54.00	-22.87	Average	HORIZONTAL
3	2400.00	67.05	29.12	44.18	4.56	56.55	74.00	-17.45	Peak	HORIZONTAL
4	2407.00	97.79	29.13	44.18	4.59	87.33	94.00	-6.67	Average	HORIZONTAL
5	2407.00	113.09	29.13	44.18	4.59	102.63	114.00	-11.37	Peak	HORIZONTAL

- Note: 1. Result Level = Read Level + Antenna Factor + Cable loss - PRM Factor.
 2. If Peak Result complies with AV limit, AV Result is deemed to comply with AV limit.
 3. Test setup: RBW: 1 MHz, VBW: 3 MHz, Sweep time: auto.

TR-4-E-009 Radiated Emission Test Result

Test Site : DDT 3m Chamber 1#

D:\2018 RE1# Report Data\Q18112311-1E FLIP5\FCC ABOVE1G.EM6

Test Date : 2019-01-15

Tested By : Talent

EUT : PORTABLE BLUETOOTH SPEAKER

Model Number : FLIP5

Power Supply : Battery

Test Mode : Tx mode

Condition : Temp:24.5°C,Humi:55%,Press:100.1kPa

Antenna/Distance : 2018 HF 907/3m/VERTICAL

Memo : DH5 2407

Data: 34

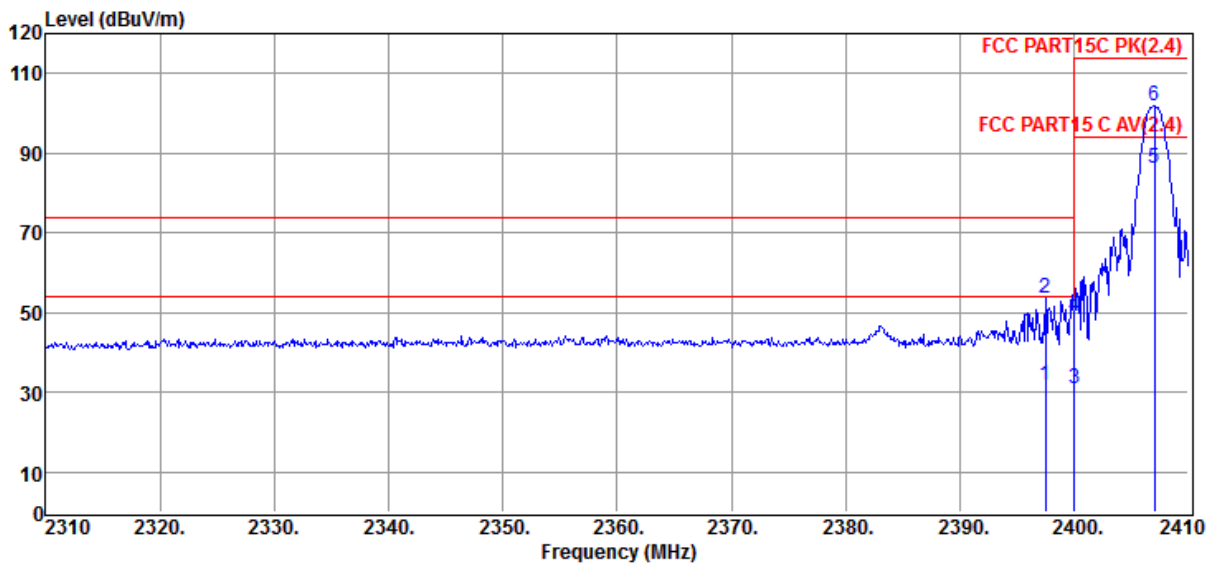

Item (Mark)	Freq. (MHz)	Read Level (dBμV)	Antenna Factor (dB/m)	PRM Factor (dB)	Cable Loss (dB)	Result Level (dBμV/m)	Limit Line (dBμV/m)	Over Limit (dB)	Detector	Polarization
1	2397.50	42.36	29.11	44.18	4.56	31.85	54.00	-22.15	Average	VERTICAL
2	2397.50	63.95	29.11	44.18	4.56	53.44	74.00	-20.56	Peak	VERTICAL
3	2400.00	41.35	29.12	44.18	4.56	30.85	54.00	-23.15	Average	VERTICAL
4	2400.00	59.50	29.12	44.18	4.56	49.00	74.00	-25.00	Peak	VERTICAL
5	2407.00	96.85	29.13	44.18	4.59	86.39	94.00	-7.61	Average	VERTICAL
6	2407.00	112.13	29.13	44.18	4.59	101.67	114.00	-12.33	Peak	VERTICAL

Note: 1. Result Level = Read Level + Antenna Factor + Cable loss - PRM Factor.

2. If Peak Result complies with AV limit, AV Result is deemed to comply with AV limit.

3. Test setup: RBW: 1 MHz, VBW: 3 MHz, Sweep time: auto.

TR-4-E-009 Radiated Emission Test Result

Test Site : DDT 3m Chamber 1#

D:\2018 RE1# Report Data\Q18112311-1E FLIP5\FCC ABOVE1G.EM6

Test Date : 2019-01-15

Tested By : Talent

EUT : PORTABLE BLUETOOTH SPEAKER

Model Number : FLIP5

Power Supply : Battery

Test Mode : Tx mode

Condition : Temp:24.5°C,Humi:55%,Press:100.1kPa

Antenna/Distance : 2018 HF 907/3m/VERTICAL

Memo : DH5 2475

Data: 35

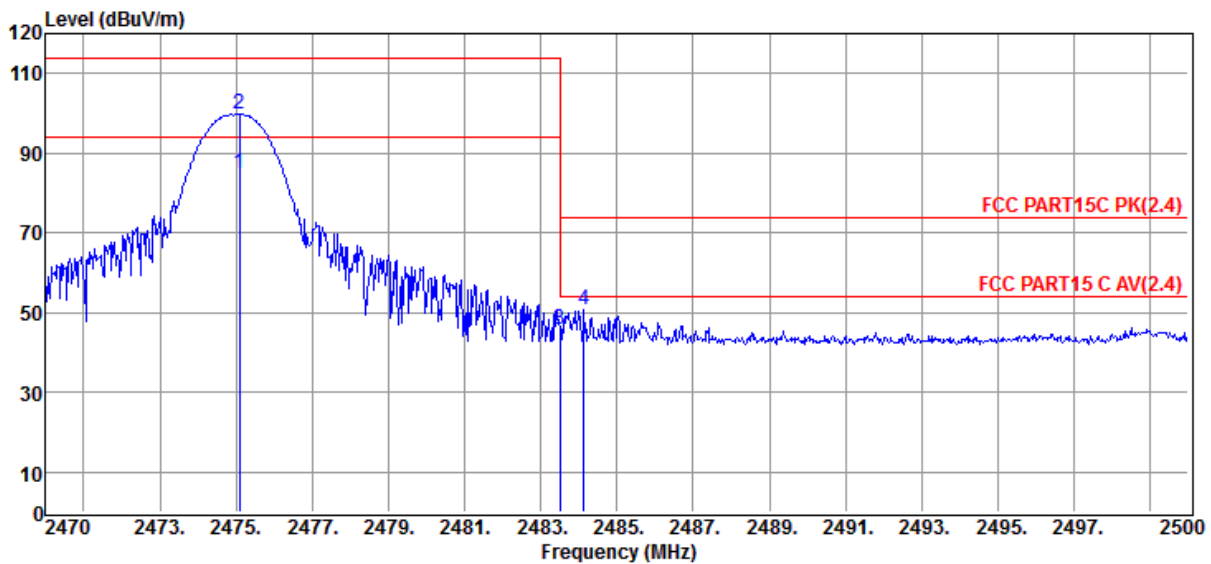

Item (Mark)	Freq. (MHz)	Read Level (dB μ V)	Antenna Factor (dB/m)	PRM Factor dB	Cable Loss dB	Result Level (dB μ V/m)	Limit Line (dB μ V/m)	Over Limit (dB)	Detector	Polarization
1	2475.00	95.23	29.26	44.21	4.86	85.14	94.00	-8.86	Average	VERTICAL
2	2475.00	109.7 5	29.26	44.21	4.86	99.66	114.00	-14.34	Peak	VERTICAL
3	2483.50	55.80	29.27	44.21	4.89	45.75	74.00	-28.25	Peak	VERTICAL
4	2484.13	60.61	29.27	44.21	4.90	50.57	74.00	-23.43	Peak	VERTICAL

Note: 1. Result Level = Read Level + Antenna Factor + Cable loss - PRM Factor.

2. If Peak Result complies with AV limit, AV Result is deemed to comply with AV limit.

3. Test setup: RBW: 1 MHz, VBW: 3 MHz, Sweep time: auto.

TR-4-E-009 Radiated Emission Test Result

Test Site : DDT 3m Chamber 1#
Test Date : 2019-01-15
EUT : PORTABLE BLUETOOTH SPEAKER
Power Supply : Battery
Condition : Temp:24.5°C,Humi:55%,Press:100.1kPa
Memo : DH5 2475

D:\2018 RE1# Report Data\Q18112311-1E FLIP5\FCC ABOVE1G.EM6
Tested By : Talent
Model Number : FLIP5
Test Mode : Tx mode
Antenna/Distance : 2018 HF 907/3m/HORIZONTAL

Data: 36

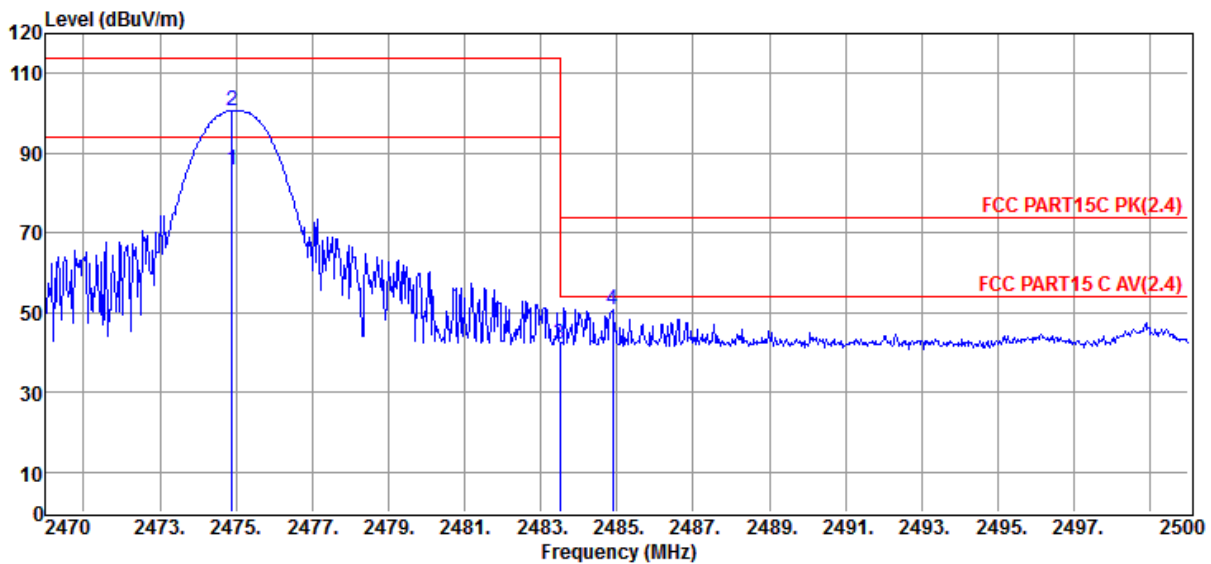

Item (Mark)	Freq. (MHz)	Read Level (dBμV)	Antenna Factor (dB/m)	PRM Factor (dB)	Cable Loss (dB)	Result Level (dBμV/m)	Limit Line (dBμV/m)	Over Limit (dB)	Detector	Polarization
1	2475.00	95.91	29.25	44.21	4.86	85.81	94.00	-8.19	Average	HORIZONTAL
2	2475.00	110.69	29.25	44.21	4.86	100.59	114.00	-13.41	Peak	HORIZONTAL
3	2483.50	52.27	29.27	44.21	4.89	42.22	74.00	-31.78	Peak	HORIZONTAL
4	2484.88	60.88	29.27	44.21	4.90	50.84	74.00	-23.16	Peak	HORIZONTAL

Note: 1. Result Level = Read Level + Antenna Factor + Cable loss - PRM Factor.

2. If Peak Result complies with AV limit, AV Result is deemed to comply with AV limit.

3. Test setup: RBW: 1 MHz, VBW: 3 MHz, Sweep time: auto.

TR-4-E-009 Radiated Emission Test Result

Test Site : DDT 3m Chamber 1# D:\2018 RE1# Report Data\Q18112311-1E FLIP5\FCC ABOVE1G.EM6
Test Date : 2019-02-01 **Tested By** : Talent
EUT : PORTABLE BLUETOOTH SPEAKER **Model Number** : FLIP5
Power Supply : Battery **Test Mode** : Tx mode
Condition : Temp:24.5°C,Humi:55%,Press:100.1kPa **Antenna/Distance** : 2018 HF 907/3m/VERTICAL
Memo : 3DH5 2407

Data: 63

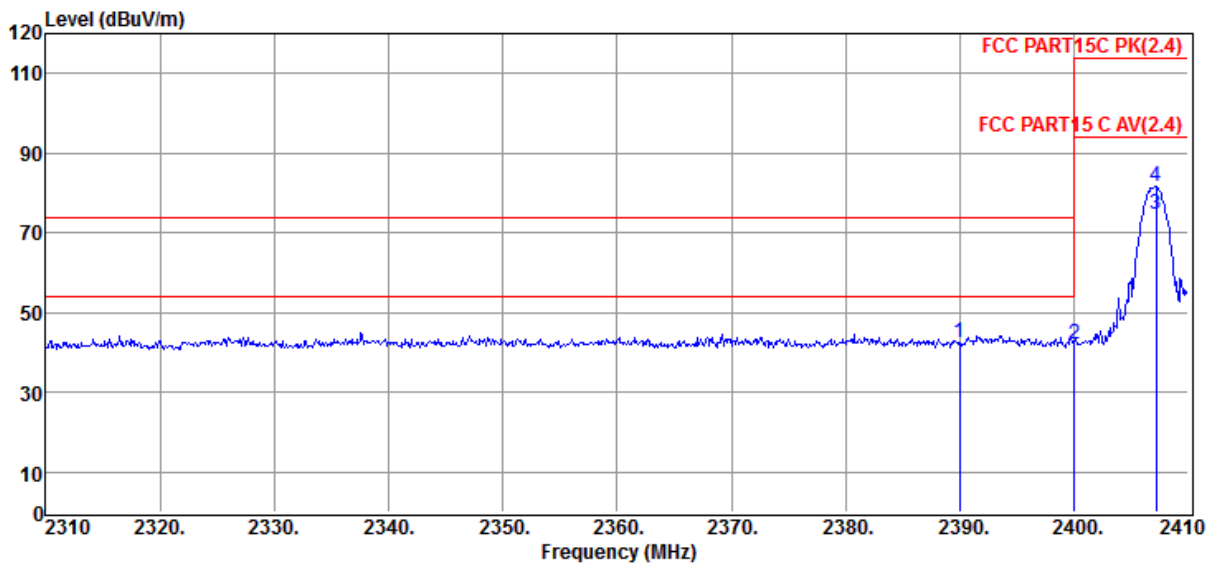

Item (Mark)	Freq. (MHz)	Read Level (dBμV)	Antenna Factor (dB/m)	PRM Factor (dB)	Cable Loss (dB)	Result Level (dBμV/m)	Limit Line (dBμV/m)	Over Limit (dB)	Detector	Polarization
1	2390.00	53.00	29.10	44.18	4.56	42.48	74.00	-31.52	Peak	VERTICAL
2	2400.00	52.73	29.12	44.18	4.56	42.23	74.00	-31.77	Peak	VERTICAL
3	2407.00	85.21	29.13	44.18	4.59	74.75	94.00	-19.25	Average	VERTICAL
4	2407.00	92.04	29.13	44.18	4.59	81.58	114.00	-32.42	Peak	VERTICAL

- Note: 1. Result Level = Read Level + Antenna Factor + Cable loss - PRM Factor.
 2. If Peak Result complies with AV limit, AV Result is deemed to comply with AV limit.
 3. Test setup: RBW: 1 MHz, VBW: 3 MHz, Sweep time: auto.

TR-4-E-009 Radiated Emission Test Result

Test Site : DDT 3m Chamber 1# D:\2018 RE1# Report Data\Q18112311-1E FLIP5\FCC ABOVE1G.EM6
Test Date : 2019-02-01 **Tested By** : Talent
EUT : PORTABLE BLUETOOTH SPEAKER **Model Number** : FLIP5
Power Supply : Battery **Test Mode** : Tx mode
Condition : Temp:24.5°C,Humi:55%,Press:100.1kPa **Antenna/Distance** : 2018 HF 907/3m/HORIZONTAL
Memo : 3DH5 2407

Data: 64

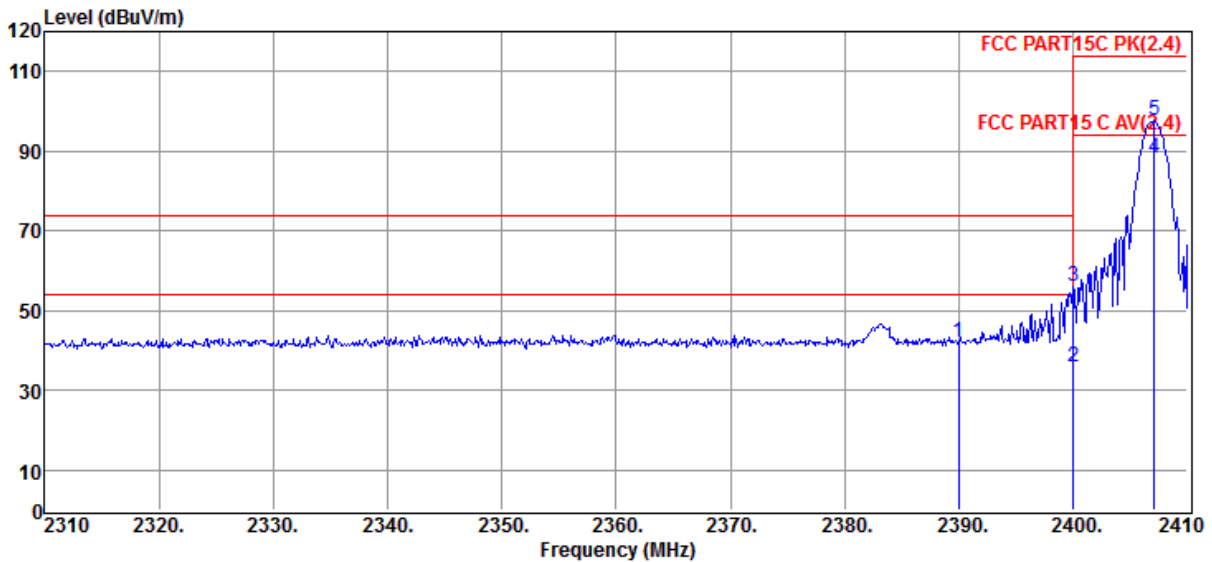

Item (Mark)	Freq. (MHz)	Read Level (dBμV)	Antenna Factor (dB/m)	PRM Factor (dB)	Cable Loss (dB)	Result Level (dBμV/m)	Limit Line (dBμV/m)	Over Limit (dB)	Detector	Polarization
1	2390.00	52.48	29.10	44.18	4.56	41.96	74.00	-32.04	Peak	HORIZONTAL
2	2400.00	46.52	29.12	44.18	4.56	36.02	54.00	-17.98	Average	HORIZONTAL
3	2400.00	66.46	29.12	44.18	4.56	55.96	74.00	-18.04	Peak	HORIZONTAL
4	2407.00	98.52	29.13	44.18	4.59	88.06	94.00	-5.94	Average	HORIZONTAL
5	2407.00	108.16	29.13	44.18	4.59	97.70	114.00	-16.30	Peak	HORIZONTAL

Note: 1. Result Level = Read Level + Antenna Factor + Cable loss - PRM Factor.
 2. If Peak Result complies with AV limit, AV Result is deemed to comply with AV limit.
 3. Test setup: RBW: 1 MHz, VBW: 3 MHz, Sweep time: auto.

TR-4-E-009 Radiated Emission Test Result

Test Site : DDT 3m Chamber 1# D:\2018 RE1# Report Data\Q18112311-1E FLIP5\FCC ABOVE1G.EM6
Test Date : 2019-02-01 **Tested By** : Talent
EUT : PORTABLE BLUETOOTH SPEAKER **Model Number** : FLIP5
Power Supply : Battery **Test Mode** : Tx mode
Condition : Temp:24.5°C,Humi:55%,Press:100.1kPa **Antenna/Distance** : 2018 HF 907/3m/HORIZONTAL
Memo : 3DH5 2475

Data: 65

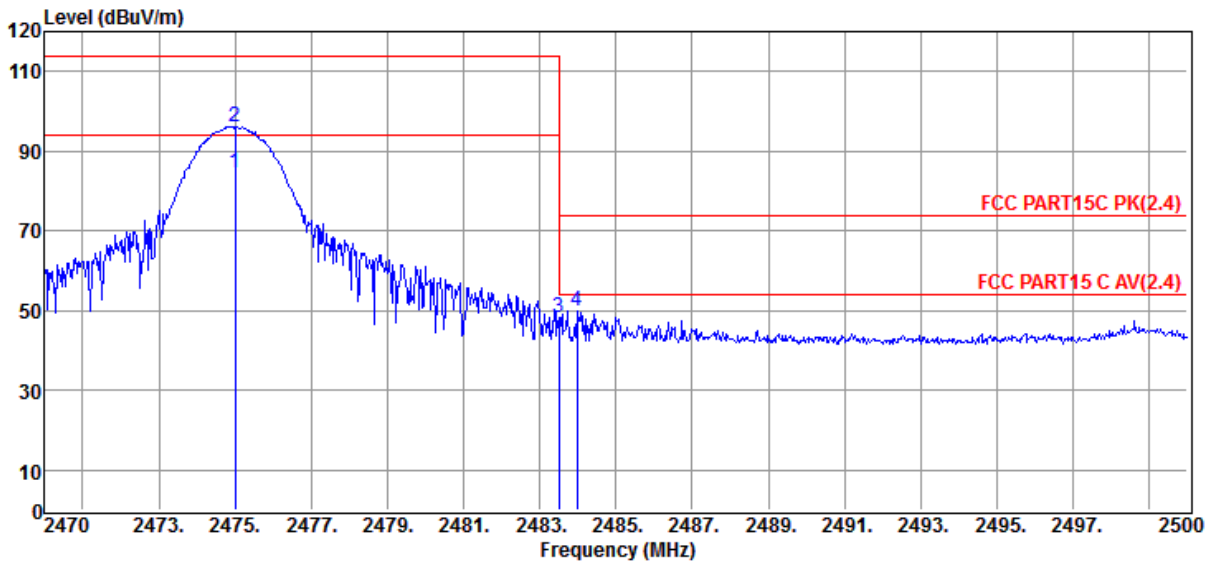

Item (Mark)	Freq. (MHz)	Read Level (dBμV)	Antenna Factor (dB/m)	PRM Factor (dB)	Cable Loss (dB)	Result Level (dBμV/m)	Limit Line (dBμV/m)	Over Limit (dB)	Detector	Polarization
1	2475.00	94.52	29.25	44.21	4.86	84.42	94.00	-9.58	Average	HORIZONTAL
2	2475.00	106.39	29.25	44.21	4.86	96.29	114.00	-17.71	Peak	HORIZONTAL
3	2483.50	58.32	29.27	44.21	4.89	48.27	74.00	-25.73	Peak	HORIZONTAL
4	2483.98	59.79	29.27	44.21	4.90	49.75	74.00	-24.25	Peak	HORIZONTAL

- Note: 1. Result Level = Read Level + Antenna Factor + Cable loss - PRM Factor.
 2. If Peak Result complies with AV limit, AV Result is deemed to comply with AV limit.
 3. Test setup: RBW: 1 MHz, VBW: 3 MHz, Sweep time: auto.

TR-4-E-009 Radiated Emission Test Result

Test Site : DDT 3m Chamber 1# D:\2018 RE1# Report Data\Q18112311-1E FLIP5\FCC ABOVE1G.EM6
Test Date : 2019-02-01 **Tested By** : Talent
EUT : PORTABLE BLUETOOTH SPEAKER **Model Number** : FLIP5
Power Supply : Battery **Test Mode** : Tx mode
Condition : Temp:24.5°C,Humi:55%,Press:100.1kPa **Antenna/Distance** : 2018 HF 907/3m/HORIZONTAL
Memo : 3DH5 2475

Data: 66

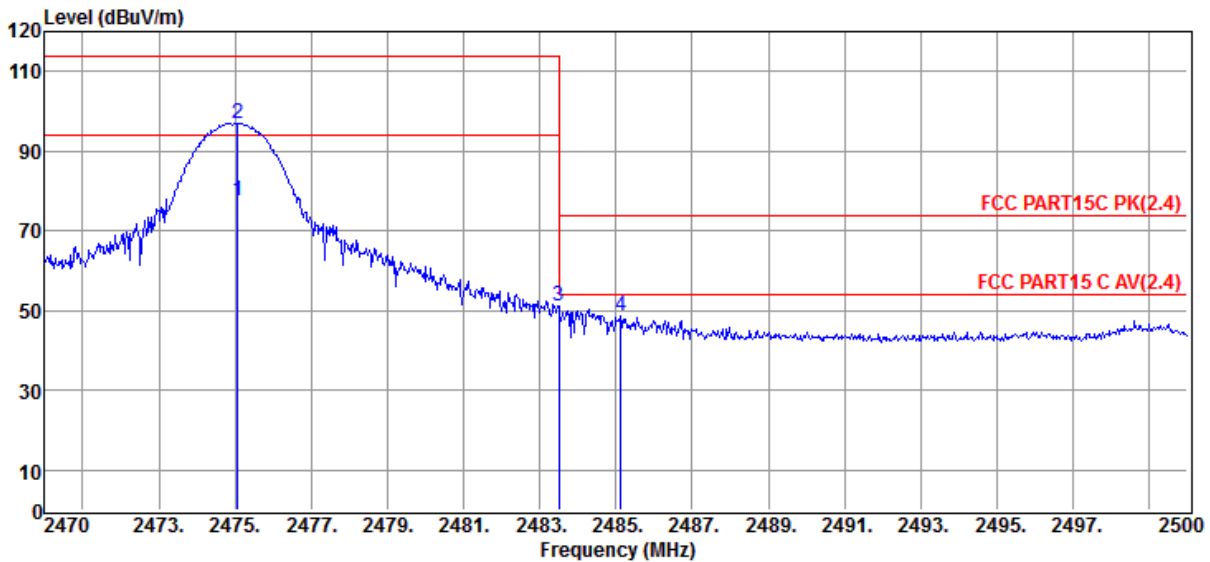

Item (Mark)	Freq. (MHz)	Read Level (dBμV)	Antenna Factor (dB/m)	PRM Factor (dB)	Cable Loss (dB)	Result Level (dBμV/m)	Limit Line (dBμV/m)	Over Limit (dB)	Detector	Polarization
1	2475.00	87.52	29.26	44.21	4.86	77.43	94.00	-16.57	Average	HORIZONTAL
2	2475.00	107.20	29.26	44.21	4.86	97.11	114.00	-16.89	Peak	HORIZONTAL
3	2483.50	61.29	29.27	44.21	4.89	51.24	74.00	-22.76	Peak	HORIZONTAL
4	2485.12	58.74	29.27	44.21	4.90	48.70	74.00	-25.30	Peak	HORIZONTAL

Note: 1. Result Level = Read Level + Antenna Factor + Cable loss - PRM Factor.
 2. If Peak Result complies with AV limit, AV Result is deemed to comply with AV limit.
 3. Test setup: RBW: 1 MHz, VBW: 3 MHz, Sweep time: auto.

7. Power Line Conducted Emission

7.1. Block diagram of test setup

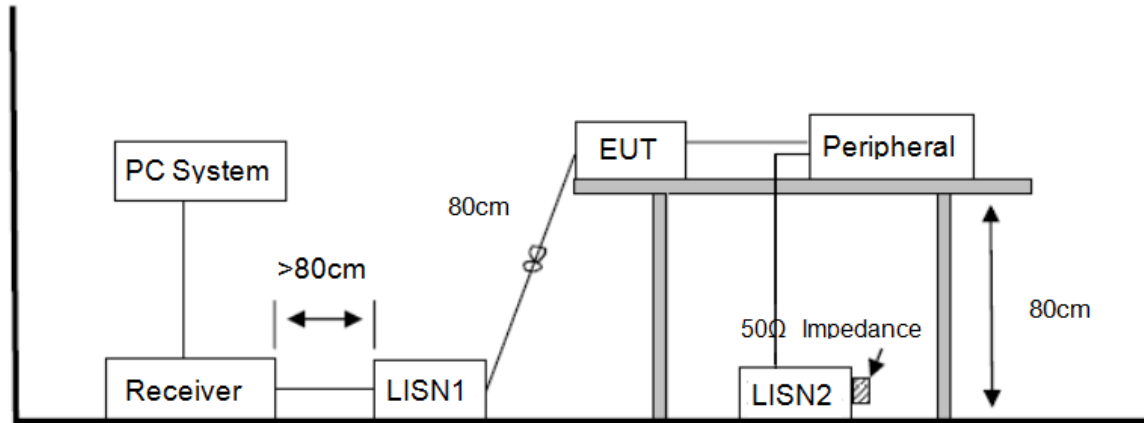

7.2. Power Line Conducted Emission Limits

Frequency	Quasi-Peak Level dB(μ V)	Average Level dB(μ V)
150kHz ~ 500kHz	66 ~ 56*	56 ~ 46*
500kHz ~ 5MHz	56	46
5MHz ~ 30MHz	60	50

Note 1: * Decreasing linearly with logarithm of frequency.

Note 2: The lower limit shall apply at the transition frequencies.

7.3. Test Procedure

The EUT and Support equipment, if needed, were put placed on a non-metallic table, 80cm above the ground plane.

Configuration EUT to simulate typical usage as described in clause 2.4 and test equipment as described in clause 10.2 of this report.

All I/O cables were positioned to simulate typical actual usage as per ANSI C63.10.

All support equipment power received from a second LISN.

Emissions were measured on each current carrying line of the EUT using an EMI Test Receiver connected to the LISN powering the EUT.

The Receiver scanned from 150 kHz to 30MHz for emissions in each of the test modes.

During the above scans, the emissions were maximized by cable manipulation.

The test mode(s) described in clause 2.4 were scanned during the preliminary test.

After the preliminary scan, we found the test mode producing the highest emission level. The EUT configuration and worse cable configuration of the above highest emission levels were

recorded for reference of the final test.

EUT and support equipment were set up on the test bench as per the configuration with highest emission level in the preliminary test.

A scan was taken on both power lines, Neutral and Line, recording at least the six highest emissions.

Emission frequency and amplitude were recorded into a computer in which correction factors were used to calculate the emission level and compare reading to the applicable limit.

The test data of the worst-case condition(s) was recorded.

The bandwidth of test receiver is set at 9 kHz.

7.4. Test Result

PASS. (See below detailed test result)

Note1: All emissions not reported below are too low against the prescribed limits.

Note2: "----" means Peak detection; "-----" means Average detection.

Note3: Pre-test AC conducted emission at both voltage AC 120V/60Hz and AC 240V/50Hz, recorded worst case.

TR-4-E-010 Conducted Emission Test Result

Test Site : DDT 1# Shield Room **D:\2018 CE report data\Q18112311-8E\CE.EM6**
Test Date : 2019-01-14 **Tested By** : Aaron
EUT : PORTABLE BLUETOOTH SPEAKER **Model Number** : FLIP5
Power Supply : AC 120V/60Hz **Test Mode** : Tx mdoe
Condition : Temp:24.5°C,Humi:55%,Press:100.1KPa **LISN** : 2018 ENV216/LINE
Memo : Original battery (Factory 1)

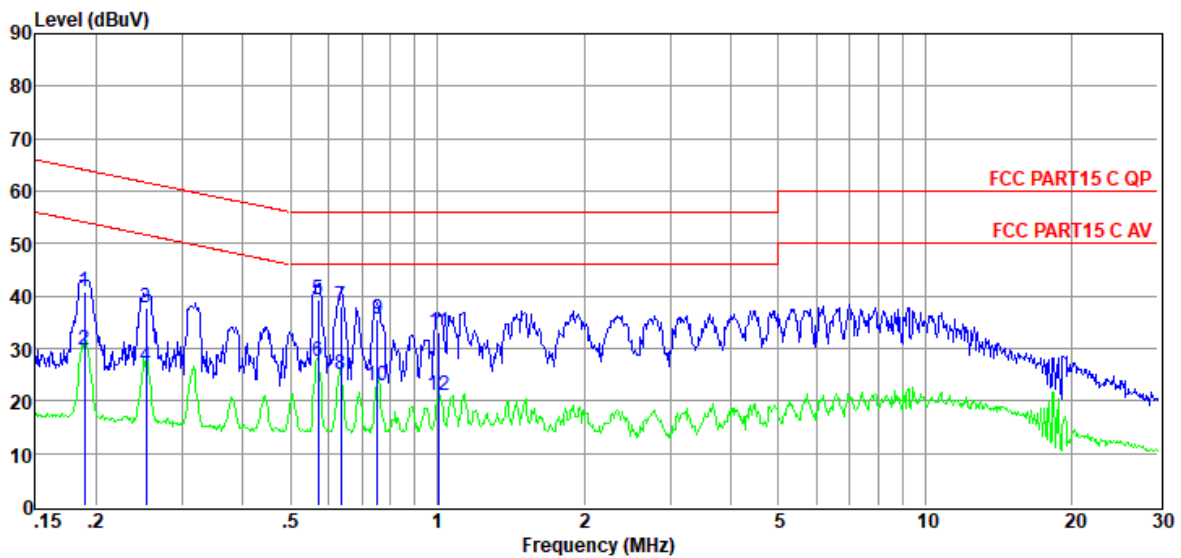

Item (Mark)	Freq. (MHz)	Read Level (dBμV)	LISN Factor (dB)	Cable Loss (dB)	Pulse Limiter Factor (dB)	Result Level (dBμV)	Limit Line (dBμV)	Over Limit (dB)	Detector	Phase
1	0.19	21.39	9.63	0.02	9.86	40.90	64.06	-23.16	QP	LINE
2	0.19	10.10	9.63	0.02	9.86	29.61	54.06	-24.45	Average	LINE
3	0.25	18.35	9.63	0.02	9.86	37.86	61.64	-23.78	QP	LINE
4	0.25	7.02	9.63	0.02	9.86	26.53	51.64	-25.11	Average	LINE
5	0.57	19.90	9.64	0.03	9.86	39.43	56.00	-16.57	QP	LINE
6	0.57	8.10	9.64	0.03	9.86	27.63	46.00	-18.37	Average	LINE
7	0.63	18.38	9.64	0.03	9.86	37.91	56.00	-18.09	QP	LINE
8	0.63	5.43	9.64	0.03	9.86	24.96	46.00	-21.04	Average	LINE
9	0.75	16.02	9.64	0.04	9.86	35.56	56.00	-20.44	QP	LINE
10	0.75	3.37	9.64	0.04	9.86	22.91	46.00	-23.09	Average	LINE
11	1.01	13.54	9.64	0.10	9.87	33.15	56.00	-22.85	QP	LINE
12	1.01	1.43	9.64	0.10	9.87	21.04	46.00	-24.96	Average	LINE

Note: 1. Result Level = Read Level + LISN Factor + Pulse Limiter Factor + Cable loss.

2. If QP Result complies with AV limit, AV Result is deemed to comply with AV limit.

3. Test setup: RBW: 200 Hz (9 kHz—150 kHz), 9 kHz (150 kHz—30 MHz).

4. Step size: 80Hz (0.009MHz-0.15MHz), 4 kHz (0.15MHz-30MHz), Scan time: auto.

TR-4-E-010 Conducted Emission Test Result

Test Site : DDT 1# Shield Room D:\2018 CE report data\Q18112311-8E\CE.EM6
Test Date : 2019-01-14 **Tested By** : Aaron
EUT : PORTABLE BLUETOOTH SPEAKER **Model Number** : FLIP5
Power Supply : AC 120V/60Hz **Test Mode** : Tx mdoe
Condition : Temp:24.5°C,Humi:55%,Press:100.1KPa **LISN** : 2018 ENV216/NEUTRAL
Memo : Original battery (Factory 1)

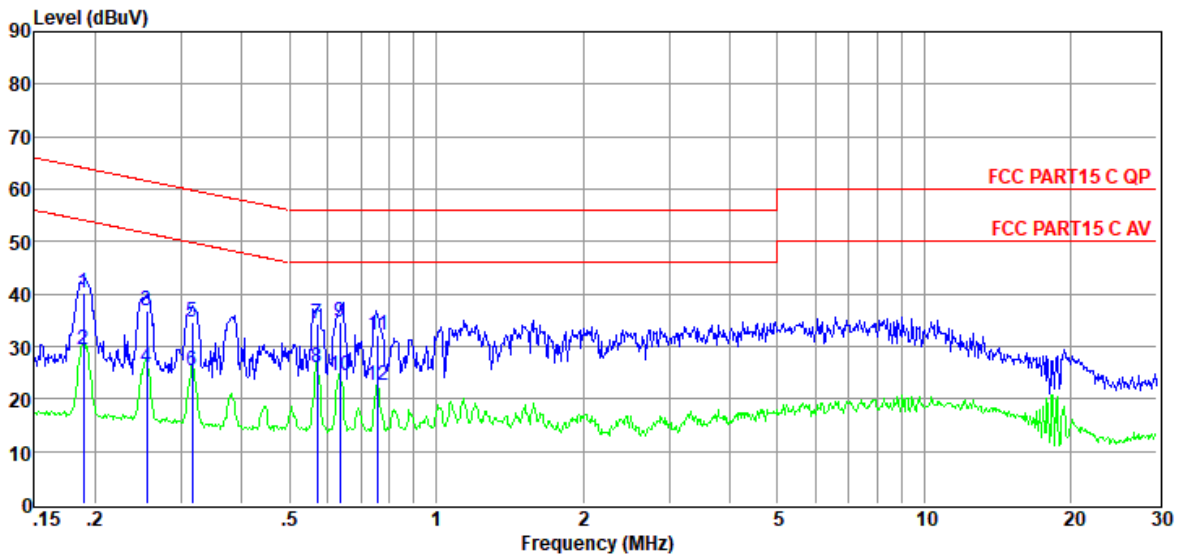

Item	Freq.	Read Level	LISN Factor	Cable Loss	Pulse Limiter Factor	Result Level	Limit Line	Over Limit	Detector	Phase
(Mark)	(MHz)	(dBμV)	(dB)	(dB)	(dB)	(dBμV)	(dBμV)	(dB)		
1	0.19	20.59	9.64	0.02	9.86	40.11	64.06	-23.95	QP	NEUTRAL
2	0.19	9.78	9.64	0.02	9.86	29.30	54.06	-24.76	Average	NEUTRAL
3	0.25	17.29	9.64	0.02	9.86	36.81	61.60	-24.79	QP	NEUTRAL
4	0.25	6.48	9.64	0.02	9.86	26.00	51.60	-25.60	Average	NEUTRAL
5	0.32	14.99	9.64	0.02	9.86	34.51	59.80	-25.29	QP	NEUTRAL
6	0.32	5.79	9.64	0.02	9.86	25.31	49.80	-24.49	Average	NEUTRAL
7	0.57	14.74	9.64	0.03	9.86	34.27	56.00	-21.73	QP	NEUTRAL
8	0.57	6.43	9.64	0.03	9.86	25.96	46.00	-20.04	Average	NEUTRAL
9	0.63	14.98	9.64	0.03	9.86	34.51	56.00	-21.49	QP	NEUTRAL
10	0.63	5.05	9.64	0.03	9.86	24.58	46.00	-21.42	Average	NEUTRAL
11	0.76	12.55	9.64	0.04	9.86	32.09	56.00	-23.91	QP	NEUTRAL
12	0.76	2.89	9.64	0.04	9.86	22.43	46.00	-23.57	Average	NEUTRAL

- Note: 1. Result Level = Read Level + LISN Factor + Pulse Limiter Factor + Cable loss.
 2. If QP Result complies with AV limit, AV Result is deemed to comply with AV limit.
 3. Test setup: RBW: 200 Hz (9 kHz—150 kHz), 9 kHz (150 kHz—30 MHz).
 4. Step size: 80Hz (0.009MHz-0.15MHz), 4 kHz (0.15MHz-30MHz), Scan time: auto

TR-4-E-010 Conducted Emission Test Result

Test Site : DDT 1# Shield Room D:\2018 CE report data\Q18112311-8E\CE.EM6
Test Date : 2019-01-14 **Tested By** : Aaron
EUT : PORTABLE BLUETOOTH SPEAKER **Model Number** : FLIP5
Power Supply : AC 120V/60Hz **Test Mode** : Tx mode
Condition : Temp:24.5°C,Humi:55%,Press:100.1KPa **LISN** : 2018 ENV216/LINE
Memo : Original battery (Factory 2)

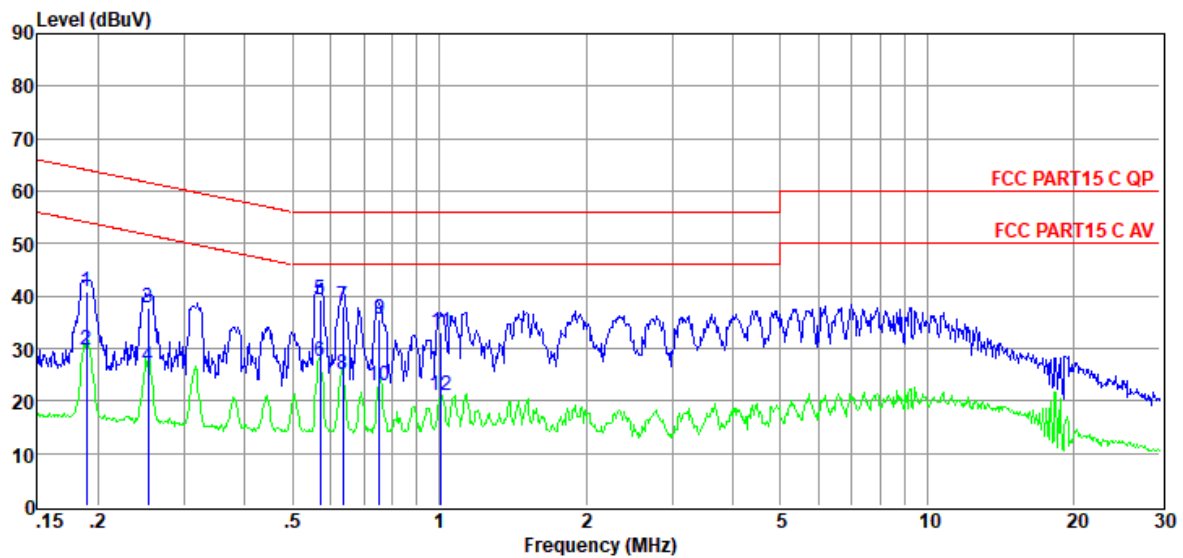

Item	Freq.	Read Level	LISN Factor	Cable Loss	Pulse Limiter Factor	Result Level	Limit Line	Over Limit	Detector	Phase
(Mark)	(MHz)	(dBμV)	(dB)	(dB)	(dB)	(dBμV)	(dBμV)	(dB)		
1	0.19	21.39	9.63	0.02	9.86	40.90	64.06	-23.16	QP	LINE
2	0.19	10.10	9.63	0.02	9.86	29.61	54.06	-24.45	Average	LINE
3	0.25	18.35	9.63	0.02	9.86	37.86	61.64	-23.78	QP	LINE
4	0.25	7.02	9.63	0.02	9.86	26.53	51.64	-25.11	Average	LINE
5	0.57	19.90	9.64	0.03	9.86	39.43	56.00	-16.57	QP	LINE
6	0.57	8.10	9.64	0.03	9.86	27.63	46.00	-18.37	Average	LINE
7	0.63	18.38	9.64	0.03	9.86	37.91	56.00	-18.09	QP	LINE
8	0.63	5.43	9.64	0.03	9.86	24.96	46.00	-21.04	Average	LINE
9	0.75	16.02	9.64	0.04	9.86	35.56	56.00	-20.44	QP	LINE
10	0.75	3.37	9.64	0.04	9.86	22.91	46.00	-23.09	Average	LINE
11	1.01	13.54	9.64	0.10	9.87	33.15	56.00	-22.85	QP	LINE
12	1.01	1.43	9.64	0.10	9.87	21.04	46.00	-24.96	Average	LINE

Note: 1. Result Level = Read Level + LISN Factor + Pulse Limiter Factor + Cable loss.

2. If QP Result complies with AV limit, AV Result is deemed to comply with AV limit.

3. Test setup: RBW: 200 Hz (9 kHz—150 kHz), 9 kHz (150 kHz—30 MHz).

4. Step size: 80Hz (0.009MHz-0.15MHz), 4 kHz (0.15MHz-30MHz), Scan time: auto.

TR-4-E-010 Conducted Emission Test Result

Test Site : DDT 1# Shield Room D:\2018 CE report data\Q18112311-8E\CE.EM6
Test Date : 2019-01-14 **Tested By** : Aaron
EUT : PORTABLE BLUETOOTH SPEAKER **Model Number** : FLIP5
Power Supply : AC 120V/60Hz **Test Mode** : Tx mode
Condition : Temp:24.5°C,Humi:55%,Press:100.1KPa **LISN** : 2018 ENV216/NEUTRAL
Memo : Original battery (Factory 2)

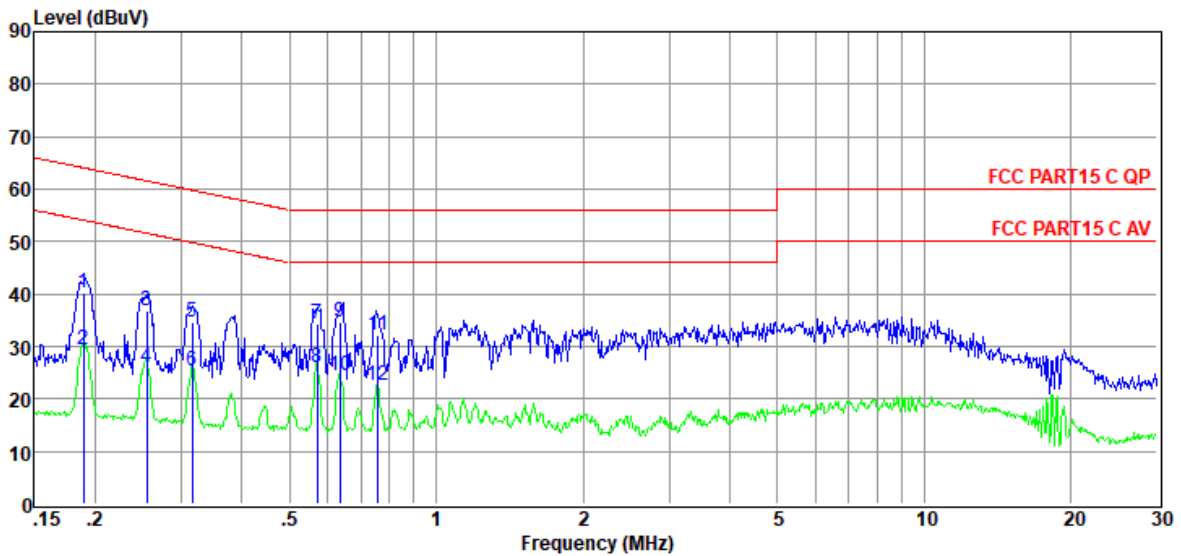

Item	Freq.	Read Level	LISN Factor	Cable Loss	Pulse Limiter Factor	Result Level	Limit Line	Over Limit	Detector	Phase
(Mark)	(MHz)	(dBμV)	(dB)	(dB)	(dB)	(dBμV)	(dBμV)	(dB)		
1	0.19	20.59	9.64	0.02	9.86	40.11	64.06	-23.95	QP	NEUTRAL
2	0.19	9.78	9.64	0.02	9.86	29.30	54.06	-24.76	Average	NEUTRAL
3	0.25	17.29	9.64	0.02	9.86	36.81	61.60	-24.79	QP	NEUTRAL
4	0.25	6.48	9.64	0.02	9.86	26.00	51.60	-25.60	Average	NEUTRAL
5	0.32	14.99	9.64	0.02	9.86	34.51	59.80	-25.29	QP	NEUTRAL
6	0.32	5.79	9.64	0.02	9.86	25.31	49.80	-24.49	Average	NEUTRAL
7	0.57	14.74	9.64	0.03	9.86	34.27	56.00	-21.73	QP	NEUTRAL
8	0.57	6.43	9.64	0.03	9.86	25.96	46.00	-20.04	Average	NEUTRAL
9	0.63	14.98	9.64	0.03	9.86	34.51	56.00	-21.49	QP	NEUTRAL
10	0.63	5.05	9.64	0.03	9.86	24.58	46.00	-21.42	Average	NEUTRAL
11	0.76	12.55	9.64	0.04	9.86	32.09	56.00	-23.91	QP	NEUTRAL
12	0.76	2.89	9.64	0.04	9.86	22.43	46.00	-23.57	Average	NEUTRAL

- Note: 1. Result Level = Read Level + LISN Factor + Pulse Limiter Factor + Cable loss.
 2. If QP Result complies with AV limit, AV Result is deemed to comply with AV limit.
 3. Test setup: RBW: 200 Hz (9 kHz—150 kHz), 9 kHz (150 kHz—30 MHz).
 4. Step size: 80Hz (0.009MHz-0.15MHz), 4 kHz (0.15MHz-30MHz), Scan time: auto

TR-4-E-010 Conducted Emission Test Result

Test Site : DDT 1# Shield Room D:\2018 CE report data\Q18112311-5E\CE.EM6
Test Date : 2019-01-14 **Tested By** : Aaron
EUT : PORTABLE BLUETOOTH SPEAKER **Model Number** : FLIP5
Power Supply : AC 120V/60Hz **Test Mode** : Tx mode
Condition : Temp:24.5°C,Humi:55%,Press:100.1KPa **LISN** : 2018 ENV216/NEUTRAL
Memo : Original battery (Factory 3)

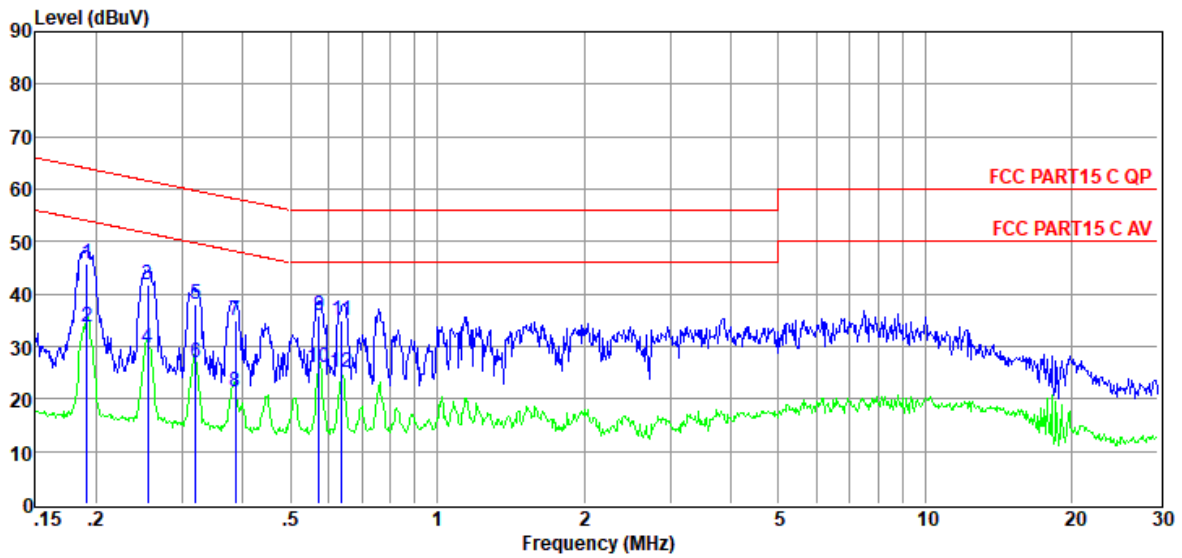

Item	Freq.	Read Level	LISN Factor	Cable Loss	Pulse Limiter Factor	Result Level	Limit Line	Over Limit	Detector	Phase
(Mark)	(MHz)	(dBμV)	(dB)	(dB)	(dB)	(dBμV)	(dBμV)	(dB)		
1	0.19	26.17	9.64	0.02	9.86	45.69	63.98	-18.29	QP	NEUTRAL
2	0.19	14.29	9.64	0.02	9.86	33.81	53.98	-20.17	Average	NEUTRAL
3	0.25	22.30	9.64	0.02	9.86	41.82	61.60	-19.78	QP	NEUTRAL
4	0.25	10.31	9.64	0.02	9.86	29.83	51.60	-21.77	Average	NEUTRAL
5	0.32	18.64	9.64	0.02	9.86	38.16	59.71	-21.55	QP	NEUTRAL
6	0.32	7.47	9.64	0.02	9.86	26.99	49.71	-22.72	Average	NEUTRAL
7	0.39	15.41	9.64	0.02	9.86	34.93	58.17	-23.24	QP	NEUTRAL
8	0.39	1.96	9.64	0.02	9.86	21.48	48.17	-26.69	Average	NEUTRAL
9	0.57	16.40	9.64	0.03	9.86	35.93	56.00	-20.07	QP	NEUTRAL
10	0.57	6.31	9.64	0.03	9.86	25.84	46.00	-20.16	Average	NEUTRAL
11	0.64	15.31	9.64	0.03	9.86	34.84	56.00	-21.16	QP	NEUTRAL
12	0.64	5.56	9.64	0.03	9.86	25.09	46.00	-20.91	Average	NEUTRAL

- Note: 1. Result Level = Read Level + LISN Factor + Pulse Limiter Factor + Cable loss.
 2. If QP Result complies with AV limit, AV Result is deemed to comply with AV limit.
 3. Test setup: RBW: 200 Hz (9 kHz—150 kHz), 9 kHz (150 kHz—30 MHz).
 4. Step size: 80Hz (0.009MHz-0.15MHz), 4 kHz (0.15MHz-30MHz), Scan time: auto.

TR-4-E-010 Conducted Emission Test Result

Test Site : DDT 1# Shield Room **D:\2018 CE report data\Q18112311-5E\CE.EM6**
Test Date : 2019-01-14 **Tested By** : Aaron
EUT : PORTABLE BLUETOOTH SPEAKER **Model Number** : FLIP5
Power Supply : AC 120V/60Hz **Test Mode** : Tx mode
Condition : Temp:24.5°C,Humi:55%,Press:100.1KPa **LISN** : 2018 ENV216/LINE
Memo : Original battery (Factory 3)

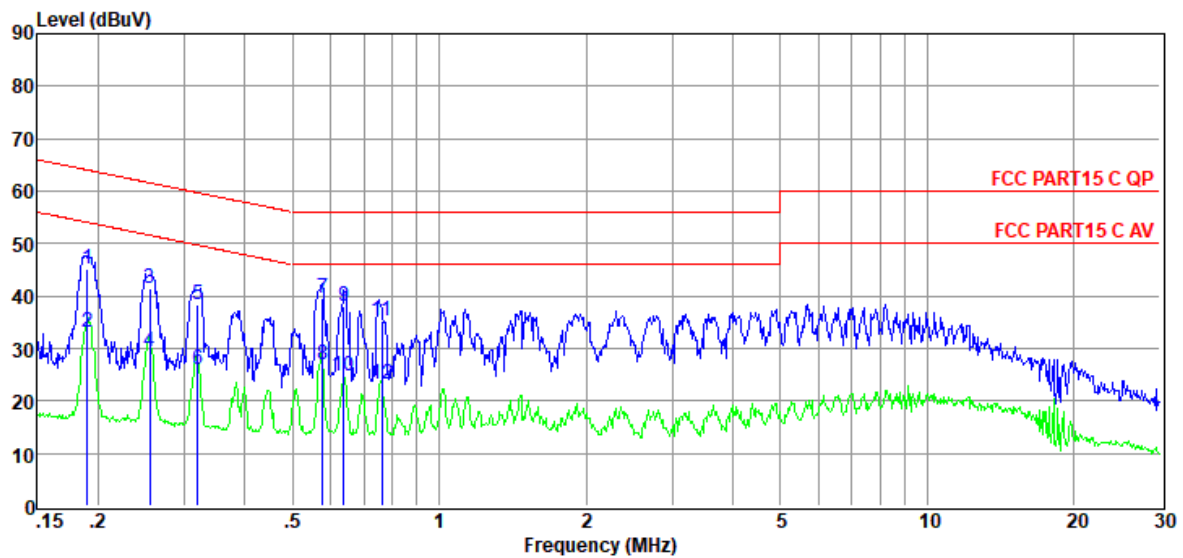

Item (Mark)	Freq. (MHz)	Read Level (dB μ V)	LISN Factor (dB)	Cable Loss (dB)	Pulse Limiter Factor (dB)	Result Level (dB μ V)	Limit Line (dB μ V)	Over Limit (dB)	Detector	Phase
1	0.19	25.63	9.63	0.02	9.86	45.14	64.02	-18.88	QP	LINE
2	0.19	13.68	9.63	0.02	9.86	33.19	54.02	-20.83	Average	LINE
3	0.25	22.07	9.63	0.02	9.86	41.58	61.60	-20.02	QP	LINE
4	0.25	9.74	9.63	0.02	9.86	29.25	51.60	-22.35	Average	LINE
5	0.32	18.82	9.63	0.02	9.86	38.33	59.71	-21.38	QP	LINE
6	0.32	6.52	9.63	0.02	9.86	26.03	49.71	-23.68	Average	LINE
7	0.58	20.10	9.64	0.03	9.86	39.63	56.00	-16.37	QP	LINE
8	0.58	7.48	9.64	0.03	9.86	27.01	46.00	-18.99	Average	LINE
9	0.64	18.53	9.64	0.03	9.86	38.06	56.00	-17.94	QP	LINE
10	0.64	5.20	9.64	0.03	9.86	24.73	46.00	-21.27	Average	LINE
11	0.76	15.75	9.64	0.04	9.86	35.29	56.00	-20.71	QP	LINE
12	0.76	3.76	9.64	0.04	9.86	23.30	46.00	-22.70	Average	LINE

Note: 1. Result Level = Read Level + LISN Factor + Pulse Limiter Factor + Cable loss.

2. If QP Result complies with AV limit, AV Result is deemed to comply with AV limit.

3. Test setup: RBW: 200 Hz (9 kHz—150 kHz), 9 kHz (150 kHz—30 MHz).

4. Step size: 80Hz (0.009MHz-0.15MHz), 4 kHz (0.15MHz-30MHz), Scan time: auto.

TR-4-E-010 Conducted Emission Test Result

Test Site : DDT 1# Shield Room D:\2018 CE report data\Q18112311-10E Flip5\CE.EM6
Test Date : 2019-03-21 **Tested By** : Only
EUT : PORTABLE BLUETOOTH SPEAKER **Model Number** : FLIP5
Power Supply : Battery **Test Mode** : Tx mode
Condition : Temp:24.5°C,Humi:55%,Press:100.1kPa **LISN** : 2018 ENV216/NEUTRAL
Memo : New battery model

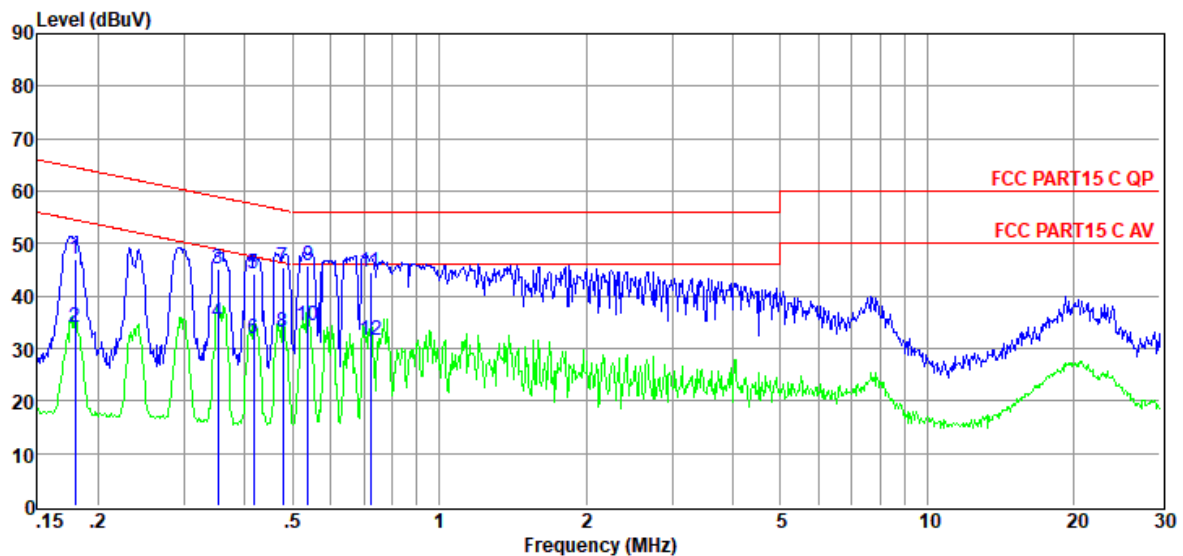

Item (Mark)	Freq. (MHz)	Read Level (dBμV)	LISN Factor (dB)	Cable Loss (dB)	Pulse Limiter Factor (dB)	Result Level (dBμV)	Limit Line (dBμV)	Over Limit (dB)	Detector	Phase
1	0.18	27.49	9.64	0.02	9.86	47.01	64.50	-17.49	QP	NEUTRAL
2	0.18	14.37	9.64	0.02	9.86	33.89	54.50	-20.61	Average	NEUTRAL
3	0.35	25.63	9.64	0.02	9.86	45.15	58.91	-13.76	QP	NEUTRAL
4	0.35	15.33	9.64	0.02	9.86	34.85	48.91	-14.06	Average	NEUTRAL
5	0.42	24.67	9.64	0.02	9.86	44.19	57.51	-13.32	QP	NEUTRAL
6	0.42	12.44	9.64	0.02	9.86	31.96	47.51	-15.55	Average	NEUTRAL
7	0.48	25.91	9.64	0.02	9.86	45.43	56.36	-10.93	QP	NEUTRAL
8	0.48	13.68	9.64	0.02	9.86	33.20	46.36	-13.16	Average	NEUTRAL
9	0.54	26.24	9.64	0.02	9.86	45.76	56.00	-10.24	QP	NEUTRAL
10	0.54	14.88	9.64	0.02	9.86	34.40	46.00	-11.60	Average	NEUTRAL
11	0.72	25.07	9.64	0.04	9.86	44.61	56.00	-11.39	QP	NEUTRAL
12	0.72	11.97	9.64	0.04	9.86	31.51	46.00	-14.49	Average	NEUTRAL

Note: 1. Result Level = Read Level + LISN Factor + Pulse Limiter Factor + Cable loss.

2. If QP Result complies with AV limit, AV Result is deemed to comply with AV limit.

3. Test setup: RBW: 200 Hz (9 kHz—150 kHz), 9 kHz (150 kHz—30 MHz).

4. Step size: 80Hz (0.009MHz-0.15MHz), 4 kHz (0.15MHz-30MHz), Scan time: auto.

TR-4-E-010 Conducted Emission Test Result

Test Site : DDT 1# Shield Room D:\2018 CE report data\Q18112311-10E Flip5\CE.EM6
Test Date : 2019-03-21 **Tested By** : Only
EUT : PORTABLE BLUETOOTH SPEAKER **Model Number** : FLIP5
Power Supply : Battery **Test Mode** : Tx mode
Condition : Temp:24.5°C,Humi:55%,Press:100.1kPa **LISN** : 2018 ENV216/LINE
Memo : New battery model

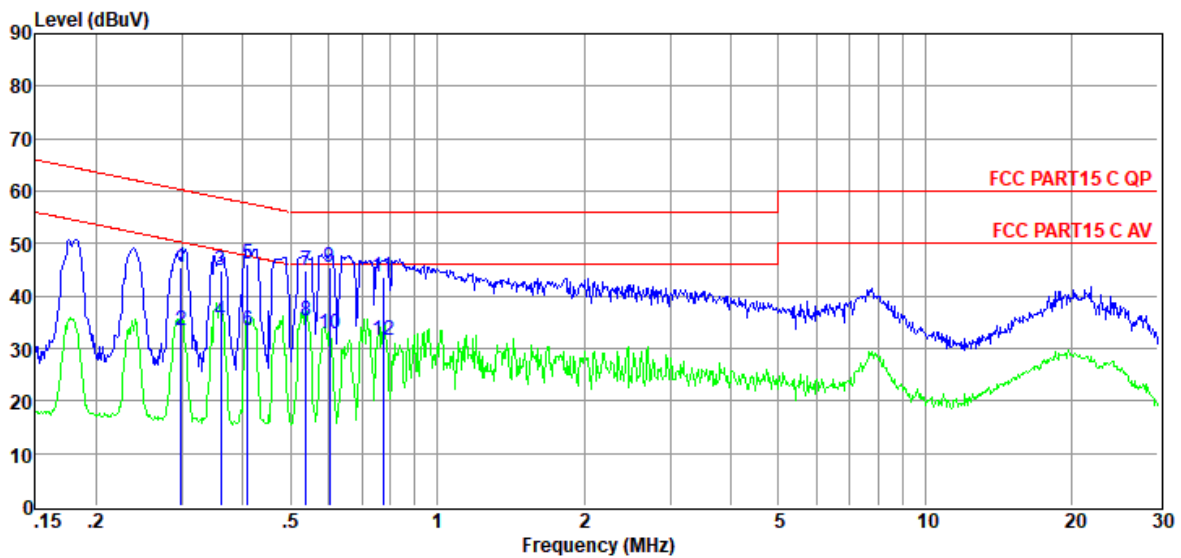

Item	Freq.	Read Level	LISN Factor	Cable Loss	Pulse Limiter Factor	Result Level	Limit Line	Over Limit	Detector	Phase
(Mark)	(MHz)	(dBμV)	(dB)	(dB)	(dB)	(dBμV)	(dBμV)	(dB)		
1	0.30	26.05	9.63	0.02	9.86	45.56	60.28	-14.72	QP	LINE
2	0.30	13.87	9.63	0.02	9.86	33.38	50.28	-16.90	Average	LINE
3	0.36	25.34	9.63	0.02	9.86	44.85	58.74	-13.89	QP	LINE
4	0.36	15.87	9.63	0.02	9.86	35.38	48.74	-13.36	Average	LINE
5	0.41	26.41	9.64	0.02	9.86	45.93	57.68	-11.75	QP	LINE
6	0.41	13.78	9.64	0.02	9.86	33.30	47.68	-14.38	Average	LINE
7	0.54	25.47	9.64	0.02	9.86	44.99	56.00	-11.01	QP	LINE
8	0.54	15.71	9.64	0.02	9.86	35.23	46.00	-10.77	Average	LINE
9	0.60	25.90	9.64	0.03	9.86	45.43	56.00	-10.57	QP	LINE
10	0.60	13.12	9.64	0.03	9.86	32.65	46.00	-13.35	Average	LINE
11	0.78	24.08	9.64	0.05	9.86	43.63	56.00	-12.37	QP	LINE
12	0.78	12.05	9.64	0.05	9.86	31.60	46.00	-14.40	Average	LINE

Note: 1. Result Level = Read Level + LISN Factor + Pulse Limiter Factor + Cable loss.

2. If QP Result complies with AV limit, AV Result is deemed to comply with AV limit.

3. Test setup: RBW: 200 Hz (9 kHz—150 kHz), 9 kHz (150 kHz—30 MHz).

4. Step size: 80Hz (0.009MHz-0.15MHz), 4 kHz (0.15MHz-30MHz), Scan time: auto.

TR-4-E-010 Conducted Emission Test Result

Test Site : DDT 1# Shield Room D:\2019 CE report data\Q19103116-7E\1218 TCL 报备三星电
Test Date : 2019-12-18 **Tested By** : Huang
EUT : PORTABLE BLUETOOTH SPEAKER **Model Number** : FLIP5
Power Supply : AC 120V/60Hz **Test Mode** : Tx mdoe
Condition : Temp:24.5°C,Humi:55%,Press:101.4KPa **LISN** : 2018 ENV216/NEUTRAL
Memo : IAA031NA (Factory 1)

Data: 78

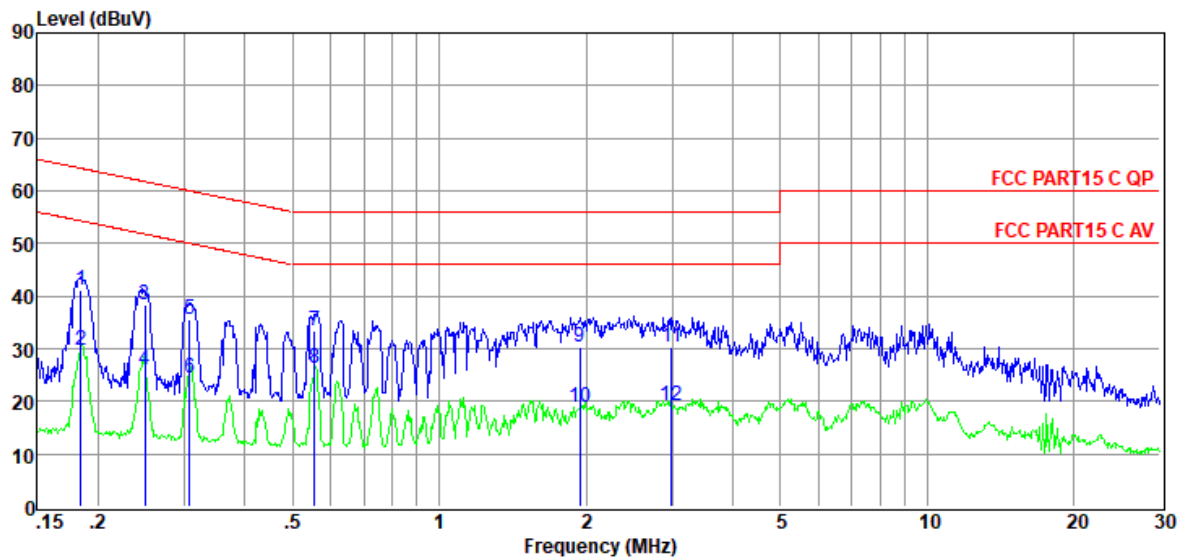

Item (Mark)	Freq. (MHz)	Read Level (dB μ V)	LISN Factor (dB)	Cable Loss (dB)	Pulse Limiter Factor (dB)	Result Level (dB μ V)	Limit Line (dB μ V)	Over Limit (dB)	Detector	Phase
1	0.18	41.09	0.00	0.00	0.00	41.09	64.28	-23.19	QP	NEUTRAL
2	0.18	29.73	0.00	0.00	0.00	29.73	54.28	-24.55	Average	NEUTRAL
3	0.25	38.26	0.00	0.00	0.00	38.26	61.78	-23.52	QP	NEUTRAL
4	0.25	26.10	0.00	0.00	0.00	26.10	51.78	-25.68	Average	NEUTRAL
5	0.31	35.61	0.00	0.00	0.00	35.61	60.02	-24.41	QP	NEUTRAL
6	0.31	24.50	0.00	0.00	0.00	24.50	50.02	-25.52	Average	NEUTRAL
7	0.56	33.40	0.00	0.00	0.00	33.40	56.00	-22.60	QP	NEUTRAL
8	0.56	26.26	0.00	0.00	0.00	26.26	46.00	-19.74	Average	NEUTRAL
9	1.94	30.23	0.00	0.00	0.00	30.23	56.00	-25.77	QP	NEUTRAL
10	1.94	18.81	0.00	0.00	0.00	18.81	46.00	-27.19	Average	NEUTRAL
11	2.99	30.16	0.00	0.00	0.00	30.16	56.00	-25.84	QP	NEUTRAL
12	2.99	19.15	0.00	0.00	0.00	19.15	46.00	-26.85	Average	NEUTRAL

Note: 1. Result Level = Read Level + LISN Factor + Pulse Limiter Factor + Cable loss.

2. If QP Result complies with AV limit, AV Result is deemed to comply with AV limit.

3. Test setup: RBW: 200 Hz (9 kHz—150 kHz), 9 kHz (150 kHz—30 MHz).

4. Step size: 80Hz (0.009MHz-0.15MHz), 4 kHz (0.15MHz-30MHz), Scan time: auto.

TR-4-E-010 Conducted Emission Test Result

Test Site : DDT 1# Shield Room D:\2019 CE report data\Q19103116-7E\1218 TCL 报备三星电
Test Date : 2019-12-18 **Tested By** : Huang
EUT : PORTABLE BLUETOOTH SPEAKER **Model Number** : FLIP5
Power Supply : AC 120V/60Hz **Test Mode** : Tx mdoe
Condition : Temp:24.5°C,Humi:55%,Press:101.4KPa **LISN** : 2018 ENV216/LINE
Memo : IAA031NA (Factory 1)

Data: 79

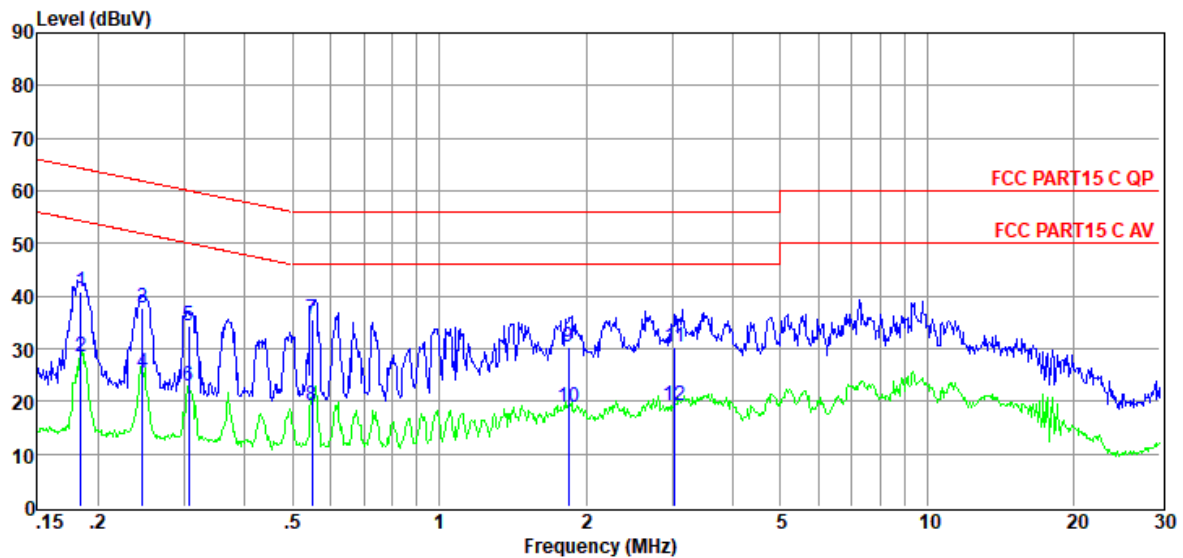

Item (Mark)	Freq. (MHz)	Read Level (dB μ V)	LISN Factor (dB)	Cable Loss (dB)	Pulse Limiter Factor (dB)	Result Level (dB μ V)	Limit Line (dB μ V)	Over Limit (dB)	Detector	Phase
1	0.18	40.87	0.00	0.00	0.00	40.87	64.28	-23.41	QP	LINE
2	0.18	28.48	0.00	0.00	0.00	28.48	54.28	-25.80	Average	LINE
3	0.25	37.82	0.00	0.00	0.00	37.82	61.86	-24.04	QP	LINE
4	0.25	25.32	0.00	0.00	0.00	25.32	51.86	-26.54	Average	LINE
5	0.31	34.25	0.00	0.00	0.00	34.25	60.06	-25.81	QP	LINE
6	0.31	22.89	0.00	0.00	0.00	22.89	50.06	-27.17	Average	LINE
7	0.55	35.46	0.00	0.00	0.00	35.46	56.00	-20.54	QP	LINE
8	0.55	19.15	0.00	0.00	0.00	19.15	46.00	-26.85	Average	LINE
9	1.84	30.43	0.00	0.00	0.00	30.43	56.00	-25.57	QP	LINE
10	1.84	18.83	0.00	0.00	0.00	18.83	46.00	-27.17	Average	LINE
11	3.04	30.21	0.00	0.00	0.00	30.21	56.00	-25.79	QP	LINE
12	3.04	19.19	0.00	0.00	0.00	19.19	46.00	-26.81	Average	LINE

Note: 1. Result Level = Read Level + LISN Factor + Pulse Limiter Factor + Cable loss.

2. If QP Result complies with AV limit, AV Result is deemed to comply with AV limit.

3. Test setup: RBW: 200 Hz (9 kHz—150 kHz), 9 kHz (150 kHz—30 MHz).

4. Step size: 80Hz (0.009MHz-0.15MHz), 4 kHz (0.15MHz-30MHz), Scan time: auto.

TR-4-E-010 Conducted Emission Test Result

Test Site : DDT 1# Shield Room D:\2019 CE report data\Q19103116-4E\1218 国光报备三星电
Test Date : 2019-12-18 **Tested By** : Huang
EUT : PORTABLE BLUETOOTH SPEAKER **Model Number** : FLIP5
Power Supply : AC 120V/60Hz **Test Mode** : Tx mode
Condition : Temp:24.5°C,Humi:55%,Press:101.4KPa **LISN** : 2018 ENV216/NEUTRAL
Memo : IAA031NA (Factory 2)

Data: 10

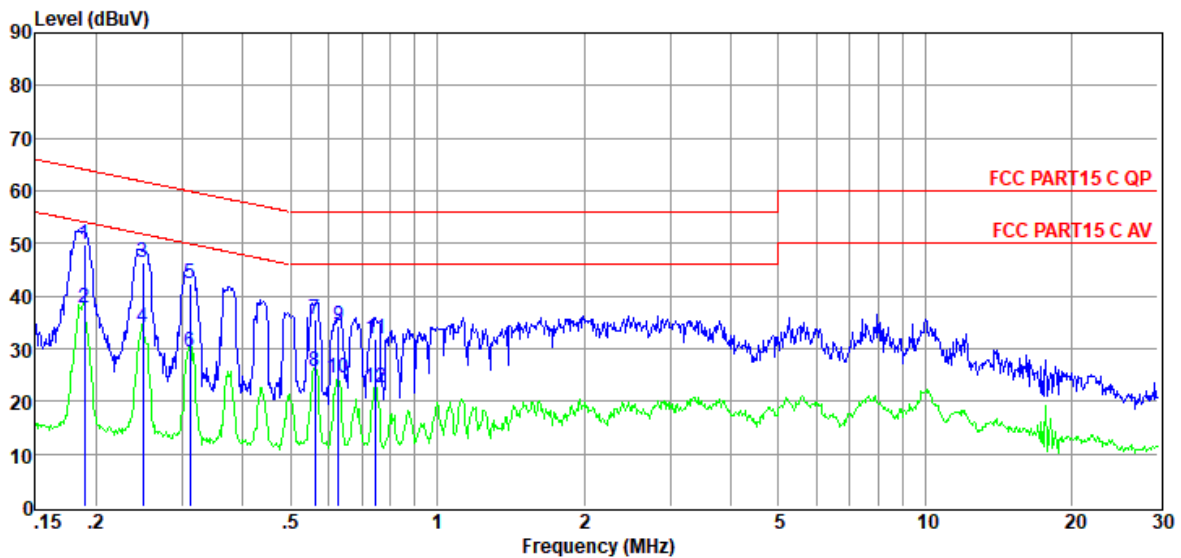

Item (Mark)	Freq. (MHz)	Read Level (dBμV)	LISN Factor (dB)	Cable Loss (dB)	Pulse Limiter Factor (dB)	Result Level (dBμV)	Limit Line (dBμV)	Over Limit (dB)	Detector	Phase
1	0.19	30.35	9.64	0.02	9.86	49.87	64.06	-14.19	QP	NEUTRAL
2	0.19	18.33	9.64	0.02	9.86	37.85	54.06	-16.21	Average	NEUTRAL
3	0.25	26.84	9.64	0.02	9.86	46.36	61.78	-15.42	QP	NEUTRAL
4	0.25	14.49	9.64	0.02	9.86	34.01	51.78	-17.77	Average	NEUTRAL
5	0.31	22.98	9.64	0.02	9.86	42.50	59.93	-17.43	QP	NEUTRAL
6	0.31	9.94	9.64	0.02	9.86	29.46	49.93	-20.47	Average	NEUTRAL
7	0.56	16.19	9.64	0.03	9.86	35.72	56.00	-20.28	QP	NEUTRAL
8	0.56	6.04	9.64	0.03	9.86	25.57	46.00	-20.43	Average	NEUTRAL
9	0.63	14.73	9.64	0.03	9.86	34.26	56.00	-21.74	QP	NEUTRAL
10	0.63	4.81	9.64	0.03	9.86	24.34	46.00	-21.66	Average	NEUTRAL
11	0.75	12.20	9.64	0.04	9.86	31.74	56.00	-24.26	QP	NEUTRAL
12	0.75	3.02	9.64	0.04	9.86	22.56	46.00	-23.44	Average	NEUTRAL

Note: 1. Result Level = Read Level + LISN Factor + Pulse Limiter Factor + Cable loss.

2. If QP Result complies with AV limit, AV Result is deemed to comply with AV limit.

3. Test setup: RBW: 200 Hz (9 kHz—150 kHz), 9 kHz (150 kHz—30 MHz).

4. Step size: 80Hz (0.009MHz-0.15MHz), 4 kHz (0.15MHz-30MHz), Scan time: auto.

TR-4-E-010 Conducted Emission Test Result

Test Site : DDT 1# Shield Room D:\2019 CE report data\Q19103116-4E\1218 国光报备三星电
Test Date : 2019-12-18 **Tested By** : Huang
EUT : PORTABLE BLUETOOTH SPEAKER **Model Number** : FLIP5
Power Supply : AC 120V/60Hz **Test Mode** : Tx mode
Condition : Temp:24.5°C,Humi:55%,Press:101.4KPa **LISN** : 2018 ENV216/LINE
Memo : IAA031NA (Factory 2)

Data: 12

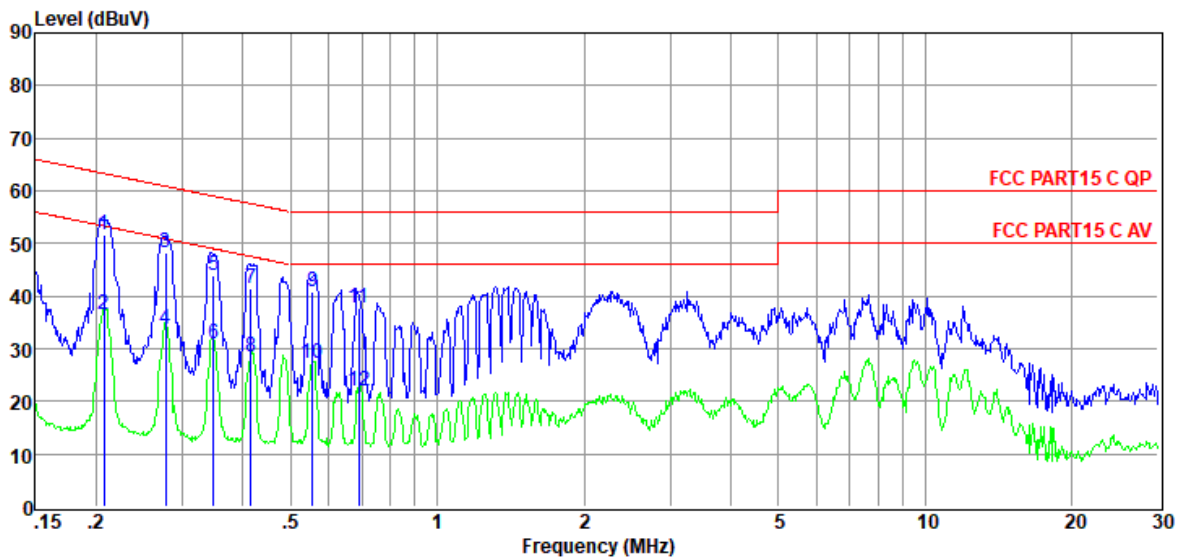

Item (Mark)	Freq. (MHz)	Read Level (dBuV)	LISN Factor (dB)	Cable Loss (dB)	Pulse Limiter Factor (dB)	Result Level (dBuV)	Limit Line (dBuV)	Over Limit (dB)	Detector	Phase
1	0.21	32.28	9.63	0.02	9.86	51.79	63.32	-11.53	QP	LINE
2	0.21	16.88	9.63	0.02	9.86	36.39	53.32	-16.93	Average	LINE
3	0.28	28.74	9.63	0.02	9.86	48.25	60.90	-12.65	QP	LINE
4	0.28	14.13	9.63	0.02	9.86	33.64	50.90	-17.26	Average	LINE
5	0.35	24.43	9.63	0.02	9.86	43.94	59.00	-15.06	QP	LINE
6	0.35	11.40	9.63	0.02	9.86	30.91	49.00	-18.09	Average	LINE
7	0.41	22.01	9.64	0.02	9.86	41.53	57.55	-16.02	QP	LINE
8	0.41	8.89	9.64	0.02	9.86	28.41	47.55	-19.14	Average	LINE
9	0.56	21.31	9.64	0.03	9.86	40.84	56.00	-15.16	QP	LINE
10	0.56	7.54	9.64	0.03	9.86	27.07	46.00	-18.93	Average	LINE
11	0.69	18.20	9.64	0.04	9.86	37.74	56.00	-18.26	QP	LINE
12	0.69	2.52	9.64	0.04	9.86	22.06	46.00	-23.94	Average	LINE

Note: 1. Result Level = Read Level + LISN Factor + Pulse Limiter Factor + Cable loss.

2. If QP Result complies with AV limit, AV Result is deemed to comply with AV limit.

3. Test setup: RBW: 200 Hz (9 kHz—150 kHz), 9 kHz (150 kHz—30 MHz).

4. Step size: 80Hz (0.009MHz-0.15MHz), 4 kHz (0.15MHz-30MHz), Scan time: auto.

TR-4-E-010 Conducted Emission Test Result

Test Site : DDT 1# Shield Room D:\2019 CE report data\Q19103116-4E\1218 CE.EM6
Test Date : 2019-12-18 **Tested By** : Huang
EUT : PORTABLE BLUETOOTH SPEAKER **Model Number** : FLIP5
Power Supply : AC 120V/60Hz **Test Mode** : Tx mode
Condition : Temp:24.5°C,Humi:55%,Press:101.4KPa **LISN** : 2018 ENV216/LINE
Memo : SUN-INTE-276 (Factory 3)

Data: 14

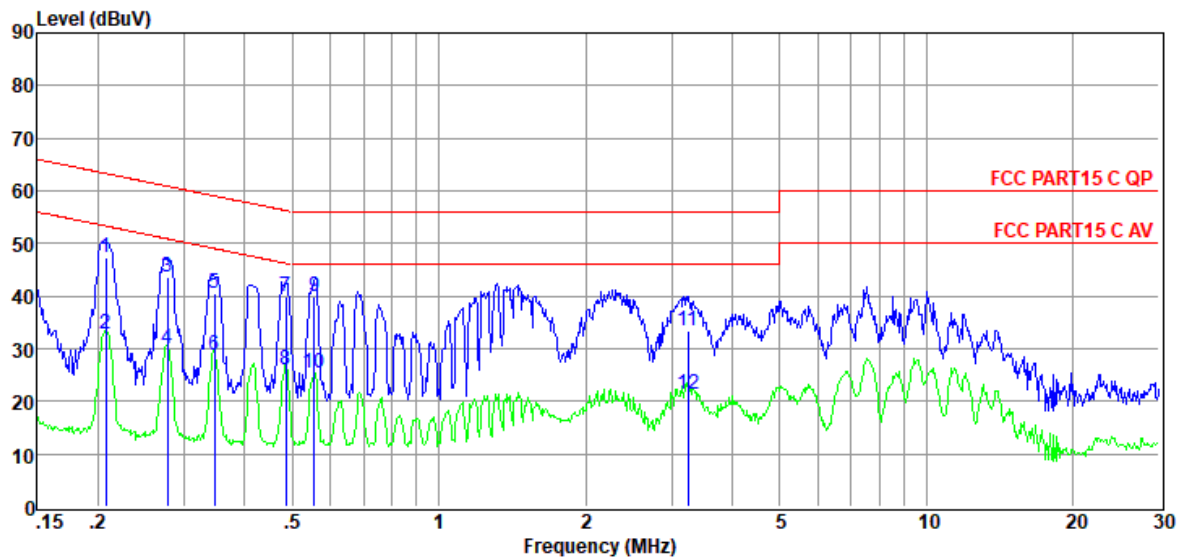

Item (Mark)	Freq. (MHz)	Read Level (dB μ V)	LISN Factor (dB)	Cable Loss (dB)	Pulse Limiter Factor (dB)	Result Level (dB μ V)	Limit Line (dB μ V)	Over Limit (dB)	Detector	Phase
1	0.21	27.69	9.63	0.02	9.86	47.20	63.32	-16.12	QP	LINE
2	0.21	13.20	9.63	0.02	9.86	32.71	53.32	-20.61	Average	LINE
3	0.28	24.18	9.63	0.02	9.86	43.69	60.90	-17.21	QP	LINE
4	0.28	10.56	9.63	0.02	9.86	30.07	50.90	-20.83	Average	LINE
5	0.35	20.95	9.63	0.02	9.86	40.46	59.05	-18.59	QP	LINE
6	0.35	9.25	9.63	0.02	9.86	28.76	49.05	-20.29	Average	LINE
7	0.49	20.26	9.64	0.02	9.86	39.78	56.23	-16.45	QP	LINE
8	0.49	6.54	9.64	0.02	9.86	26.06	46.23	-20.17	Average	LINE
9	0.56	20.50	9.64	0.03	9.86	40.03	56.00	-15.97	QP	LINE
10	0.56	5.80	9.64	0.03	9.86	25.33	46.00	-20.67	Average	LINE
11	3.24	13.83	9.67	0.04	9.87	33.41	56.00	-22.59	QP	LINE
12	3.24	1.82	9.67	0.04	9.87	21.40	46.00	-24.60	Average	LINE

Note: 1. Result Level = Read Level + LISN Factor + Pulse Limiter Factor + Cable loss.

2. If QP Result complies with AV limit, AV Result is deemed to comply with AV limit.

3. Test setup: RBW: 200 Hz (9 kHz—150 kHz), 9 kHz (150 kHz—30 MHz).

4. Step size: 80Hz (0.009MHz-0.15MHz), 4 kHz (0.15MHz-30MHz), Scan time: auto.

TR-4-E-010 Conducted Emission Test Result

Test Site : DDT 1# Shield Room D:\2019 CE report data\Q19103116-4E\1218CE.EM6
Test Date : 2019-12-18 **Tested By** : Huang
EUT : PORTABLE BLUETOOTH SPEAKER **Model Number** : FLIP5
Power Supply : AC 120V/60Hz **Test Mode** : Tx mode
Condition : Temp:24.5°C,Humi:55%,Press:101.4KPa **LISN** : 2018 ENV216/NEUTRAL
Memo : SUN-INTE-276 (Factory 3)

Data: 16

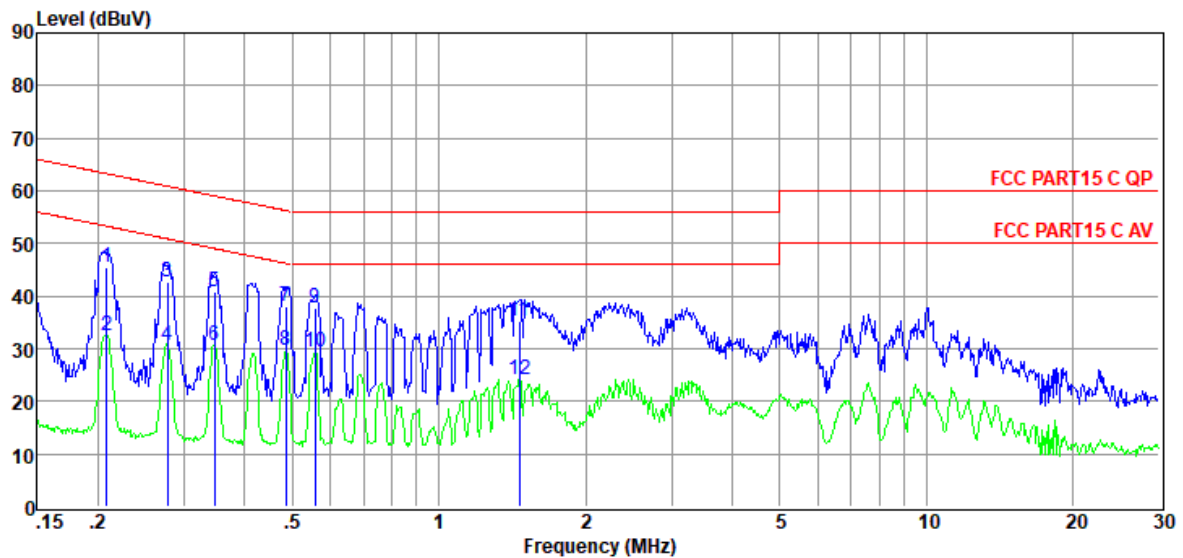

Item (Mark)	Freq. (MHz)	Read Level (dB μ V)	LISN Factor (dB)	Cable Loss (dB)	Pulse Limiter Factor (dB)	Result Level (dB μ V)	Limit Line (dB μ V)	Over Limit (dB)	Detector	Phase
1	0.21	25.80	9.64	0.02	9.86	45.32	63.27	-17.95	QP	NEUTRAL
2	0.21	12.87	9.64	0.02	9.86	32.39	53.27	-20.88	Average	NEUTRAL
3	0.28	23.31	9.64	0.02	9.86	42.83	60.90	-18.07	QP	NEUTRAL
4	0.28	11.00	9.64	0.02	9.86	30.52	50.90	-20.38	Average	NEUTRAL
5	0.35	21.22	9.64	0.02	9.86	40.74	59.05	-18.31	QP	NEUTRAL
6	0.35	11.18	9.64	0.02	9.86	30.70	49.05	-18.35	Average	NEUTRAL
7	0.49	18.59	9.64	0.02	9.86	38.11	56.23	-18.12	QP	NEUTRAL
8	0.49	10.11	9.64	0.02	9.86	29.63	46.23	-16.60	Average	NEUTRAL
9	0.56	18.23	9.64	0.03	9.86	37.76	56.00	-18.24	QP	NEUTRAL
10	0.56	9.80	9.64	0.03	9.86	29.33	46.00	-16.67	Average	NEUTRAL
11	1.46	15.78	9.66	0.08	9.87	35.39	56.00	-20.61	QP	NEUTRAL
12	1.46	4.49	9.66	0.08	9.87	24.10	46.00	-21.90	Average	NEUTRAL

Note: 1. Result Level = Read Level + LISN Factor + Pulse Limiter Factor + Cable loss.

2. If QP Result complies with AV limit, AV Result is deemed to comply with AV limit.

3. Test setup: RBW: 200 Hz (9 kHz—150 kHz), 9 kHz (150 kHz—30 MHz).

4. Step size: 80Hz (0.009MHz-0.15MHz), 4 kHz (0.15MHz-30MHz), Scan time: auto.

TR-4-E-010 Conducted Emission Test Result

Test Site : DDT 1# Shield Room D:\2019 CE report data\Q19103116-4E\1218 CE.EM6
Test Date : 2019-12-18 **Tested By** : Huang
EUT : PORTABLE BLUETOOTH SPEAKER **Model Number** : FLIP5
Power Supply : AC 120V/60Hz **Test Mode** : Tx mode
Condition : Temp:24.5°C,Humi:55%,Press:101.4KPa **LISN** : 2018 ENV216/NEUTRAL
Memo : GSP-1S2P-F5A (Factory 3)

Data: 18

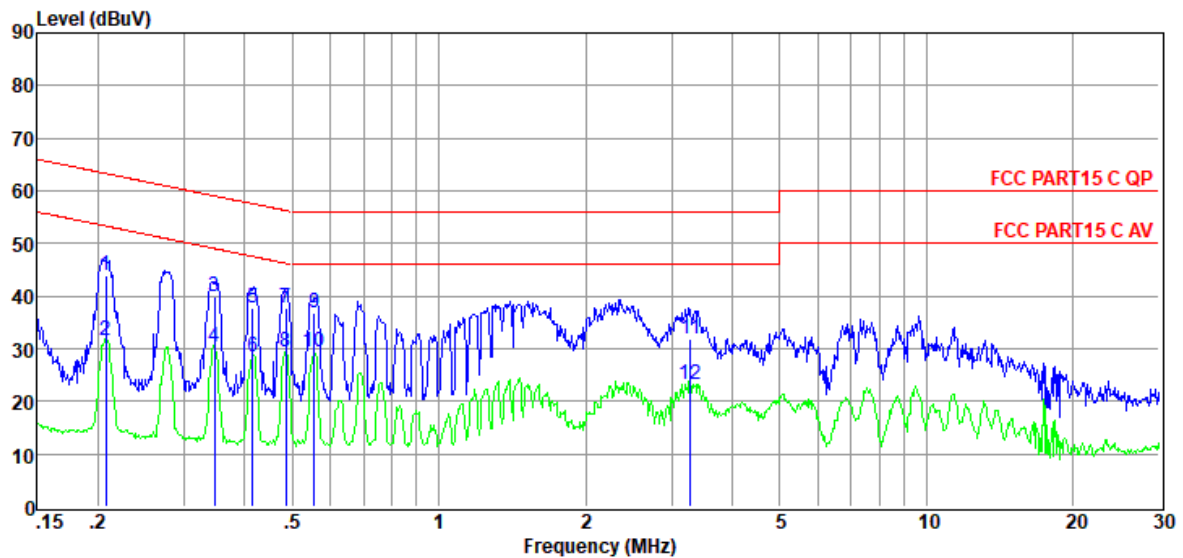

Item (Mark)	Freq. (MHz)	Read Level (dBμV)	LISN Factor (dB)	Cable Loss (dB)	Pulse Limiter Factor (dB)	Result Level (dBμV)	Limit Line (dBμV)	Over Limit (dB)	Detector	Phase
1	0.21	24.35	9.64	0.02	9.86	43.87	63.32	-19.45	QP	NEUTRAL
2	0.21	11.94	9.64	0.02	9.86	31.46	53.32	-21.86	Average	NEUTRAL
3	0.35	20.49	9.64	0.02	9.86	40.01	59.05	-19.04	QP	NEUTRAL
4	0.35	10.87	9.64	0.02	9.86	30.39	49.05	-18.66	Average	NEUTRAL
5	0.41	18.21	9.64	0.02	9.86	37.73	57.55	-19.82	QP	NEUTRAL
6	0.41	9.08	9.64	0.02	9.86	28.60	47.55	-18.95	Average	NEUTRAL
7	0.49	18.13	9.64	0.02	9.86	37.65	56.23	-18.58	QP	NEUTRAL
8	0.49	9.78	9.64	0.02	9.86	29.30	46.23	-16.93	Average	NEUTRAL
9	0.56	17.38	9.64	0.03	9.86	36.91	56.00	-19.09	QP	NEUTRAL
10	0.56	9.84	9.64	0.03	9.86	29.37	46.00	-16.63	Average	NEUTRAL
11	3.28	12.26	9.68	0.04	9.87	31.85	56.00	-24.15	QP	NEUTRAL
12	3.28	3.49	9.68	0.04	9.87	23.08	46.00	-22.92	Average	NEUTRAL

Note: 1. Result Level = Read Level + LISN Factor + Pulse Limiter Factor + Cable loss.

2. If QP Result complies with AV limit, AV Result is deemed to comply with AV limit.

3. Test setup: RBW: 200 Hz (9 kHz—150 kHz), 9 kHz (150 kHz—30 MHz).

4. Step size: 80Hz (0.009MHz-0.15MHz), 4 kHz (0.15MHz-30MHz), Scan time: auto.

TR-4-E-010 Conducted Emission Test Result

Test Site : DDT 1# Shield Room D:\2019 CE report data\Q19103116-4E\1218 CE.EM6
Test Date : 2019-12-18 **Tested By** : Huang
EUT : PORTABLE BLUETOOTH SPEAKER **Model Number** : FLIP5
Power Supply : AC 120V/60Hz **Test Mode** : Tx mode
Condition : Temp:24.5°C,Humi:55%,Press:101.4KPa **LISN** : 2018 ENV216/LINE
Memo : GSP-1S2P-F5A (Factory 3)

Data: 20

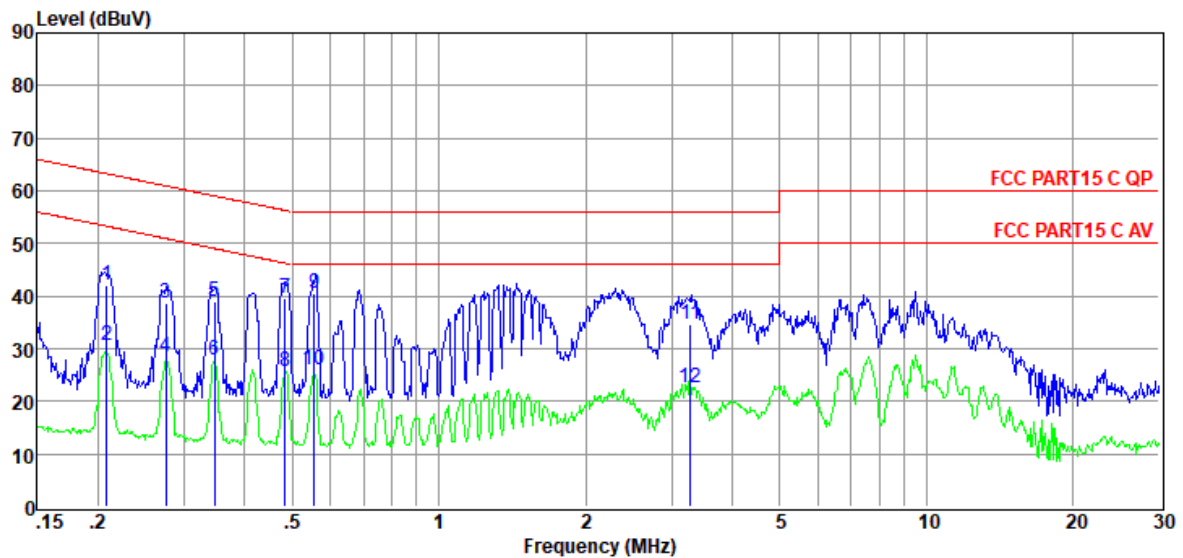

Item (Mark)	Freq. (MHz)	Read Level (dBμV)	LISN Factor (dB)	Cable Loss (dB)	Pulse Limiter Factor (dB)	Result Level (dBμV)	Limit Line (dBμV)	Over Limit (dB)	Detector	Phase
1	0.21	22.45	9.63	0.02	9.86	41.96	63.27	-21.31	QP	LINE
2	0.21	10.96	9.63	0.02	9.86	30.47	53.27	-22.80	Average	LINE
3	0.28	19.28	9.63	0.02	9.86	38.79	60.94	-22.15	QP	LINE
4	0.28	8.84	9.63	0.02	9.86	28.35	50.94	-22.59	Average	LINE
5	0.35	19.57	9.63	0.02	9.86	39.08	59.05	-19.97	QP	LINE
6	0.35	8.31	9.63	0.02	9.86	27.82	49.05	-21.23	Average	LINE
7	0.48	20.13	9.64	0.02	9.86	39.65	56.27	-16.62	QP	LINE
8	0.48	6.16	9.64	0.02	9.86	25.68	46.27	-20.59	Average	LINE
9	0.56	20.95	9.64	0.03	9.86	40.48	56.00	-15.52	QP	LINE
10	0.56	6.35	9.64	0.03	9.86	25.88	46.00	-20.12	Average	LINE
11	3.28	14.93	9.67	0.04	9.87	34.51	56.00	-21.49	QP	LINE
12	3.28	2.96	9.67	0.04	9.87	22.54	46.00	-23.46	Average	LINE

Note: 1. Result Level = Read Level + LISN Factor + Pulse Limiter Factor + Cable loss.

2. If QP Result complies with AV limit, AV Result is deemed to comply with AV limit.

3. Test setup: RBW: 200 Hz (9 kHz—150 kHz), 9 kHz (150 kHz—30 MHz).

4. Step size: 80Hz (0.009MHz-0.15MHz), 4 kHz (0.15MHz-30MHz), Scan time: auto.

TR-4-E-010 Conducted Emission Test Result

Test Site : DDT 1# Shield Room D:\2019 CE report data\Q19103116-4E\1218 国光报备三星电
Test Date : 2019-12-18 **Tested By** : Huang
EUT : PORTABLE BLUETOOTH SPEAKER **Model Number** : FLIP5
Power Supply : AC 120V/60Hz **Test Mode** : Tx mode
Condition : Temp:24.5°C,Humi:55%,Press:101.4KPa **LISN** : 2018 ENV216/LINE
Memo : GSP-1S2P-F5B (Factory 3)

Data: 22

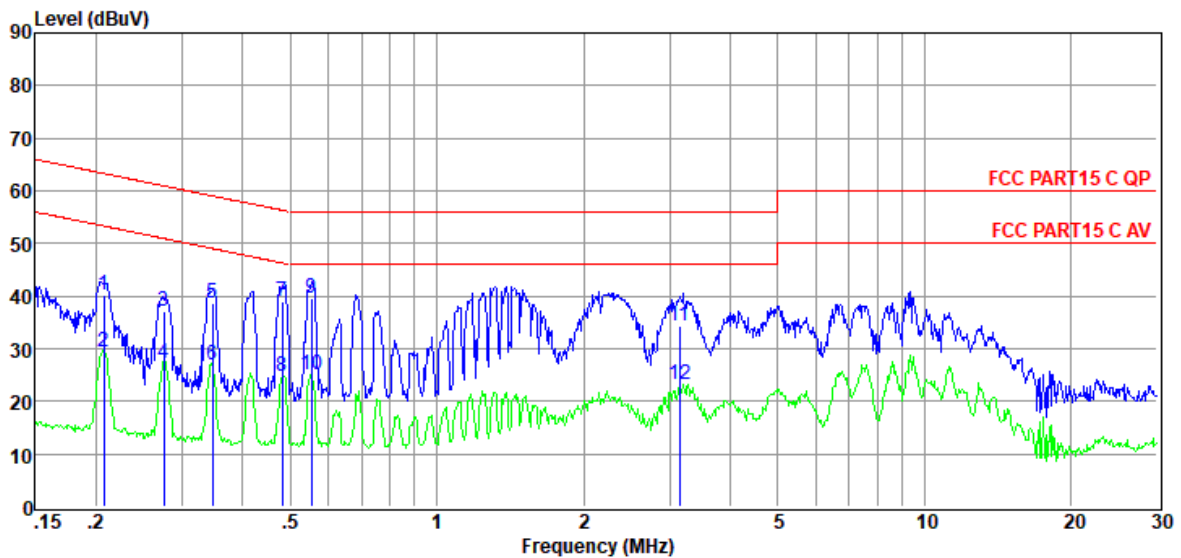

Item (Mark)	Freq. (MHz)	Read Level (dBuV)	LISN Factor (dB)	Cable Loss (dB)	Pulse Limiter Factor (dB)	Result Level (dBuV)	Limit Line (dBuV)	Over Limit (dB)	Detector	Phase
1	0.21	20.70	9.63	0.02	9.86	40.21	63.32	-23.11	QP	LINE
2	0.21	9.76	9.63	0.02	9.86	29.27	53.32	-24.05	Average	LINE
3	0.28	17.63	9.63	0.02	9.86	37.14	60.94	-23.80	QP	LINE
4	0.28	7.75	9.63	0.02	9.86	27.26	50.94	-23.68	Average	LINE
5	0.35	19.09	9.63	0.02	9.86	38.60	59.05	-20.45	QP	LINE
6	0.35	7.55	9.63	0.02	9.86	27.06	49.05	-21.99	Average	LINE
7	0.48	19.51	9.64	0.02	9.86	39.03	56.32	-17.29	QP	LINE
8	0.48	5.15	9.64	0.02	9.86	24.67	46.32	-21.65	Average	LINE
9	0.55	19.98	9.64	0.02	9.86	39.50	56.00	-16.50	QP	LINE
10	0.55	5.54	9.64	0.02	9.86	25.06	46.00	-20.94	Average	LINE
11	3.14	14.90	9.67	0.04	9.87	34.48	56.00	-21.52	QP	LINE
12	3.14	3.49	9.67	0.04	9.87	23.07	46.00	-22.93	Average	LINE

Note: 1. Result Level = Read Level + LISN Factor + Pulse Limiter Factor + Cable loss.

2. If QP Result complies with AV limit, AV Result is deemed to comply with AV limit.

3. Test setup: RBW: 200 Hz (9 kHz—150 kHz), 9 kHz (150 kHz—30 MHz).

4. Step size: 80Hz (0.009MHz-0.15MHz), 4 kHz (0.15MHz-30MHz), Scan time: auto.

TR-4-E-010 Conducted Emission Test Result

Test Site : DDT 1# Shield Room D:\2019 CE report data\Q19103116-4E\1218 CE.EM6
Test Date : 2019-12-18 **Tested By** : Huang
EUT : PORTABLE BLUETOOTH SPEAKER **Model Number** : FLIP5
Power Supply : AC 120V/60Hz **Test Mode** : Tx mode
Condition : Temp:24.5°C,Humi:55%,Press:101.4KPa **LISN** : 2018 ENV216/NEUTRAL
Memo : GSP-1S2P-F5B (Factory 3)

Data: 24

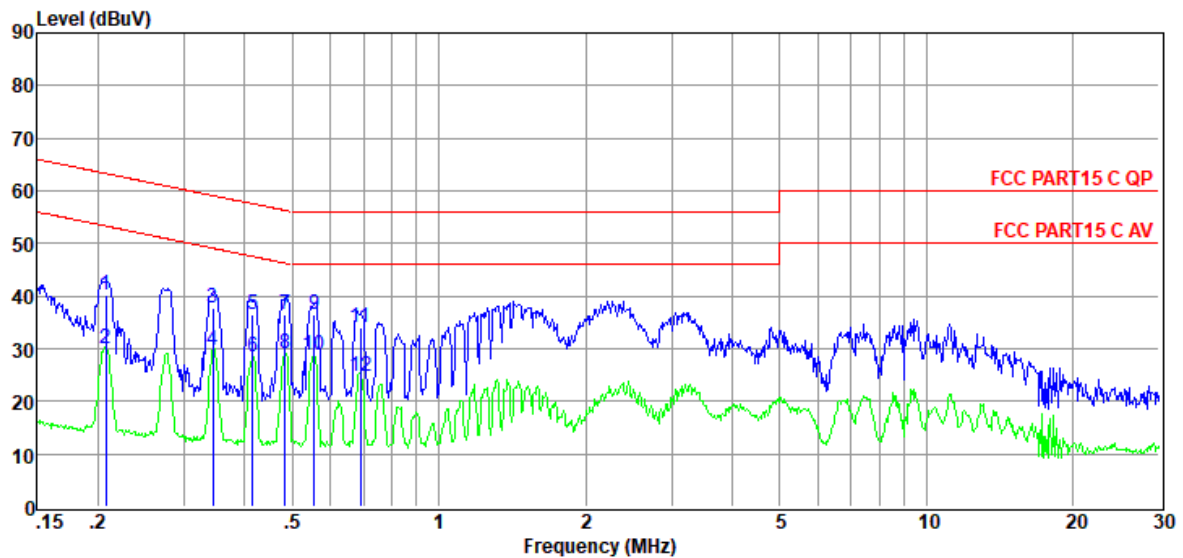

Item (Mark)	Freq. (MHz)	Read Level (dB μ V)	LISN Factor (dB)	Cable Loss (dB)	Pulse Limiter Factor (dB)	Result Level (dB μ V)	Limit Line (dB μ V)	Over Limit (dB)	Detector	Phase
1	0.21	20.71	9.64	0.02	9.86	40.23	63.32	-23.09	QP	NEUTRAL
2	0.21	10.44	9.64	0.02	9.86	29.96	53.32	-23.36	Average	NEUTRAL
3	0.34	18.26	9.64	0.02	9.86	37.78	59.09	-21.31	QP	NEUTRAL
4	0.34	10.25	9.64	0.02	9.86	29.77	49.09	-19.32	Average	NEUTRAL
5	0.41	16.92	9.64	0.02	9.86	36.44	57.55	-21.11	QP	NEUTRAL
6	0.41	8.88	9.64	0.02	9.86	28.40	47.55	-19.15	Average	NEUTRAL
7	0.48	17.09	9.64	0.02	9.86	36.61	56.27	-19.66	QP	NEUTRAL
8	0.48	9.54	9.64	0.02	9.86	29.06	46.27	-17.21	Average	NEUTRAL
9	0.56	16.85	9.64	0.03	9.86	36.38	56.00	-19.62	QP	NEUTRAL
10	0.56	9.09	9.64	0.03	9.86	28.62	46.00	-17.38	Average	NEUTRAL
11	0.69	14.45	9.64	0.04	9.86	33.99	56.00	-22.01	QP	NEUTRAL
12	0.69	5.33	9.64	0.04	9.86	24.87	46.00	-21.13	Average	NEUTRAL

Note: 1. Result Level = Read Level + LISN Factor + Pulse Limiter Factor + Cable loss.

2. If QP Result complies with AV limit, AV Result is deemed to comply with AV limit.

3. Test setup: RBW: 200 Hz (9 kHz—150 kHz), 9 kHz (150 kHz—30 MHz).

4. Step size: 80Hz (0.009MHz-0.15MHz), 4 kHz (0.15MHz-30MHz), Scan time: auto.

8. Antenna Requirements

8.1. Limit

For intentional device, according to FCC 47 CFR Section 15.203, an intentional radiator shall be designed to ensure that no antenna other than that furnished by the responsible party shall be used with the device.

8.2. Result

The antennas used for this product are FPC Antenna and that no antenna other than that furnished by the responsible party shall be used with the device, the maximum peak gain of the transmit antenna is only 2.12 dBi.

END OF REPORT