

11N20MIMO Ant2 2462

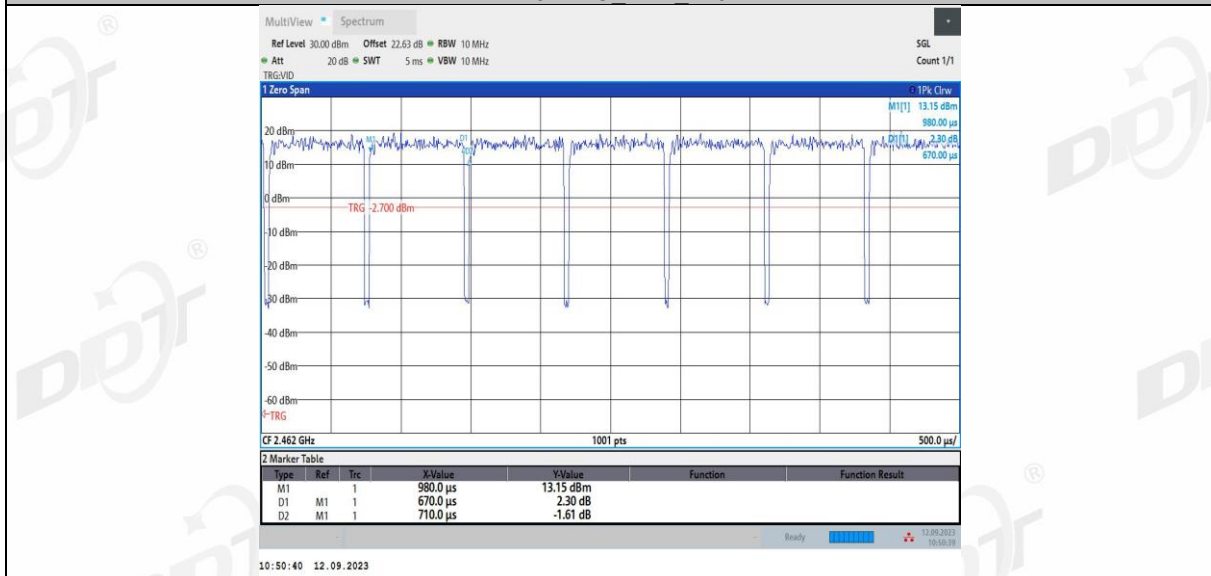

11. Radiated Spurious Emissions

11.1. Block diagram of test setup

In 3 m Anechoic Chamber, test setup diagram for 9 kHz - 30 MHz:

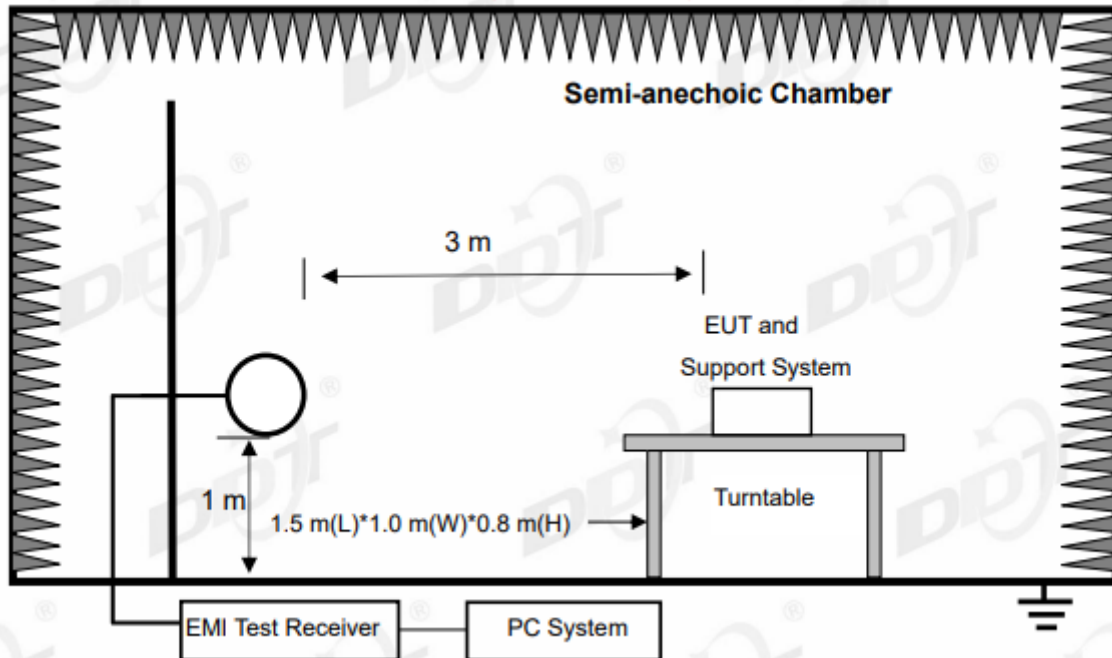

In 3 m Anechoic Chamber, test setup diagram for 30 MHz - 1 GHz:

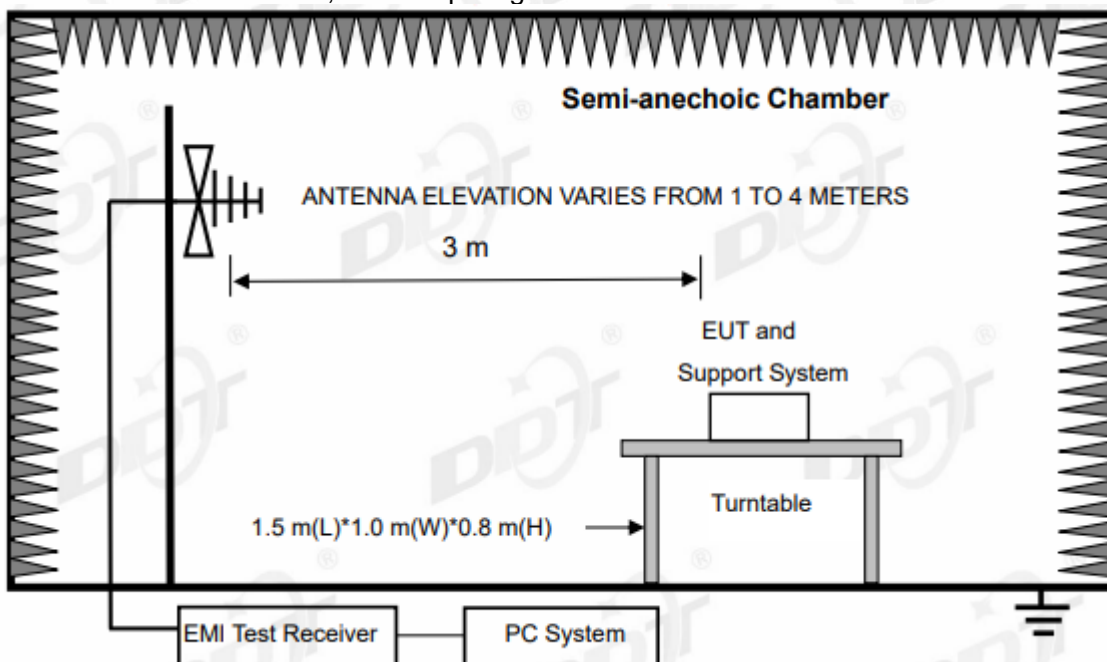

In 3 m Anechoic Chamber, test setup diagram for frequency above 1 GHz:

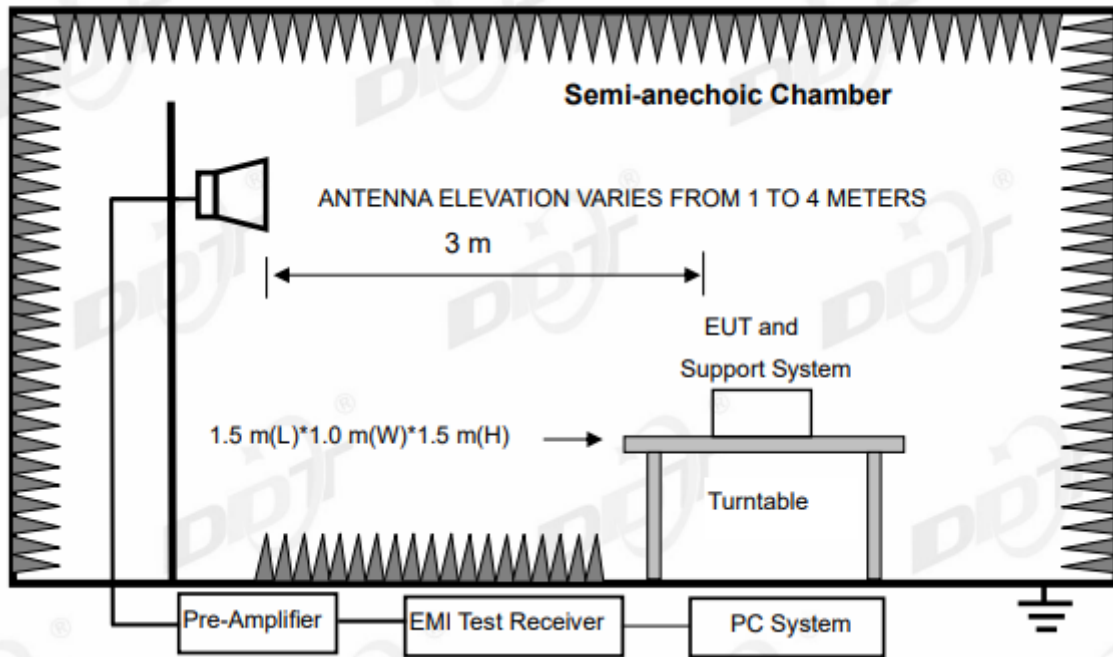

Note: For harmonic emissions test an appropriate high pass filter was inserted in the input port of AMP.

11.2. Limit

(1) FCC 15.205 Restricted frequency band:

MHz	MHz	MHz	GHz
0.090-0.110	16.42-16.423	399.9-410	4.5-5.15
¹ 0.495-0.505	16.69475-16.69525	608-614	5.35-5.46
2.1735-2.1905	16.80425-16.80475	960-1240	7.25-7.75
4.125-4.128	25.5-25.67	1300-1427	8.025-8.5
4.1772&4.17775	37.5-38.25	1435-1626.5	9.0-9.2
4.2072&4.20775	73-74.6	1645.5-1646.5	9.3-9.5
6.215-6.218	74.8-75.2	1660-1710	10.6-12.7
6.26775-6.26825	108-121.94	1718.8-1722.2	13.25-13.4
6.31175-6.31225	123-138	2200-2300	14.47-14.5
8.291-8.294	149.9-150.05	2310-2390	15.35-16.2
8.362-8.366	156.52475-156.52525	2483.5-2500	17.7-21.4
8.37625-8.38675	156.7-156.9	2690-2900	22.01-23.12
8.41425-8.41475	162.0125-167.17	3260-3267	23.6-24.0
12.29-12.293	167.72-173.2	3332-3339	31.2-31.8
12.51975-12.52025	240-285	3345.8-3358	36.43-36.5
12.57675-12.57725	322-335.4	3600-4400	(²)
13.36-13.41			

¹Until February 1, 1999, this restricted band shall be 0.490-0.510 MHz.

²Above 38.6

(2) FCC 15.209 Limit.

Frequency (MHz)	Measurement distance (meters)	Field strength limit	
		$\mu\text{V}/\text{m}$	$\text{dB}(\mu\text{V})/\text{m}$
0.009 ~ 0.490	300	$2400/\text{F}(\text{kHz})$	$67.6-20\log(\text{F})$
0.490 ~ 1.705	30	$24000/\text{F}(\text{kHz})$	$87.6-20\log(\text{F})$
1.705 ~ 30.0	30	30	29.54
30 ~ 88	3	100	40.0
88 ~ 216	3	150	43.5
216 ~ 960	3	200	46.0
960 ~ 1000	3	500	54.0
Above 1000	3	74.0 $\text{dB}(\mu\text{V})/\text{m}$ (Peak), 54.0 $\text{dB}(\mu\text{V})/\text{m}$ (Average)	

Note:

(1) The emission limits shown in the above table are based on measurements employing a CISPR QP detector except for the frequency bands 9-90kHz, 110-490kHz and above 1000MHz, radiated emissions limits in these three bands are based on measurements employing an average detector.

(2) At frequencies below 30MHz, measurement may be performed at a distance closer than that specified, and the limit at closer measurement distance can be extrapolated by below formula:

$$\text{Limit}_{3\text{m}}(\text{dB}\mu\text{V}/\text{m}) = \text{Limit}_{30\text{m}}(\text{dB}\mu\text{V}/\text{m}) + 40\text{Log}(30\text{m}/3\text{m})$$

(3) Limit for this EUT

The emissions appearing within 15.205 restricted frequency bands shall not exceed the limits shown in 15.209, all the other emissions shall be at least 20 dB below the fundamental emissions or comply with 15.209 limits.

11.3. Test procedure

(1) EUT height should be 0.8 m for below 1 GHz at a semi - anechoic chamber while EUT height should be 1.5 m for above 1 GHz at full chamber or semi - anechoic chamber ground with absorbers.

(2) The antenna used as below table.

Test frequency range	Test antenna used	Test antenna distance
9kHz-30MHz	Active Loop antenna	3m
30MHz-1GHz	Trilog Broadband Antenna	3m
1GHz-18GHz	Double Ridged Horn Antenna (1GHz-18GHz)	3m
18GHz-40GHz	Horn Antenna (18GHz-40GHz)	1m

According ANSI C63.10:2013 clause 6.4.6 and 6.5.3, for measurements below 30 MHz, Antenna was located 3 m from EUT, the loop antenna was positioned in three antenna orientations (parallel, perpendicular, and round-parallel), for each measurement antenna alignment, the EUT shall be rotated through 0° to 360° on a turntable, and the lowest height of the magnetic antenna shall be 1 m above the ground. For measurement above 30MHz, the trilog Broadband Antenna or

Horn Antenna was located 3m from EUT, Measurements were made with the antenna positioned in both the horizontal and vertical planes of Polarization, and the measurement antenna was varied from 1 m to 4 m. in height above the reference ground plane to obtain the maximum signal strength.

(3) Below pre-scan procedure was first performed in order to find prominent frequency spectrum radiated emissions from 9 kHz to 25 GHz:

(a) Scanning the peak frequency spectrum with the antenna specified in step (3), and the EUT was rotated 360 degree, the antenna height was varied from 1 m to 4 m (Except loop antenna, it's fixed 1m above ground.)

(b) Change work frequency or channel of device if practicable.

(c) Change modulation type of device if practicable.

(d) Change power supply range from 85% to 115% of the rated supply voltage

(e) Rotated EUT though three orthogonal axes to determine the attitude of EUT arrangement produces highest emissions.

Spectrum frequency from 9 kHz to 25 GHz (tenth harmonic of fundamental frequency) was investigated, and no any obvious emission were detected from 18GHz to 25GHz, so below final test was performed with frequency range from 9kHz to 18GHz.

(4) For final emissions measurements at each frequency of interest, the EUT was rotated and the antenna height was varied between 1 m and 4 m in order to maximize the emission. Measurements in both horizontal and vertical polarities were made and the data was recorded. In order to find the maximum emission, the relative positions of equipments and all of the interface cables were changed according to ANSI C63.10 2013 on Radiated Emission test.

(5) The emissions from 9 kHz to 1 GHz were measured based on CISPR QP detector except for the frequency bands 9-90 kHz, 110-490 kHz, for emissions from 9 kHz-90 kHz, 110 kHz-490 kHz and above 1 GHz were measured based on average detector, for emissions above 1 GHz, peak emissions also be measured and need comply with Peak limit.

(6) The emissions from 9 kHz to 1 GHz, QP or average values were measured with EMI receiver with below RBW

Frequency band	RBW
9 kHz-150 kHz	200 Hz
150 kHz-30 MHz	9 kHz
30 MHz-1 GHz	120 kHz

(7) For emissions above 1GHz, both Peak and Average level were measured with Spectrum Analyzer, and the RBW is set at 1 MHz, VBW is set at 3 MHz for Peak measure; RMS detector RBW 1 MHz VBW 10 Hz for Average measure (according ANSI C63.10:2013 clause 4.2.3.2.3 procedure for average measure)..

11.4. Test result

Pass. (See below detailed test result)

All the emissions except fundamental emission from 9 kHz to 25 GHz were comply with 15.209 limits.

Note 1: According exploratory test, the emission levels are 20 dB below the limit detected from 9 kHz to 30 MHz and 18 GHz to 25 GHz, so the final test was performed with frequency range from 30 MHz to 18 GHz and recorded in below.

Note 2: 30 MHz ~ 25 GHz: (Scan with all mode, the worst case is 802.11n HT20 mode)

Note 3: For emissions below 1 GHz, according exploratory explorer test, when change Tx mode and channel, have no distinct influence on emissions level, so for emissions below 1 GHz, the final test was only performed with EUT working in 802.11n20.

Note 4: For emissions above 1 GHz. If peak results comply with AV limit, AV Result is deemed to comply with AV limit, only recorded the worst case in this report.

Note5: 1N20MIMO 2412+WISA 5180MHz is the worst simultaneous case and was recorded.

Radiated Emission test (below 1GHz)

TR-4-E-009 Radiated Emission Test Result

Test Date: 2023-09-08 **Tested By:** Bairong
EUT: Wireless Multi-Channel Soundbar **Model Number:** CITATION MULTIBEAM 700
Test Mode: TX Mode **Power Supply:** AC 120V/60Hz
Condition: Temp:20.9°C;Humi:65.5% **Test Site:** DDT 3# Chamber
File Path: d:\ts\2023 report data\Q23082223-2E CITATION MULTIBEAM 700\FCC BELOW 1G\20230908-015330_H

Memo:

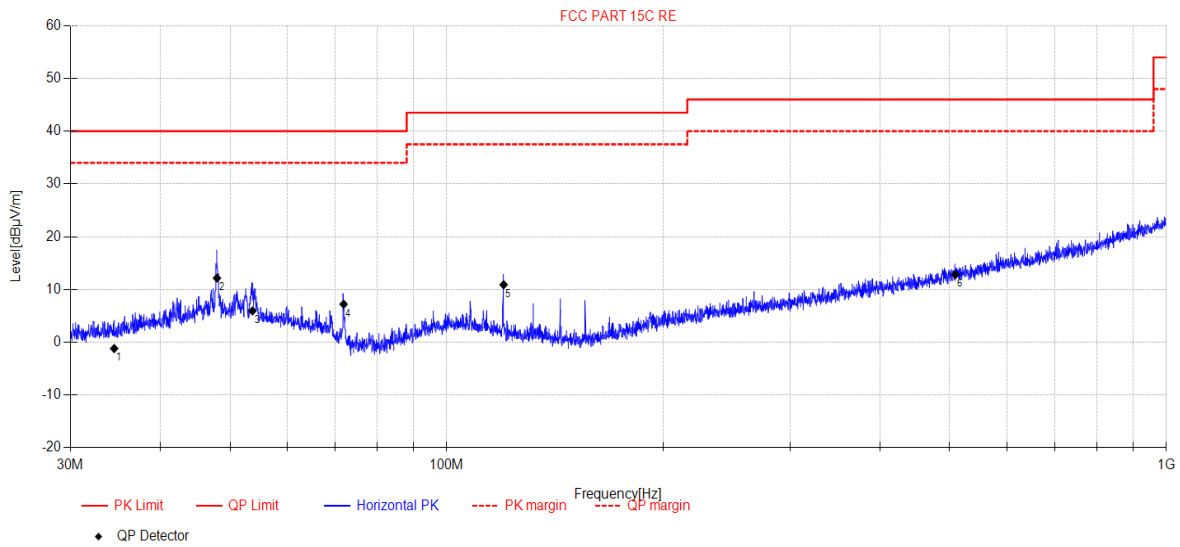

Final Data List										
NO.	Freq. [MHz]	Reading [dBµV/m]	Antenna Factor [dB]	Cable Loss [dB]	AMP [dB]	Result [dBµV/m]	Limit [dBµV/m]	Margin [dB]	Detector	Polarity
1	34.52	14.46	10.75	4.53	-30.93	-1.19	40.00	41.19	QP	Horizontal
2	47.96	24.99	13.20	4.70	-30.73	12.16	40.00	27.84	QP	Horizontal
3	53.72	19.05	12.83	4.74	-30.68	5.94	40.00	34.06	QP	Horizontal
4	71.92	25.04	7.92	4.80	-30.55	7.21	40.00	32.79	QP	Horizontal
5	119.99	27.88	8.70	5.17	-30.84	10.91	43.50	32.59	QP	Horizontal
6	509.04	18.59	17.18	6.97	-29.90	12.84	46.00	33.16	QP	Horizontal

Note:

1. Result Level = Reading + Cable loss + Antenna Factor + AMP
2. If Peak Result complies with QP limit, QP Result is deemed to comply with QP limit.
3. Test setup: RBW: 120 kHz, VBW: 300 kHz, Sweep time: auto.

TR-4-E-009 Radiated Emission Test Result

Test Date: 2023-09-08 **Tested By:** Bairong
EUT: Wireless Multi-Channel Soundbar **Model Number:** CITATION MULTIBEAM 700
Test Mode: TX Mode **Power Supply:** AC 120V/60Hz
Condition: Temp:20.9°C;Humi:65.5% **Test Site:** DDT 3# Chamber
File Path: d:\ts\2023 report data\Q23082223-2E CITATION MULTIBEAM 700\FCC BELOW 1G\20230908-015412_V

Memo:

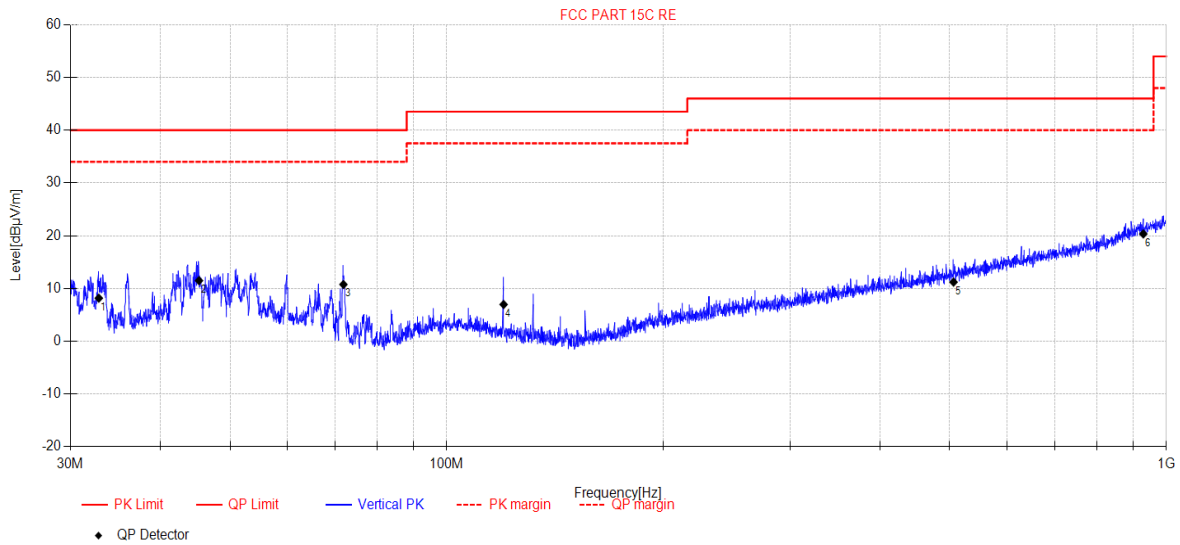

Final Data List										
NO.	Freq. [MHz]	Reading [dBµV/m]	Antenna Factor [dB]	Cable Loss [dB]	AMP [dB]	Result [dBµV/m]	Limit [dBµV/m]	Margin [dB]	Detector	Polarity
1	32.86	24.22	10.40	4.51	-30.96	8.17	40.00	31.83	QP	Vertical
2	45.28	24.56	13.03	4.67	-30.77	11.49	40.00	28.51	QP	Vertical
3	71.87	28.57	7.94	4.80	-30.55	10.76	40.00	29.24	QP	Vertical
4	119.99	23.94	8.70	5.17	-30.84	6.97	43.50	36.53	QP	Vertical
5	506.19	17.04	17.12	6.95	-29.90	11.21	46.00	34.79	QP	Vertical
6	929.02	18.14	22.50	8.44	-28.74	20.34	46.00	25.66	QP	Vertical

Note:

1. Result Level = Reading + Cable loss + Antenna Factor + AMP
2. If Peak Result complies with QP limit, QP Result is deemed to comply with QP limit.
3. Test setup: RBW: 120 kHz, VBW: 300 kHz, Sweep time: auto.

Radiated Emission test (above 1GHz)

TR-4-E-009 Radiated Emission Test Result

Test Date: 2023-09-08 **Tested By:** Bairong
EUT: Wireless Multi-Channel Soundbar **Model Number:** CITATION MULTIBEAM 700
Test Mode: 11N20MIMO 2412 TX Mode **Power Supply:** AC 120V/60Hz
Condition: Temp:20.9°C;Humi:65.5% **Test Site:** DDT 3# Chamber
File Path: d:\ts\2023 report data\Q23082223-2E CITATION MULTIBEAM 700\FCC ABOVE 1G 2.4GWIFI\1

Memo:

Test Graph

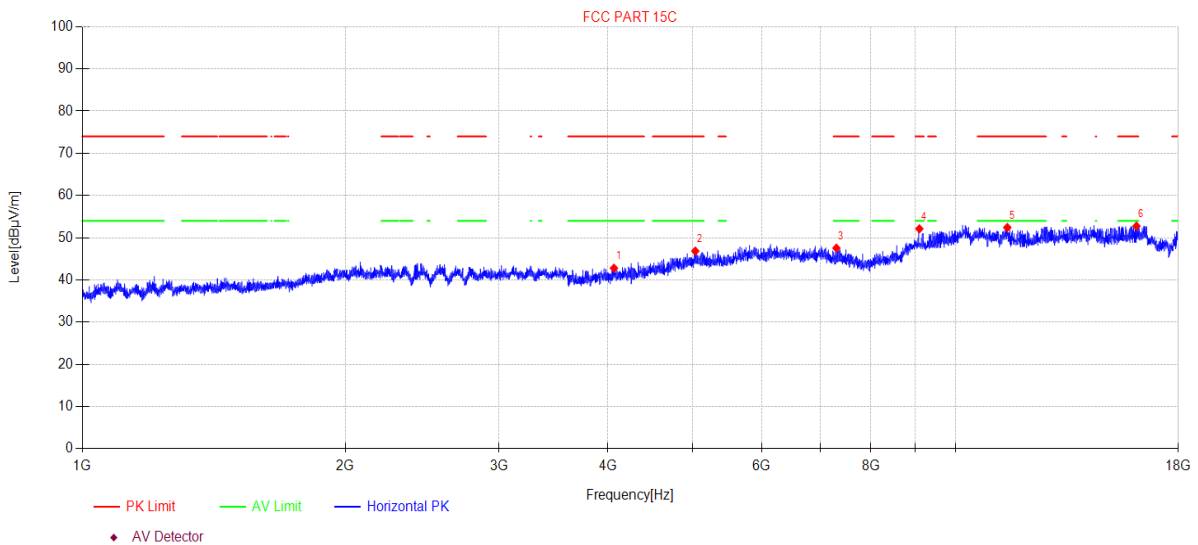

Suspected Data List										
N O.	Freq. [MHz]	Reading [dBµV/m]	Cable loss [dB]	Antenna Factor [dB]	AMP [dB]	Level [dBµV/m]	Limit [dBµV/m]	Margin [dB]	Detector	Polarity
1	4063.23	46.41	5.98	30.83	-40.43	42.79	74.00	31.21	PK	Horizontal
2	5035.05	46.13	7.92	32.87	-40.08	46.84	74.00	27.16	PK	Horizontal
3	7305.78	44.88	7.63	36.50	-41.46	47.55	74.00	26.45	PK	Horizontal
4	9092.46	43.95	8.75	38.20	-38.78	52.12	74.00	21.88	PK	Horizontal
5	11464.21	42.63	10.06	39.04	-39.31	52.42	74.00	21.58	PK	Horizontal
6	16118.55	39.02	15.41	37.78	-39.46	52.75	74.00	21.25	PK	Horizontal

Note:

1. Level = Reading + Cable loss + Antenna Factor + AMP
2. If Peak Result complies with AV limit, AV Result is deemed to comply with AV limit.
3. Test setup: RBW: 1 MHz, VBW: 3 MHz, Sweep time: auto.

TR-4-E-009 Radiated Emission Test Result

Test Date: 2023-09-08 **Tested By:** Bairong
EUT: Wireless Multi-Channel Soundbar **Model Number:** CITATION MULTIBEAM 700
Test Mode: 11N20MIMO 2412 TX Mode **Power Supply:** AC 120V/60Hz
Condition: Temp:20.9°C;Humi:65.5% **Test Site:** DDT 3# Chamber
File Path: d:\ts\2023 report data\Q23082223-2E CITATION MULTIBEAM 700\FCC ABOVE 1G 2.4GWIFI\2

Memo:

Test Graph

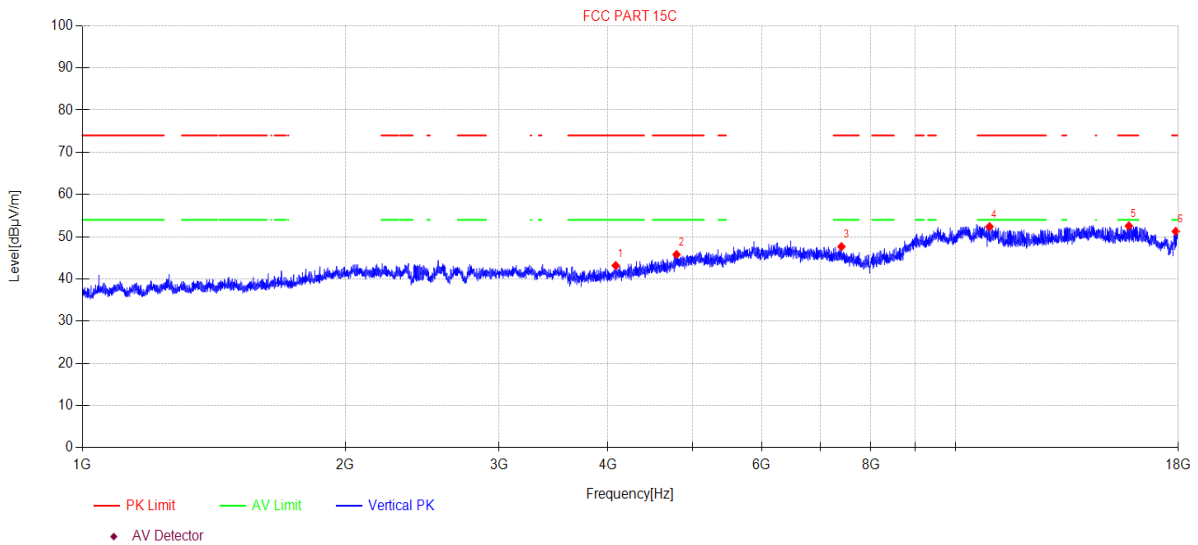

Suspected Data List										
N O.	Freq. [MHz]	Reading [dBµV/m]	Cable loss [dB]	Antenna Factor [dB]	AMP [dB]	Level [dBµV/m]	Limit [dBµV/m]	Margin [dB]	Detector	Polarity
1	4082.07	46.70	6.02	30.86	-40.42	43.16	74.00	30.84	PK	Vertical
2	4792.26	46.23	7.45	32.27	-40.16	45.79	74.00	28.21	PK	Vertical
3	7403.56	45.23	7.64	36.50	-41.71	47.66	74.00	26.34	PK	Vertical
4	10939.83	42.74	9.61	39.10	-39.07	52.38	74.00	21.62	PK	Vertical
5	15795.74	38.66	14.95	38.20	-39.24	52.57	74.00	21.43	PK	Vertical
6	17880.75	39.33	12.99	41.07	-42.13	51.26	74.00	22.74	PK	Vertical

Note:

1. Level = Reading + Cable loss + Antenna Factor + AMP
2. If Peak Result complies with AV limit, AV Result is deemed to comply with AV limit.
3. Test setup: RBW: 1 MHz, VBW: 3 MHz, Sweep time: auto.

TR-4-E-009 Radiated Emission Test Result

Test Date: 2023-09-08 **Tested By:** Bairong
EUT: Wireless Multi-Channel Soundbar **Model Number:** CITATION MULTIBEAM 700
Test Mode: 11N20MIMO 2437 TX Mode **Power Supply:** AC 120V/60Hz
Condition: Temp:20.9°C;Humi:65.5% **Test Site:** DDT 3# Chamber
File Path: d:\ts\2023 report data\Q23082223-2E CITATION MULTIBEAM 700\FCC ABOVE 1G 2.4GWIFI\3

Memo:

Test Graph

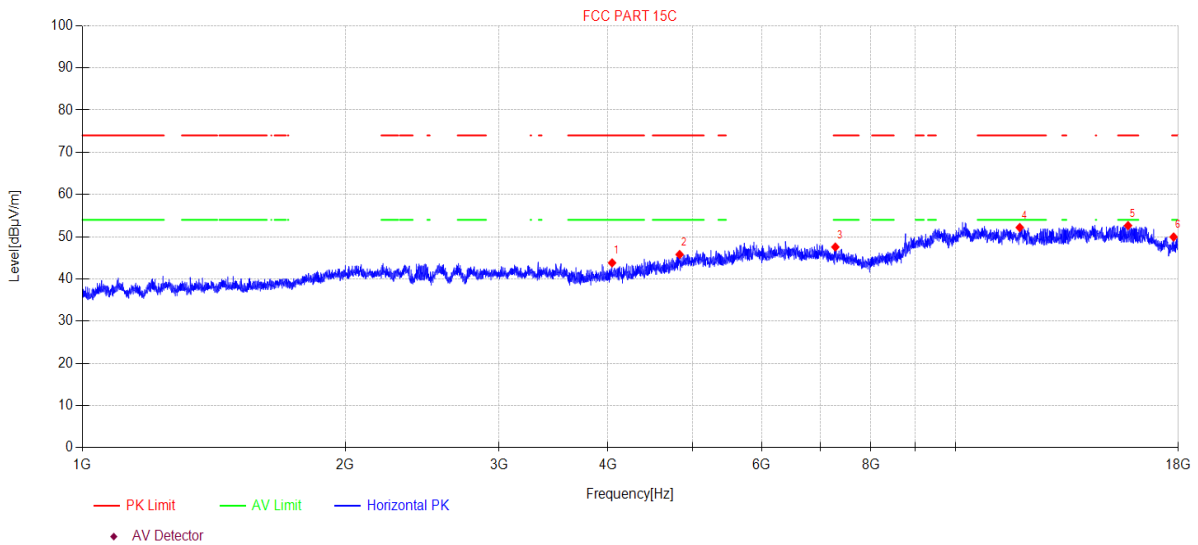

Suspected Data List										
N O.	Freq. [MHz]	Reading [dBμV/m]	Cable loss [dB]	Antenna Factor [dB]	AMP [dB]	Level [dBμV/m]	Limit [dBμV/m]	Margin [dB]	Detector	Polarity
1	4043.32	47.51	5.94	30.79	-40.43	43.81	74.00	30.19	PK	Horizontal
2	4831.20	45.97	7.53	32.42	-40.14	45.78	74.00	28.22	PK	Horizontal
3	7284.70	44.84	7.63	36.50	-41.41	47.56	74.00	26.44	PK	Horizontal
4	11848.21	42.47	10.40	38.80	-39.49	52.18	74.00	21.82	PK	Horizontal
5	15763.81	38.81	14.81	38.24	-39.22	52.64	74.00	21.36	PK	Horizontal
6	17777.69	38.64	12.86	40.34	-41.90	49.94	74.00	24.06	PK	Horizontal

Note:

- Level = Reading + Cable loss + Antenna Factor + AMP
- If Peak Result complies with AV limit, AV Result is deemed to comply with AV limit.
- Test setup: RBW: 1 MHz, VBW: 3 MHz, Sweep time: auto.

TR-4-E-009 Radiated Emission Test Result

Test Date: 2023-09-08 **Tested By:** Bairong
EUT: Wireless Multi-Channel Soundbar **Model Number:** CITATION MULTIBEAM 700
Test Mode: 11N20MIMO 2437 TX Mode **Power Supply:** AC 120V/60Hz
Condition: Temp:20.9°C;Humi:65.5% **Test Site:** DDT 3# Chamber
File Path: d:\ts\2023 report data\Q23082223-2E CITATION MULTIBEAM 700\FCC ABOVE 1G 2.4GWIFI4

Memo:

Test Graph

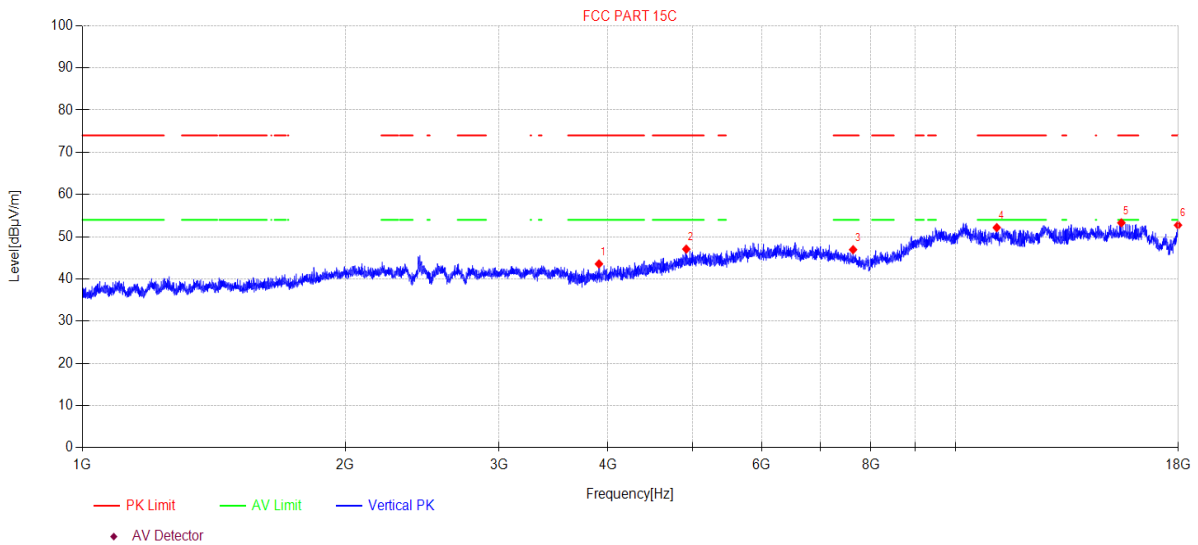

Suspected Data List										
N O.	Freq. [MHz]	Reading [dBµV/m]	Cable loss [dB]	Antenna Factor [dB]	AMP [dB]	Level [dBµV/m]	Limit [dBµV/m]	Margin [dB]	Detector	Polarity
1	3905.50	47.61	5.83	30.51	-40.39	43.56	74.00	30.44	PK	Vertical
2	4917.13	46.81	7.70	32.67	-40.11	47.07	74.00	26.93	PK	Vertical
3	7633.87	45.10	7.65	36.47	-42.28	46.94	74.00	27.06	PK	Vertical
4	11150.51	42.44	9.78	39.10	-39.16	52.16	74.00	21.84	PK	Vertical
5	15488.34	40.17	13.56	38.61	-39.05	53.29	74.00	20.71	PK	Vertical
6	17984.40	40.29	13.11	41.71	-42.37	52.74	74.00	21.26	PK	Vertical

Note:

- Level = Reading + Cable loss + Antenna Factor + AMP
- If Peak Result complies with AV limit, AV Result is deemed to comply with AV limit.
- Test setup: RBW: 1 MHz, VBW: 3 MHz, Sweep time: auto.

TR-4-E-009 Radiated Emission Test Result

Test Date: 2023-09-08 **Tested By:** Bairong
EUT: Wireless Multi-Channel Soundbar **Model Number:** CITATION MULTIBEAM 700
Test Mode: 11N20MIMO 2462 TX Mode **Power Supply:** AC 120V/60Hz
Condition: Temp:20.9°C;Humi:65.5% **Test Site:** DDT 3# Chamber
File Path: d:\ts\2023 report data\Q23082223-2E CITATION MULTIBEAM 700\FCC ABOVE 1G 2.4GWIFI\5

Memo:

Test Graph

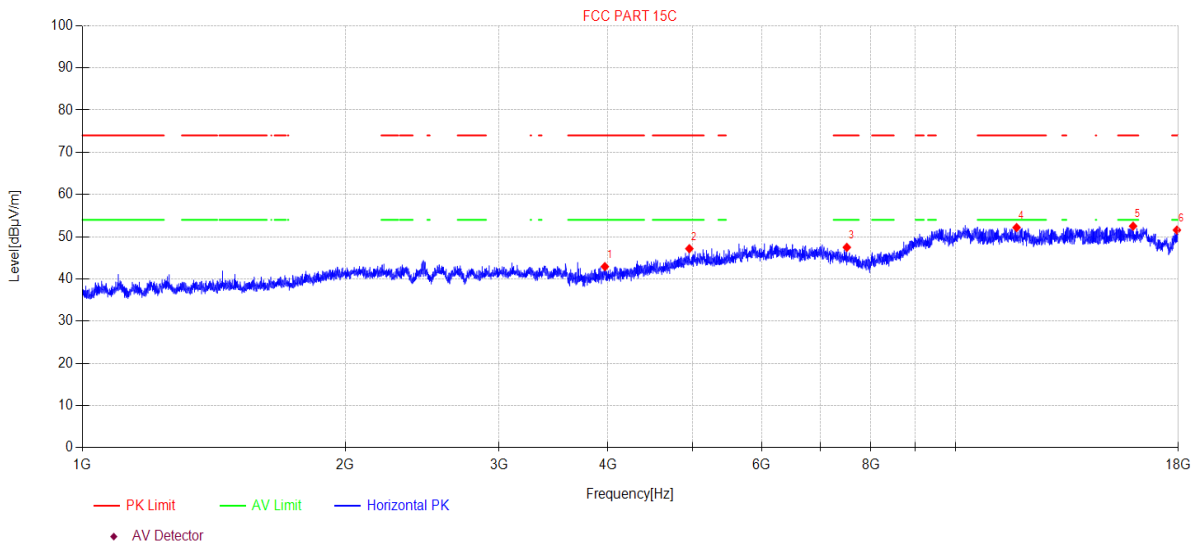

Suspected Data List										
N O.	Freq. [MHz]	Reading [dBµV/m]	Cable loss [dB]	Antenna Factor [dB]	AMP [dB]	Level [dBµV/m]	Limit [dBµV/m]	Margin [dB]	Detector	Polarity
1	3966.93	46.88	5.84	30.63	-40.43	42.92	74.00	31.08	PK	Horizontal
2	4957.08	46.69	7.78	32.80	-40.10	47.17	74.00	26.83	PK	Horizontal
3	7509.15	45.40	7.65	36.40	-41.97	47.48	74.00	26.52	PK	Horizontal
4	11749.32	42.50	10.32	38.80	-39.44	52.18	74.00	21.82	PK	Horizontal
5	15974.78	38.13	15.77	37.95	-39.34	52.51	74.00	21.49	PK	Horizontal
6	17932.50	39.38	13.05	41.39	-42.25	51.57	74.00	22.43	PK	Horizontal

Note:

- Level = Reading + Cable loss + Antenna Factor + AMP
- If Peak Result complies with AV limit, AV Result is deemed to comply with AV limit.
- Test setup: RBW: 1 MHz, VBW: 3 MHz, Sweep time: auto.

TR-4-E-009 Radiated Emission Test Result

Test Date: 2023-09-08 **Tested By:** Bairong
EUT: Wireless Multi-Channel Soundbar **Model Number:** CITATION MULTIBEAM 700
Test Mode: 11N20MIMO 2462 TX Mode **Power Supply:** AC 120V/60Hz
Condition: Temp:20.9°C;Humi:65.5% **Test Site:** DDT 3# Chamber
File Path: d:\ts\2023 report data\Q23082223-2E CITATION MULTIBEAM 700\FCC ABOVE 1G 2.4GWIFI\6

Memo:

Test Graph

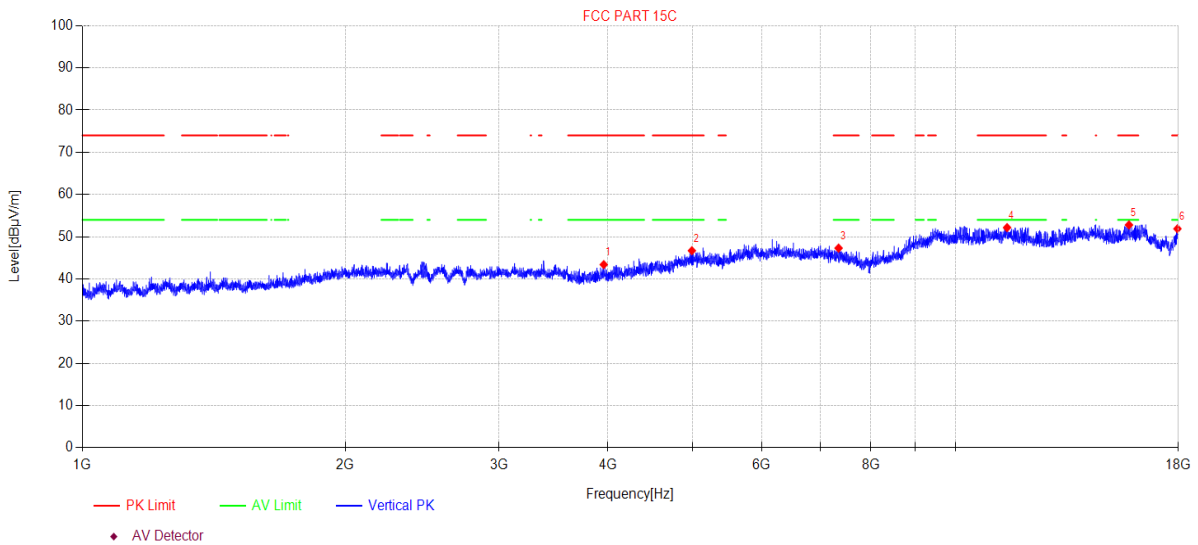

Suspected Data List										
N O.	Freq. [MHz]	Reading [dBµV/m]	Cable loss [dB]	Antenna Factor [dB]	AMP [dB]	Level [dBµV/m]	Limit [dBµV/m]	Margin [dB]	Detector	Polarity
1	3955.48	47.36	5.84	30.61	-40.42	43.39	74.00	30.61	PK	Vertical
2	4990.14	46.12	7.85	32.80	-40.08	46.69	74.00	27.31	PK	Vertical
3	7348.13	44.74	7.63	36.50	-41.57	47.30	74.00	26.70	PK	Vertical
4	11457.58	42.37	10.06	39.04	-39.31	52.16	74.00	21.84	PK	Vertical
5	15804.87	38.83	15.00	38.20	-39.24	52.79	74.00	21.21	PK	Vertical
6	17958.43	39.57	13.08	41.55	-42.31	51.89	74.00	22.11	PK	Vertical

Note:

1. Level = Reading + Cable loss + Antenna Factor + AMP
2. If Peak Result complies with AV limit, AV Result is deemed to comply with AV limit.
3. Test setup: RBW: 1 MHz, VBW: 3 MHz, Sweep time: auto.

TR-4-E-009 Radiated Emission Test Result

Test Date: 2023-09-13 **Tested By:** Bairong
EUT: Wireless Multi-Channel Soundbar **Model Number:** CITATION MULTIBEAM 700
Test Mode: 11N20MIMO 2412+WISA 5180MHz TX Mode **Power Supply:** AC 120V/60Hz
Condition: Temp:20.9°C;Humi:65.5% **Test Site:** DDT 3# Chamber
File Path: d:\ts\2023 report data\Q23082223-2E CITATION MULTIBEAM 700\FCC ABOVE 1G\1

Memo:

Test Graph

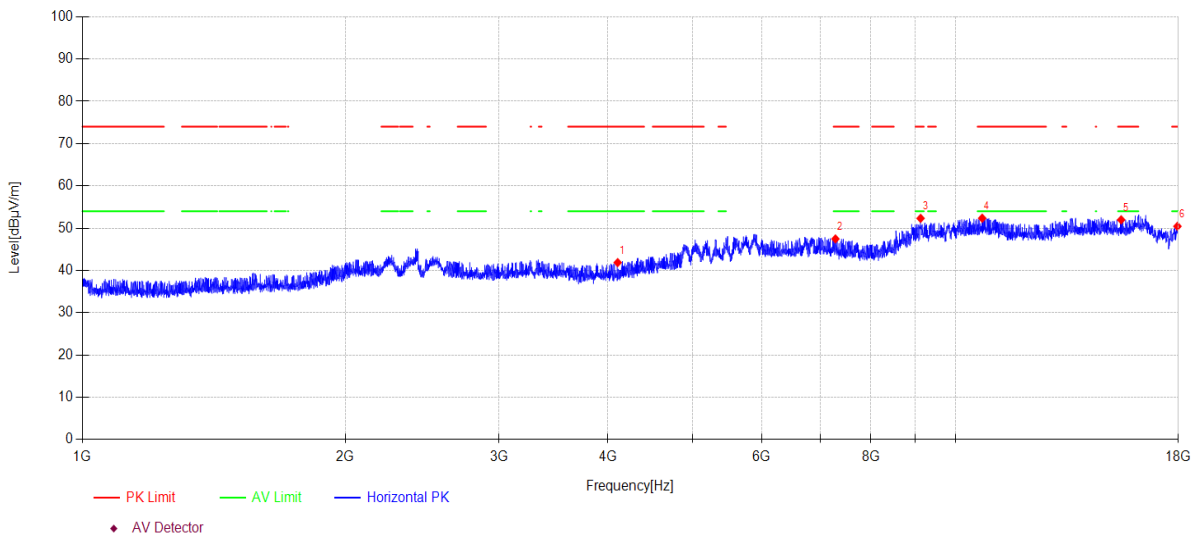

Suspected Data List										
NO	Freq. [MHz]	Reading [dBuV/m]	Cable loss [dB]	Antenna Factor [dB]	AMP [dB]	Level [dBuV/m]	Limit [dBuV/m]	Margin [dB]	Detector	Polarity
1	4103.36	45.30	6.06	30.91	-40.41	41.86	74.00	32.14	PK	Horizontal
2	7286.80	44.75	7.63	36.50	-41.42	47.46	74.00	26.54	PK	Horizontal
3	9121.41	44.10	8.76	38.24	-38.78	52.32	74.00	21.68	PK	Horizontal
4	10730.04	42.78	9.46	39.10	-38.99	52.35	74.00	21.65	PK	Horizontal
5	15479.39	38.89	13.52	38.62	-39.05	51.98	74.00	22.02	PK	Horizontal
6	17958.43	38.12	13.08	41.55	-42.31	50.44	74.00	23.56	PK	Horizontal

Note:

- Level = Reading + Cable loss + Antenna Factor + AMP
- If Peak Result complies with AV limit, AV Result is deemed to comply with AV limit.
- Test setup: RBW: 1 MHz, VBW: 3 MHz, Sweep time: auto.

TR-4-E-009 Radiated Emission Test Result

Test Date: 2023-09-13 **Tested By:** Bairong
EUT: Wireless Multi-Channel Soundbar **Model Number:** CITATION MULTIBEAM 700
Test Mode: 11N20MIMO 2412+WISA 5180MHz TX Mode **Power Supply:** AC 120V/60Hz
Condition: Temp:20.9°C;Humi:65.5% **Test Site:** DDT 3# Chamber
File Path: d:\ts\2023 report data\Q23082223-2E CITATION MULTIBEAM 700\FCC ABOVE 1G\2

Memo:

Test Graph

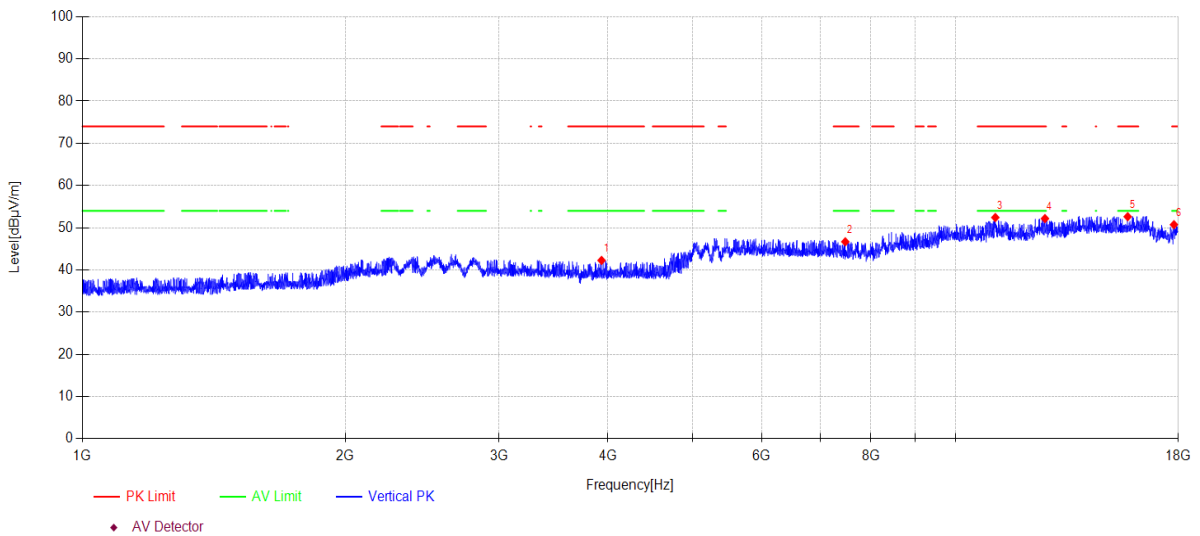

Suspected Data List										
NO	Freq. [MHz]	Reading [dBµV/m]	Cable loss [dB]	Antenna Factor [dB]	AMP [dB]	Level [dBµV/m]	Limit [dBµV/m]	Margin [dB]	Detector	Polarity
1	3932.68	46.26	5.84	30.57	-40.41	42.26	74.00	31.74	PK	Vertical
2	7478.82	44.49	7.64	36.44	-41.90	46.67	74.00	27.33	PK	Vertical
3	11108.69	42.71	9.75	39.10	-39.14	52.42	74.00	21.58	PK	Vertical
4	12662.55	42.12	10.54	39.33	-39.82	52.17	74.00	21.83	PK	Vertical
5	15750.15	38.83	14.75	38.25	-39.21	52.62	74.00	21.38	PK	Vertical
6	17793.11	39.33	12.88	40.45	-41.94	50.72	74.00	23.28	PK	Vertical

Note:

1. Level = Reading + Cable loss + Antenna Factor + AMP
2. If Peak Result complies with AV limit, AV Result is deemed to comply with AV limit.
3. Test setup: RBW: 1 MHz, VBW: 3 MHz, Sweep time: auto.

12. Radiated Band Edge Compliance

12.1. Block diagram of test setup

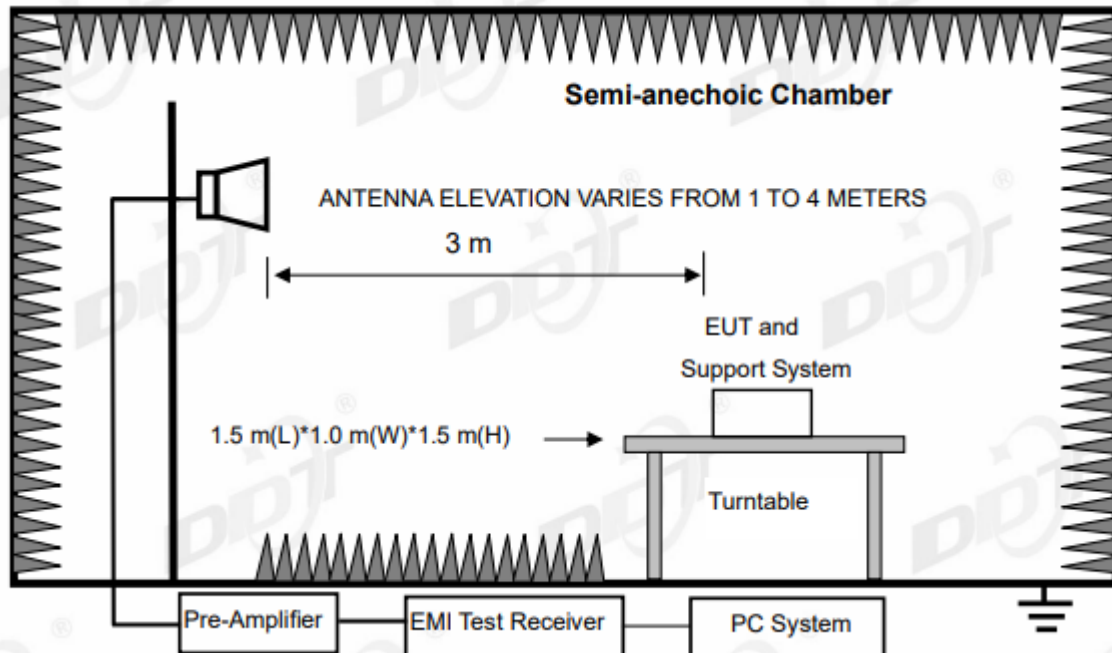

12.2. Limit

All restricted frequency bands shall not exceed the limits shown in 15.209, all the other emissions outside operation frequency band 2400 MHz to 2483.5 MHz shall be at least 20dB below the fundamental emissions.

12.3. Test procedure

Same with Radiated Spurious Emissions except change investigated frequency range from 2310 MHz to 2430 MHz and 2445 MHz to 2500 MHz.

12.4. Test result

Pass. (See below detailed test result)

TR-4-E-009 Radiated Emission Test Result

Test Date: 2023-09-08 **Tested By:** Bairong
EUT: Wireless Multi-Channel Soundbar **Model Number:** CITATION MULTIBEAM 700
Test Mode: 11B 2412 ANT1 TX Mode **Power Supply:** AC 120V/60Hz
Condition: Temp:20.9°C;Humi:65.5% **Test Site:** DDT 3# Chamber
File Path: d:\ts\2023 report data\Q23082223-2E CITATION MULTIBEAM 700\FCC ABOVE 1G 2.4GWIFI\28

Memo:

Test Graph

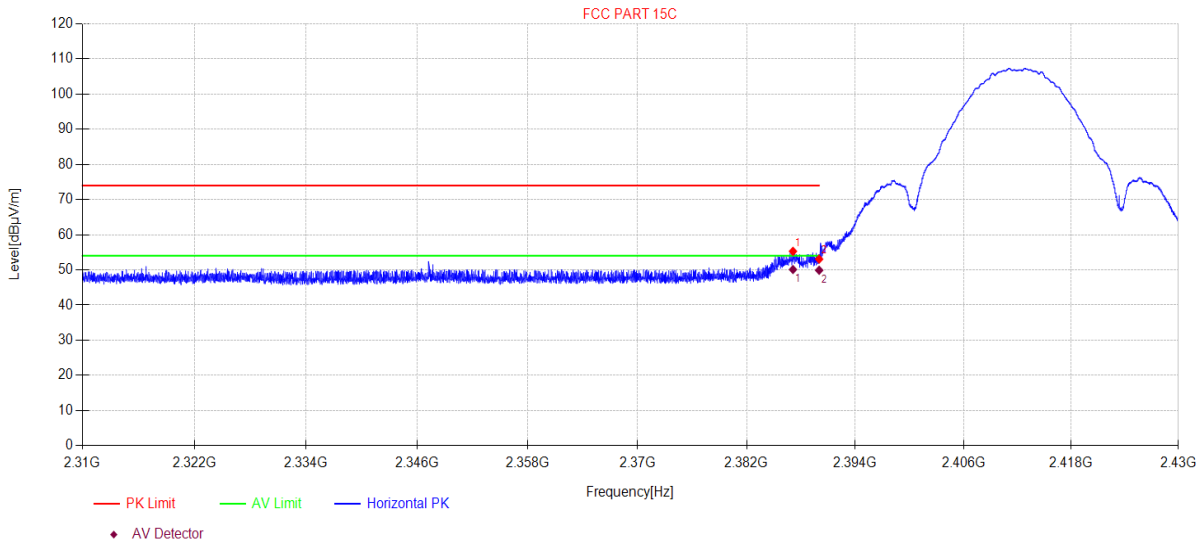

Suspected Data List										
N O.	Freq. [MHz]	Reading [dBµV/m]	Cable loss [dB]	Antenna Factor [dB]	AMP [dB]	Level [dBµV/m]	Limit [dBµV/m]	Margin [dB]	Detector	Polarity
1	2387.11	52.07	3.86	27.47	-28.11	55.29	74.00	18.71	PK	Horizontal
2	2390.00	49.82	3.87	27.48	-28.11	53.06	74.00	20.94	PK	Horizontal

Final Data List										
N O.	Freq. [MHz]	Reading [dBµV/m]	Cable loss [dB]	Antenna Factor [dB]	AMP [dB]	Level [dBµV/m]	Limit [dBµV/m]	Margin [dB]	Detector	Polarity
1	2387.11	46.89	3.86	27.47	-28.11	50.11	54.00	3.89	AV	Horizontal
2	2390.00	46.67	3.87	27.48	-28.11	49.91	54.00	4.09	AV	Horizontal

Note:

1. Level = Reading + Cable loss + Antenna Factor + AMP
2. If Peak Result complies with AV limit, AV Result is deemed to comply with AV limit.
3. Test setup: RBW: 1 MHz, VBW: 3 MHz, Sweep time: auto.

TR-4-E-009 Radiated Emission Test Result

Test Date: 2023-09-08 **Tested By:** Bairong
EUT: Wireless Multi-Channel Soundbar **Model Number:** CITATION MULTIBEAM 700
Test Mode: 11B 2412 ANT1 TX Mode **Power Supply:** AC 120V/60Hz
Condition: Temp:20.9°C;Humi:65.5% **Test Site:** DDT 3# Chamber
File Path: d:\ts\2023 report data\Q23082223-2E CITATION MULTIBEAM 700\FCC ABOVE 1G 2.4GWIFI\29

Memo:

Test Graph

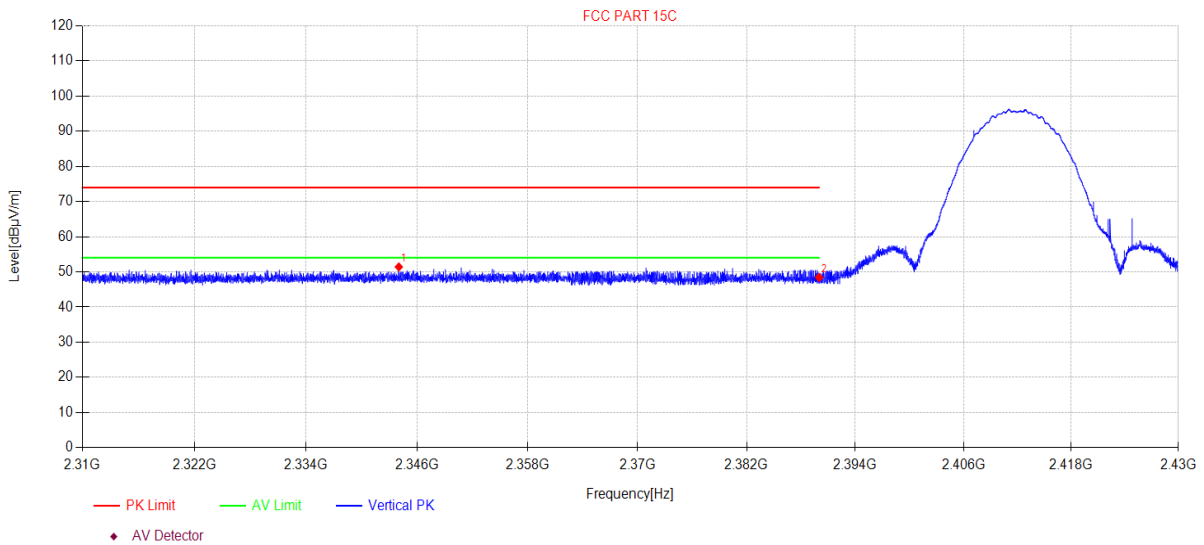

Suspected Data List										
N O.	Freq. [MHz]	Reading [dBµV/m]	Cable loss [dB]	Antenna Factor [dB]	AMP [dB]	Level [dBµV/m]	Limit [dBµV/m]	Margin [dB]	Detector	Polarity
1	2344.03	48.18	3.83	27.39	-27.98	51.42	74.00	22.58	PK	Vertical
2	2390.00	45.19	3.87	27.48	-28.11	48.43	74.00	25.57	PK	Vertical

Note:

- Level = Reading + Cable loss + Antenna Factor + AMP
- If Peak Result complies with AV limit, AV Result is deemed to comply with AV limit.
- Test setup: RBW: 1 MHz, VBW: 3 MHz, Sweep time: auto.

TR-4-E-009 Radiated Emission Test Result

Test Date: 2023-09-08 **Tested By:** Bairong
EUT: Wireless Multi-Channel Soundbar **Model Number:** CITATION MULTIBEAM 700
Test Mode: 11B 2412 ANT2 TX Mode **Power Supply:** AC 120V/60Hz
Condition: Temp:20.9°C;Humi:65.5% **Test Site:** DDT 3# Chamber
File Path: d:\ts\2023 report data\Q23082223-2E CITATION MULTIBEAM 700\FCC ABOVE 1G 2.4GWIFI\30

Memo:

Test Graph

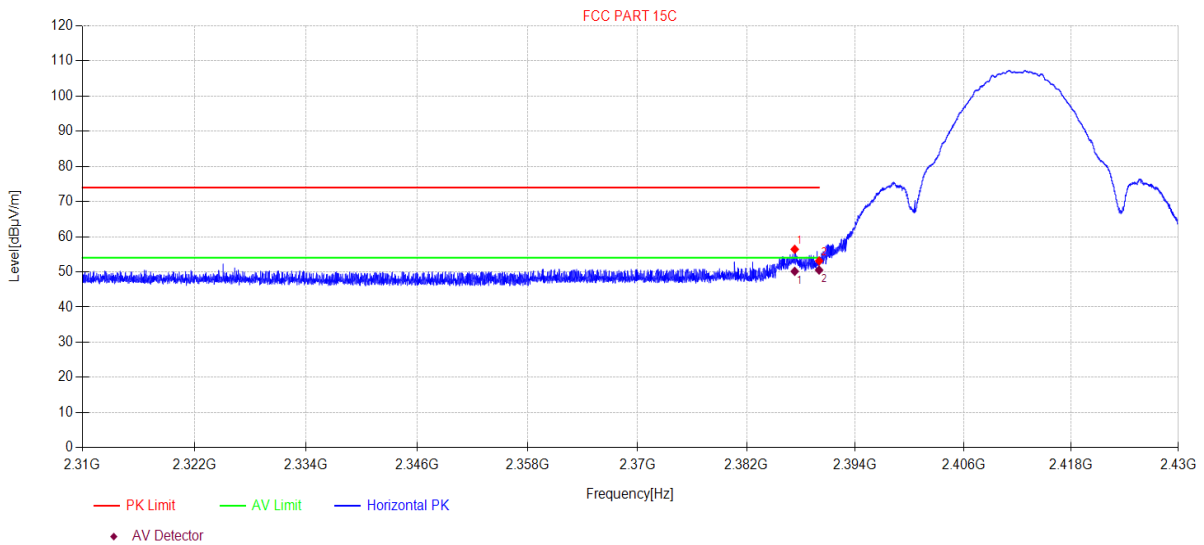

Suspected Data List										
N O.	Freq. [MHz]	Reading [dBµV/m]	Cable loss [dB]	Antenna Factor [dB]	AMP [dB]	Level [dBµV/m]	Limit [dBµV/m]	Margin [dB]	Detector	Polarity
1	2387.30	53.21	3.86	27.47	-28.11	56.43	74.00	17.57	PK	Horizontal
2	2390.00	49.88	3.87	27.48	-28.11	53.12	74.00	20.88	PK	Horizontal

Final Data List										
N O.	Freq. [MHz]	Reading [dBµV/m]	Cable loss [dB]	Antenna Factor [dB]	AMP [dB]	Level [dBµV/m]	Limit [dBµV/m]	Margin [dB]	Detector	Polarity
1	2387.30	46.94	3.86	27.47	-28.11	50.16	54.00	3.84	AV	Horizontal
2	2390.00	47.28	3.87	27.48	-28.11	50.52	54.00	3.48	AV	Horizontal

Note:

1. Level = Reading + Cable loss + Antenna Factor + AMP
2. If Peak Result complies with AV limit, AV Result is deemed to comply with AV limit.
3. Test setup: RBW: 1 MHz, VBW: 3 MHz, Sweep time: auto.

TR-4-E-009 Radiated Emission Test Result

Test Date: 2023-09-08 **Tested By:** Bairong
EUT: Wireless Multi-Channel Soundbar **Model Number:** CITATION MULTIBEAM 700
Test Mode: 11B 2412 ANT2 TX Mode **Power Supply:** AC 120V/60Hz
Condition: Temp:20.9°C;Humi:65.5% **Test Site:** DDT 3# Chamber
File Path: d:\ts\2023 report data\Q23082223-2E CITATION MULTIBEAM 700\FCC ABOVE 1G 2.4GWIFI\31

Memo:

Test Graph

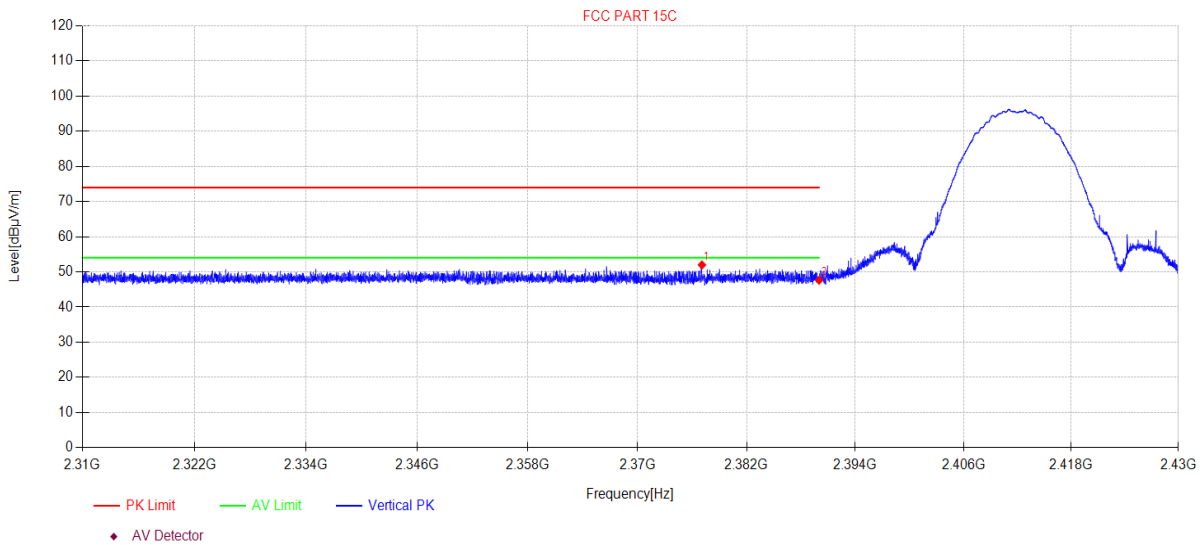

Suspected Data List										
N O.	Freq. [MHz]	Reading [dBµV/m]	Cable loss [dB]	Antenna Factor [dB]	AMP [dB]	Level [dBµV/m]	Limit [dBµV/m]	Margin [dB]	Detector	Polarity
1	2377.09	48.76	3.86	27.45	-28.08	51.99	74.00	22.01	PK	Vertical
2	2390.00	44.39	3.87	27.48	-28.11	47.63	74.00	26.37	PK	Vertical

Note:

1. Level = Reading + Cable loss + Antenna Factor + AMP
2. If Peak Result complies with AV limit, AV Result is deemed to comply with AV limit.
3. Test setup: RBW: 1 MHz, VBW: 3 MHz, Sweep time: auto.

TR-4-E-009 Radiated Emission Test Result

Test Date: 2023-09-08 **Tested By:** Bairong
EUT: Wireless Multi-Channel Soundbar **Model Number:** CITATION MULTIBEAM 700
Test Mode: 11B 2462 ANT1 TX Mode **Power Supply:** AC 120V/60Hz
Condition: Temp:20.9°C;Humi:65.5% **Test Site:** DDT 3# Chamber
File Path: d:\ts\2023 report data\Q23082223-2E CITATION MULTIBEAM 700\FCC ABOVE 1G 2.4GWIFI\32

Memo:

Test Graph

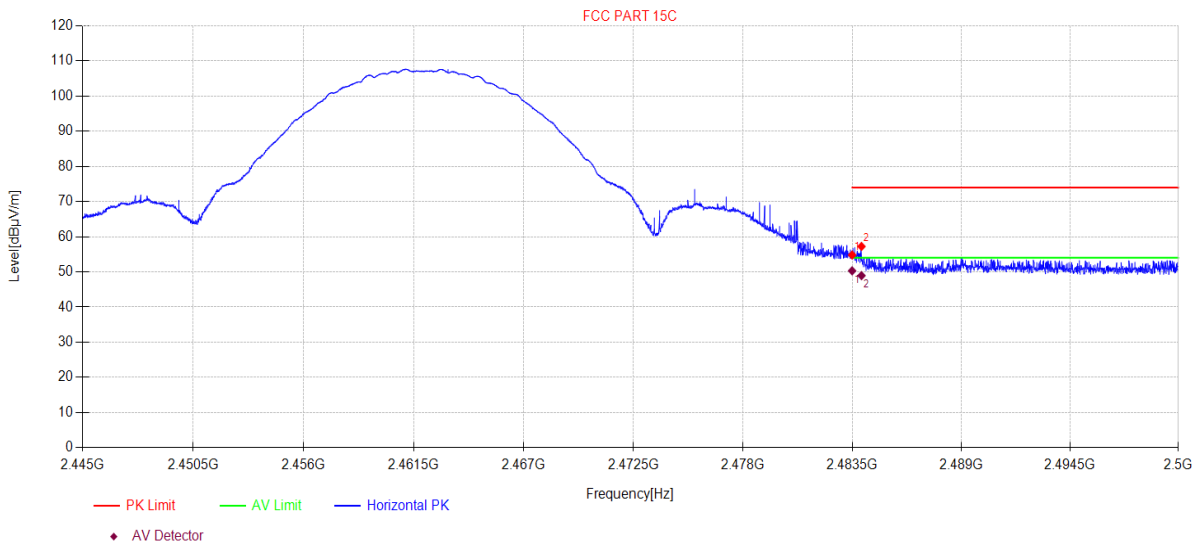

Suspected Data List										
N O.	Freq. [MHz]	Reading [dBμV/m]	Cable loss [dB]	Antenna Factor [dB]	AMP [dB]	Level [dBμV/m]	Limit [dBμV/m]	Margin [dB]	Detector	Polarity
1	2483.50	51.52	3.94	27.73	-28.38	54.81	74.00	19.19	PK	Horizontal
2	2483.97	53.94	3.94	27.74	-28.38	57.24	74.00	16.76	PK	Horizontal

Final Data List										
N O.	Freq. [MHz]	Reading [dBμV/m]	Cable loss [dB]	Antenna Factor [dB]	AMP [dB]	Level [dBμV/m]	Limit [dBμV/m]	Margin [dB]	Detector	Polarity
1	2483.50	47.02	3.94	27.73	-28.38	50.31	54.00	3.69	AV	Horizontal
2	2483.97	45.64	3.94	27.74	-28.38	48.94	54.00	5.06	AV	Horizontal

Note:

1. Level = Reading + Cable loss + Antenna Factor + AMP
2. If Peak Result complies with AV limit, AV Result is deemed to comply with AV limit.
3. Test setup: RBW: 1 MHz, VBW: 3 MHz, Sweep time: auto.

TR-4-E-009 Radiated Emission Test Result

Test Date: 2023-09-08 **Tested By:** Bairong
EUT: Wireless Multi-Channel Soundbar **Model Number:** CITATION MULTIBEAM 700
Test Mode: 11B 2462 ANT1 TX Mode **Power Supply:** AC 120V/60Hz
Condition: Temp:20.9°C;Humi:65.5% **Test Site:** DDT 3# Chamber
File Path: d:\ts\2023 report data\Q23082223-2E CITATION MULTIBEAM 700\FCC ABOVE 1G 2.4GWIFI\33

Memo:

Test Graph

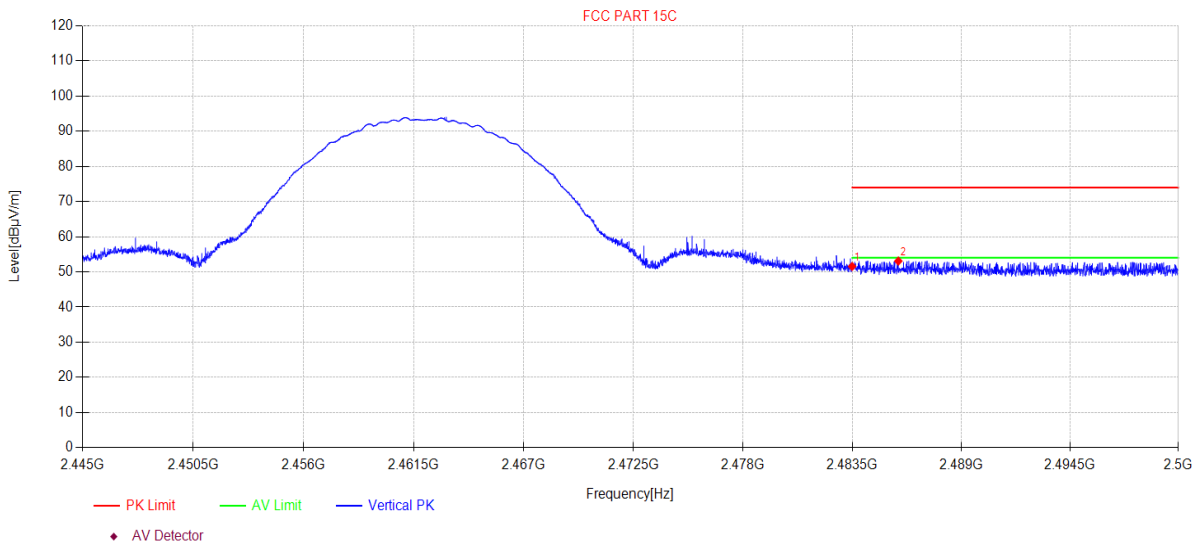

Suspected Data List										
N O.	Freq. [MHz]	Reading [dBµV/m]	Cable loss [dB]	Antenna Factor [dB]	AMP [dB]	Level [dBµV/m]	Limit [dBµV/m]	Margin [dB]	Detector	Polarity
1	2483.50	48.27	3.94	27.73	-28.38	51.56	74.00	22.44	PK	Vertical
2	2485.83	49.79	3.94	27.74	-28.38	53.09	74.00	20.91	PK	Vertical

Note:

1. Level = Reading + Cable loss + Antenna Factor + AMP
2. If Peak Result complies with AV limit, AV Result is deemed to comply with AV limit.
3. Test setup: RBW: 1 MHz, VBW: 3 MHz, Sweep time: auto.

TR-4-E-009 Radiated Emission Test Result

Test Date: 2023-09-08 **Tested By:** Bairong
EUT: Wireless Multi-Channel Soundbar **Model Number:** CITATION MULTIBEAM 700
Test Mode: 11B 2462 ANT2 TX Mode **Power Supply:** AC 120V/60Hz
Condition: Temp:20.9°C;Humi:65.5% **Test Site:** DDT 3# Chamber
File Path: d:\ts\2023 report data\Q23082223-2E CITATION MULTIBEAM 700\FCC ABOVE 1G 2.4GWIFI\34

Memo:

Test Graph

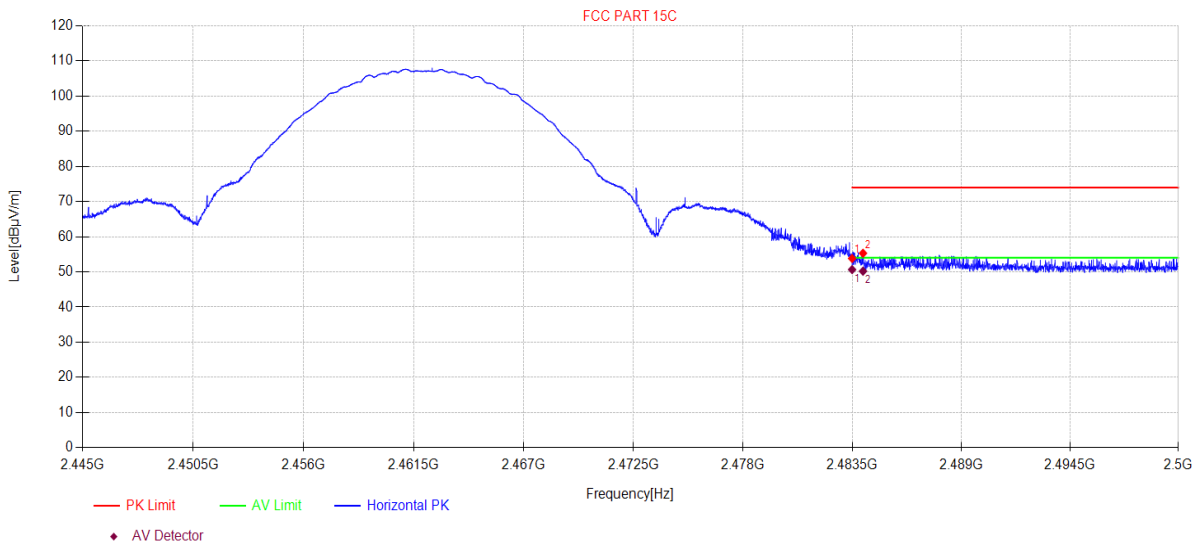

Suspected Data List										
N O.	Freq. [MHz]	Reading [dBμV/m]	Cable loss [dB]	Antenna Factor [dB]	AMP [dB]	Level [dBμV/m]	Limit [dBμV/m]	Margin [dB]	Detector	Polarity
1	2483.50	50.53	3.94	27.73	-28.38	53.82	74.00	20.18	PK	Horizontal
2	2484.05	52.00	3.94	27.74	-28.38	55.30	74.00	18.70	PK	Horizontal

Final Data List										
N O.	Freq. [MHz]	Reading [dBμV/m]	Cable loss [dB]	Antenna Factor [dB]	AMP [dB]	Level [dBμV/m]	Limit [dBμV/m]	Margin [dB]	Detector	Polarity
1	2483.50	47.36	3.94	27.73	-28.38	50.65	54.00	3.35	AV	Horizontal
2	2484.05	46.91	3.94	27.74	-28.38	50.21	54.00	3.79	AV	Horizontal

Note:

1. Level = Reading + Cable loss + Antenna Factor + AMP
2. If Peak Result complies with AV limit, AV Result is deemed to comply with AV limit.
3. Test setup: RBW: 1 MHz, VBW: 3 MHz, Sweep time: auto.

TR-4-E-009 Radiated Emission Test Result

Test Date: 2023-09-08 **Tested By:** Bairong
EUT: Wireless Multi-Channel Soundbar **Model Number:** CITATION MULTIBEAM 700
Test Mode: 11B 2462 ANT2 TX Mode **Power Supply:** AC 120V/60Hz
Condition: Temp:20.9°C;Humi:65.5% **Test Site:** DDT 3# Chamber
File Path: d:\ts\2023 report data\Q23082223-2E CITATION MULTIBEAM 700\FCC ABOVE 1G 2.4GWIFI\35

Memo:

Test Graph

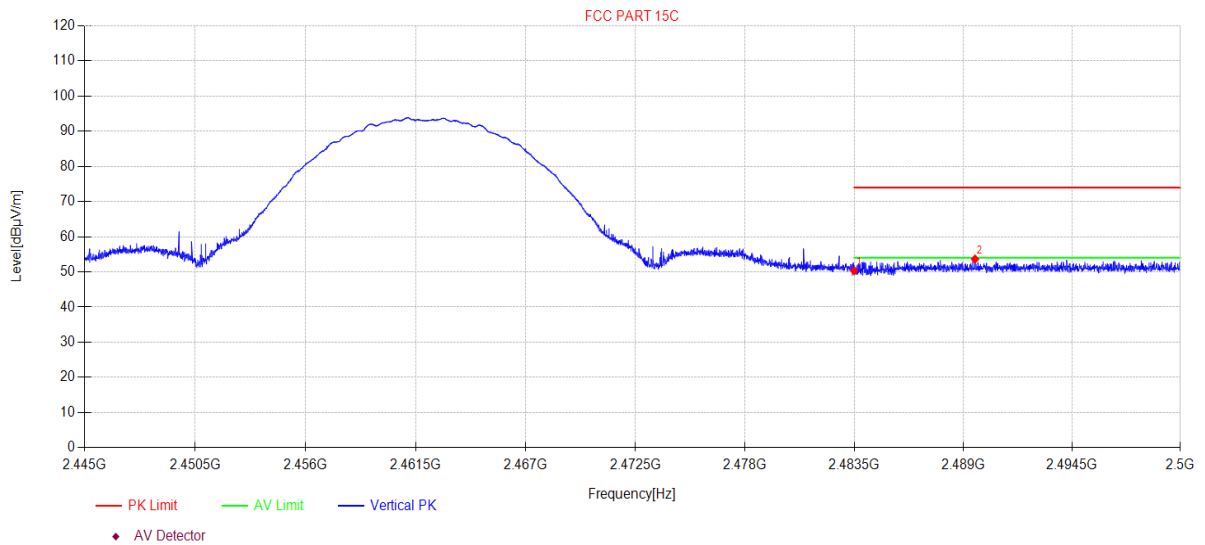

Suspected Data List										
N O.	Freq. [MHz]	Reading [dBµV/m]	Cable loss [dB]	Antenna Factor [dB]	AMP [dB]	Level [dBµV/m]	Limit [dBµV/m]	Margin [dB]	Detector	Polarity
1	2483.50	47.06	3.94	27.73	-28.38	50.35	74.00	23.65	PK	Vertical
2	2489.61	50.34	3.94	27.76	-28.40	53.64	74.00	20.36	PK	Vertical

Note:

1. Level = Reading + Cable loss + Antenna Factor + AMP
2. If Peak Result complies with AV limit, AV Result is deemed to comply with AV limit.
3. Test setup: RBW: 1 MHz, VBW: 3 MHz, Sweep time: auto.

TR-4-E-009 Radiated Emission Test Result

Test Date: 2023-09-09 **Tested By:** Bairong
EUT: Wireless Multi-Channel Soundbar **Model Number:** CITATION MULTIBEAM 700
Test Mode: 11G 2412 TX Mode **Power Supply:** AC 120V/60Hz
Condition: Temp:20.9°C;Humi:65.5% **Test Site:** DDT 3# Chamber
File Path: d:\ts\2023 report data\Q23082223-2E CITATION MULTIBEAM 700\FCC ABOVE 1G 2.4GWIFI\36

Memo:

Test Graph

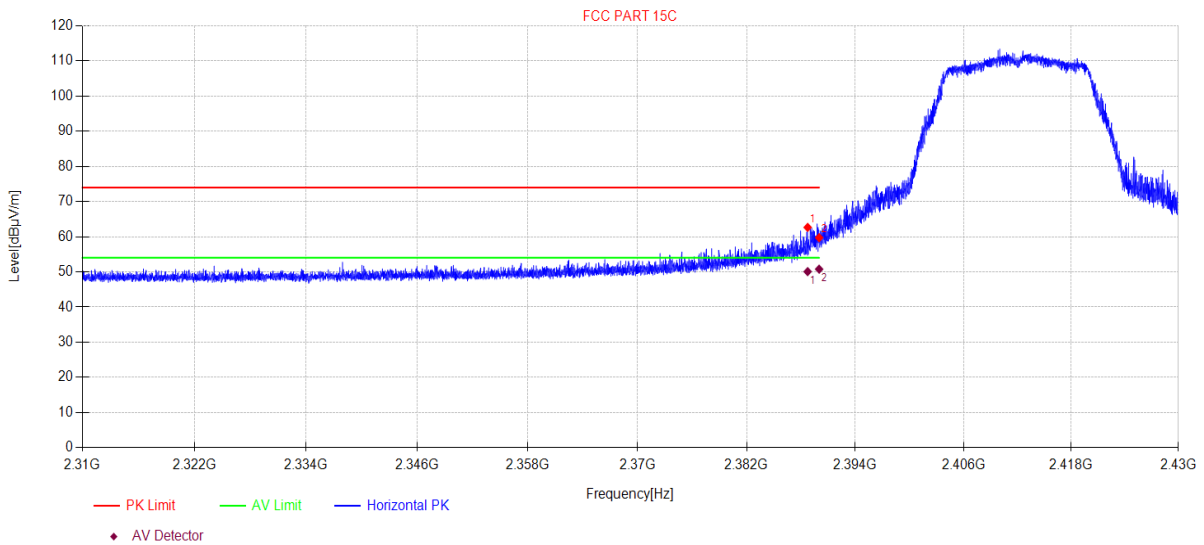

Suspected Data List										
N O.	Freq. [MHz]	Reading [dBµV/m]	Cable loss [dB]	Antenna Factor [dB]	AMP [dB]	Level [dBµV/m]	Limit [dBµV/m]	Margin [dB]	Detector	Polarity
1	2388.73	31.31	3.87	27.48	0.00	62.66	74.00	11.34	PK	Horizontal
2	2390.00	28.38	3.87	27.48	0.00	59.73	74.00	14.27	PK	Horizontal

Final Data List										
N O.	Freq. [MHz]	Reading [dBµV/m]	Cable loss [dB]	Antenna Factor [dB]	AMP [dB]	Level [dBµV/m]	Limit [dBµV/m]	Margin [dB]	Detector	Polarity
1	2388.73	18.74	3.87	27.48	0.00	50.09	54.00	3.91	AV	Horizontal
2	2390.00	19.43	3.87	27.48	0.00	50.78	54.00	3.22	AV	Horizontal

Note:

1. Level = Reading + Cable loss + Antenna Factor + AMP
2. If Peak Result complies with AV limit, AV Result is deemed to comply with AV limit.
3. Test setup: RBW: 1 MHz, VBW: 3 MHz, Sweep time: auto.

TR-4-E-009 Radiated Emission Test Result

Test Date: 2023-09-09 **Tested By:** Bairong
EUT: Wireless Multi-Channel Soundbar **Model Number:** CITATION MULTIBEAM 700
Test Mode: 11G 2412 TX Mode **Power Supply:** AC 120V/60Hz
Condition: Temp:20.9°C;Humi:65.5% **Test Site:** DDT 3# Chamber
File Path: d:\ts\2023 report data\Q23082223-2E CITATION MULTIBEAM 700\FCC ABOVE 1G 2.4GWIFI\37

Memo:

Test Graph

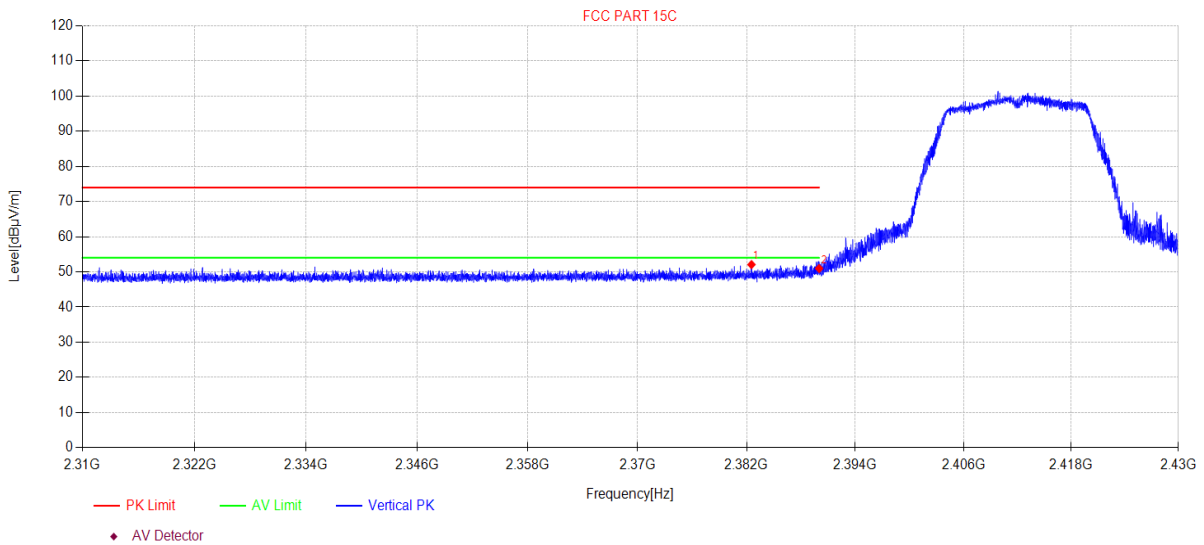

Suspected Data List										
N O.	Freq. [MHz]	Reading [dBµV/m]	Cable loss [dB]	Antenna Factor [dB]	AMP [dB]	Level [dBµV/m]	Limit [dBµV/m]	Margin [dB]	Detector	Polarity
1	2382.54	20.75	3.86	27.47	0.00	52.08	74.00	21.92	PK	Vertical
2	2390.00	19.62	3.87	27.48	0.00	50.97	74.00	23.03	PK	Vertical

Note:

- Level = Reading + Cable loss + Antenna Factor + AMP
- If Peak Result complies with AV limit, AV Result is deemed to comply with AV limit.
- Test setup: RBW: 1 MHz, VBW: 3 MHz, Sweep time: auto.

TR-4-E-009 Radiated Emission Test Result

Test Date: 2023-09-09 **Tested By:** Bairong
EUT: Wireless Multi-Channel Soundbar **Model Number:** CITATION MULTIBEAM 700
Test Mode: 11G 2462 TX Mode **Power Supply:** AC 120V/60Hz
Condition: Temp:20.9°C;Humi:65.5% **Test Site:** DDT 3# Chamber
File Path: d:\ts\2023 report data\Q23082223-2E CITATION MULTIBEAM 700\FCC ABOVE 1G 2.4GWIFI\38

Memo:

Test Graph

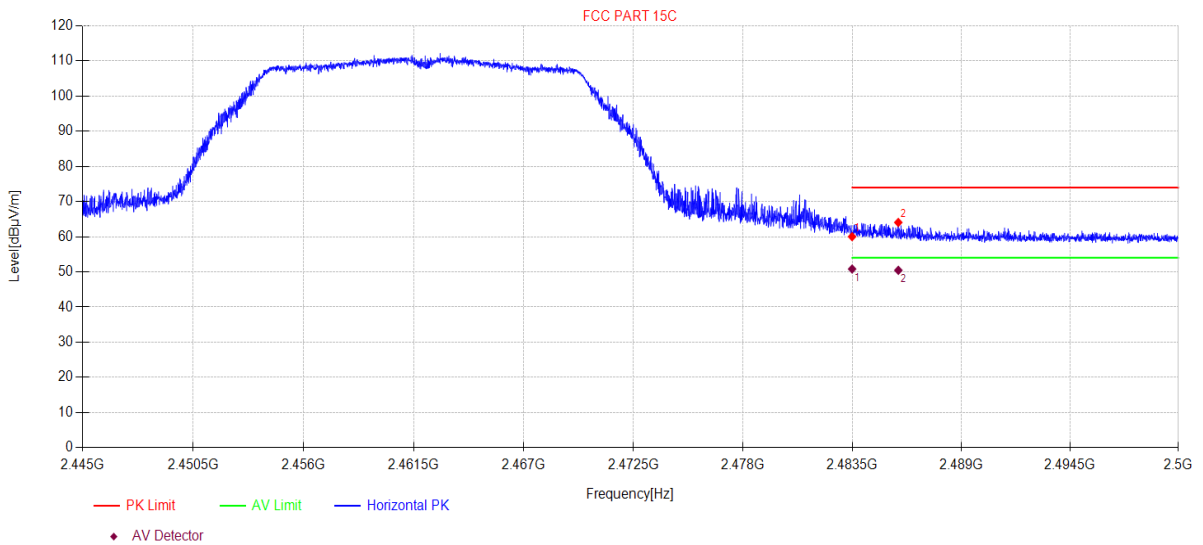

Suspected Data List										
N O.	Freq. [MHz]	Reading [dBµV/m]	Cable loss [dB]	Antenna Factor [dB]	AMP [dB]	Level [dBµV/m]	Limit [dBµV/m]	Margin [dB]	Detector	Polarity
1	2483.50	28.35	3.94	27.73	0.00	60.02	74.00	13.98	PK	Horizontal
2	2485.83	32.38	3.94	27.74	0.00	64.06	74.00	9.94	PK	Horizontal

Final Data List										
N O.	Freq. [MHz]	Reading [dBµV/m]	Cable loss [dB]	Antenna Factor [dB]	AMP [dB]	Level [dBµV/m]	Limit [dBµV/m]	Margin [dB]	Detector	Polarity
1	2483.50	19.16	3.94	27.73	0.00	50.83	54.00	3.17	AV	Horizontal
2	2485.83	18.78	3.94	27.74	0.00	50.46	54.00	3.54	AV	Horizontal

Note:

1. Level = Reading + Cable loss + Antenna Factor + AMP
2. If Peak Result complies with AV limit, AV Result is deemed to comply with AV limit.
3. Test setup: RBW: 1 MHz, VBW: 3 MHz, Sweep time: auto.

TR-4-E-009 Radiated Emission Test Result

Test Date: 2023-09-09 **Tested By:** Bairong
EUT: Wireless Multi-Channel Soundbar **Model Number:** CITATION MULTIBEAM 700
Test Mode: 11G 2462 TX Mode **Power Supply:** AC 120V/60Hz
Condition: Temp:20.9°C;Humi:65.5% **Test Site:** DDT 3# Chamber
File Path: d:\ts\2023 report data\Q23082223-2E CITATION MULTIBEAM 700\FCC ABOVE 1G 2.4GWIFI\39

Memo:

Test Graph

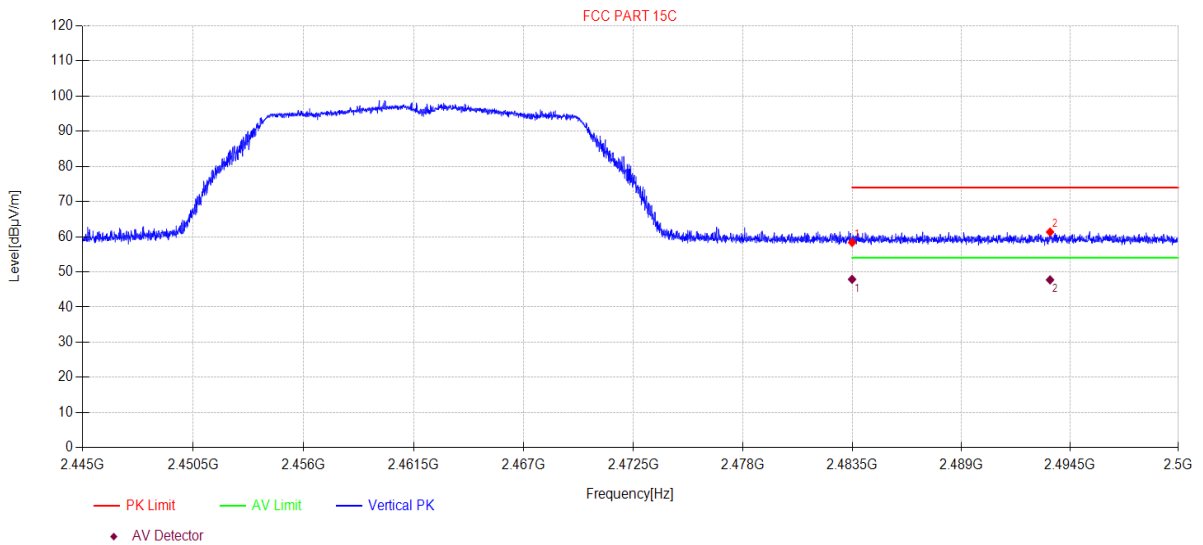

Suspected Data List										
N O.	Freq. [MHz]	Reading [dBµV/m]	Cable loss [dB]	Antenna Factor [dB]	AMP [dB]	Level [dBµV/m]	Limit [dBµV/m]	Margin [dB]	Detector	Polarity
1	2483.50	26.68	3.94	27.73	0.00	58.35	74.00	15.65	PK	Vertical
2	2493.50	29.62	3.95	27.77	0.00	61.34	74.00	12.66	PK	Vertical

Final Data List										
N O.	Freq. [MHz]	Reading [dBµV/m]	Cable loss [dB]	Antenna Factor [dB]	AMP [dB]	Level [dBµV/m]	Limit [dBµV/m]	Margin [dB]	Detector	Polarity
1	2483.50	16.22	3.94	27.73	0.00	47.89	54.00	6.11	AV	Vertical
2	2493.50	16.01	3.95	27.77	0.00	47.73	54.00	6.27	AV	Vertical

Note:

1. Level = Reading + Cable loss + Antenna Factor + AMP
2. If Peak Result complies with AV limit, AV Result is deemed to comply with AV limit.
3. Test setup: RBW: 1 MHz, VBW: 3 MHz, Sweep time: auto.

TR-4-E-009 Radiated Emission Test Result

Test Date: 2023-09-09 **Tested By:** Bairong
EUT: Wireless Multi-Channel Soundbar **Model Number:** CITATION MULTIBEAM 700
Test Mode: 11N20MIMO 2412 TX Mode **Power Supply:** AC 120V/60Hz
Condition: Temp:20.9°C;Humi:65.5% **Test Site:** DDT 3# Chamber
File Path: d:\ts\2023 report data\Q23082223-2E CITATION MULTIBEAM 700\FCC ABOVE 1G 2.4GWIFI40

Memo:

Test Graph

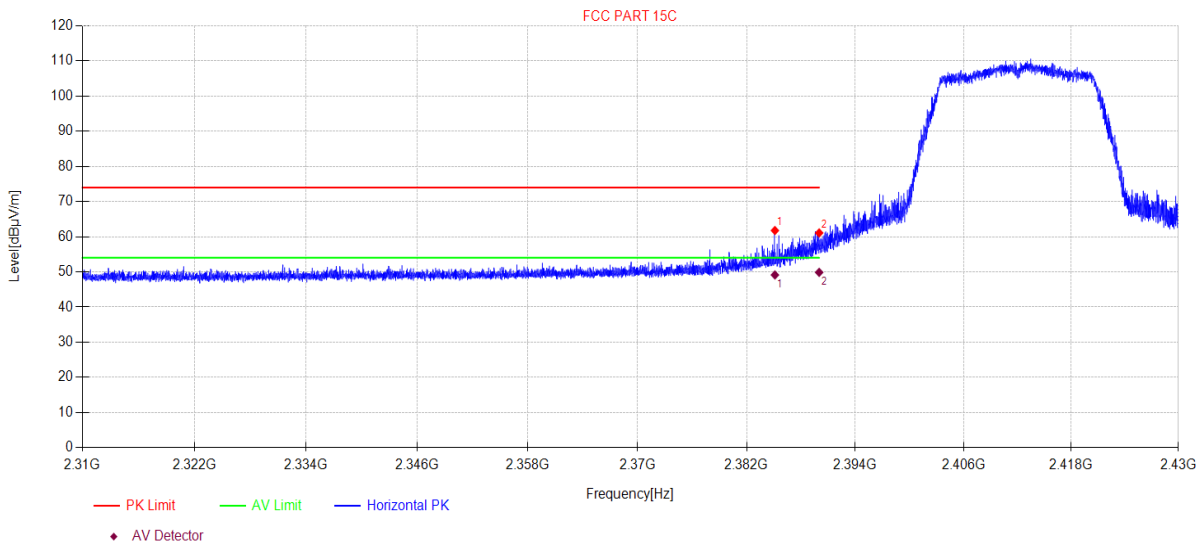

Suspected Data List										
N O.	Freq. [MHz]	Reading [dBµV/m]	Cable loss [dB]	Antenna Factor [dB]	AMP [dB]	Level [dBµV/m]	Limit [dBµV/m]	Margin [dB]	Detector	Polarity
1	2385.12	30.44	3.86	27.47	0.00	61.77	74.00	12.23	PK	Horizontal
2	2390.00	29.74	3.87	27.48	0.00	61.09	74.00	12.91	PK	Horizontal

Final Data List										
N O.	Freq. [MHz]	Reading [dBµV/m]	Cable loss [dB]	Antenna Factor [dB]	AMP [dB]	Level [dBµV/m]	Limit [dBµV/m]	Margin [dB]	Detector	Polarity
1	2385.12	17.80	3.86	27.47	0.00	49.13	54.00	4.87	AV	Horizontal
2	2390.00	18.52	3.87	27.48	0.00	49.87	54.00	4.13	AV	Horizontal

Note:

1. Level = Reading + Cable loss + Antenna Factor + AMP
2. If Peak Result complies with AV limit, AV Result is deemed to comply with AV limit.
3. Test setup: RBW: 1 MHz, VBW: 3 MHz, Sweep time: auto.

TR-4-E-009 Radiated Emission Test Result

Test Date: 2023-09-09 **Tested By:** Bairong
EUT: Wireless Multi-Channel Soundbar **Model Number:** CITATION MULTIBEAM 700
Test Mode: 11N20MIMO 2412 TX Mode **Power Supply:** AC 120V/60Hz
Condition: Temp:20.9°C;Humi:65.5% **Test Site:** DDT 3# Chamber
File Path: d:\ts\2023 report data\Q23082223-2E CITATION MULTIBEAM 700\FCC ABOVE 1G 2.4GWIFI41

Memo:

Test Graph

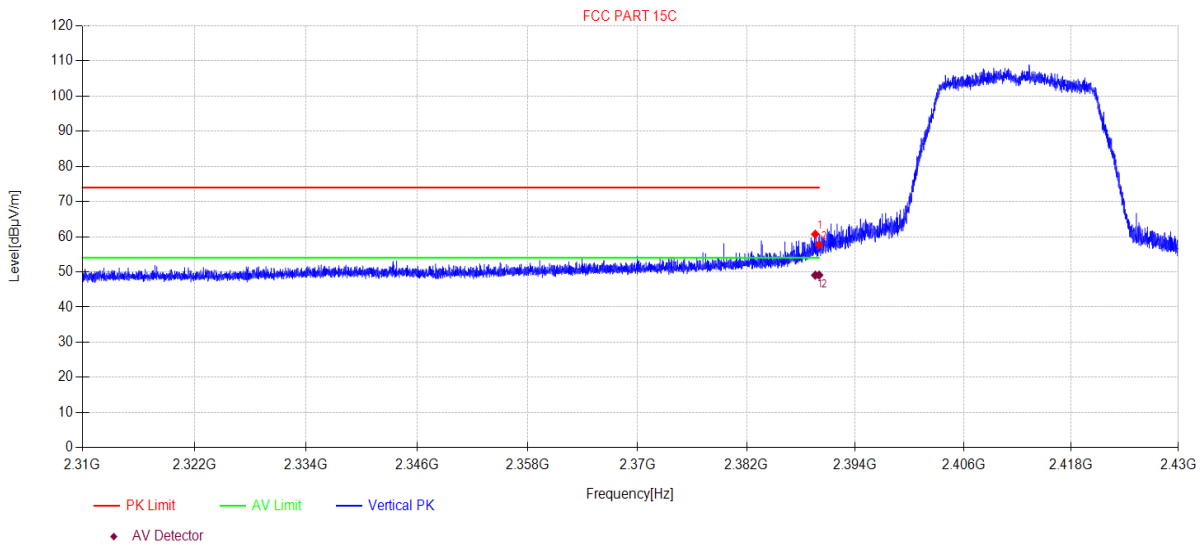

Suspected Data List										
N O.	Freq. [MHz]	Reading [dBµV/m]	Cable loss [dB]	Antenna Factor [dB]	AMP [dB]	Level [dBµV/m]	Limit [dBµV/m]	Margin [dB]	Detector	Polarity
1	2389.57	29.38	3.87	27.48	0.00	60.73	74.00	13.27	PK	Vertical
2	2390.00	26.39	3.87	27.48	0.00	57.74	74.00	16.26	PK	Vertical

Final Data List										
N O.	Freq. [MHz]	Reading [dBµV/m]	Cable loss [dB]	Antenna Factor [dB]	AMP [dB]	Level [dBµV/m]	Limit [dBµV/m]	Margin [dB]	Detector	Polarity
1	2389.57	17.72	3.87	27.48	0.00	49.07	54.00	4.93	AV	Vertical
2	2390.00	17.74	3.87	27.48	0.00	49.09	54.00	4.91	AV	Vertical

Note:

1. Level = Reading + Cable loss + Antenna Factor + AMP
2. If Peak Result complies with AV limit, AV Result is deemed to comply with AV limit.
3. Test setup: RBW: 1 MHz, VBW: 3 MHz, Sweep time: auto.

TR-4-E-009 Radiated Emission Test Result

Test Date: 2023-09-09 **Tested By:** Bairong
EUT: Wireless Multi-Channel Soundbar **Model Number:** CITATION MULTIBEAM 700
Test Mode: 11N20MIMO 2462 TX Mode **Power Supply:** AC 120V/60Hz
Condition: Temp:20.9°C;Humi:65.5% **Test Site:** DDT 3# Chamber
File Path: d:\ts\2023 report data\Q23082223-2E CITATION MULTIBEAM 700\FCC ABOVE 1G 2.4GWIFI42

Memo:

Test Graph

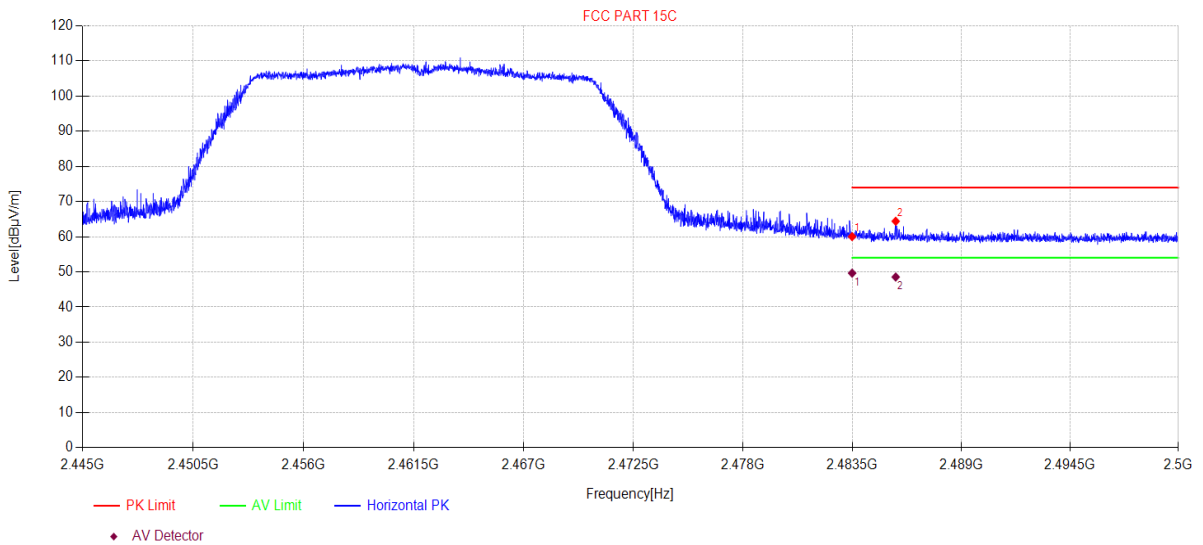

Suspected Data List										
N O.	Freq. [MHz]	Reading [dBµV/m]	Cable loss [dB]	Antenna Factor [dB]	AMP [dB]	Level [dBµV/m]	Limit [dBµV/m]	Margin [dB]	Detector	Polarity
1	2483.50	28.38	3.94	27.73	0.00	60.05	74.00	13.95	PK	Horizontal
2	2485.70	32.72	3.94	27.74	0.00	64.40	74.00	9.60	PK	Horizontal

Final Data List										
N O.	Freq. [MHz]	Reading [dBµV/m]	Cable loss [dB]	Antenna Factor [dB]	AMP [dB]	Level [dBµV/m]	Limit [dBµV/m]	Margin [dB]	Detector	Polarity
1	2483.50	17.98	3.94	27.73	0.00	49.65	54.00	4.35	AV	Horizontal
2	2485.70	16.87	3.94	27.74	0.00	48.55	54.00	5.45	AV	Horizontal

Note:

1. Level = Reading + Cable loss + Antenna Factor + AMP
2. If Peak Result complies with AV limit, AV Result is deemed to comply with AV limit.
3. Test setup: RBW: 1 MHz, VBW: 3 MHz, Sweep time: auto.

TR-4-E-009 Radiated Emission Test Result

Test Date: 2023-09-09 **Tested By:** Bairong
EUT: Wireless Multi-Channel Soundbar **Model Number:** CITATION MULTIBEAM 700
Test Mode: 11N20MIMO 2462 TX Mode **Power Supply:** AC 120V/60Hz
Condition: Temp:20.9°C;Humi:65.5% **Test Site:** DDT 3# Chamber
File Path: d:\ts\2023 report data\Q23082223-2E CITATION MULTIBEAM 700\FCC ABOVE 1G 2.4GWIFI43

Memo:

Test Graph

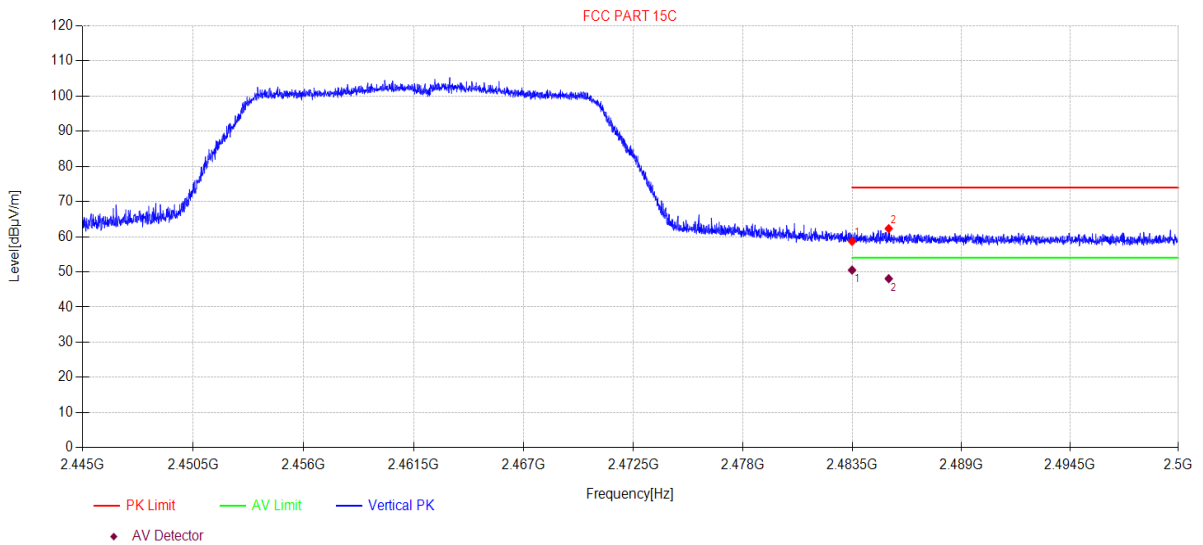

Suspected Data List										
N O.	Freq. [MHz]	Reading [dBµV/m]	Cable loss [dB]	Antenna Factor [dB]	AMP [dB]	Level [dBµV/m]	Limit [dBµV/m]	Margin [dB]	Detector	Polarity
1	2483.50	26.98	3.94	27.73	0.00	58.65	74.00	15.35	PK	Vertical
2	2485.35	30.63	3.94	27.74	0.00	62.31	74.00	11.69	PK	Vertical

Final Data List										
N O.	Freq. [MHz]	Reading [dBµV/m]	Cable loss [dB]	Antenna Factor [dB]	AMP [dB]	Level [dBµV/m]	Limit [dBµV/m]	Margin [dB]	Detector	Polarity
1	2483.50	18.85	3.94	27.73	0.00	50.52	54.00	3.48	AV	Vertical
2	2485.35	16.39	3.94	27.74	0.00	48.07	54.00	5.93	AV	Vertical

Note:

1. Level = Reading + Cable loss + Antenna Factor + AMP
2. If Peak Result complies with AV limit, AV Result is deemed to comply with AV limit.
3. Test setup: RBW: 1 MHz, VBW: 3 MHz, Sweep time: auto.

13. Power Line Conducted Emission

13.1. Block diagram of test setup

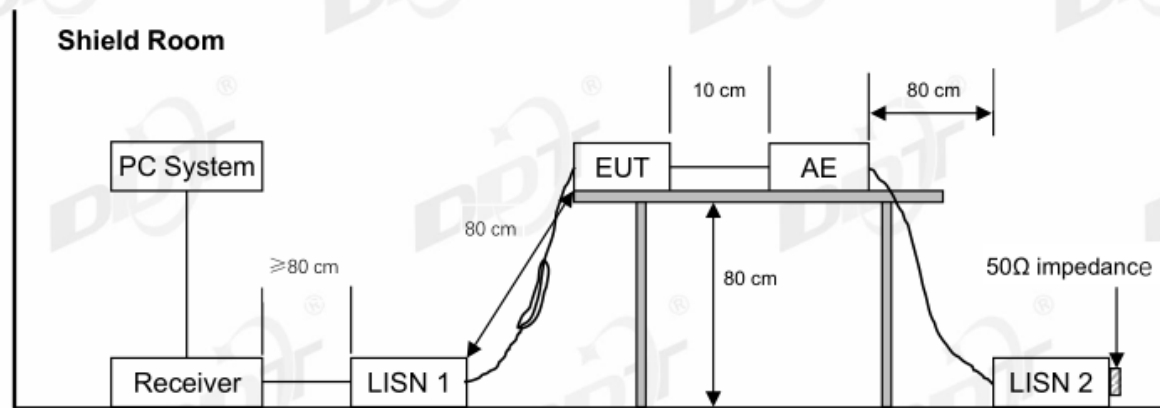

13.2. Power Line Conducted Emission Limits

Frequency	Quasi-Peak Level dB(μ V)	Average Level dB(μ V)
150 kHz ~ 500 kHz	66 ~ 56*	56 ~ 46*
500 kHz ~ 5 MHz	56	46
5 MHz ~ 30 MHz	60	50

Note 1: * Decreasing linearly with logarithm of frequency.

Note 2: The lower limit shall apply at the transition frequencies.

13.3. Test procedure

The EUT and Support equipment, if needed, were put placed on a non-metallic table, 80cm above the ground plane.

All support equipment power received from a second LISN.

Emissions were measured on each current carrying line of the EUT using an EMI Test Receiver connected to the LISN powering the EUT.

The Receiver scanned from 150 kHz to 30 MHz for emissions in each of the test modes.

During the above scans, the emissions were maximized by cable manipulation.

The test mode(s) described in clause 2.4 were scanned during the preliminary test.

After the preliminary scan, we found the test mode producing the highest emission level.

The EUT configuration and worse cable configuration of the above highest emission levels were recorded for reference of the final test.

EUT and support equipment were set up on the test bench as per the configuration with highest emission level in the preliminary test.

A scan was taken on both power lines, Neutral and Line, recording at least the six highest

emissions.

Emission frequency and amplitude were recorded into a computer in which correction factors were used to calculate the emission level and compare reading to the applicable limit.

The test data of the worst-case condition(s) was recorded.

The bandwidth of test receiver is set at 9 kHz.

13.4. Test result

Pass. (See below detailed test result)

Note1: All emissions not reported below are too low against the prescribed limits.

Note2: “----” means peak detection; “-----” means average detection

Note3: Pre-test AC conducted emission at both voltage AC 120V/60Hz and AC 240V/60Hz, recorded worse case.

14. Antenna Requirements

14.1. Limit

For intentional device, according to FCC 47 CFR Section 15.203, an intentional radiator shall be designed to ensure that no antenna other than that furnished by the responsible party shall be used with the device. And according to FCC 47 CFR Section 15.247 (b), if transmitting antennas of directional gain greater than 6 dBi are used, the power shall be reduced by the amount in dB that the directional gain of the antenna exceeds 6 dBi.

14.2. Result

The device support 2T2R MIMO, the antennas both used for this product are FPC antennas and no antenna other than that furnished by the responsible party shall be used with the device, maximum antenna gain is 2.64 dBi for antenna 1, 2.36 dBi for antenna 2.

16. Photos of the EUT

Please refer to appendix I.

END OF REPORT