

FCC AND ISED CERTIFICATION TEST REPORT

FOR

Applicant	:	Harman International Industries, Inc.
Address	:	8500 Balboa Boulevard, Northridge, CA 91329, UNITED STATES
Equipment under Test	:	HK Marine Headunit
Model No.	:	HKMARSOHUG1A2B
Trade Mark	:	harman/kardon
FCC ID	:	APIHKMARSOHU
IC	:	6132A-HKMARSOHU
Manufacturer	:	Harman International Industries, Inc.
Address	:	8500 Balboa Boulevard, Northridge, CA 91329, UNITED STATES

Issued By: Dongguan Dongdian Testing Service Co., Ltd.

Add.: No. 17, Zongbu Road 2, Songshan Lake Sci&Tech, Industry Park,
Dongguan City, Guangdong Province, China, 523808

Tel.: +86-0769-38826678, **E-mail:** ddt@dgddt.com, <http://www.dgddt.com>

REPORT

Table of Contents

	Test report declares.....	4
1.	Summary of Test Results.....	6
2.	General Test Information	7
2.1.	Description of EUT	7
2.2.	Accessories of EUT.....	7
2.3.	Assistant equipment used for test.....	8
2.4.	Block diagram of EUT configuration for test	8
2.5.	Test environment conditions	8
2.6.	Deviations of test standard.....	8
2.7.	Test laboratory	9
2.8.	Measurement uncertainty.....	9
3.	Equipment Used During Test.....	10
4.	6 dB Bandwidth	11
4.1.	Block diagram of test setup.....	11
4.2.	Limits	11
4.3.	Test procedure	11
4.4.	Test result.....	11
4.5.	Test graphs	12
5.	99% Bandwidth	13
5.1.	Block diagram of test setup.....	13
5.2.	Limits	13
5.3.	Test procedure	13
5.4.	Test Result	13
5.5.	Test Graphs.....	14
6.	Maximum Peak Output Power	15
6.1.	Block diagram of test setup.....	15
6.2.	Limits	15
6.3.	Test procedure	15
6.4.	Test result peak.....	15
6.5.	Test graphs peak.....	16
7.	Power Spectral Density.....	17
7.1.	Block diagram of test setup.....	17
7.2.	Limits	17
7.3.	Test procedure	17
7.4.	Test result.....	17
7.5.	Test graphs	18
8.	Band Edge Compliance (Conducted Method)	19

8.1.	Block diagram of test setup.....	19
8.2.	Limits	19
8.3.	Test procedure	19
8.4.	Test result.....	19
8.5.	Test graphs	20
9.	RF Conducted Spurious Emissions	21
9.1.	Block diagram of test setup.....	21
9.2.	Limits	21
9.3.	Test procedure	21
9.4.	Test result.....	22
9.5.	Test graphs	22
10.	Duty Cycle	26
10.1.	Block diagram of test setup.....	26
10.2.	Limit.....	26
10.3.	Test procedure	26
10.4.	Test result.....	26
10.5.	Test graphs	27
11.	Radiated Emission	28
11.1.	Block diagram of test setup.....	28
11.2.	Limit.....	29
11.3.	Test Procedure.....	31
11.4.	Test result.....	32
12.	Emissions in Restricted Frequency Bands	41
12.1.	Block diagram of test setup.....	41
12.2.	Limit.....	41
12.3.	Test procedure	41
12.4.	Test result.....	41
13.	Power Line Conducted Emission	46
13.1.	Block diagram of test setup.....	46
13.2.	Power line conducted emission limits	46
13.3.	Test procedure	46
13.4.	Test result.....	47
14.	Antenna Requirements	48
14.1.	Limit.....	48
14.2.	Result	48
15.	Test Setup Photograph	49
16.	Photos of the EUT	51

Test Report Declare

Applicant	:	Harman International Industries, Inc.
Address	:	8500 Balboa Boulevard, Northridge, CA 91329, UNITED STATES
Equipment under Test	:	HK Marine Headunit
Model No.	:	HKMARSOHUG1A2B
Trade Mark	:	harman/kardon
Manufacturer	:	Harman International Industries, Inc.
Address	:	8500 Balboa Boulevard, Northridge, CA 91329, UNITED STATES

Test Standard Used:

FCC Rules and Regulations Part 15 Subpart C, RSS-247 Issue 2 February 2017.

Test Procedure Used:

ANSI C63.10:2013, RSS-Gen Issue 5, Apr. 2018, Amendment 2 (February 2021)

We Declare:

The equipment described above is tested by Dongguan Dongdian Testing Service Co., Ltd. and in the configuration tested the equipment complied with the standards specified above. The test results are contained in this test report and Dongguan Dongdian Testing Service Co., Ltd. is assumed of full responsibility for the accuracy and completeness of these tests.

After test and evaluation, our opinion is that the equipment provided for test compliance with the requirement of the above FCC&ISED standards.

Report No.:	DDT-R22091303-2E02		
Date of Receipt:	Dec. 12, 2022	Date of Test:	Dec. 12, 2022 ~ May 06, 2023

Prepared By:

Bobo Chen

Bobo Chen/Engineer

Approved By:



Damon Hu/EMC Manager

Note: This report applies to above tested sample only. This report shall not be reproduced in parts without written approval of Dongguan Dongdian Testing Service Co., Ltd.

Revision History

Rev.	Revisions	Issue Date	Revised By
---	Initial issue	May 06, 2023	

1. Summary of Test Results

The EUT have been tested according to the applicable standards as referenced below.		
Description of Test Item	Standard	Verdict
6dB Bandwidth and 99% Bandwidth	FCC Part 15: 15.247(a)(2) RSS-247 Issue 2 clause 5.2(a) RSS-Gen Issue 5 clause 6.7	Pass
Peak Output Power	FCC Part 15: 15.247(b)(3) RSS-247 Issue 2 clause 5.4(d)	Pass
Power Spectral Density	FCC Part 15:15.247(e) RSS-247 Issue 2 clause 5.2(b)	Pass
Band Edge Compliance (conducted method)	FCC Part 15: 15.247(d) RSS-247 Issue 2 clause 5.5	Pass
RF Conducted Spurious Emissions	FCC Part 15: 15.247(d) RSS-247 Issue 2 clause 5.5	Pass
Radiation Emission	FCC Part 15: 15.205(a) FCC Part 15: 15.209(a) FCC Part 15: 15.247(d) RSS-247 Issue 2 clause 5.5 RSS-Gen Issue 5 clause 8.9 RSS-Gen Issue 5 clause 8.10	Pass
Emission in Restricted Frequency Bands	FCC Part 15: 15.205(a) FCC Part 15: 15.209(a) FCC Part 15: 15.247(d) RSS-247 Issue 2 clause 5.5 RSS-Gen Issue 5 clause 8.9 RSS-Gen Issue 5 clause 8.10	Pass
Power Line Conducted Emission	FCC Part 15: 15.207(a) RSS-Gen Issue 5 clause 8.8	Pass
Antenna Requirement	FCC Part 15: 15.203 RSS-Gen Issue 5 clause 6.8	Pass

2. General Test Information

2.1. Description of EUT

EUT Name	: HK Marine Headunit
Model Number	: HKMARSOHUG1A2B
EUT Function Description	: Please reference user manual of this device
Power Supply	: DC 12V
Radio Specification	: Bluetooth V4.2
Operation Frequency	: 2402 MHz - 2480 MHz
Modulation	: GFSK
Data Rate	: 1 Mbps
Antenna Gain	: 0.83 dBi
Sample Number	: S22091303-01

Note: EUT is the ab. of equipment under test.

Channel information					
Channel	Frequency (MHz)	Channel	Frequency (MHz)	Channel	Frequency (MHz)
0	2402	14	2430	28	2458
1	2404	15	2432	29	2460
2	2406	16	2434	30	2462
3	2408	17	2436	31	2464
4	2410	18	2438	32	2466
5	2412	19	2440	33	2468
6	2414	20	2442	34	2470
7	2416	21	2444	35	2472
8	2418	22	2446	36	2474
9	2420	23	2448	37	2476
10	2422	24	2450	38	2478
11	2424	25	2452	39	2480
12	2426	26	2454		
13	2428	27	2456		

2.2. Accessories of EUT

Description of Accessories	Manufacturer	Model number	Description	Remark
HK Marine Remote	Harman	HKMARSOREMG1	Input: DC 12V	N/A

2.3. Assistant equipment used for test

Assistant equipment	Manufacturer	Model number	EMC Compliance	SN
N/A	N/A	N/A	N/A	N/A

2.4. Block diagram of EUT configuration for test

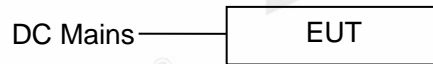

Test software: RTLBTAPP.exe

The test software was used to control EUT work in Continuous Tx mode, and select test channel, wireless mode as below table:

The pathloss of external cable: 0.5dB (According to the manufacturer's claims)

Tested mode, channel, information			
Mode	Setting Tx Power	Channel	Frequency (MHz)
GFSK 1M	Default	CH0	2402
	Default	CH19	2440
	Default	CH39	2480

2.5. Test environment conditions

Temperature range:	+15°C to +35 °C
Humidity range:	20% to 75%
Pressure range:	86 kPa to 106 kPa

2.6. Deviations of test standard

No deviation.

2.7. Test laboratory

Dongguan Dongdian Testing Service Co., Ltd.

Add.: No. 17, Zongbu Road 2, Songshan Lake Sci&Tech, Industry Park, Dongguan City, Guangdong Province, China, 523808.

Tel.: +86-0769-38826678, <http://www.dgddt.com>, Email: ddt@dgddt.com.

CNAS Accreditation No. L6451; A2LA Accreditation Number: 3870.01

FCC Designation Number: CN1182, Test Firm Registration Number: 540522

Innovation, Science and Economic Development Canada Site Registration Number: 10288A

Conformity Assessment Body identifier: CN0048

VCCI facility registration number: C-20087, T-20088, R-20123, R-20155, G-20118

2.8. Measurement uncertainty

Test Item	Uncertainty
Bandwidth	1.1%
Peak Output Power (Conducted) (Spectrum analyzer)	0.86 dB (10 MHz ≤ f < 3.6 GHz);
	1.38 dB (3.6 GHz ≤ f < 8 GHz)
Peak Output Power (Conducted) (Power Sensor)	0.74 dB
Power Spectral Density	0.74 dB (10 MHz ≤ f < 3.6 GHz);
	1.38 dB (3.6 GHz ≤ f < 8 GHz)
Frequencies Stability	6.7 x 10 ⁻⁸ (Antenna couple method)
	5.5 x 10 ⁻⁸ (Conducted method)
Conducted spurious emissions	0.86 dB (10 MHz ≤ f < 3.6 GHz);
	1.40 dB (3.6 GHz ≤ f < 8 GHz)
	1.66 dB (8 GHz ≤ f < 26.5 GHz)
Uncertainty for radio frequency (RBW < 20 kHz)	3x10 ⁻⁸
Temperature	0.4 °C
Humidity	2 %
Uncertainty for Radiation Emission test (9 kHz – 30 MHz)	3.44 dB
Uncertainty for Radiation Emission test (30 MHz - 1 GHz)	4.70 dB (Antenna Polarize: V)
	4.84 dB (Antenna Polarize: H)
Uncertainty for Radiation Emission test (1 GHz - 40 GHz)	4.10 dB (1 - 6 GHz)
	4.40 dB (6 GHz - 18 GHz)
	3.54 dB (18 GHz - 26 GHz)
	4.30 dB (26 GHz - 40 GHz)
Uncertainty for Power line conduction emission test	3.34dB (150KHz-30MHz)
	3.72dB (9KHz-150KHz)
Note: This uncertainty represents an expanded uncertainty expressed at approximately the 95% confidence level using a coverage factor of k=2.	

3. Equipment Used During Test

Equipment	Manufacturer	Model No.	Serial No.	Last Cal.	Cal. Interval
☑RF Connected Test (Tonscend RF Measurement System 2#)					
SIGNAL ANALYZER	R&S	FSQ26	101272	May 18, 2022	1 Year
RF Control Unit	Tonsend	JS0806-2	158060010	May 18, 2022	1 Year
Test Software	JS Tonscend	JS1120-3	Ver.3.2.22	N/A	N/A
☑Radiation 3#chamber					
EMI Test Receiver	R&S	ESU26	100472	May 19, 2022	1 Year
Spectrum analyzer	Agilent	E4447A	MY50180031	May 17, 2022	1 Year
Active Loop antenna	Schwarzbeck	FMZB-1519	1519-038	Sep. 29, 2022	1 Year
Trilog Broadband Antenna	Schwarzbeck	VULB 9163	01429	Jul. 22, 2022	1 Year
Double Ridged Horn Antenna	Schwarzbeck	BBHA9120 D	02468	Sep. 29, 2022	1 Year
Broad Band Horn Antenna	Schwarzbeck	BBHA 9170	790	May 06, 2022	1 Year
Pre-amplifier	COM-POWER	PAM-118A	18040084	Aug. 17, 2022	1 Year
Pre-amplifier	COM-POWER	PAM-840A	461369	Apr. 11, 2022 Apr. 11, 2023	1 Year
RE Cable	N/A	W23.02 CP1-X2 + W23.09 AP1-X8+ JCT26S-NJ-NJ-1.5M+ JCT26S-NJ-NJ-1.5M	4.5M+8M+1.5M+1.5M	Aug.17, 2022	1 Year
RF Cable	Yuhu Technology	JCTB810-NJ-NJ-9M	21123964	May 19, 2022	1 Year
RF Cable	Yuhu Technology	ZT26S-SMAJ-SMAJ-1M	21073466	Aug. 17, 2022	1 Year
Test software	Tonscend	JS32-RE	V 5.0.0.1	N/A	N/A
Test software	Audix	E3	V 6.1.1.1	N/A	N/A

4. 6 dB Bandwidth

4.1. Block diagram of test setup

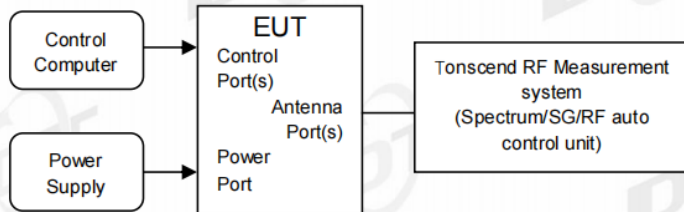

4.2. Limits

For direct sequence systems, the minimum 6 dB bandwidth shall be at least 500 kHz

4.3. Test procedure

- (1) The test according to ANSI C63.10-2013 clause 11.8.
- (2) Connect EUT's antenna output to spectrum analyzer by RF cable, the path loss was compensated to the results
- (3) Set the EUT as maximum power setting and enable the EUT transmit continuously
- (4) Use the following spectrum analyzer settings for 6 dB Bandwidth:

RBW:	100 kHz
VBW:	$\geq [3 \times \text{RBW}]$
Detector Mode:	peak
Sweep time:	auto
Trace mode	max hold
- (5) Allow the trace to stabilize, measure the 6 dB bandwidth of signal, and record the results in the report.

4.4. Test result

Test Mode	Antenna	Frequency [MHz]	DTS BW [MHz]	FL[MHz]	FH[MHz]	Limit [MHz]	Verdict
BLE_1M	Ant1	2402	0.71	2401.63	2402.34	0.5	PASS
		2440	0.71	2439.63	2440.34	0.5	PASS
		2480	0.72	2479.62	2480.34	0.5	PASS

4.5. Test graphs

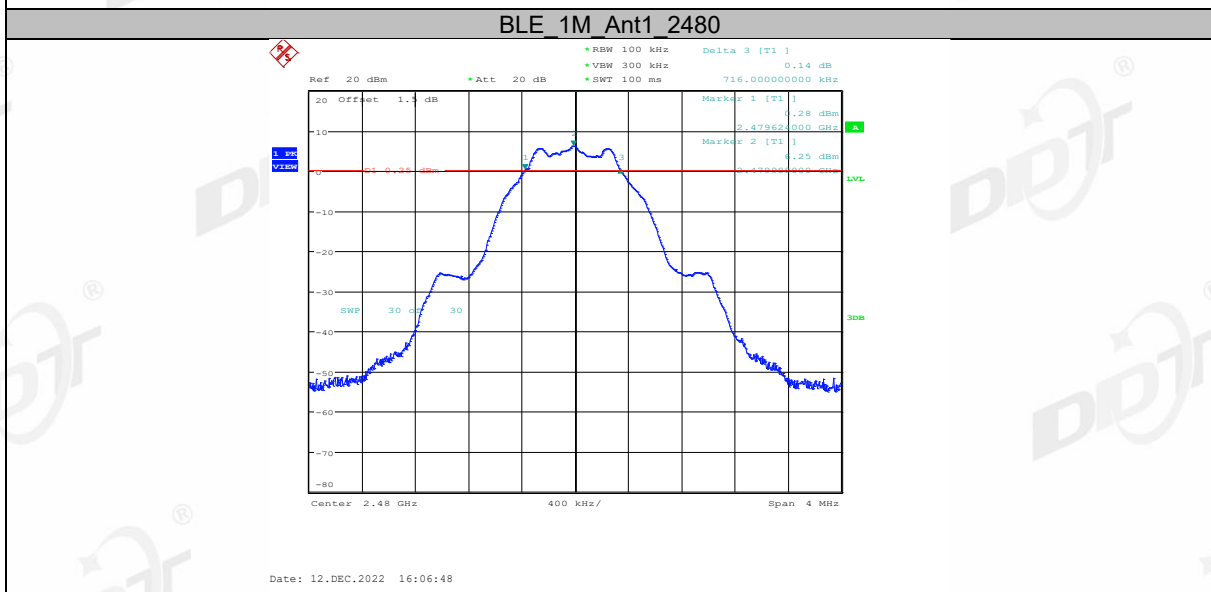
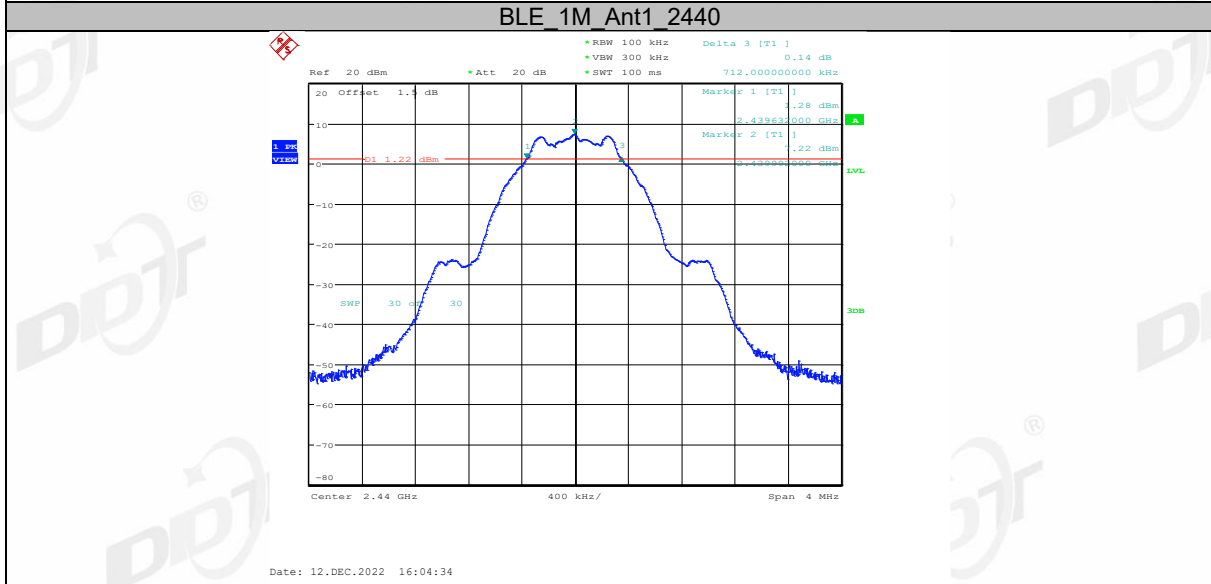
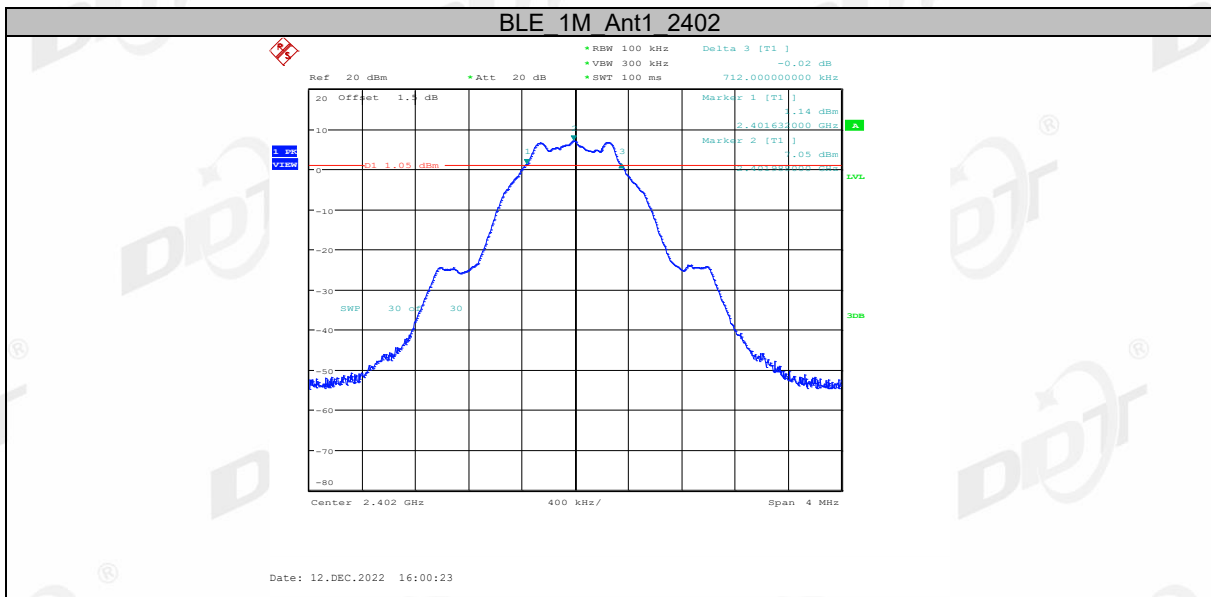

5. 99% Bandwidth

5.1. Block diagram of test setup

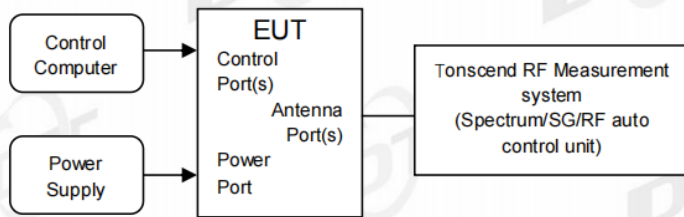

5.2. Limits

Just for Report.

5.3. Test procedure

- (6) The test according to ANSI C63.10-2013 clause 6.9.3.
- (7) Connect EUT's antenna output to spectrum analyzer by RF cable, the path loss was compensated to the results
- (8) Set the EUT as maximum power setting and enable the EUT transmit continuously
- (9) Use the following spectrum analyzer settings for the 99% Bandwidth:

RBW:	1% to 5% of the OBW
VBW:	approximately three times RBW
Span:	between 1.5 times and 5.0 times the OBW
Detector Mode:	peak
Sweep time:	auto
Trace mode	max hold
- (10) Allow the trace to stabilize, measure the 99% bandwidth of signal, and record the results in the report.

5.4. Test Result

TestMode	Antenna	Frequency[MHz]	OCB [MHz]	FL[MHz]	FH[MHz]	Limit[MHz]	Verdict
BLE_1M	Ant1	2402	1.040	2401.4760	2402.5160	---	---
		2440	1.044	2439.4720	2440.5160	---	---
		2480	1.040	2479.4760	2480.5160	---	---

5.5. Test Graphs

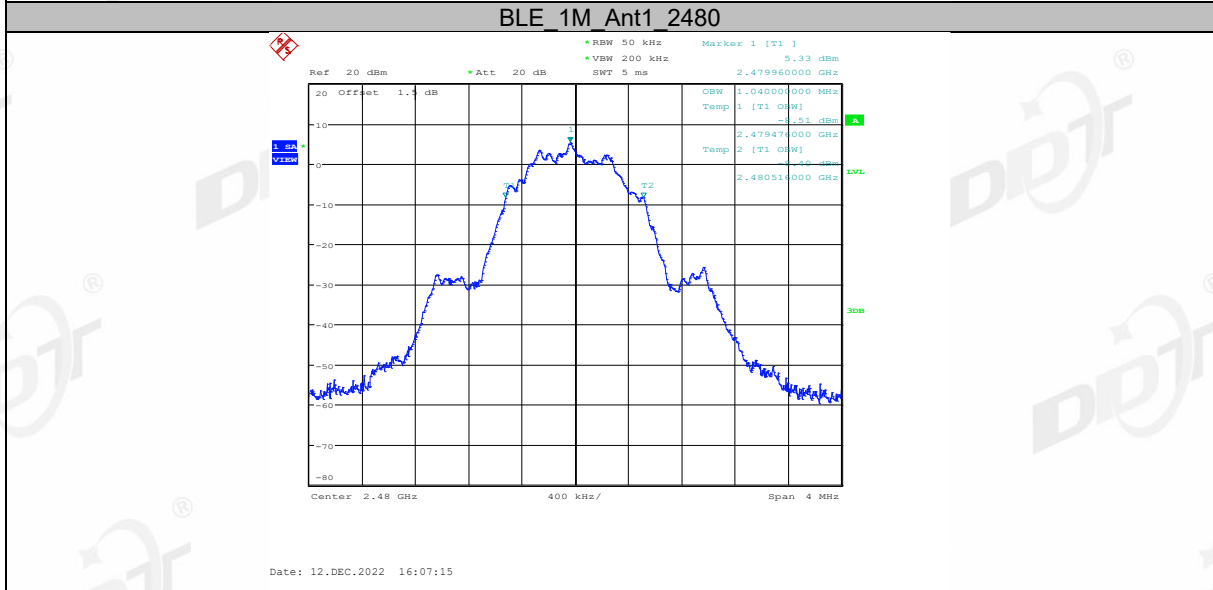
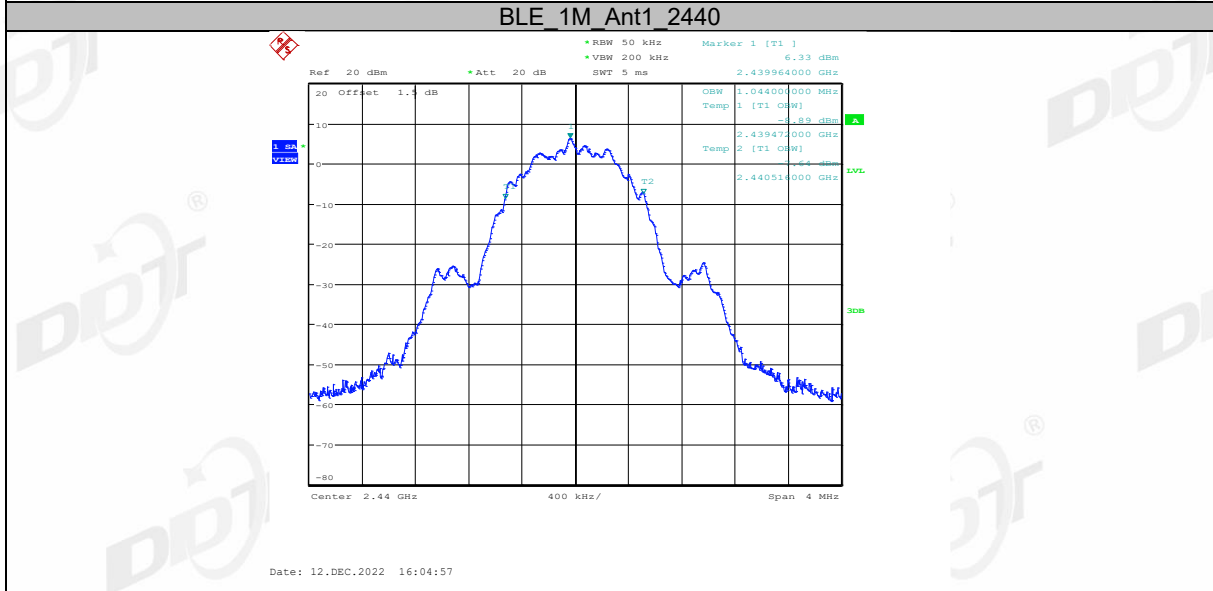
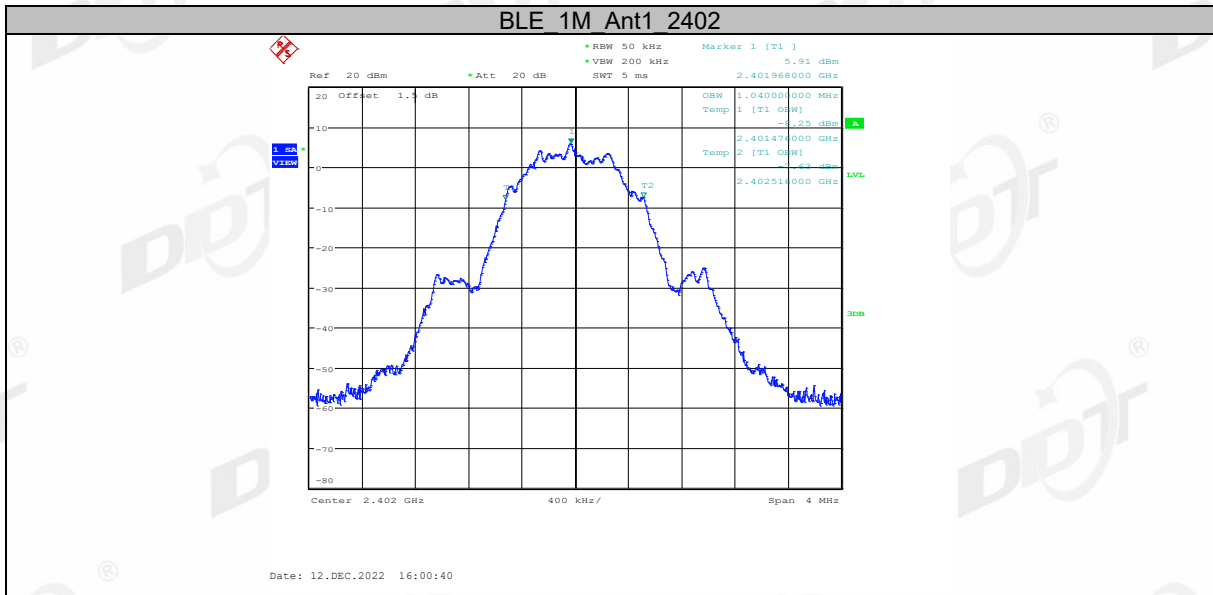

6. Maximum Peak Output Power

6.1. Block diagram of test setup

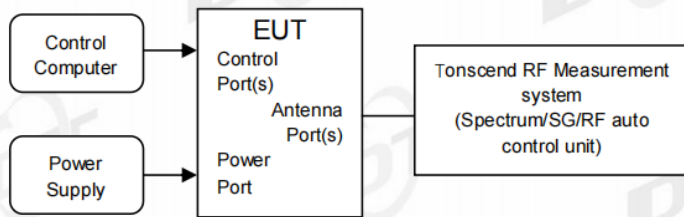

6.2. Limits

For systems using digital modulation in the 902-928 MHz, 2400-2483.5 MHz, and 5725-5850 MHz bands: 1 Watt. If transmitting antennas of directional gain greater than 6dBi are used, the conducted output power from the intentional radiator shall be reduced below the stated values as appropriate, by the amount in dB that the directional gain of the antenna exceeds 6 dBi, the e.i.r.p shall not exceed 4W.

6.3. Test procedure

- (1) The test according to ANSI C63.10-2013 clause 11.9.1.1.
- (2) Connect EUT's antenna output to spectrum analyzer by RF cable, the path loss was compensated to the results.
- (3) Set the EUT as maximum power setting and enable the EUT transmit continuously.
- (4) Use the following spectrum analyzer settings for the maximum peak output power measurement:

RBW:	≥DTS bandwidth
VBW:	≥3 x RBW
Span	≥3 x RBW
Detector Mode:	peak
Sweep time:	auto
Trace mode	max hold

- (5) Allow the trace to stabilize, use peak marker function to determine the peak amplitude level.

6.4. Test result peak

Test Mode	Antenna	Frequency [MHz]	Conducted Peak Power[dBm]	Conducted Limit[dBm]	EIRP[dBm]	EIRP Limit[dBm]	Verdict
BLE_1M	Ant1	2402	8.18	≤30	9.01	≤36	PASS
		2440	8.39	≤30	9.22	≤36	PASS
		2480	7.66	≤30	8.49	≤36	PASS

6.5. Test graphs peak

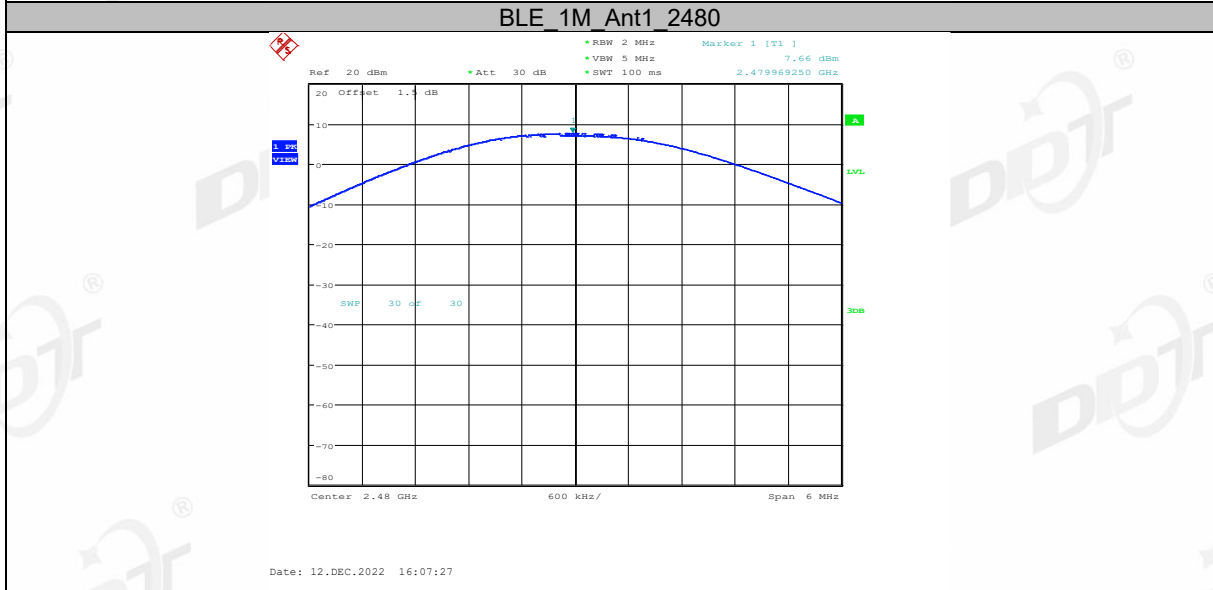
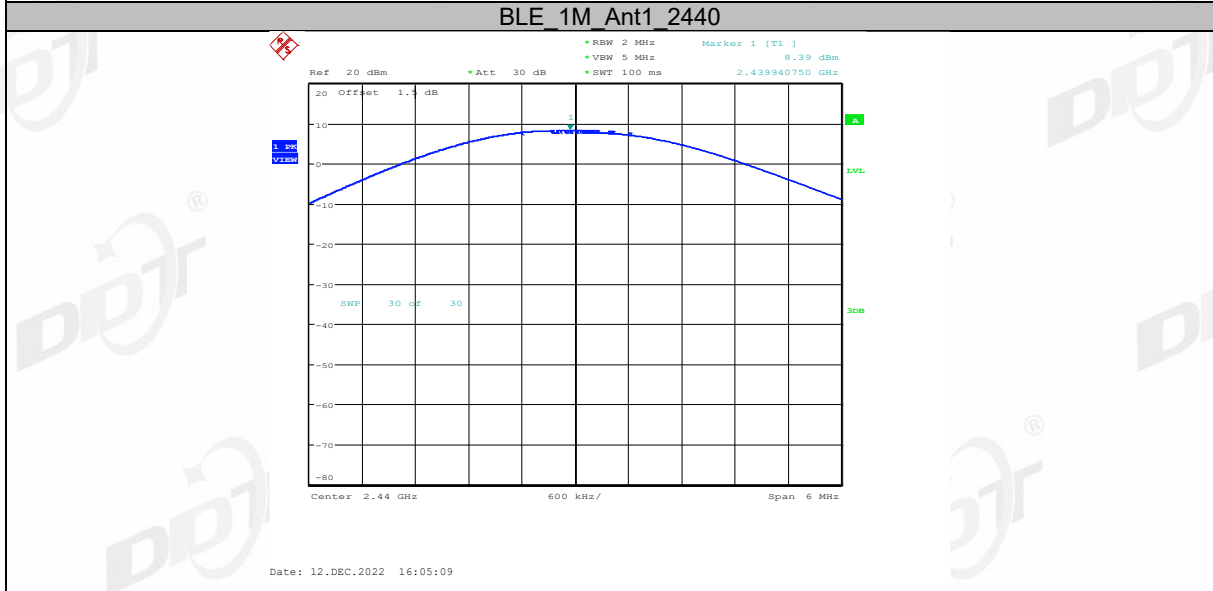
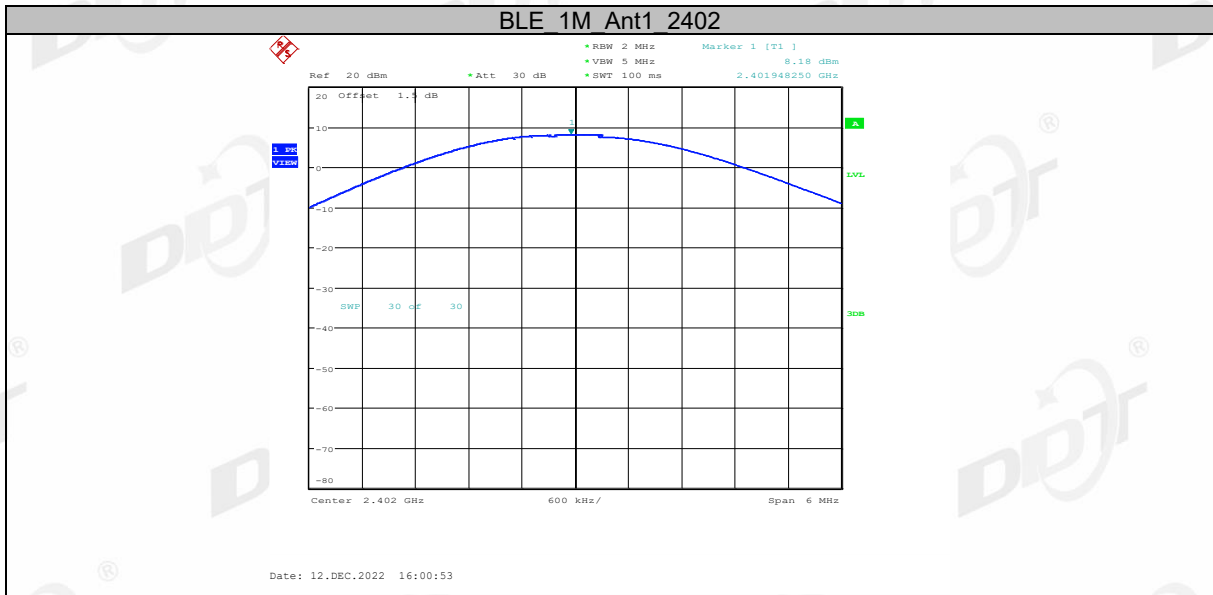

7. Power Spectral Density

7.1. Block diagram of test setup

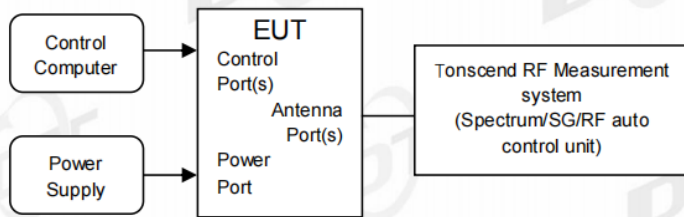

7.2. Limits

For digitally modulated systems, the power spectral density conducted from the intentional radiator to the antenna shall not be greater than 8 dBm in any 3 kHz band during any time interval of continuous transmission.

7.3. Test procedure

- (1) The test according to ANSI C63.10-2013 clause 11.10.2.
- (2) Connect EUT's antenna output to spectrum analyzer by RF cable, the path loss was compensated to the results.
- (3) Set the EUT as maximum power setting and enable the EUT transmit continuously.
- (4) Use the following spectrum analyzer settings for Power Spectral Density measurement:

Center frequency	DTS Channel center frequency
RBW:	$3 \text{ kHz} \leq \text{RBW} \leq 100 \text{ kHz}$
VBW:	$\geq 3\text{RBW}$
Span	1.5 times the DTS bandwidth
Detector Mode:	peak
Sweep time:	auto
Trace mode	max hold
- (5) Allow the trace to stabilize, use the peak marker function to determine the maximum amplitude level within the RBW.

If measured value exceeds limit, reduce RBW (no less than 3 kHz) and repeat.

7.4. Test result

Test Mode	Antenna	Frequency [MHz]	Result [dBm/3kHz]	Limit [dBm/3kHz]	Verdict
BLE_1M	Ant1	2402	-7.43	≤ 8.00	PASS
		2440	-7.44	≤ 8.00	PASS
		2480	-9.31	≤ 8.00	PASS

7.5. Test graphs

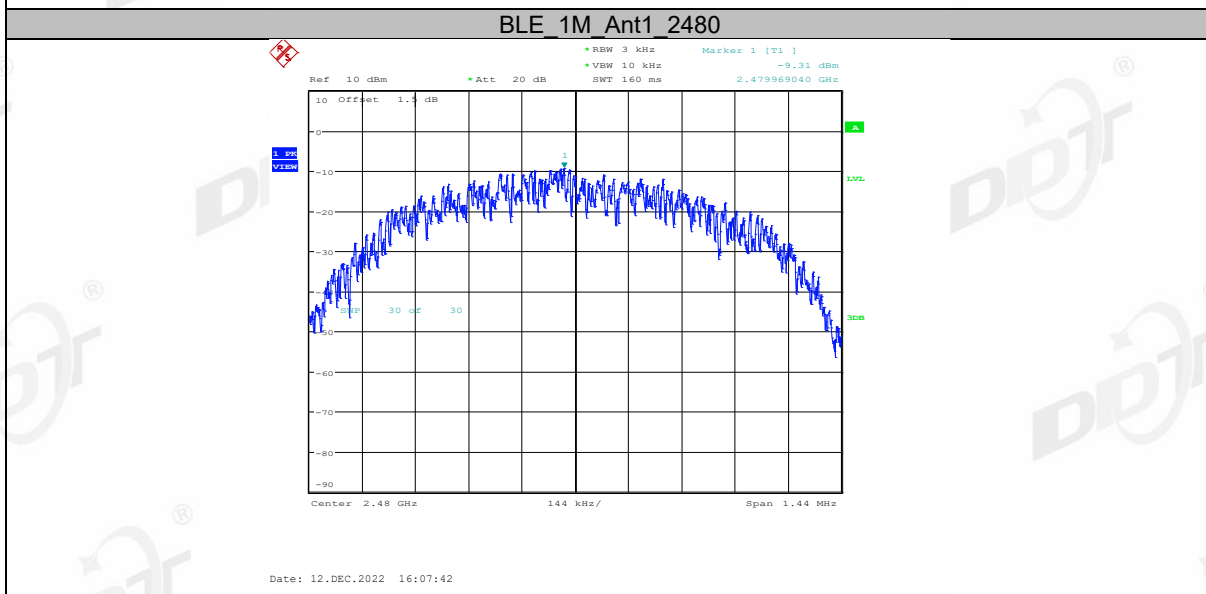
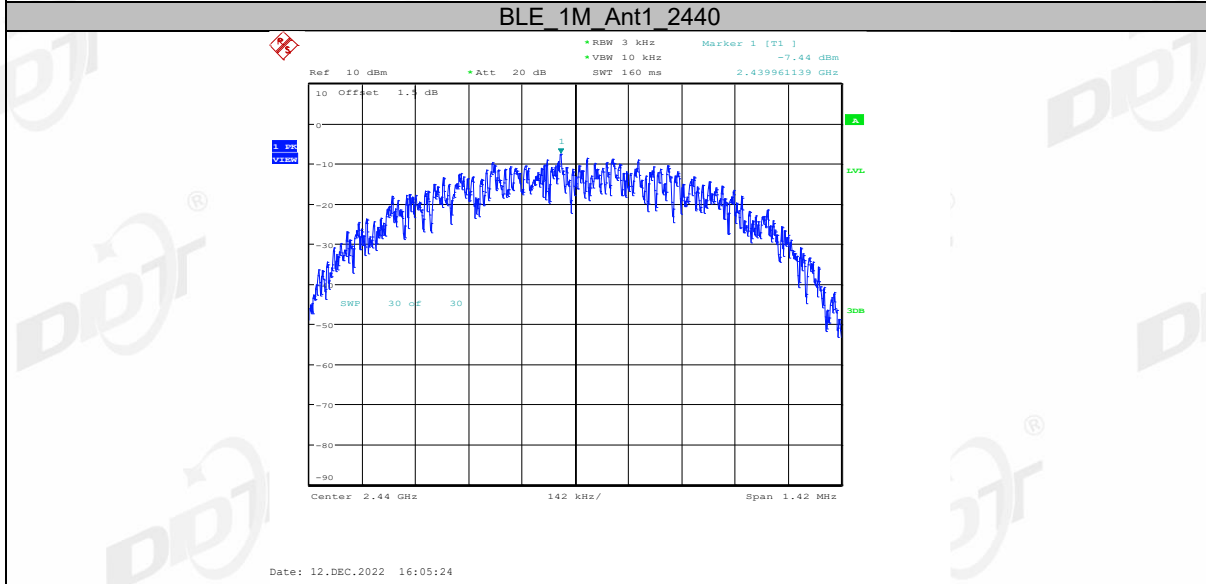
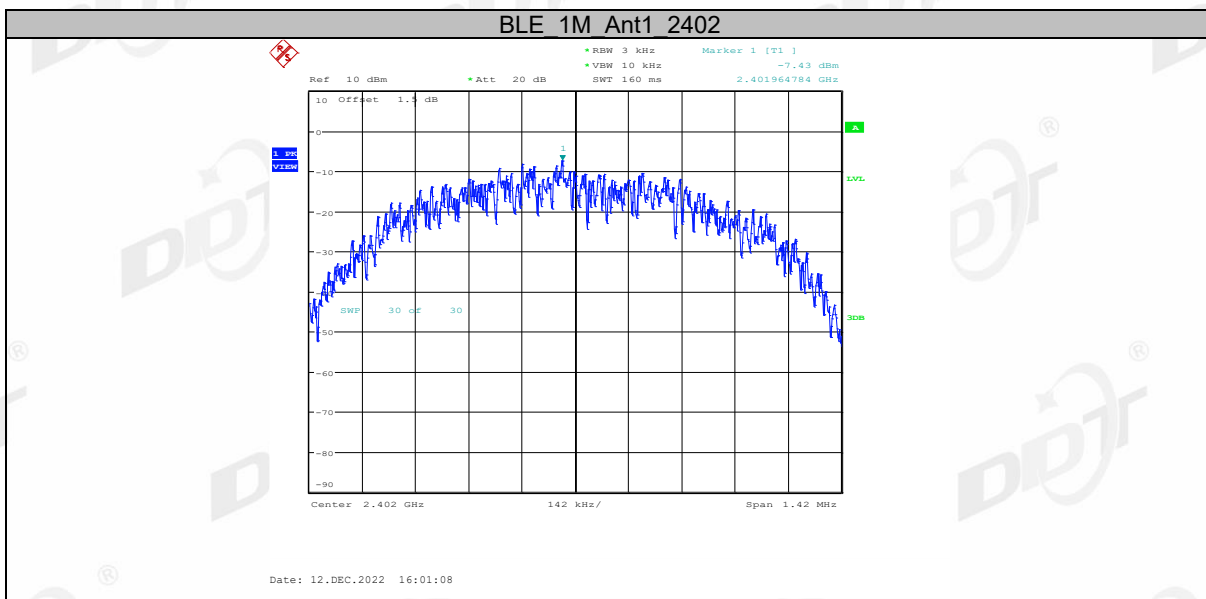

8. Band Edge Compliance (Conducted Method)

8.1. Block diagram of test setup

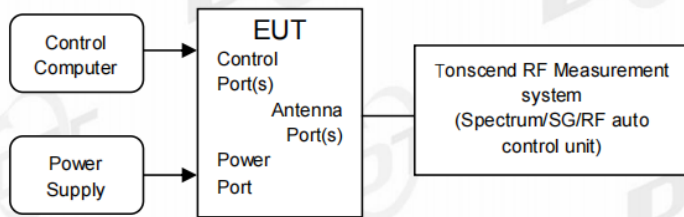

8.2. Limits

In any 100 kHz bandwidth outside the frequency bands in which the spread spectrum intentional radiator is operating, the radio frequency power that is produced by the intentional radiator shall be at least 20 dB below that in the 100 kHz bandwidth within the band that contains the highest level of the desired power.

8.3. Test procedure

(1) Connect EUT's antenna output to spectrum analyzer by RF cable.

(2) Establish a reference level by using the following procedure:

RBW:	100 kHz
VBW:	300 kHz
Span	Encompass frequency range to be measured
Detector Mode:	Peak
Sweep time:	Auto
Trace mode	Max hold

(3) Allow the trace to stabilize, use the peak marker function to determine the maximum peak power level to establish the reference level.

(4) Then mark the maximum amplitude of all unwanted emissions outside of the authorized frequency band.

8.4. Test result

EUT Set Mode	CH or Frequency	Measured Range	Verdict
GFSK 1M	CH0	2.310 GHz - 2.410 GHz	Pass
	CH39	2.470 GHz - 2.500 GHz	Pass

8.5. Test graphs

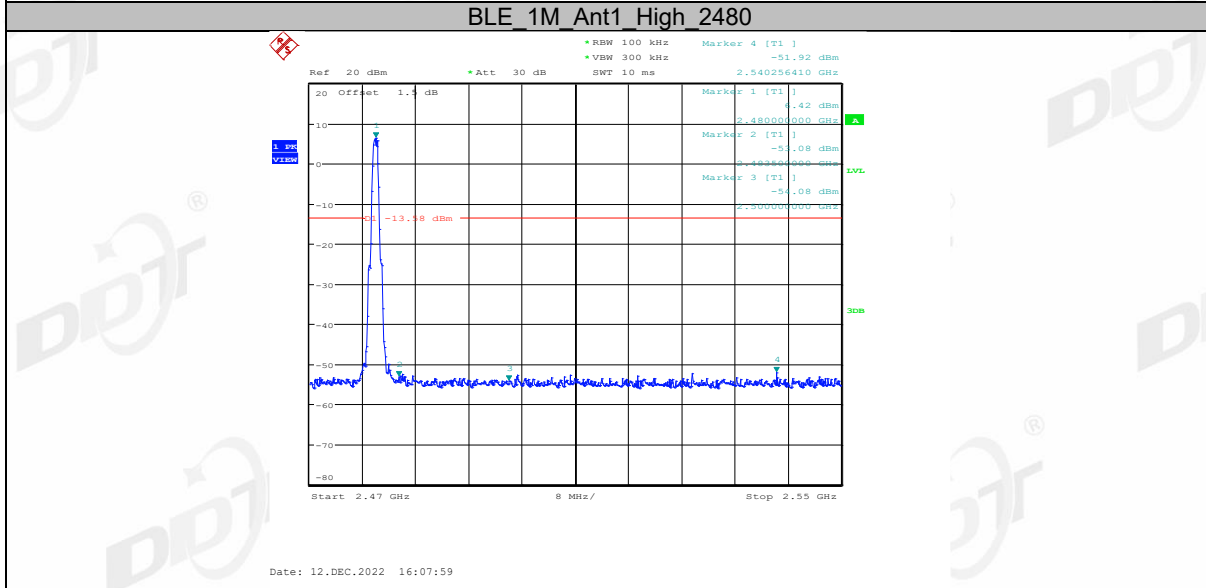
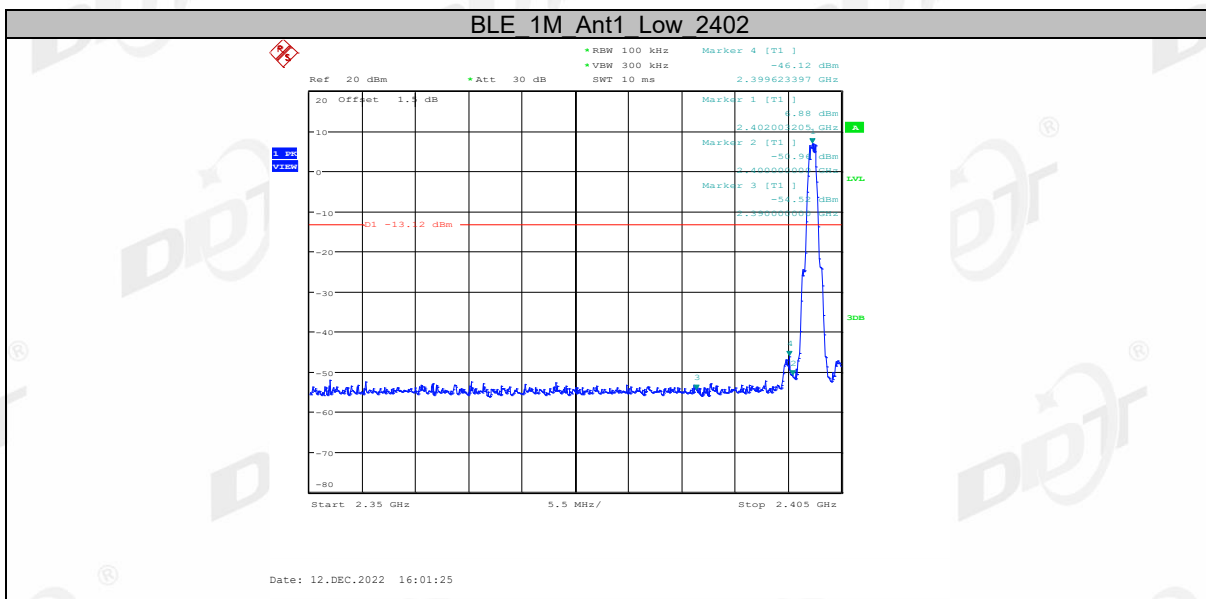

9. RF Conducted Spurious Emissions

9.1. Block diagram of test setup

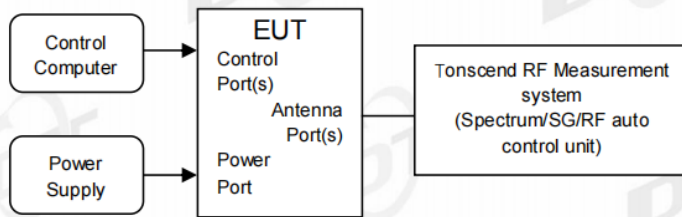

9.2. Limits

In any 100 kHz bandwidth outside the frequency bands in which the spread spectrum intentional radiator is operating, the radio frequency power that is produced by the intentional radiator shall be at least 20 dB below that in the 100 kHz bandwidth within the band that contains the highest level of the desired power.

9.3. Test procedure

- (1) Connect EUT's antenna output to spectrum analyzer by RF cable.
- (2) Establish a reference level by using the following procedure:

Center frequency	Test frequency
RBW:	100 kHz
VBW:	300 kHz
Span	Wide enough to capture the peak level of the in-band emission
Detector Mode:	Peak
Sweep time:	Auto
Trace mode	Max hold

- (3) Allow the trace to stabilize, use the peak marker function to determine the maximum peak power level to establish the reference level.

- (4) Set the spectrum analyzer as follows:

RBW:	100 kHz
VBW:	300 kHz
Span	Encompass frequency range to be measured
Number of measurement points	$\geq \text{Span}/\text{RBW}$
Detector Mode:	Peak
Sweep time:	Auto
Trace mode	Max hold

Allow the trace to stabilize, use the peak marker function to determine the maximum amplitude of all unwanted emissions outside of the authorized frequency band

9.4. Test result

Mode	Freq. (MHz)	Verdict
GFSK 1M	2402	Pass
	2440	Pass
	2480	Pass

9.5. Test graphs

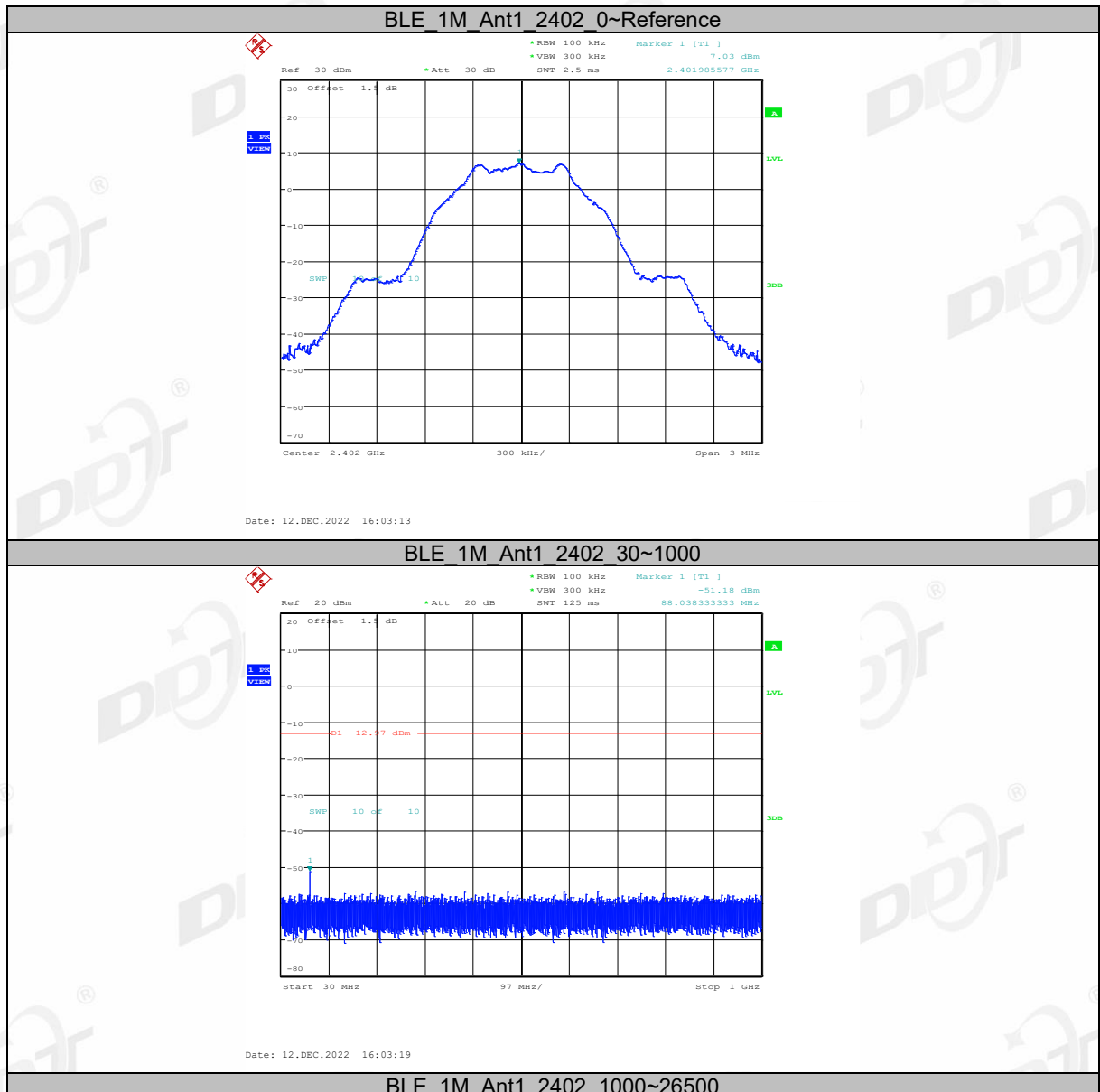

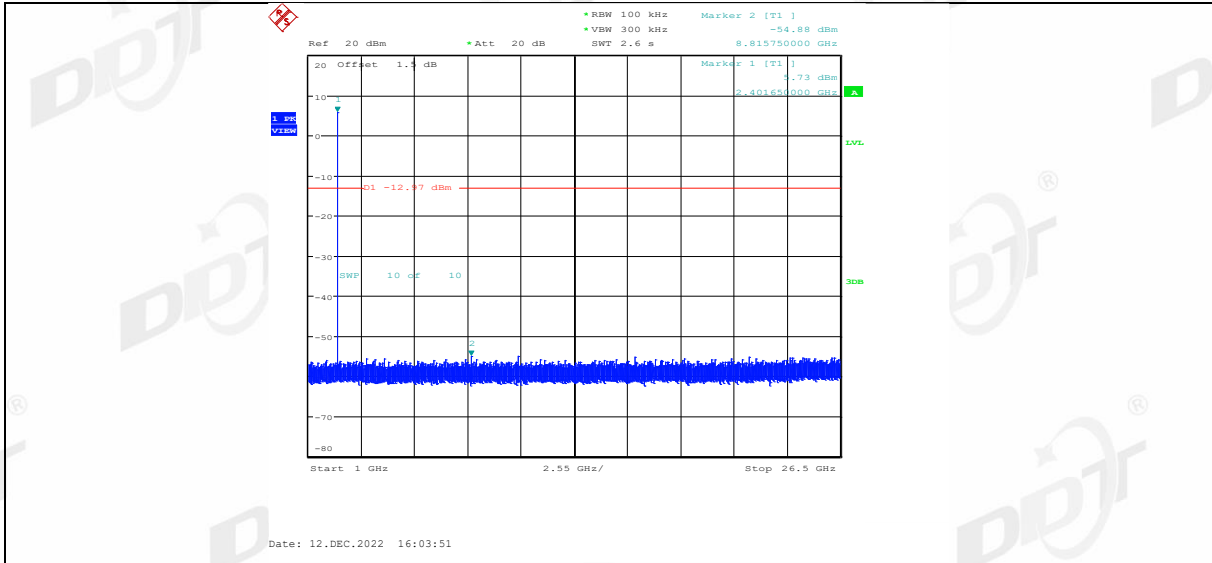

BLE 1M Ant1 2440 0~Reference

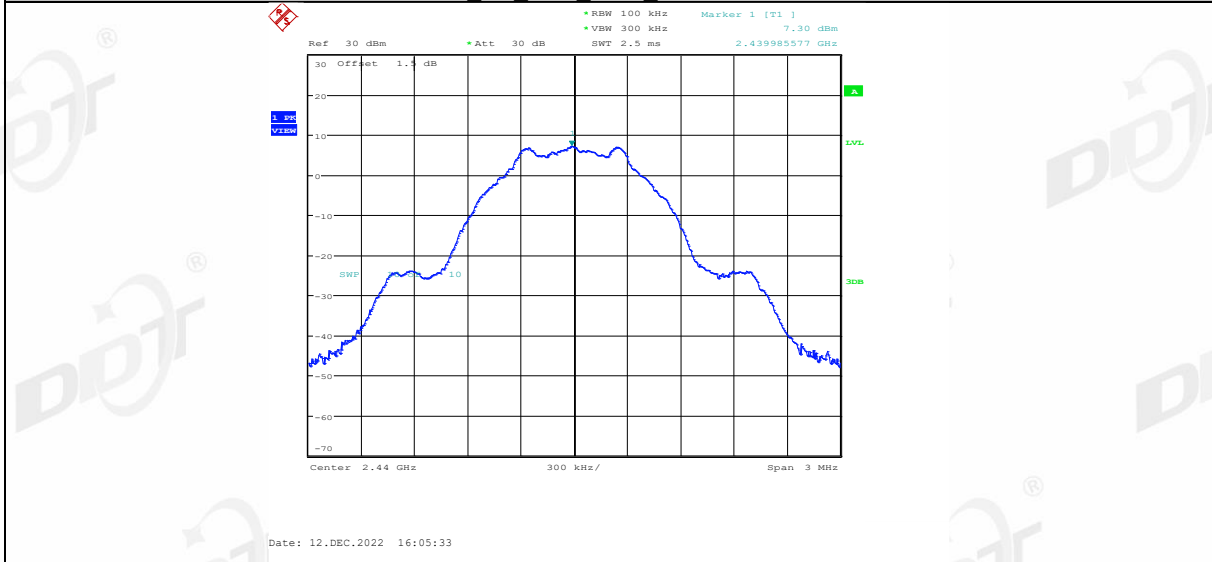

BLE 1M Ant1 2440 30~1000

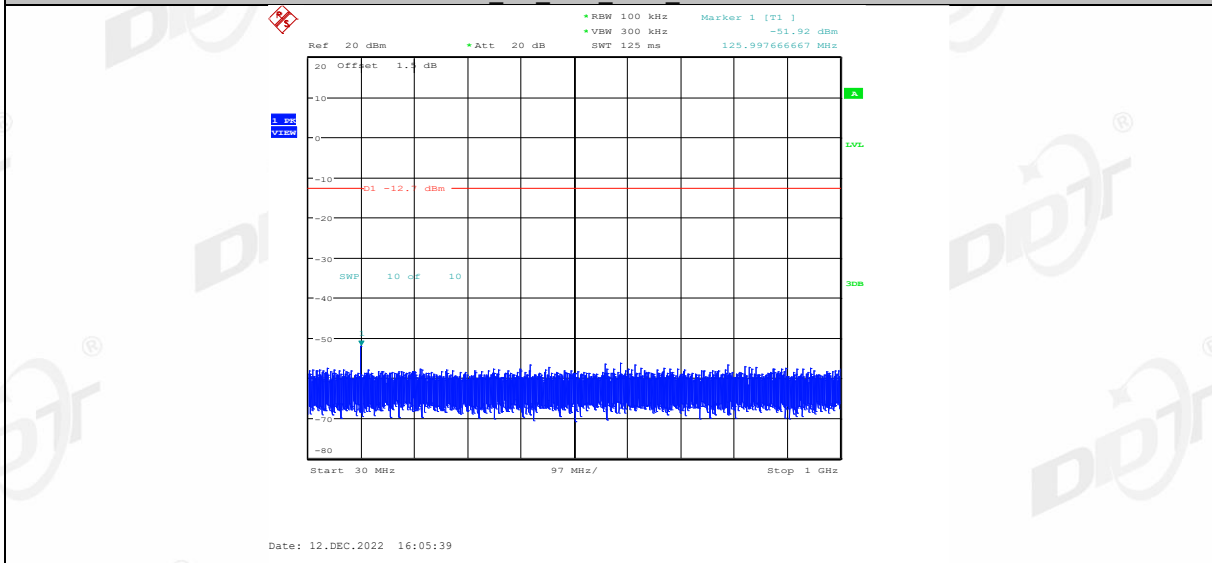

BLE 1M Ant1 2440 1000~26500

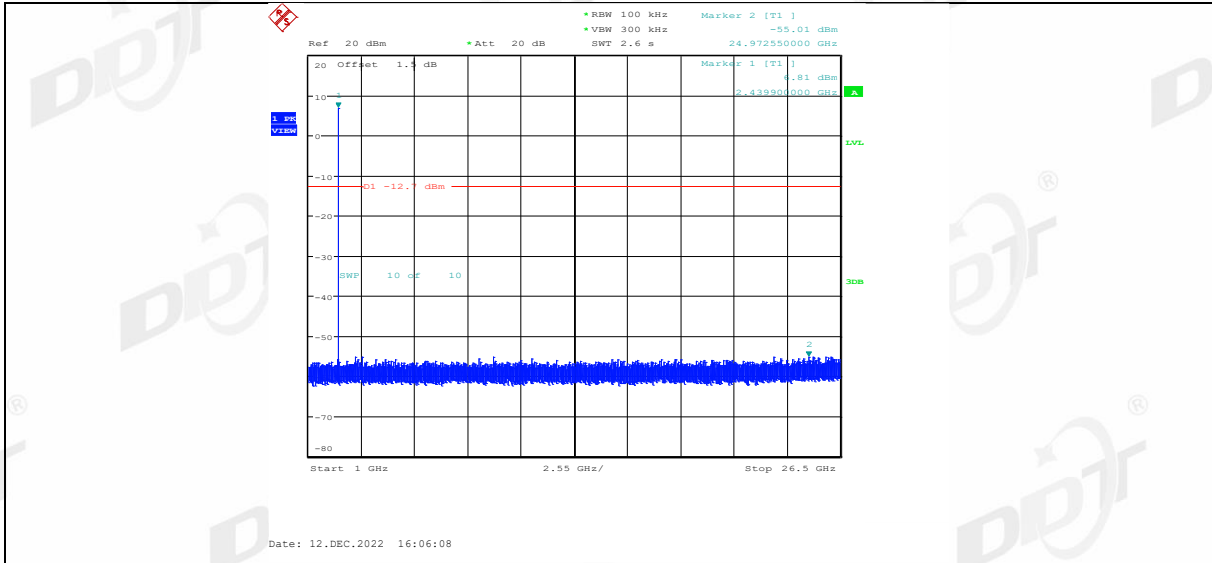

BLE 1M Ant1 2480 0~Reference

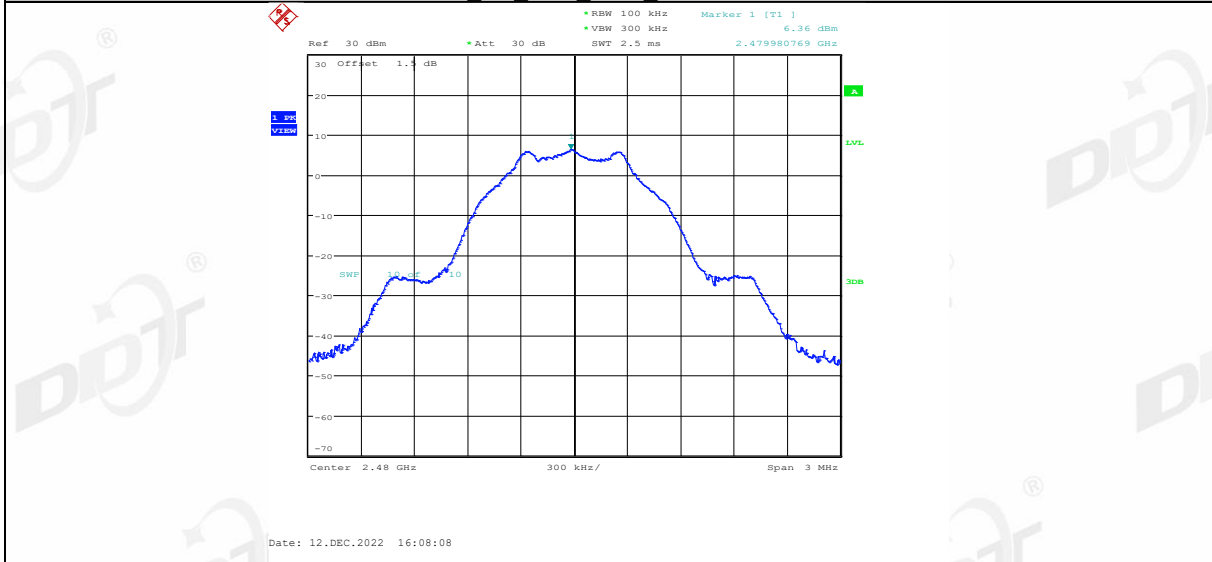

BLE 1M Ant1 2480 30~1000

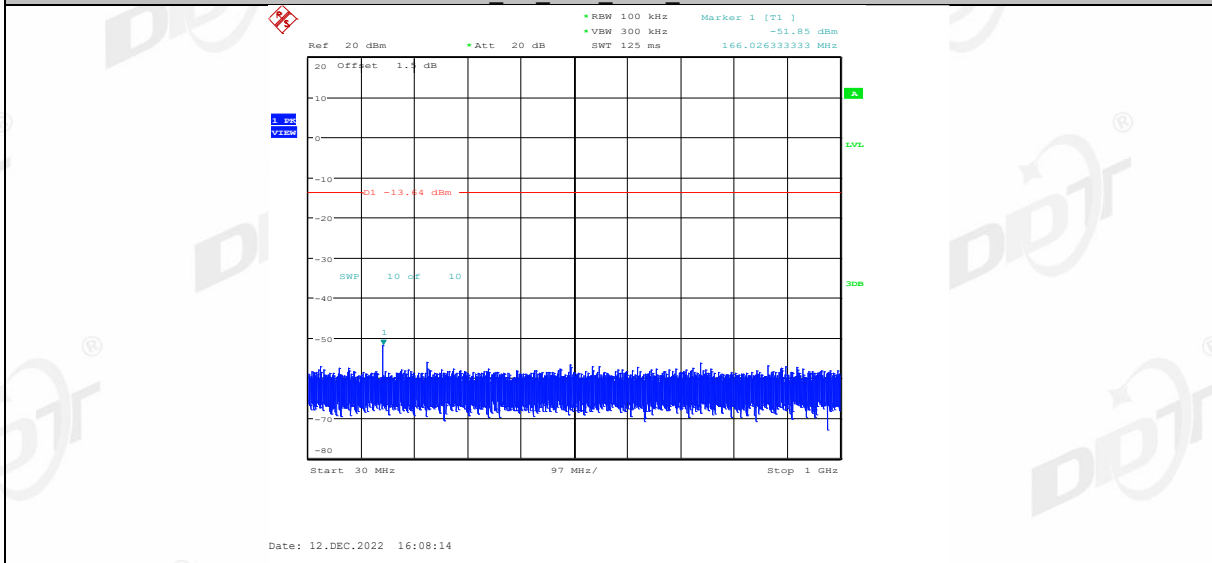

BLE 1M Ant1 2480 1000~26500

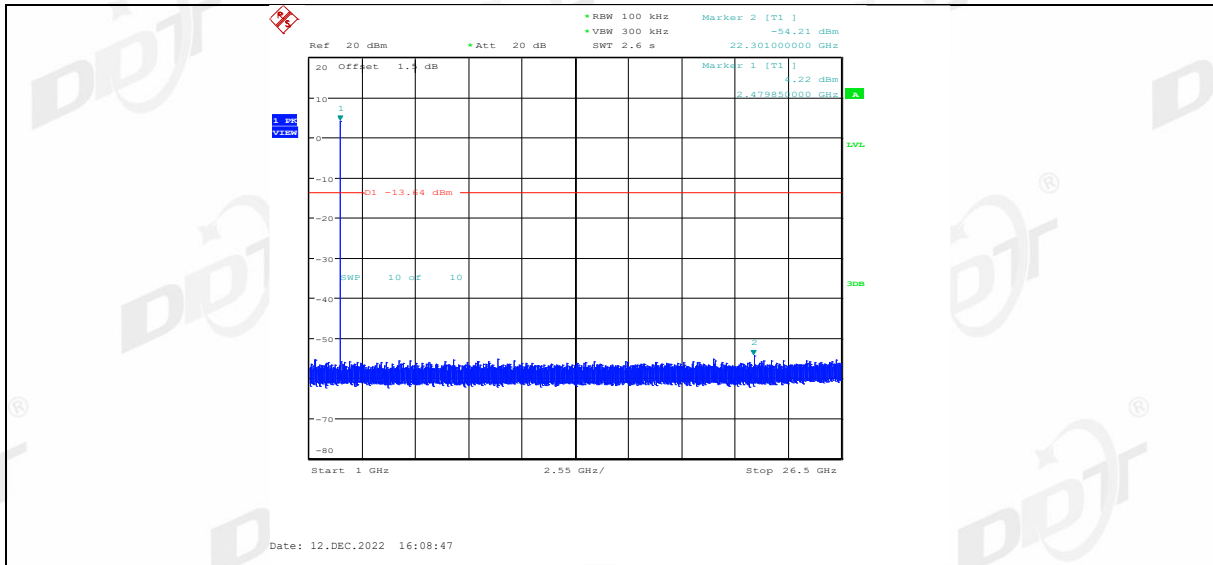

10. Duty Cycle

10.1. Block diagram of test setup

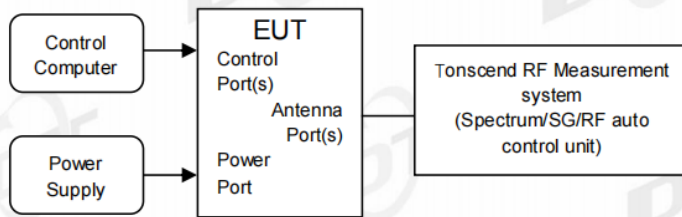

10.2. Limit

Just for Report.

10.3. Test procedure

- (1) Connected the EUT's antenna port to the Spectrum Analyzer by suitable attenuator, The cable loss and attenuator loss have been put into spectrum analyzer as amplitude offset.

set the Spectrum Analyzer as below:

Centre Frequency: The centre frequency of the middle hopping channel.

Resolution BW: 1 MHz.

Video BW: 1 MHz.

Span: Zero span.

Detector: Peak.

Trace Mode: Clear Write.

Sweep: Video Trigger

- (2) When the trace is complete, measure the sending time of 1 burst and the duty cycle of 1 burst cycle.

- (3) Calculate dwell time follow below formula:

$$\text{Duty cycle} = \text{Pulse's on time} / \text{Burst cycle}$$

10.4. Test result

Test Mode	Antenna	Frequency [MHz]	ON Time [ms]	Period [ms]	Duty Cycle [%]	Duty Cycle Factor[dB]
BLE_1M	Ant1	2402	0.40	0.63	63.49	1.97
		2440	0.40	0.63	63.49	1.97
		2480	0.40	0.63	63.49	1.97

10.5. Test graphs

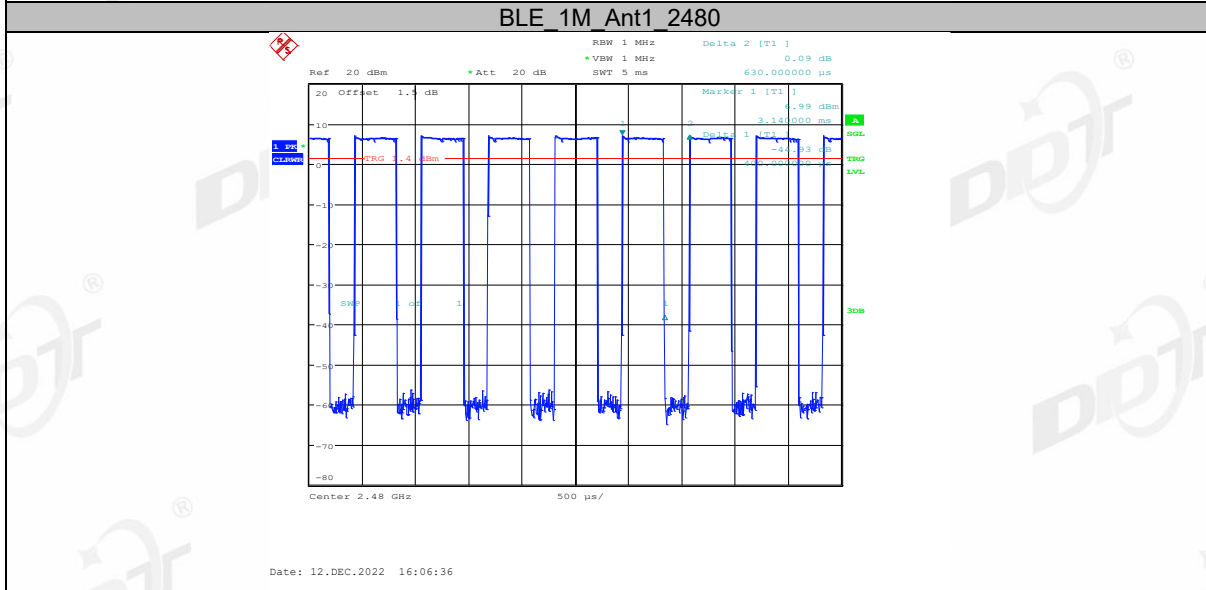
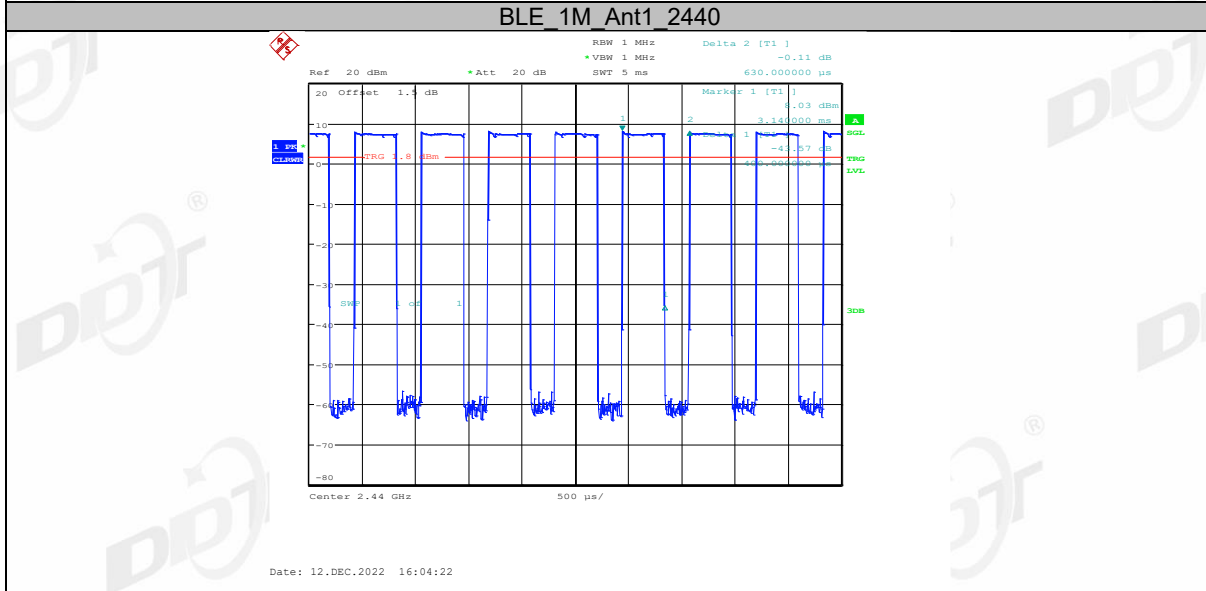
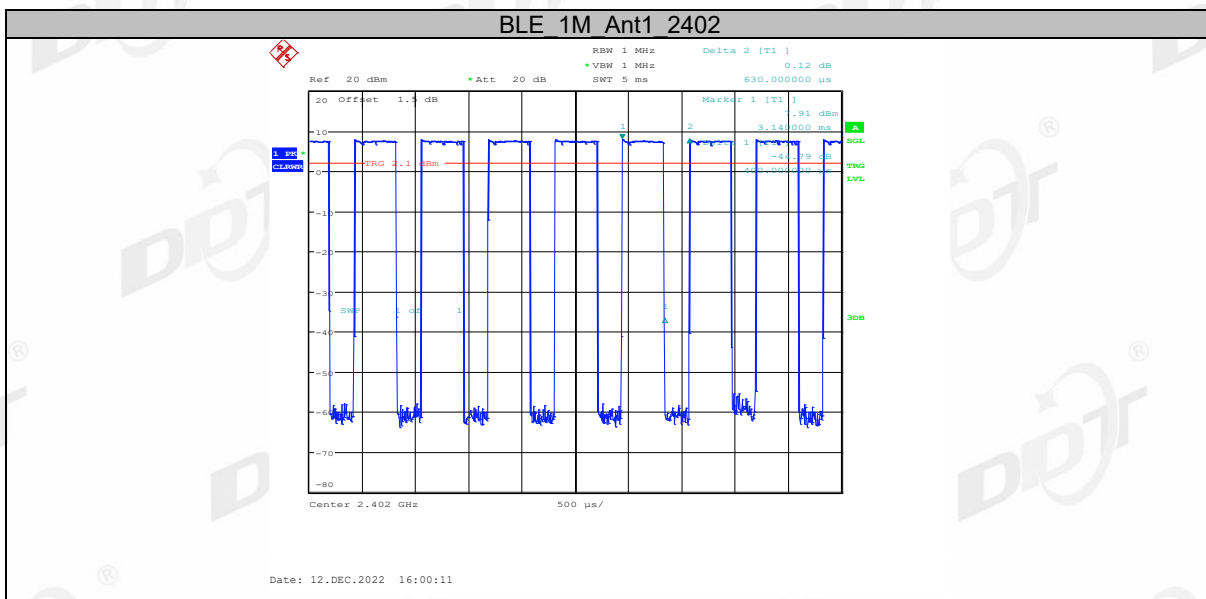

11. Radiated Emission

11.1. Block diagram of test setup

In 3 m Anechoic Chamber, test setup diagram for 9 kHz - 30 MHz:

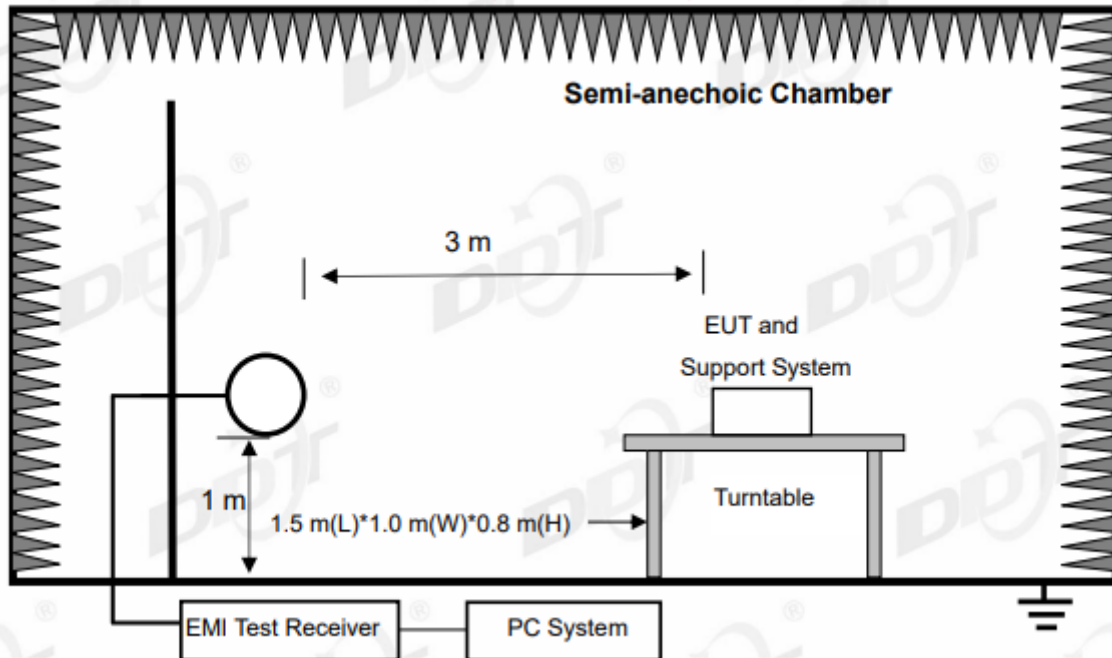

In 3 m Anechoic Chamber, test setup diagram for 30 MHz - 1 GHz:

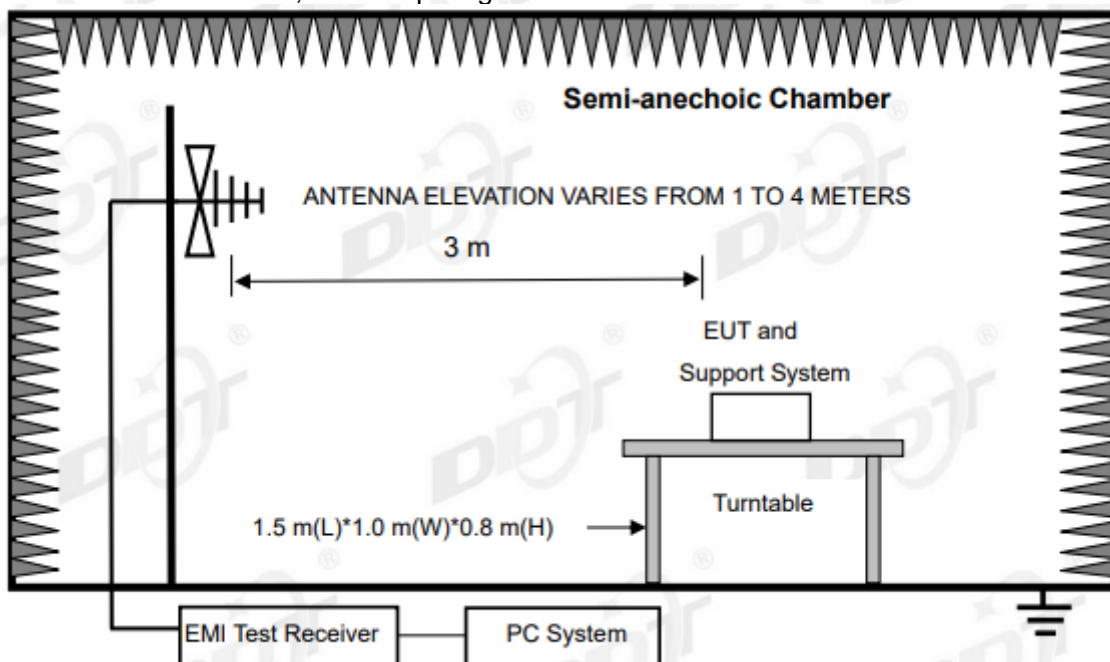

In 3 m Anechoic Chamber, test setup diagram for frequency above 1 GHz:

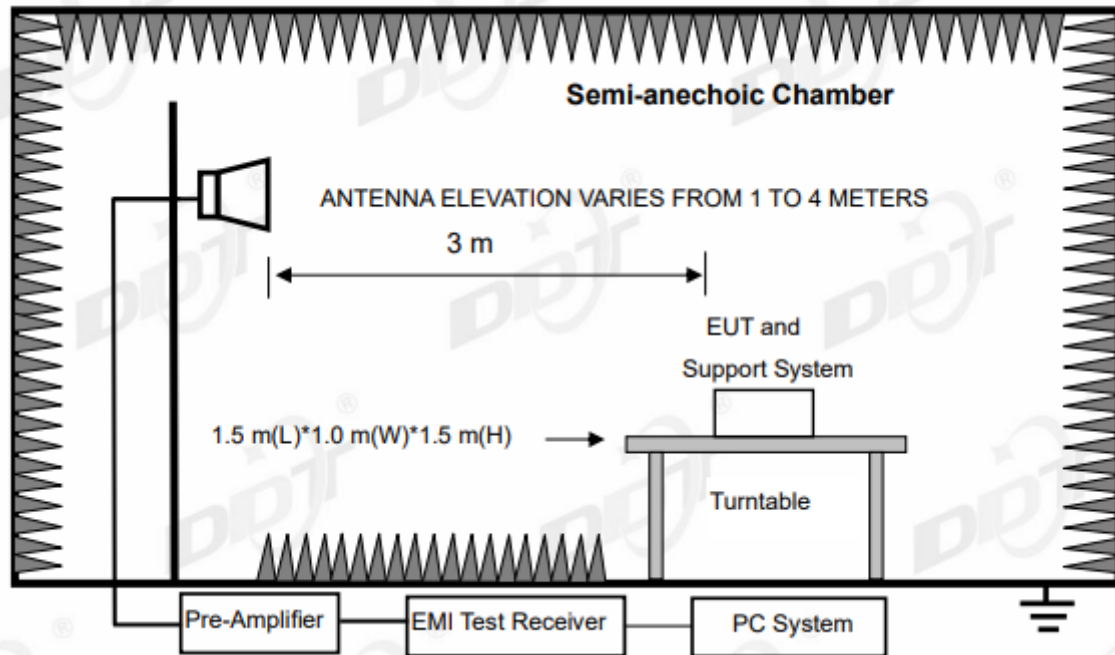

Note: For harmonic emissions test an appropriate high pass filter was inserted in the input port of AMP.

11.2. Limit

(1) FCC 15.205 Restricted frequency band

MHz	MHz	MHz	GHz
0.090-0.110	16.42-16.423	399.9-410	4.5-5.15
¹ 0.495-0.505	16.69475-16.69525	608-614	5.35-5.46
2.1735-2.1905	16.80425-16.80475	960-1240	7.25-7.75
4.125-4.128	25.5-25.67	1300-1427	8.025-8.5
4.1772&4.17775	37.5-38.25	1435-1626.5	9.0-9.2
4.2072&4.20775	73-74.6	1645.5-1646.5	9.3-9.5
6.215-6.218	74.8-75.2	1660-1710	10.6-12.7
6.26775-6.26825	108-121.94	1718.8-1722.2	13.25-13.4
6.31175-6.31225	123-138	2200-2300	14.47-14.5
8.291-8.294	149.9-150.05	2310-2390	15.35-16.2
8.362-8.366	156.52475-156.52525	2483.5-2500	17.7-21.4
8.37625-8.38675	156.7-156.9	2690-2900	22.01-23.12
8.41425-8.41475	162.0125-167.17	3260-3267	23.6-24.0
12.29-12.293	167.72-173.2	3332-3339	31.2-31.8
12.51975-12.52025	240-285	3345.8-3358	36.43-36.5
12.57675-12.57725	322-335.4	3600-4400	(²)
13.36-13.41			

¹Until February 1, 1999, this restricted band shall be 0.490-0.510 MHz.

²Above 38.6

RSS-Gen section 8.10 Restricted frequency bands*

MHz	MHz	MHz	GHz
0.090-0.110	12.51975-12.52025	240-285	3.5-4.4
0.495-0.505	12.57675-12.57725	322-335.4	4.5-5.15
2.1735-2.1905	13.36-13.41	399.9-410	5.35-5.46
3.020-3.026	16.42-16.423	608-614	7.25-7.75
4.125-4.128	16.69475-16.69525	960-1427	8.025-8.5
4.1772&4.17775	16.80425-16.80475	1435-1626.5	9.0-9.2
4.2072&4.20775	25.5-25.67	1645.5-1646.5	9.3-9.5
5.677-5.683	37.5-38.25	1660-1710	10.6-12.7
6.215-6.218	73-74.6	1718.8-1722.2	13.25-13.4
6.26775-6.26825	74.8-75.2	2200-2300	14.47-14.5
6.31175-6.31225	108-138	2310-2390	15.35-16.2
8.291-8.294	149.9-150.05	2483.5-2500	17.7-21.4
8.362-8.366	156.52475-156.52525	2655-2900	22.01-23.12
8.37625-8.38675	156.7-156.9	3260-3267	23.6-24.0
8.41425-8.41475	162.0125-167.17	3332-3339	31.2-31.8
12.29-12.293	167.72-173.2	3345.8-3358	36.43-36.5
			Above 38.6

* Certain frequency bands listed in table and in bands above 38.6 GHz are designated for licence-exempt applications. These frequency bands and the requirements that apply to related devices are set out in the 200 and 300 series of RSSs.

(2) FCC 15.209 Limit & RSS-Gen section 8.9 Limit

FREQUENCY MHz	DISTANCE Meters	FIELD STRENGTHS LIMIT	
		$\mu\text{V}/\text{m}$	$\text{dB}(\mu\text{V})/\text{m}$
0.009 ~ 0.490	300	2400/F(kHz)	67.6-20log(F)
0.490 ~ 1.705	30	24000/F(kHz)	87.6-20log(F)
1.705 ~ 30.0	30	30	29.54
30 ~ 88	3	100	40.0
88 ~ 216	3	150	43.5
216 ~ 960	3	200	46.0
960 ~ 1000	3	500	54.0
Above 1000	3	74.0 dB(μV)/m (Peak) 54.0 dB(μV)/m (Average)	

Note: (1) The emission limits shown in the above table are based on measurements employing a CISPR QP detector except for the frequency bands 9 - 90 kHz, 110 - 490 kHz and above 1000 MHz. Radiated emissions limits in these three bands are based on measurements employing an average detector.

(2) At frequencies below 30 MHz, measurement may be performed at a distance closer than that specified, and the limit at closer measurement distance can be extrapolated by below formula:

$$\text{Limit}_{3\text{m}}(\text{dB}\mu\text{V}/\text{m}) = \text{Limit}_{30\text{m}}(\text{dB}\mu\text{V}/\text{m}) + 40\text{Log}(30\text{m}/3\text{m})$$

(3) Limit for this EUT

The emissions appearing within 15.205 restricted frequency bands shall not exceed the limits

shown in 15.209, and the emissions appearing within RSS-Gen section 8.10 Restricted frequency bands shall not exceed the limits shown in RSS-Gen section 8.9, all the other emissions shall be at least 20 dB below the fundamental emissions or comply with 15.209 limits and RSS-Gen section 8.9 limits.

11.3. Test Procedure

- (1) EUT was placed on a non-metallic table, 80 cm above the ground plane inside a semi-anechoic chamber for below 1 G and 150 cm above the ground plane inside a semi-anechoic chamber for above 1 G.
- (2) Test antenna was located 3 m from the EUT on an adjustable mast, and the antenna used as below table.

Test frequency range	Test antenna used	Test antenna distance
9 kHz - 30 MHz	Active Loop antenna	3 m
30 MHz - 1 GHz	Trilog Broadband Antenna	3 m
1 GHz - 18 GHz	Double Ridged Horn Antenna (1 GHz - 18 GHz)	3 m
18 GHz - 40 GHz	Horn Antenna (18 GHz - 40 GHz)	1 m

According ANSI C63.10:2013 clause 6.4.6 and 6.5.3, for measurements below 30 MHz, Antenna was located 3 m from EUT, the loop antenna was positioned in three antenna orientations (parallel, perpendicular, and round-parallel), for each measurement antenna alignment, the EUT shall be rotated through 0° to 360° on a turntable, and the lowest height of the magnetic antenna shall be 1 m above the ground. For measurement above 30 MHz, the Trilog Broadband Antenna or Horn Antenna was located 3 m from EUT, Measurements were made with the antenna positioned in both the horizontal and vertical planes of Polarization, and the measurement antenna was varied from 1 m to 4 m. in height above the reference ground plane to obtain the maximum signal strength.

- (3) Below pre-scan procedure was first performed in order to find prominent frequency spectrum radiated emissions from 9 kHz to 25 GHz:

- (a) Scanning the peak frequency spectrum with the antenna specified in step (3), and the EUT was rotated 360 degree, the antenna height was varied from 1 m to 4 m (Except loop antenna, it's fixed 1 m above ground.)

- (b) Change work frequency or channel of device if practicable.

- (c) Change modulation type of device if practicable.

- (d) Change power supply range from 85% to 115% of the rated supply voltage

- (e) Rotated EUT though three orthogonal axes to determine the attitude of EUT arrangement produces highest emissions.

Spectrum frequency from 9 kHz to 25 GHz (tenth harmonic of fundamental frequency) was investigated, and no any obvious emission were detected from 9 kHz to 30 MHz and 18 GHz to 25 GHz, so below final test was performed with frequency range from 30 MHz to 18 GHz.

- (4) For final emissions measurements at each frequency of interest, the EUT was rotated and the antenna height was varied between 1 m and 4 m in order to maximize the emission. Measurements in both horizontal and vertical polarities were made and the data was recorded. In order to find the maximum emission, the relative positions of equipments and all of the interface cables were changed according to ANSI C63.10:2013 on Radiated Emission test.
- (5) The emissions from 9 kHz to 1 GHz were measured based on CISPR QP detector except for the frequency bands 9 - 90 kHz, 110 - 490 kHz, for emissions from 9 kHz - 90 kHz, 110 kHz - 490 kHz and above 1 GHz were measured based on average detector, for emissions above 1 GHz, peak emissions also be measured and need comply with Peak limit.
- (6) The emissions from 9 kHz to 1 GHz, QP or average values were measured with EMI receiver with below RBW

Frequency band	RBW
9 kHz - 150 kHz	200 Hz
150 kHz - 30 MHz	9 kHz
30 MHz - 1 GHz	120 kHz

- (7) For emissions above 1 GHz, both Peak and Average level were measured with Spectrum Analyzer, and the RBW is set at 1 MHz, VBW is set at 3 MHz for Peak measure; According ANSI C63.10:2013 clause 4.1.4.2.2 procedure for average measure.

11.4. Test result

Pass. (See below detailed test result)

All the emissions except fundamental emission from 9 kHz to 25 GHz were comply with 15.209 limits and RSS-Gen section 8.9 limits.

Note1: According exploratory test, the emission levels are 20 dB below the limit detected from 9 kHz to 30 MHz and 18 GHz to 25 GHz, so the final test was performed with frequency range from 30 MHz to 18 GHz and recorded in below.

Note2: For emissions below 1 GHz, according exploratory explorer test, when change Tx mode and channel, have no distinct influence on emissions level, so for emissions below 1 GHz, the final test was only performed with EUT working in GFSK 1M Tx 2440 MHz mode.

Note3: For emissions above 1 GHz. If peak results comply with AV limit, AV Result is deemed to comply with AV limit.

Radiated Emission test (below 1 GHz)

TR-4-E-009 Radiated Emission Test Result

Test Date: 2023-05-06 **Tested By:** Liaowanrong
EUT: HK Marine Headunit **Model Number:** HKMARSOHUG1A2B
Test Mode: Tx mode **Power Supply:** DC 12V
Condition: Temp:22.8°C;Humi:54.2%;Press:100.3kPa **Test Site:** DDT 3# Chamber
File Path: d:\ts\2022 report data\Q22091303-2E HK Cobalt Head Unit\FCC BELOW 1G\20230506-173040_H
Memo:

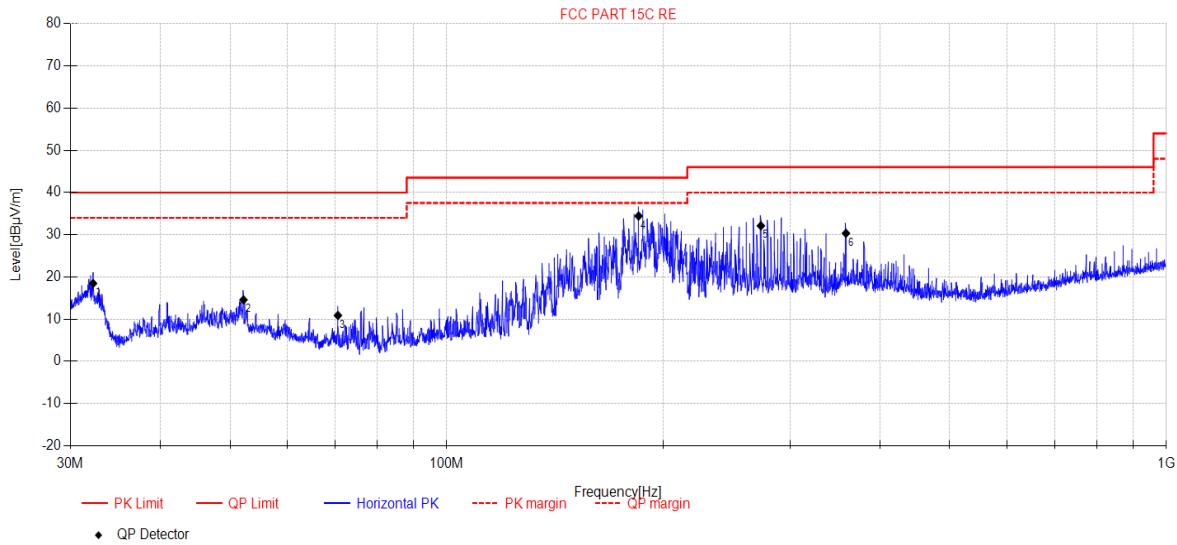

Final Data List										
NO.	Freq. [MHz]	Reading [dBµV/m]	Antenna Factor [dB]	Cable Loss [dB]	AMP [dB]	Result [dBµV/m]	Limit [dBµV/m]	Margin [dB]	Detector	Polarity
1	32.27	39.61	10.40	0.74	-32.29	18.46	40.00	21.54	QP	Horizontal
2	52.20	32.89	12.98	0.99	-32.28	14.58	40.00	25.42	QP	Horizontal
3	70.62	33.59	8.31	1.24	-32.27	10.87	40.00	29.13	QP	Horizontal
4	184.81	54.66	9.78	2.24	-32.25	34.43	43.50	9.07	QP	Horizontal
5	273.31	48.89	12.77	2.72	-32.26	32.12	46.00	13.88	QP	Horizontal
6	358.76	44.73	14.78	3.17	-32.34	30.34	46.00	15.66	QP	Horizontal

Note:

1. Result Level = Reading + Cable loss + Antenna Factor + AMP
2. If Peak Result complies with QP limit, QP Result is deemed to comply with QP limit.
3. Test setup: RBW: 120 kHz, VBW: 300 kHz, Sweep time: auto.

TR-4-E-009 Radiated Emission Test Result

Test Date: 2023-05-06 **Tested By:** Liaowanrong
EUT: HK Marine Headunit **Model Number:** HKMARSOHUG1A2B
Test Mode: Tx mode **Power Supply:** DC 12V
Condition: Temp:22.8°C;Humi:54.2%;Press:100.3kPa **Test Site:** DDT 3# Chamber
File Path: d:\ts\2022 report data\Q22091303-2E HK Cobalt Head Unit\FCC BELOW 1G\20230506-173128_V

Memo:

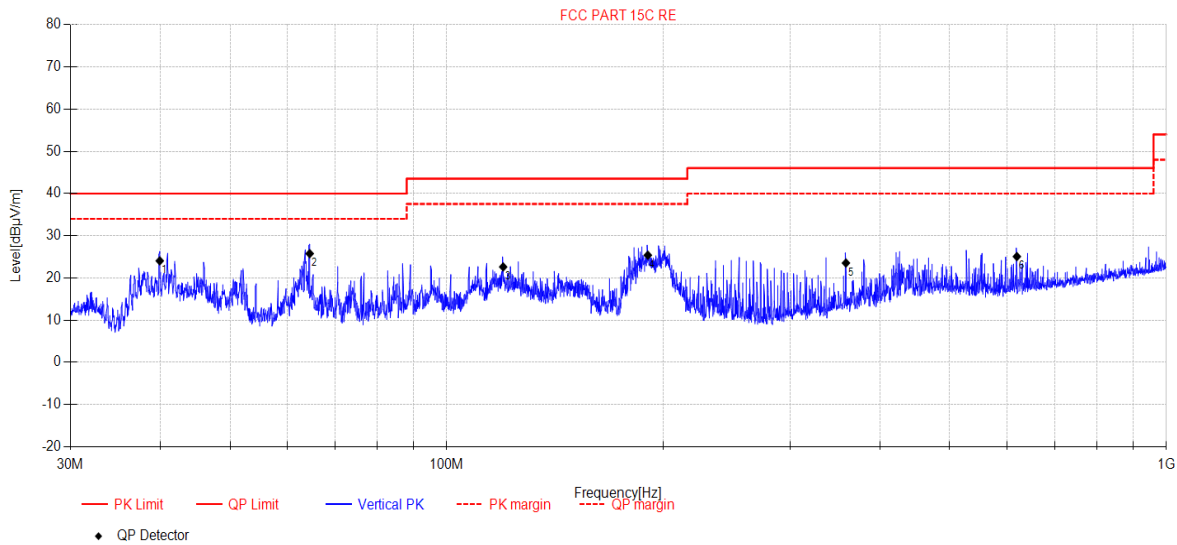

Final Data List										
NO.	Freq. [MHz]	Reading [dBµV/m]	Antenna Factor [dB]	Cable Loss [dB]	AMP [dB]	Result [dBµV/m]	Limit [dBµV/m]	Margin [dB]	Detector	Polarity
1	39.94	43.41	12.09	0.83	-32.28	24.05	40.00	15.95	QP	Vertical
2	64.51	46.12	10.75	1.16	-32.27	25.76	40.00	14.24	QP	Vertical
3	119.82	44.3	8.74	1.79	-32.22	22.61	43.50	20.89	QP	Vertical
4	190.33	45.13	10.23	2.28	-32.26	25.38	43.50	18.12	QP	Vertical
5	358.76	37.93	14.78	3.17	-32.34	23.54	46.00	22.46	QP	Vertical
6	619.90	34.66	18.90	4.26	-32.75	25.07	46.00	20.93	QP	Vertical

Note:

1. Result Level = Reading + Cable loss + Antenna Factor + AMP
2. If Peak Result complies with QP limit, QP Result is deemed to comply with QP limit.
3. Test setup: RBW: 120 kHz, VBW: 300 kHz, Sweep time: auto.

Radiated Emission test (above 1 GHz)

TR-4-E-009 Radiated Emission Test Result

Test Date: 2022-12-14 **Tested By:** Johnson Huang
EUT: HK Marine Headunit **Model Number:** HKMARSOHUG1A2B
Test Mode: Tx mode **Power Supply:** DC 12V
Condition: Temp:22.8°C;Humi:54.2%;Press:100.3kPa **Test Site:** DDT 3# Chamber
File Path: d:\ts\2022 report data\Q22091303-2E HK Cobalt Head Unit\FCC ABOVE 1G\9
Memo: BLE 2402
Test Graph

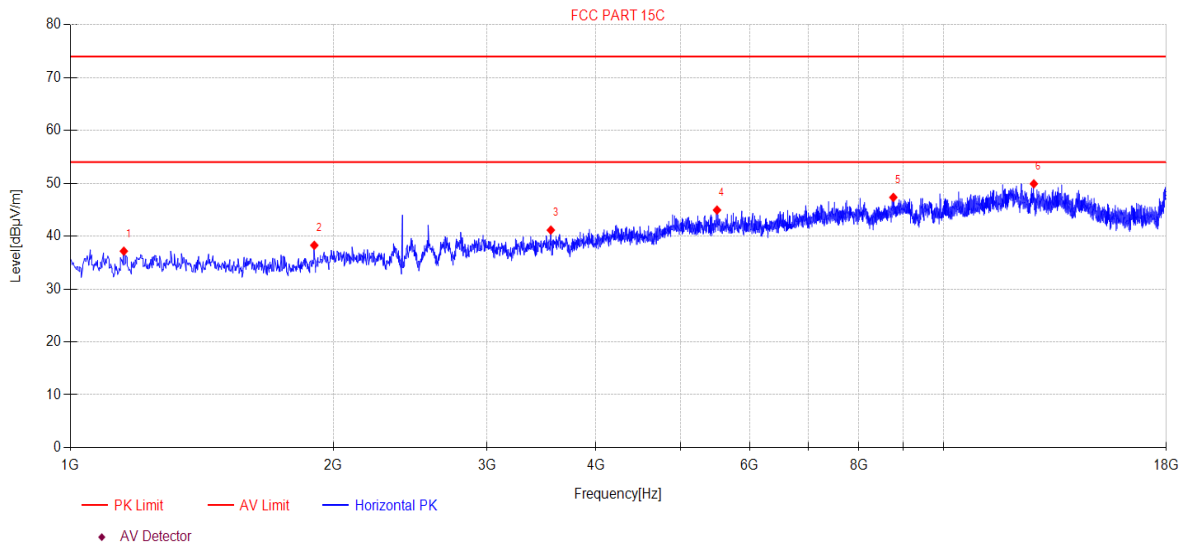

Suspected Data List										
NO	Freq. [MHz]	Reading [dBμV]	Cable loss [dB]	Antenna Factor [dB]	AMP [dB]	Level [dBμV /m]	Limit [dBμV /m]	Margin [dB]	Detector	Polarity
1	1151.51	48.24	1.75	25.60	-38.43	37.16	74.00	36.84	PK	Horizontal
2	1902.82	49.23	2.66	25.92	-39.55	38.26	74.00	35.74	PK	Horizontal
3	3550.73	49.27	3.41	29.60	-41.13	41.15	74.00	32.85	PK	Horizontal
4	5503.72	49.56	3.37	32.91	-40.90	44.94	74.00	29.06	PK	Horizontal
5	8762.18	45.16	3.96	38.00	-39.78	47.34	74.00	26.66	PK	Horizontal
6	12691.00	45.13	4.99	39.38	-39.59	49.91	74.00	24.09	PK	Horizontal

Note:

1. Level = Reading + Cable loss + Antenna Factor +AMP
2. Cable loss= filter +Cable
3. If Peak Result complies with AV limit, AV Result is deemed to comply with AV limit.
4. Test setup: RBW: 1 MHz, VBW: 3 MHz, Sweep time: auto.

TR-4-E-009 Radiated Emission Test Result

Test Date: 2022-12-14 **Tested By:** Johnson Huang
EUT: HK Marine Headunit **Model Number:** HKMARSOHUG1A2B
Test Mode: Tx mode **Power Supply:** DC 12V
Condition: Temp:22.8°C;Humi:54.2%;Press:100.3kPa **Test Site:** DDT 3# Chamber
File Path: d:\ts\2022 report data\Q22091303-2E HK Cobalt Head Unit\FCC ABOVE 1G\10
Memo: BLE 2402

Test Graph

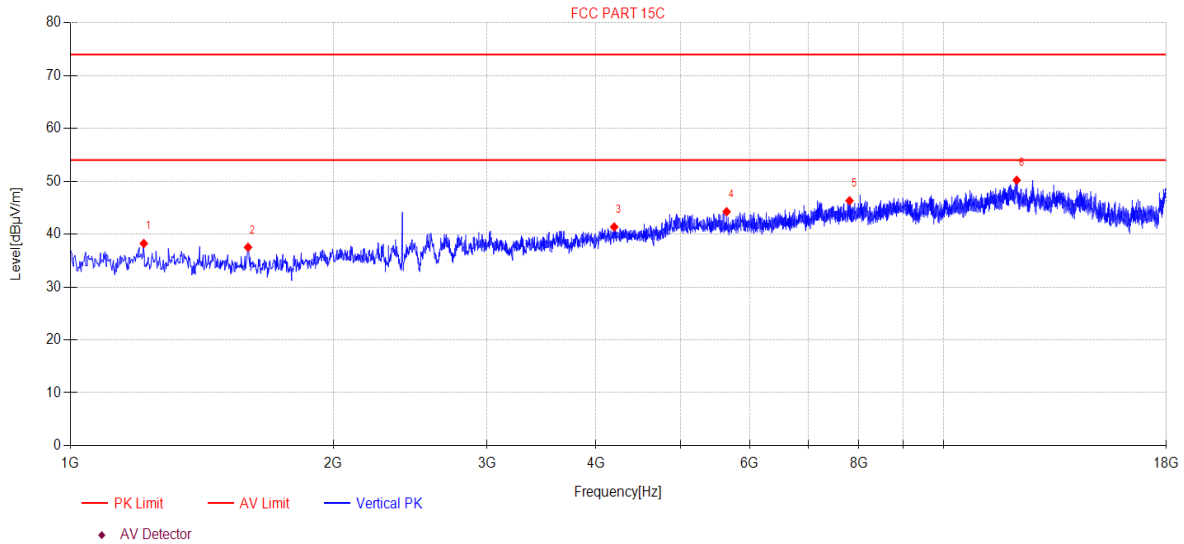

Suspected Data List										
NO	Freq. [MHz]	Reading [dBµV]	Cable loss [dB]	Antenna Factor [dB]	AMP [dB]	Level [dBµV /m]	Limit [dBµV /m]	Margin [dB]	Detector	Polarity
1	1213.77	49.30	1.83	25.63	-38.52	38.24	74.00	35.76	PK	Vertical
2	1597.73	48.93	2.29	25.40	-39.10	37.52	74.00	36.48	PK	Vertical
3	4196.19	48.41	3.21	31.09	-41.34	41.37	74.00	32.63	PK	Vertical
4	5644.85	48.51	3.39	33.19	-40.84	44.25	74.00	29.75	PK	Vertical
5	7805.40	46.79	3.83	36.71	-41.00	46.33	74.00	27.67	PK	Vertical
6	12130.63	45.30	4.83	39.10	-39.03	50.20	74.00	23.80	PK	Vertical

Note:

1. Level = Reading + Cable loss + Antenna Factor +AMP
2. Cable loss= filter +Cable
3. If Peak Result complies with AV limit, AV Result is deemed to comply with AV limit.
4. Test setup: RBW: 1 MHz, VBW: 3 MHz, Sweep time: auto.

TR-4-E-009 Radiated Emission Test Result

Test Date: 2022-12-14 **Tested By:** Johnson Huang
EUT: HK Marine Headunit **Model Number:** HKMARSOHUG1A2B
Test Mode: Tx mode **Power Supply:** DC 12V
Condition: Temp:22.8°C;Humi:54.2%;Press:100.3kPa **Test Site:** DDT 3# Chamber
File Path: d:\ts\2022 report data\Q22091303-2E HK Cobalt Head Unit\FCC ABOVE 1G\11
Memo: BLE 2440

Test Graph

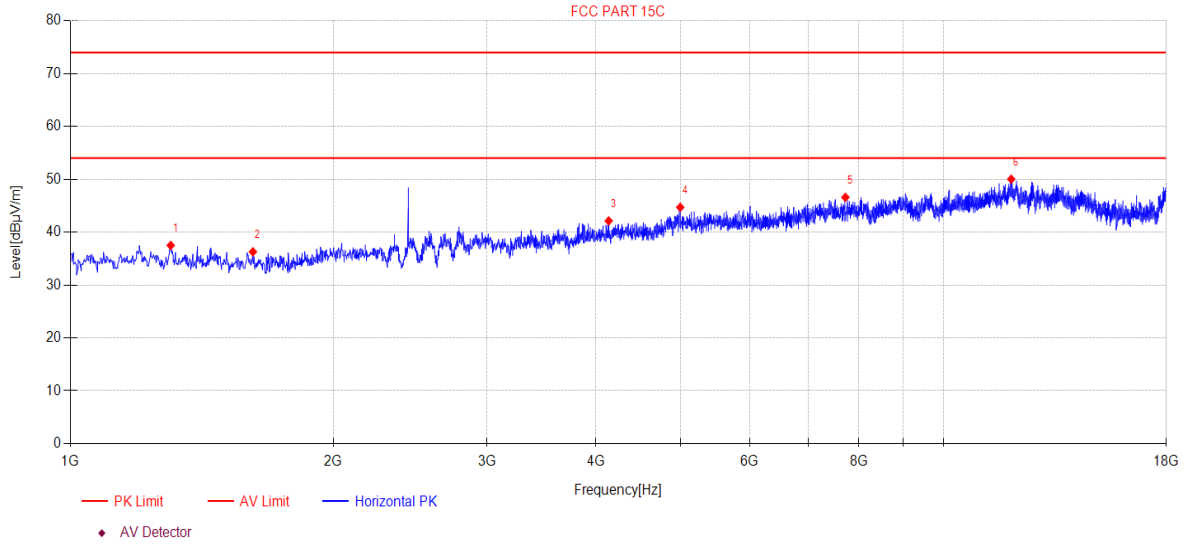

Suspected Data List										
NO	Freq. [MHz]	Reading [dBµV]	Cable loss [dB]	Antenna Factor [dB]	AMP [dB]	Level [dBµV /m]	Limit [dBµV /m]	Margin [dB]	Detector	Polarity
1	1303.02	48.61	1.94	25.60	-38.65	37.50	74.00	36.50	PK	Horizontal
2	1618.48	47.74	2.32	25.36	-39.13	36.29	74.00	37.71	PK	Horizontal
3	4136.00	49.33	3.20	30.97	-41.36	42.14	74.00	31.86	PK	Horizontal
4	4995.24	49.70	3.30	32.80	-41.10	44.70	74.00	29.30	PK	Horizontal
5	7720.30	47.19	3.81	36.60	-41.00	46.60	74.00	27.40	PK	Horizontal
6	11956.29	45.35	4.78	38.86	-38.97	50.02	74.00	23.98	PK	Horizontal

Note:

1. Level = Reading + Cable loss + Antenna Factor +AMP
2. Cable loss= filter +Cable
3. If Peak Result complies with AV limit, AV Result is deemed to comply with AV limit.
4. Test setup: RBW: 1 MHz, VBW: 3 MHz, Sweep time: auto.

TR-4-E-009 Radiated Emission Test Result

Test Date: 2022-12-14 **Tested By:** Johnson Huang
EUT: HK Marine Headunit **Model Number:** HKMARSOHUG1A2B
Test Mode: Tx mode **Power Supply:** DC 12V
Condition: Temp:22.8°C;Humi:54.2%;Press:100.3kPa **Test Site:** DDT 3# Chamber
File Path: d:\ts\2022 report data\Q22091303-2E HK Cobalt Head Unit\FCC ABOVE 1G\12
Memo: BLE 2440

Test Graph

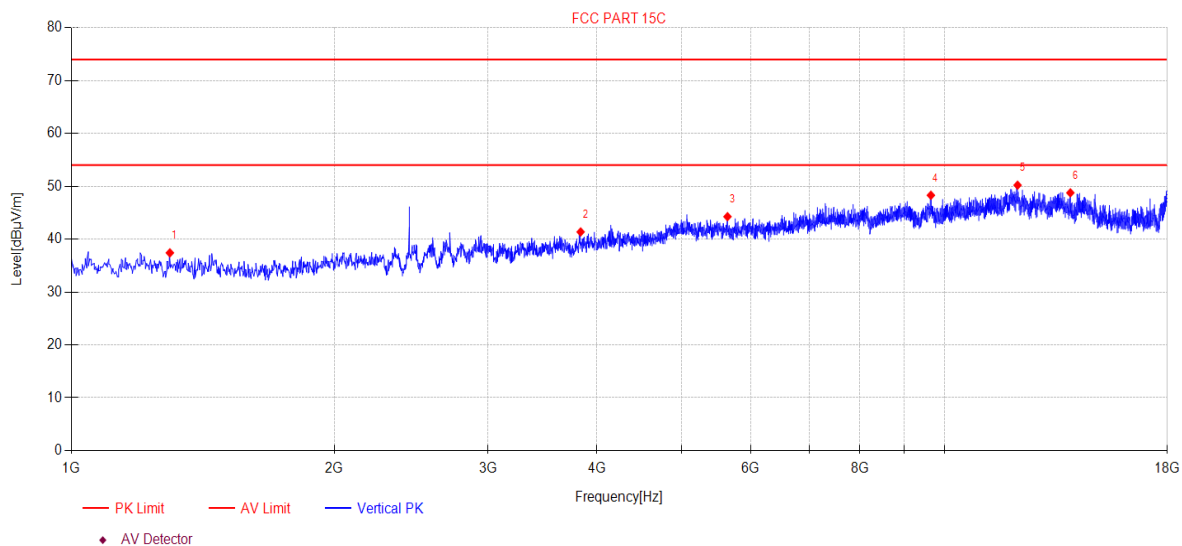

Suspected Data List										
NO	Freq. [MHz]	Reading [dBµV]	Cable loss [dB]	Antenna Factor [dB]	AMP [dB]	Level [dBµV /m]	Limit [dBµV /m]	Margin [dB]	Detector	Polarity
1	1296.79	48.52	1.93	25.61	-38.65	37.41	74.00	36.59	PK	Vertical
2	3830.91	49.04	3.27	30.36	-41.30	41.37	74.00	32.63	PK	Vertical
3	5642.78	48.52	3.39	33.19	-40.84	44.26	74.00	29.74	PK	Vertical
4	9648.39	46.12	4.06	38.30	-40.18	48.30	74.00	25.70	PK	Vertical
5	12126.48	45.32	4.83	39.10	-39.03	50.22	74.00	23.78	PK	Vertical
6	13938.35	43.24	5.15	40.00	-39.62	48.77	74.00	25.23	PK	Vertical

Note:

1. Level = Reading + Cable loss + Antenna Factor +AMP
2. Cable loss= filter +Cable
3. If Peak Result complies with AV limit, AV Result is deemed to comply with AV limit.
4. Test setup: RBW: 1 MHz, VBW: 3 MHz, Sweep time: auto.

TR-4-E-009 Radiated Emission Test Result

Test Date: 2022-12-14 **Tested By:** Johnson Huang
EUT: HK Marine Headunit **Model Number:** HKMARSOHUG1A2B
Test Mode: Tx mode **Power Supply:** DC 12V
Condition: Temp:22.8°C;Humi:54.2%;Press:100.3kPa **Test Site:** DDT 3# Chamber
File Path: d:\ts\2022 report data\Q22091303-2E HK Cobalt Head Unit\FCC ABOVE 1G\13
Memo: BLE 2480

Test Graph

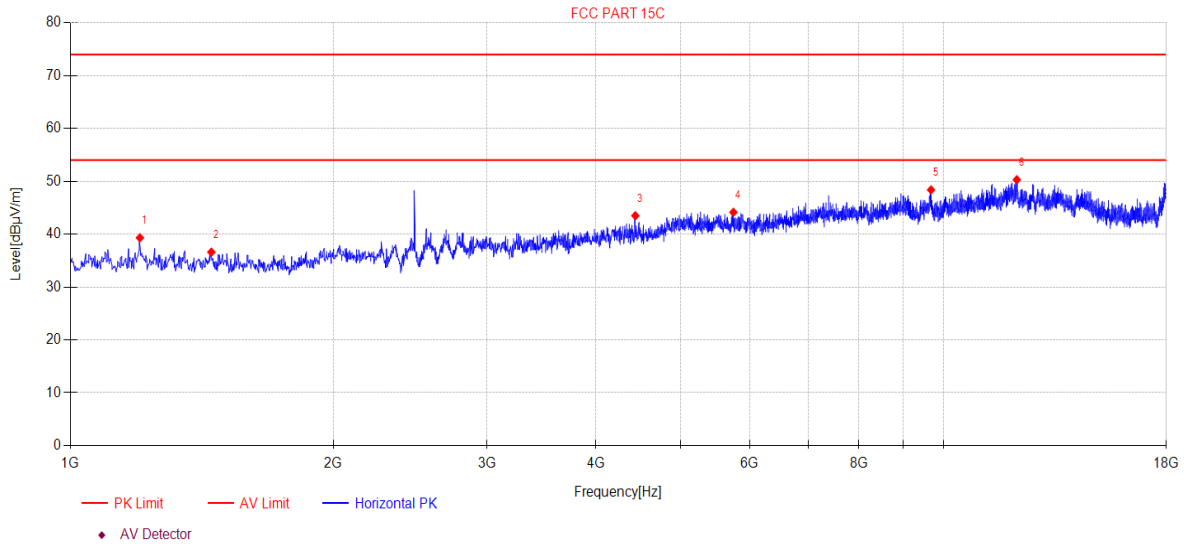

Suspected Data List										
NO	Freq. [MHz]	Reading [dBμV]	Cable loss [dB]	Antenna Factor [dB]	AMP [dB]	Level [dBμV /m]	Limit [dBμV /m]	Margin [dB]	Detector	Polarity
1	1201.32	50.41	1.81	25.60	-38.50	39.32	74.00	34.68	PK	Horizontal
2	1450.37	47.77	2.11	25.60	-38.88	36.60	74.00	37.40	PK	Horizontal
3	4436.94	50.02	3.24	31.50	-41.27	43.49	74.00	30.51	PK	Horizontal
4	5746.55	48.05	3.40	33.49	-40.80	44.14	74.00	29.86	PK	Horizontal
5	9677.45	46.23	4.06	38.30	-40.21	48.38	74.00	25.62	PK	Horizontal
6	12134.78	45.40	4.83	39.10	-39.03	50.30	74.00	23.70	PK	Horizontal

Note:

1. Level = Reading + Cable loss + Antenna Factor +AMP
2. Cable loss= filter +Cable
3. If Peak Result complies with AV limit, AV Result is deemed to comply with AV limit.
4. Test setup: RBW: 1 MHz, VBW: 3 MHz, Sweep time: auto.

TR-4-E-009 Radiated Emission Test Result

Test Date: 2022-12-14 **Tested By:** Johnson Huang
EUT: HK Marine Headunit **Model Number:** HKMARSOHUG1A2B
Test Mode: Tx mode **Power Supply:** DC 12V
Condition: Temp:22.8°C;Humi:54.2%;Press:100.3kPa **Test Site:** DDT 3# Chamber
File Path: d:\ts\2022 report data\Q22091303-2E HK Cobalt Head Unit\FCC ABOVE 1G\14
Memo: BLE 2480

Test Graph

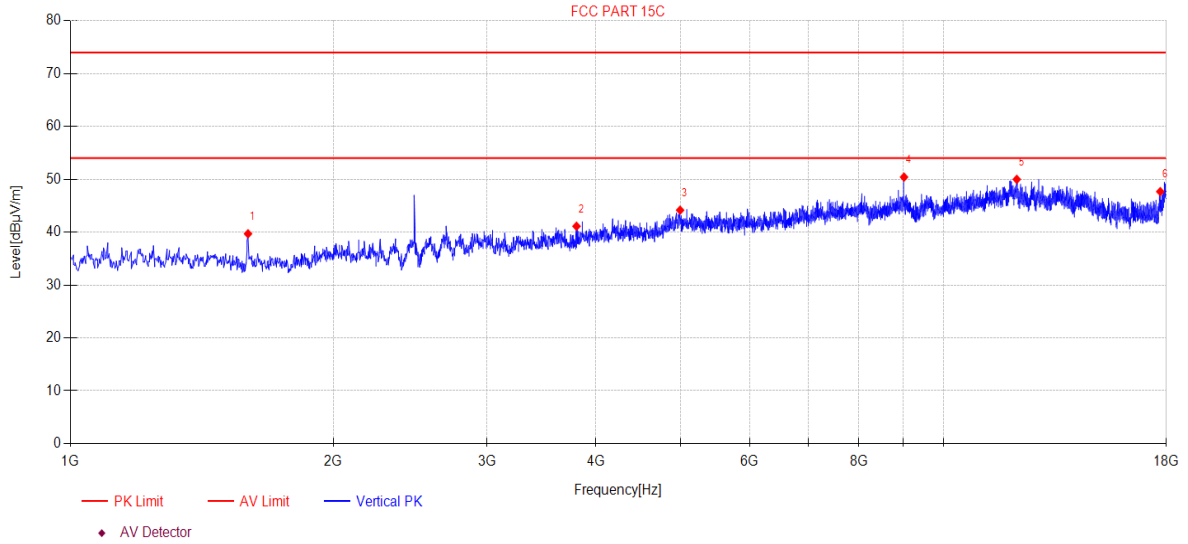

Suspected Data List										
NO	Freq. [MHz]	Reading [dBμV]	Cable loss [dB]	Antenna Factor [dB]	AMP [dB]	Level [dBμV /m]	Limit [dBμV /m]	Margin [dB]	Detector	Polarity
1	1597.73	51.11	2.29	25.40	-39.10	39.70	74.00	34.30	PK	Vertical
2	3799.78	48.81	3.29	30.30	-41.28	41.12	74.00	32.88	PK	Vertical
3	4993.16	49.16	3.30	32.80	-41.10	44.16	74.00	29.84	PK	Vertical
4	9013.31	47.65	3.99	38.20	-39.42	50.42	74.00	23.58	PK	Vertical
5	12132.71	45.09	4.83	39.10	-39.03	49.99	74.00	24.01	PK	Vertical
6	17713.59	40.07	8.29	39.90	-40.59	47.67	74.00	26.33	PK	Vertical

Note:

1. Level = Reading + Cable loss + Antenna Factor +AMP
2. Cable loss= filter +Cable
3. If Peak Result complies with AV limit, AV Result is deemed to comply with AV limit.
4. Test setup: RBW: 1 MHz, VBW: 3 MHz, Sweep time: auto.

12. Emissions in Restricted Frequency Bands

12.1. Block diagram of test setup

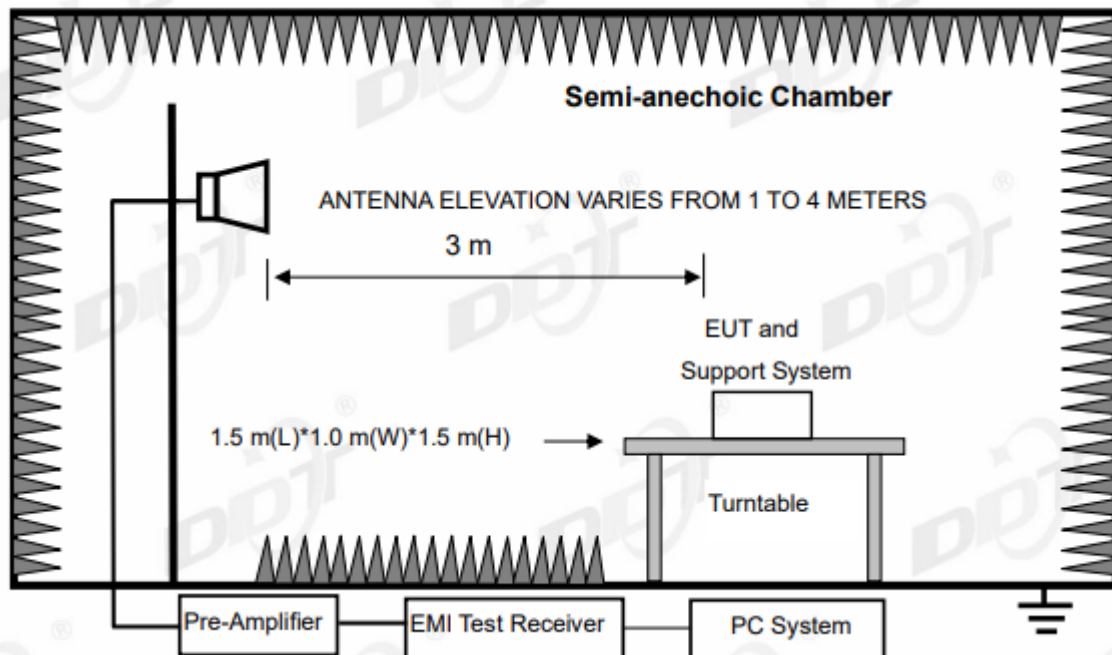

12.2. Limit

All restriction band should comply with 15.209 and RSS-Gen section 8.9 limits, other emission should be at least 20 dB below the fundamental.

12.3. Test procedure

Same with Radiated Emission except change investigated frequency range from 2310 MHz to 2410 MHz and 2475 MHz to 2500 MHz.

Remark: All restriction band have been tested, and only the worst case is shown in report.

12.4. Test result

Pass. (See below detailed test result)

TR-4-E-009 Radiated Emission Test Result

Test Date: 2022-12-14 **Tested By:** Johnson Huang
EUT: HK Marine Headunit **Model Number:** HKMARSOHUG1A2B
Test Mode: Tx mode **Power Supply:** DC 12V
Condition: Temp:22.8°C;Humi:54.2%;Press:100.3kPa **Test Site:** DDT 3# Chamber
File Path: d:\ts\2022 report data\Q22091303-2E HK Cobalt Head Unit\FCC ABOVE 1G\21
Memo: BLE 2402

Test Graph

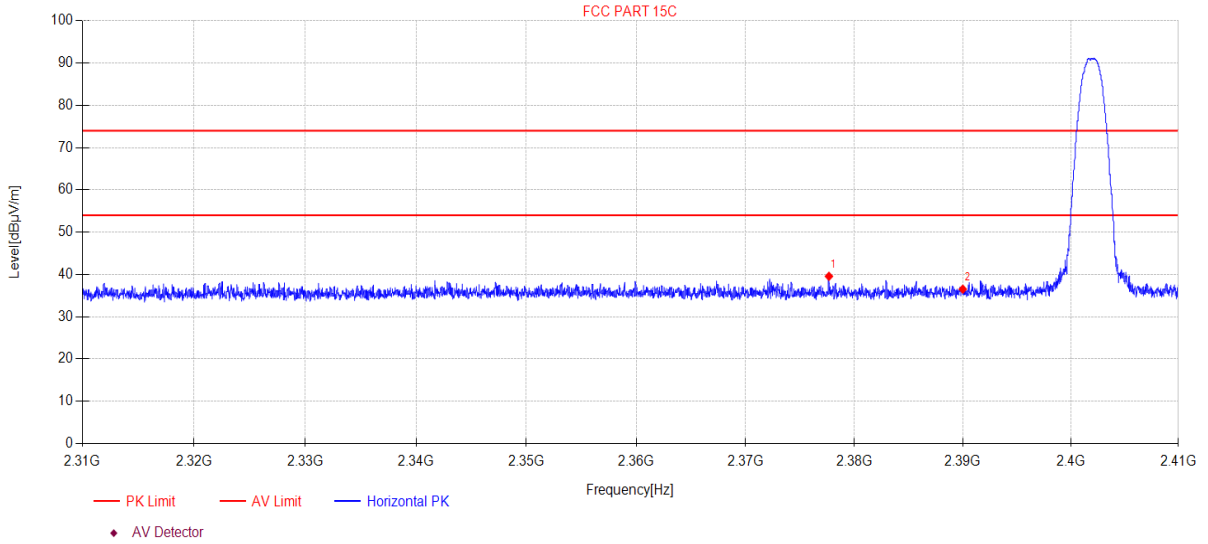

Suspected Data List										
NO	Freq. [MHz]	Reading [dBμV]	Cable loss [dB]	Antenna Factor [dB]	AMP [dB]	Level [dBμV /m]	Limit [dBμV /m]	Margin [dB]	Detector	Polarity
1	2377.66	49.18	3.04	27.46	-40.12	39.56	74.00	34.44	PK	Horizontal
2	2390.00	46.10	3.06	27.48	-40.13	36.51	74.00	37.49	PK	Horizontal

Note:

1. Level = Reading + Cable loss + Antenna Factor +AMP
2. Cable loss= filter +Cable
3. If Peak Result complies with AV limit, AV Result is deemed to comply with AV limit.
4. Test setup: RBW: 1 MHz, VBW: 3 MHz, Sweep time: auto.

TR-4-E-009 Radiated Emission Test Result

Test Date: 2022-12-14 **Tested By:** Johnson Huang
EUT: HK Marine Headunit **Model Number:** HKMARSOHUG1A2B
Test Mode: Tx mode **Power Supply:** DC 12V
Condition: Temp:22.8°C;Humi:54.2%;Press:100.3kPa **Test Site:** DDT 3# Chamber
File Path: d:\ts\2022 report data\Q22091303-2E HK Cobalt Head Unit\FCC ABOVE 1G\22
Memo: BLE 2402

Test Graph

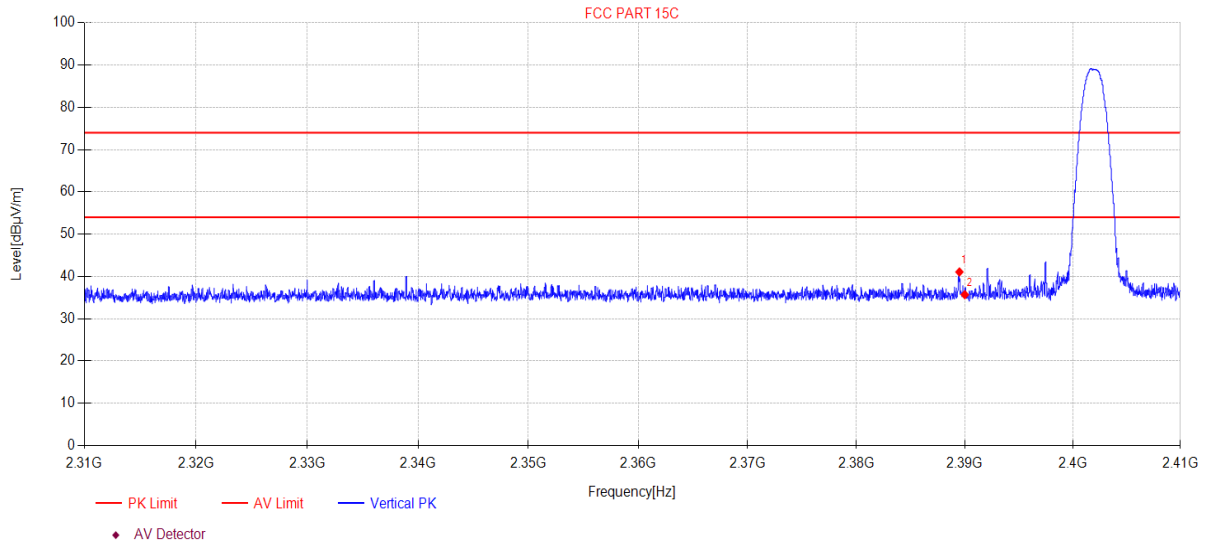

Suspected Data List										
NO	Freq. [MHz]	Reading [dBµV]	Cable loss [dB]	Antenna Factor [dB]	AMP [dB]	Level [dBµV /m]	Limit [dBµV /m]	Margin [dB]	Detector	Polarity
1	2389.50	50.65	3.06	27.48	-40.13	41.06	74.00	32.94	PK	Vertical
2	2390.00	45.28	3.06	27.48	-40.13	35.69	74.00	38.31	PK	Vertical

Note:

1. Level = Reading + Cable loss + Antenna Factor +AMP
2. Cable loss= filter +Cable
3. If Peak Result complies with AV limit, AV Result is deemed to comply with AV limit.
4. Test setup: RBW: 1 MHz, VBW: 3 MHz, Sweep time: auto.

TR-4-E-009 Radiated Emission Test Result

Test Date: 2022-12-14 **Tested By:** Johnson Huang
EUT: HK Marine Headunit **Model Number:** HKMARSOHUG1A2B
Test Mode: Tx mode **Power Supply:** DC 12V
Condition: Temp:22.8°C;Humi:54.2%;Press:100.3kPa **Test Site:** DDT 3# Chamber
File Path: d:\ts\2022 report data\Q22091303-2E HK Cobalt Head Unit\FCC ABOVE 1G\29
Memo: BLE 2480

Test Graph

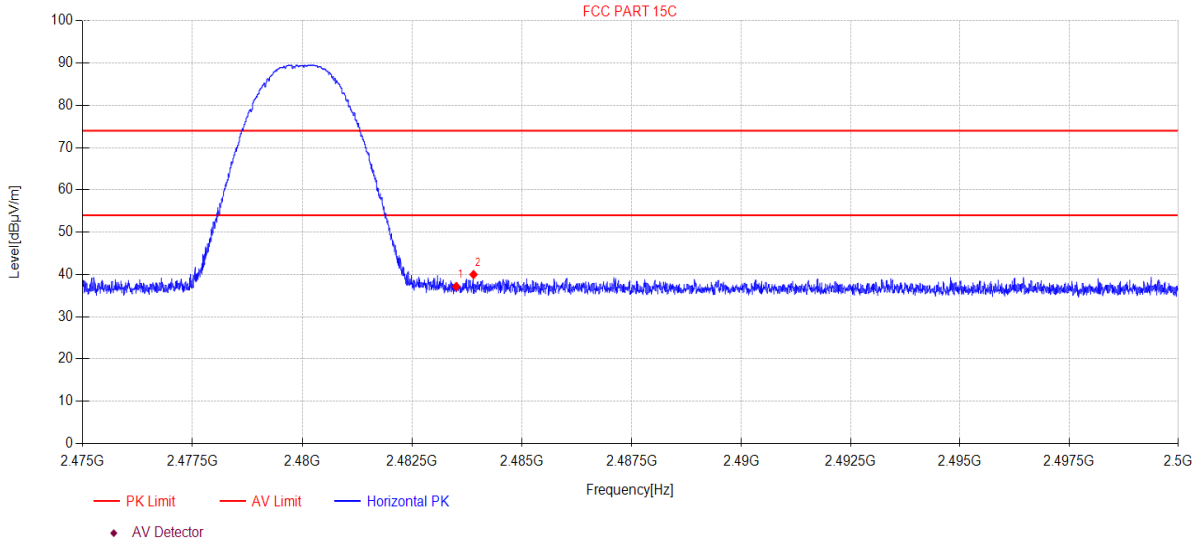

Suspected Data List										
NO	Freq. [MHz]	Reading [dBμV]	Cable loss [dB]	Antenna Factor [dB]	AMP [dB]	Level [dBμV /m]	Limit [dBμV /m]	Margin [dB]	Detector	Polarity
1	2483.50	46.49	3.15	27.73	-40.23	37.14	74.00	36.86	PK	Horizontal
2	2483.89	49.32	3.15	27.74	-40.23	39.98	74.00	34.02	PK	Horizontal

Note:

1. Level = Reading + Cable loss + Antenna Factor +AMP
2. Cable loss= filter +Cable
3. If Peak Result complies with AV limit, AV Result is deemed to comply with AV limit.
4. Test setup: RBW: 1 MHz, VBW: 3 MHz, Sweep time: auto.

TR-4-E-009 Radiated Emission Test Result

Test Date: 2022-12-14 **Tested By:** Johnson Huang
EUT: HK Marine Headunit **Model Number:** HKMARSOHUG1A2B
Test Mode: Tx mode **Power Supply:** DC 12V
Condition: Temp:22.8°C;Humi:54.2%;Press:100.3kPa **Test Site:** DDT 3# Chamber
File Path: d:\ts\2022 report data\Q22091303-2E HK Cobalt Head Unit\FCC ABOVE 1G\30
Memo: BLE 2480

Test Graph

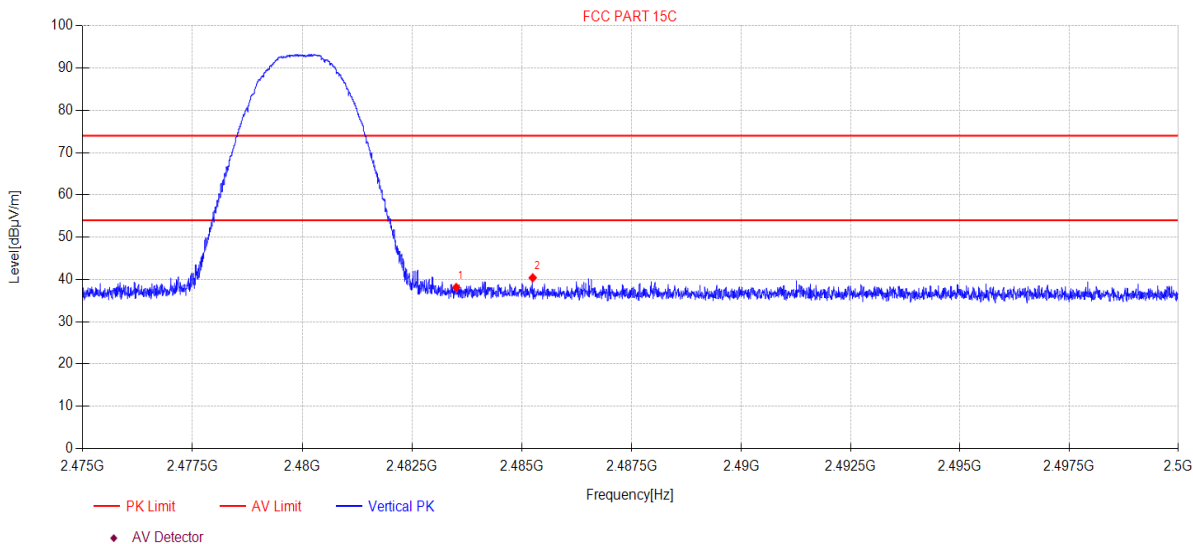

Suspected Data List										
NO	Freq. [MHz]	Reading [dBμV]	Cable loss [dB]	Antenna Factor [dB]	AMP [dB]	Level [dBμV /m]	Limit [dBμV /m]	Margin [dB]	Detector	Polarity
1	2483.50	47.45	3.15	27.73	-40.23	38.10	74.00	35.90	PK	Vertical
2	2485.24	49.73	3.15	27.74	-40.23	40.39	74.00	33.61	PK	Vertical

Note:

1. Level = Reading + Cable loss + Antenna Factor +AMP
2. Cable loss= filter +Cable
3. If Peak Result complies with AV limit, AV Result is deemed to comply with AV limit.
4. Test setup: RBW: 1 MHz, VBW: 3 MHz, Sweep time: auto.

13. Power Line Conducted Emission

13.1. Block diagram of test setup

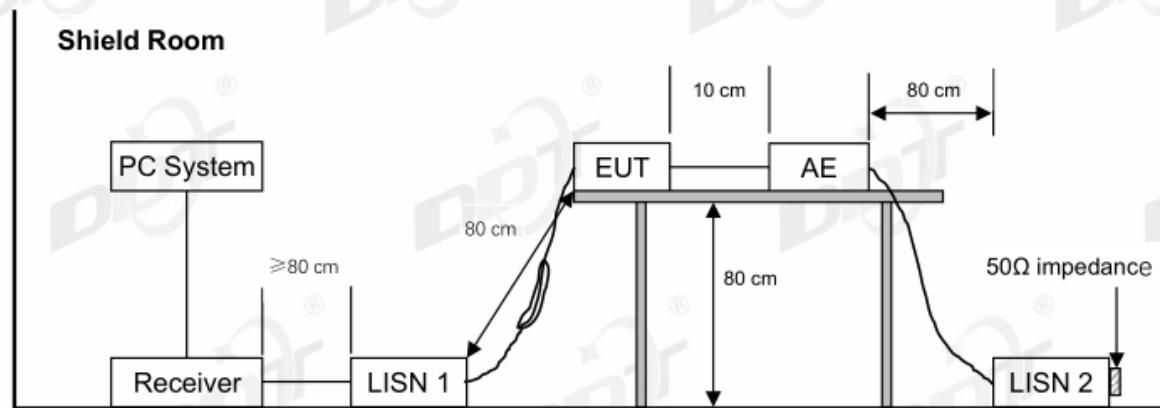

13.2. Power line conducted emission limits

Frequency	Quasi-Peak Level dB(μ V)	Average Level dB(μ V)
150 kHz ~ 500 kHz	66 ~ 56*	56 ~ 46*
500 kHz ~ 5 MHz	56	46
5 MHz ~ 30 MHz	60	50

Note 1: * Decreasing linearly with logarithm of frequency.

Note 2: The lower limit shall apply at the transition frequencies.

13.3. Test procedure

The EUT and Support equipment, if needed, were put placed on a non-metallic table, 80 cm above the ground plane.

All support equipment power received from a second LISN.

Emissions were measured on each current carrying line of the EUT using an EMI Test Receiver connected to the LISN powering the EUT.

The Receiver scanned from 150 kHz to 30 MHz for emissions in each of the test modes.

During the above scans, the emissions were maximized by cable manipulation.

The test mode(s) described in clause 2.4 were scanned during the preliminary test.

After the preliminary scan, we found the test mode producing the highest emission level.

The EUT configuration and worse cable configuration of the above highest emission levels were recorded for reference of the final test.

EUT and support equipment were set up on the test bench as per the configuration with highest emission level in the preliminary test.

A scan was taken on both power lines, Neutral and Line, recording at least the six highest emissions.

Emission frequency and amplitude were recorded into a computer in which correction factors were used to calculate the emission level and compare reading to the applicable limit.

The test data of the worst-case condition(s) was recorded.

The bandwidth of test receiver is set at 9 kHz.

13.4. Test result

Not Applicable

Remark: Conducted limits are not required for devices which do not operate from the AC power lines or contain provisions for operation while connected to the AC power lines according to 15.207(C).

14. Antenna Requirements

14.1. Limit

For intentional device, according to FCC 47 CFR Section 15.203, an intentional radiator shall be designed to ensure that no antenna other than that furnished by the responsible party shall be used with the device. And according to FCC 47 CFR Section 15.247 (b), if transmitting antennas of directional gain greater than 6 dBi are used, the power shall be reduced by the amount in dB that the directional gain of the antenna exceeds 6 dBi.

For intentional device, according to RSS-Gen issue 5 section 6.8.

The applicant for equipment certification shall provide a list of all antenna types that may be used with the transmitter, where applicable (i.e. for transmitters with detachable antenna), indicating the maximum permissible antenna gain (in dBi) and the required impedance for each antenna. The test report shall demonstrate the compliance of the transmitter with the limit for maximum equivalent isotropically radiated power (e.i.r.p.) specified in the applicable RSS, when the transmitter is equipped with any antenna type, selected from this list.

14.2. Result

The antenna used for this product is external antenna and that no antenna other than that furnished by the responsible party shall be used with the device, the maximum peak gain of the transmit antenna is 0.83 dBi.

16. Photos of the EUT

Please refer to appendix I.

END OF REPORT