

2DH5_ANT1_2480_1000~12750

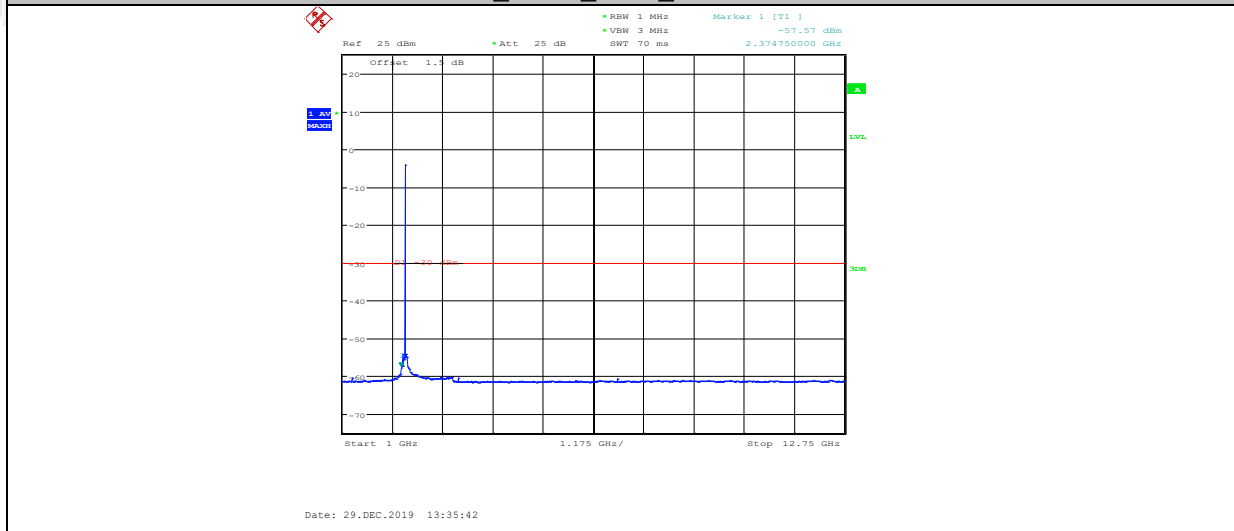

2DH5_ANT1_2480_2390~2420

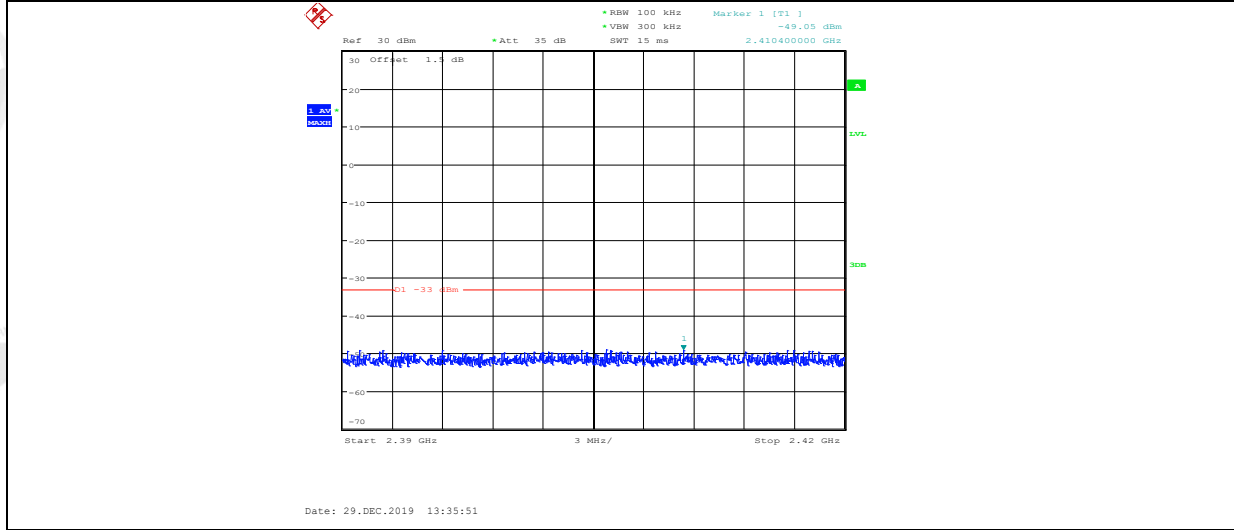

2DH5_ANT1_2480_2400~2483.5

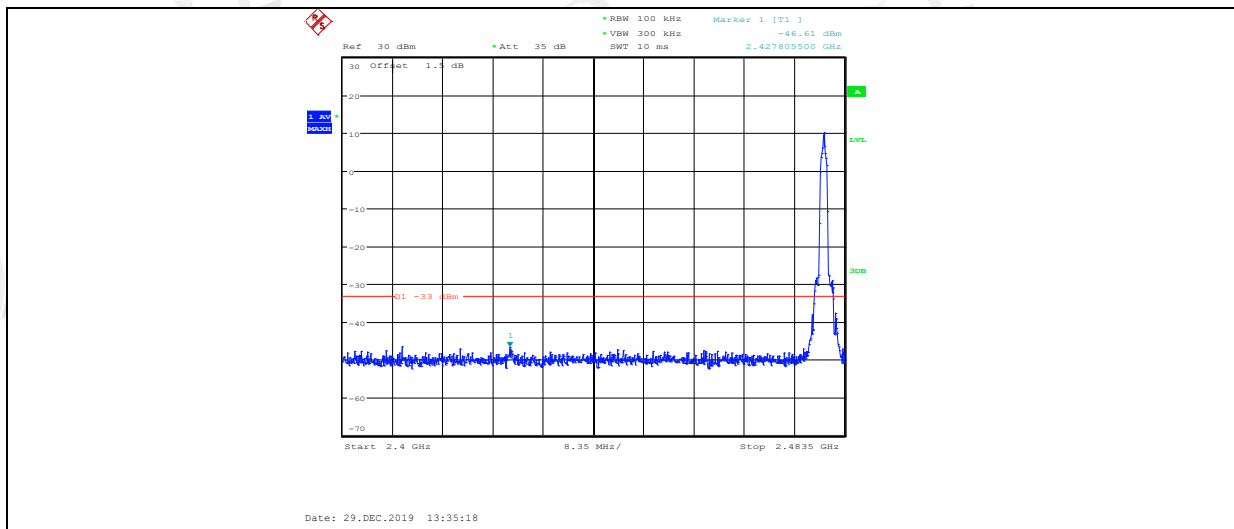

2DH5_ANT1_2480_2470~2490

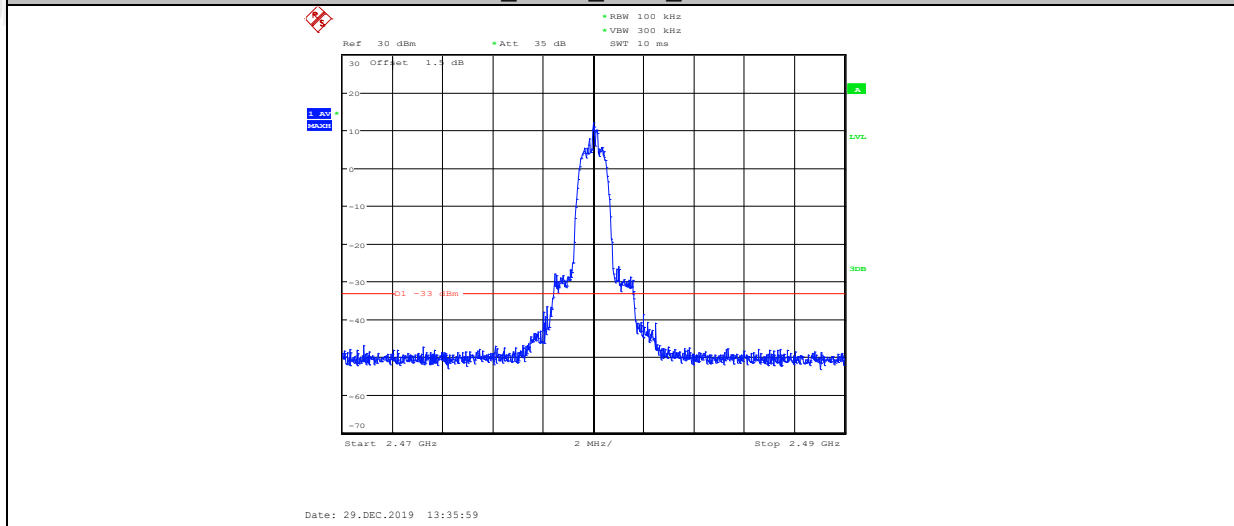

2DH5_ANT1_2480_3400~3530

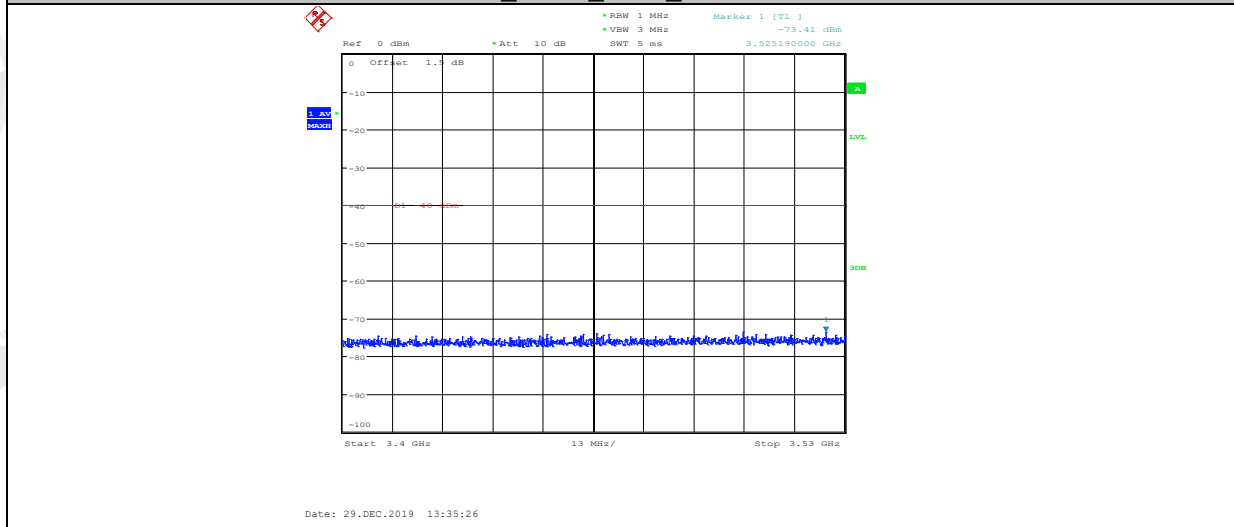

2DH5_ANT1_2480_5725~5850

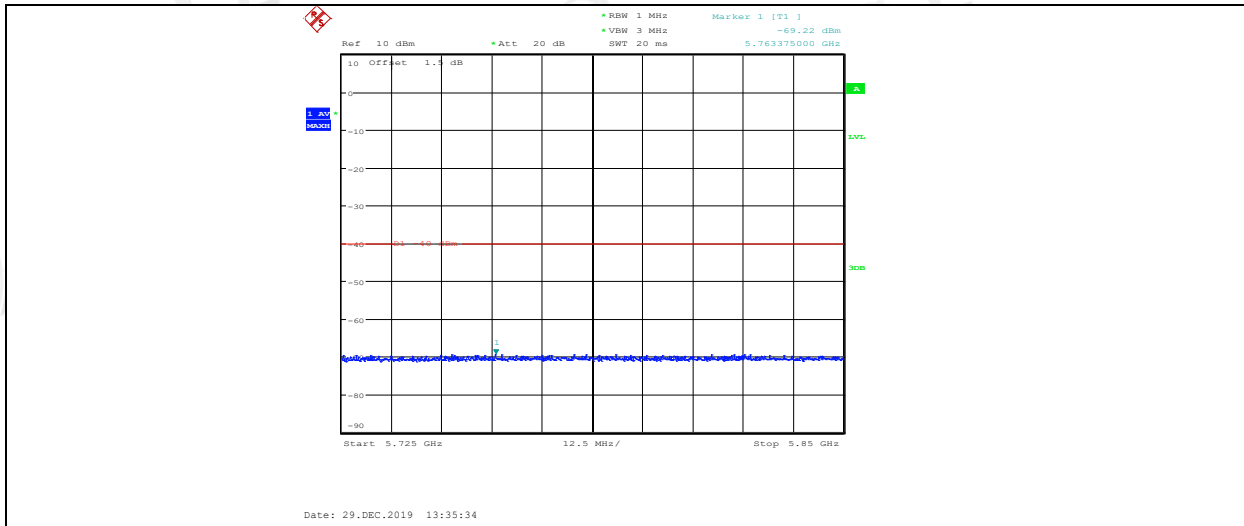

3DH5_ANT1_2402_Ref

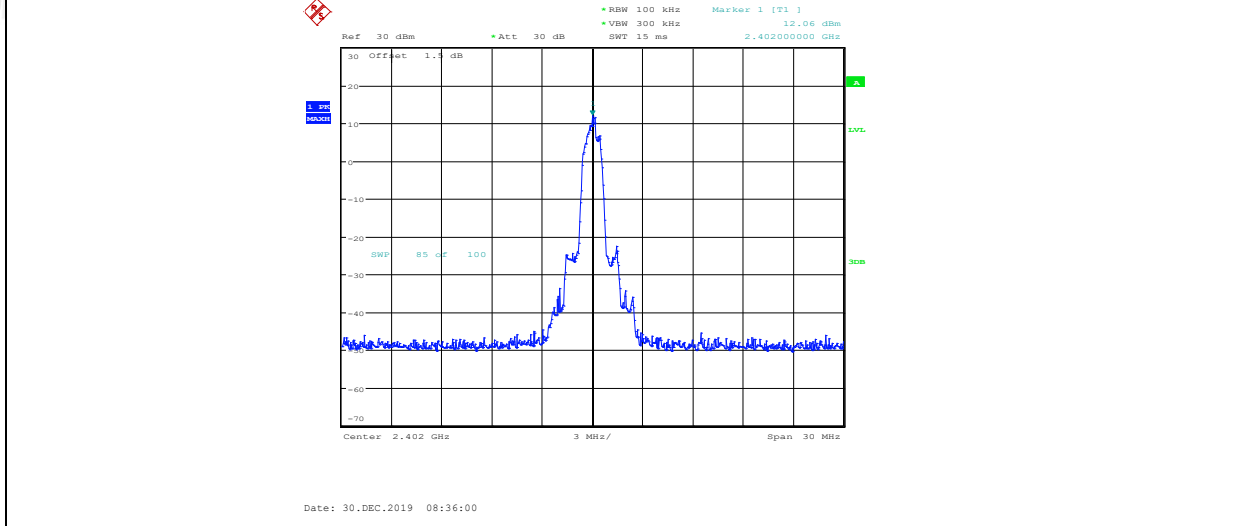

3DH5_ANT1_2402_30~1000

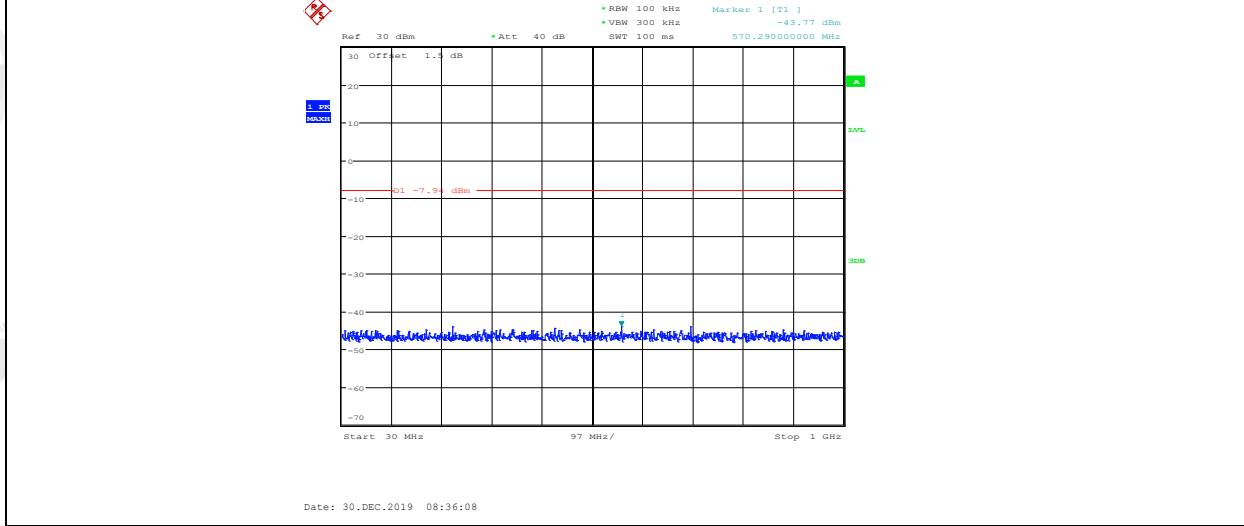

3DH5_ANT1_2402_1000~26500

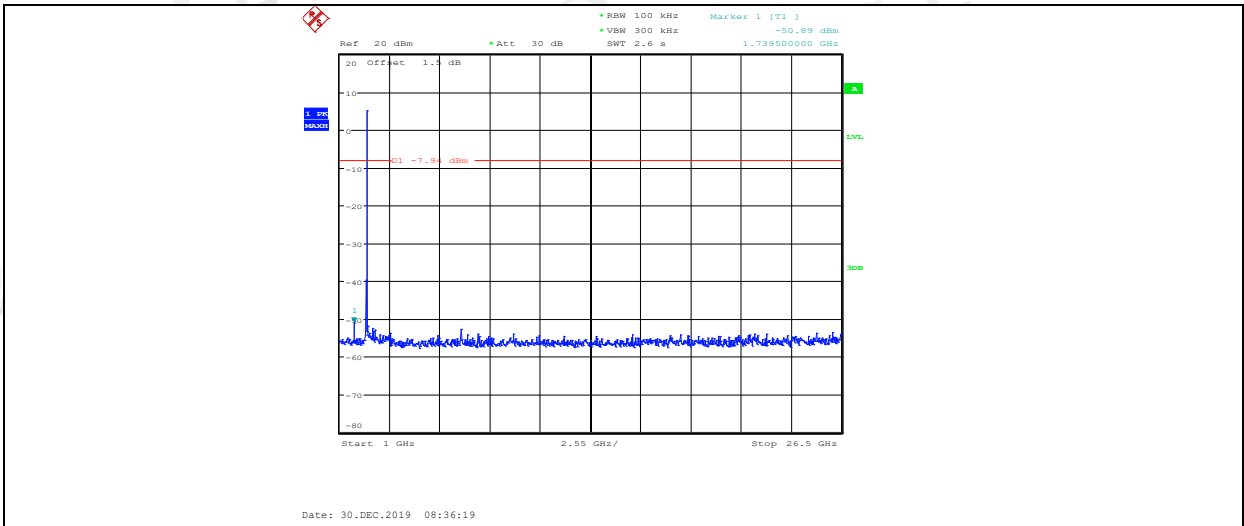

3DH5_ANT1_2402_1000~12750

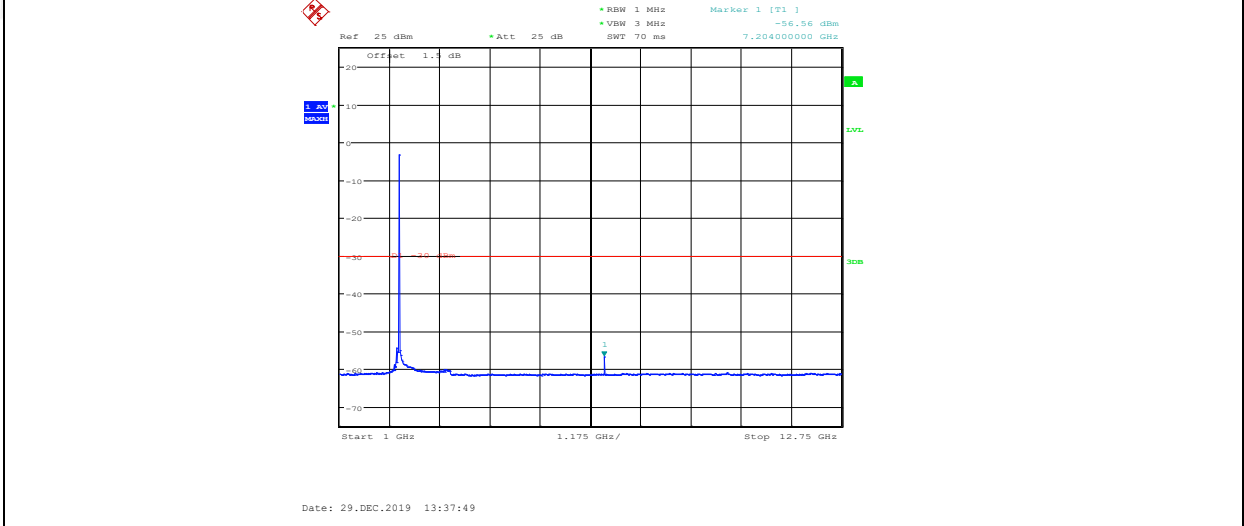

3DH5_ANT1_2402_2390~2420

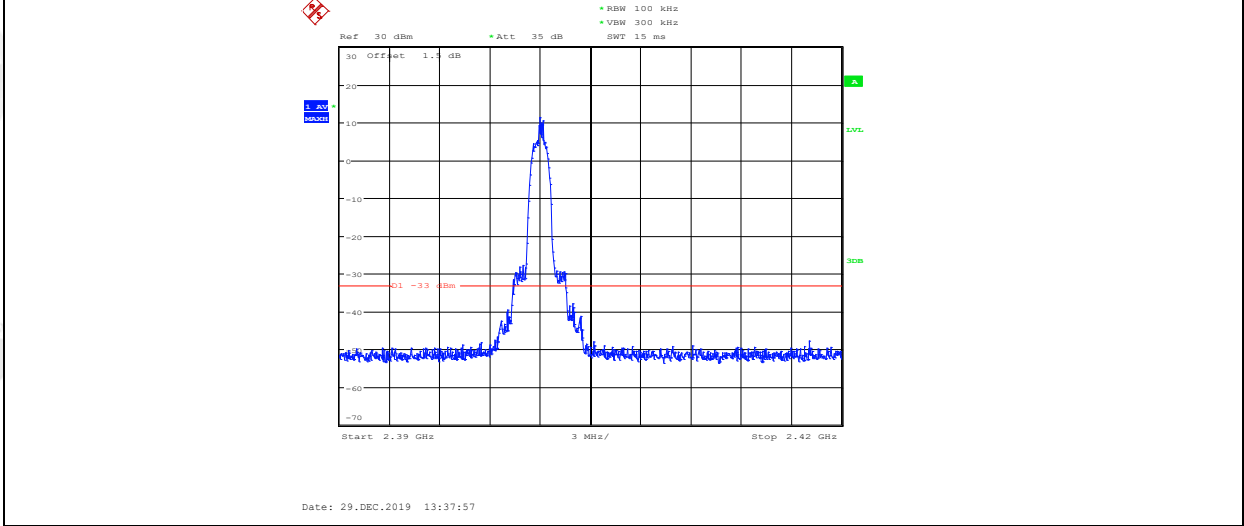

3DH5_ANT1_2402_2400~2483.5

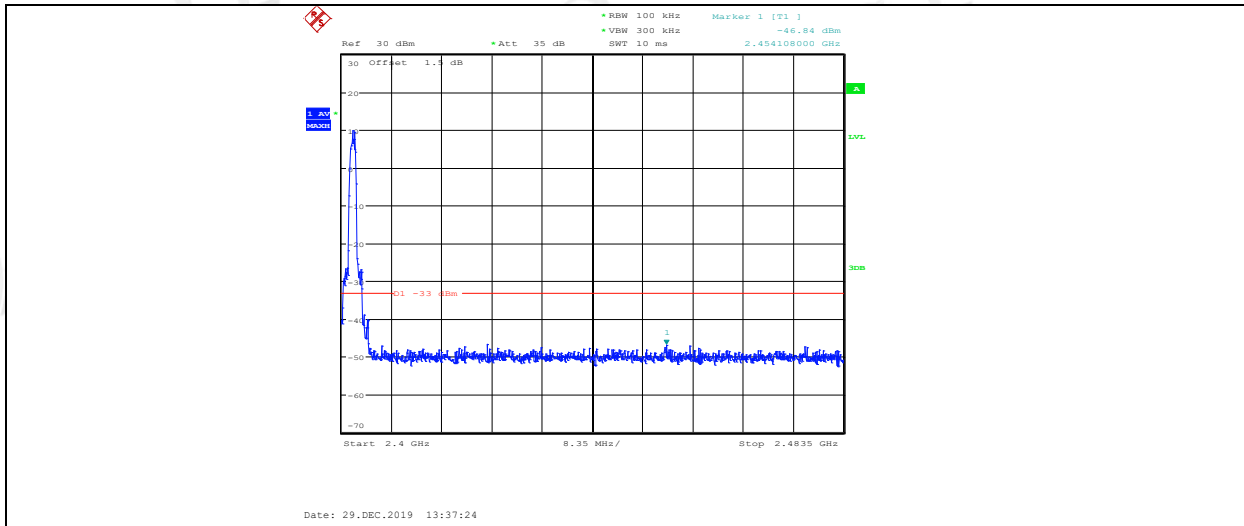

3DH5_ANT1_2402_2470~2490

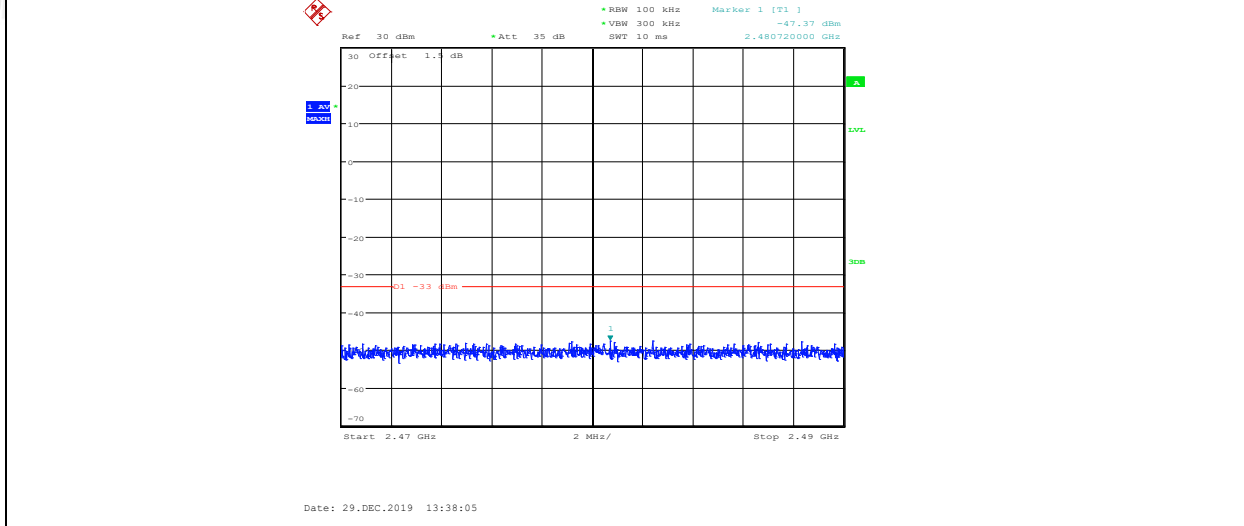

3DH5_ANT1_2402_3400~3530

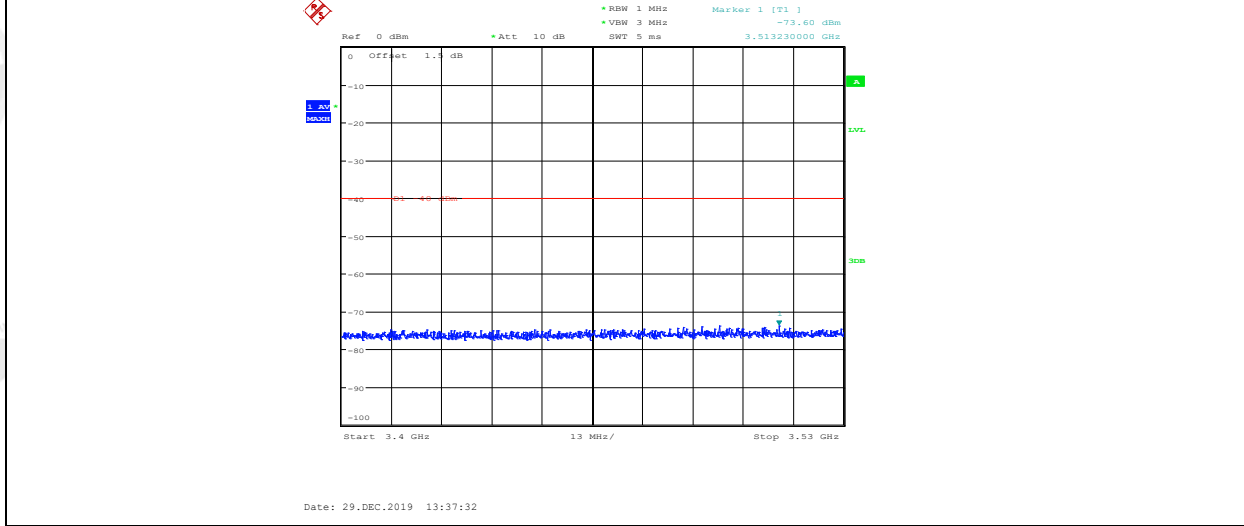

3DH5_ANT1_2402_5725~5850

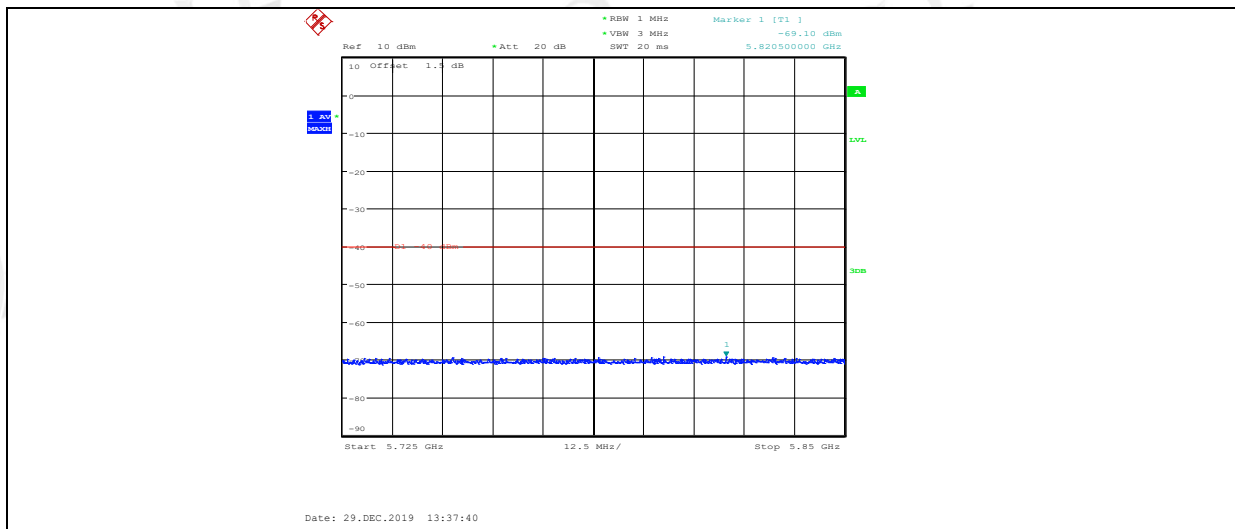

3DH5_ANT1_2441_Ref

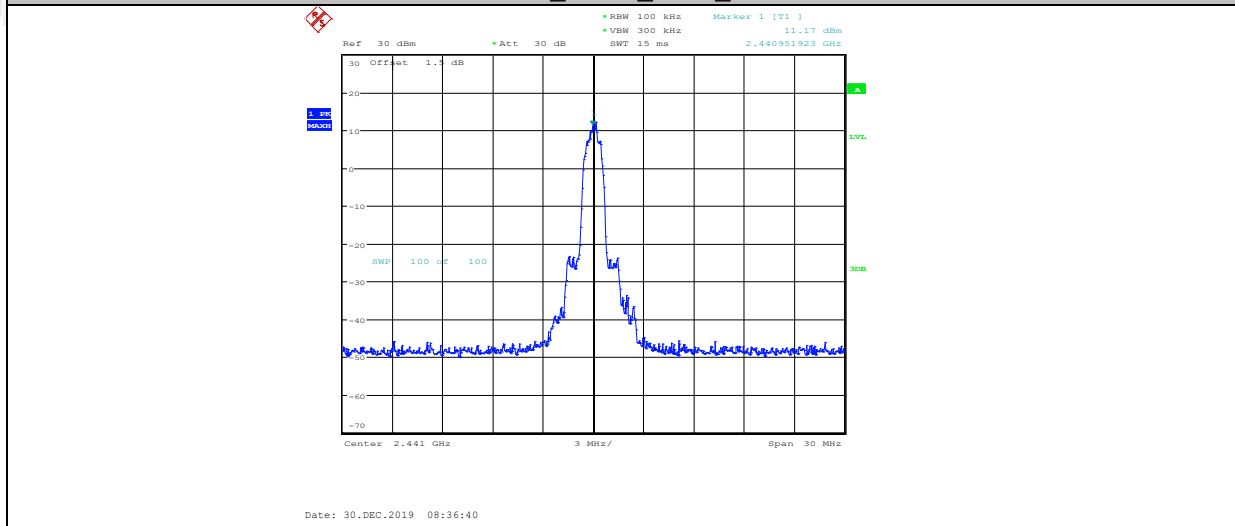

3DH5_ANT1_2441_30~1000

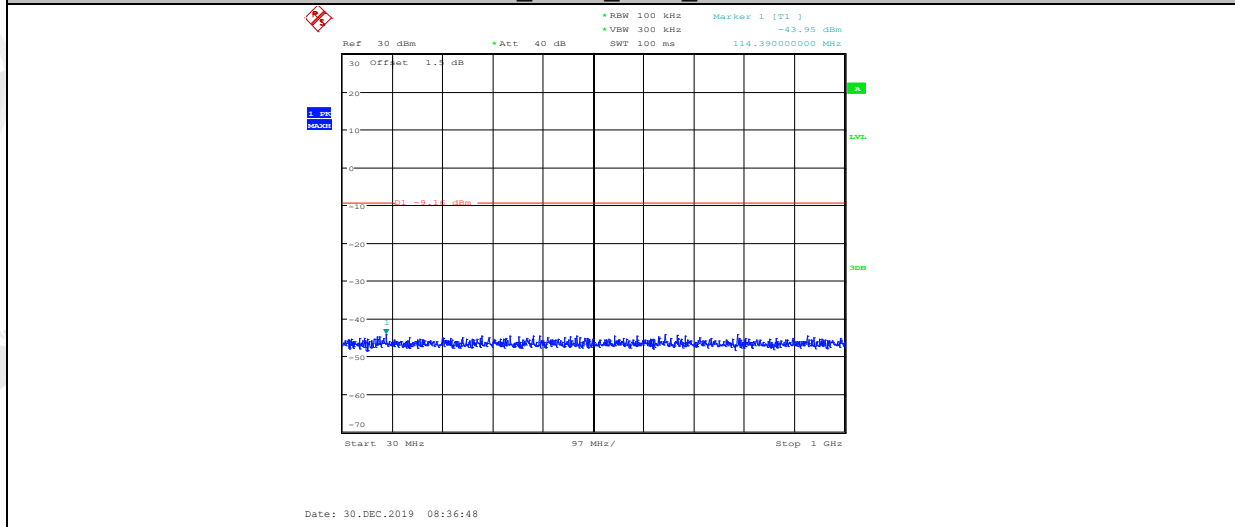

3DH5_ANT1_2441_1000~12750

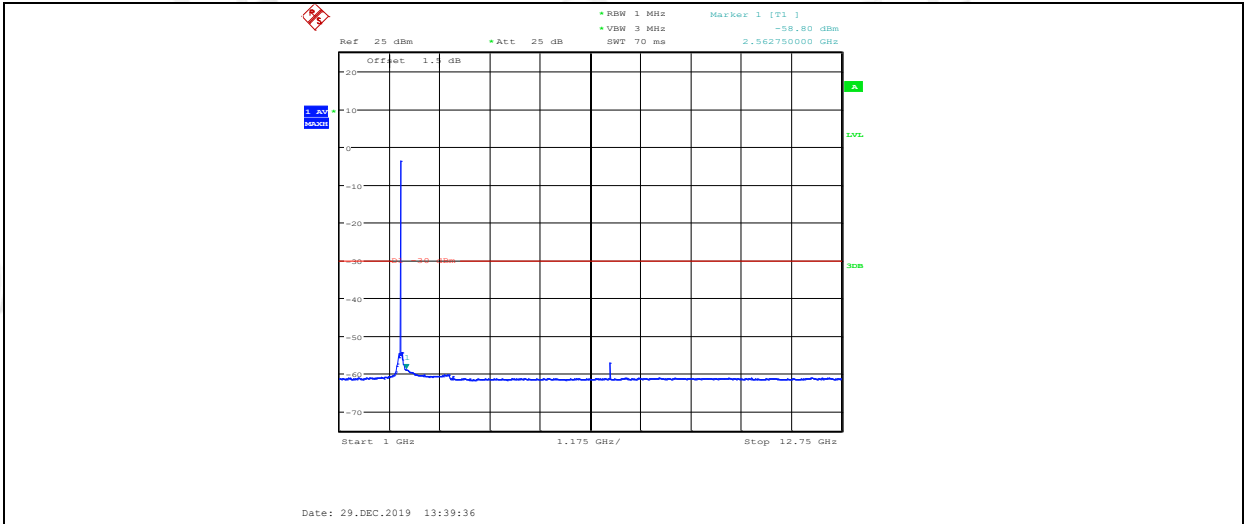

3DH5_ANT1_2441_1000~26500

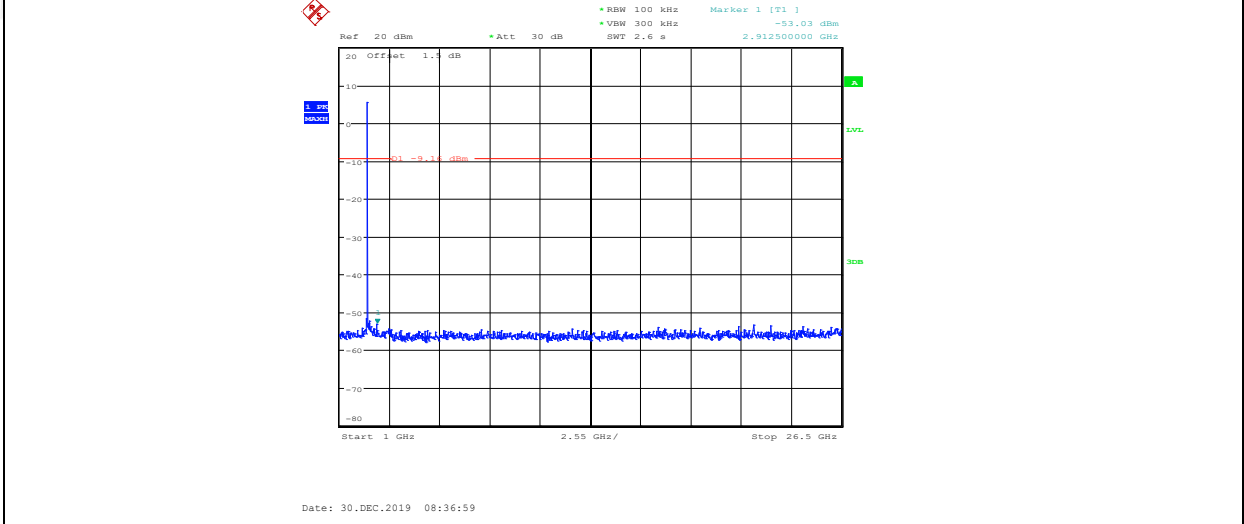

3DH5_ANT1_2441_2390~2420

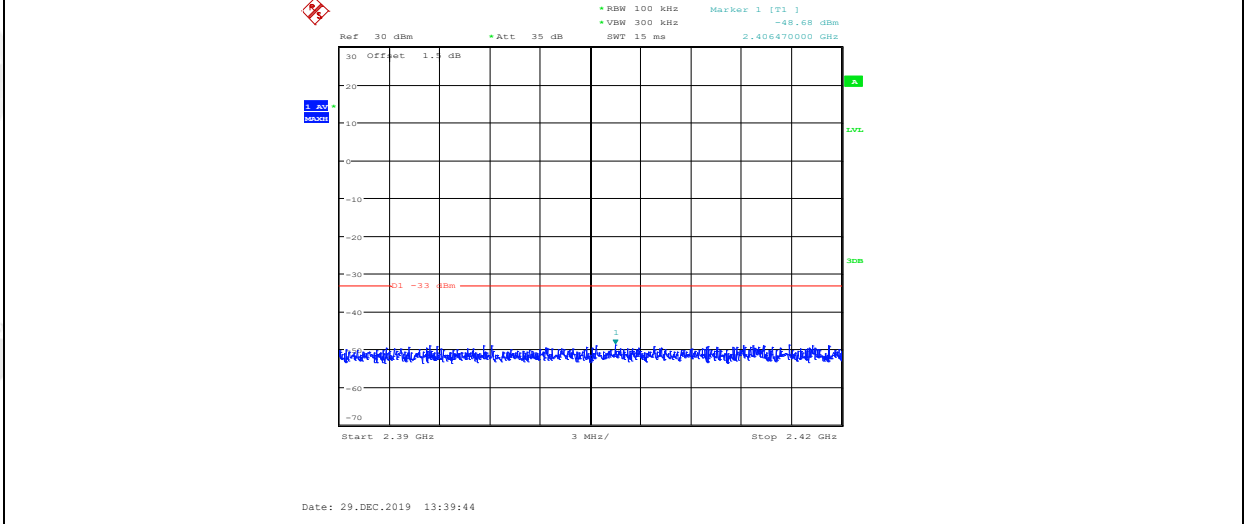

3DH5_ANT1_2441_2400~2483.5

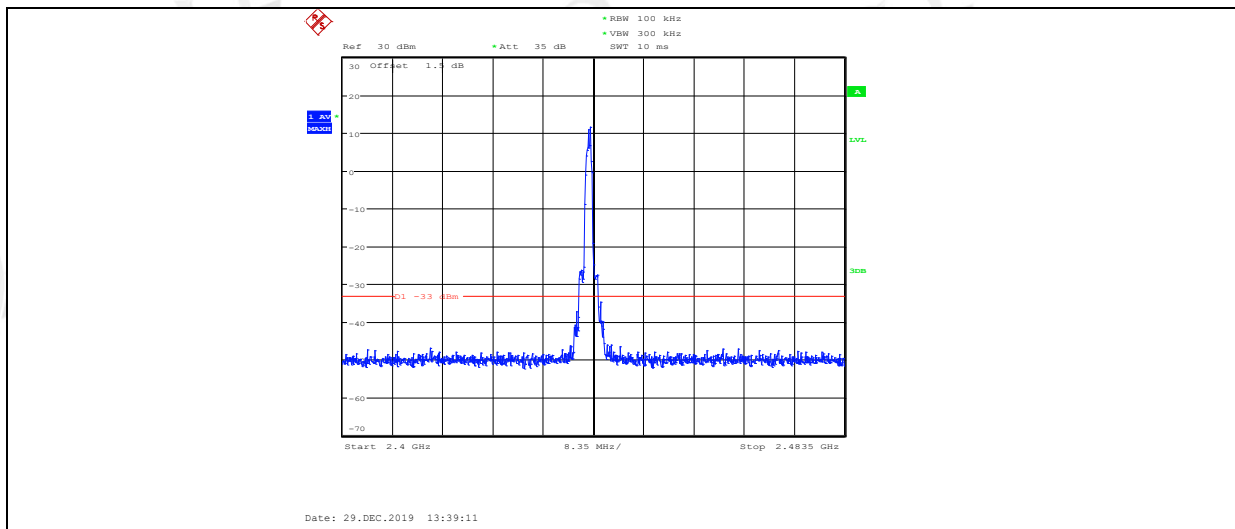

3DH5_ANT1_2441_2470-2490

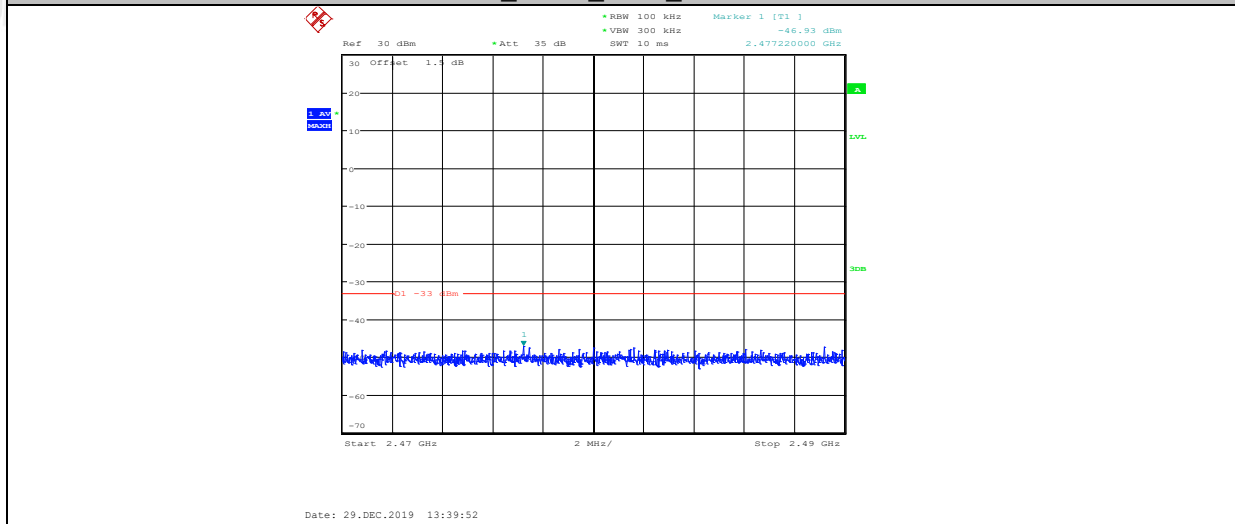

3DH5_ANT1_2441_3400-3530

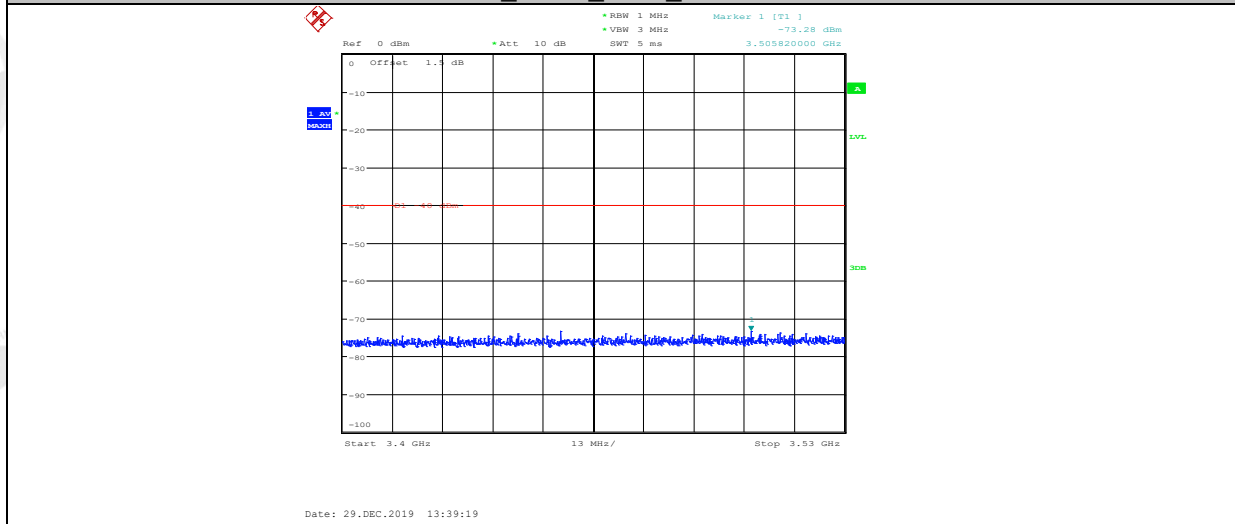

3DH5_ANT1_2441_5725-5850

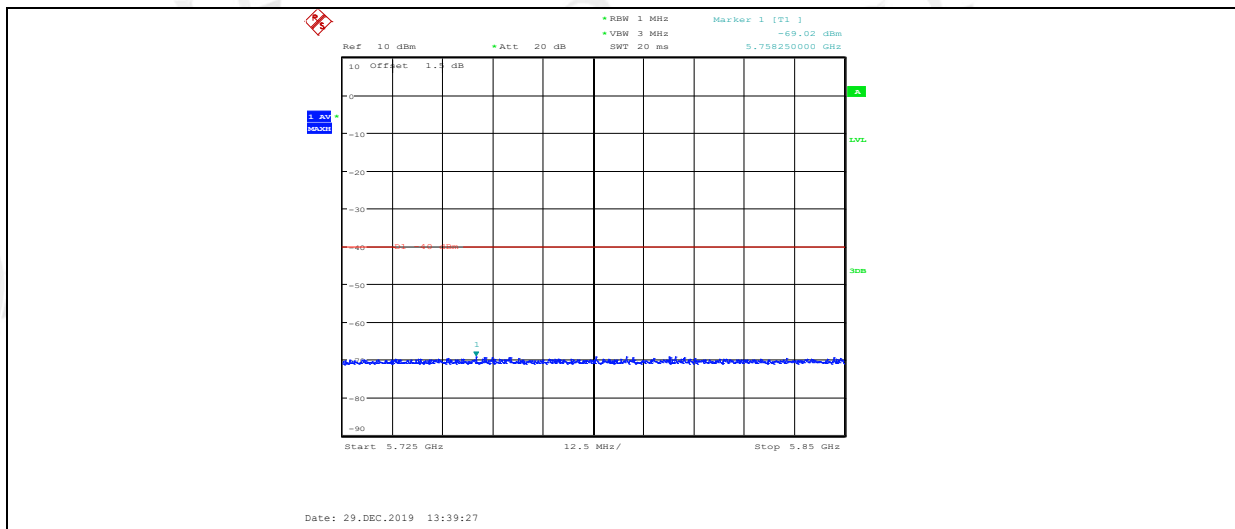

3DH5_ANT1_2480_Ref

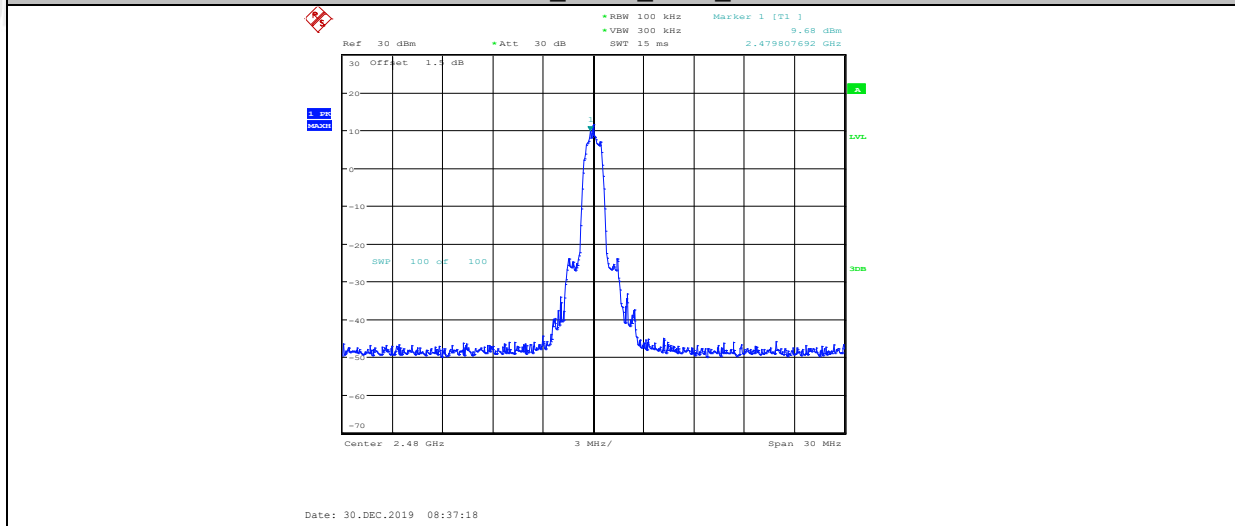

3DH5_ANT1_2480_30~1000

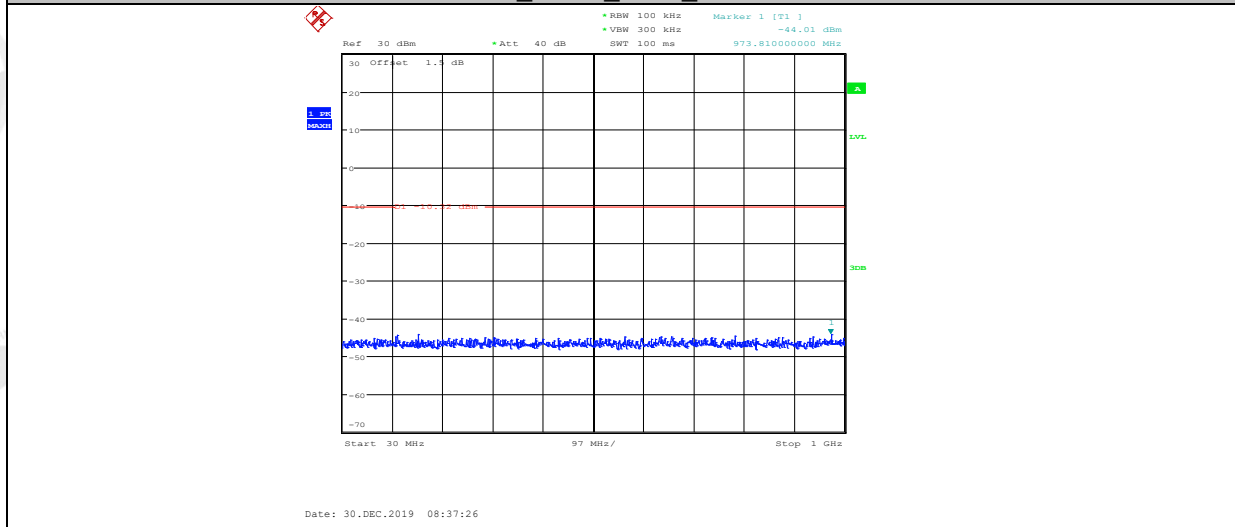

3DH5_ANT1_2480_1000~26500

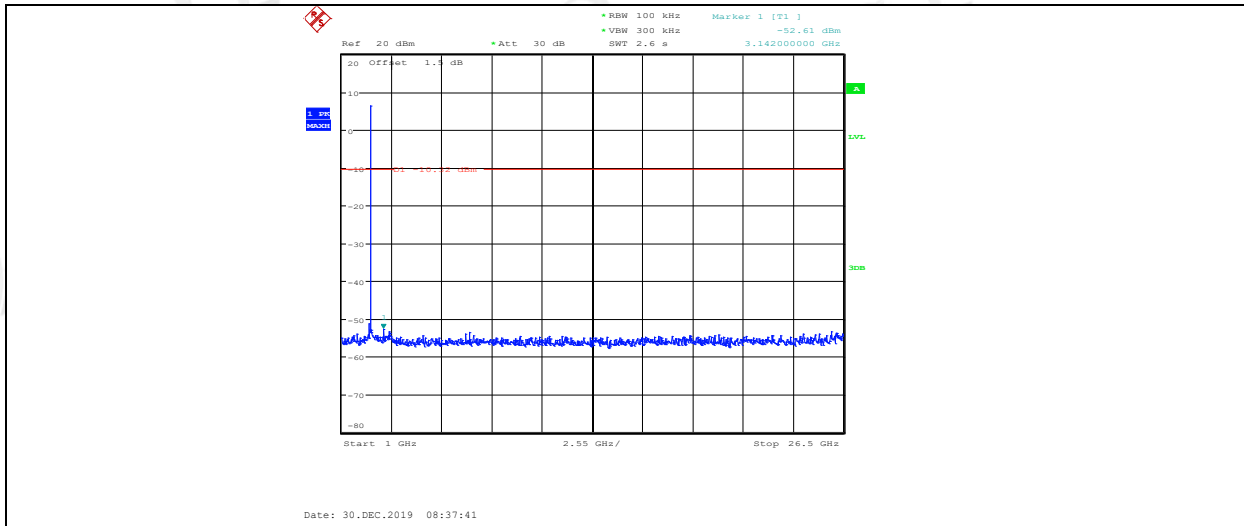

3DH5_ANT1_2480_1000~12750

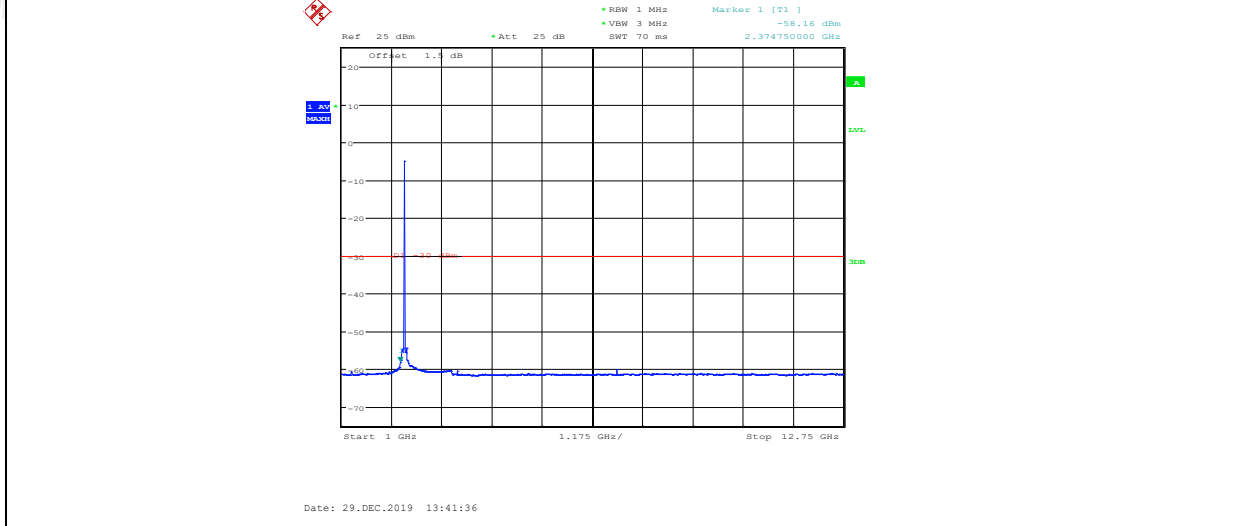

3DH5_ANT1_2480_2390~2420

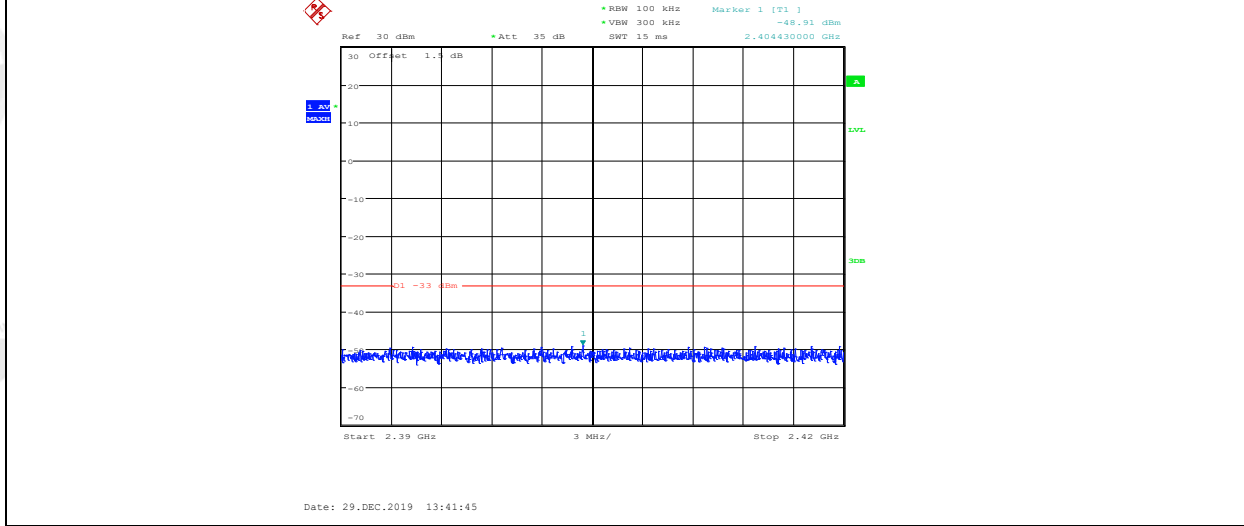

3DH5_ANT1_2480_2400~2483.5

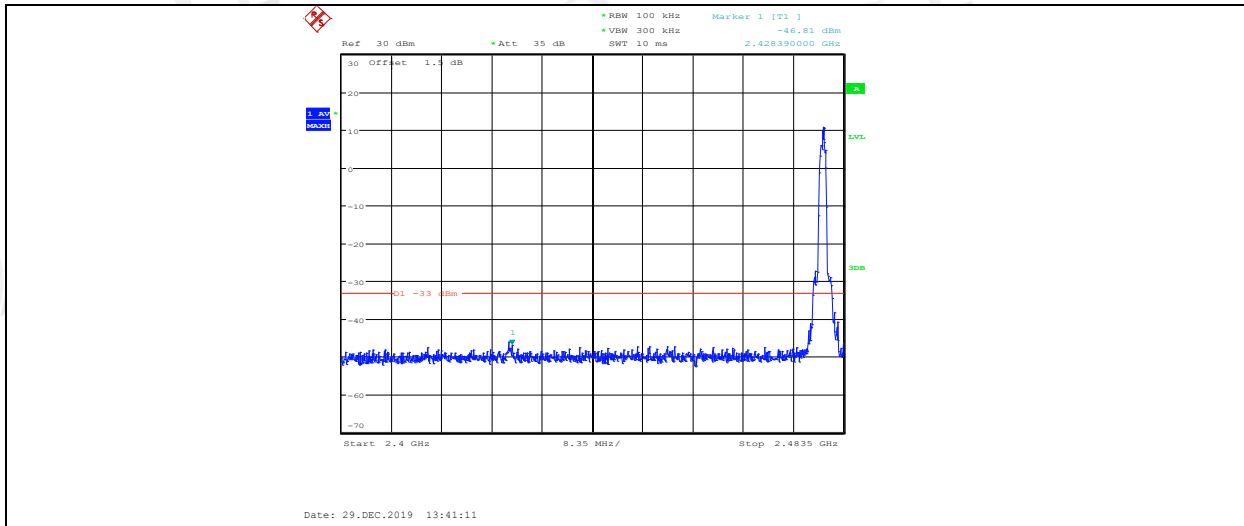

3DH5_ANT1_2480_2470~2490

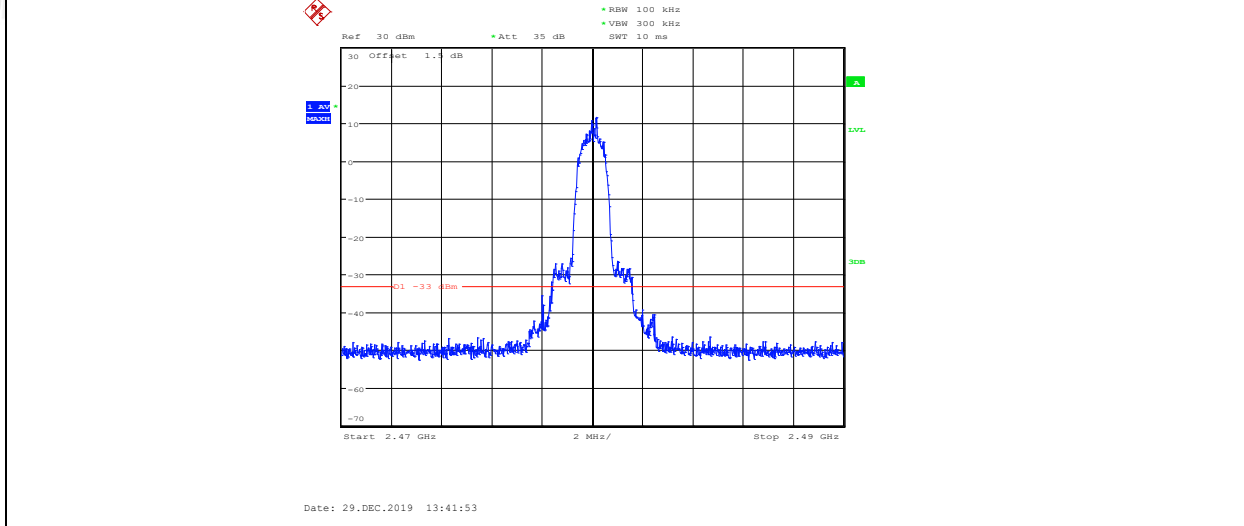

3DH5_ANT1_2480_3400~3530

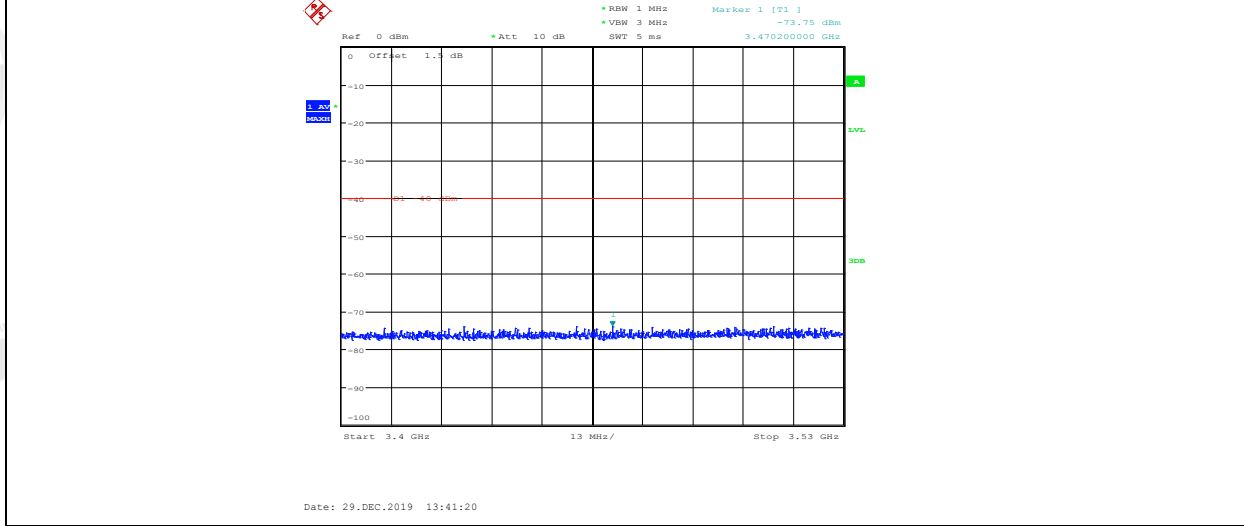

3DH5_ANT1_2480_5725~5850

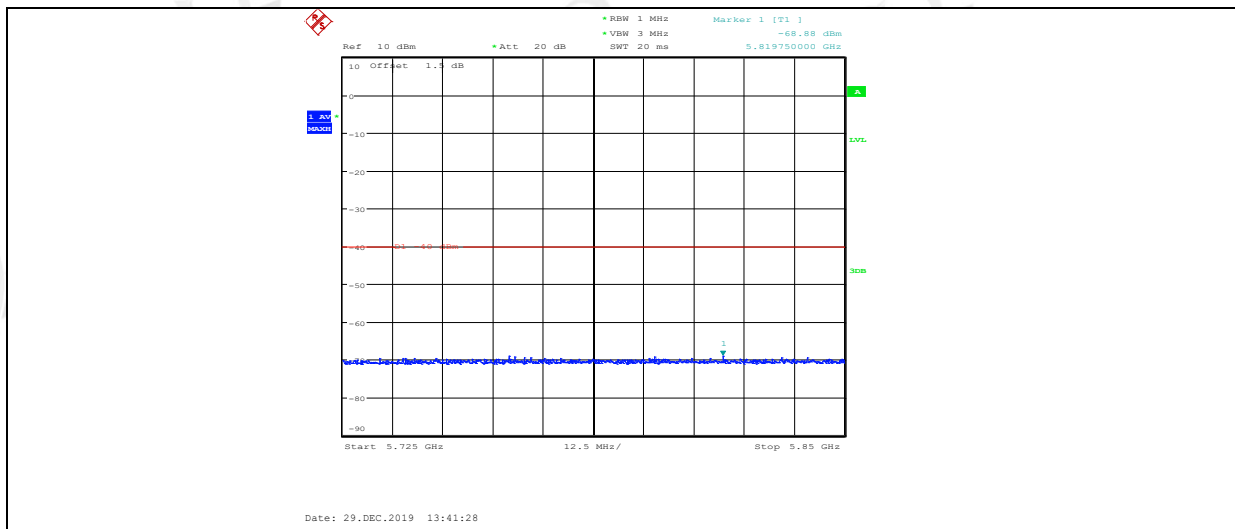

Right side:

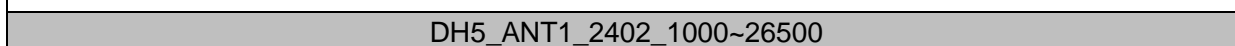
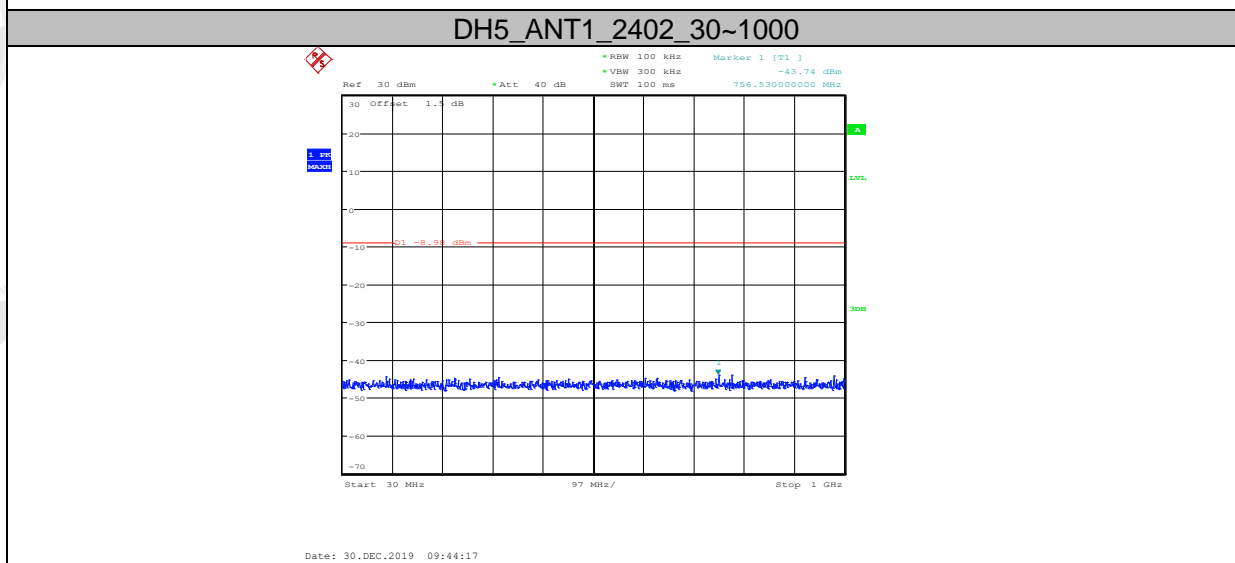
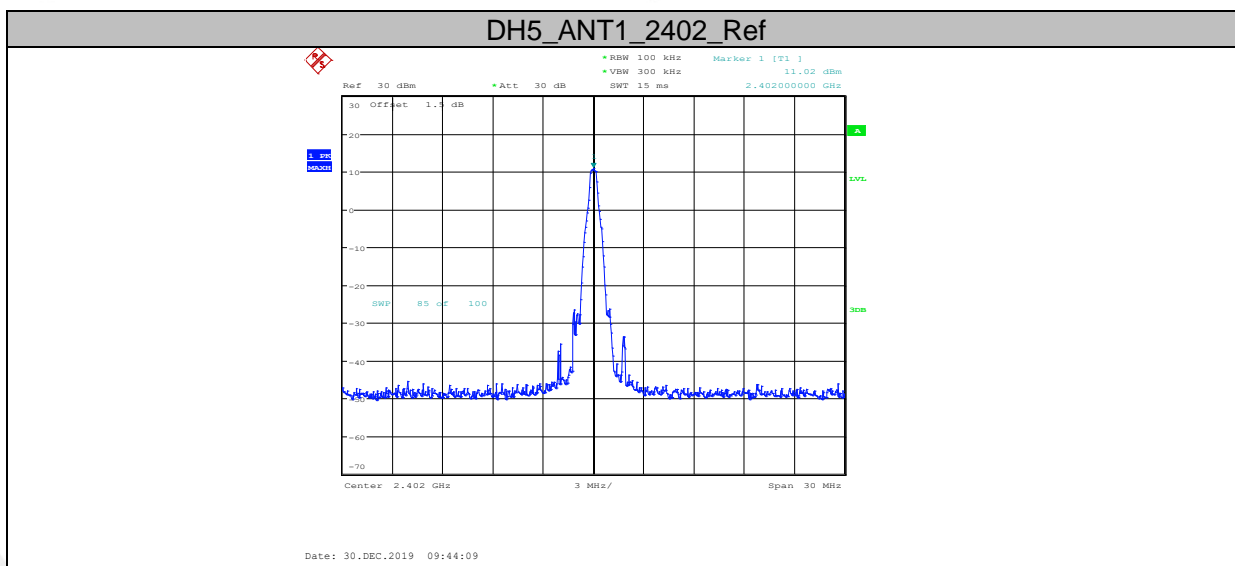

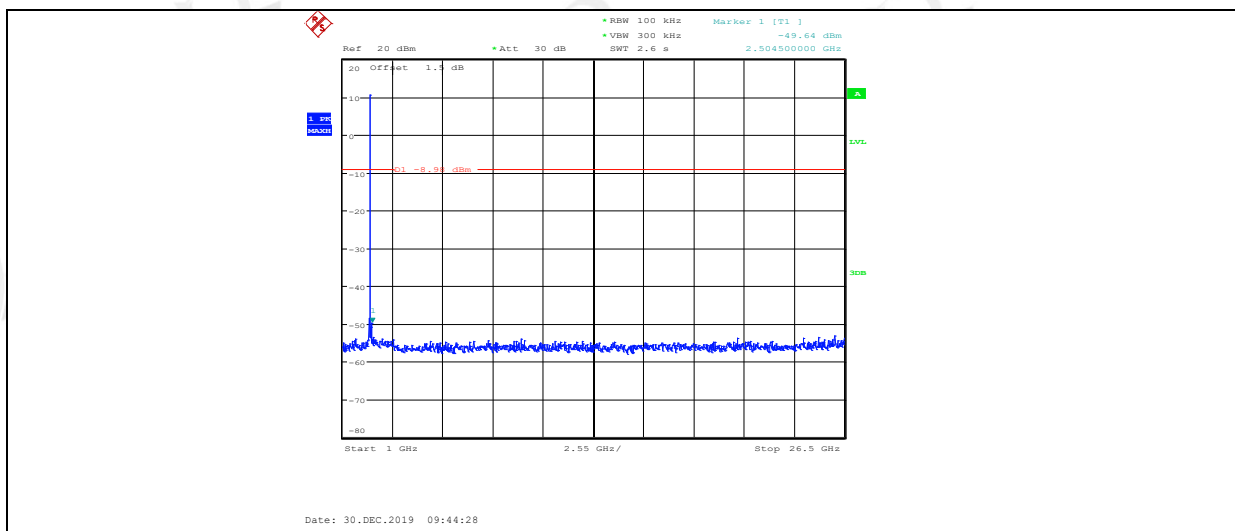

DH5_ANT1_2441_Ref

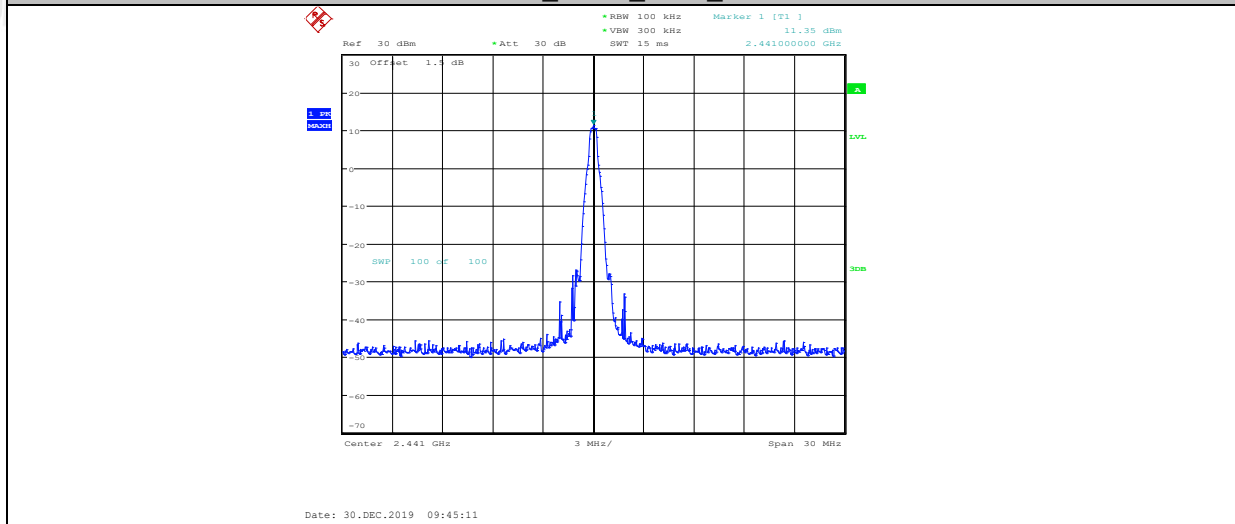

DH5_ANT1_2441_30~1000

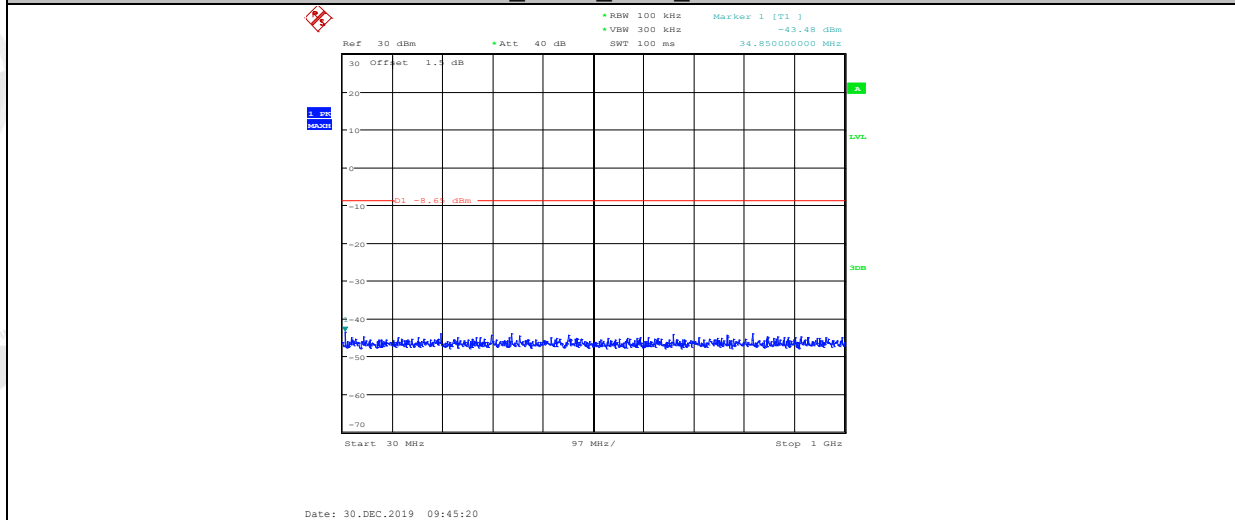

DH5_ANT1_2441_1000~26500

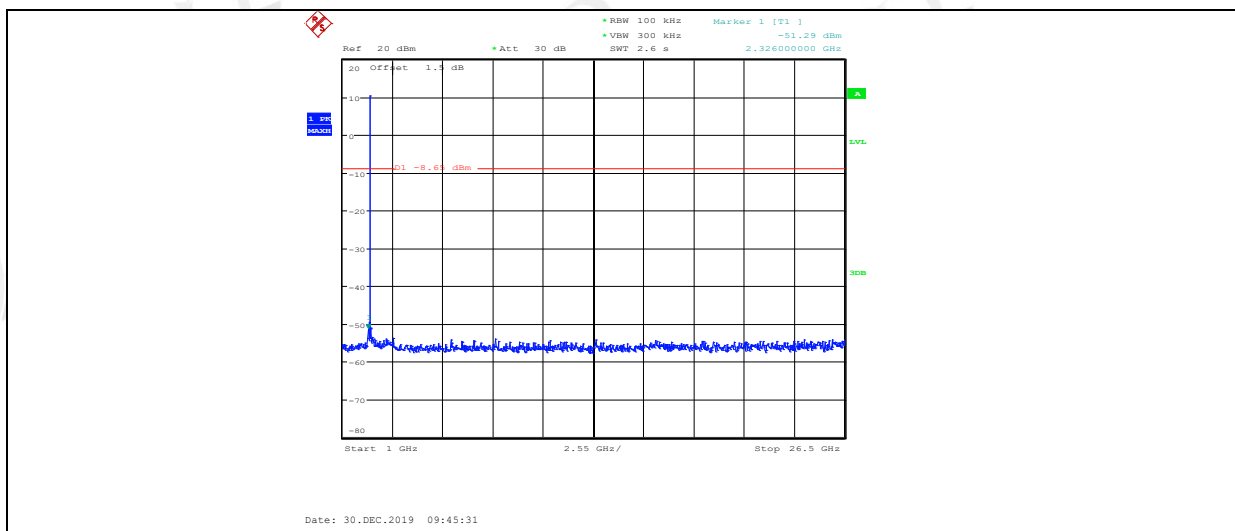

DH5_ANT1_2480_Ref

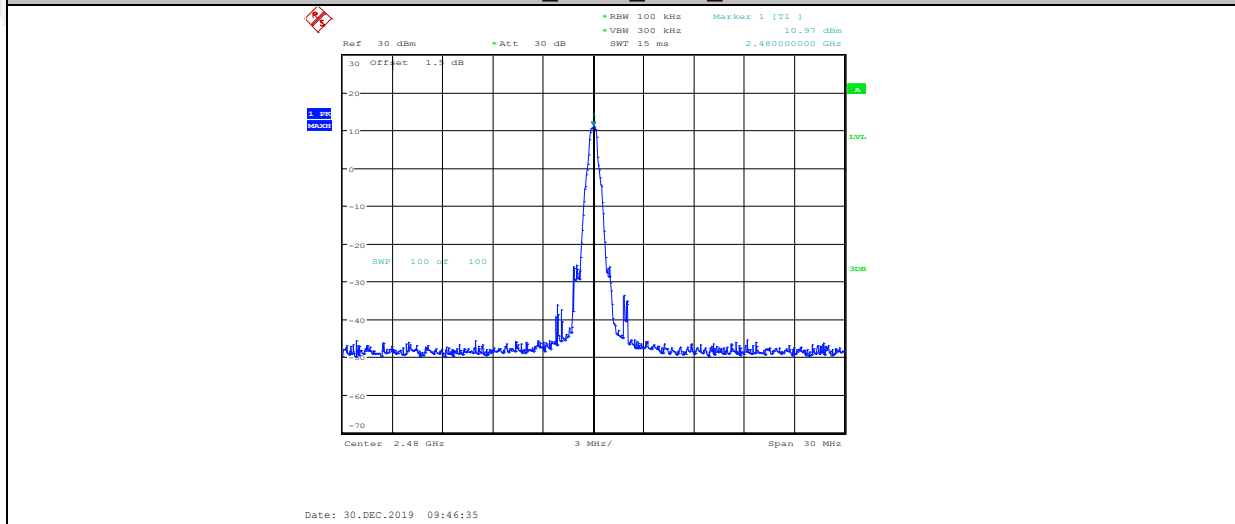

DH5_ANT1_2480_30~1000

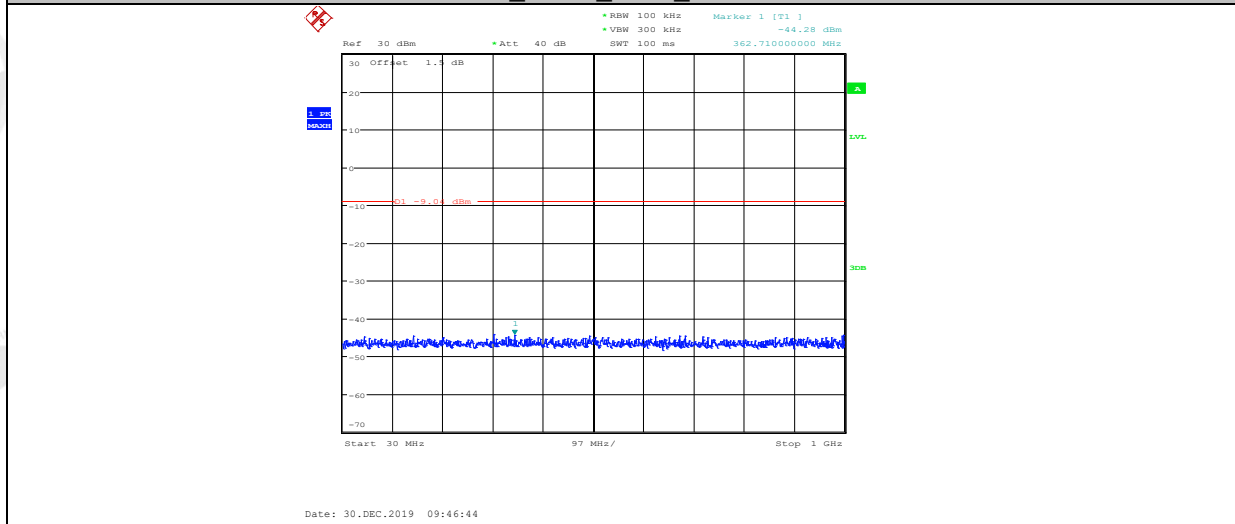

DH5_ANT1_2480_1000~26500

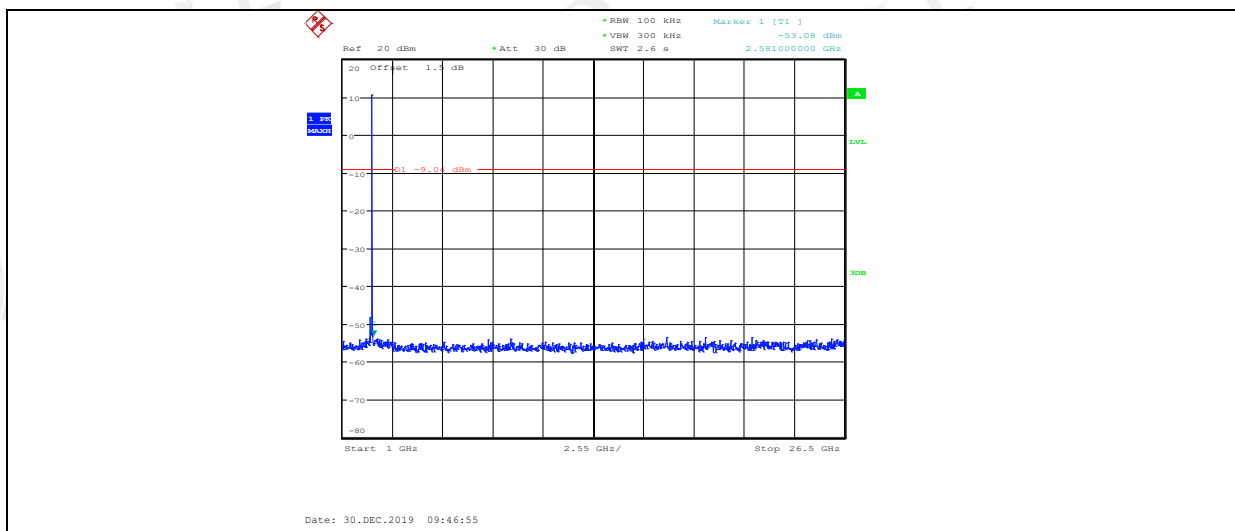

2DH5_ANT1_2402_Ref

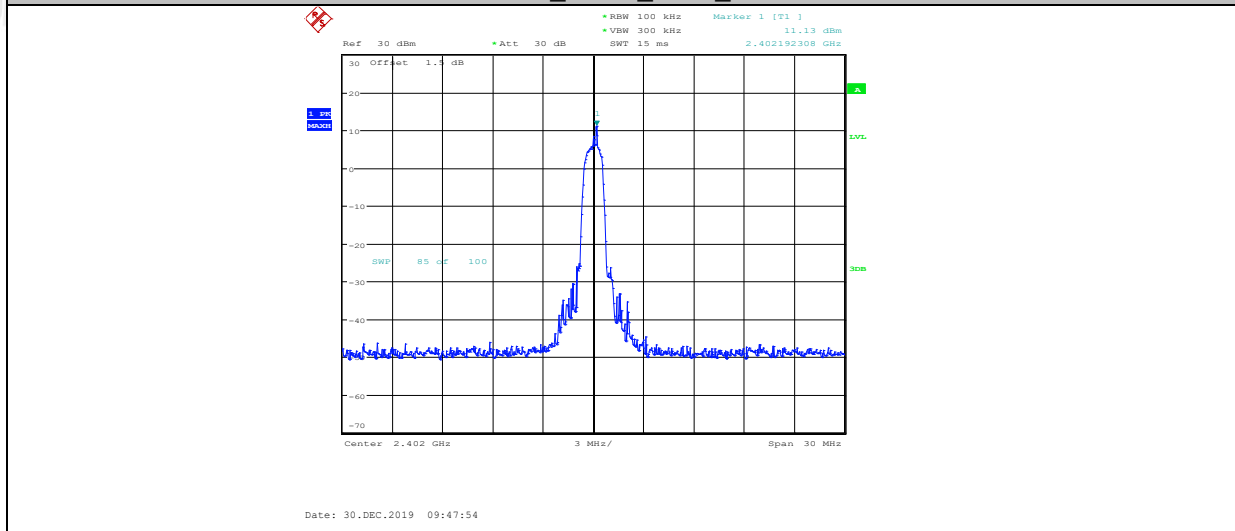

2DH5_ANT1_2402_30~1000

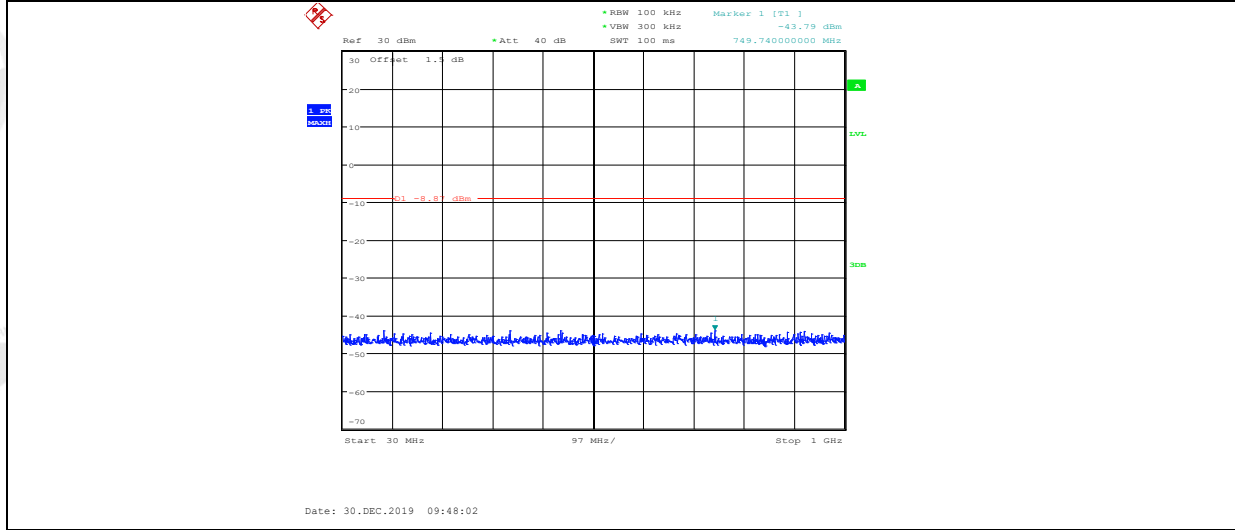

2DH5_ANT1_2402_1000~26500

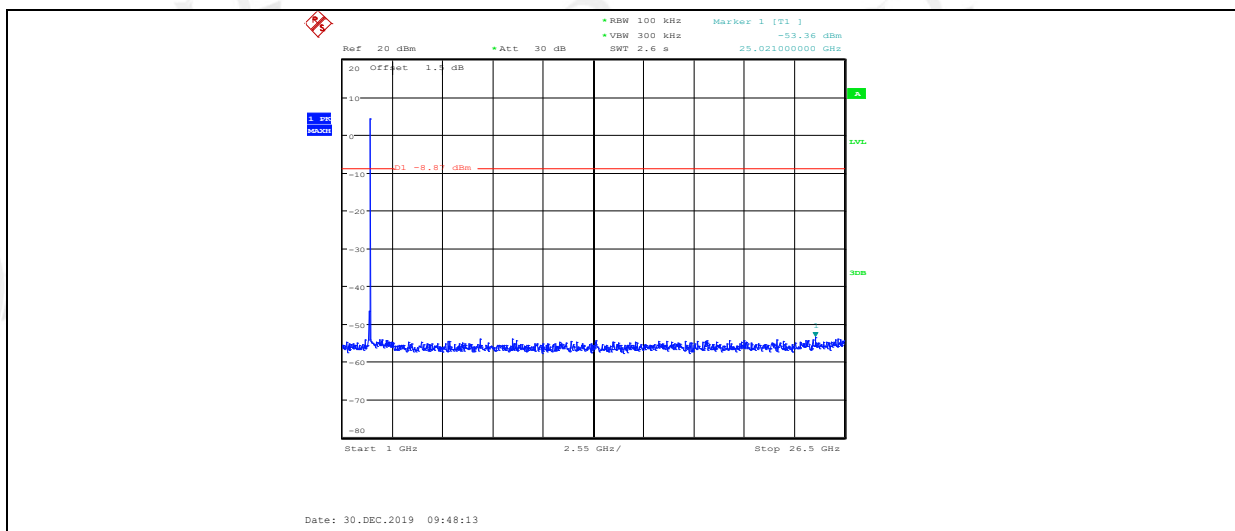

2DH5_ANT1_2441_Ref

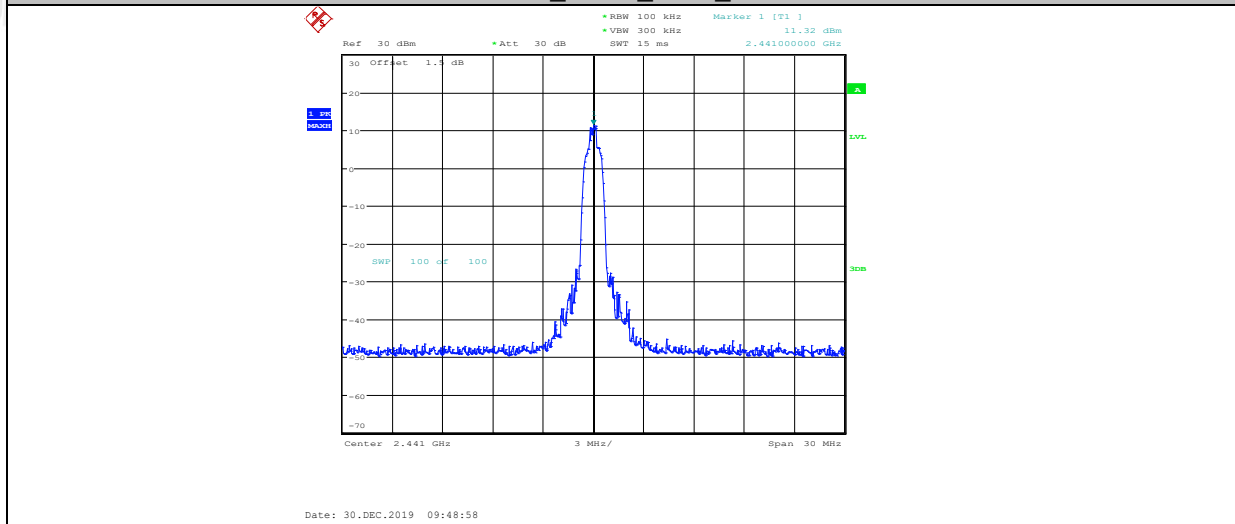

2DH5_ANT1_2441_30~1000

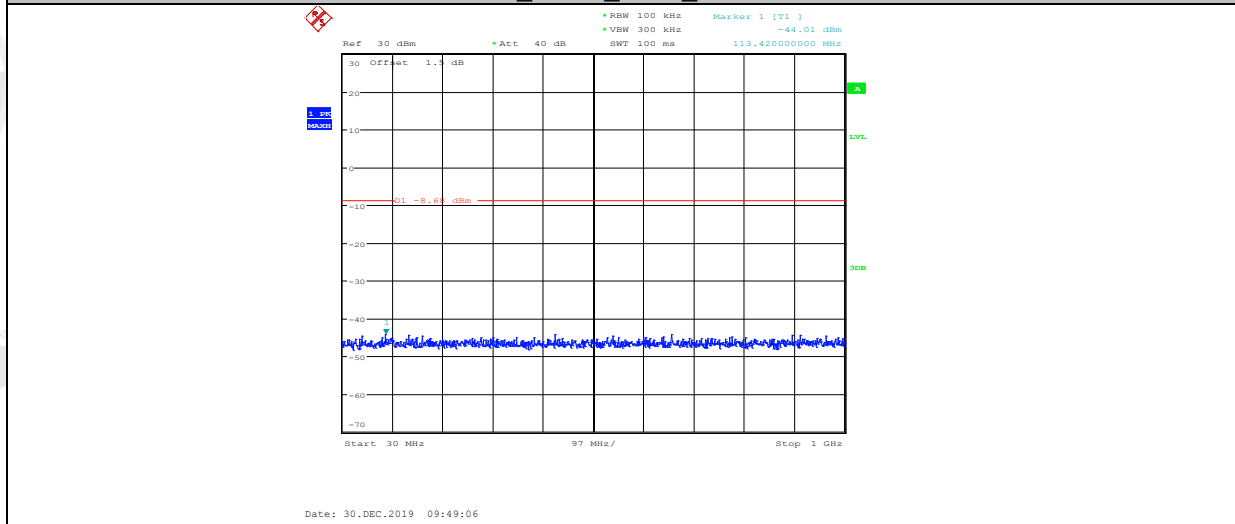

2DH5_ANT1_2441_1000~26500

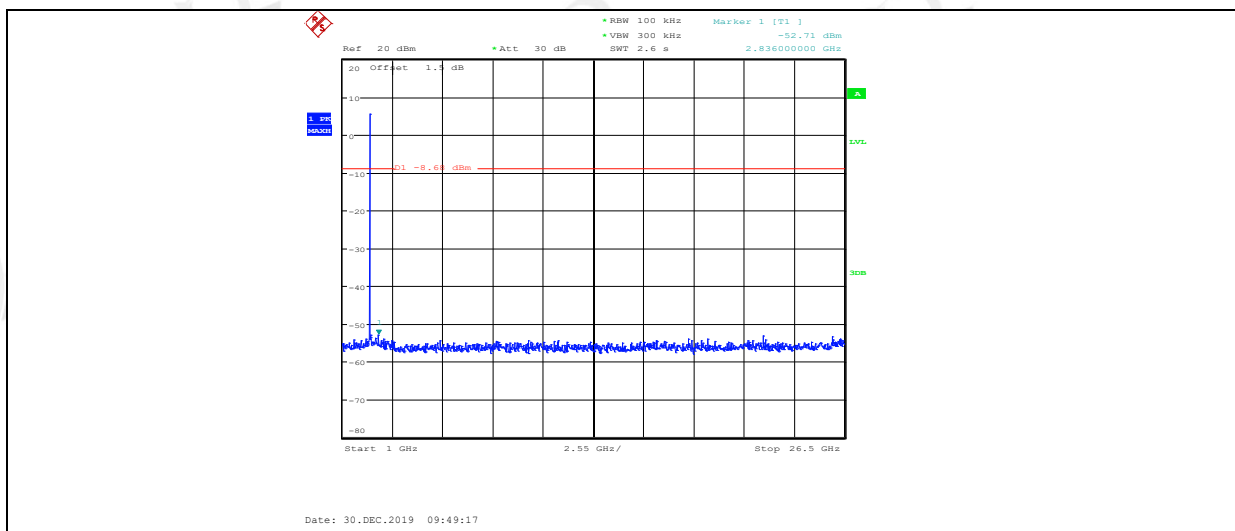

2DH5_ANT1_2480_Ref

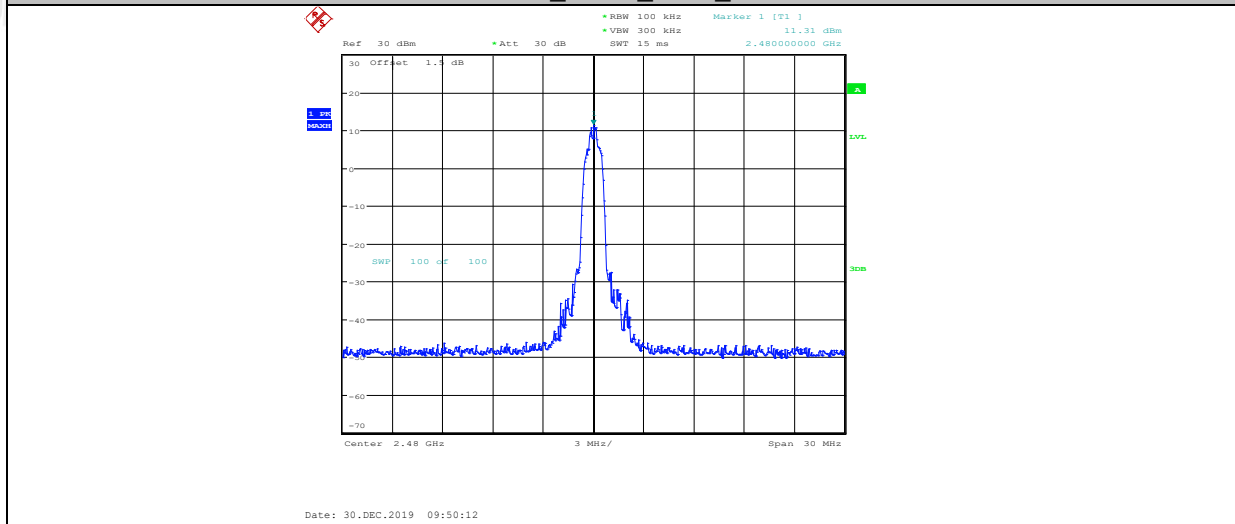

2DH5_ANT1_2480_30~1000

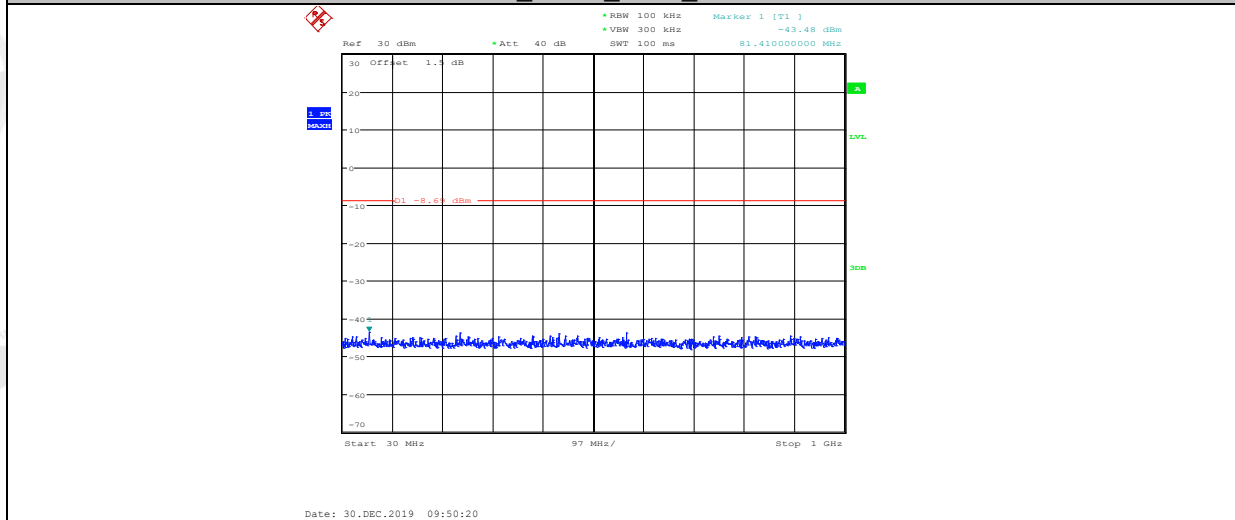

2DH5_ANT1_2480_1000~26500

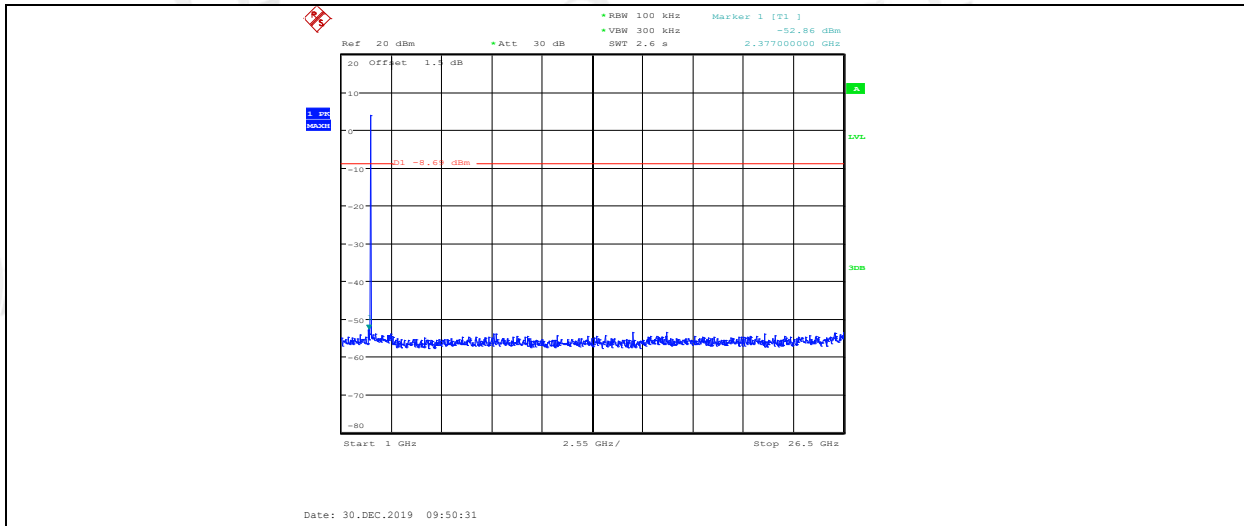

3DH5_ANT1_2402_Ref

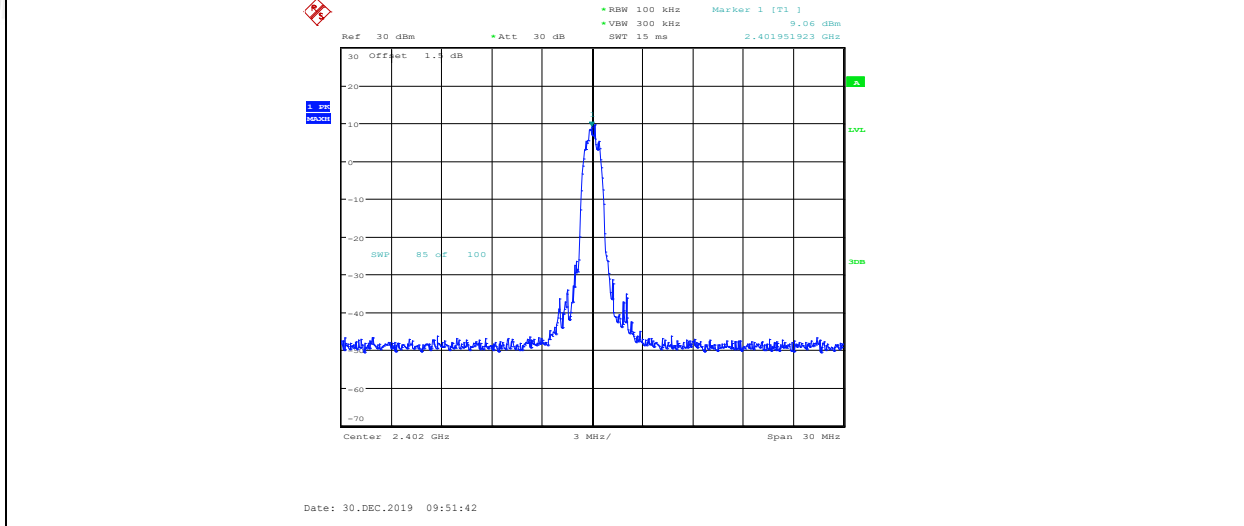

3DH5_ANT1_2402_30~1000

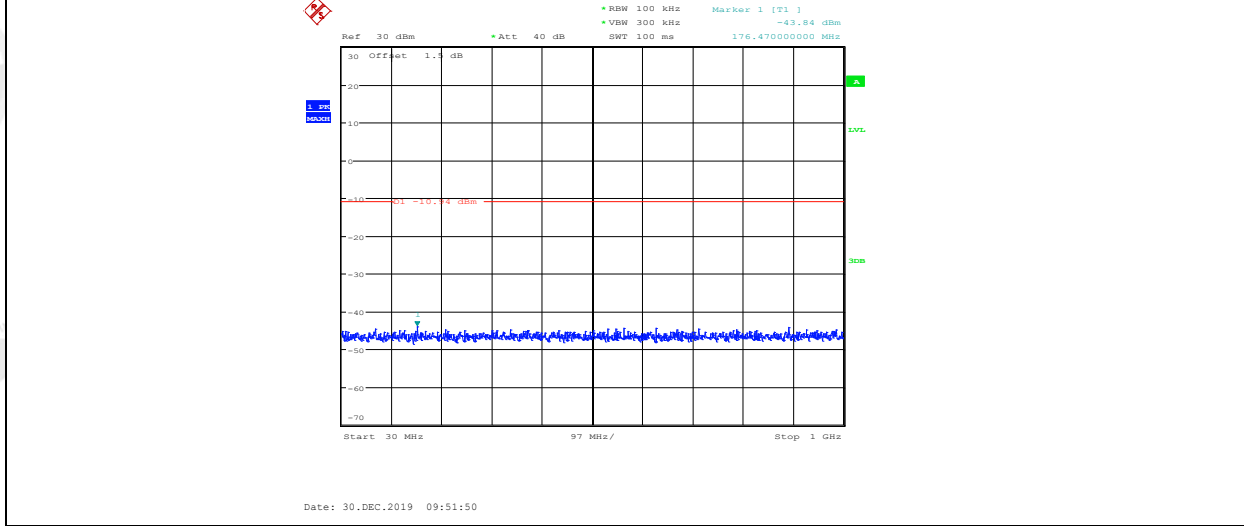

3DH5_ANT1_2402_1000~26500

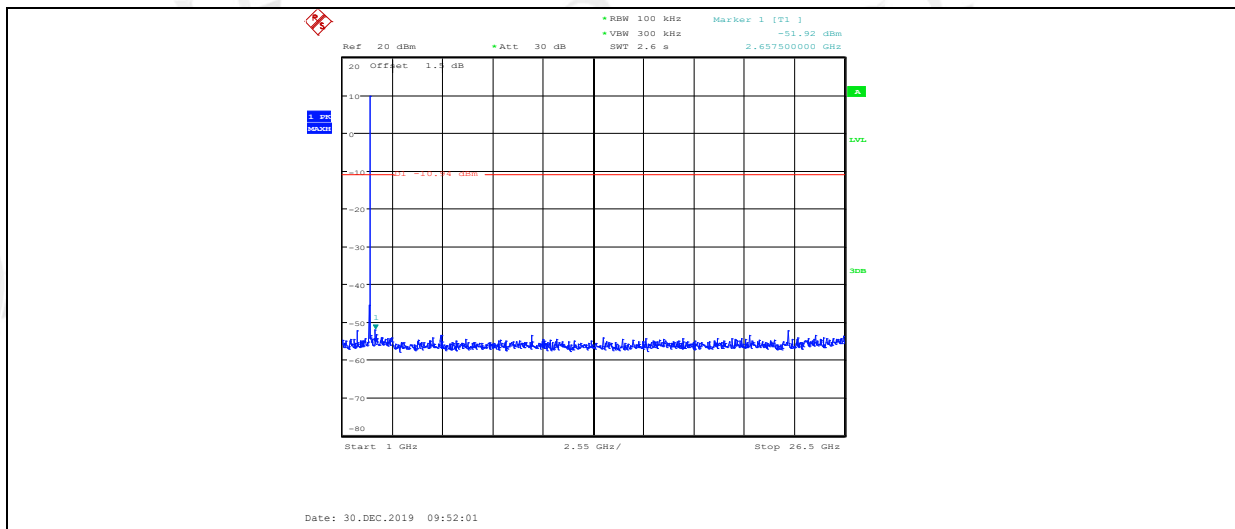

3DH5_ANT1_2441_Ref

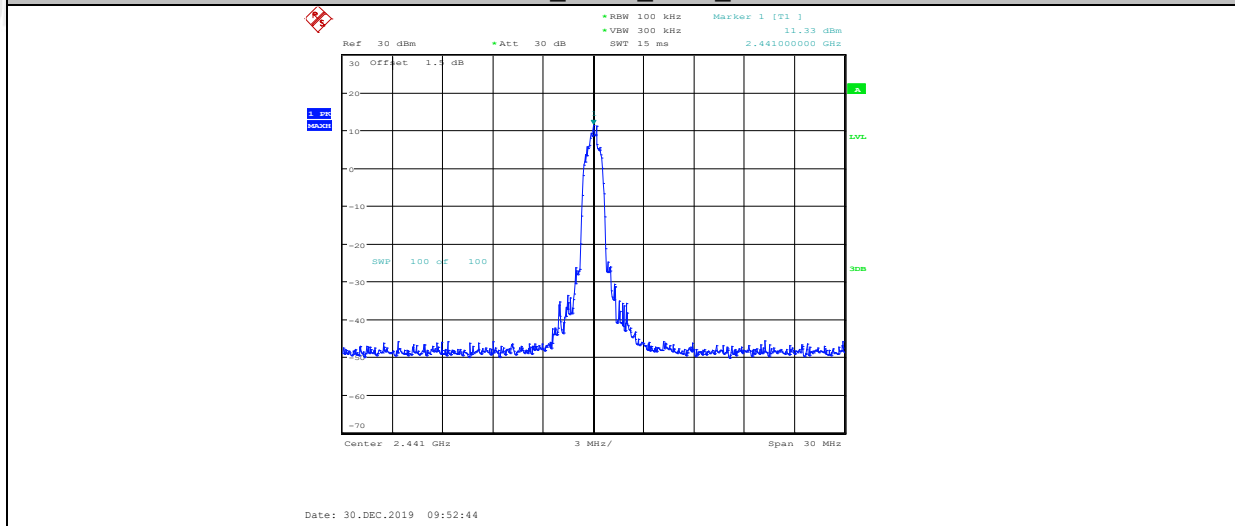

3DH5_ANT1_2441_30~1000

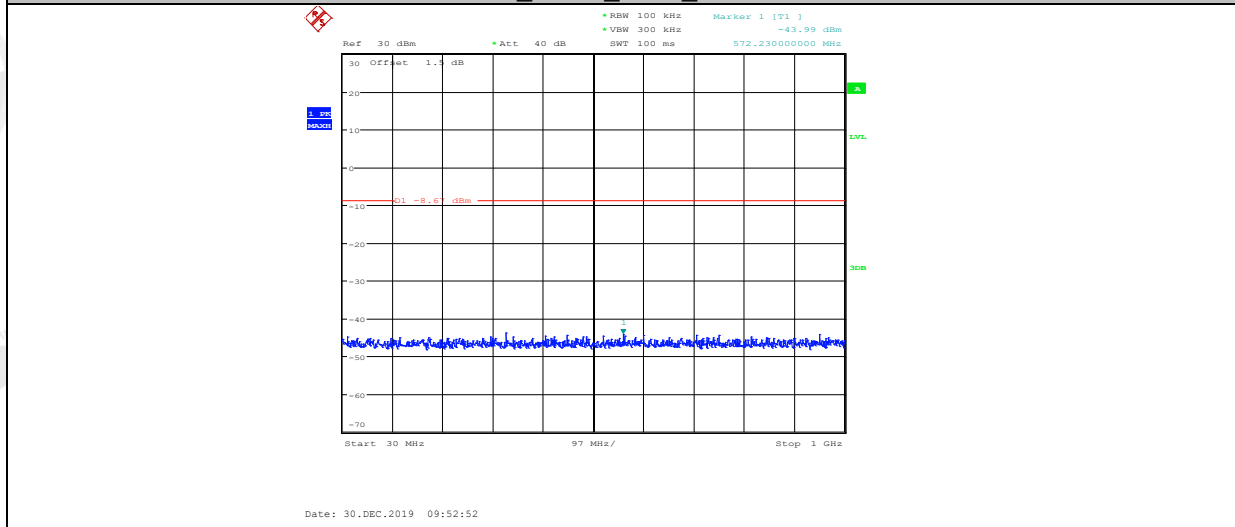

3DH5_ANT1_2441_1000~26500

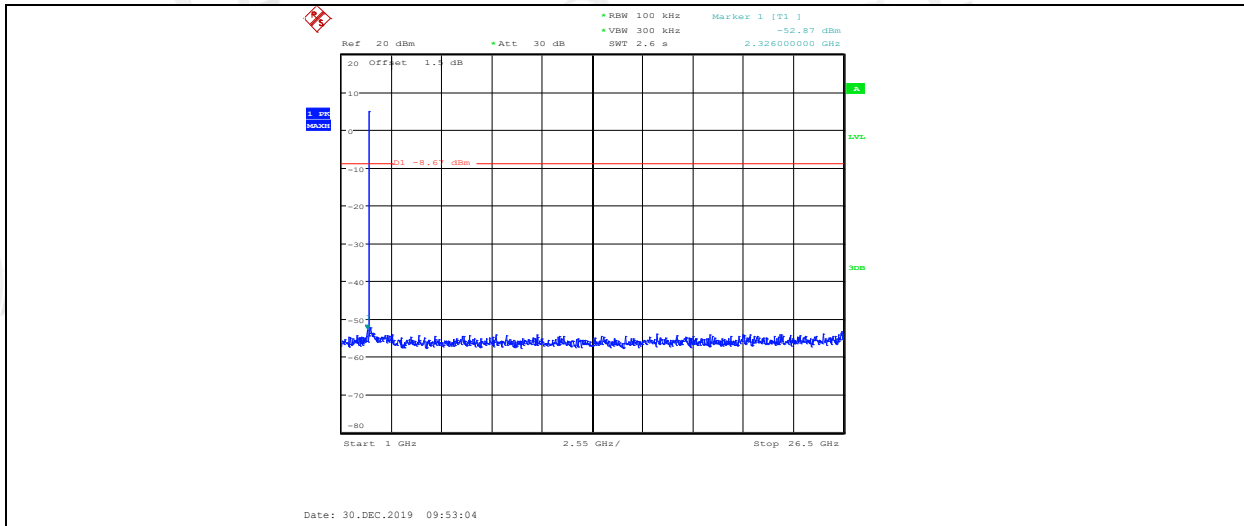

3DH5_ANT1_2480_Ref

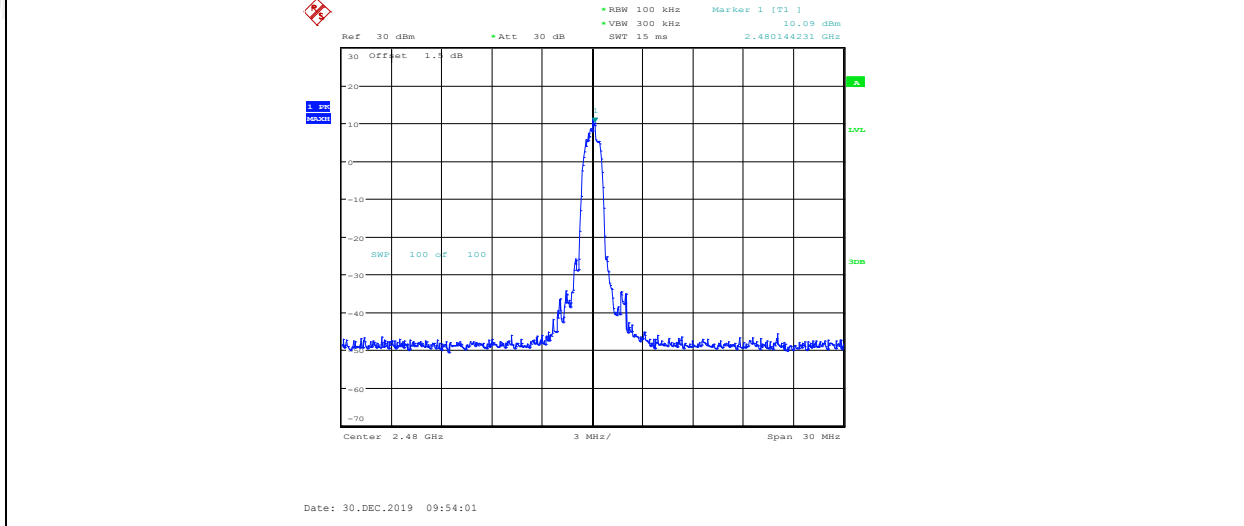

3DH5_ANT1_2480_30~1000

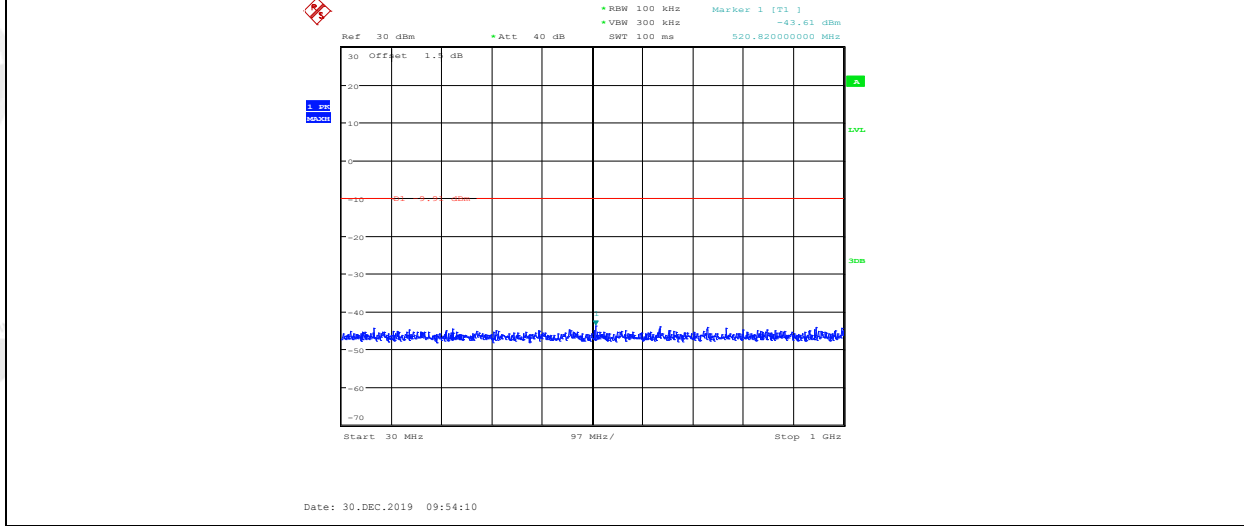

3DH5_ANT1_2480_1000~26500

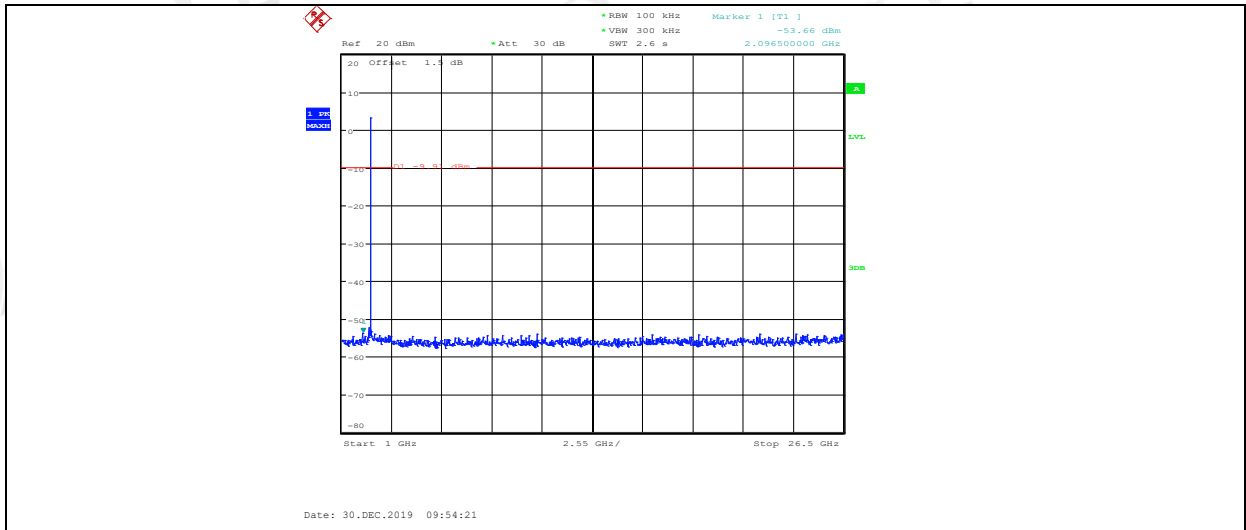

12. Band Edge Compliance (radiated method)

12.1. Block diagram of test setup

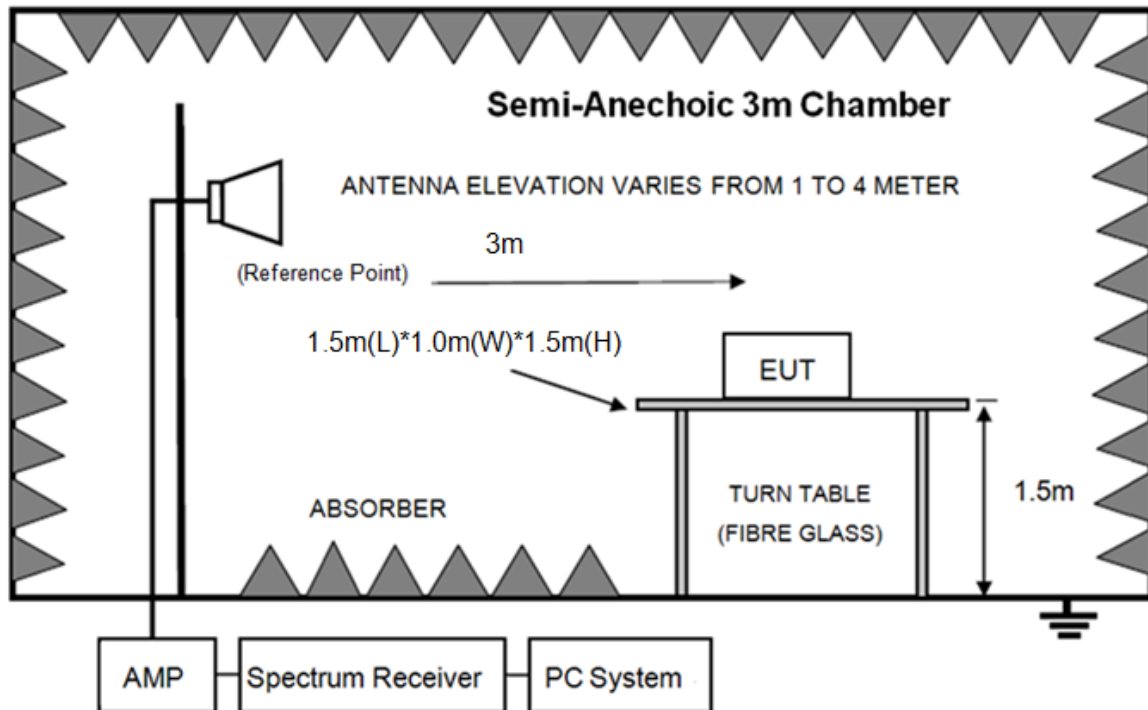

12.2. Limit

All restriction band should comply with 15.209, other emission should be at least 20dB below the fundamental.

12.3. Test Procedure

Same with clause 10.3 except change investigated frequency range from 2310 MHz to 2410 MHz and 2470 MHz to 2500 MHz.

Remark: All restriction band have been tested, and only the worst case is shown in report.

12.4. Test result

PASS. (See below detailed test result)

Remark: hopping on and hopping off mode all have been test, hopping off mode is worse and reported only. Scan with all side, the worst case is left side recorded in this report.

TR-4-E-009 Radiated Emission Test Result

Test Site : DDT 3m Chamber 1# D:\2019 RE1# Report Data\Q19102502-1E HK FLY TWS\FCC ABOVE1G.EM6
Test Date : 2019-12-26 **Tested By** : Talent
EUT : Bluetooth Headset **Model Number** : HK FLY TWS
Power Supply : Battery **Test Mode** : Tx mode
Condition : Temp:24.5°C,Humi:55%,Press:100.1kPa **Antenna/Distance** : 2019 HF 907/3m/HORIZONTAL
Memo : DH5 2402

Data: 31

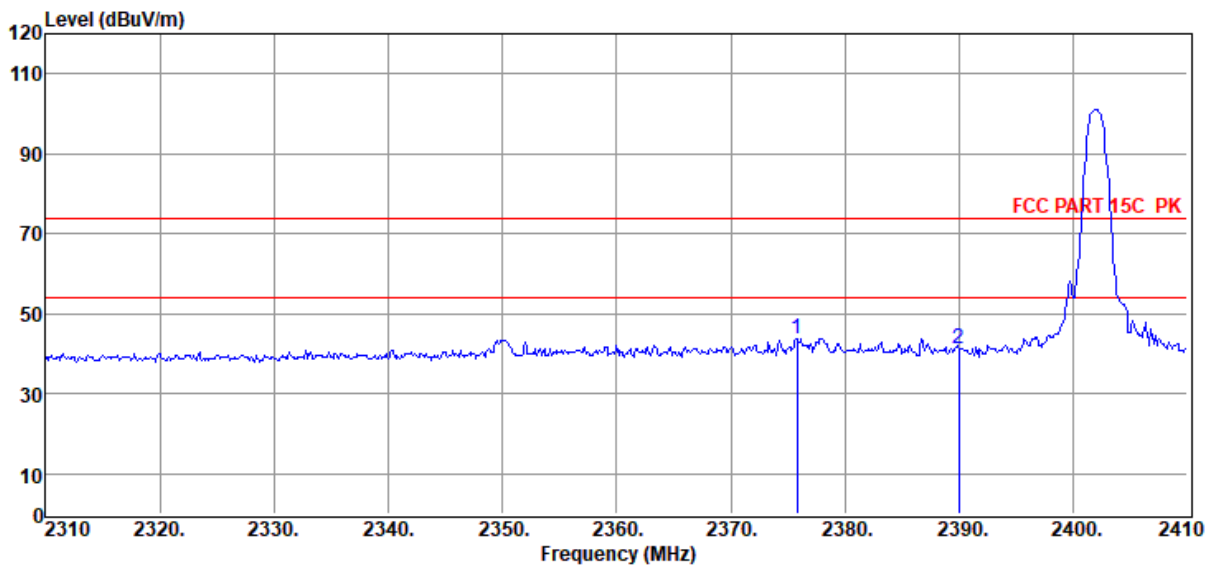

Item (Mark)	Freq. (MHz)	Read Level (dBμV)	Antenna Factor (dB/m)	PRM Factor (dB)	Cable Loss (dB)	Result Level (dBμV/m)	Limit Line (dBμV/m)	Over Limit (dB)	Detector	Polarization
1	2375.80	53.32	29.43	43.20	4.32	43.87	74.00	-30.13	Peak	HORIZONTAL
2	2390.00	50.64	29.46	43.21	4.34	41.23	74.00	-32.77	Peak	HORIZONTAL

Note: 1. Result Level = Read Level + Antenna Factor + Cable loss - PRM Factor.
 2. If Peak Result complies with AV limit, AV Result is deemed to comply with AV limit.
 3. Test setup: RBW: 1 MHz, VBW: 3 MHz, Sweep time: auto.

TR-4-E-009 Radiated Emission Test Result

Test Site : DDT 3m Chamber 1#
Test Date : 2019-12-26
EUT : Bluetooth Headset
Power Supply : Battery
Condition : Temp:24.5°C,Humi:55%,Press:100.1kPa
Memo : DH5 2402

D:\2019 RE1# Report Data\Q19102502-1E HK FLY TWS\FCC ABOVE1G.EM6
Tested By : Talent
Model Number : HK FLY TWS
Test Mode : Tx mode
Antenna/Distance : 2019 HF 907/3m/VERTICAL

Data: 32

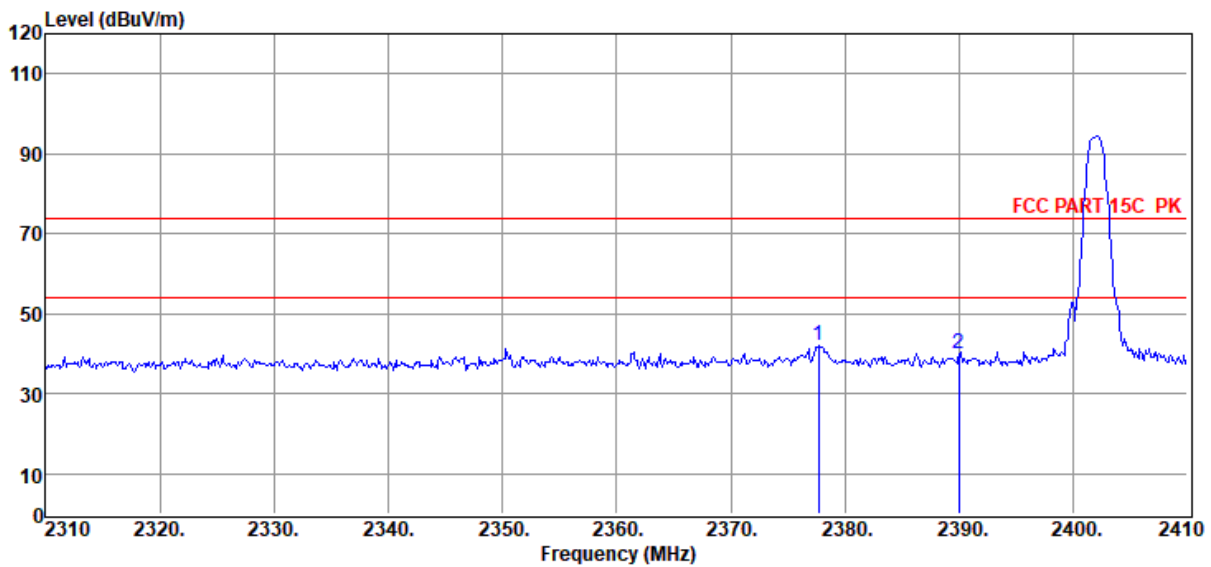

Item (Mark)	Freq. (MHz)	Read Level (dBμV)	Antenna Factor (dB/m)	PRM Factor (dB)	Cable Loss (dB)	Result Level (dBμV/m)	Limit Line (dBμV/m)	Over Limit (dB)	Detector	Polarization
1	2377.70	51.42	29.43	43.20	4.33	41.98	74.00	-32.02	Peak	VERTICAL
2	2390.00	49.53	29.46	43.21	4.34	40.12	74.00	-33.88	Peak	VERTICAL

Note: 1. Result Level = Read Level + Antenna Factor + Cable loss - PRM Factor.

2. If Peak Result complies with AV limit, AV Result is deemed to comply with AV limit.

3. Test setup: RBW: 1 MHz, VBW: 3 MHz, Sweep time: auto.

TR-4-E-009 Radiated Emission Test Result

Test Site : DDT 3m Chamber 1#

D:\2019 RE1# Report Data\Q19102502-1E HK FLY TWS\FCC ABOVE1G.EM6

Test Date : 2019-12-26

Tested By : Talent

EUT : Bluetooth Headset

Model Number : HK FLY TWS

Power Supply : Battery

Test Mode : Tx mode

Condition : Temp:24.5°C,Humi:55%,Press:100.1kPa

Antenna/Distance : 2019 HF 907/3m/VERTICAL

Memo : DH5 2480

Data: 37

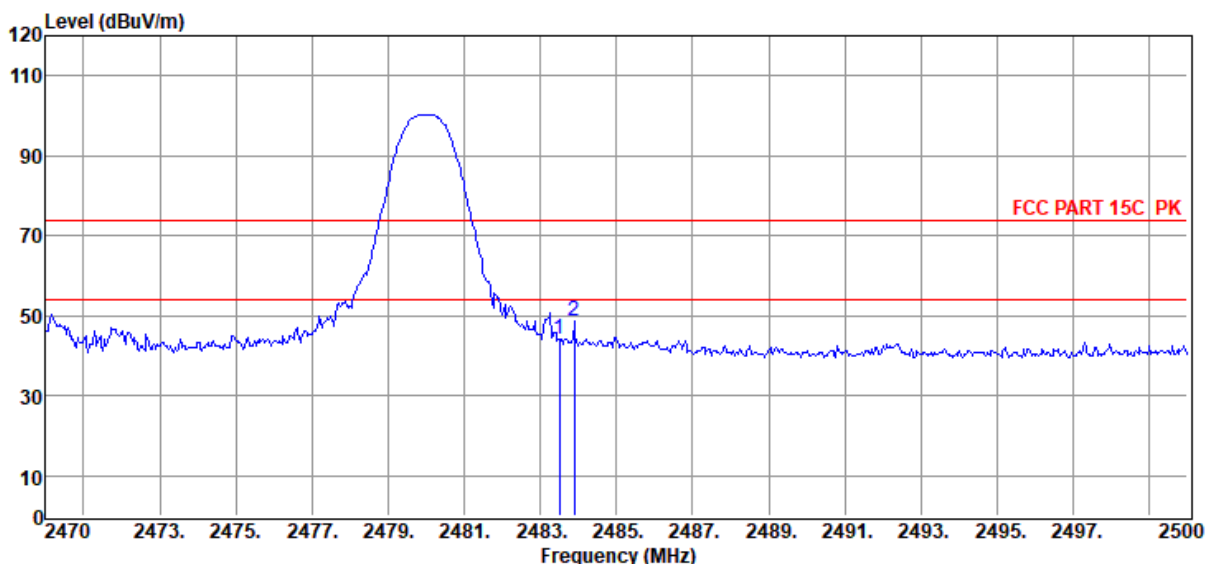

Item (Mark)	Freq. (MHz)	Read Level (dBμV)	Antenna Factor (dB/m)	PRM Factor (dB)	Cable Loss (dB)	Result Level (dBμV/m)	Limit Line (dBμV/m)	Over Limit (dB)	Detector	Polarization
1	2483.50	53.32	29.66	43.25	4.43	44.16	74.00	-29.84	Peak	VERTICAL
2	2483.89	57.68	29.67	43.25	4.43	48.53	74.00	-25.47	Peak	VERTICAL

Note: 1. Result Level = Read Level + Antenna Factor + Cable loss - PRM Factor.

2. If Peak Result complies with AV limit, AV Result is deemed to comply with AV limit.

3. Test setup: RBW: 1 MHz, VBW: 3 MHz, Sweep time: auto.

TR-4-E-009 Radiated Emission Test Result

Test Site : DDT 3m Chamber 1#

D:\2019 RE1# Report Data\Q19102502-1E HK FLY TWS\FCC ABOVE1G.EM6

Test Date : 2019-12-26

Tested By : Talent

EUT : Bluetooth Headset

Model Number : HK FLY TWS

Power Supply : Battery

Test Mode : Tx mode

Condition : Temp:24.5°C,Humi:55%,Press:100.1kPa

Antenna/Distance : 2019 HF 907/3m/HORIZONTAL

Memo : DH5 2480

Data: 38

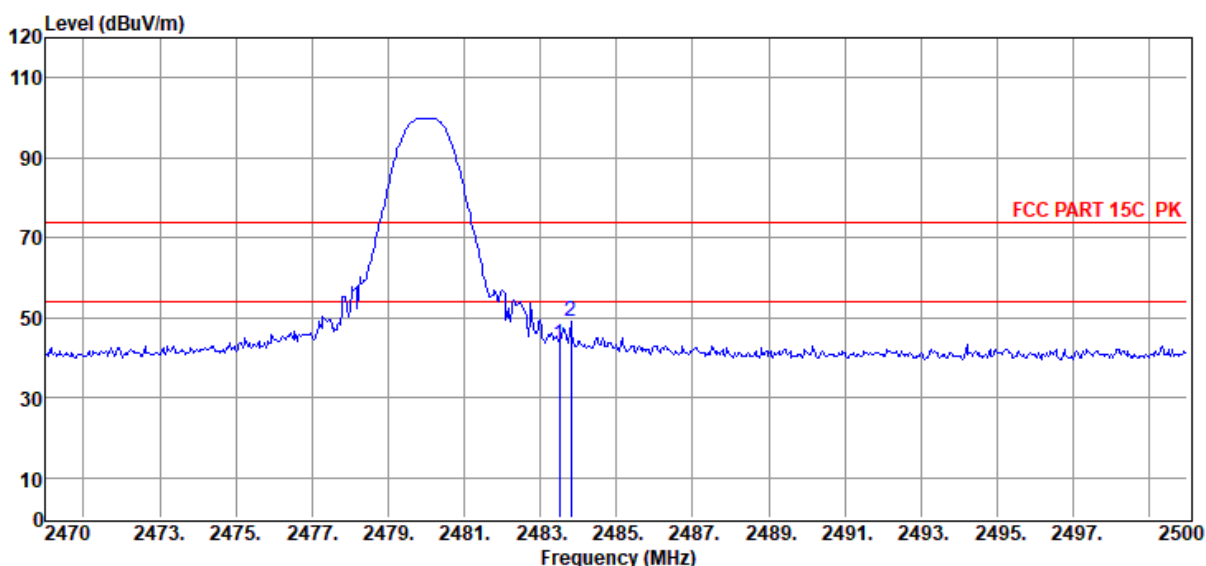

Item (Mark)	Freq. (MHz)	Read Level (dBμV)	Antenna Factor (dB/m)	PRM Factor (dB)	Cable Loss (dB)	Result Level (dBμV/m)	Limit Line (dBμV/m)	Over Limit (dB)	Detector	Polarization
1	2483.50	52.59	29.66	43.25	4.43	43.43	74.00	-30.57	Peak	HORIZONTAL
2	2483.80	58.08	29.67	43.25	4.43	48.93	74.00	-25.07	Peak	HORIZONTAL

Note: 1. Result Level = Read Level + Antenna Factor + Cable loss - PRM Factor.

2. If Peak Result complies with AV limit, AV Result is deemed to comply with AV limit.

3. Test setup: RBW: 1 MHz, VBW: 3 MHz, Sweep time: auto.

TR-4-E-009 Radiated Emission Test Result

Test Site : DDT 3m Chamber 1#

D:\2019 RE1# Report Data\Q19102502-1E HK FLY TWS\FCC ABOVE1G.EM6

Test Date : 2019-12-26

Tested By : Talent

EUT : Bluetooth Headset

Model Number : HK FLY TWS

Power Supply : Battery

Test Mode : Tx mode

Condition : Temp:24.5°C,Humi:55%,Press:100.1kPa

Antenna/Distance : 2019 HF 907/3m/HORIZONTAL

Memo : 2DH5 2402

Data: 39

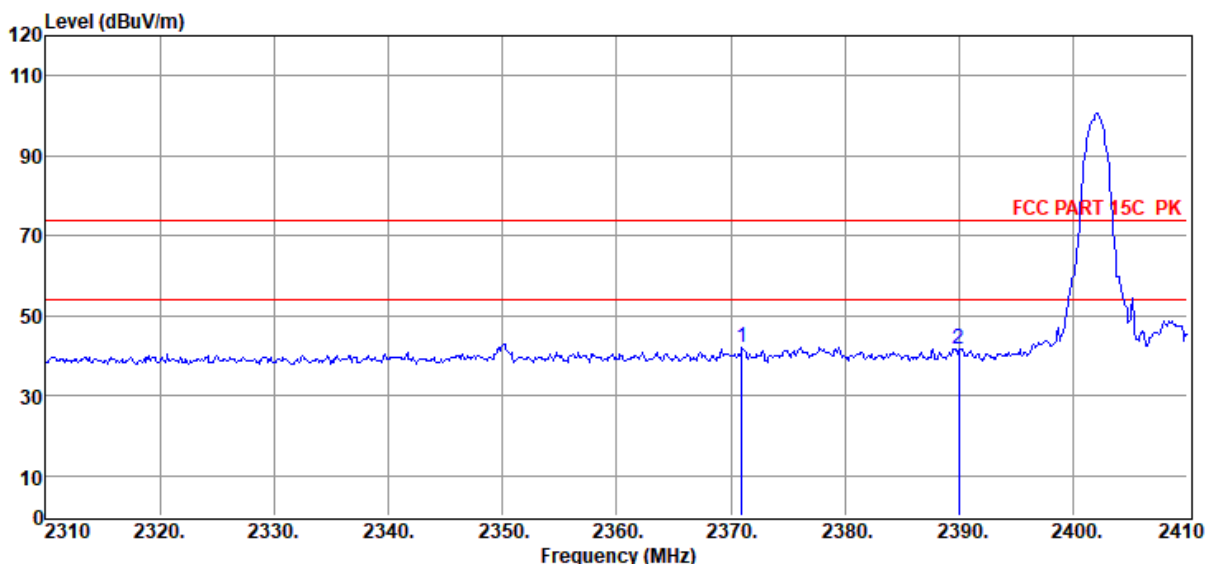

Item (Mark)	Freq. (MHz)	Read Level (dBμV)	Antenna Factor (dB/m)	PRM Factor (dB)	Cable Loss (dB)	Result Level (dBμV/m)	Limit Line (dBμV/m)	Over Limit (dB)	Detector	Polarization
1	2371.00	51.61	29.42	43.20	4.32	42.15	74.00	-31.85	Peak	HORIZONTAL
2	2390.00	50.93	29.46	43.21	4.34	41.52	74.00	-32.48	Peak	HORIZONTAL

Note: 1. Result Level = Read Level + Antenna Factor + Cable loss - PRM Factor.

2. If Peak Result complies with AV limit, AV Result is deemed to comply with AV limit.

3. Test setup: RBW: 1 MHz, VBW: 3 MHz, Sweep time: auto.

TR-4-E-009 Radiated Emission Test Result

Test Site : DDT 3m Chamber 1#

D:\2019 RE1# Report Data\Q19102502-1E HK FLY TWS\FCC ABOVE1G.EM6

Test Date : 2019-12-26

Tested By : Talent

EUT : Bluetooth Headset

Model Number : HK FLY TWS

Power Supply : Battery

Test Mode : Tx mode

Condition : Temp:24.5°C,Humi:55%,Press:100.1kPa

Antenna/Distance : 2019 HF 907/3m/VERTICAL

Memo : 2DH5 2402

Data: 40

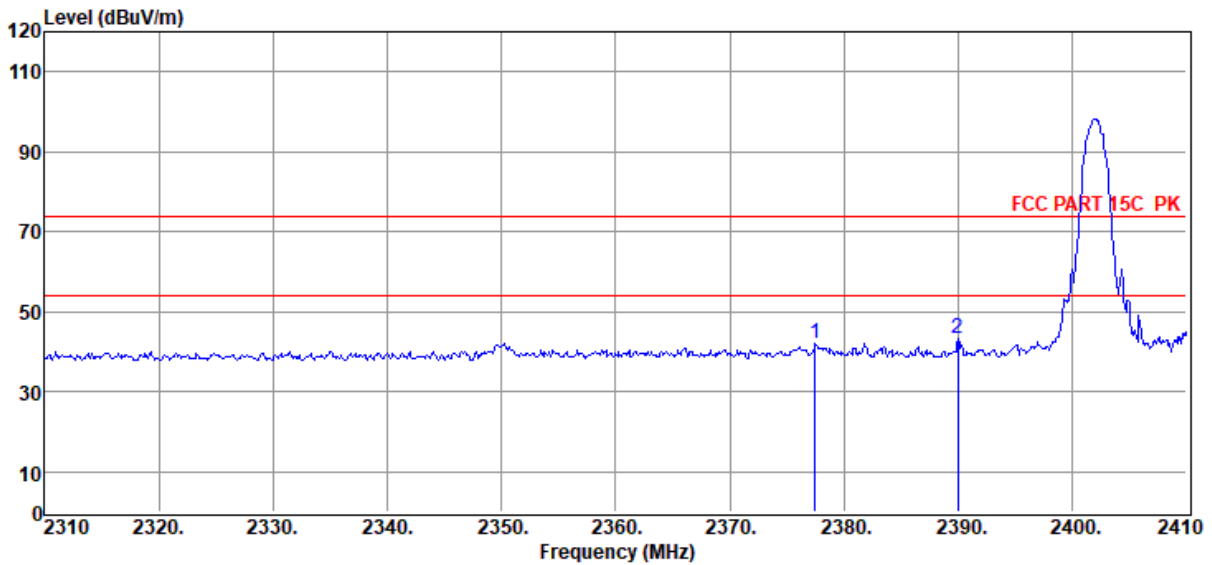

Item (Mark)	Freq. (MHz)	Read Level (dBμV)	Antenna Factor (dB/m)	PRM Factor (dB)	Cable Loss (dB)	Result Level (dBμV/m)	Limit Line (dBμV/m)	Over Limit (dB)	Detector	Polarization
1	2377.50	51.51	29.43	43.20	4.33	42.07	74.00	-31.93	Peak	VERTICAL
2	2390.00	52.87	29.46	43.21	4.34	43.46	74.00	-30.54	Peak	VERTICAL

- Note: 1. Result Level = Read Level + Antenna Factor + Cable loss - PRM Factor.
 2. If Peak Result complies with AV limit, AV Result is deemed to comply with AV limit.
 3. Test setup: RBW: 1 MHz, VBW: 3 MHz, Sweep time: auto.

TR-4-E-009 Radiated Emission Test Result

Test Site : DDT 3m Chamber 1#

D:\2019 RE1# Report Data\Q19102502-1E HK FLY TWS\FCC ABOVE1G.EM6

Test Date : 2019-12-26

Tested By : Talent

EUT : Bluetooth Headset

Model Number : HK FLY TWS

Power Supply : Battery

Test Mode : Tx mode

Condition : Temp:24.5°C,Humi:55%,Press:100.1kPa

Antenna/Distance : 2019 HF 907/3m/VERTICAL

Memo : 2DH5 2480

Data: 41

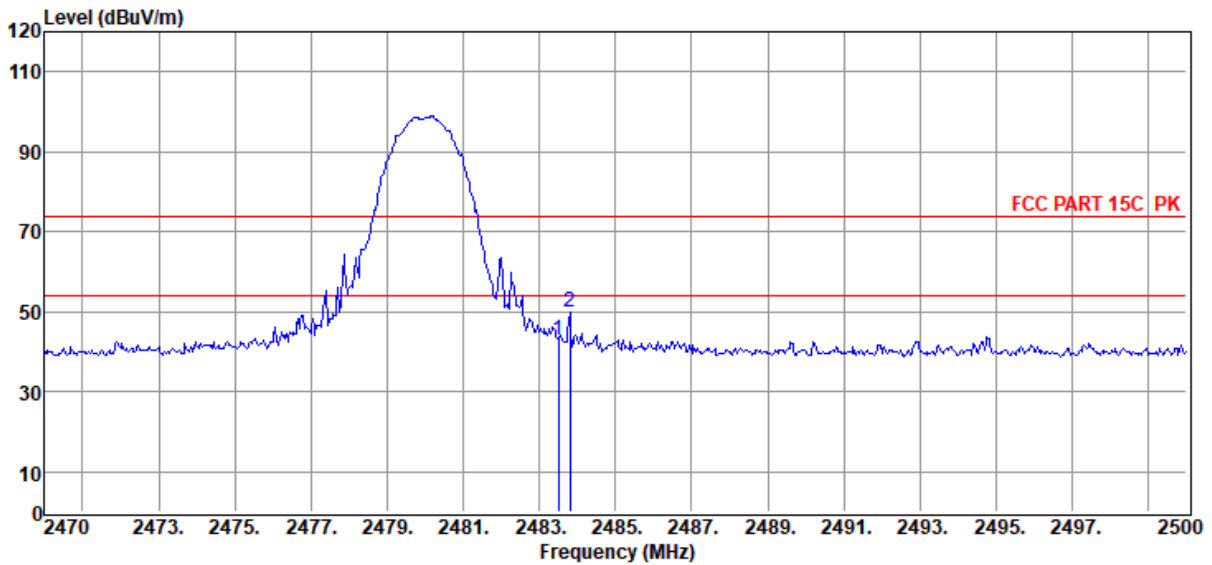

Item (Mark)	Freq. (MHz)	Read Level (dBμV)	Antenna Factor (dB/m)	PRM Factor (dB)	Cable Loss (dB)	Result Level (dBμV/m)	Limit Line (dBμV/m)	Over Limit (dB)	Detector	Polarization
1	2483.50	51.88	29.66	43.25	4.43	42.72	74.00	-31.28	Peak	VERTICAL
2	2483.80	58.91	29.67	43.25	4.43	49.76	74.00	-24.24	Peak	VERTICAL

- Note: 1. Result Level = Read Level + Antenna Factor + Cable loss - PRM Factor.
 2. If Peak Result complies with AV limit, AV Result is deemed to comply with AV limit.
 3. Test setup: RBW: 1 MHz, VBW: 3 MHz, Sweep time: auto.

TR-4-E-009 Radiated Emission Test Result

Test Site : DDT 3m Chamber 1#

D:\2019 RE1# Report Data\Q19102502-1E HK FLY TWS\FCC ABOVE1G.EM6

Test Date : 2019-12-26

Tested By : Talent

EUT : Bluetooth Headset

Model Number : HK FLY TWS

Power Supply : Battery

Test Mode : Tx mode

Condition : Temp:24.5°C,Humi:55%,Press:100.1kPa

Antenna/Distance : 2019 HF 907/3m/HORIZONTAL

Memo : 2DH5 2480

Data: 42

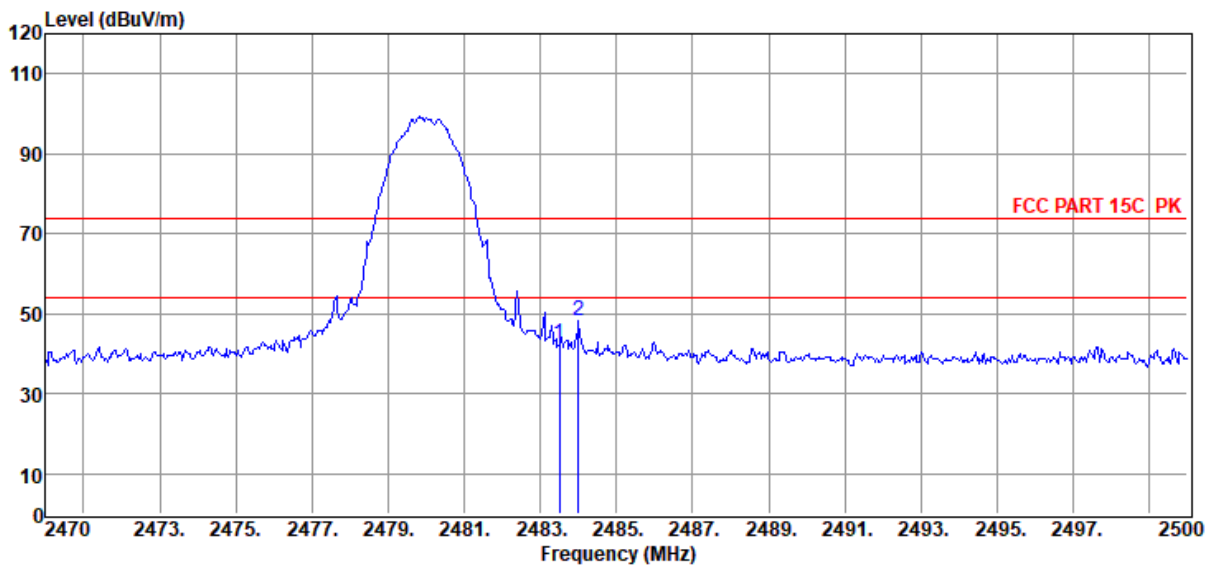

Item (Mark)	Freq. (MHz)	Read Level (dBμV)	Antenna Factor (dB/m)	PRM Factor (dB)	Cable Loss (dB)	Result Level (dBμV/m)	Limit Line (dBμV/m)	Over Limit (dB)	Detector	Polarization
1	2483.50	51.66	29.66	43.25	4.43	42.50	74.00	-31.50	Peak	HORIZONTAL
2	2484.01	57.35	29.67	43.25	4.43	48.20	74.00	-25.80	Peak	HORIZONTAL

Note: 1. Result Level = Read Level + Antenna Factor + Cable loss - PRM Factor.

2. If Peak Result complies with AV limit, AV Result is deemed to comply with AV limit.

3. Test setup: RBW: 1 MHz, VBW: 3 MHz, Sweep time: auto.

TR-4-E-009 Radiated Emission Test Result

Test Site : DDT 3m Chamber 1# D:\2019 RE1# Report Data\Q19102502-1E HK FLY TWS\FCC ABOVE1G.EM6
Test Date : 2019-12-26 **Tested By** : Talent
EUT : Bluetooth Headset **Model Number** : HK FLY TWS
Power Supply : Battery **Test Mode** : Tx mode
Condition : Temp:24.5°C,Humi:55%,Press:100.1kPa **Antenna/Distance** : 2019 HF 907/3m/HORIZONTAL
Memo : 3DH5 2402

Data: 43

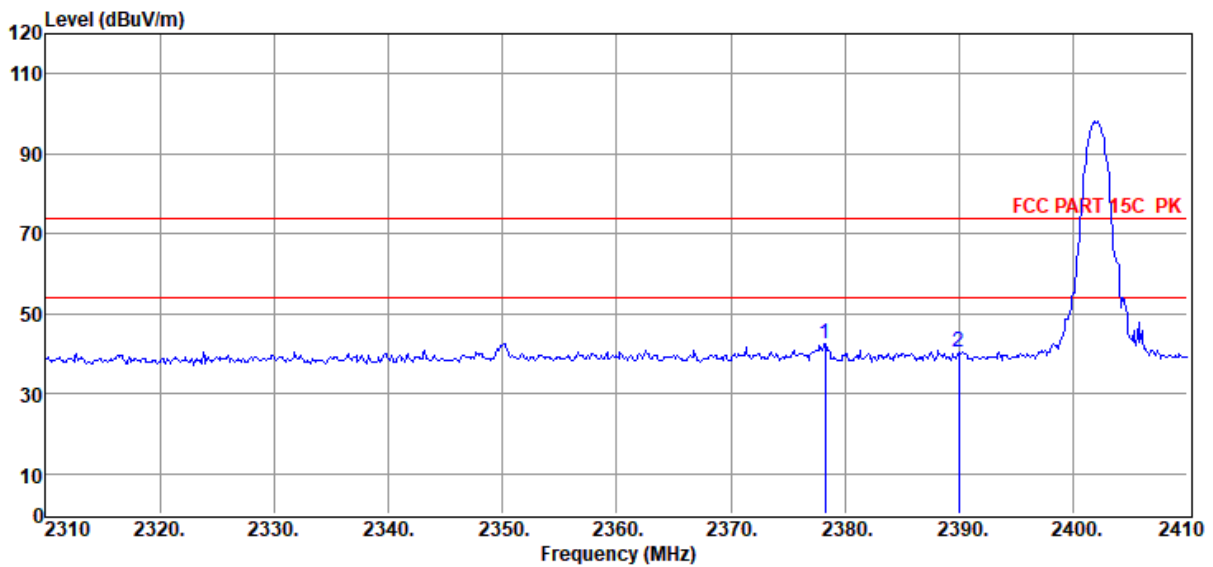

Item (Mark)	Freq. (MHz)	Read Level (dBμV)	Antenna Factor (dB/m)	PRM Factor (dB)	Cable Loss (dB)	Result Level (dBμV/m)	Limit Line (dBμV/m)	Over Limit (dB)	Detector	Polarization
1	2378.30	51.73	29.43	43.20	4.33	42.29	74.00	-31.71	Peak	HORIZONTAL
2	2390.00	49.62	29.46	43.21	4.34	40.21	74.00	-33.79	Peak	HORIZONTAL

- Note: 1. Result Level = Read Level + Antenna Factor + Cable loss - PRM Factor.
 2. If Peak Result complies with AV limit, AV Result is deemed to comply with AV limit.
 3. Test setup: RBW: 1 MHz, VBW: 3 MHz, Sweep time: auto.

TR-4-E-009 Radiated Emission Test Result

Test Site : DDT 3m Chamber 1# D:\2019 RE1# Report Data\Q19102502-1E HK FLY TWS\FCC ABOVE1G.EM6
Test Date : 2019-12-26 **Tested By** : Talent
EUT : Bluetooth Headset **Model Number** : HK FLY TWS
Power Supply : Battery **Test Mode** : Tx mode
Condition : Temp:24.5°C,Humi:55%,Press:100.1kPa **Antenna/Distance** : 2019 HF 907/3m/VERTICAL
Memo : 3DH5 2402

Data: 44

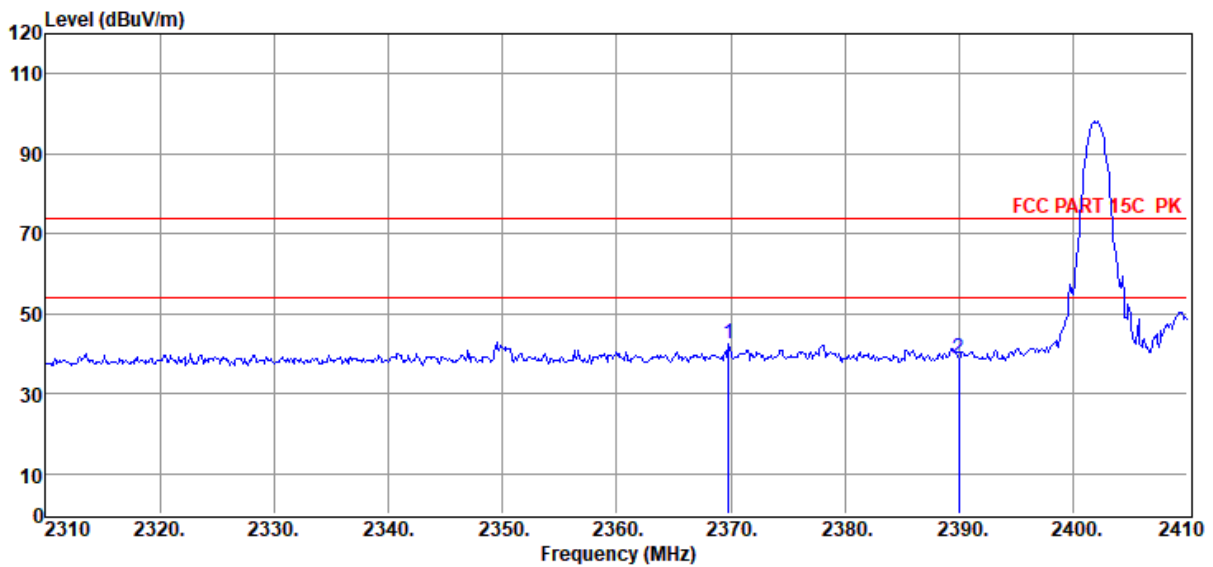

Item (Mark)	Freq. (MHz)	Read Level (dBμV)	Antenna Factor (dB/m)	PRM Factor (dB)	Cable Loss (dB)	Result Level (dBμV/m)	Limit Line (dBμV/m)	Over Limit (dB)	Detector	Polarization
1	2369.80	51.80	29.41	43.20	4.32	42.33	74.00	-31.67	Peak	VERTICAL
2	2390.00	48.01	29.46	43.21	4.34	38.60	74.00	-35.40	Peak	VERTICAL

- Note: 1. Result Level = Read Level + Antenna Factor + Cable loss - PRM Factor.
 2. If Peak Result complies with AV limit, AV Result is deemed to comply with AV limit.
 3. Test setup: RBW: 1 MHz, VBW: 3 MHz, Sweep time: auto.

TR-4-E-009 Radiated Emission Test Result

Test Site : DDT 3m Chamber 1#

D:\2019 RE1# Report Data\Q19102502-1E HK FLY TWS\FCC ABOVE1G.EM6

Test Date : 2019-12-26

Tested By : Talent

EUT : Bluetooth Headset

Model Number : HK FLY TWS

Power Supply : Battery

Test Mode : Tx mode

Condition : Temp:24.5°C,Humi:55%,Press:100.1kPa

Antenna/Distance : 2019 HF 907/3m/VERTICAL

Memo : 3DH5 2480

Data: 45

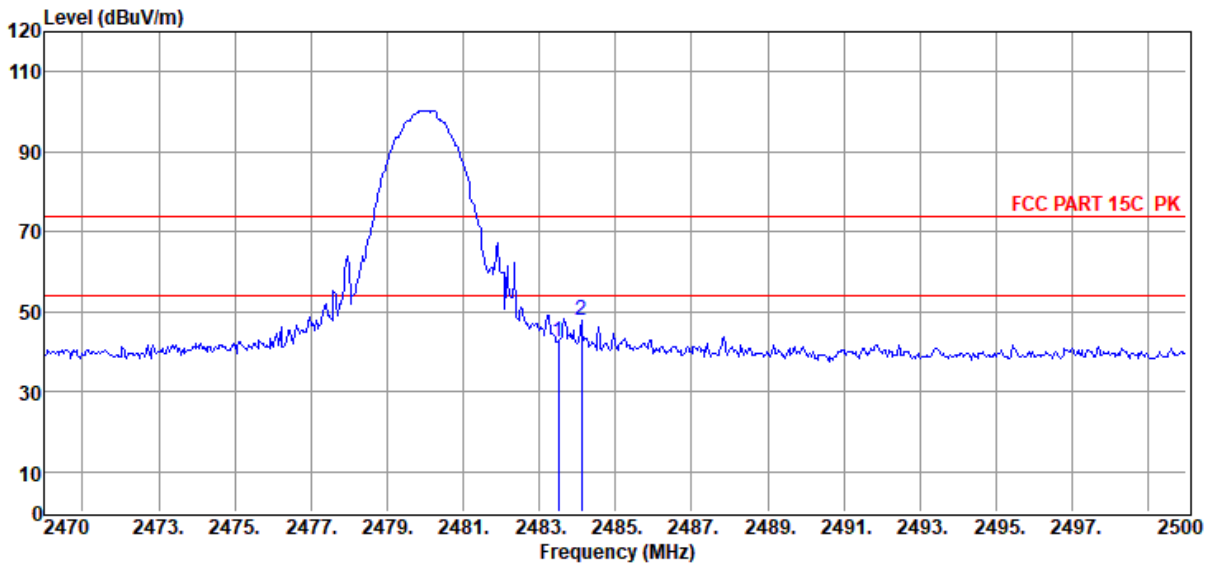

Item (Mark)	Freq. (MHz)	Read Level (dBμV)	Antenna Factor (dB/m)	PRM Factor (dB)	Cable Loss (dB)	Result Level (dBμV/m)	Limit Line (dBμV/m)	Over Limit (dB)	Detector	Polarization
1	2483.50	51.75	29.66	43.25	4.43	42.59	74.00	-31.41	Peak	VERTICAL
2	2484.10	57.02	29.67	43.25	4.43	47.87	74.00	-26.13	Peak	VERTICAL

- Note: 1. Result Level = Read Level + Antenna Factor + Cable loss - PRM Factor.
 2. If Peak Result complies with AV limit, AV Result is deemed to comply with AV limit.
 3. Test setup: RBW: 1 MHz, VBW: 3 MHz, Sweep time: auto.

TR-4-E-009 Radiated Emission Test Result

Test Site : DDT 3m Chamber 1# D:\2019 RE1# Report Data\Q19102502-1E HK FLY TWS\FCC ABOVE1G.EM6
Test Date : 2019-12-26 **Tested By** : Talent
EUT : Bluetooth Headset **Model Number** : HK FLY TWS
Power Supply : Battery **Test Mode** : Tx mode
Condition : Temp:24.5°C,Humi:55%,Press:100.1kPa **Antenna/Distance** : 2019 HF 907/3m/HORIZONTAL
Memo : 3DH5 2480

Data: 46

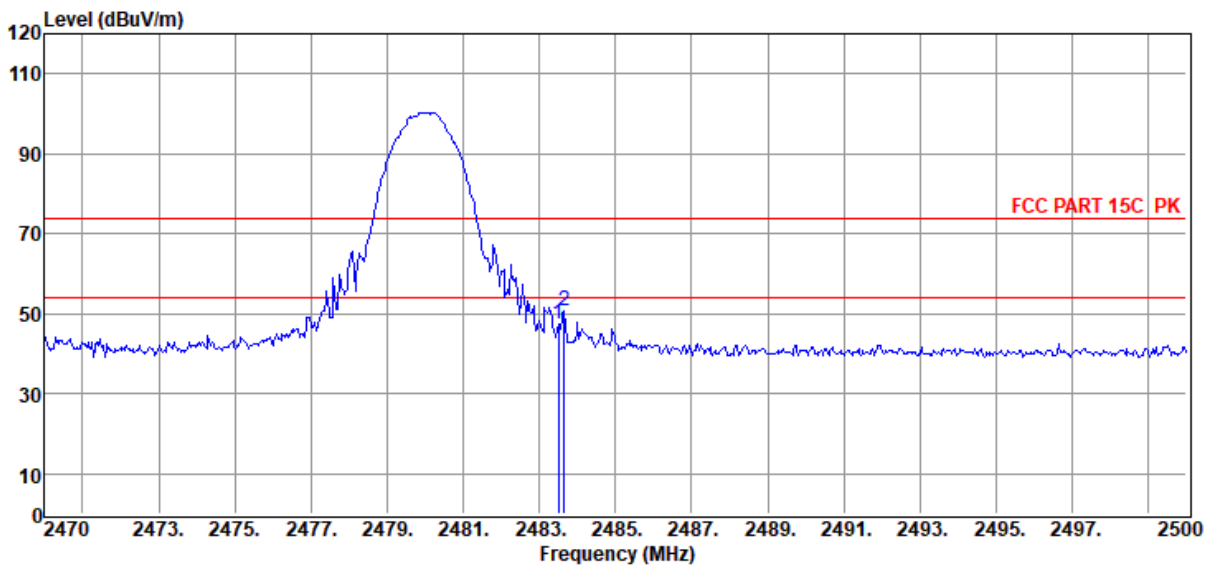

Item (Mark)	Freq. (MHz)	Read Level (dBμV)	Antenna Factor (dB/m)	PRM Factor (dB)	Cable Loss (dB)	Result Level (dBμV/m)	Limit Line (dBμV/m)	Over Limit (dB)	Detector	Polarization
1	2483.50	56.53	29.66	43.25	4.43	47.37	74.00	-26.63	Peak	HORIZONTAL
2	2483.65	59.71	29.66	43.25	4.43	50.55	74.00	-23.45	Peak	HORIZONTAL

Note: 1. Result Level = Read Level + Antenna Factor + Cable loss - PRM Factor.
 2. If Peak Result complies with AV limit, AV Result is deemed to comply with AV limit.
 3. Test setup: RBW: 1 MHz, VBW: 3 MHz, Sweep time: auto.

13. Power Line Conducted Emission

13.1. Block diagram of test setup

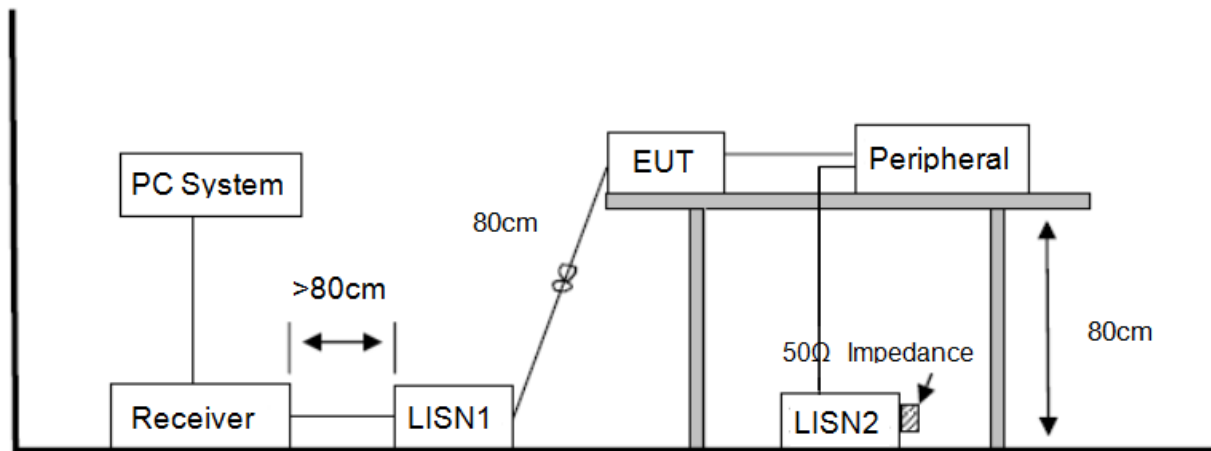

13.2. Power Line Conducted Emission Limits

Frequency	Quasi-Peak Level dB(μ V)	Average Level dB(μ V)
150 kHz ~ 500 kHz	66 ~ 56*	56 ~ 46*
500 kHz ~ 5 MHz	56	46
5 MHz ~ 30 MHz	60	50

Note 1: * Decreasing linearly with logarithm of frequency.

Note 2: The lower limit shall apply at the transition frequencies.

13.3. Test Procedure

The EUT and Support equipment, if needed, were put placed on a non-metallic table, 80cm above the ground plane.

Configuration EUT to simulate typical usage as described in clause 2.4 and test equipment as described in clause 10.2 of this report.

All I/O cables were positioned to simulate typical actual usage as per ANSI C63.10.

All support equipment power received from a second LISN.

Emissions were measured on each current carrying line of the EUT using an EMI Test Receiver connected to the LISN powering the EUT.

The Receiver scanned from 150 kHz to 30MHz for emissions in each of the test modes.

During the above scans, the emissions were maximized by cable manipulation.

The test mode(s) described in clause 2.4 were scanned during the preliminary test.

After the preliminary scan, we found the test mode producing the highest emission level.

The EUT configuration and worse cable configuration of the above highest emission levels were recorded for reference of the final test.

EUT and support equipment were set up on the test bench as per the configuration with highest emission level in the preliminary test.

A scan was taken on both power lines, Neutral and Line, recording at least the six highest emissions.

Emission frequency and amplitude were recorded into a computer in which correction factors were used to calculate the emission level and compare reading to the applicable limit.

The test data of the worst-case condition(s) was recorded.

The bandwidth of test receiver is set at 9 kHz.

13.4. Test Result

PASS. (See below detailed test result)

Note1: All emissions not reported below are too low against the prescribed limits.

Note2: "----" means Peak detection; "-----" means Average detection.

Note3: Pre-test AC conducted emission at both voltage AC 120V/60Hz and AC 240V/60Hz, recorded worse case.

TR-4-E-010 Conducted Emission Test Result

Test Site : DDT 1# Shield Room D:\2019 CE report data\Q19102502-1E\20191029.EM6
Test Date : 2019-10-29 **Tested By** : Lori
EUT : Bluetooth Headset **Model Number** : HK FLY TWS
Power Supply : AC 120V/60Hz **Test Mode** : Tx mode
Condition : Temp:24.5°C,Humi:55%,Press:101.4KPa **LISN** : 2018 ENV216/LINE

Memo :

Data: 14

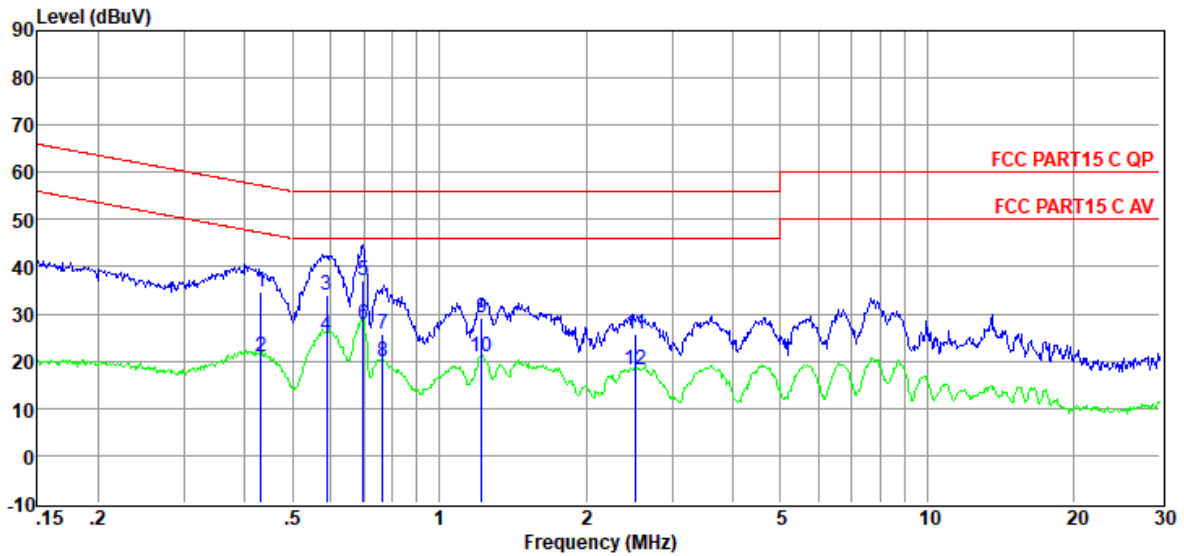

Item (Mark)	Freq. (MHz)	Read Level (dBµV)	LISN Factor (dB)	Cable Loss (dB)	Pulse Limiter Factor (dB)	Result Level (dBµV)	Limit Line (dBµV)	Over Limit (dB)	Detector	Phase
1	0.43	15.01	9.64	0.02	9.86	34.53	57.24	-22.71	QP	LINE
2	0.43	1.28	9.64	0.02	9.86	20.80	47.24	-26.44	Average	LINE
3	0.59	14.57	9.64	0.03	9.86	34.10	56.00	-21.90	QP	LINE
4	0.59	5.70	9.64	0.03	9.86	25.23	46.00	-20.77	Average	LINE
5	0.70	17.45	9.64	0.04	9.86	36.99	56.00	-19.01	QP	LINE
6	0.70	8.41	9.64	0.04	9.86	27.95	46.00	-18.05	Average	LINE
7	0.77	6.31	9.64	0.04	9.86	25.85	56.00	-30.15	QP	LINE
8	0.77	0.39	9.64	0.04	9.86	19.93	46.00	-26.07	Average	LINE
9	1.22	9.45	9.64	0.09	9.87	29.05	56.00	-26.95	QP	LINE
10	1.22	1.22	9.64	0.09	9.87	20.82	46.00	-25.18	Average	LINE
11	2.53	6.27	9.66	0.04	9.87	25.84	56.00	-30.16	QP	LINE
12	2.53	-1.24	9.66	0.04	9.87	18.33	46.00	-27.67	Average	LINE

- Note: 1. Result Level = Read Level + LISN Factor + Pulse Limiter Factor + Cable loss.
 2. If QP Result complies with AV limit, AV Result is deemed to comply with AV limit.
 3. Test setup: RBW: 200 Hz (9 kHz—150 kHz), 9 kHz (150 kHz—30 MHz).
 4. Step size: 80Hz (0.009MHz-0.15MHz), 4 kHz (0.15MHz-30MHz), Scan time: auto.

TR-4-E-010 Conducted Emission Test Result

Test Site : DDT 1# Shield Room D:\2019 CE report data\Q19102502-1E\20191029.EM6
Test Date : 2019-10-29 **Tested By** : Lori
EUT : Bluetooth Headset **Model Number** : HK FLY TWS
Power Supply : AC 120V/60Hz **Test Mode** : Tx mode
Condition : Temp:24.5°C,Humi:55%,Press:101.4KPa **LISN** : 2018 ENV216/NEUTRAL

Memo :

Data: 16

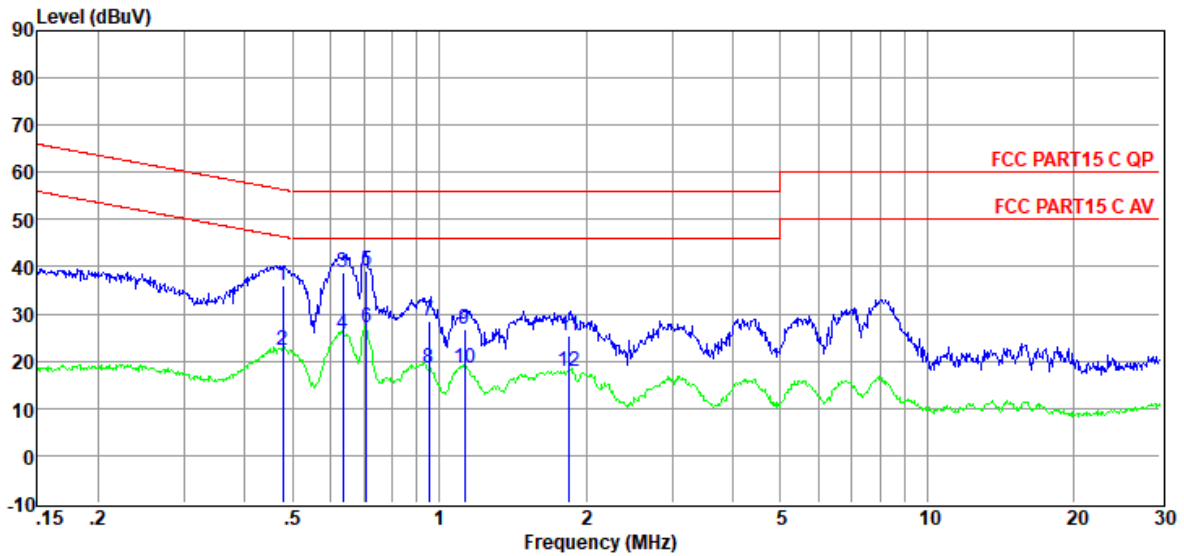

Item (Mark)	Freq. (MHz)	Read Level (dBμV)	LISN Factor (dB)	Cable Loss (dB)	Pulse Limiter Factor (dB)	Result Level (dBμV)	Limit Line (dBμV)	Over Limit (dB)	Detector	Phase
1	0.48	16.43	9.64	0.02	9.86	35.95	56.36	-20.41	QP	NEUTRAL
2	0.48	2.69	9.64	0.02	9.86	22.21	46.36	-24.15	Average	NEUTRAL
3	0.63	19.16	9.64	0.03	9.86	38.69	56.00	-17.31	QP	NEUTRAL
4	0.63	6.22	9.64	0.03	9.86	25.75	46.00	-20.25	Average	NEUTRAL
5	0.71	19.70	9.64	0.04	9.86	39.24	56.00	-16.76	QP	NEUTRAL
6	0.71	7.61	9.64	0.04	9.86	27.15	46.00	-18.85	Average	NEUTRAL
7	0.95	8.94	9.64	0.09	9.87	28.54	56.00	-27.46	QP	NEUTRAL
8	0.95	-1.15	9.64	0.09	9.87	18.45	46.00	-27.55	Average	NEUTRAL
9	1.13	7.18	9.65	0.09	9.87	26.79	56.00	-29.21	QP	NEUTRAL
10	1.13	-0.93	9.65	0.09	9.87	18.68	46.00	-27.32	Average	NEUTRAL
11	1.85	5.96	9.67	0.06	9.87	25.56	56.00	-30.44	QP	NEUTRAL
12	1.85	-1.83	9.67	0.06	9.87	17.77	46.00	-28.23	Average	NEUTRAL

- Note: 1. Result Level = Read Level + LISN Factor + Pulse Limiter Factor + Cable loss.
 2. If QP Result complies with AV limit, AV Result is deemed to comply with AV limit.
 3. Test setup: RBW: 200 Hz (9 kHz—150 kHz), 9 kHz (150 kHz—30 MHz).
 4. Step size: 80Hz (0.009MHz-0.15MHz), 4 kHz (0.15MHz-30MHz), Scan time: auto.

14. Antenna Requirements

14.1. Limit

For intentional device, according to FCC 47 CFR Section 15.203, an intentional radiator shall be designed to ensure that no antenna other than that furnished by the responsible party shall be used with the device. And according to FCC 47 CFR Section 15.247 (b), if transmitting antennas of directional gain greater than 6dBi are used, the power shall be reduced by the amount in dB that the directional gain of the antenna exceeds 6dBi.

14.2. Result

The antennas used for this product are LDS antenna and that no antenna other than that furnished by the responsible party shall be used with the device, the maximum peak gain of the left side transmit antenna is -2.80 dBi and right side is 1.70 dBi.

END OF REPORT