

11AC80MIMO	Ant2	5795	NV	-10	40000.00	6.902502	20	PASS
			NV	0	40000.00	6.902502	20	PASS
			NV	10	40000.00	6.902502	20	PASS
			NV	20	40000.00	6.902502	20	PASS
			NV	30	40000.00	6.902502	20	PASS
			NV	40	40000.00	6.902502	20	PASS
			NV	50	40000.00	6.902502	20	PASS
	Ant2	5795	NV	-30	40000.00	6.902502	20	PASS
			NV	-20	40000.00	6.902502	20	PASS
			NV	-10	40000.00	6.902502	20	PASS
			NV	0	40000.00	6.902502	20	PASS
			NV	10	40000.00	6.902502	20	PASS
			NV	20	40000.00	6.902502	20	PASS
			NV	30	40000.00	6.902502	20	PASS
	Ant1	5210	NV	40	80000.00	13.805004	20	PASS
			NV	50	40000.00	6.902502	20	PASS
			NV	-30	80000.00	15.355086	20	PASS
			NV	-20	80000.00	15.355086	20	PASS
			NV	-10	0.00	0.000000	20	PASS
			NV	0	0.00	0.000000	20	PASS
			NV	10	80000.00	15.355086	20	PASS
	Ant2	5210	NV	20	0.00	0.000000	20	PASS
			NV	30	0.00	0.000000	20	PASS
			NV	40	0.00	0.000000	20	PASS
			NV	50	0.00	0.000000	20	PASS
			NV	-30	80000.00	15.355086	20	PASS
			NV	-20	0.00	0.000000	20	PASS
			NV	-10	0.00	0.000000	20	PASS
Ant1	5290	NV	0	80000.00	15.355086	20	PASS	
		NV	10	0.00	0.000000	20	PASS	
		NV	20	0.00	0.000000	20	PASS	
		NV	30	0.00	0.000000	20	PASS	
		NV	40	0.00	0.000000	20	PASS	
		NV	50	0.00	0.000000	20	PASS	
		NV	-30	0.00	0.000000	20	PASS	
Ant2	5290	NV	-20	0.00	0.000000	20	PASS	
		NV	-10	0.00	0.000000	20	PASS	
		NV	0	0.00	0.000000	20	PASS	
		NV	10	80000.00	15.122873	20	PASS	
		NV	20	0.00	0.000000	20	PASS	
		NV	30	80000.00	15.122873	20	PASS	
		NV	40	80000.00	15.122873	20	PASS	
Ant1	5530	NV	50	80000.00	15.122873	20	PASS	
		NV	-30	80000.00	15.122873	20	PASS	
		NV	-20	0.00	0.000000	20	PASS	
		NV	-10	0.00	0.000000	20	PASS	
		NV	0	0.00	0.000000	20	PASS	
		NV	10	0.00	0.000000	20	PASS	
		NV	20	80000.00	14.466546	20	PASS	
Ant2	5530	NV	30	0.00	0.000000	20	PASS	
		NV	40	0.00	0.000000	20	PASS	
		NV	50	0.00	0.000000	20	PASS	
Ant2	5530	NV	-30	0.00	0.000000	20	PASS	
		NV	-20	0.00	0.000000	20	PASS	
		NV	-10	0.00	0.000000	20	PASS	

Ant1	5610	NV	0	0.00	0.000000	20	PASS	
		NV	10	80000.00	14.466546	20	PASS	
		NV	20	80000.00	14.466546	20	PASS	
		NV	30	0.00	0.000000	20	PASS	
		NV	40	80000.00	14.466546	20	PASS	
		NV	50	0.00	0.000000	20	PASS	
	Ant2	5610	NV	-30	80000.00	14.260250	20	PASS
			NV	-20	80000.00	14.260250	20	PASS
			NV	-10	80000.00	14.260250	20	PASS
			NV	0	0.00	0.000000	20	PASS
			NV	10	80000.00	14.260250	20	PASS
			NV	20	0.00	0.000000	20	PASS
	Ant1	5690	NV	30	80000.00	14.260250	20	PASS
			NV	40	0.00	0.000000	20	PASS
			NV	50	80000.00	14.260250	20	PASS
			NV	-30	80000.00	14.059754	20	PASS
			NV	-20	80000.00	14.059754	20	PASS
			NV	-10	80000.00	14.059754	20	PASS
Ant2	5690	NV	0	0.00	0.000000	20	PASS	
		NV	10	80000.00	14.059754	20	PASS	
		NV	20	0.00	0.000000	20	PASS	
		NV	30	80000.00	14.059754	20	PASS	
		NV	40	80000.00	14.059754	20	PASS	
		NV	50	80000.00	14.059754	20	PASS	
Ant1	5775	NV	-30	80000.00	14.059754	20	PASS	
		NV	-20	80000.00	14.059754	20	PASS	
		NV	-10	80000.00	14.059754	20	PASS	
		NV	0	80000.00	13.852814	20	PASS	
		NV	10	80000.00	13.852814	20	PASS	
		NV	20	80000.00	13.852814	20	PASS	
Ant2	5775	NV	30	80000.00	13.852814	20	PASS	
		NV	40	80000.00	13.852814	20	PASS	
		NV	50	80000.00	13.852814	20	PASS	
		NV	-30	80000.00	13.852814	20	PASS	
		NV	-20	0.00	0.000000	20	PASS	
		NV	-10	80000.00	13.852814	20	PASS	
Ant1	5775	NV	0	0.00	0.000000	20	PASS	
		NV	10	80000.00	13.852814	20	PASS	
		NV	20	80000.00	13.852814	20	PASS	
		NV	30	80000.00	13.852814	20	PASS	
		NV	40	80000.00	13.852814	20	PASS	
		NV	50	80000.00	13.852814	20	PASS	

11. Dynamic Frequency Selection

11.1. Applicability of DFS requirements

Table 1: Applicability of DFS Requirements Prior to Use of a Channel

Requirement	Operational Mode		
	<input type="checkbox"/> Master	<input checked="" type="checkbox"/> Client Without Radar Detection	<input type="checkbox"/> Client with Radar Detection
Non-Occupancy Period	Yes	Not required	Yes
DFS Detection Threshold	Yes	Not required	Yes
Channel Availability Check Time	Yes	Not required	Not required
U-NII Detection Bandwidth	Yes	Not required	Yes

Table 2: Applicability of DFS requirements during normal operation

Requirement	Operational Mode	
	<input type="checkbox"/> Master Device or Client with Radar Detection	<input checked="" type="checkbox"/> Client Without Radar Detection
DFS Detection Threshold	Yes	Not required
Channel Closing Transmission Time	Yes	Yes
Channel Move Time	Yes	Yes
U-NII Detection Bandwidth	Yes	Not required

Additional requirements for devices with multiple bandwidth modes	<input type="checkbox"/> Master Device or Client with Radar Detection	<input checked="" type="checkbox"/> Client Without Radar Detection
U-NII Detection Bandwidth and Statistical Performance Check	All BW modes must be tested	Not required
Channel Move Time and Channel Closing Transmission Time	Test using widest BW mode available	Test using the widest BW mode available for the link
All other tests	Any single BW mode	Not required

Note: Frequencies selected for statistical performance check should include several frequencies within the radar detection bandwidth and frequencies near the edge of the radar detection bandwidth. For 802.11 devices it is suggested to select frequencies in each of the bonded 20 MHz channels and the channel center frequency.

11.2. Limit

(1) DFS Detection Thresholds

Table 3: DFS Detection Thresholds for Master Devices and Client Devices with Radar Detection

Maximum Transmit Power	Value (See Notes 1, 2, and 3)
EIRP \geq 200 milliwatt	-64 dBm
EIRP $<$ 200 milliwatt and power spectral density $<$ 10 dBm/MHz	-62 dBm
EIRP $<$ 200 milliwatt that do not meet the power spectral density requirement	-64 dBm

Note 1: This is the level at the input of the receiver assuming a 0 dBi receive antenna.
 Note 2: Throughout these test procedures an additional 1 dB has been added to the amplitude of the test transmission waveforms to account for variations in measurement equipment. This will ensure that the test signal is at or above the detection threshold level to trigger a DFS response.
 Note3: EIRP is based on the highest antenna gain. For MIMO devices refer to KDB Publication 662911 D01.

(2) DFS Response Requirements

Table 4: DFS Response Requirement Values

Parameter	Value
Non-occupancy period	Minimum 30 minutes
Channel Availability Check Time	60 seconds
Channel Move Time	10 seconds See Note 1.
Channel Closing Transmission Time	200 milliseconds + an aggregate of 60 milliseconds over remaining 10 second period. See Notes 1 and 2.
U-NII Detection Bandwidth	Minimum 100% of the U-NII 99% transmission power bandwidth. See Note 3.

Note 1: Channel Move Time and the Channel Closing Transmission Time should be performed with Radar Type 0. The measurement timing begins at the end of the Radar Type 0 burst.
 Note 2: The Channel Closing Transmission Time is comprised of 200 milliseconds starting at the beginning of the Channel Move Time plus any additional intermittent control signals required facilitating a Channel move (an aggregate of 60 milliseconds) during the remainder of the 10 second period. The aggregate duration of control signals will not count quiet periods in between transmissions.
 Note 3: During the U-NII Detection Bandwidth detection test, radar type 0 should be used. For each frequency step the minimum percentage of detection is 90 percent. Measurements are performed with no data traffic.

11.3. Parameters of radar test waveforms

This section provides the parameters for required test waveforms, minimum percentage of successful detections, and the minimum number of trials that must be used for determining DFS conformance. Step intervals of 0.1 microsecond for Pulse Width, 1 microsecond for PRI, 1 MHz for chirp width and 1 for the number of pulses will be utilized for the random determination of specific test waveforms.

Table 5 Short Pulse Radar Test Waveforms

Radar Type	Pulse Width (μsec)	PRI (μsec)	Number of Pulses	Minimum Percentage of Successful Detection	Minimum Number of Trials
0	1	1428	18	See Note 1	See Note 1
1	1	Test A	Roundup $\left\{ \begin{array}{l} \left(\frac{1}{360} \right) \cdot \\ \left(\frac{19 \cdot 10^6}{PRI_{\mu\text{sec}}} \right) \end{array} \right\}$	60%	30
		Test B			
2	1-5	150-230	23-29	60%	30
3	6-10	200-500	16-18	60%	30
4	11-20	200-500	12-16	60%	30
Aggregate (Radar Types 1-4)				80%	120
Note 1: Short Pulse Radar Type 0 should be used for the detection bandwidth test, channel move time, and channel closing time tests.					
Test A: 15 unique PRI values randomly selected from the list of 23 PRI values in Table 5a					
Test B: 15 unique PRI values randomly selected within the range of 518-3066 μsec, with a minimum increment of 1 μsec, excluding PRI values selected in Test A					

A minimum of 30 unique waveforms are required for each of the Short Pulse Radar Types 2 through 4. If more than 30 waveforms are used for Short Pulse Radar Types 2 through 4, then each additional waveform must also be unique and not repeated from the previous waveforms. If more than 30 waveforms are used for Short Pulse Radar Type 1, then each additional waveform is generated with Test B and must also be unique and not repeated from the previous waveforms in Tests A or B. Test aggregate is average of the percentage of successful detections of short pulse radar types 1-4

11.4. Calibration of radar waveform

Radar Waveform Calibration Procedure:

- (1) A 50 ohm load is connected in place of the spectrum analyzer, and the spectrum analyzer is connected to place of the master
- (2) The interference Radar Detection Threshold Level is $-62\text{dBm} + 0\text{dBi} + 1\text{dB} = -61\text{dBm}$ that had been taken into account the output power range and antenna gain.
- (3) The following equipment setup was used to calibrate the conducted radar waveform. A vector signal generator was utilized to establish the test signal level for radar type 0. During this process there were no transmissions by either the master or client device. The spectrum analyzer was switched to the zero spans (time domain) at the frequency of the radar waveform generator. Peak detection was used. The spectrum analyzer resolution bandwidth (RBW) and

video bandwidth (VBW) were set to 3 MHz. The spectrum analyzer had offset -1.0dB to compensate RF cable loss 1.0dB.

- (4) The vector signal generator amplitude was set so that the power level measured at the spectrum analyzer was $-62\text{dBm} + 0\text{dBi} + 1\text{dB} = -61\text{dBm}$. Capture the spectrum analyzer plots on short pulse radar waveform.

Conducted Calibration Setup:

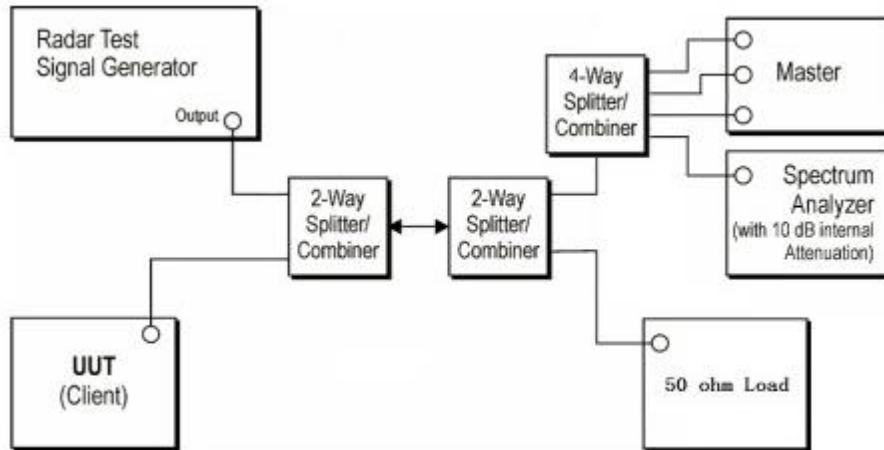

Note: 1. Use the software "Web" to set the frequency channel.

2. EUT is not support TPC and not with Radar detection.

Radar Waveform Calibration Result:

Test Mode	Frequency[dbm]	Radar Type	Result	Limit[dbm]	Verdict
11AC80SISO	5290	Type0	-57.28	-57.20	PASS
	5530	Type0	-57.39	-57.20	PASS

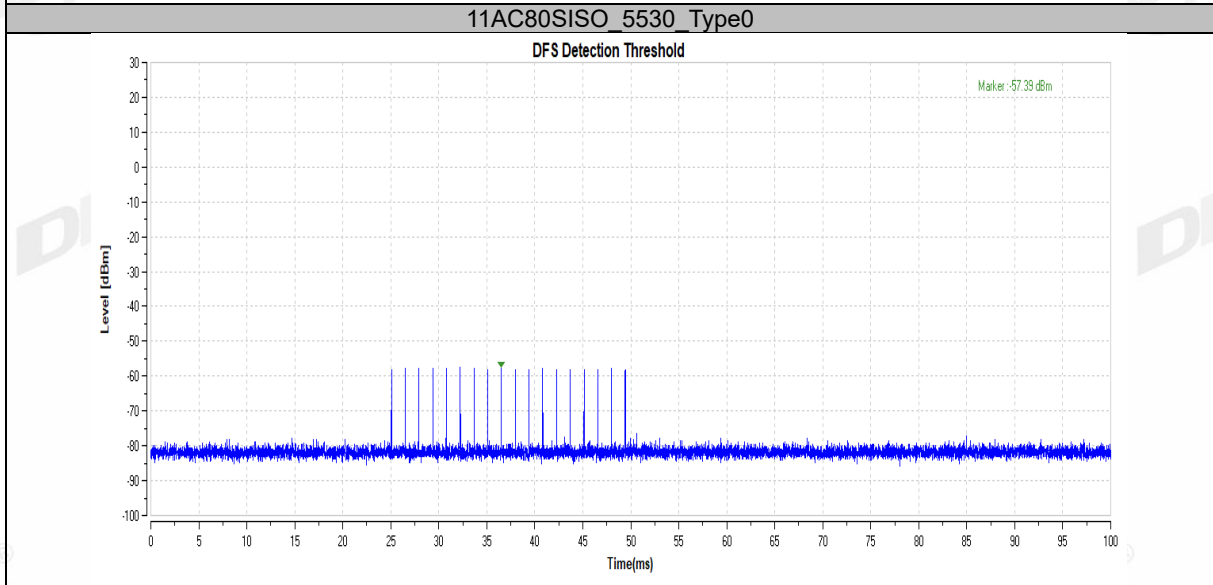
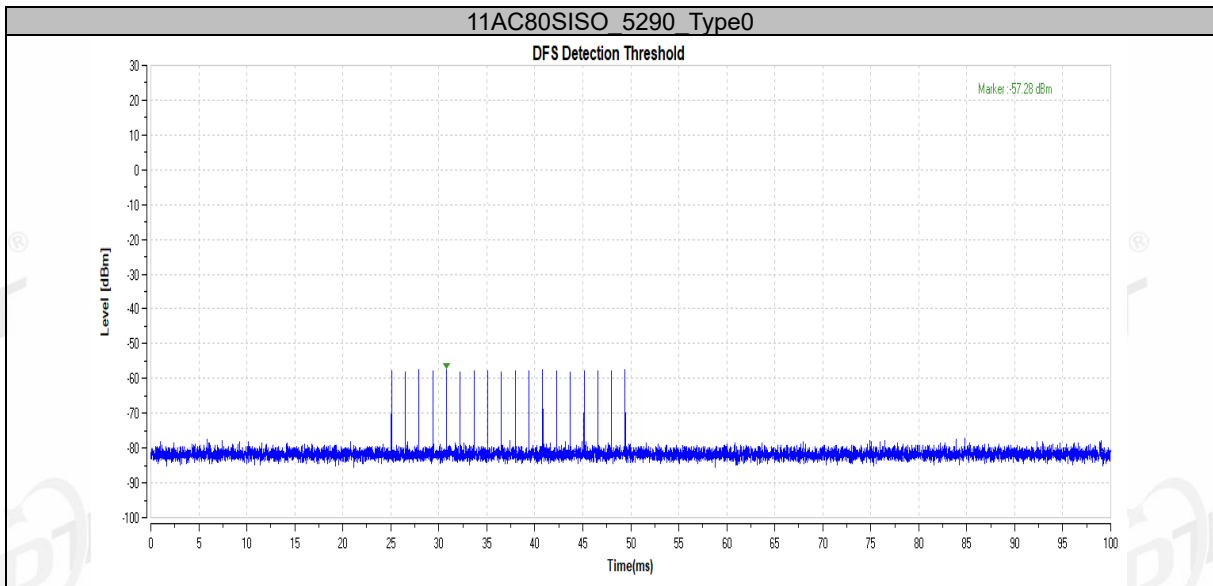

11.5. Channel closing transmission time, channel move time and non-occupancy period

Block diagram of test setup Test Procedure:

- (1) The radar pulse generator is setup to provide a pulse at frequency that the master and client are operating. A type 0 radar pulse with a 1us pulse width and a 1428us PRI is used for the testing.
- (2) The vector signal generator is adjusted to provide the radar burst (18 pulses) at the level of approximately -61dBm at the antenna port of the master device.
- (3) A trigger is provided from the pulse generator to the DFS monitoring system in order to capture the traffic and the occurrence of the radar pulse.
- (4) EUT will associate with the master at channel. The file "iperf.exe" specified by the FCC is streamed from the PC 2 through the master and the client device to the PC 1 and played in full motion video using Test Software in order to properly load the network for the entire period of the test.
- (5) When radar burst with a level equal to the DFS Detection Threshold +1dB is generated on the operating channel of the U-NII device. At time T0 the radar waveform generator sends a burst of pulse of the radar waveform at Detection Threshold +1dB.
- (6) Observe the transmissions of the EUT at the end of the radar Burst on the Operating Channel. Measure and record the transmissions from the UUT during the observation time (Channel Move Time). One 15 seconds plot is reported for the Short Pulse Radar Type 0. The plot for the Short Pulse Radar Types start at the end of the radar burst. The Channel Move Time will be calculated based on the zoom in 600ms plot of the Short Pulse Radar Type.
- (7) Measurement of the aggregate duration of the Channel Closed Transmission Time method. With the
- (8) spectrum analyzer set to zero span tuned to the center frequency of the EUT operating channel at the radar simulated frequency, peak detection, and max hold, the dwell time per bin is given by: $Dwell (0.3ms) = S (12000ms) / B (4000)$; where Dwell is the dwell time per spectrum analyzer sampling bin, S is sweep time and B is the number of spectrum analyzer sampling bins. An upper bound of the aggregate duration of the intermittent control signals of Channel Closing Transmission Time is calculated by: $C (ms) = N \times Dwell (0.3ms)$; where C is the Closing Time, N is the number of spectrum analyzer sampling bins (intermittent control signals) showing a U-NII transmission and Dwell is the dwell time per bin.

Measurement the EUT for more than 30 minutes following the channel move time to verify that no transmission or beacons occur on this channel.

11.6. Test setup

Setup for Client with injection at the Master

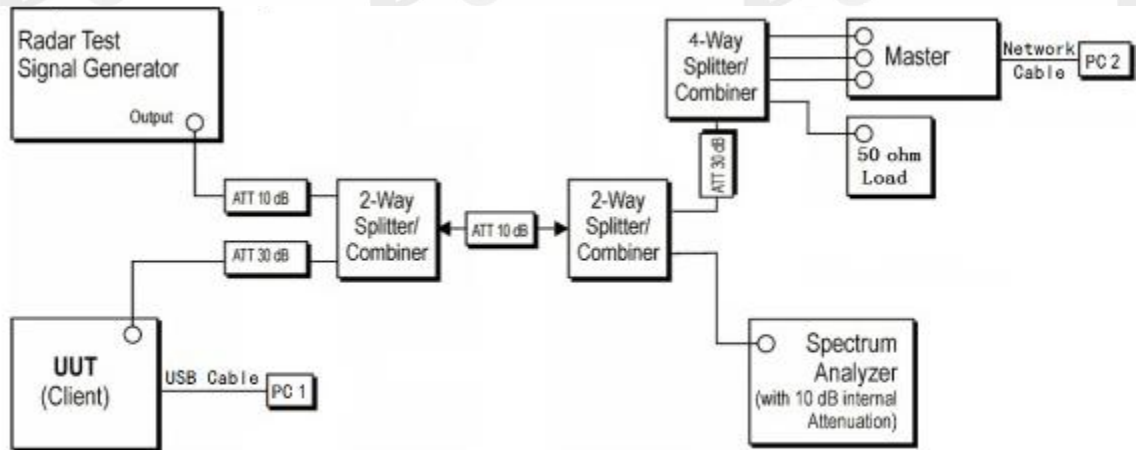

11.7. Test result

TestMode	Frequency[MHz]	CCTT[ms]	Limit[ms]	CMT[ms]	Limit[ms]	Verdict
11AC80SISO	5290	200+6.5	200+60	545.7	10000	PASS
11AC80SISO	5530	200+6.5	200+60	522.3	10000	PASS

Test plots as follows:

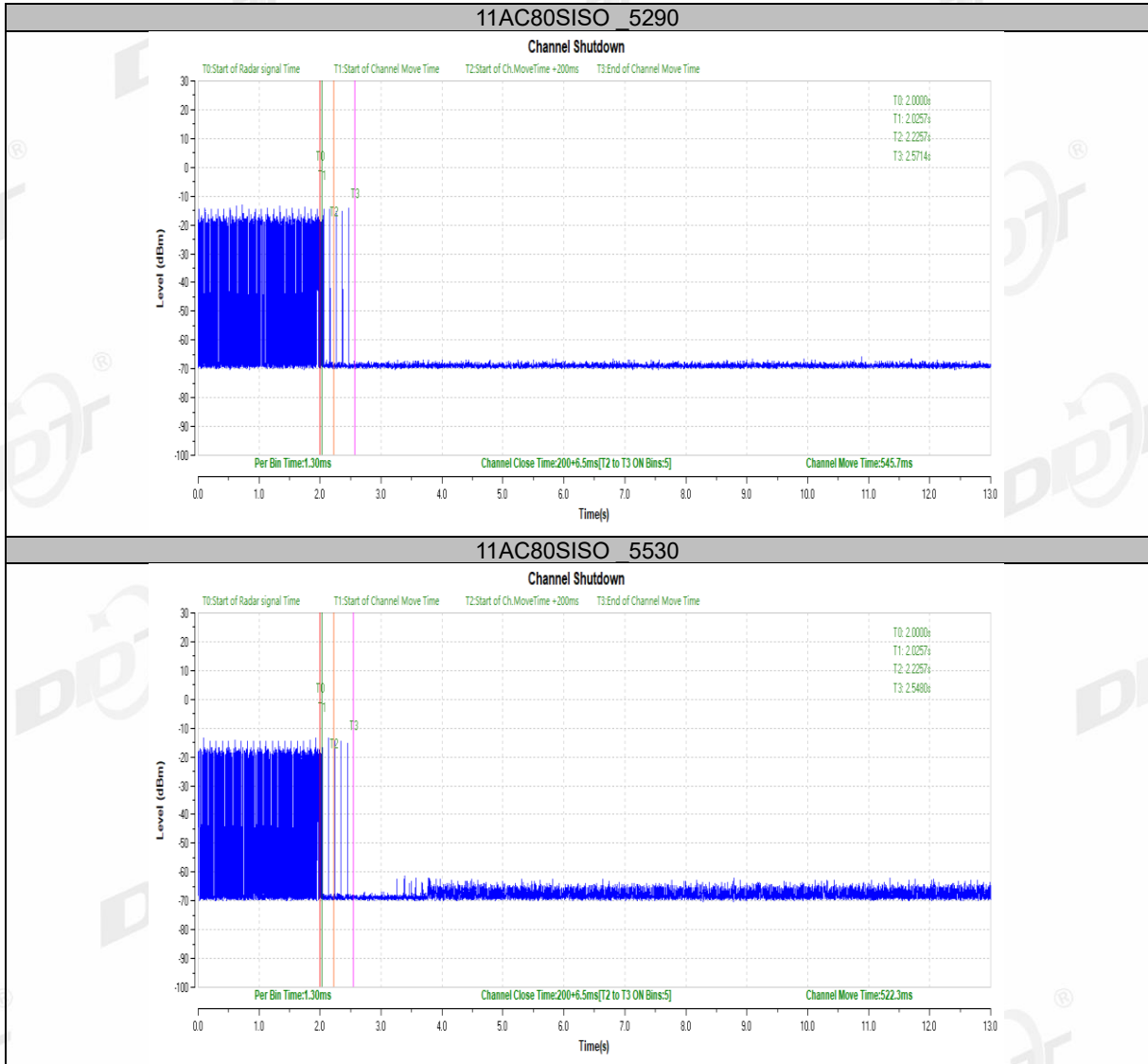

12. Emissions in Restricted Frequency Bands

12.1. Block diagram of test setup

In 3 m Anechoic Chamber, test setup diagram for 9 kHz - 30 MHz:

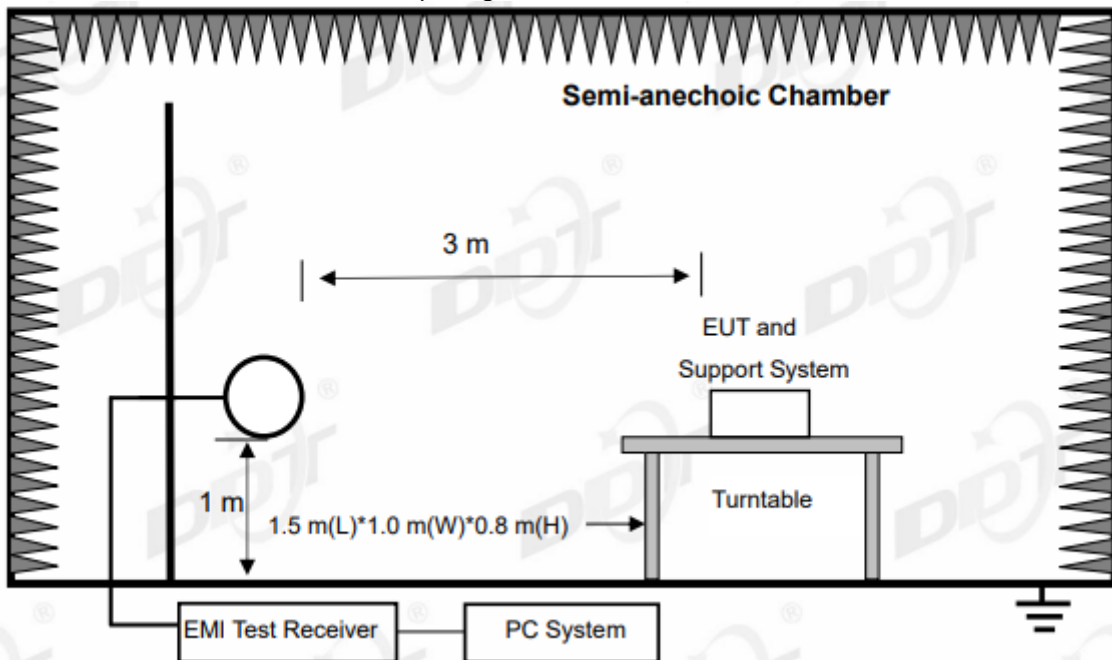

In 3 m Anechoic Chamber, test setup diagram for 30 MHz - 1 GHz:

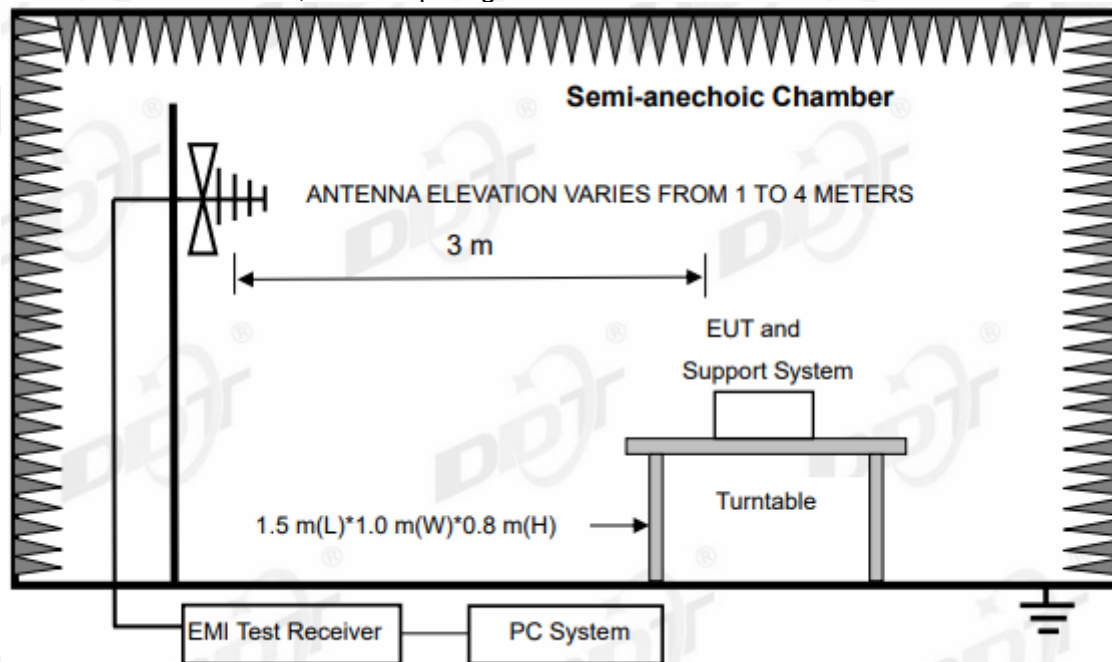

In 3 m Anechoic Chamber, test setup diagram for frequency above 1 GHz:

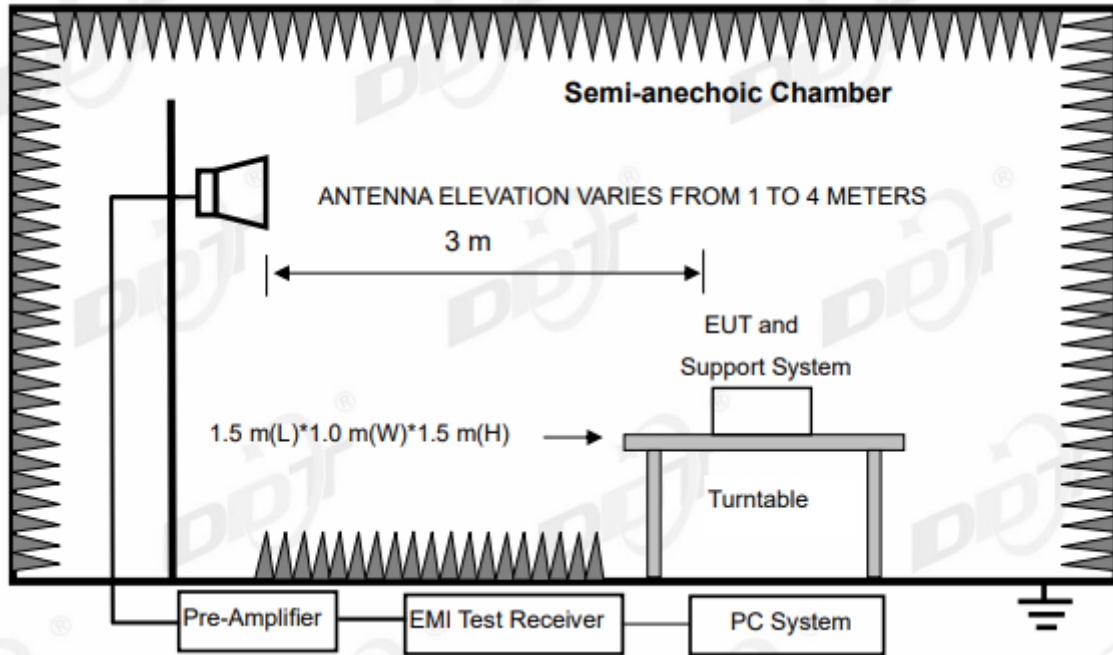

Note: For harmonic emissions test an appropriate high pass filter was inserted in the input port of AMP.

12.2. Limit

(1) FCC 15.205 Restricted frequency band

MHz	MHz	MHz	GHz
0.090-0.110	16.42-16.423	399.9-410	4.5-5.15
¹ 0.495-0.505	16.69475-16.69525	608-614	5.35-5.46
2.1735-2.1905	16.80425-16.80475	960-1240	7.25-7.75
4.125-4.128	25.5-25.67	1300-1427	8.025-8.5
4.1772&4.17775	37.5-38.25	1435-1626.5	9.0-9.2
4.2072&4.20775	73-74.6	1645.5-1646.5	9.3-9.5
6.215-6.218	74.8-75.2	1660-1710	10.6-12.7
6.26775-6.26825	108-121.94	1718.8-1722.2	13.25-13.4
6.31175-6.31225	123-138	2200-2300	14.47-14.5
8.291-8.294	149.9-150.05	2310-2390	15.35-16.2
8.362-8.366	156.52475-156.52525	2483.5-2500	17.7-21.4
8.37625-8.38675	156.7-156.9	2690-2900	22.01-23.12
8.41425-8.41475	162.0125-167.17	3260-3267	23.6-24.0
12.29-12.293	167.72-173.2	3332-3339	31.2-31.8
12.51975-12.52025	240-285	3345.8-3358	36.43-36.5
12.57675-12.57725	322-335.4	3600-4400	(²)
13.36-13.41			

¹Until February 1, 1999, this restricted band shall be 0.490-0.510 MHz

²Above 38.6

(2) FCC 15.209 Limit

FREQUENCY MHz	DISTANCE Meters	FIELD STRENGTHS LIMIT	
		$\mu\text{V}/\text{m}$	$\text{dB}(\mu\text{V})/\text{m}$
0.009 ~ 0.490	300	2400/F(kHz)	67.6-20log(F)
0.490 ~ 1.705	30	24000/F(kHz)	87.6-20log(F)
1.705 ~ 30.0	30	30	29.54
30 ~ 88	3	100	40.0
88 ~ 216	3	150	43.5
216 ~ 960	3	200	46.0
960 ~ 1000	3	500	54.0
Above 1000	3	74.0 $\text{dB}(\mu\text{V})/\text{m}$ (Peak) 54.0 $\text{dB}(\mu\text{V})/\text{m}$ (Average)	

Note: (1) The emission limits shown in the above table are based on measurements employing a CISPR QP detector except for the frequency bands 9 - 90 kHz, 110 - 490 kHz and above 1000 MHz, radiated emissions limits in these three bands are based on measurements employing an average detector.

(2) At frequencies below 30 MHz, measurement may be performed at a distance closer than that specified, and the limit at closer measurement distance can be extrapolated by below formula:

$$\text{Limit}_{3\text{m}}(\text{dB}\mu\text{V}/\text{m}) = \text{Limit}_{30\text{m}}(\text{dB}\mu\text{V}/\text{m}) + 40\text{Log}(30\text{m}/3\text{m})$$

(3) Limit for this EUT

The emissions appearing within 15.205 restricted frequency bands shall not exceed the limits shown in 15.209, all the other emissions shall be at least 20 dB below the fundamental emissions or comply with 15.209 limits.

12.3. Test Procedure

- (1) EUT was placed on a non-metallic table, 80 cm above the ground plane inside a semi-anechoic chamber for below 1G and 150 cm above the ground plane inside a fully-anechoic chamber for above 1G.
- (2) Test antenna was located 3 m from the EUT on an adjustable mast, and the antenna used as below table.

Test frequency range	Test antenna used	Test antenna distance
9 kHz - 30 MHz	Active Loop antenna	3 m
30 MHz - 1 GHz	Trilog Broadband Antenna	3 m
1 GHz - 18 GHz	Double Ridged Horn Antenna (1 GHz - 18 GHz)	3 m
18 GHz - 40 GHz	Horn Antenna (18 GHz - 40 GHz)	1 m

According ANSI C63.10:2013 clause 6.4.6 and 6.5.3, for measurements below 30 MHz, Antenna was located 3 m from EUT, the loop antenna was positioned in three antenna orientations (parallel, perpendicular, and round-parallel), for each measurement antenna alignment, the EUT shall be rotated through 0° to 360° on a turntable, and the lowest height of the magnetic

antenna shall be 1 m above the ground. For measurement above 30MHz, the trilog Broadband Antenna or Horn Antenna was located 3m from EUT, Measurements were made with the antenna positioned in both the horizontal and vertical planes of Polarization, and the measurement antenna was varied from 1 m to 4 m. in height above the reference ground plane to obtain the maximum signal strength.

(3) Below pre-scan procedure was first performed in order to find prominent frequency spectrum radiated emissions from 9 kHz to 25 GHz:

(a) Scanning the peak frequency spectrum with the antenna specified in step (3), and the EUT was rotated 360 degree, the antenna height was varied from 1 m to 4 m (Except loop antenna, it's fixed 1 m above ground.)

(b) Change work frequency or channel of device if practicable.

(c) Change modulation type of device if practicable.

(d) Change power supply range from 85% to 115% of the rated supply voltage

(e) Rotated EUT though three orthogonal axes to determine the attitude of EUT arrangement produces highest emissions.

Spectrum frequency from 9 kHz to 25 GHz (tenth harmonic of fundamental frequency) was investigated, and no any obvious emission were detected from 18 GHz to 25 GHz, so below final test was performed with frequency range from 9 kHz to 18 GHz.

(4) For final emissions measurements at each frequency of interest, the EUT was rotated and the antenna height was varied between 1 m and 4 m in order to maximize the emission.

Measurements in both horizontal and vertical polarities were made and the data was recorded. In order to find the maximum emission, the relative positions of equipment and all of the interface cables were changed according to ANSI C63.10:2013 on Radiated Emission test.

(5) The emissions from 9 kHz to 1 GHz were measured based on CISPR QP detector except for the frequency bands 9 - 90 kHz, 110 - 490 kHz, for emissions from 9 kHz - 90 kHz, 110 kHz - 490 kHz and above 1 GHz were measured based on average detector, for emissions above 1 GHz, peak emissions also be measured and need comply with Peak limit.

(6) The emissions from 9 kHz to 1 GHz, QP or average values were measured with EMI receiver with below RBW.

Frequency band	RBW
9 kHz - 150 kHz	200 Hz
150 kHz - 30 MHz	9 kHz
30 MHz - 1 GHz	120 kHz

(7) For emissions above 1GHz, both Peak and Average level were measured with Spectrum Analyzer, and the RBW is set at 1 MHz, VBW is set at 3 MHz for Peak measure; According ANSI C63.10:2013 clause 4.1.4.2.2 procedure for average measure.

(8) For portable device, X axis, Y axis, Z axis are tested, and worse setup is reported.

12.4. Test result

Pass. (See below detailed test result)

All the emissions except fundamental emission from 9 kHz to 25 GHz were comply with 15.209 limits.

Note1: According exploratory test no any obvious emission was detected from 9 kHz to 30 MHz and 18 GHz to 40 GHz, so the final test was performed with frequency range from 30 MHz to 18 GHz and recorded in below.

Note2: For emissions below 1 GHz, according exploratory explorer test, when change Tx mode and channel, have no distinct influence on emissions level, so for emissions below 1 GHz, the final test was only performed with EUT working in 802.11n HT20 mode.

Note3: For emissions above 1 GHz. If peak results comply with AV limit, AV Result is deemed to comply with AV limit.

Radiated Emission test (below 1GHz) TR-4-E-009 Radiated Emission Test Result

Test Date: 2023-09-08 **Tested By:** Bairong
EUT: Wireless Speaker **Model Number:** CITATION 500
Test Mode: TX Mode **Power Supply:** AC 120V/60Hz
Condition: Temp:21.1°C;Humi:68.5% **Test Site:** DDT 3# Chamber
File Path: d:\ts\2023 report data\Q23082222-2E CITATION 500\FCC BELOW 1G\20230908-013914_H
Memo: 5GWIFI

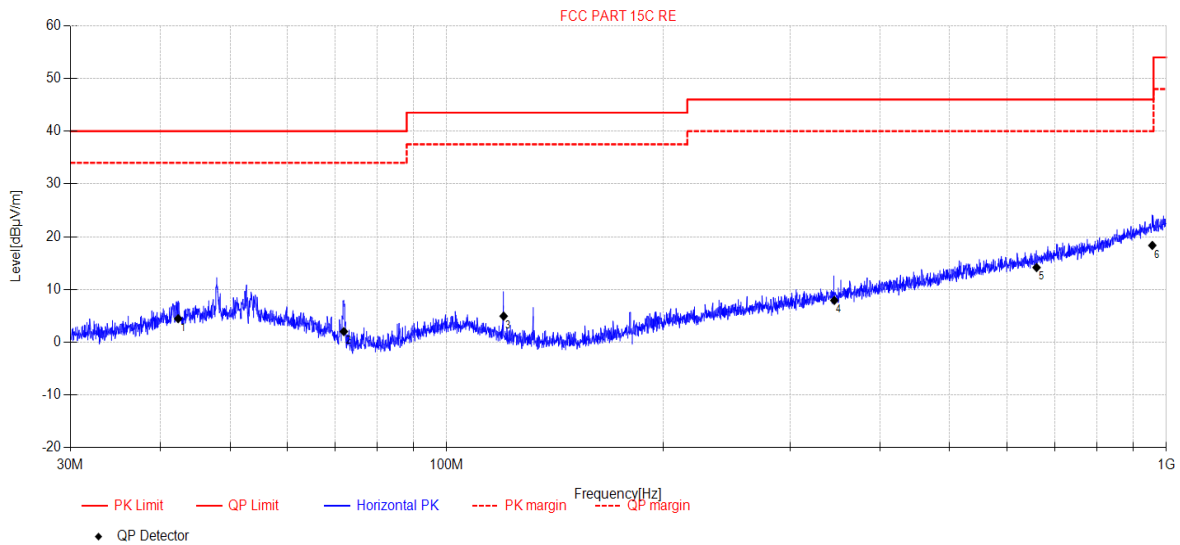

Final Data List										
NO.	Freq. [MHz]	Reading [dBµV/m]	Antenna Factor [dB]	Cable Loss [dB]	AMP [dB]	Result [dBµV/m]	Limit [dBµV/m]	Margin [dB]	Detector	Polarity
1	42.36	18.08	12.57	4.63	-30.81	4.47	40.00	35.53	QP	Horizontal
2	71.97	19.87	7.91	4.80	-30.55	2.03	40.00	37.97	QP	Horizontal
3	119.99	21.92	8.70	5.17	-30.84	4.95	43.50	38.55	QP	Horizontal
4	345.67	17.23	14.51	6.40	-30.21	7.93	46.00	38.07	QP	Horizontal
5	660.28	17.06	19.41	7.59	-29.90	14.16	46.00	31.84	QP	Horizontal
6	956.12	15.6	22.70	8.54	-28.49	18.35	46.00	27.65	QP	Horizontal

Note:

1. Result Level = Reading + Cable loss + Antenna Factor + AMP
2. If Peak Result complies with QP limit, QP Result is deemed to comply with QP limit.
3. Test setup: RBW: 120 kHz, VBW: 300 kHz, Sweep time: auto.

TR-4-E-009 Radiated Emission Test Result

Test Date: 2023-09-08 **Tested By:** Bairong
EUT: Wireless Speaker **Model Number:** CITATION 500
Test Mode: TX Mode **Power Supply:** AC 120V/60Hz
Condition: Temp:21.1°C;Humi:68.5% **Test Site:** DDT 3# Chamber
File Path: d:\ts\2023 report data\Q23082222-2E CITATION 500\FCC BELOW 1G\20230908-013955_V
Memo: 5GWIFI

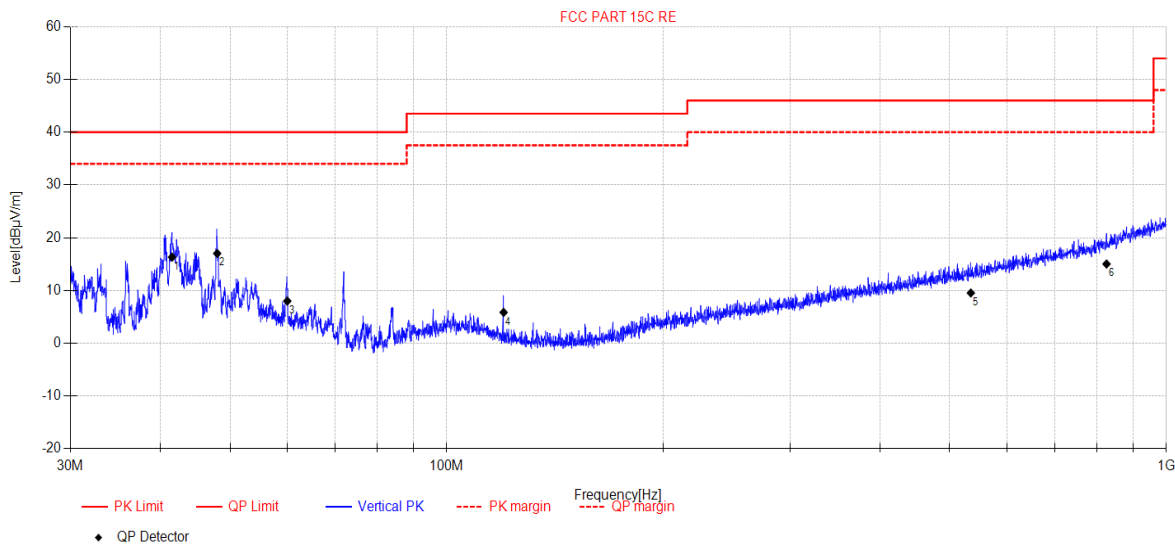

Final Data List										
NO.	Freq. [MHz]	Reading [dBµV/m]	Antenna Factor [dB]	Cable Loss [dB]	AMP [dB]	Result [dBµV/m]	Limit [dBµV/m]	Margin [dB]	Detector	Polarity
1	41.54	30.12	12.41	4.62	-30.83	16.32	40.00	23.68	QP	Vertical
2	47.99	29.84	13.20	4.70	-30.73	17.01	40.00	22.99	QP	Vertical
3	60.06	21.99	11.88	4.76	-30.63	8.00	40.00	32.00	QP	Vertical
4	119.99	22.82	8.70	5.17	-30.84	5.85	43.50	37.65	QP	Vertical
5	535.02	14.86	17.50	7.07	-29.90	9.53	46.00	36.47	QP	Vertical
6	825.79	15.02	21.60	8.07	-29.67	15.02	46.00	30.98	QP	Vertical

Note:

1. Result Level = Reading + Cable loss + Antenna Factor + AMP
2. If Peak Result complies with QP limit, QP Result is deemed to comply with QP limit.
3. Test setup: RBW: 120 kHz, VBW: 300 kHz, Sweep time: auto.

Radiated Emission test (above 1GHz)

TR-4-E-009 Radiated Emission Test Result

Test Date: 2023-09-07 **Tested By:** Bairong
EUT: Wireless Speaker **Model Number:** CITATION 500
Test Mode: TX Mode **Power Supply:** AC 120V/60Hz
Condition: Temp:21.1°C;Humi:68.5% **Test Site:** DDT 3# Chamber
File Path: d:\ts\2023 report data\Q23082222-2E CITATION 500\FCC ABOVE 1G 5GWIFI\1
Memo: 11N20MIMO 5180

Test Graph

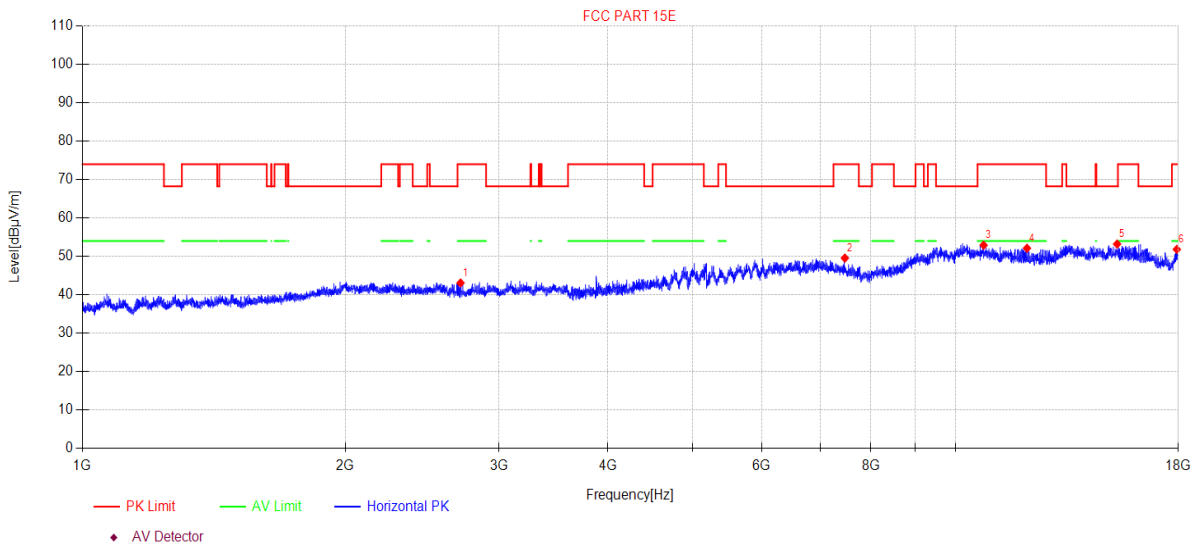

Suspected Data List										
N O.	Freq. [MHz]	Reading [dBμV/m]	Cable loss [dB]	Antenna Factor [dB]	AMP [dB]	Level [dBμV/m]	Limit [dBμV/m]	Margin [dB]	Detector	Polarity
1	2711.14	48.20	5.60	28.32	-39.02	43.10	74.00	30.90	PK	Horizontal
2	7470.18	46.10	8.88	36.46	-41.88	49.56	74.00	24.44	PK	Horizontal
3	10770.43	43.32	9.50	39.10	-39.01	52.91	74.00	21.09	PK	Horizontal
4	12076.38	42.34	10.32	39.05	-39.59	52.12	74.00	21.88	PK	Horizontal
5	15314.75	40.75	12.62	38.79	-38.95	53.21	68.20	14.99	PK	Horizontal
6	17927.32	39.92	12.78	41.36	-42.24	51.82	74.00	22.18	PK	Horizontal

Note:

1. Level = Reading + Cable loss + Antenna Factor + AMP
2. If Peak Result complies with AV limit, AV Result is deemed to comply with AV limit.
3. Test setup: RBW: 1 MHz, VBW: 3 MHz, Sweep time: auto.

TR-4-E-009 Radiated Emission Test Result

Test Date: 2023-09-07 **Tested By:** Bairong
EUT: Wireless Speaker **Model Number:** CITATION 500
Test Mode: TX Mode **Power Supply:** AC 120V/60Hz
Condition: Temp:21.1°C;Humi:68.5% **Test Site:** DDT 3# Chamber
File Path: d:\ts\2023 report data\Q23082222-2E CITATION 500\FCC ABOVE 1G 5GWIFI\2
Memo: 11N20MIMO 5180

Test Graph

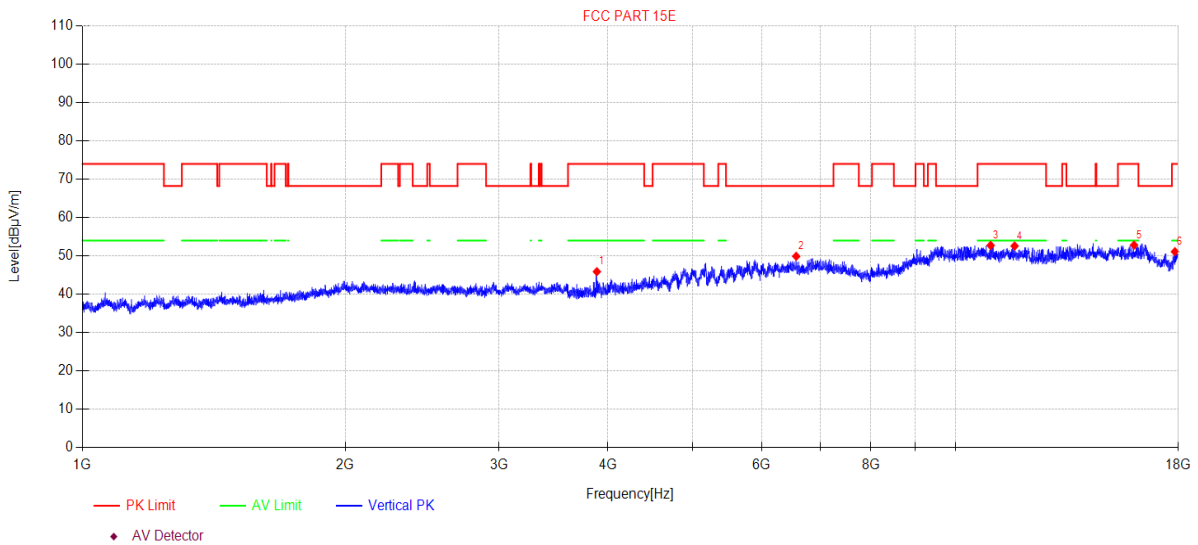

Suspected Data List										
N O.	Freq. [MHz]	Reading [dBµV/m]	Cable loss [dB]	Antenna Factor [dB]	AMP [dB]	Level [dBµV/m]	Limit [dBµV/m]	Margin [dB]	Detector	Polarity
1	3884.11	49.81	6.00	30.47	-40.38	45.90	74.00	28.10	PK	Vertical
2	6570.57	45.87	9.13	35.28	-40.38	49.90	68.20	18.30	PK	Vertical
3	10971.50	43.20	9.52	39.10	-39.08	52.74	74.00	21.26	PK	Vertical
4	11688.36	43.11	10.07	38.81	-39.41	52.58	74.00	21.42	PK	Vertical
5	16016.39	38.31	16.00	37.88	-39.37	52.82	74.00	21.18	PK	Vertical
6	17839.45	39.67	12.69	40.78	-42.04	51.10	74.00	22.90	PK	Vertical

Note:

1. Level = Reading + Cable loss + Antenna Factor + AMP
2. If Peak Result complies with AV limit, AV Result is deemed to comply with AV limit.
3. Test setup: RBW: 1 MHz, VBW: 3 MHz, Sweep time: auto.

TR-4-E-009 Radiated Emission Test Result

Test Date: 2023-09-07 **Tested By:** Bairong
EUT: Wireless Speaker **Model Number:** CITATION 500
Test Mode: TX Mode **Power Supply:** AC 120V/60Hz
Condition: Temp:21.1°C;Humi:68.5% **Test Site:** DDT 3# Chamber
File Path: d:\ts\2023 report data\Q23082222-2E CITATION 500\FCC ABOVE 1G 5GWIFI\3
Memo: 11N20MIMO 5200

Test Graph

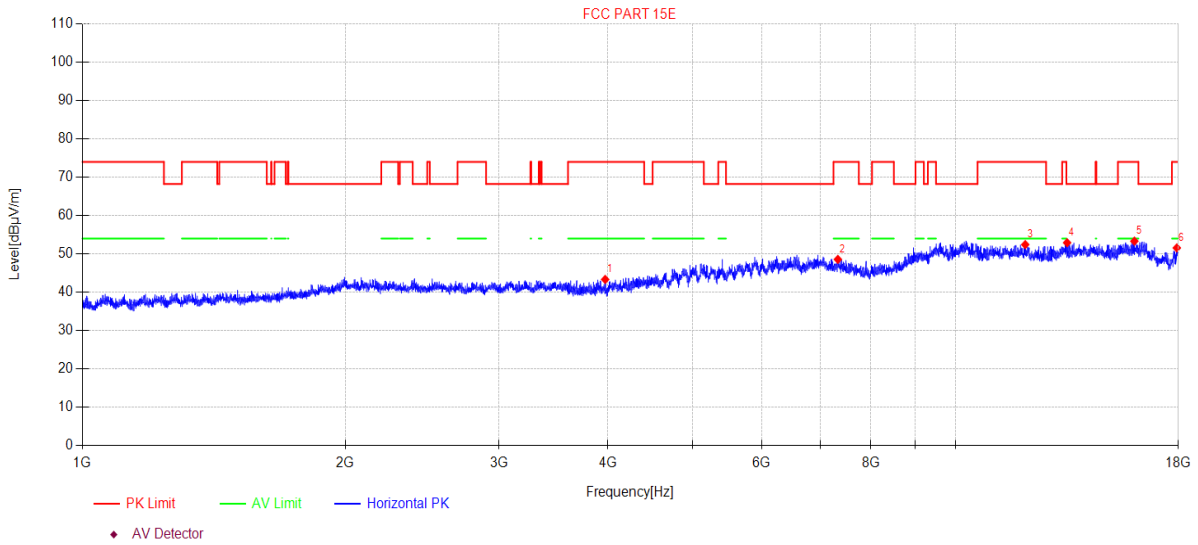

Suspected Data List										
N O.	Freq. [MHz]	Reading [dBµV/m]	Cable loss [dB]	Antenna Factor [dB]	AMP [dB]	Level [dBµV/m]	Limit [dBµV/m]	Margin [dB]	Detector	Polarity
1	3970.37	47.08	6.06	30.64	-40.43	43.35	74.00	30.65	PK	Horizontal
2	7333.28	44.70	8.91	36.50	-41.53	48.58	74.00	25.42	PK	Horizontal
3	12020.66	42.74	10.32	38.94	-39.57	52.43	74.00	21.57	PK	Horizontal
4	13423.79	42.09	10.54	40.10	-39.82	52.91	68.20	15.29	PK	Horizontal
5	16030.28	38.90	15.94	37.87	-39.38	53.33	74.00	20.67	PK	Horizontal
6	17927.32	39.66	12.78	41.36	-42.24	51.56	74.00	22.44	PK	Horizontal

Note:

1. Level = Reading + Cable loss + Antenna Factor + AMP
2. If Peak Result complies with AV limit, AV Result is deemed to comply with AV limit.
3. Test setup: RBW: 1 MHz, VBW: 3 MHz, Sweep time: auto.

TR-4-E-009 Radiated Emission Test Result

Test Date: 2023-09-07 **Tested By:** Bairong
EUT: Wireless Speaker **Model Number:** CITATION 500
Test Mode: TX Mode **Power Supply:** AC 120V/60Hz
Condition: Temp:21.1°C;Humi:68.5% **Test Site:** DDT 3# Chamber
File Path: d:\ts\2023 report data\Q23082222-2E CITATION 500\FCC ABOVE 1G 5GWIFI4
Memo: 11N20MIMO 5200

Test Graph

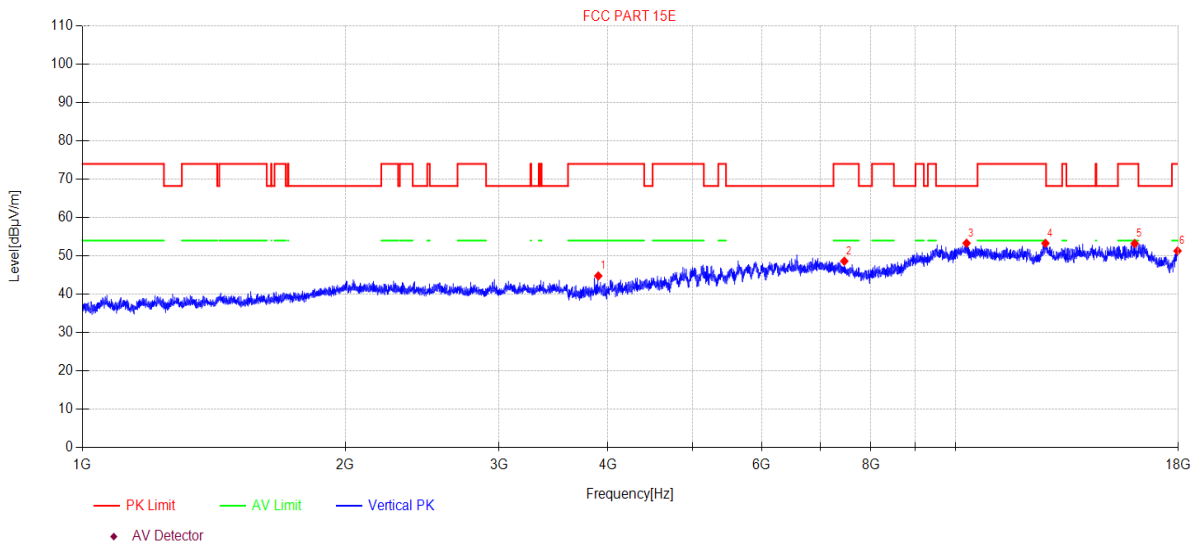

Suspected Data List										
N O.	Freq. [MHz]	Reading [dBµV/m]	Cable loss [dB]	Antenna Factor [dB]	AMP [dB]	Level [dBµV/m]	Limit [dBµV/m]	Margin [dB]	Detector	Polarity
1	3898.73	48.67	6.01	30.50	-40.39	44.79	74.00	29.21	PK	Vertical
2	7459.40	45.12	8.89	36.48	-41.85	48.64	74.00	25.36	PK	Vertical
3	10298.60	43.89	9.45	38.80	-38.83	53.31	68.20	14.89	PK	Vertical
4	12677.20	43.40	10.36	39.35	-39.82	53.29	74.00	20.71	PK	Vertical
5	16044.18	38.89	15.88	37.86	-39.40	53.23	74.00	20.77	PK	Vertical
6	17963.62	39.23	12.81	41.58	-42.32	51.30	74.00	22.70	PK	Vertical

Note:

1. Level = Reading + Cable loss + Antenna Factor + AMP
2. If Peak Result complies with AV limit, AV Result is deemed to comply with AV limit.
3. Test setup: RBW: 1 MHz, VBW: 3 MHz, Sweep time: auto.

TR-4-E-009 Radiated Emission Test Result

Test Date: 2023-09-07 **Tested By:** Bairong
EUT: Wireless Speaker **Model Number:** CITATION 500
Test Mode: TX Mode **Power Supply:** AC 120V/60Hz
Condition: Temp:21.1°C;Humi:68.5% **Test Site:** DDT 3# Chamber
File Path: d:\ts\2023 report data\Q23082222-2E CITATION 500\FCC ABOVE 1G 5GWIFI\5
Memo: 11N20MIMO 5240

Test Graph

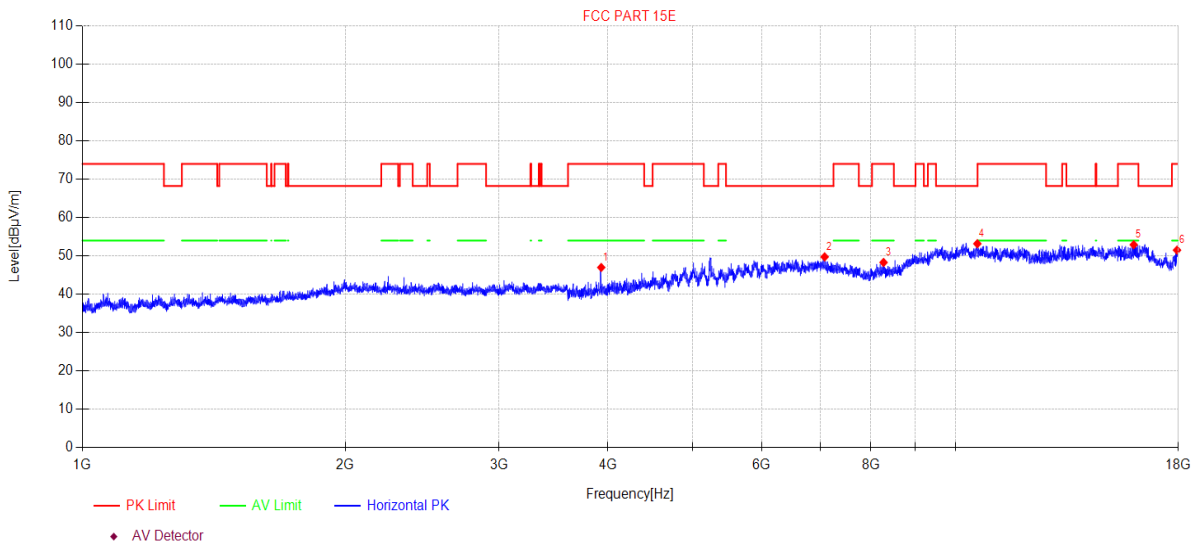

Suspected Data List										
N O.	Freq. [MHz]	Reading [dBµV/m]	Cable loss [dB]	Antenna Factor [dB]	AMP [dB]	Level [dBµV/m]	Limit [dBµV/m]	Margin [dB]	Detector	Polarity
1	3929.27	50.81	6.03	30.56	-40.41	46.99	74.00	27.01	PK	Horizontal
2	7081.27	45.44	8.95	36.26	-40.90	49.75	68.20	18.45	PK	Horizontal
3	8272.52	44.28	8.87	37.15	-42.00	48.30	74.00	25.70	PK	Horizontal
4	10594.45	43.65	9.48	38.99	-38.94	53.18	68.20	15.02	PK	Horizontal
5	16002.51	38.32	16.06	37.90	-39.36	52.92	74.00	21.08	PK	Horizontal
6	17937.68	39.54	12.79	41.43	-42.26	51.50	74.00	22.50	PK	Horizontal

Note:

1. Level = Reading + Cable loss + Antenna Factor + AMP
2. If Peak Result complies with AV limit, AV Result is deemed to comply with AV limit.
3. Test setup: RBW: 1 MHz, VBW: 3 MHz, Sweep time: auto.

TR-4-E-009 Radiated Emission Test Result

Test Date: 2023-09-07 **Tested By:** Bairong
EUT: Wireless Speaker **Model Number:** CITATION 500
Test Mode: TX Mode **Power Supply:** AC 120V/60Hz
Condition: Temp:21.1°C;Humi:68.5% **Test Site:** DDT 3# Chamber
File Path: d:\ts\2023 report data\Q23082222-2E CITATION 500\FCC ABOVE 1G 5GWIFI\6
Memo: 11N20MIMO 5240

Test Graph

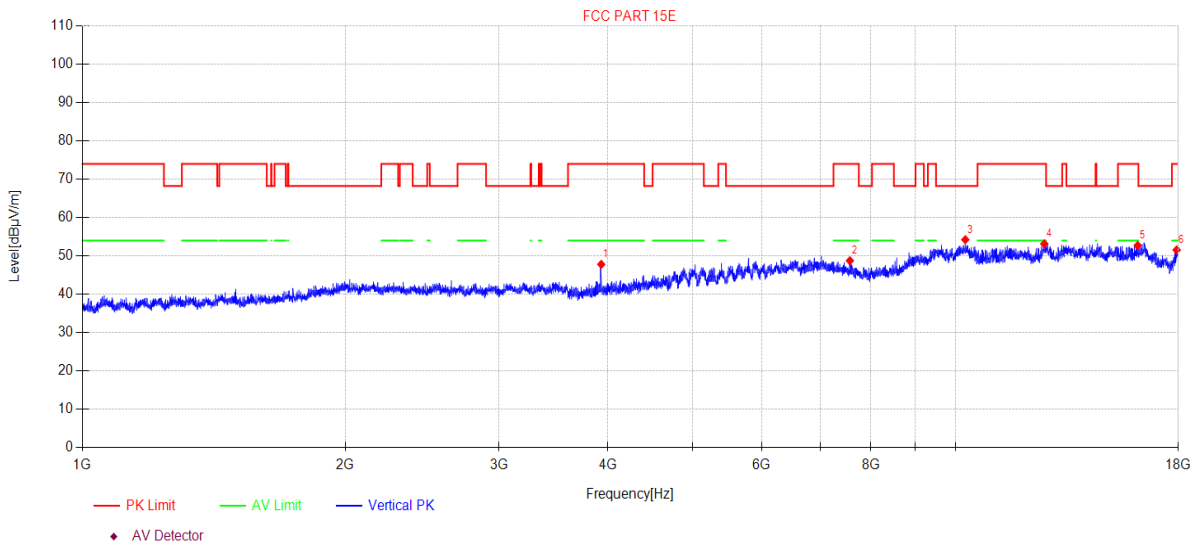

Suspected Data List										
N O.	Freq. [MHz]	Reading [dBμV/m]	Cable loss [dB]	Antenna Factor [dB]	AMP [dB]	Level [dBμV/m]	Limit [dBμV/m]	Margin [dB]	Detector	Polarity
1	3929.27	51.62	6.03	30.56	-40.41	47.80	74.00	26.20	PK	Vertical
2	7570.16	45.62	8.87	36.40	-42.13	48.76	74.00	25.24	PK	Vertical
3	10262.94	44.84	9.45	38.76	-38.82	54.23	68.20	13.97	PK	Vertical
4	12640.61	43.33	10.36	39.28	-39.81	53.16	74.00	20.84	PK	Vertical
5	16169.87	39.13	15.36	37.73	-39.50	52.72	74.00	21.28	PK	Vertical
6	17922.14	39.68	12.77	41.33	-42.23	51.55	74.00	22.45	PK	Vertical

Note:

1. Level = Reading + Cable loss + Antenna Factor + AMP
2. If Peak Result complies with AV limit, AV Result is deemed to comply with AV limit.
3. Test setup: RBW: 1 MHz, VBW: 3 MHz, Sweep time: auto.

TR-4-E-009 Radiated Emission Test Result

Test Date: 2023-09-07 **Tested By:** Bairong
EUT: Wireless Speaker **Model Number:** CITATION 500
Test Mode: TX Mode **Power Supply:** AC 120V/60Hz
Condition: Temp:21.1°C;Humi:68.5% **Test Site:** DDT 3# Chamber
File Path: d:\ts\2023 report data\Q23082222-2E CITATION 500\FCC ABOVE 1G 5GWIFI\7
Memo: 11N20MIMO 5260

Test Graph

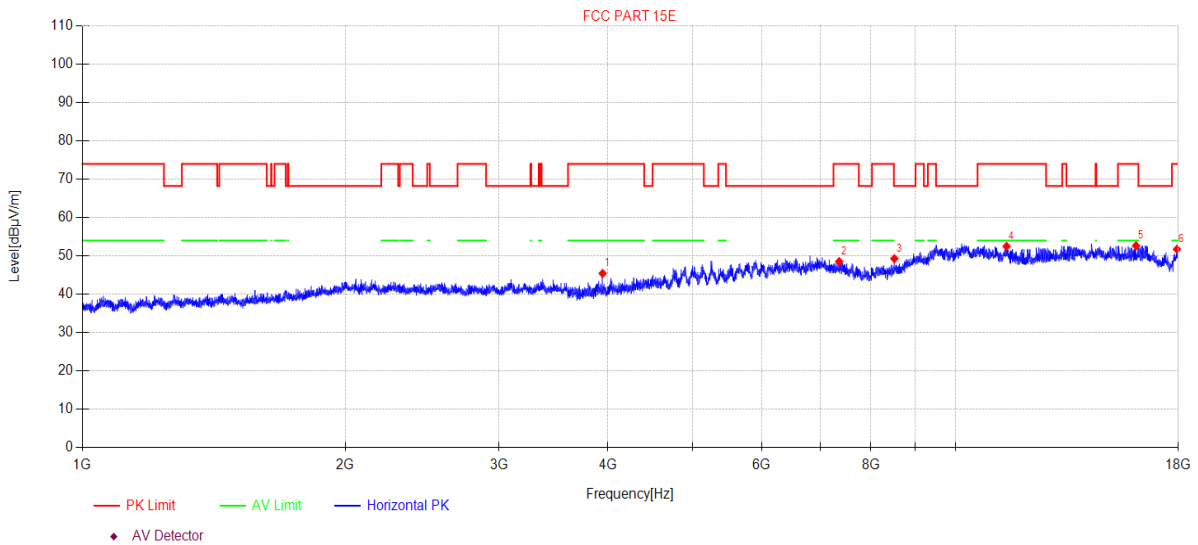

Suspected Data List										
N O.	Freq. [MHz]	Reading [dBµV/m]	Cable loss [dB]	Antenna Factor [dB]	AMP [dB]	Level [dBµV/m]	Limit [dBµV/m]	Margin [dB]	Detector	Polarity
1	3944.06	49.22	6.04	30.59	-40.42	45.43	74.00	28.57	PK	Horizontal
2	7358.76	44.71	8.90	36.50	-41.60	48.51	74.00	25.49	PK	Horizontal
3	8512.63	43.77	8.92	37.53	-40.94	49.28	68.20	18.92	PK	Horizontal
4	11444.35	42.86	9.88	39.06	-39.30	52.50	74.00	21.50	PK	Horizontal
5	16099.92	38.64	15.65	37.80	-39.44	52.65	74.00	21.35	PK	Horizontal
6	17932.50	39.82	12.78	41.39	-42.25	51.74	74.00	22.26	PK	Horizontal

Note:

- Level = Reading + Cable loss + Antenna Factor + AMP
- If Peak Result complies with AV limit, AV Result is deemed to comply with AV limit.
- Test setup: RBW: 1 MHz, VBW: 3 MHz, Sweep time: auto.

TR-4-E-009 Radiated Emission Test Result

Test Date: 2023-09-07 **Tested By:** Bairong
EUT: Wireless Speaker **Model Number:** CITATION 500
Test Mode: TX Mode **Power Supply:** AC 120V/60Hz
Condition: Temp:21.1°C;Humi:68.5% **Test Site:** DDT 3# Chamber
File Path: d:\ts\2023 report data\Q23082222-2E CITATION 500\FCC ABOVE 1G 5GWIFI\8
Memo: 11N20MIMO 5260

Test Graph

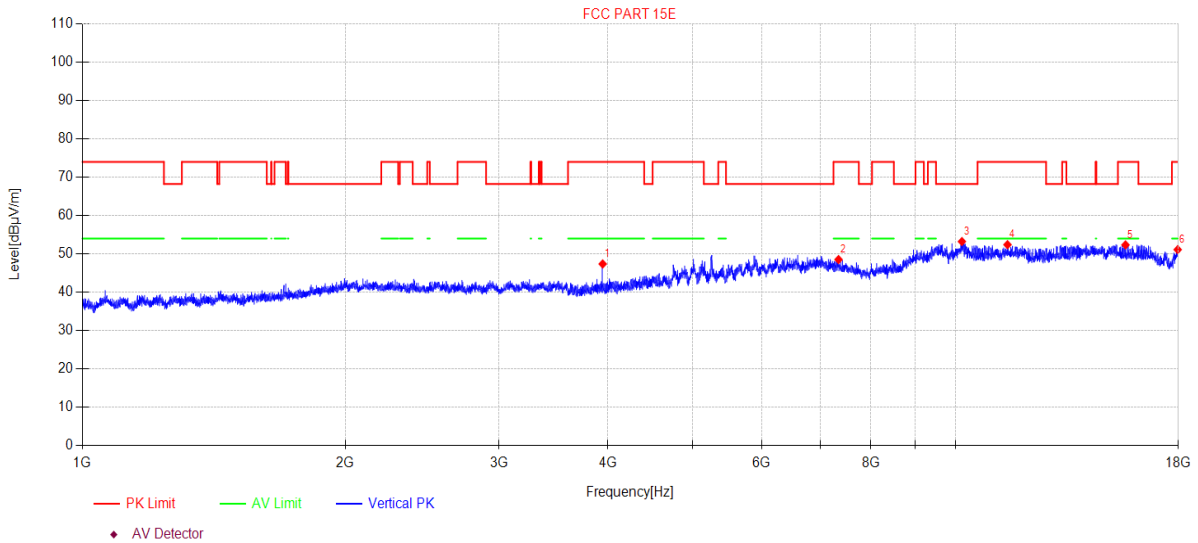

Suspected Data List										
N O.	Freq. [MHz]	Reading [dBµV/m]	Cable loss [dB]	Antenna Factor [dB]	AMP [dB]	Level [dBµV/m]	Limit [dBµV/m]	Margin [dB]	Detector	Polarity
1	3944.06	51.18	6.04	30.59	-40.42	47.39	74.00	26.61	PK	Vertical
2	7346.01	44.70	8.90	36.50	-41.57	48.53	74.00	25.47	PK	Vertical
3	10171.41	43.90	9.44	38.67	-38.78	53.23	68.20	14.97	PK	Vertical
4	11470.84	42.78	9.90	39.03	-39.31	52.40	74.00	21.60	PK	Vertical
5	15659.37	38.82	14.35	38.34	-39.16	52.35	74.00	21.65	PK	Vertical
6	17968.81	39.01	12.82	41.61	-42.33	51.11	74.00	22.89	PK	Vertical

Note:

1. Level = Reading + Cable loss + Antenna Factor + AMP
2. If Peak Result complies with AV limit, AV Result is deemed to comply with AV limit.
3. Test setup: RBW: 1 MHz, VBW: 3 MHz, Sweep time: auto.

TR-4-E-009 Radiated Emission Test Result

Test Date: 2023-09-07 **Tested By:** Bairong
EUT: Wireless Speaker **Model Number:** CITATION 500
Test Mode: TX Mode **Power Supply:** AC 120V/60Hz
Condition: Temp:21.1°C;Humi:68.5% **Test Site:** DDT 3# Chamber
File Path: d:\ts\2023 report data\Q23082222-2E CITATION 500\FCC ABOVE 1G 5GWIFI\9
Memo: 11N20MIMO 5280

Test Graph

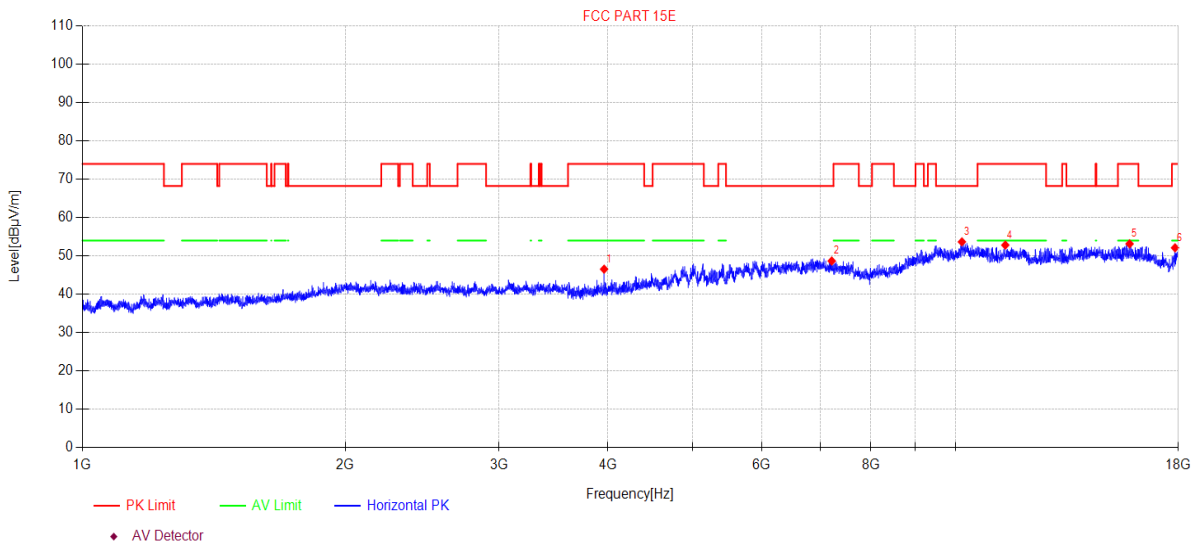

Suspected Data List										
N O.	Freq. [MHz]	Reading [dBµV/m]	Cable loss [dB]	Antenna Factor [dB]	AMP [dB]	Level [dBµV/m]	Limit [dBµV/m]	Margin [dB]	Detector	Polarity
1	3958.91	50.30	6.05	30.62	-40.42	46.55	74.00	27.45	PK	Horizontal
2	7215.55	44.49	8.93	36.50	-41.24	48.68	68.20	19.52	PK	Horizontal
3	10171.41	44.33	9.44	38.67	-38.78	53.66	68.20	14.54	PK	Horizontal
4	11404.72	43.16	9.84	39.10	-39.28	52.82	74.00	21.18	PK	Horizontal
5	15827.72	39.05	15.20	38.17	-39.26	53.16	74.00	20.84	PK	Horizontal
6	17844.61	40.66	12.70	40.81	-42.05	52.12	74.00	21.88	PK	Horizontal

Note:

1. Level = Reading + Cable loss + Antenna Factor + AMP
2. If Peak Result complies with AV limit, AV Result is deemed to comply with AV limit.
3. Test setup: RBW: 1 MHz, VBW: 3 MHz, Sweep time: auto.

TR-4-E-009 Radiated Emission Test Result

Test Date: 2023-09-07 **Tested By:** Bairong
EUT: Wireless Speaker **Model Number:** CITATION 500
Test Mode: TX Mode **Power Supply:** AC 120V/60Hz
Condition: Temp:21.1°C;Humi:68.5% **Test Site:** DDT 3# Chamber
File Path: d:\ts\2023 report data\Q23082222-2E CITATION 500\FCC ABOVE 1G 5GWIFI\10
Memo: 11N20MIMO 5280

Test Graph

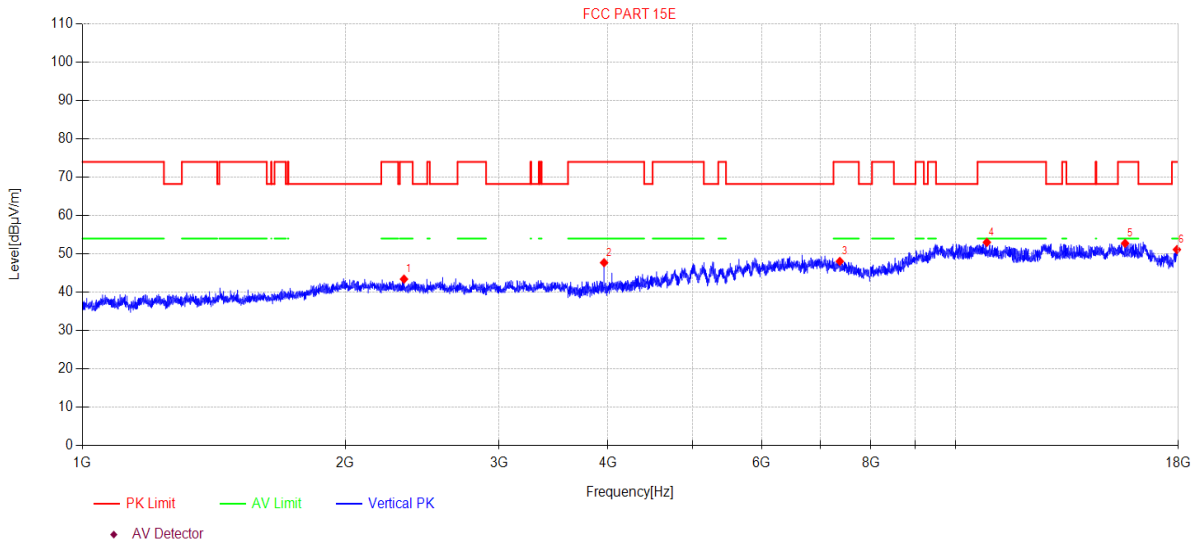

Suspected Data List										
N O.	Freq. [MHz]	Reading [dBµV/m]	Cable loss [dB]	Antenna Factor [dB]	AMP [dB]	Level [dBµV/m]	Limit [dBµV/m]	Margin [dB]	Detector	Polarity
1	2335.53	48.10	5.93	27.37	-37.96	43.44	74.00	30.56	PK	Vertical
2	3958.91	51.47	6.05	30.62	-40.42	47.72	74.00	26.28	PK	Vertical
3	7371.53	44.30	8.90	36.50	-41.63	48.07	74.00	25.93	PK	Vertical
4	10864.21	43.45	9.51	39.10	-39.04	53.02	74.00	20.98	PK	Vertical
5	15641.28	39.27	14.26	38.36	-39.14	52.75	74.00	21.25	PK	Vertical
6	17932.50	39.21	12.78	41.39	-42.25	51.13	74.00	22.87	PK	Vertical

Note:

1. Level = Reading + Cable loss + Antenna Factor + AMP
2. If Peak Result complies with AV limit, AV Result is deemed to comply with AV limit.
3. Test setup: RBW: 1 MHz, VBW: 3 MHz, Sweep time: auto.

TR-4-E-009 Radiated Emission Test Result

Test Date: 2023-09-07 **Tested By:** Bairong
EUT: Wireless Speaker **Model Number:** CITATION 500
Test Mode: TX Mode **Power Supply:** AC 120V/60Hz
Condition: Temp:21.1°C;Humi:68.5% **Test Site:** DDT 3# Chamber
File Path: d:\ts\2023 report data\Q23082222-2E CITATION 500\FCC ABOVE 1G 5GWIFI\11
Memo: 11N20MIMO 5320

Test Graph

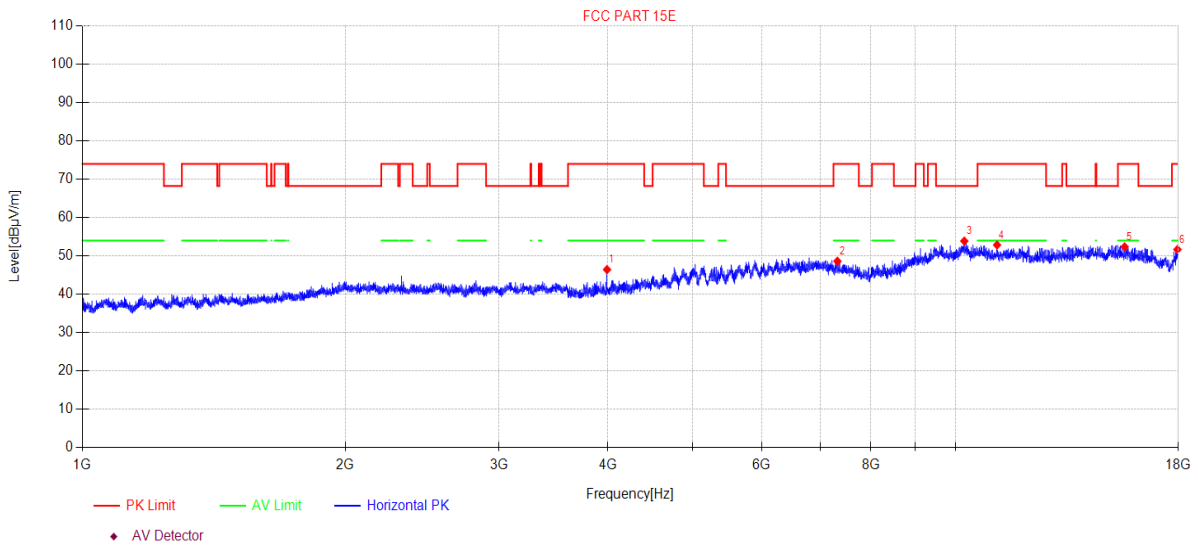

Suspected Data List										
N O.	Freq. [MHz]	Reading [dBµV/m]	Cable loss [dB]	Antenna Factor [dB]	AMP [dB]	Level [dBµV/m]	Limit [dBµV/m]	Margin [dB]	Detector	Polarity
1	3989.92	50.12	6.07	30.68	-40.44	46.43	74.00	27.57	PK	Horizontal
2	7324.81	44.73	8.91	36.50	-41.51	48.63	74.00	25.37	PK	Horizontal
3	10236.28	44.51	9.44	38.74	-38.81	53.88	68.20	14.32	PK	Horizontal
4	11160.18	43.27	9.65	39.10	-39.17	52.85	74.00	21.15	PK	Horizontal
5	15623.21	38.95	14.17	38.38	-39.13	52.37	74.00	21.63	PK	Horizontal
6	17958.43	39.63	12.81	41.55	-42.31	51.68	74.00	22.32	PK	Horizontal

Note:

1. Level = Reading + Cable loss + Antenna Factor + AMP
2. If Peak Result complies with AV limit, AV Result is deemed to comply with AV limit.
3. Test setup: RBW: 1 MHz, VBW: 3 MHz, Sweep time: auto.

TR-4-E-009 Radiated Emission Test Result

Test Date: 2023-09-07 **Tested By:** Bairong
EUT: Wireless Speaker **Model Number:** CITATION 500
Test Mode: TX Mode **Power Supply:** AC 120V/60Hz
Condition: Temp:21.1°C;Humi:68.5% **Test Site:** DDT 3# Chamber
File Path: d:\ts\2023 report data\Q23082222-2E CITATION 500\FCC ABOVE 1G 5GWIFI\12
Memo: 11N20MIMO 5320

Test Graph

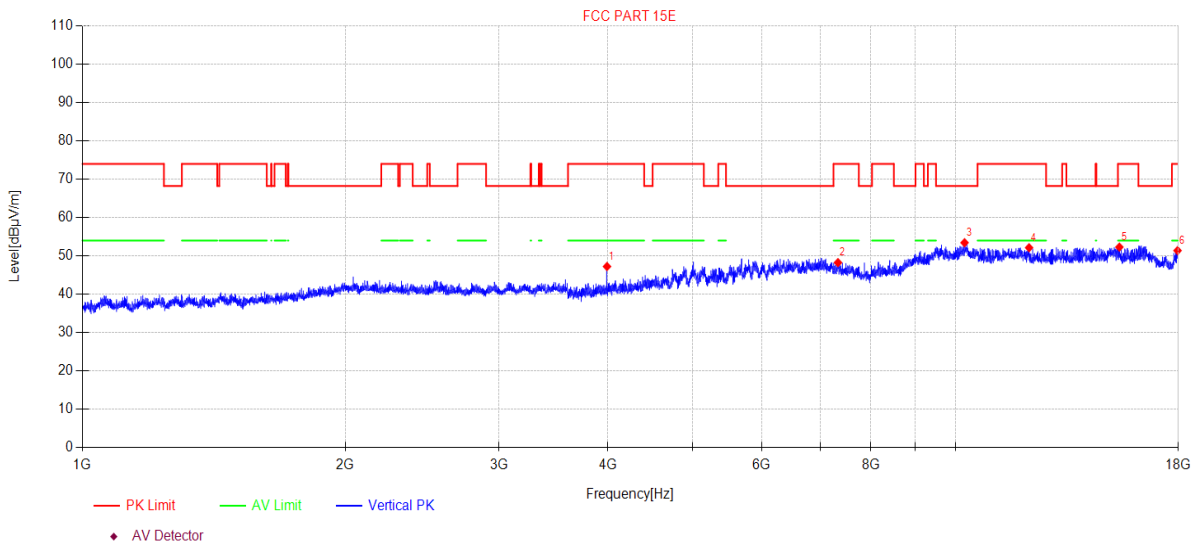

Suspected Data List										
N O.	Freq. [MHz]	Reading [dBµV/m]	Cable loss [dB]	Antenna Factor [dB]	AMP [dB]	Level [dBµV/m]	Limit [dBµV/m]	Margin [dB]	Detector	Polarity
1	3989.92	50.93	6.07	30.68	-40.44	47.24	74.00	26.76	PK	Vertical
2	7335.40	44.38	8.91	36.50	-41.54	48.25	74.00	25.75	PK	Vertical
3	10242.20	44.07	9.44	38.74	-38.81	53.44	68.20	14.76	PK	Vertical
4	12142.87	42.34	10.33	39.10	-39.62	52.15	74.00	21.85	PK	Vertical
5	15407.98	39.52	13.09	38.69	-39.00	52.30	74.00	21.70	PK	Vertical
6	17963.62	39.32	12.81	41.58	-42.32	51.39	74.00	22.61	PK	Vertical

Note:

1. Level = Reading + Cable loss + Antenna Factor + AMP
2. If Peak Result complies with AV limit, AV Result is deemed to comply with AV limit.
3. Test setup: RBW: 1 MHz, VBW: 3 MHz, Sweep time: auto.

TR-4-E-009 Radiated Emission Test Result

Test Date: 2023-09-07 **Tested By:** Bairong
EUT: Wireless Speaker **Model Number:** CITATION 500
Test Mode: TX Mode **Power Supply:** AC 120V/60Hz
Condition: Temp:21.1°C;Humi:68.5% **Test Site:** DDT 3# Chamber
File Path: d:\ts\2023 report data\Q23082222-2E CITATION 500\FCC ABOVE 1G 5GWIFI\13
Memo: 11N20MIMO 5500

Test Graph

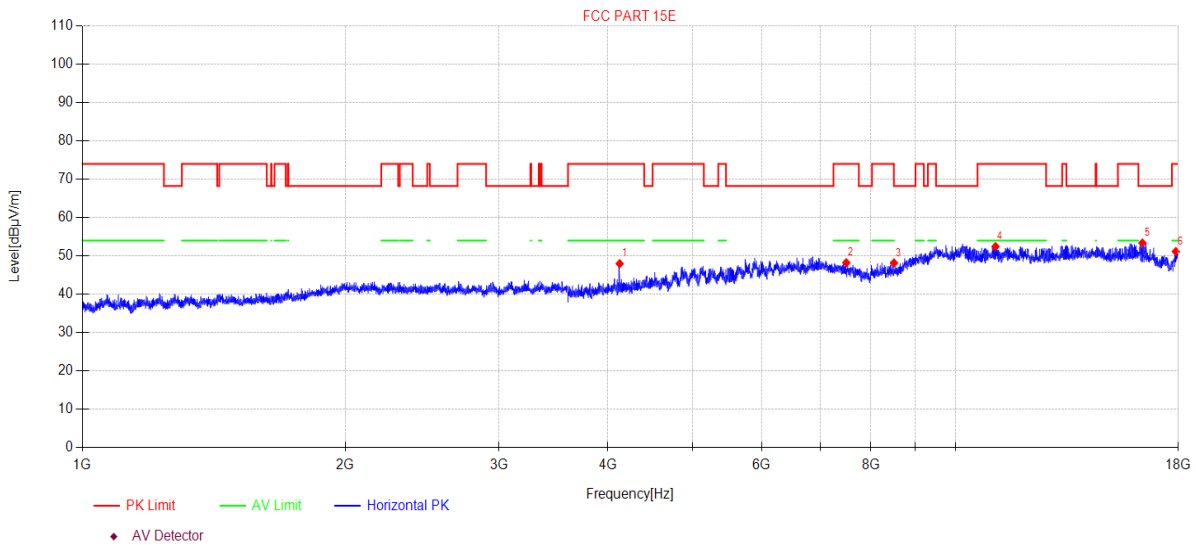

Suspected Data List										
N O.	Freq. [MHz]	Reading [dBµV/m]	Cable loss [dB]	Antenna Factor [dB]	AMP [dB]	Level [dBµV/m]	Limit [dBµV/m]	Margin [dB]	Detector	Polarity
1	4124.76	51.12	6.32	30.95	-40.40	47.99	74.00	26.01	PK	Horizontal
2	7498.30	44.92	8.88	36.40	-41.95	48.25	74.00	25.75	PK	Horizontal
3	8502.80	42.74	8.92	37.51	-40.98	48.19	68.20	20.01	PK	Horizontal
4	11115.12	42.86	9.61	39.10	-39.14	52.43	74.00	21.57	PK	Horizontal
5	16372.07	40.86	14.51	37.67	-39.66	53.38	68.20	14.82	PK	Horizontal
6	17880.75	39.48	12.73	41.07	-42.13	51.15	74.00	22.85	PK	Horizontal

Note:

1. Level = Reading + Cable loss + Antenna Factor + AMP
2. If Peak Result complies with AV limit, AV Result is deemed to comply with AV limit.
3. Test setup: RBW: 1 MHz, VBW: 3 MHz, Sweep time: auto.

TR-4-E-009 Radiated Emission Test Result

Test Date: 2023-09-07 **Tested By:** Bairong
EUT: Wireless Speaker **Model Number:** CITATION 500
Test Mode: TX Mode **Power Supply:** AC 120V/60Hz
Condition: Temp:21.1°C;Humi:68.5% **Test Site:** DDT 3# Chamber
File Path: d:\ts\2023 report data\Q23082222-2E CITATION 500\FCC ABOVE 1G 5GWIFI\14
Memo: 11N20MIMO 5500

Test Graph

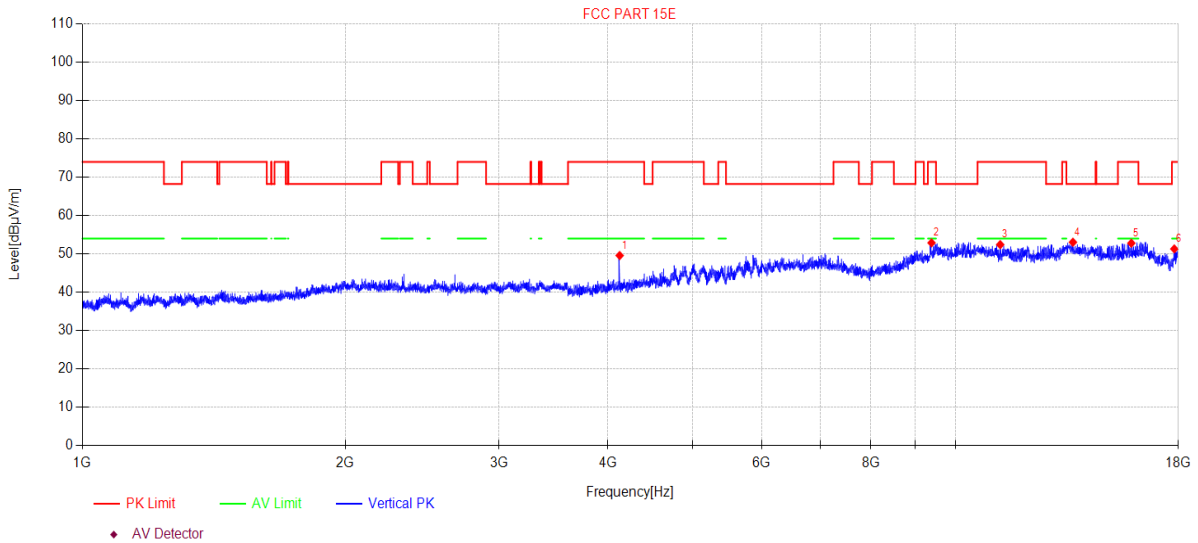

Suspected Data List										
N O.	Freq. [MHz]	Reading [dBµV/m]	Cable loss [dB]	Antenna Factor [dB]	AMP [dB]	Level [dBµV/m]	Limit [dBµV/m]	Margin [dB]	Detector	Polarity
1	4124.76	52.71	6.32	30.95	-40.40	49.58	74.00	24.42	PK	Vertical
2	9388.87	44.05	9.19	38.40	-38.76	52.88	74.00	21.12	PK	Vertical
3	11254.11	42.81	9.72	39.10	-39.21	52.42	74.00	21.58	PK	Vertical
4	13630.99	42.08	10.62	40.10	-39.75	53.05	68.20	15.15	PK	Vertical
5	15901.08	38.42	15.57	38.10	-39.30	52.79	74.00	21.21	PK	Vertical
6	17808.55	40.05	12.66	40.56	-41.97	51.30	74.00	22.70	PK	Vertical

Note:

1. Level = Reading + Cable loss + Antenna Factor + AMP
2. If Peak Result complies with AV limit, AV Result is deemed to comply with AV limit.
3. Test setup: RBW: 1 MHz, VBW: 3 MHz, Sweep time: auto.

TR-4-E-009 Radiated Emission Test Result

Test Date: 2023-09-07 **Tested By:** Bairong
EUT: Wireless Speaker **Model Number:** CITATION 500
Test Mode: TX Mode **Power Supply:** AC 120V/60Hz
Condition: Temp:21.1°C;Humi:68.5% **Test Site:** DDT 3# Chamber
File Path: d:\ts\2023 report data\Q23082222-2E CITATION 500\FCC ABOVE 1G 5GWIFI\15
Memo: 11N20MIMO 5580

Test Graph

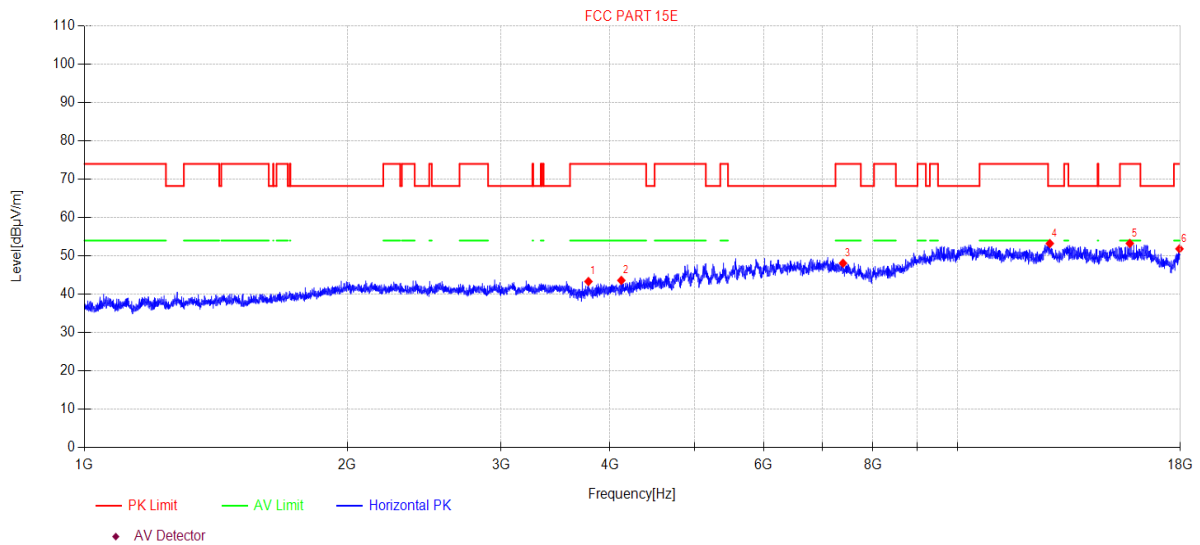

Suspected Data List										
N O.	Freq. [MHz]	Reading [dBμV/m]	Cable loss [dB]	Antenna Factor [dB]	AMP [dB]	Level [dBμV/m]	Limit [dBμV/m]	Margin [dB]	Detector	Polarity
1	3778.92	47.52	5.92	30.22	-40.32	43.34	74.00	30.66	PK	Horizontal
2	4121.18	46.79	6.31	30.94	-40.41	43.63	74.00	30.37	PK	Horizontal
3	7395.00	44.39	8.90	36.50	-41.69	48.10	74.00	25.90	PK	Horizontal
4	12758.06	43.27	10.37	39.46	-39.86	53.24	68.20	14.96	PK	Horizontal
5	15754.70	39.39	14.83	38.25	-39.21	53.26	74.00	20.74	PK	Horizontal
6	17958.43	39.79	12.81	41.55	-42.31	51.84	74.00	22.16	PK	Horizontal

Note:

1. Level = Reading + Cable loss + Antenna Factor + AMP
2. If Peak Result complies with AV limit, AV Result is deemed to comply with AV limit.
3. Test setup: RBW: 1 MHz, VBW: 3 MHz, Sweep time: auto.

TR-4-E-009 Radiated Emission Test Result

Test Date: 2023-09-07 **Tested By:** Bairong
EUT: Wireless Speaker **Model Number:** CITATION 500
Test Mode: TX Mode **Power Supply:** AC 120V/60Hz
Condition: Temp:21.1°C;Humi:68.5% **Test Site:** DDT 3# Chamber
File Path: d:\ts\2023 report data\Q23082222-2E CITATION 500\FCC ABOVE 1G 5GWIFI\16
Memo: 11N20MIMO 5580

Test Graph

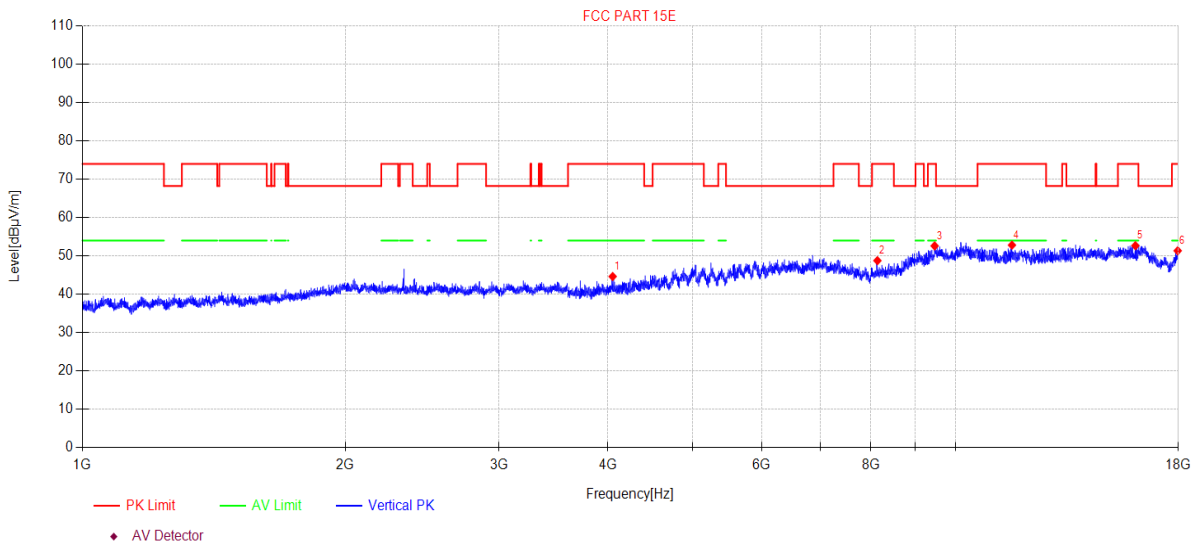

Suspected Data List										
N O.	Freq. [MHz]	Reading [dBµV/m]	Cable loss [dB]	Antenna Factor [dB]	AMP [dB]	Level [dBµV/m]	Limit [dBµV/m]	Margin [dB]	Detector	Polarity
1	4049.17	48.09	6.17	30.80	-40.43	44.63	74.00	29.37	PK	Vertical
2	8139.71	45.52	8.83	37.00	-42.58	48.77	74.00	25.23	PK	Vertical
3	9465.16	43.75	9.22	38.40	-38.76	52.61	74.00	21.39	PK	Vertical
4	11607.57	43.29	10.01	38.89	-39.38	52.81	74.00	21.19	PK	Vertical
5	16072.03	38.49	15.77	37.83	-39.42	52.67	74.00	21.33	PK	Vertical
6	17968.81	39.25	12.82	41.61	-42.33	51.35	74.00	22.65	PK	Vertical

Note:

1. Level = Reading + Cable loss + Antenna Factor + AMP
2. If Peak Result complies with AV limit, AV Result is deemed to comply with AV limit.
3. Test setup: RBW: 1 MHz, VBW: 3 MHz, Sweep time: auto.

TR-4-E-009 Radiated Emission Test Result

Test Date: 2023-09-07 **Tested By:** Bairong
EUT: Wireless Speaker **Model Number:** CITATION 500
Test Mode: TX Mode **Power Supply:** AC 120V/60Hz
Condition: Temp:21.1°C;Humi:68.5% **Test Site:** DDT 3# Chamber
File Path: d:\ts\2023 report data\Q23082222-2E CITATION 500\FCC ABOVE 1G 5GWIFI\17
Memo: 11N20MIMO 5700

Test Graph

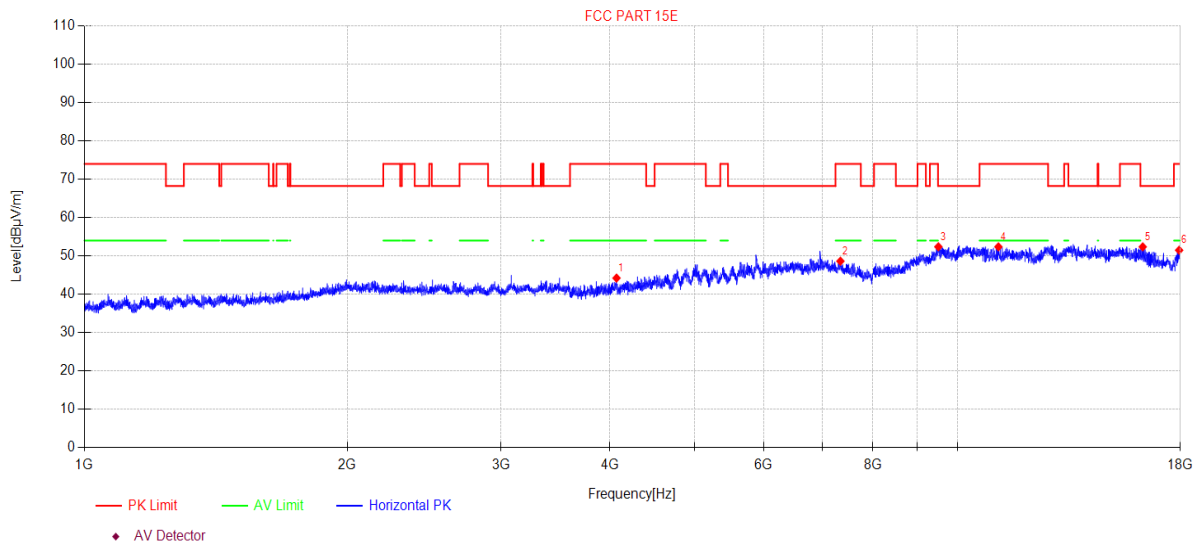

Suspected Data List										
N O.	Freq. [MHz]	Reading [dBµV/m]	Cable loss [dB]	Antenna Factor [dB]	AMP [dB]	Level [dBµV/m]	Limit [dBµV/m]	Margin [dB]	Detector	Polarity
1	4069.11	47.60	6.21	30.84	-40.42	44.23	74.00	29.77	PK	Horizontal
2	7343.89	44.79	8.90	36.50	-41.56	48.63	74.00	25.37	PK	Horizontal
3	9509.03	43.51	9.23	38.40	-38.75	52.39	68.20	15.81	PK	Horizontal
4	11140.84	42.81	9.63	39.10	-39.16	52.38	74.00	21.62	PK	Horizontal
5	16301.25	39.57	14.80	37.60	-39.60	52.37	68.20	15.83	PK	Horizontal
6	17942.87	39.51	12.79	41.46	-42.27	51.49	74.00	22.51	PK	Horizontal

Note:

1. Level = Reading + Cable loss + Antenna Factor + AMP
2. If Peak Result complies with AV limit, AV Result is deemed to comply with AV limit.
3. Test setup: RBW: 1 MHz, VBW: 3 MHz, Sweep time: auto.

TR-4-E-009 Radiated Emission Test Result

Test Date: 2023-09-07 **Tested By:** Bairong
EUT: Wireless Speaker **Model Number:** CITATION 500
Test Mode: TX Mode **Power Supply:** AC 120V/60Hz
Condition: Temp:21.1°C;Humi:68.5% **Test Site:** DDT 3# Chamber
File Path: d:\ts\2023 report data\Q23082222-2E CITATION 500\FCC ABOVE 1G 5GWIFI\18
Memo: 11N20MIMO 5700

Test Graph

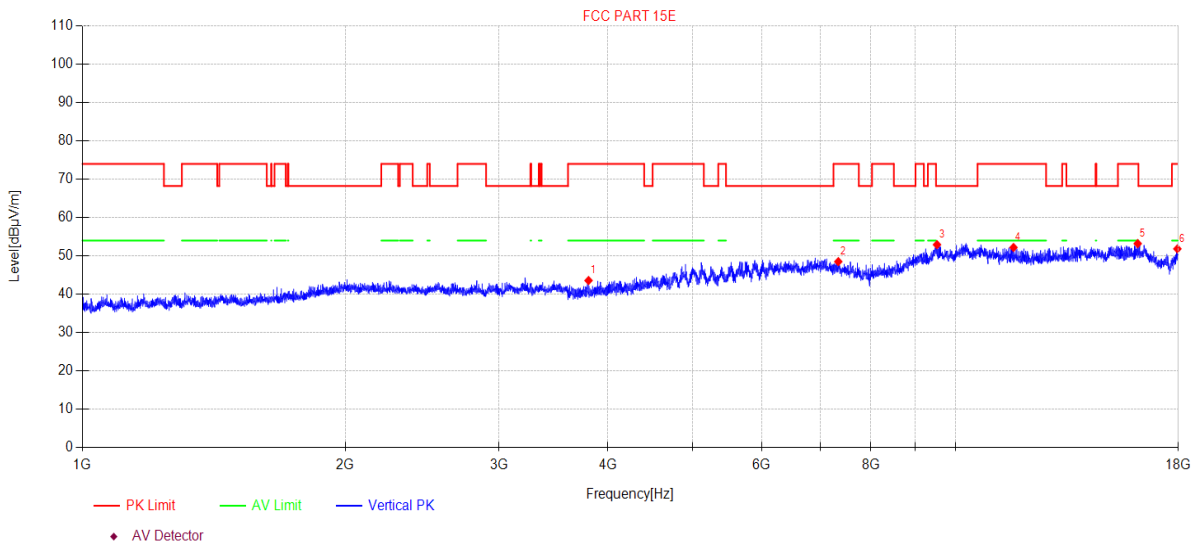

Suspected Data List										
N O.	Freq. [MHz]	Reading [dBµV/m]	Cable loss [dB]	Antenna Factor [dB]	AMP [dB]	Level [dBµV/m]	Limit [dBµV/m]	Margin [dB]	Detector	Polarity
1	3799.73	47.69	5.93	30.30	-40.33	43.59	74.00	30.41	PK	Vertical
2	7341.76	44.65	8.91	36.50	-41.55	48.51	74.00	25.49	PK	Vertical
3	9525.53	44.04	9.24	38.40	-38.75	52.93	68.20	15.27	PK	Vertical
4	11654.63	42.71	10.04	38.85	-39.40	52.20	74.00	21.80	PK	Vertical
5	16169.87	39.61	15.36	37.73	-39.50	53.20	74.00	20.80	PK	Vertical
6	17953.24	39.82	12.80	41.52	-42.30	51.84	74.00	22.16	PK	Vertical

Note:

1. Level = Reading + Cable loss + Antenna Factor + AMP
2. If Peak Result complies with AV limit, AV Result is deemed to comply with AV limit.
3. Test setup: RBW: 1 MHz, VBW: 3 MHz, Sweep time: auto.

TR-4-E-009 Radiated Emission Test Result

Test Date: 2023-09-07 **Tested By:** Bairong
EUT: Wireless Speaker **Model Number:** CITATION 500
Test Mode: TX Mode **Power Supply:** AC 120V/60Hz
Condition: Temp:21.1°C;Humi:68.5% **Test Site:** DDT 3# Chamber
File Path: d:\ts\2023 report data\Q23082222-2E CITATION 500\FCC ABOVE 1G 5GWIFI\19
Memo: 11N20MIMO 5720

Test Graph

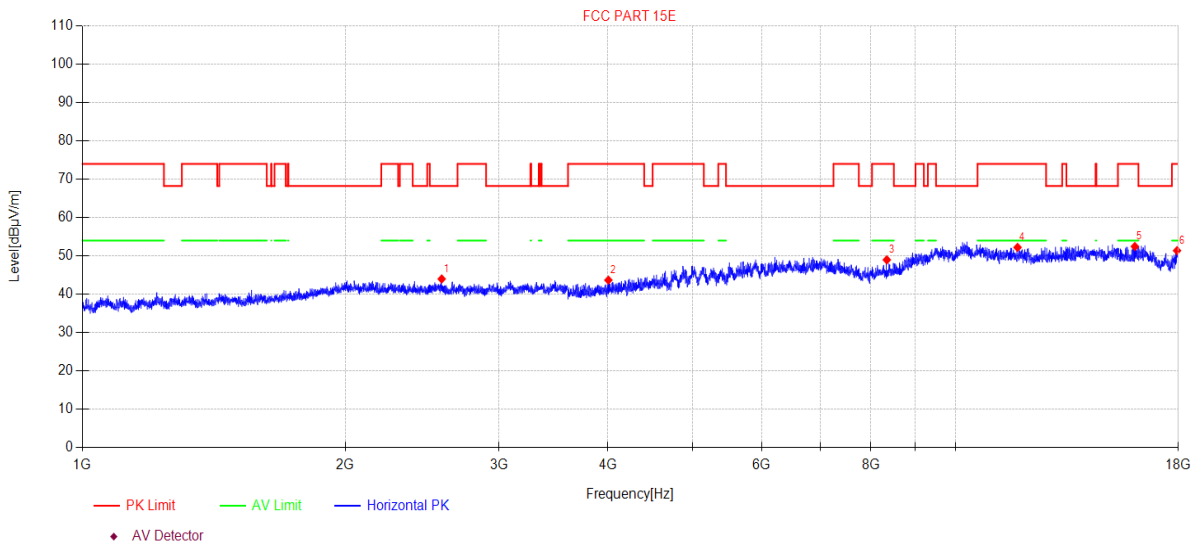

Suspected Data List										
N O.	Freq. [MHz]	Reading [dBµV/m]	Cable loss [dB]	Antenna Factor [dB]	AMP [dB]	Level [dBµV/m]	Limit [dBµV/m]	Margin [dB]	Detector	Polarity
1	2579.66	48.90	5.72	28.02	-38.65	43.99	68.20	24.21	PK	Horizontal
2	4003.78	47.34	6.09	30.71	-40.45	43.69	74.00	30.31	PK	Horizontal
3	8344.56	44.58	8.88	37.20	-41.68	48.98	74.00	25.02	PK	Horizontal
4	11779.92	42.74	10.14	38.80	-39.46	52.22	74.00	21.78	PK	Horizontal
5	16048.82	38.15	15.86	37.85	-39.40	52.46	74.00	21.54	PK	Horizontal
6	17937.68	39.42	12.79	41.43	-42.26	51.38	74.00	22.62	PK	Horizontal

Note:

1. Level = Reading + Cable loss + Antenna Factor + AMP
2. If Peak Result complies with AV limit, AV Result is deemed to comply with AV limit.
3. Test setup: RBW: 1 MHz, VBW: 3 MHz, Sweep time: auto.

TR-4-E-009 Radiated Emission Test Result

Test Date: 2023-09-07 **Tested By:** Bairong
EUT: Wireless Speaker **Model Number:** CITATION 500
Test Mode: TX Mode **Power Supply:** AC 120V/60Hz
Condition: Temp:21.1°C;Humi:68.5% **Test Site:** DDT 3# Chamber
File Path: d:\ts\2023 report data\Q23082222-2E CITATION 500\FCC ABOVE 1G 5GWIFI\20
Memo: 11N20MIMO 5720

Test Graph

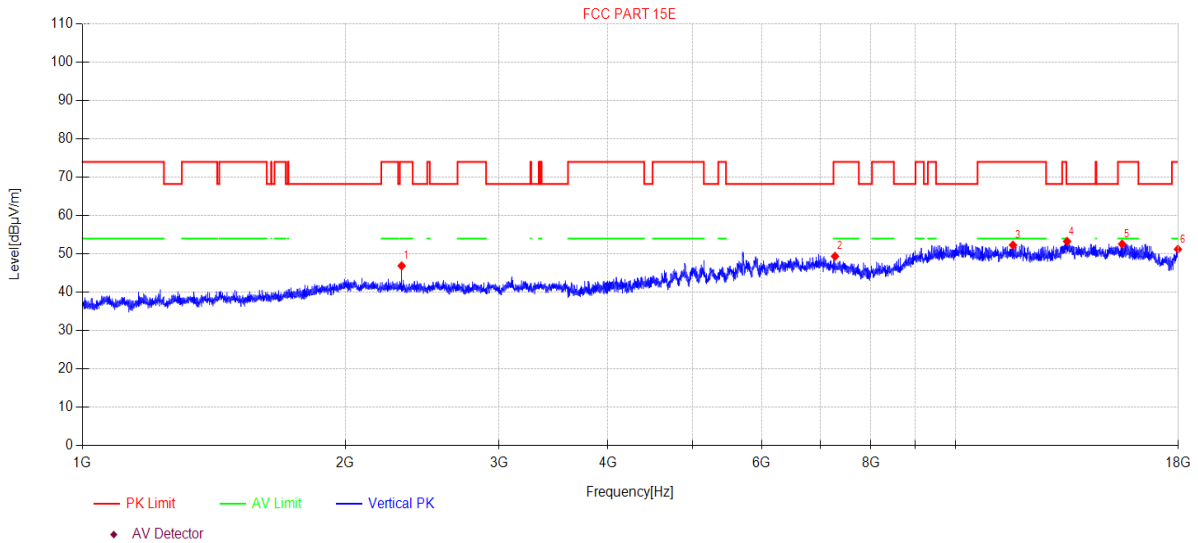

Suspected Data List										
N O.	Freq. [MHz]	Reading [dBµV/m]	Cable loss [dB]	Antenna Factor [dB]	AMP [dB]	Level [dBµV/m]	Limit [dBµV/m]	Margin [dB]	Detector	Polarity
1	2321.40	51.51	5.95	27.34	-37.92	46.88	74.00	27.12	PK	Vertical
2	7278.38	45.36	8.92	36.50	-41.40	49.38	74.00	24.62	PK	Vertical
3	11637.80	42.80	10.03	38.86	-39.39	52.30	74.00	21.70	PK	Vertical
4	13423.79	42.45	10.54	40.10	-39.82	53.27	68.20	14.93	PK	Vertical
5	15519.71	39.43	13.65	38.56	-39.07	52.57	74.00	21.43	PK	Vertical
6	17979.20	39.05	12.83	41.68	-42.35	51.21	74.00	22.79	PK	Vertical

Note:

1. Level = Reading + Cable loss + Antenna Factor + AMP
2. If Peak Result complies with AV limit, AV Result is deemed to comply with AV limit.
3. Test setup: RBW: 1 MHz, VBW: 3 MHz, Sweep time: auto.

TR-4-E-009 Radiated Emission Test Result

Test Date: 2023-09-07 **Tested By:** Bairong
EUT: Wireless Speaker **Model Number:** CITATION 500
Test Mode: TX Mode **Power Supply:** AC 120V/60Hz
Condition: Temp:21.1°C;Humi:68.5% **Test Site:** DDT 3# Chamber
File Path: d:\ts\2023 report data\Q23082222-2E CITATION 500\FCC ABOVE 1G 5.8GWIFI\1
Memo: 11N20MIMO 5745

Test Graph

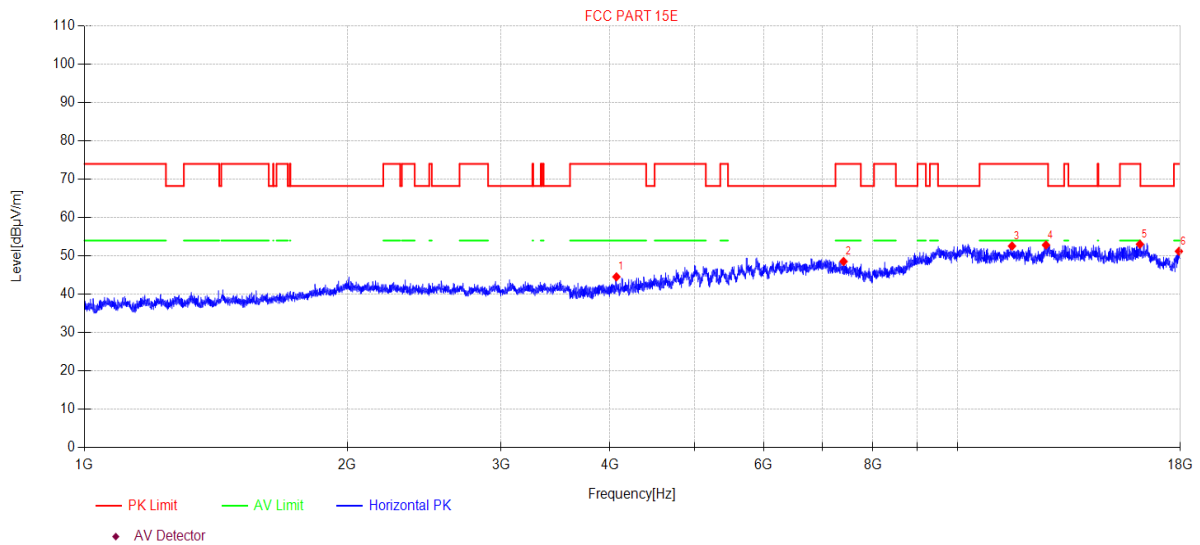

Suspected Data List										
N O.	Freq. [MHz]	Reading [dBµV/m]	Cable loss [dB]	Antenna Factor [dB]	AMP [dB]	Level [dBµV/m]	Limit [dBµV/m]	Margin [dB]	Detector	Polarity
1	4067.93	47.92	6.21	30.84	-40.42	44.55	74.00	29.45	PK	Horizontal
2	7405.70	44.86	8.90	36.50	-41.71	48.55	74.00	25.45	PK	Horizontal
3	11547.34	43.01	9.96	38.95	-39.35	52.57	74.00	21.43	PK	Horizontal
4	12629.65	43.03	10.36	39.26	-39.81	52.84	74.00	21.16	PK	Horizontal
5	16179.22	39.52	15.32	37.72	-39.51	53.05	74.00	20.95	PK	Horizontal
6	17932.50	39.28	12.78	41.39	-42.25	51.20	74.00	22.80	PK	Horizontal

Note:

1. Level = Reading + Cable loss + Antenna Factor + AMP
2. If Peak Result complies with AV limit, AV Result is deemed to comply with AV limit.
3. Test setup: RBW: 1 MHz, VBW: 3 MHz, Sweep time: auto.

TR-4-E-009 Radiated Emission Test Result

Test Date: 2023-09-07 **Tested By:** Bairong
EUT: Wireless Speaker **Model Number:** CITATION 500
Test Mode: TX Mode **Power Supply:** AC 120V/60Hz
Condition: Temp:21.1°C;Humi:68.5% **Test Site:** DDT 3# Chamber
File Path: d:\ts\2023 report data\Q23082222-2E CITATION 500\FCC ABOVE 1G 5.8GWIFI\2
Memo: 11N20MIMO 5745

Test Graph

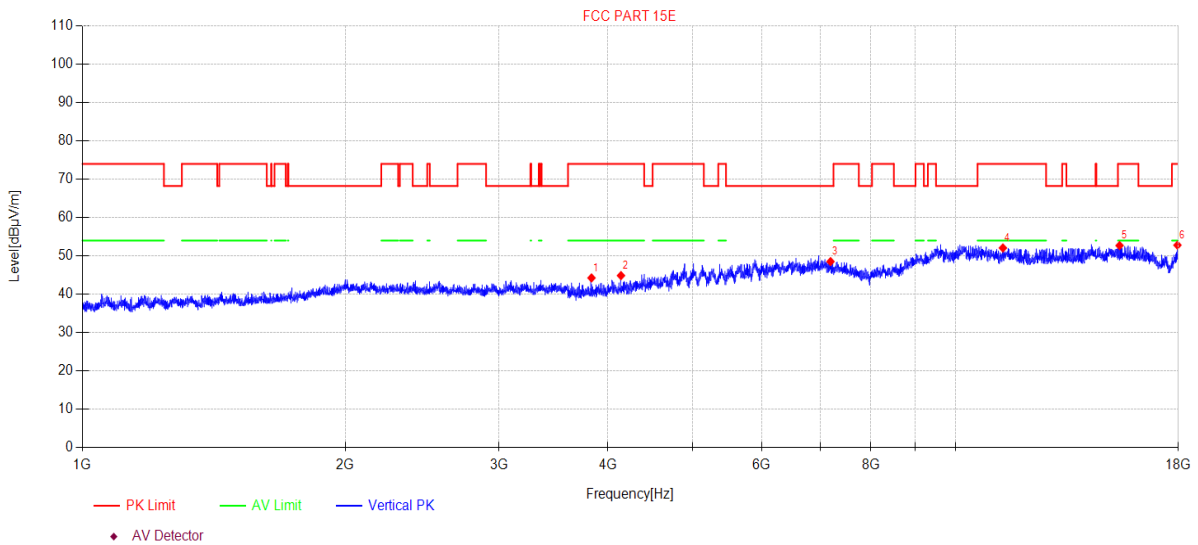

Suspected Data List										
N O.	Freq. [MHz]	Reading [dBµV/m]	Cable loss [dB]	Antenna Factor [dB]	AMP [dB]	Level [dBµV/m]	Limit [dBµV/m]	Margin [dB]	Detector	Polarity
1	3829.49	48.29	5.96	30.36	-40.35	44.26	74.00	29.74	PK	Vertical
2	4139.09	47.94	6.35	30.98	-40.40	44.87	74.00	29.13	PK	Vertical
3	7192.65	44.28	8.93	36.49	-41.18	48.52	68.20	19.68	PK	Vertical
4	11332.44	42.43	9.79	39.10	-39.25	52.07	74.00	21.93	PK	Vertical
5	15416.88	39.91	13.13	38.68	-39.01	52.71	74.00	21.29	PK	Vertical
6	17958.43	40.76	12.81	41.55	-42.31	52.81	74.00	21.19	PK	Vertical

Note:

1. Level = Reading + Cable loss + Antenna Factor + AMP
2. If Peak Result complies with AV limit, AV Result is deemed to comply with AV limit.
3. Test setup: RBW: 1 MHz, VBW: 3 MHz, Sweep time: auto.

TR-4-E-009 Radiated Emission Test Result

Test Date: 2023-09-07 **Tested By:** Bairong
EUT: Wireless Speaker **Model Number:** CITATION 500
Test Mode: TX Mode **Power Supply:** AC 120V/60Hz
Condition: Temp:21.1°C;Humi:68.5% **Test Site:** DDT 3# Chamber
File Path: d:\ts\2023 report data\Q23082222-2E CITATION 500\FCC ABOVE 1G 5.8GWIFI\3
Memo: 11N20MIMO 5785

Test Graph

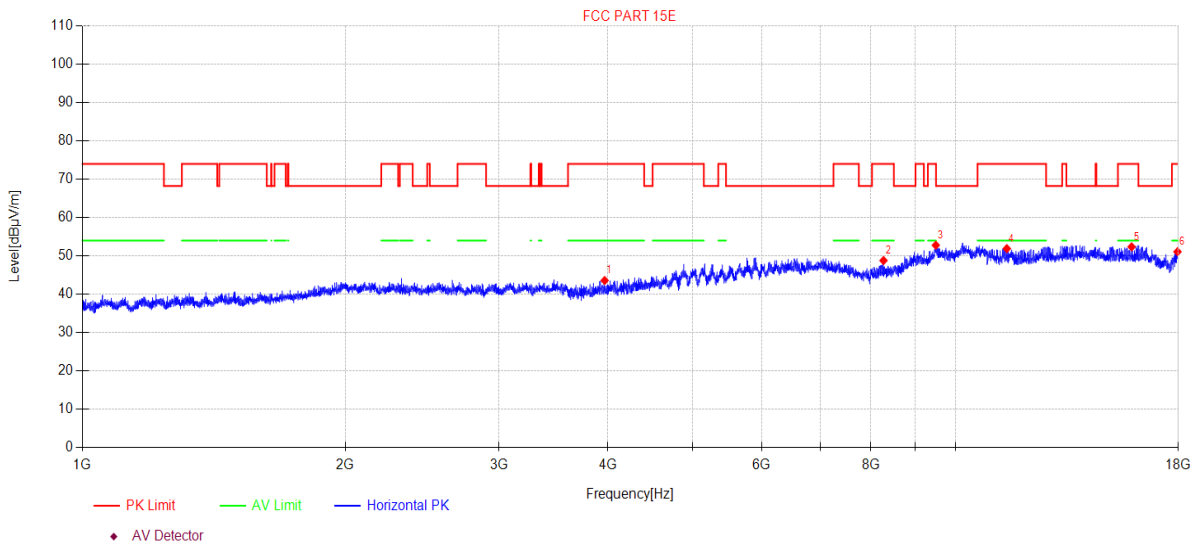

Suspected Data List										
N O.	Freq. [MHz]	Reading [dBµV/m]	Cable loss [dB]	Antenna Factor [dB]	AMP [dB]	Level [dBµV/m]	Limit [dBµV/m]	Margin [dB]	Detector	Polarity
1	3964.63	47.35	6.05	30.63	-40.43	43.60	74.00	30.40	PK	Horizontal
2	8272.52	44.78	8.87	37.15	-42.00	48.80	74.00	25.20	PK	Horizontal
3	9495.30	43.91	9.23	38.40	-38.76	52.78	74.00	21.22	PK	Horizontal
4	11450.96	42.28	9.88	39.05	-39.30	51.91	74.00	22.09	PK	Horizontal
5	15914.88	37.97	15.64	38.07	-39.31	52.37	74.00	21.63	PK	Horizontal
6	17958.43	39.03	12.81	41.55	-42.31	51.08	74.00	22.92	PK	Horizontal

Note:

1. Level = Reading + Cable loss + Antenna Factor + AMP
2. If Peak Result complies with AV limit, AV Result is deemed to comply with AV limit.
3. Test setup: RBW: 1 MHz, VBW: 3 MHz, Sweep time: auto.

TR-4-E-009 Radiated Emission Test Result

Test Date: 2023-09-07 **Tested By:** Bairong
EUT: Wireless Speaker **Model Number:** CITATION 500
Test Mode: TX Mode **Power Supply:** AC 120V/60Hz
Condition: Temp:21.1°C;Humi:68.5% **Test Site:** DDT 3# Chamber
File Path: d:\ts\2023 report data\Q23082222-2E CITATION 500\FCC ABOVE 1G 5.8GWIFI\4
Memo: 11N20MIMO 5785

Test Graph

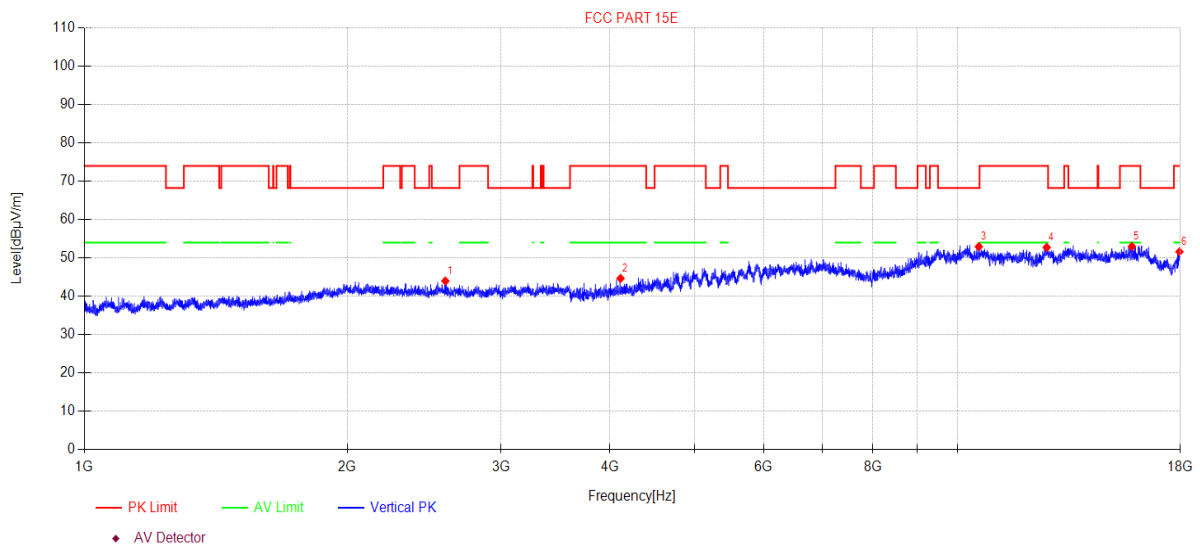

Suspected Data List										
N O.	Freq. [MHz]	Reading [dBµV/m]	Cable loss [dB]	Antenna Factor [dB]	AMP [dB]	Level [dBµV/m]	Limit [dBµV/m]	Margin [dB]	Detector	Polarity
1	2590.87	48.89	5.71	28.06	-38.68	43.98	68.20	24.22	PK	Vertical
2	4112.86	47.83	6.30	30.93	-40.41	44.65	74.00	29.35	PK	Vertical
3	10579.15	43.42	9.48	38.98	-38.93	52.95	68.20	15.25	PK	Vertical
4	12655.23	42.89	10.36	39.31	-39.82	52.74	74.00	21.26	PK	Vertical
5	15841.45	38.81	15.27	38.16	-39.26	52.98	74.00	21.02	PK	Vertical
6	17958.43	39.55	12.81	41.55	-42.31	51.60	74.00	22.40	PK	Vertical

Note:

1. Level = Reading + Cable loss + Antenna Factor + AMP
2. If Peak Result complies with AV limit, AV Result is deemed to comply with AV limit.
3. Test setup: RBW: 1 MHz, VBW: 3 MHz, Sweep time: auto.

TR-4-E-009 Radiated Emission Test Result

Test Date: 2023-09-07 **Tested By:** Bairong
EUT: Wireless Speaker **Model Number:** CITATION 500
Test Mode: TX Mode **Power Supply:** AC 120V/60Hz
Condition: Temp:21.1°C;Humi:68.5% **Test Site:** DDT 3# Chamber
File Path: d:\ts\2023 report data\Q23082222-2E CITATION 500\FCC ABOVE 1G 5.8GWIFI\5
Memo: 11N20MIMO 5825

Test Graph

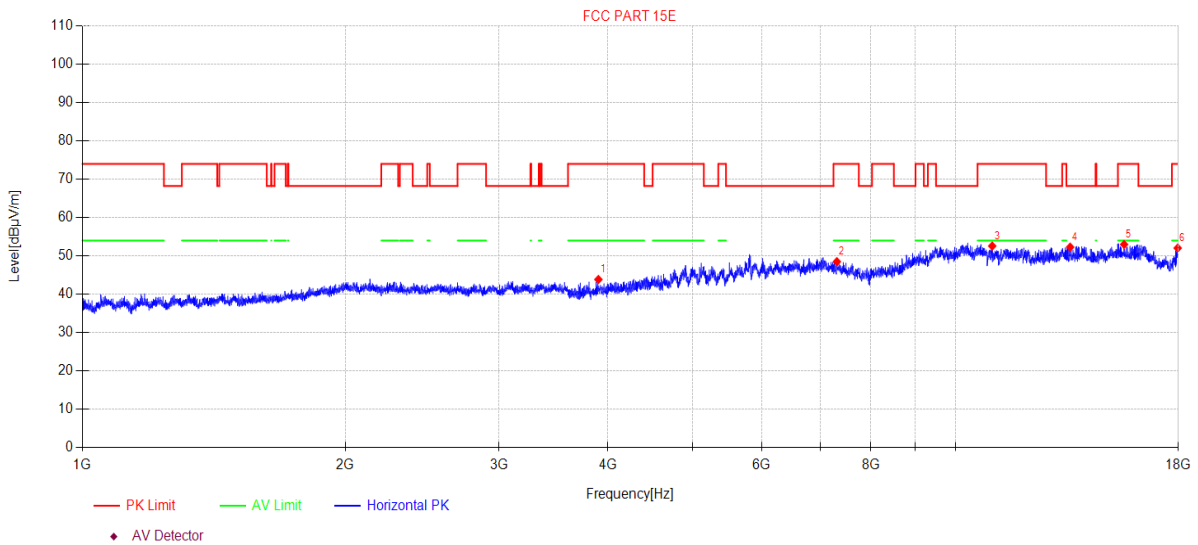

Suspected Data List										
N O.	Freq. [MHz]	Reading [dBµV/m]	Cable loss [dB]	Antenna Factor [dB]	AMP [dB]	Level [dBµV/m]	Limit [dBµV/m]	Margin [dB]	Detector	Polarity
1	3899.86	47.74	6.01	30.50	-40.39	43.86	74.00	30.14	PK	Horizontal
2	7314.23	44.58	8.91	36.50	-41.49	48.50	74.00	25.50	PK	Horizontal
3	11019.16	43.04	9.54	39.10	-39.10	52.58	74.00	21.42	PK	Horizontal
4	13532.86	41.39	10.58	40.10	-39.78	52.29	68.20	15.91	PK	Horizontal
5	15600.65	39.65	14.06	38.40	-39.12	52.99	74.00	21.01	PK	Horizontal
6	17968.81	39.94	12.82	41.61	-42.33	52.04	74.00	21.96	PK	Horizontal

Note:

1. Level = Reading + Cable loss + Antenna Factor + AMP
2. If Peak Result complies with AV limit, AV Result is deemed to comply with AV limit.
3. Test setup: RBW: 1 MHz, VBW: 3 MHz, Sweep time: auto.

TR-4-E-009 Radiated Emission Test Result

Test Date: 2023-09-07 **Tested By:** Bairong
EUT: Wireless Speaker **Model Number:** CITATION 500
Test Mode: TX Mode **Power Supply:** AC 120V/60Hz
Condition: Temp:21.1°C;Humi:68.5% **Test Site:** DDT 3# Chamber
File Path: d:\ts\2023 report data\Q23082222-2E CITATION 500\FCC ABOVE 1G 5.8GWIFI\6
Memo: 11N20MIMO 5825

Test Graph

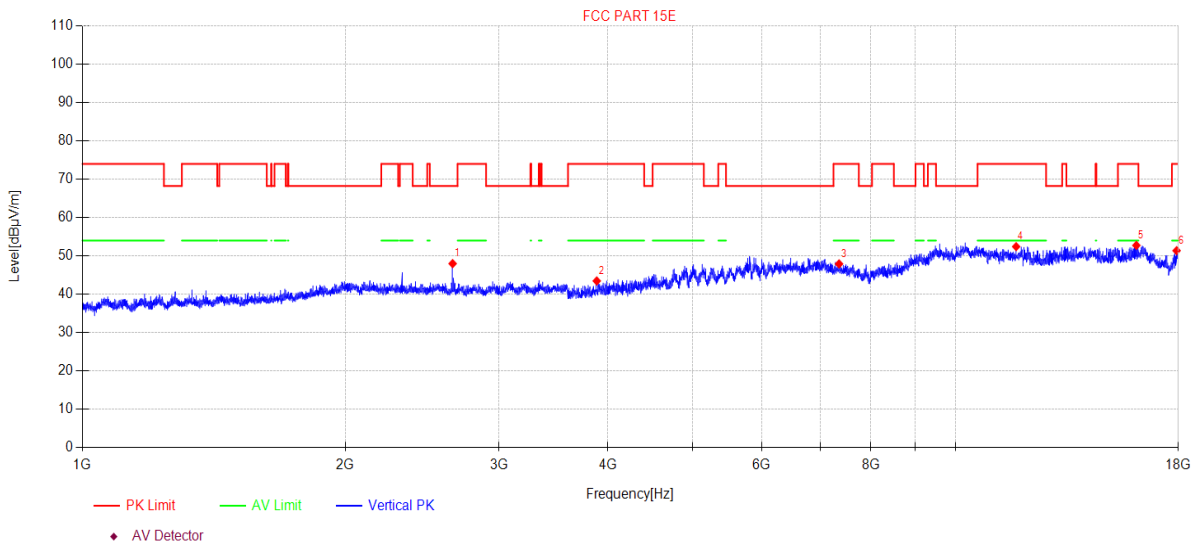

Suspected Data List										
N O.	Freq. [MHz]	Reading [dBµV/m]	Cable loss [dB]	Antenna Factor [dB]	AMP [dB]	Level [dBµV/m]	Limit [dBµV/m]	Margin [dB]	Detector	Polarity
1	2655.30	52.99	5.65	28.21	-38.86	47.99	68.20	20.21	PK	Vertical
2	3882.99	47.40	5.99	30.47	-40.38	43.48	74.00	30.52	PK	Vertical
3	7356.63	44.11	8.90	36.50	-41.59	47.92	74.00	26.08	PK	Vertical
4	11735.75	42.95	10.11	38.80	-39.44	52.42	74.00	21.58	PK	Vertical
5	16113.89	38.81	15.59	37.79	-39.45	52.74	74.00	21.26	PK	Vertical
6	17916.96	39.51	12.77	41.30	-42.21	51.37	74.00	22.63	PK	Vertical

Note:

1. Level = Reading + Cable loss + Antenna Factor + AMP
2. If Peak Result complies with AV limit, AV Result is deemed to comply with AV limit.
3. Test setup: RBW: 1 MHz, VBW: 3 MHz, Sweep time: auto.

13. Band Edge Compliance

13.1. Block diagram of test setup

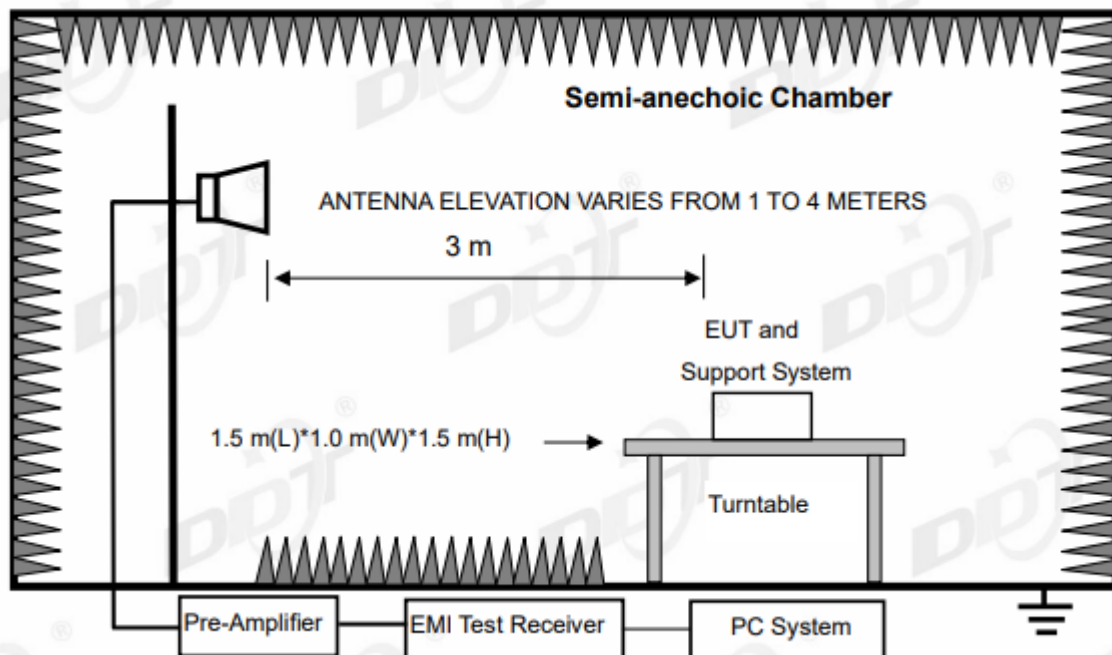

13.2. Limit

- (1) For transmitters operating in the 5.15-5.25 GHz band: All emissions outside of the 5.15-5.35 GHz band shall not exceed an e.i.r.p. of -27 dBm/MHz.
- (2) For transmitters operating in the 5.25-5.35 GHz band: All emissions outside of the 5.15-5.35 GHz band shall not exceed an e.i.r.p. of -27 dBm/MHz.
- (3) For transmitters operating in the 5.47-5.725 GHz band: All emissions outside of the 5.47-5.725 GHz band shall not exceed an e.i.r.p. of -27 dBm/MHz.
- (4) For transmitters operating solely in the 5.725-5.850 GHz band:
All emissions shall be limited to a level of -27 dBm/MHz at 75 MHz or more above or below the band edge increasing linearly to 10 dBm/MHz at 25 MHz above or below the band edge, and from 25 MHz above or below the band edge increasing linearly to a level of 15.6 dBm/MHz at 5 MHz above or below the band edge, and from 5 MHz above or below the band edge increasing linearly to a level of 27 dBm/MHz at the band edge.

13.3. Test Procedure

Same with Emissions in Restricted Frequency Bands except change investigated frequency range from 5.15-5.25 GHz, 5250-5350 GHz, 5470-5725 GHz, 5.725-5.85 GHz.

Remark: All restriction band have been tested, and only the worst case is shown in report.

13.4. Test result

Pass. (See below detailed test result)

Note: As specified in 15.407(b), emissions above 1000 MHz that are outside of the restricted bands are subject to a peak emission limit of -27 dBm/MHz. However, out-of-band emission that complies with both the average and peak limits of 15.209 is not required to satisfy the -27 dBm/MHz peak emission limit

Note2: 11a, 11n20, n40 and 11ac80 mode all have been tested, only 11a mode of ANT 1, 11n20, n40, 11ac20, 11ac40 and 11ac80 mode of MIMO mode is worse case and reported.

TR-4-E-009 Radiated Emission Test Result

Test Date: 2023-09-07 **Tested By:** Bairong
EUT: Wireless Speaker **Model Number:** CITATION 500
Test Mode: TX Mode **Power Supply:** AC 120V/60Hz
Condition: Temp:21.1°C;Humi:68.5% **Test Site:** DDT 3# Chamber
File Path: d:\ts\2023 report data\Q23082222-2E CITATION 500\FCC ABOVE 1G 5GWIFI\21
Memo: 11A 5180

Test Graph

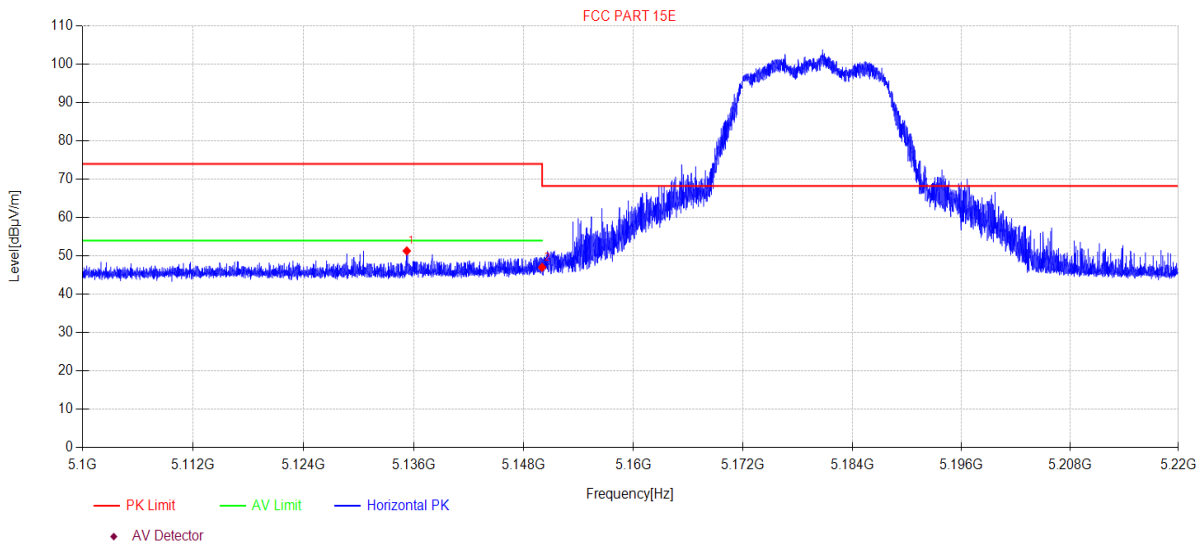

Suspected Data List										
N O.	Freq. [MHz]	Reading [dBµV/m]	Cable loss [dB]	Antenna Factor [dB]	AMP [dB]	Level [dBµV/m]	Limit [dBµV/m]	Margin [dB]	Detector	Polarity
1	5135.23	52.88	5.58	32.90	-40.06	51.30	74.00	22.70	PK	Horizontal
2	5150.00	48.60	5.59	32.90	-40.06	47.03	68.20	21.17	PK	Horizontal

Note:

1. Level = Reading + Cable loss + Antenna Factor + AMP
2. If Peak Result complies with AV limit, AV Result is deemed to comply with AV limit.
3. Test setup: RBW: 1 MHz, VBW: 3 MHz, Sweep time: auto.

TR-4-E-009 Radiated Emission Test Result

Test Date: 2023-09-07 **Tested By:** Bairong
EUT: Wireless Speaker **Model Number:** CITATION 500
Test Mode: TX Mode **Power Supply:** AC 120V/60Hz
Condition: Temp:21.1°C;Humi:68.5% **Test Site:** DDT 3# Chamber
File Path: d:\ts\2023 report data\Q23082222-2E CITATION 500\FCC ABOVE 1G 5GWIFI\22
Memo: 11A 5180

Test Graph

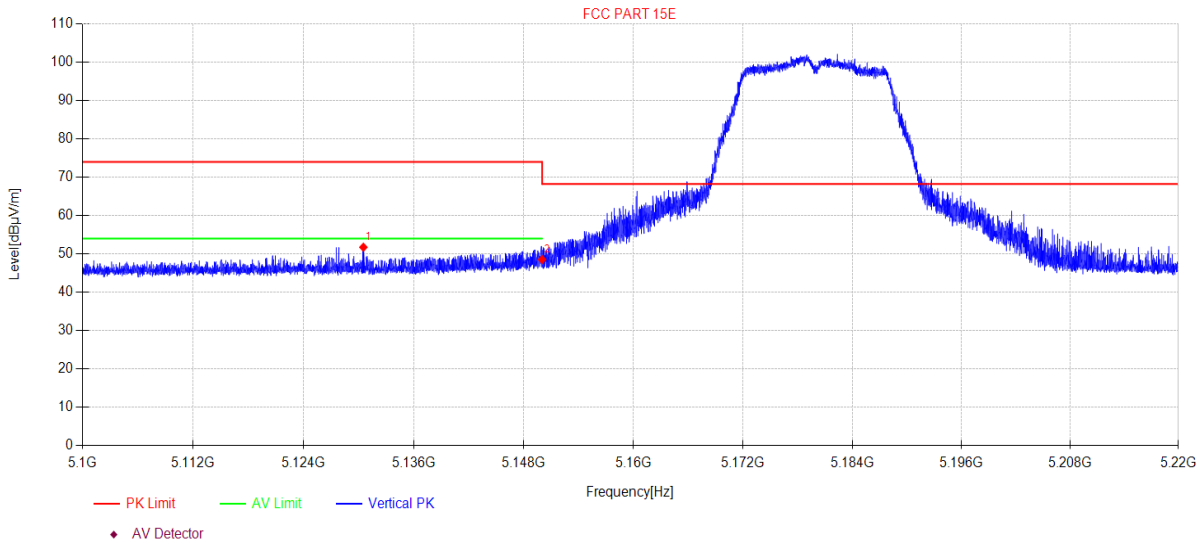

Suspected Data List										
N O.	Freq. [MHz]	Reading [dBµV/m]	Cable loss [dB]	Antenna Factor [dB]	AMP [dB]	Level [dBµV/m]	Limit [dBµV/m]	Margin [dB]	Detector	Polarity
1	5130.50	53.32	5.58	32.90	-40.06	51.74	74.00	22.26	PK	Vertical
2	5150.00	50.11	5.59	32.90	-40.06	48.54	68.20	19.66	PK	Vertical

Note:

1. Level = Reading + Cable loss + Antenna Factor + AMP
2. If Peak Result complies with AV limit, AV Result is deemed to comply with AV limit.
3. Test setup: RBW: 1 MHz, VBW: 3 MHz, Sweep time: auto.

TR-4-E-009 Radiated Emission Test Result

Test Date: 2023-09-07 **Tested By:** Bairong
EUT: Wireless Speaker **Model Number:** CITATION 500
Test Mode: TX Mode **Power Supply:** AC 120V/60Hz
Condition: Temp:21.1°C;Humi:68.5% **Test Site:** DDT 3# Chamber
File Path: d:\ts\2023 report data\Q23082222-2E CITATION 500\FCC ABOVE 1G 5GWIFI\23
Memo: 11N20MIMO 5180

Test Graph

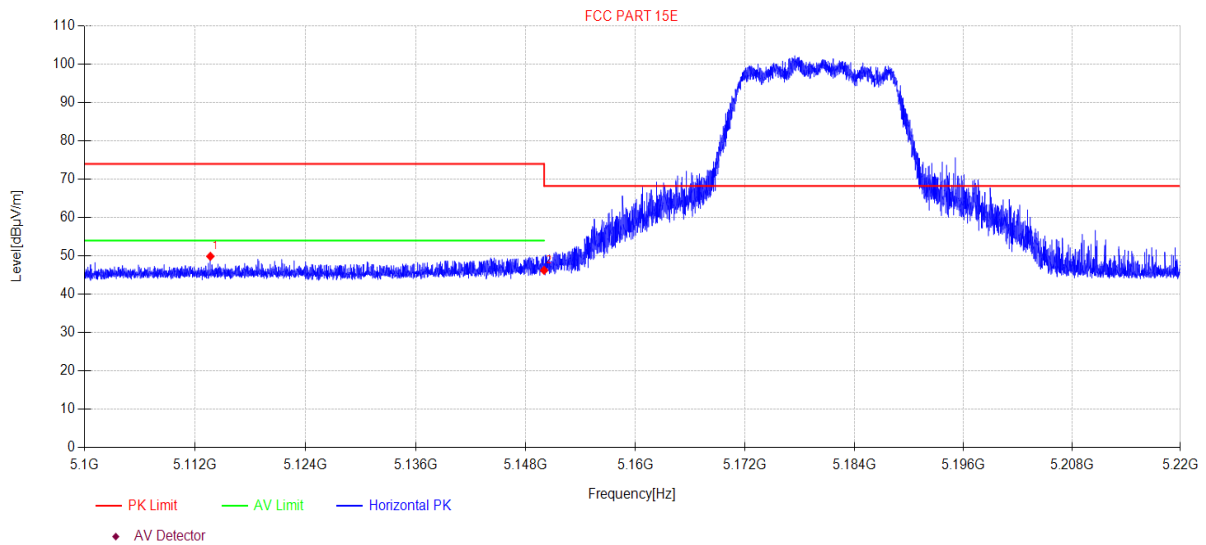

Suspected Data List										
N O.	Freq. [MHz]	Reading [dBµV/m]	Cable loss [dB]	Antenna Factor [dB]	AMP [dB]	Level [dBµV/m]	Limit [dBµV/m]	Margin [dB]	Detector	Polarity
1	5113.66	51.49	5.57	32.90	-40.07	49.89	74.00	24.11	PK	Horizontal
2	5150.00	47.82	5.59	32.90	-40.06	46.25	68.20	21.95	PK	Horizontal

Note:

- Level = Reading + Cable loss + Antenna Factor + AMP
- If Peak Result complies with AV limit, AV Result is deemed to comply with AV limit.
- Test setup: RBW: 1 MHz, VBW: 3 MHz, Sweep time: auto.

TR-4-E-009 Radiated Emission Test Result

Test Date: 2023-09-07 **Tested By:** Bairong
EUT: Wireless Speaker **Model Number:** CITATION 500
Test Mode: TX Mode **Power Supply:** AC 120V/60Hz
Condition: Temp:21.1°C;Humi:68.5% **Test Site:** DDT 3# Chamber
File Path: d:\ts\2023 report data\Q23082222-2E CITATION 500\FCC ABOVE 1G 5GWIFI\24
Memo: 11N20MIMO 5180

Test Graph

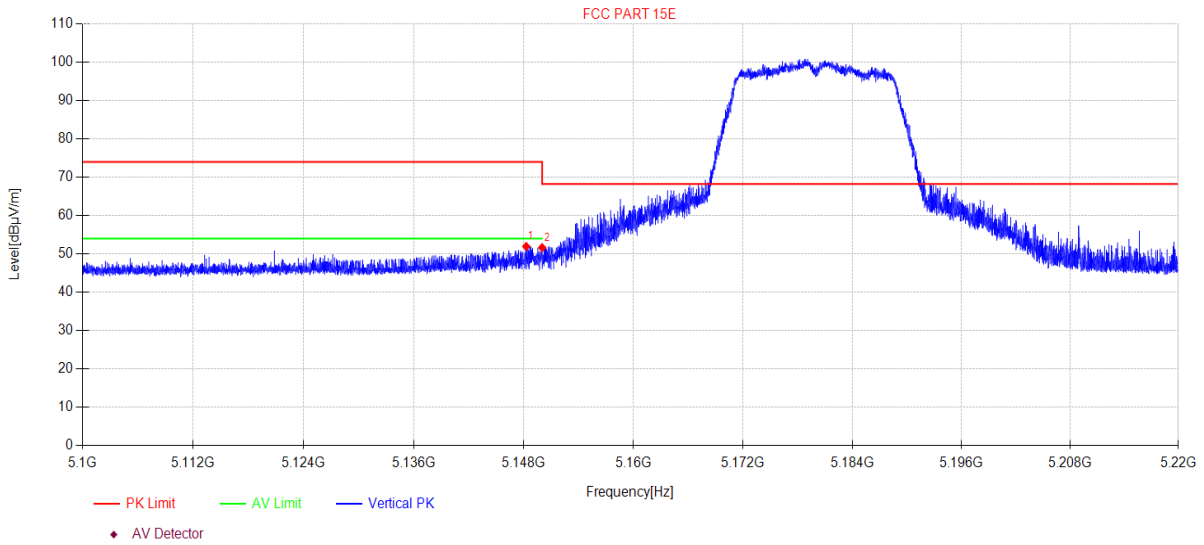

Suspected Data List										
N O.	Freq. [MHz]	Reading [dBµV/m]	Cable loss [dB]	Antenna Factor [dB]	AMP [dB]	Level [dBµV/m]	Limit [dBµV/m]	Margin [dB]	Detector	Polarity
1	5148.26	53.54	5.58	32.90	-40.06	51.96	74.00	22.04	PK	Vertical
2	5150.00	53.21	5.59	32.90	-40.06	51.64	68.20	16.56	PK	Vertical

Note:

1. Level = Reading + Cable loss + Antenna Factor + AMP
2. If Peak Result complies with AV limit, AV Result is deemed to comply with AV limit.
3. Test setup: RBW: 1 MHz, VBW: 3 MHz, Sweep time: auto.

TR-4-E-009 Radiated Emission Test Result

Test Date: 2023-09-07 **Tested By:** Bairong
EUT: Wireless Speaker **Model Number:** CITATION 500
Test Mode: TX Mode **Power Supply:** AC 120V/60Hz
Condition: Temp:21.1°C;Humi:68.5% **Test Site:** DDT 3# Chamber
File Path: d:\ts\2023 report data\Q23082222-2E CITATION 500\FCC ABOVE 1G 5GWIFI\25
Memo: 11AC20MIMO 5180

Test Graph

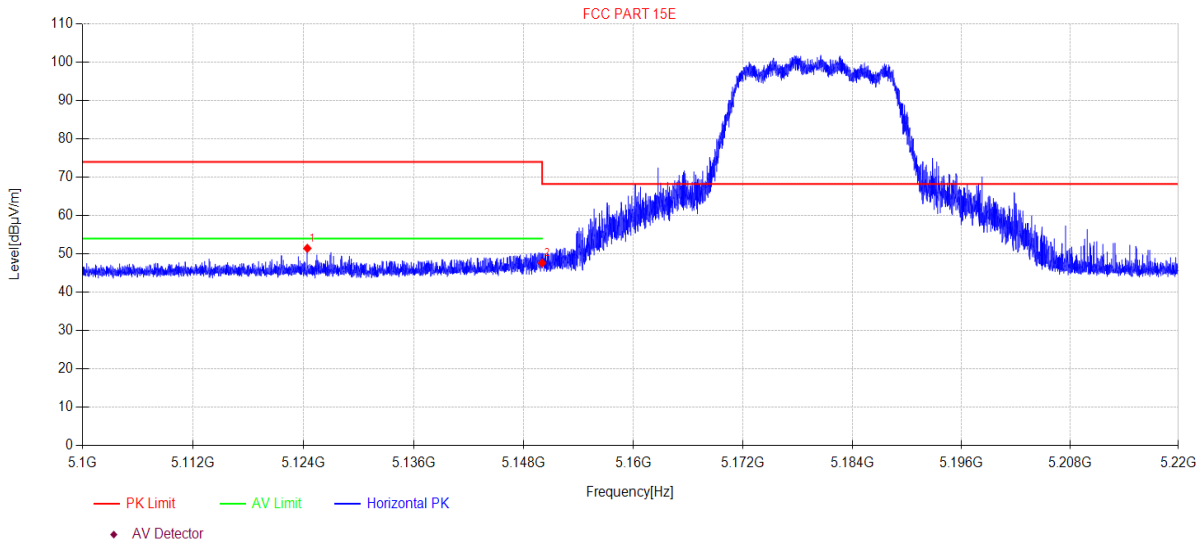

Suspected Data List										
N O.	Freq. [MHz]	Reading [dBµV/m]	Cable loss [dB]	Antenna Factor [dB]	AMP [dB]	Level [dBµV/m]	Limit [dBµV/m]	Margin [dB]	Detector	Polarity
1	5124.41	53.05	5.57	32.90	-40.06	51.46	74.00	22.54	PK	Horizontal
2	5150.00	49.21	5.59	32.90	-40.06	47.64	68.20	20.56	PK	Horizontal

Note:

1. Level = Reading + Cable loss + Antenna Factor + AMP
2. If Peak Result complies with AV limit, AV Result is deemed to comply with AV limit.
3. Test setup: RBW: 1 MHz, VBW: 3 MHz, Sweep time: auto.

TR-4-E-009 Radiated Emission Test Result

Test Date: 2023-09-07 **Tested By:** Bairong
EUT: Wireless Speaker **Model Number:** CITATION 500
Test Mode: TX Mode **Power Supply:** AC 120V/60Hz
Condition: Temp:21.1°C;Humi:68.5% **Test Site:** DDT 3# Chamber
File Path: d:\ts\2023 report data\Q23082222-2E CITATION 500\FCC ABOVE 1G 5GWIFI\126
Memo: 11AC20MIMO 5180

Test Graph

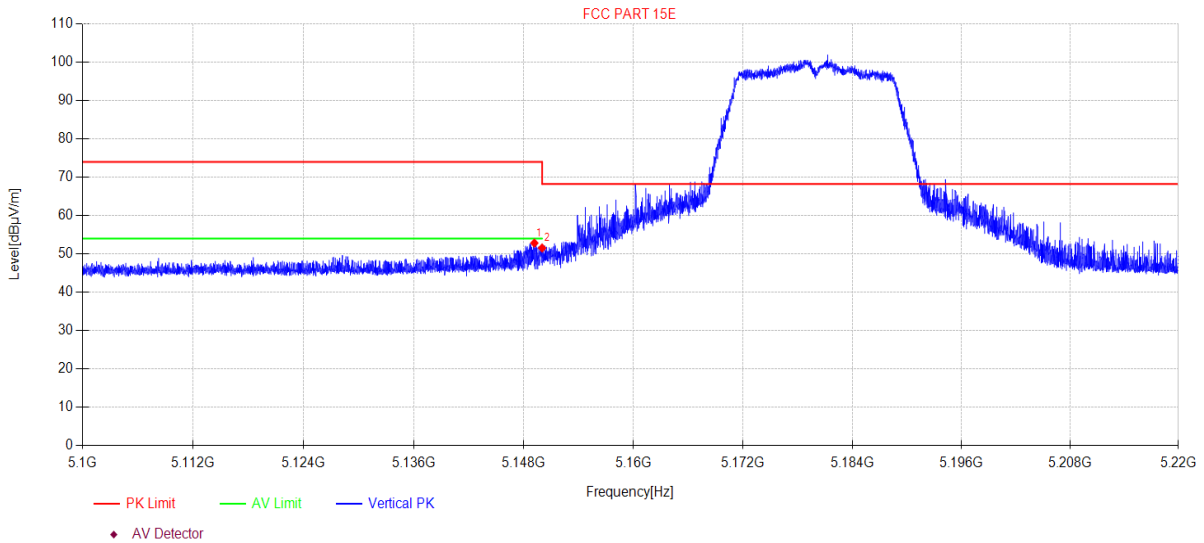

Suspected Data List										
N O.	Freq. [MHz]	Reading [dBµV/m]	Cable loss [dB]	Antenna Factor [dB]	AMP [dB]	Level [dBµV/m]	Limit [dBµV/m]	Margin [dB]	Detector	Polarity
1	5149.15	54.41	5.58	32.90	-40.06	52.83	74.00	21.17	PK	Vertical
2	5150.00	53.11	5.59	32.90	-40.06	51.54	68.20	16.66	PK	Vertical

Note:

1. Level = Reading + Cable loss + Antenna Factor + AMP
2. If Peak Result complies with AV limit, AV Result is deemed to comply with AV limit.
3. Test setup: RBW: 1 MHz, VBW: 3 MHz, Sweep time: auto.