

# FCC AND IC CERTIFICATION TEST REPORT

## FOR

<b>Applicant</b>	:	Harman International Industries, Incorporated
<b>Address</b>	:	8500 Balboa Boulevard, Northridge, CA 91329, UNITED STATES
<b>Equipment under Test</b>	:	Wireless Speaker
<b>Model No.</b>	:	ALLURE PORTABLE
<b>Trade Mark</b>	:	Harman Kardon
<b>FCC ID</b>	:	APIHKALLUREPORT
<b>IC</b>	:	6132A-ALLUREPORT
<b>Manufacturer</b>	:	Harman International Industries, Incorporated
<b>Address</b>	:	8500 Balboa Boulevard, Northridge, CA 91329, UNITED STATES

**Issued By: Dongguan Dongdian Testing Service Co., Ltd.**

**Add:** No. 17, Zongbu Road 2, Songshan Lake Sci&Tech, Industry Park, Dongguan City,  
Guangdong Province, China, 523808

**Tel:** +86-0769-89201699 **E-mail:** ddt@dgddt.com <http://www.dgddt.com>

# REPORT

## TABLE OF CONTENTS

	Test report declares.....	4
1.	Summary of test results .....	6
2.	General test information.....	7
2.1.	Description of EUT.....	7
2.2.	Accessories of EUT .....	7
2.3.	Assistant equipment used for test .....	7
2.4.	Block diagram of EUT configuration for test .....	8
2.5.	Deviations of test standard .....	8
2.6.	Test environment conditions .....	8
2.7.	Test laboratory.....	8
2.8.	Measurement uncertainty .....	9
3.	Equipment used during test.....	10
4.	6dB Bandwidth and 99% Bandwidth.....	11
4.1.	Block diagram of test setup .....	11
4.2.	Limits.....	11
4.3.	Test Procedure .....	11
4.4.	Test Result .....	11
4.5.	original test data .....	13
5.	Conducted peak Output Power.....	31
5.1.	Block diagram of test setup .....	31
5.2.	Limits.....	31
5.3.	Test Procedure .....	31
5.4.	Test Result .....	31
6.	Power Spectral Density.....	32
6.1.	Block diagram of test setup .....	32
6.2.	Limits.....	32
6.3.	Test Procedure .....	32
6.4.	Test Result .....	32
6.5.	original test data .....	33
6.6.	Band Edge and Spurious Emissions (Conducted).....	43
6.7.	Block diagram of test setup .....	43
6.8.	Limits.....	43
6.9.	Test Procedure .....	43
6.10.	Test Result .....	44
6.11.	original test data .....	44
7.	Radiated Spurious Emissions .....	69
7.1.	Block diagram of test setup .....	69

7.2.	Limit.....	70
7.3.	Test Procedure .....	71
7.4.	Test result.....	72
8.	Radiated Band Edge Compliance .....	77
8.1.	Block diagram of test setup .....	77
8.2.	Limit.....	77
8.3.	Test Procedure .....	77
8.4.	Test result.....	77
9.	Power Line Conducted Emission.....	90
9.1.	Block diagram of test setup .....	90
9.2.	Power Line Conducted Emission Limits(Class B).....	90
9.3.	Test Procedure .....	90
9.4.	Test Result .....	91
10.	Antenna Requirements.....	94
10.1.	Limit.....	94
10.2.	Result.....	94

## TEST REPORT DECLARE

<b>Applicant</b>	:	Harman International Industries, Incorporated
<b>Address</b>	:	8500 Balboa Boulevard, Northridge, CA 91329, UNITED STATES
<b>Equipment under Test</b>	:	Wireless Speaker
<b>Model No</b>	:	ALLURE PORTABLE
<b>Trade Mark</b>	:	Harman Kardon
<b>Manufacturer</b>	:	Harman International Industries, Incorporated
<b>Address</b>	:	8500 Balboa Boulevard, Northridge, CA 91329, UNITED STATES

**Test Standard Used:** FCC Rules and Regulations Part 15 Subpart C, RSS-247 Issue 2 February 2017.

**Test procedure used:** ANSI C63.10:2013, RSS-Gen Issue 4, Nov. 2014, KDB558074 D01 DTS Meas Guidance V03r02

**We Declare:**

The equipment described above is tested by Dongguan Dongdian Testing Service Co., Ltd and in the configuration tested the equipment complied with the standards specified above. The test results are contained in this test report and Dongguan Dongdian Testing Service Co., Ltd is assumed of full responsibility for the accuracy and completeness of these tests.

**After test and evaluation, our opinion is that the equipment provided for test compliance with the requirement of the above FCC&IC standards.**

<b>Report No:</b>	DDT-R17112903-1E15		
<b>Date of Receipt:</b>	Dec. 21, 2017	<b>Date of Test:</b>	Dec. 21, 2017 ~ Jan. 09, 2018

**Prepared By:**

*Sam Li*

**Sam Li/Engineer**

**Approved By:**



**Kevin Feng/EMC Manager**

Note: This report applies to above tested sample only. This report shall not be reproduced in parts without written approval of Dongguan Dongdian Testing Service Co., Ltd.

## Revision history

Rev.	Revisions	Issue Date	Revised By
---	Initial issue	Jan. 09, 2018	

## 1. Summary of test results

The EUT have been tested according to the applicable standards as referenced below.		
Description of Test Item	Standard	Results
6dB Bandwidth and 99% Bandwidth	FCC 15.247 (a) (2) RSS-247 Clause 5.2 (a)	PASS
Conducted Output Power	FCC 15.247 (b) (3) RSS-247 Clause 5.4 (e)	PASS
Power Spectral Density	FCC 15.247 (e) RSS-247 Clause 5.2 (b)	PASS
Band-edge and Spurious Emissions (Conducted)	FCC 15.247 (d) RSS-247 Clause 5.5	PASS
Radiated Spurious Emissions	FCC 15.247 (d) FCC 15.209 FCC 15.205 RSS-247 Clause 5.5 RSS-GEN Clause 8.9	PASS
Radiated Band Edge Compliance	FCC 15.247 (d) FCC 15.209 FCC 15.205 RSS-247 Clause 5.5 RSS-GEN Clause 8.9	PASS
Power Line Conducted Emission	FCC 15.207 RSS-GEN Clause 8.8	PASS
Antenna requirement	FCC 15.203 RSS-GEN Clause 8.3	PASS

## 2. General test information

### 2.1. Description of EUT

EUT* Name	: Wireless Speaker
Model Number	: ALLURE PORTABLE
EUT function description	: Please reference user manual of this device
Power supply	: DC 5V from external AC Adapter DC 3.7V built-in battery
Radio Technology	: IEEE802.11b/g/n
FCC Operation frequency	: IEEE 802.11b: 2412MHz—2462MHz IEEE 802.11g: 2412MHz—2462MHz IEEE 802.11n HT20: 2412MHz—2462MHz
Modulation	: IEEE 802.11b: DSSS(CCK,DQPSK,DBPSK) IEEE 802.11g: OFDM(64QAM, 16QAM, QPSK, BPSK) IEEE 802.11n HT2, HT40: OFDM (64QAM, 16QAM, QPSK,BPSK)
Transmitter rate	: IEEE 802.11b: 1, 2, 5.5, 11 Mbps IEEE 802.11g: 6, 9, 12, 18, 24, 36, 48, 54 Mbps IEEE 802.11n HT20: up to 150 Mbps
Antenna Type	: Integrated antenna 1: 2.4G band maximum PK gain 2.25dBi Integrated antenna 2: 2.4G band maximum PK gain 2.23dBi
Sample Type	: Series production

Note: EUT is the ab.of equipment under test.

Channle information							
CH	Frequency	CH	Frequency	CH	Frequency	CH	Frequency
1	2412	5	2432	9	2452	/	/
2	2417	6	2437	10	2457	/	/
3	2422	7	2442	11	2462	/	/
4	2427	8	2447	/	/	/	/

### 2.2. Accessories of EUT

Description of Accessories	Manufacturer	Model number	Serial No.	Other
AC Adapter	Harman	NF5V-2.3C-1U	N/A	Input: AC 100-240V -50/60Hz, 0.5A; Output: DC 5V, 2.3A
DC cable	Harman	N/A	N/A	Length: 1.0m
Charging Dock	Harman	N/A	N/A	N/A

### 2.3. Assistant equipment used for test

Assistant equipment	Manufacturer	Model number	EMC Compliance	SN
Notebook	DELL	Latitude D610	FCC DOC	00045-534-136-300
Network Cable	N/A	N/A	N/A	Length: 1.5m

## 2.4. Block diagram of EUT configuration for test



EUT was connected to control to provided by manufacturer which has a standard LAN PORT connector to connect to Notebook, and the Notebook will run a special test software “SecureCRT. EXE” provided by manufacturer to control EUT work in Continuous TX mode (>98% duty cycle), and select test channel, wireless mode and data rate.

Tested mode, channel, and data rate information				
Mode	Setting Tx Power	data rate (Mbps) (see Note)	Channel	Frequency (MHz)
IEEE 802.11b	/	11	LCH :CH1	2412
	/	11	MCH: CH6	2437
	/	11	HCH: CH11	2462
IEEE 802.11g	/	54	LCH :CH1	2412
	/	54	MCH: CH6	2437
	/	54	HCH: CH11	2462
IEEE 802.11n HT20	/	MCS 7	LCH :CH1	2412
	/	MCS 7	MCH: CH6	2437
	/	MCS 7	HCH: CH11	2462

Note: According exploratory test, EUT will have maximum output power in those data rate, so those data rate were used for all test.

## 2.5. Deviations of test standard

No Deviation

## 2.6. Test environment conditions

During the measurement the environmental conditions were within the listed ranges:

Temperature range:	21-25°C
Humidity range:	40-75%
Pressure range:	86-106kPa

## 2.7. Test laboratory

Dongguan Dongdian Testing Service Co., Ltd

Add: No. 17, Zongbu Road 2, Songshan Lake Sci&Tech, Industry Park, Dongguan City, Guangdong Province, China, 523808 Tel: +86-0769-89201699 <http://www.dgddt.com>

CNAS Accreditation No. L6451; A2LA Accreditation No. 3870.01

Designation Number: CN1182; Test Firm Registration Number: 540522

Industry Canada site registration number: 10288A-1



## 2.8. Measurement uncertainty

Test Item	Uncertainty
Bandwidth	1.1%
Peak Output Power(Conducted)( Spectrum analyzer)	0.86dB(10 MHz ≤ f < 3.6GHz);
	1.38dB(3.6GHz ≤ f < 8GHz)
Peak Output Power(Conducted)(Power Sensor)	0.74dB
Power Spectral Density	0.74dB(10 MHz ≤ f < 3.6GHz);
	1.38dB(3.6GHz ≤ f < 8GHz)
Frequencies Stability	6.7 x 10 <sup>-8</sup> (Antenna couple method)
	5.5 x 10 <sup>-8</sup> (Conducted method)
Conducted spurious emissions	0.86dB(10 MHz ≤ f < 3.6GHz);
	1.40dB(3.6GHz ≤ f < 8GHz)
	1.66dB(8GHz ≤ f < 22GHz)
Uncertainty for radio frequency (RBW<20KHz)	3×10 <sup>-8</sup>
Temperature	0.4℃
Humidity	2%
Uncertainty for Radiation Emission test (30MHz-1GHz)	4.70 dB (Antenna Polarize: V)
	4.84 dB (Antenna Polarize: H)
Uncertainty for Radiation Emission test (1GHz-40GHz)	4.10dB(1-6GHz)
	4.40dB (6GHz-18Gz)
	3.54dB (18GHz-26Gz)
	4.30dB (26GHz-40Gz)
Uncertainty for Power line conduction emission test	3.32dB (150KHz-30MHz)
Note: This uncertainty represents an expanded uncertainty expressed at approximately the 95% confidence level using a coverage factor of k=2.	

### 3. Equipment used during test

Equipment	Manufacturer	Model No.	Serial No.	Last Cal.	Cal. Interval
<b>RF Connected Test (Tonscent RF Measurement System)</b>					
Spectrum analyzer	R&S	FSU26	200071	Oct. 23, 2017	1Year
Wideband Radio Communication tester	R&S	CMW500	117491	Jun. 16, 2017	1 Year
Vector Signal Generator	Agilent	E8267D	US49060192	Oct. 23, 2017	1Year
Vector Signal Generator	Agilent	N5182A	MY48180737	Jun.16, 2017	1Year
Power Sensor	Agilent	U2021XA	MY55150010	Oct. 21, 2017	1Year
Power Sensor	Agilent	U2021XA	MY55150011	Oct. 23, 2017	1Year
DC Power Source	MATRIS	MPS-3005L-3	D813058W	Aug. 18, 2017	1Year
Attenuator	Mini-Circuits	BW-S10W2	101109	Aug. 18, 2017	1Year
RF Cable	Micable	C10-01-01-1	100309	Oct. 21, 2017	1Year
Temp&Humi Programmable	ZHIXIANG	ZXGDJS-150L	ZX170110-A	Oct. 21, 2017	1Year
Test Software	JS Tonscent	JS1120-3	Ver.2.7	N/A	N/A
<b>Radiated Emission Test Chamber 1#</b>					
EMI Test Receiver	R&S	ESU8	100316	Oct. 21 2017	1 Year
Spectrum analyzer	Agilent	E4447A	MY50180031	Jun. 16, 2017	1 Year
Trilog Broadband Antenna	Schwarzbeck	VULB9163	9163-462	Nov. 09, 2017	1 Year
Active Loop antenna	Schwarzbeck	FMZB-1519	1519-038	Oct. 17, 2017	1 Year
Double Ridged Horn Antenna	R&S	HF907	100276	Oct. 17, 2017	1 Year
Broad Band Horn Antenna	Schwarzbeck	BBHA 9170	790	Nov. 09,2017	1 Year
Pre-amplifier	A.H.	PAM-0118	360	Oct. 21, 2017	1 Year
Pre-amplifier	TERA-MW	TRLA-0040G35	101303	Oct. 21, 2017	1 Year
RF Cable	HUBSER	CP-X2+ CP-X1	W11.03+ W12.02	Oct. 21, 2017	1Year
RF Cable	N/A	SMAJ-SMAJ-1M+ SMAJ-SMAJ-11M	17070133+17070131	Nov. 08, 2017	1 Year
MI Cable	HUBSER	C10-01-01-1M	1091629	Oct. 21, 2017	1 Year
Test software	Audix	E3	V 6.11111b	N/A	N/A
<b>Power Line Conducted Emissions Test</b>					
Test Receiver	R&S	ESU8	100316	Oct. 21, 2017	1 Year
LISN 1	R&S	ENV216	101109	Oct. 21 2017	1 Year
LISN 2	R&S	ESH2-Z5	100309	Oct. 21 2017	1 Year
Pulse Limiter	R&S	ESH3-Z2	101242	Oct. 21 2017	1 Year
CE Cable 1	HUBSER	N/A	W10.01	Oct. 21 2017	1 Year
Test software	Audix	E3	V 6.11111b	N/A	N/A

## 4. 6dB Bandwidth and 99% Bandwidth

### 4.1. Block diagram of test setup

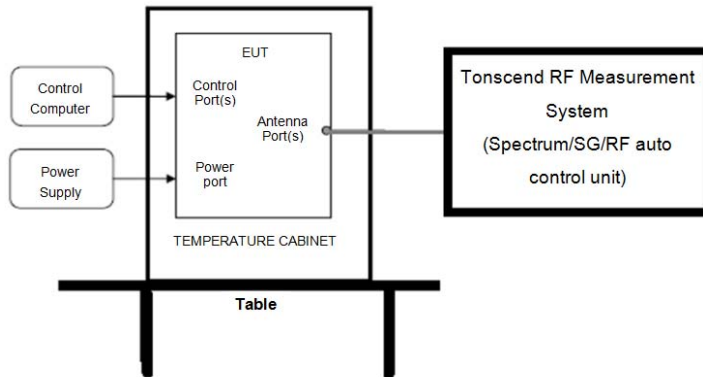

### 4.2. Limits

For direct sequence systems, the minimum 6dB bandwidth shall be at least 500 KHz

### 4.3. Test Procedure

- (1) Connect EUT's antenna output to spectrum analyzer by RF cable.
- (2) Set the spectrum analyzer as follows:
 

RBW:	100KHz
VBW:	300KHz
Detector Mode:	Peak
Sweep time:	auto
Trace mode	Max hold
- (3) Allow the trace to stabilize, measure the maximum width of the emission that is constrained by the frequencies associated with the two outermost amplitude points (upper and lower frequencies) that are attenuated by 6 dB relative to the maximum level measured in the fundamental emission.

### 4.4. Test Result

Test Mode	Test	Ant	6dB Bandwidth [MHz]	Limit	Verdict
11B	2412	Ant1	8.960	0.5	PASS
11B	2412	Ant2	8.840	0.5	PASS
11B	2437	Ant1	8.880	0.5	PASS
11B	2437	Ant2	8.520	0.5	PASS
11B	2462	Ant1	8.600	0.5	PASS
11B	2462	Ant2	9.360	0.5	PASS
11G	2412	Ant1	15.520	0.5	PASS
11G	2412	Ant2	15.840	0.5	PASS

11G	2437	Ant1	15.760	0.5	PASS
11G	2437	Ant2	15.840	0.5	PASS
11G	2462	Ant1	15.520	0.5	PASS
11G	2462	Ant2	16.360	0.5	PASS
11N20	2412	Ant1	17.080	0.5	PASS
11N20	2412	Ant2	17.760	0.5	PASS
11N20	2437	Ant1	17.480	0.5	PASS
11N20	2437	Ant2	17.720	0.5	PASS
11N20	2462	Ant1	17.320	0.5	PASS
11N20	2462	Ant2	17.720	0.5	PASS

Test Mode	Test	Ant	99% OBW [MHz]	Limit[MHz]	Verdict
11B	2412	Ant1	11.880	---	PASS
11B	2412	Ant2	12.040	---	PASS
11B	2437	Ant1	11.880	---	PASS
11B	2437	Ant2	11.960	---	PASS
11B	2462	Ant1	11.880	---	PASS
11B	2462	Ant2	12.000	---	PASS
11G	2412	Ant1	16.360	---	PASS
11G	2412	Ant2	16.400	---	PASS
11G	2437	Ant1	16.400	---	PASS
11G	2437	Ant2	16.440	---	PASS
11G	2462	Ant1	16.360	---	PASS
11G	2462	Ant2	16.440	---	PASS
11N20	2412	Ant1	17.640	---	PASS
11N20	2412	Ant2	17.640	---	PASS
11N20	2437	Ant1	17.640	---	PASS
11N20	2437	Ant2	17.640	---	PASS
11N20	2462	Ant1	17.640	---	PASS
11N20	2462	Ant2	17.680	---	PASS

### 4.5. original test data

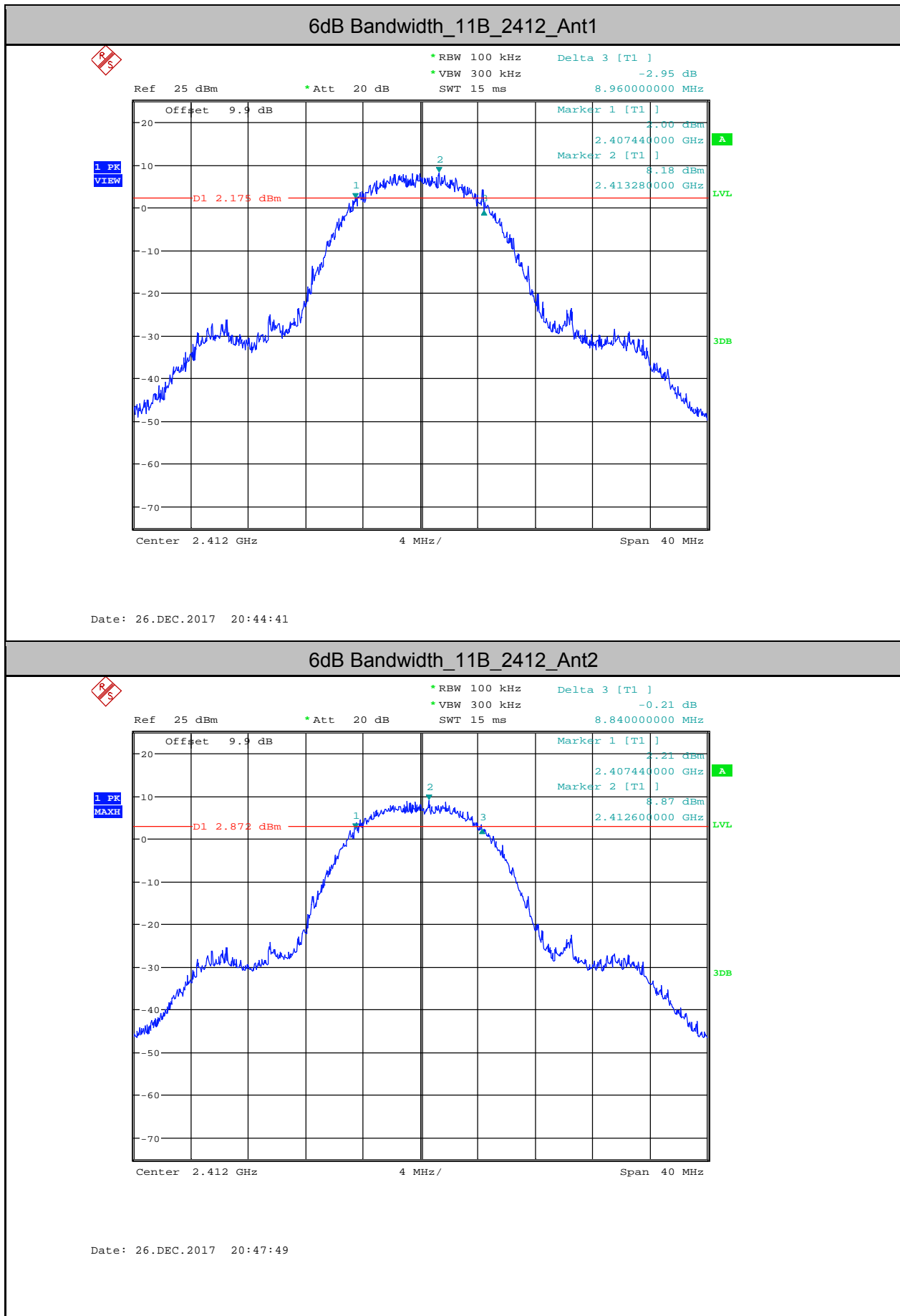

### 6dB Bandwidth\_11B\_2437\_Ant1

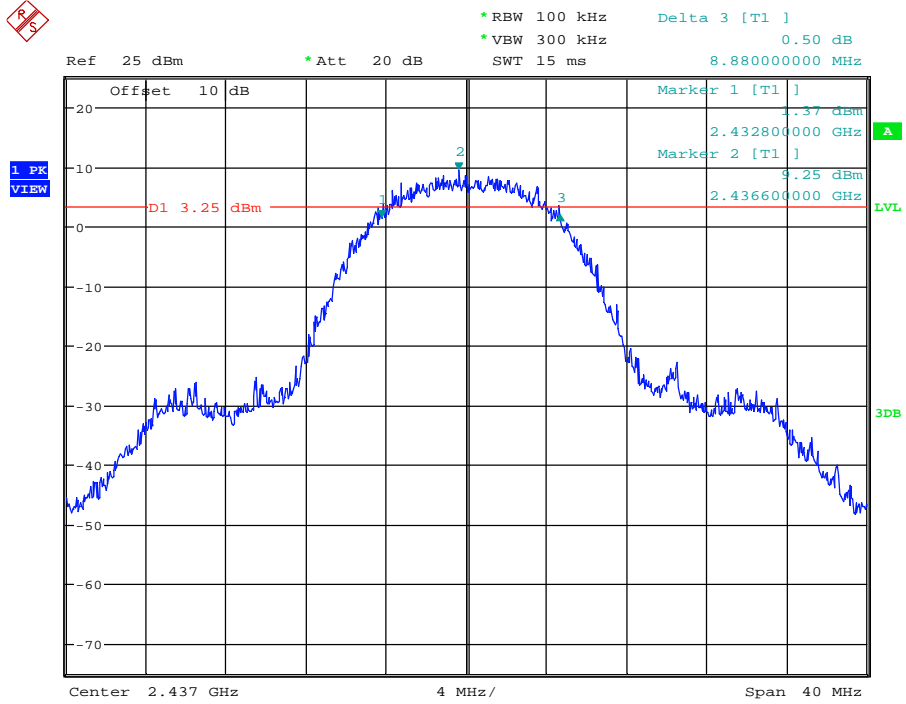

Date: 26.DEC.2017 20:56:22

### 6dB Bandwidth\_11B\_2437\_Ant2

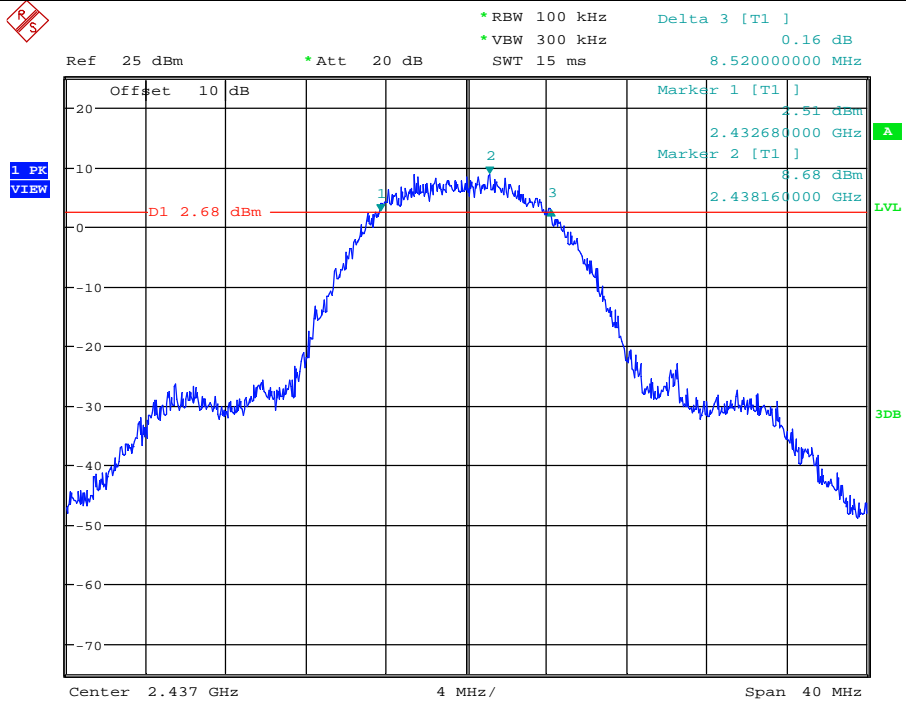

Date: 26.DEC.2017 21:23:29



### 6dB Bandwidth\_11G\_2412\_Ant1

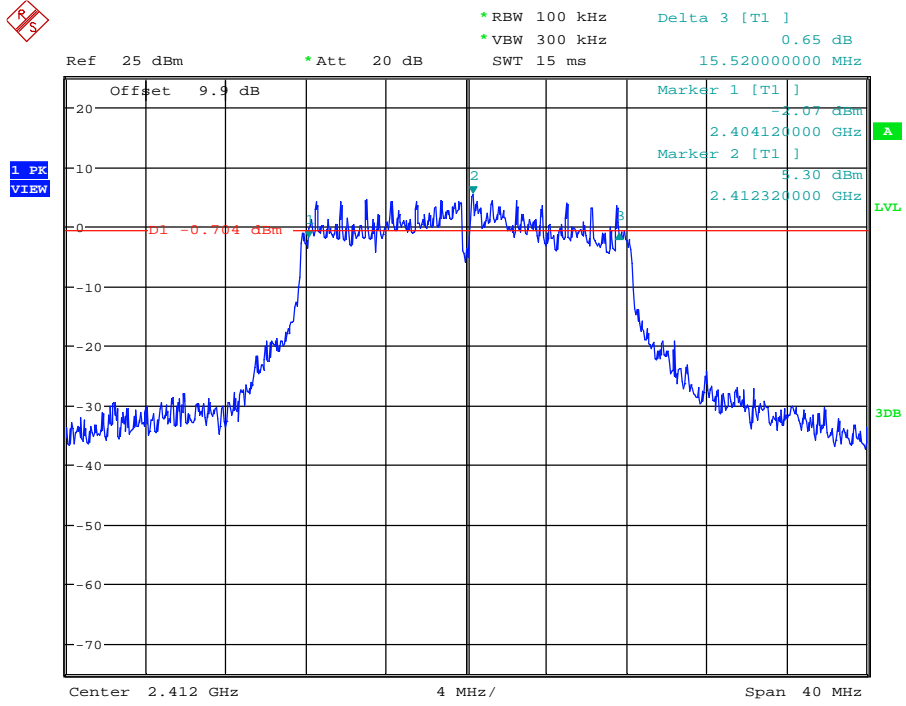

Date: 26.DEC.2017 21:01:16

### 6dB Bandwidth\_11G\_2412\_Ant2

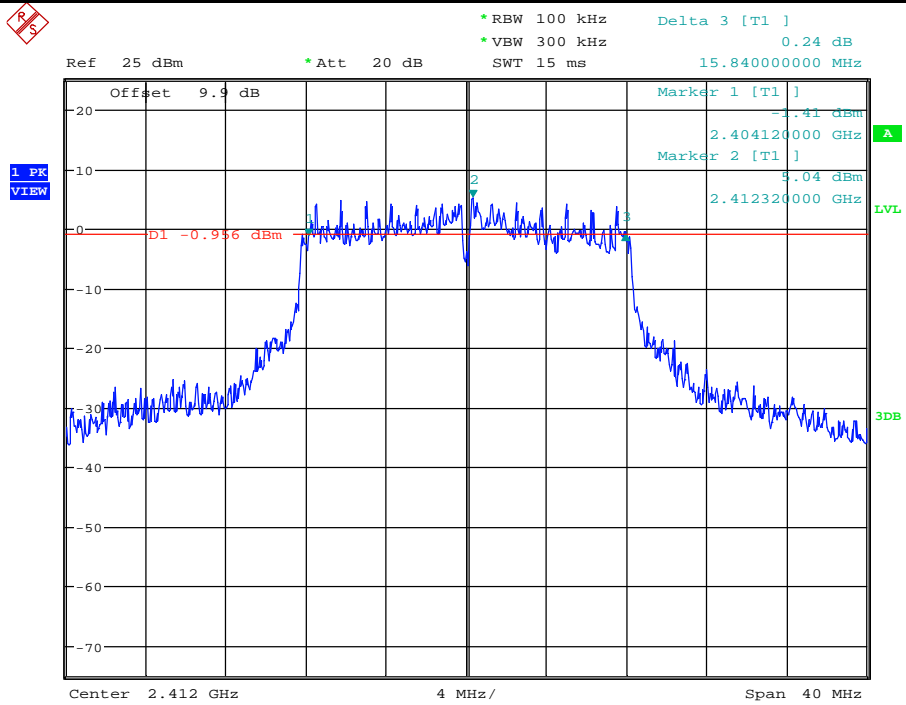

Date: 26.DEC.2017 21:28:15



### 6dB Bandwidth\_11G\_2437\_Ant1

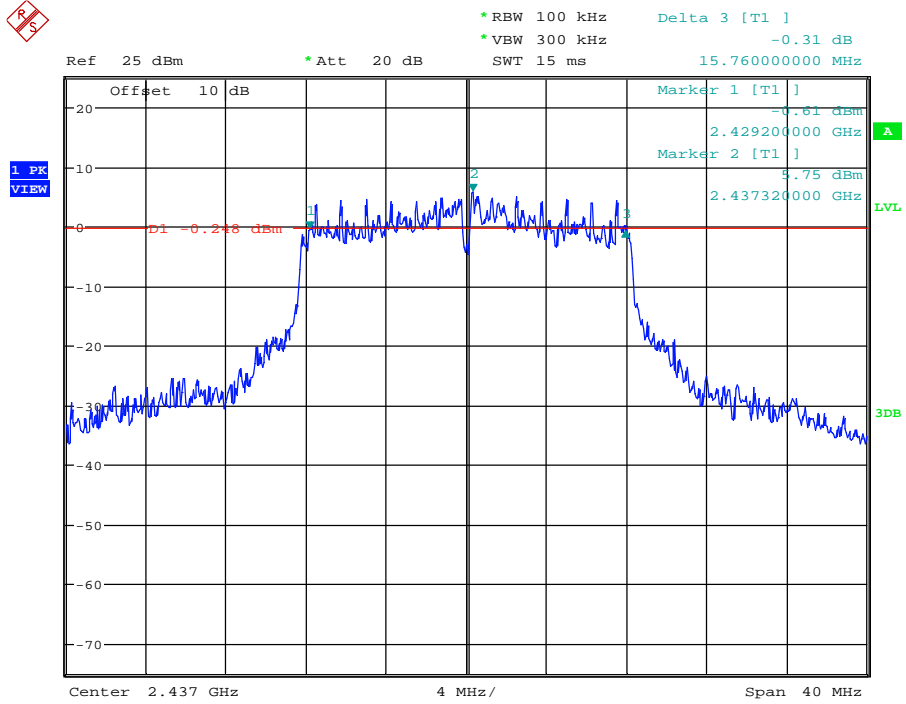

Date: 26.DEC.2017 21:06:45

### 6dB Bandwidth\_11G\_2437\_Ant2

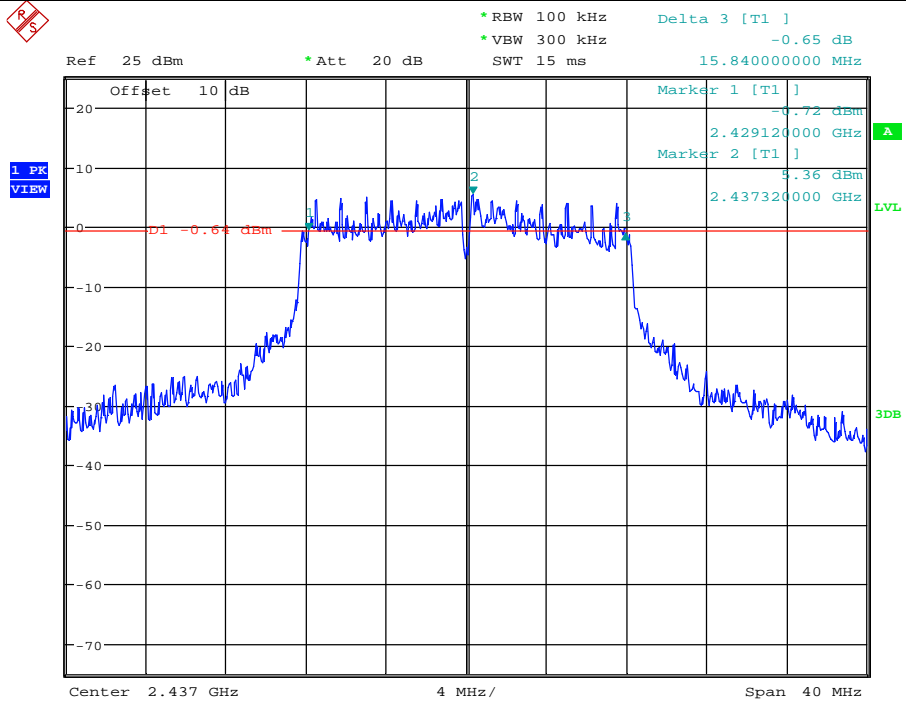

Date: 26.DEC.2017 21:30:59

### 6dB Bandwidth\_11G\_2462\_Ant1

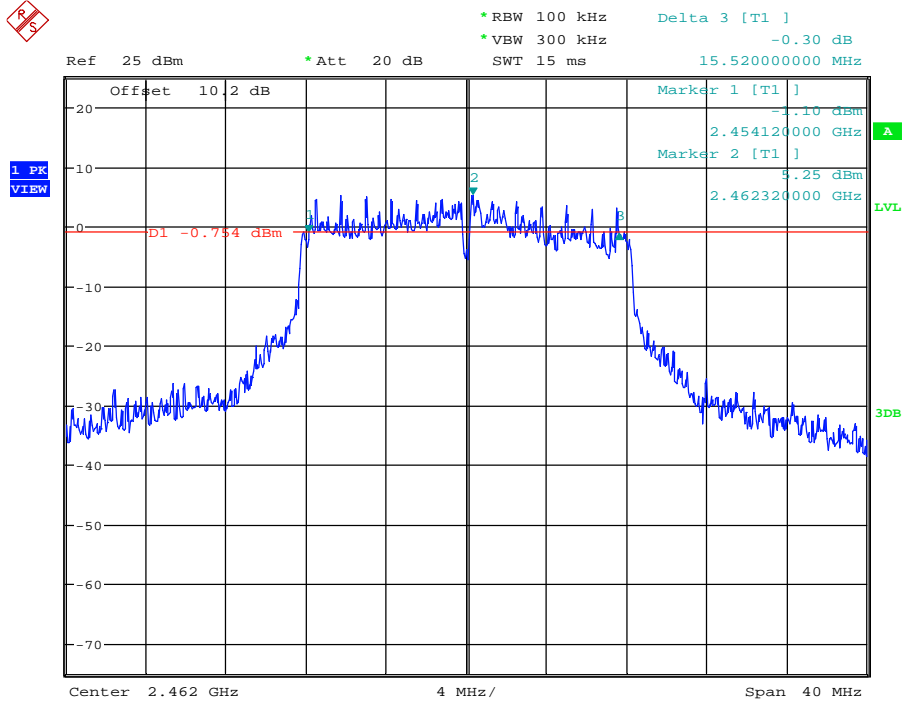

Date: 26.DEC.2017 21:08:46

### 6dB Bandwidth\_11G\_2462\_Ant2

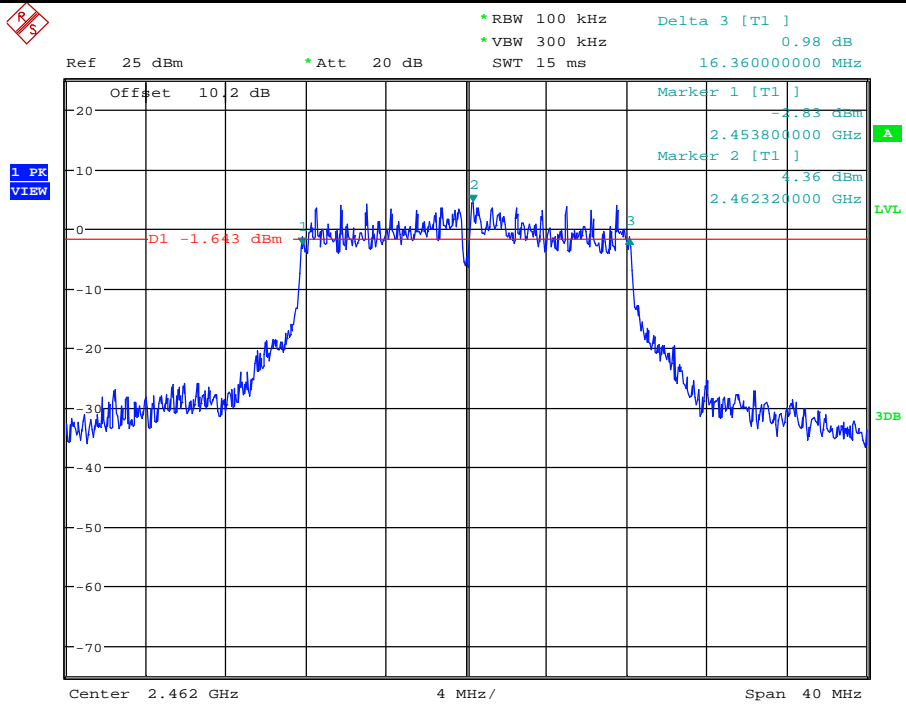

Date: 26.DEC.2017 21:33:57

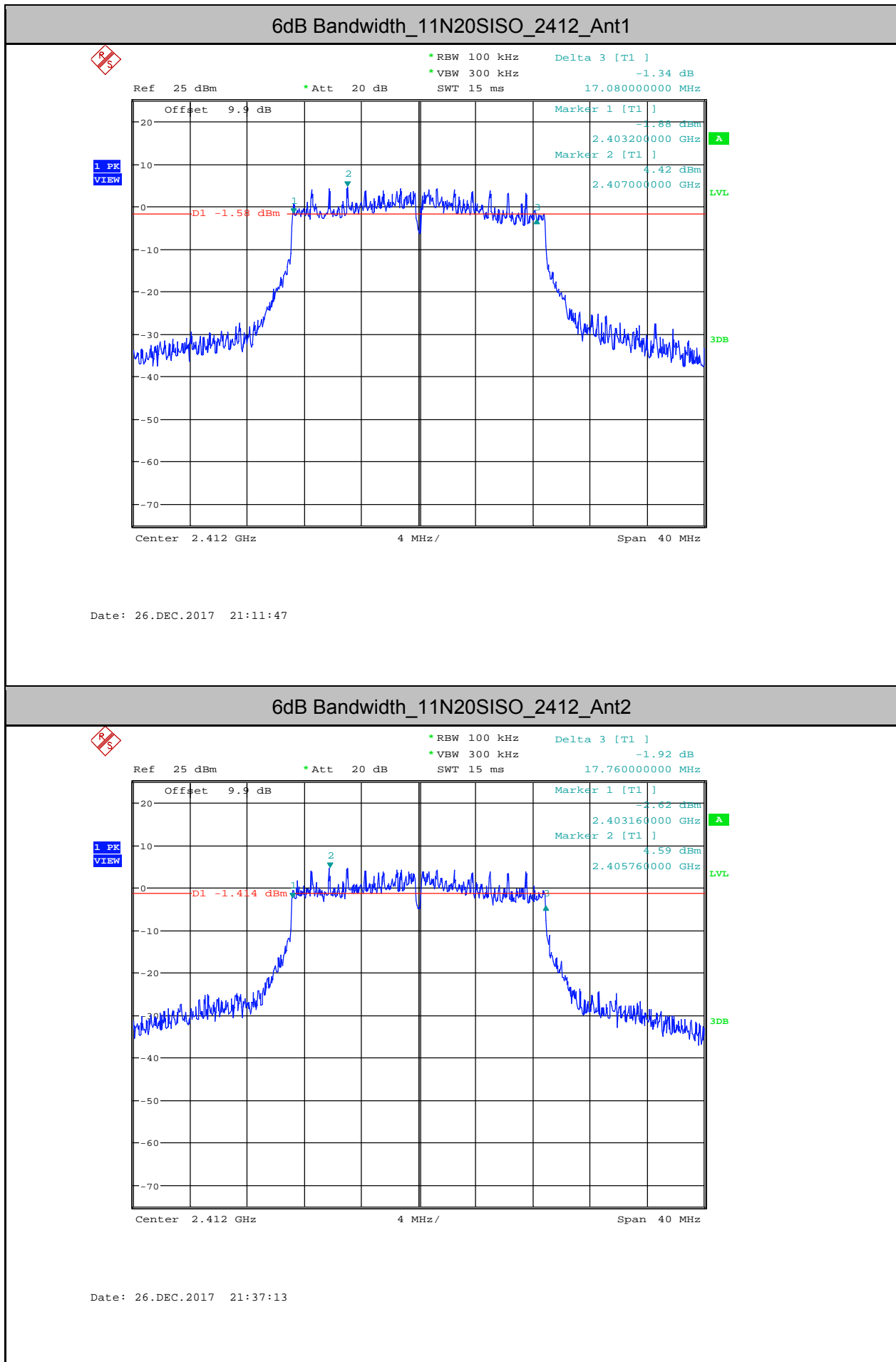

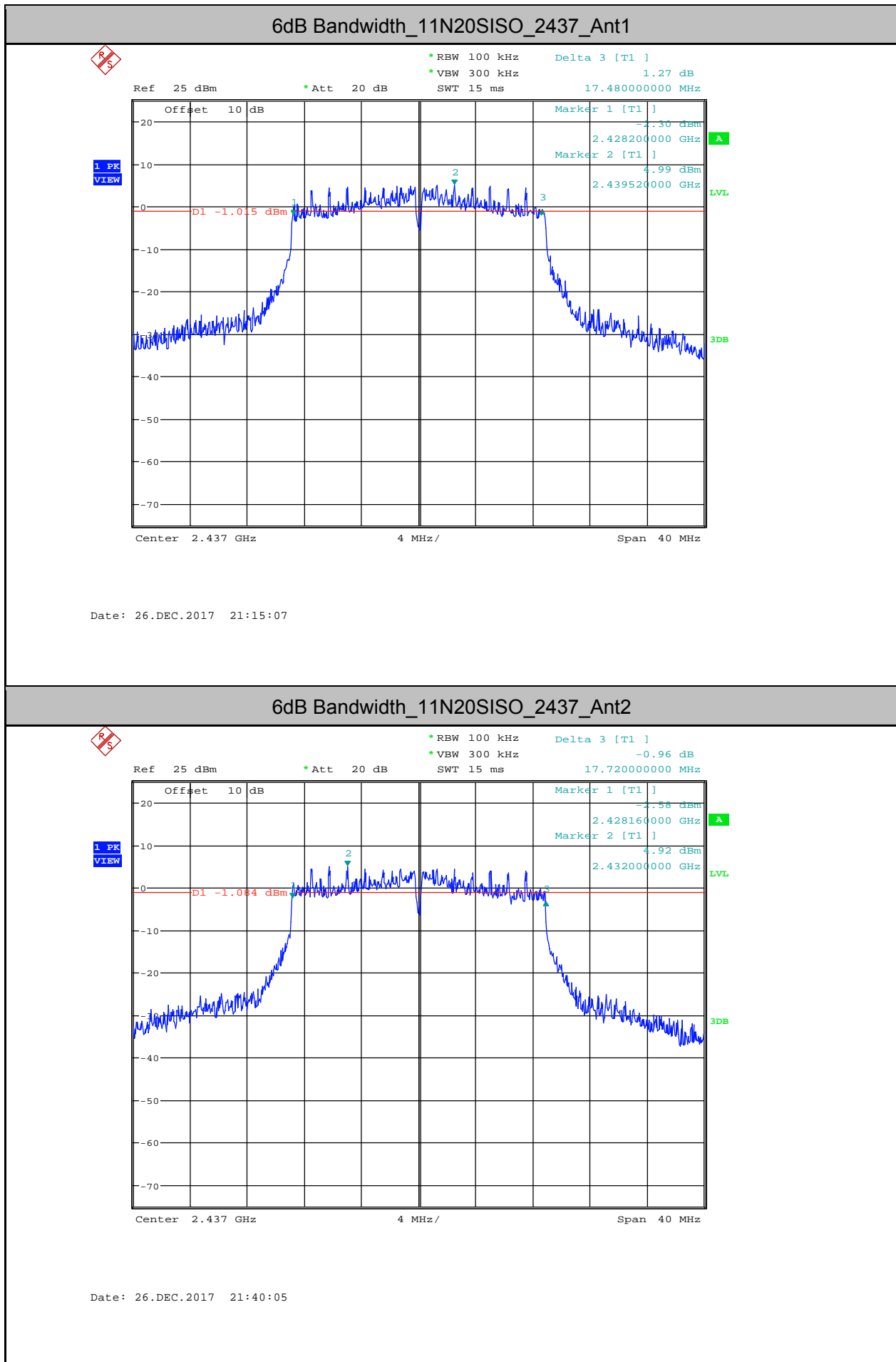

### 6dB Bandwidth\_11N20SISO\_2462\_Ant1

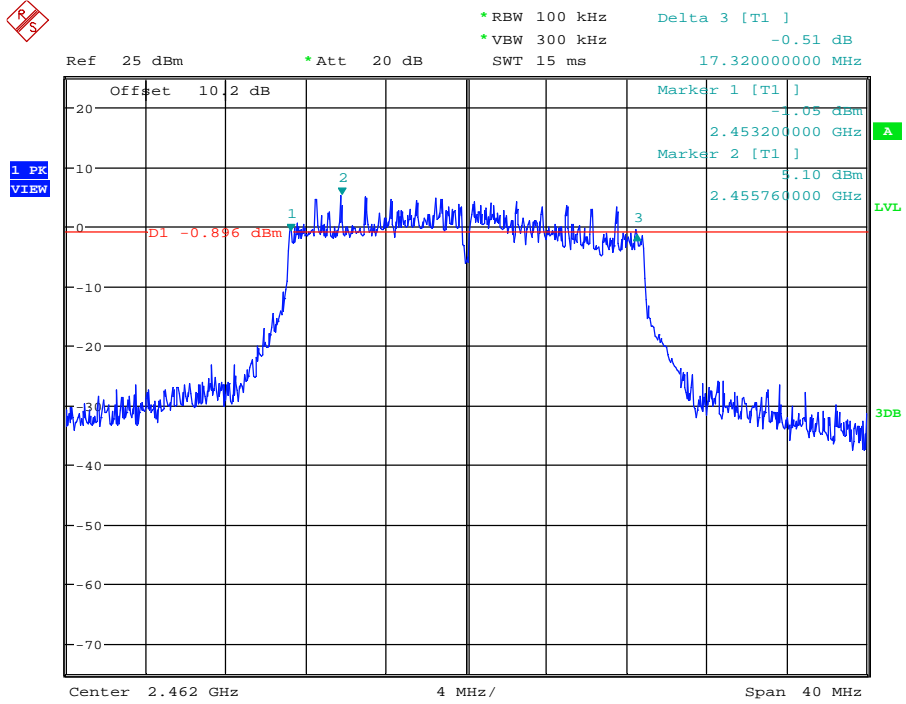

Date: 26.DEC.2017 21:16:58

### 6dB Bandwidth\_11N20SISO\_2462\_Ant2

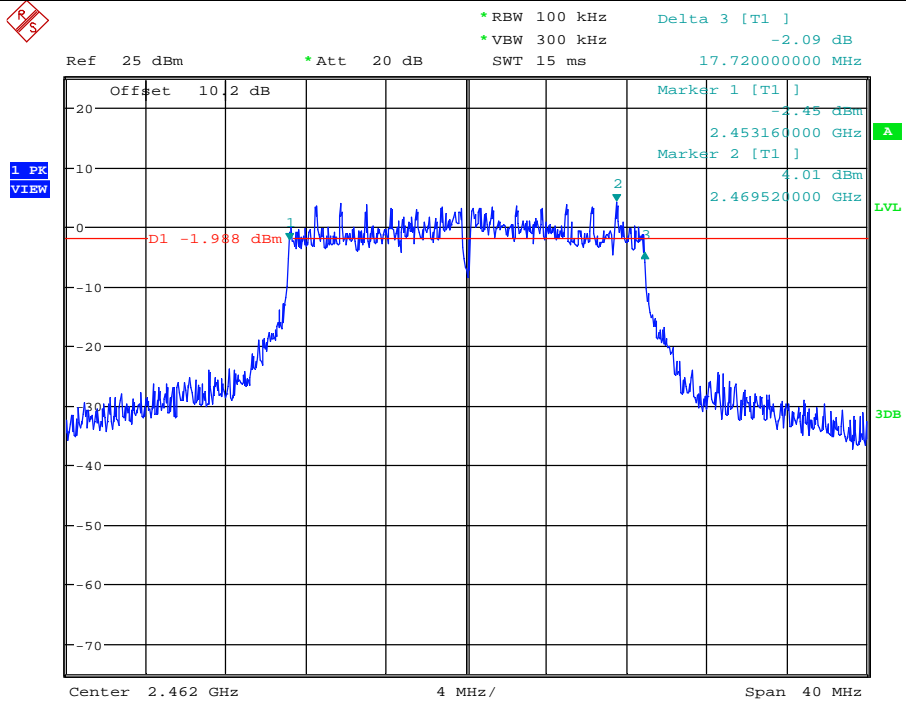

Date: 26.DEC.2017 21:41:44

### Occupied Bandwidth\_11B\_2412\_Ant1

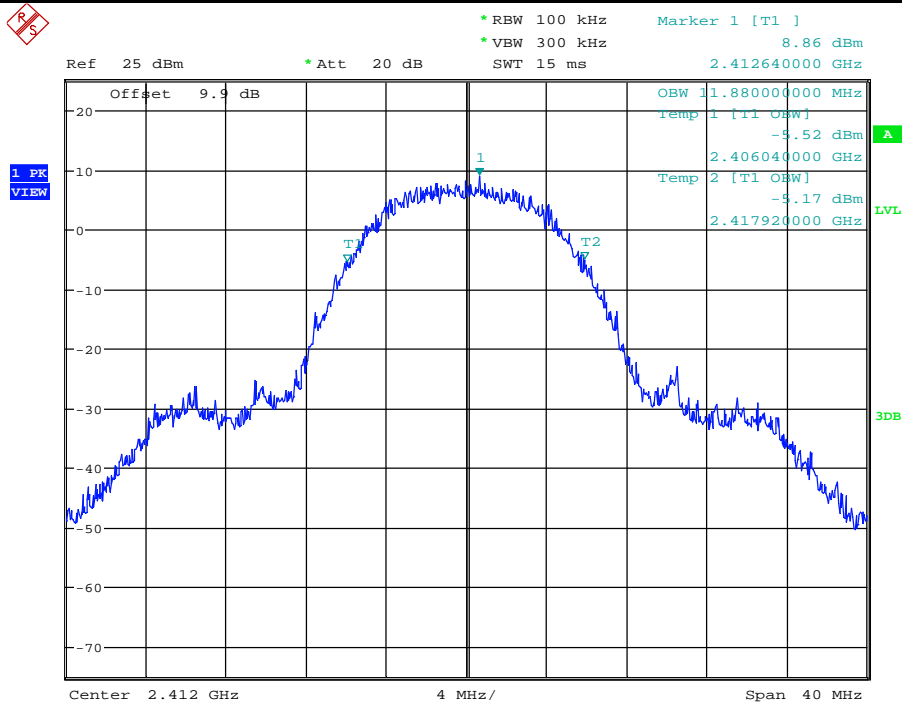

Date: 26.DEC.2017 20:44:59

### Occupied Bandwidth\_11B\_2412\_Ant2

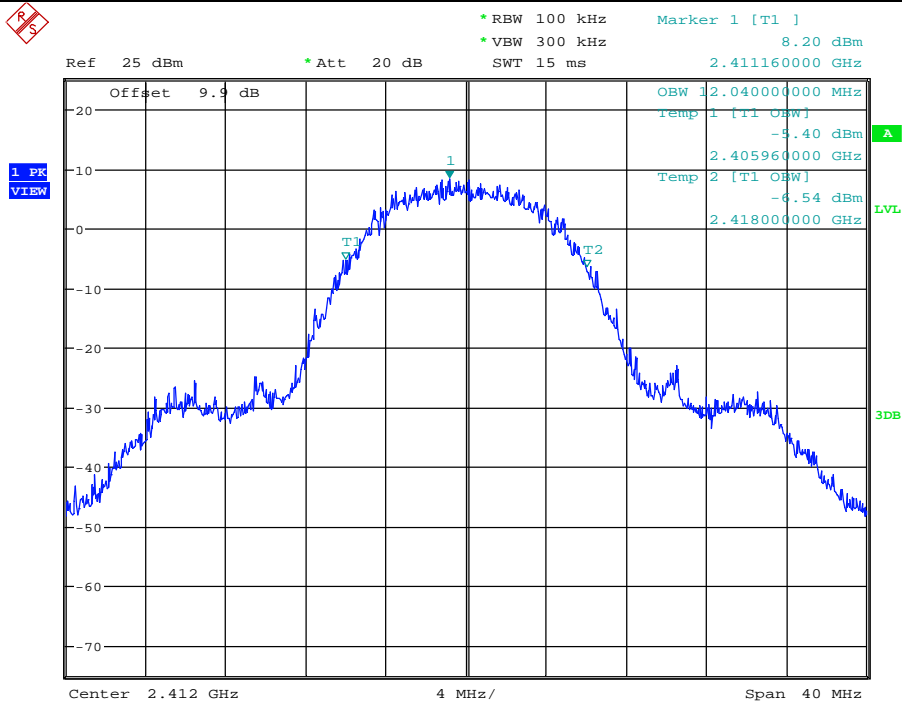

Date: 26.DEC.2017 20:48:07

### Occupied Bandwidth\_11B\_2437\_Ant1

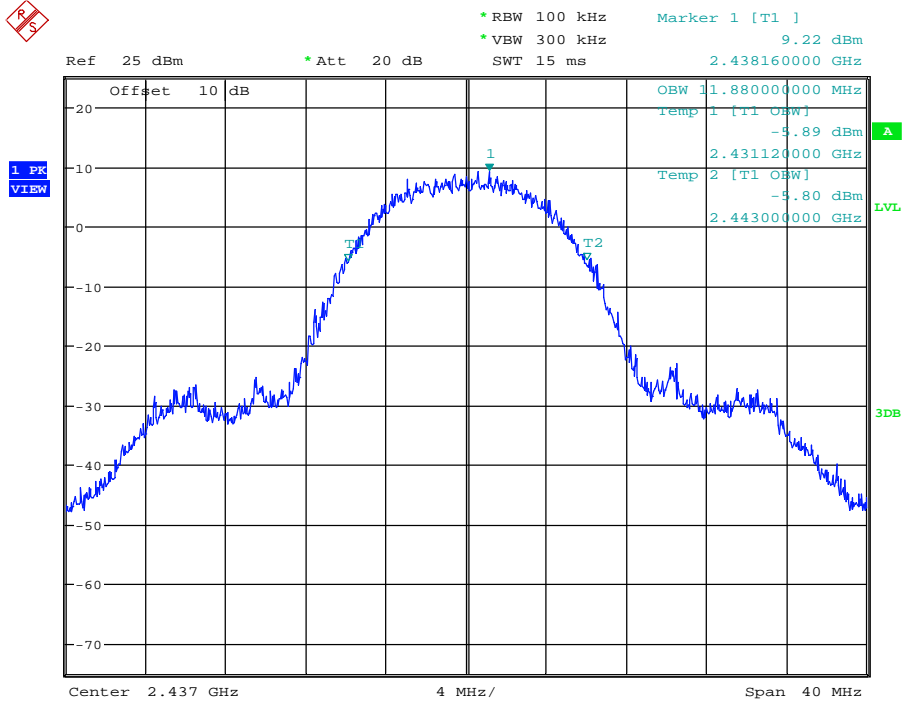

Date: 26.DEC.2017 20:56:40

### Occupied Bandwidth\_11B\_2437\_Ant2

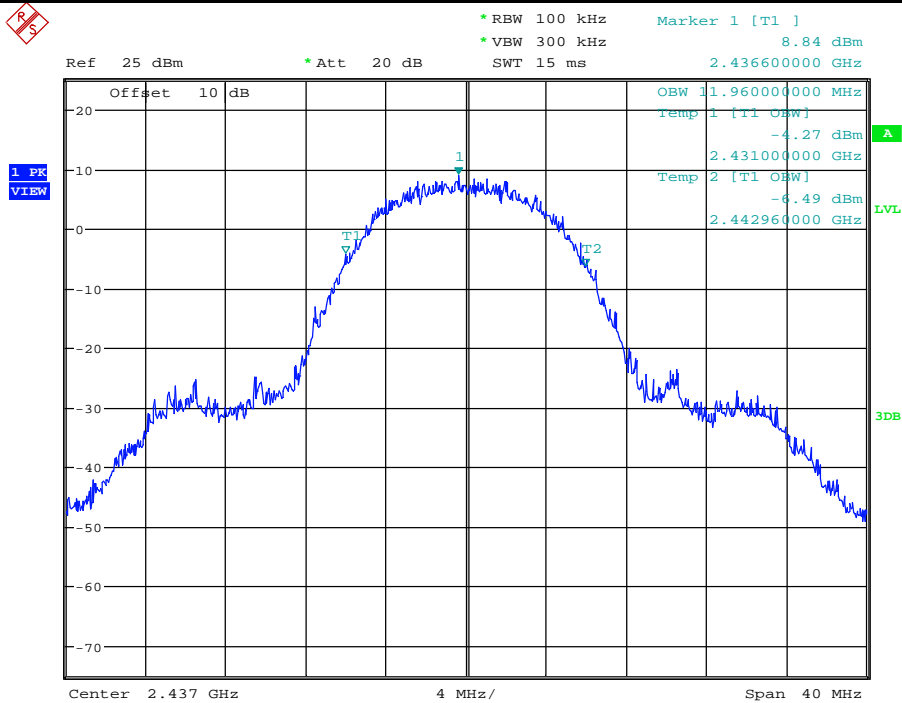

Date: 26.DEC.2017 21:23:47

### Occupied Bandwidth\_11B\_2462\_Ant1

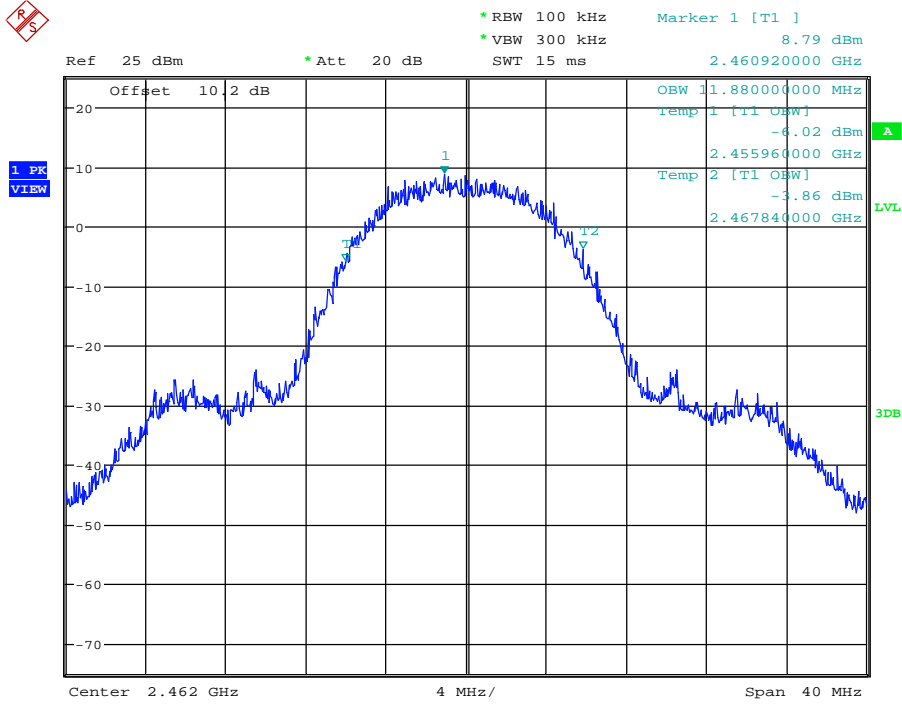

Date: 26.DEC.2017 20:58:26

### Occupied Bandwidth\_11B\_2462\_Ant2

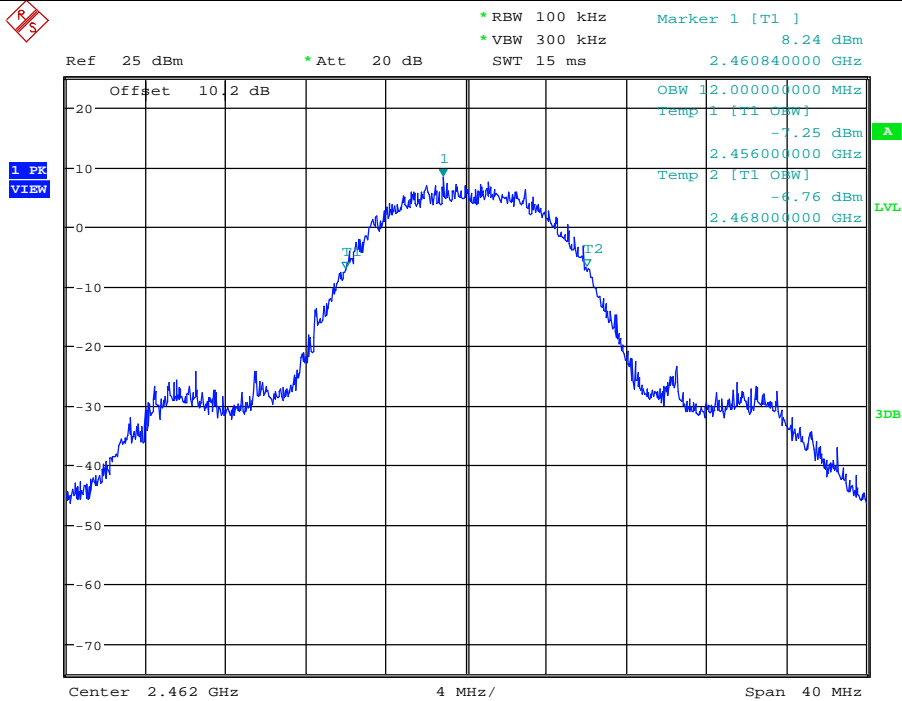

Date: 26.DEC.2017 21:25:51



### Occupied Bandwidth\_11G\_2412\_Ant1

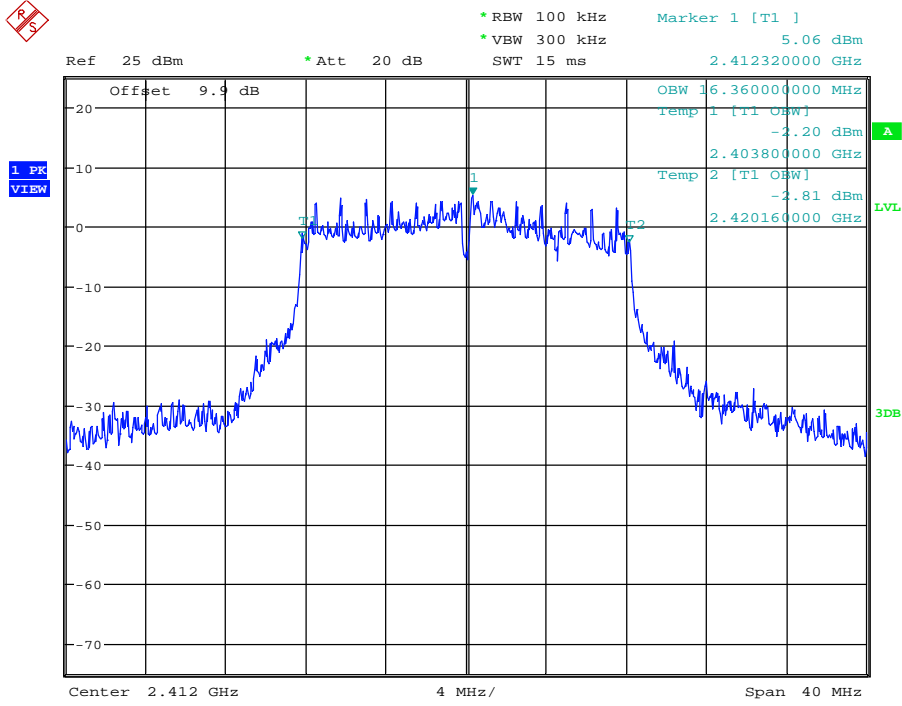

Date: 26.DEC.2017 21:01:34

### Occupied Bandwidth\_11G\_2412\_Ant2

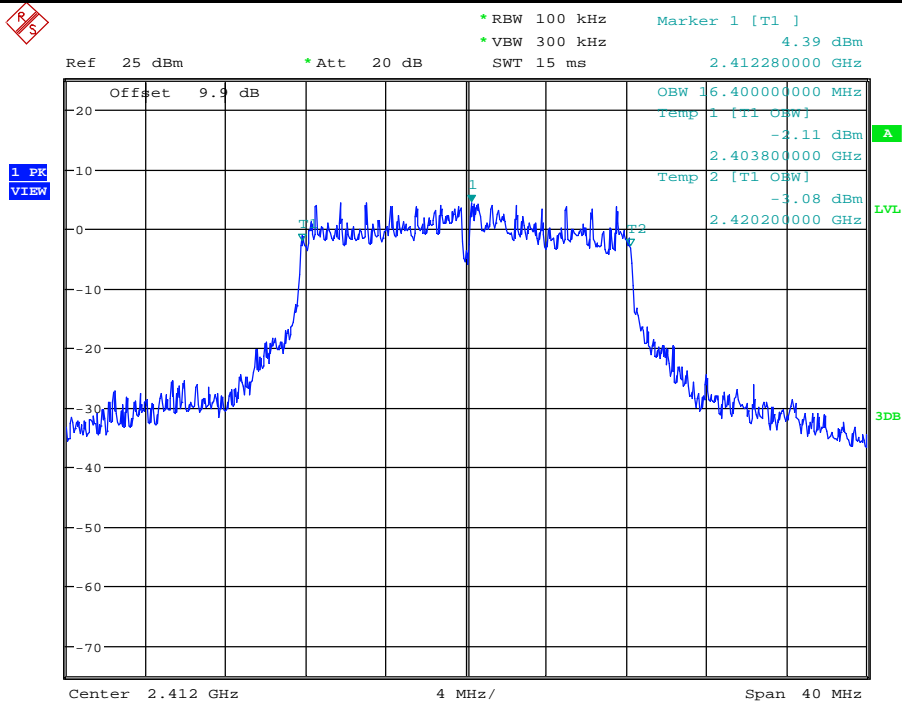

Date: 26.DEC.2017 21:28:33

### Occupied Bandwidth\_11G\_2437\_Ant1

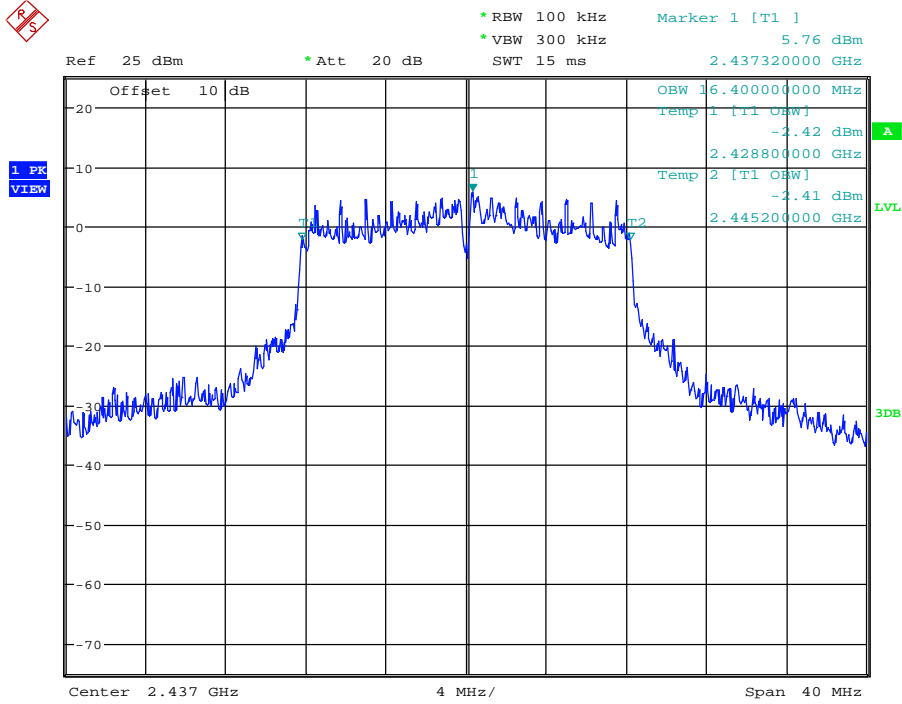

Date: 26.DEC.2017 21:07:03

### Occupied Bandwidth\_11G\_2437\_Ant2

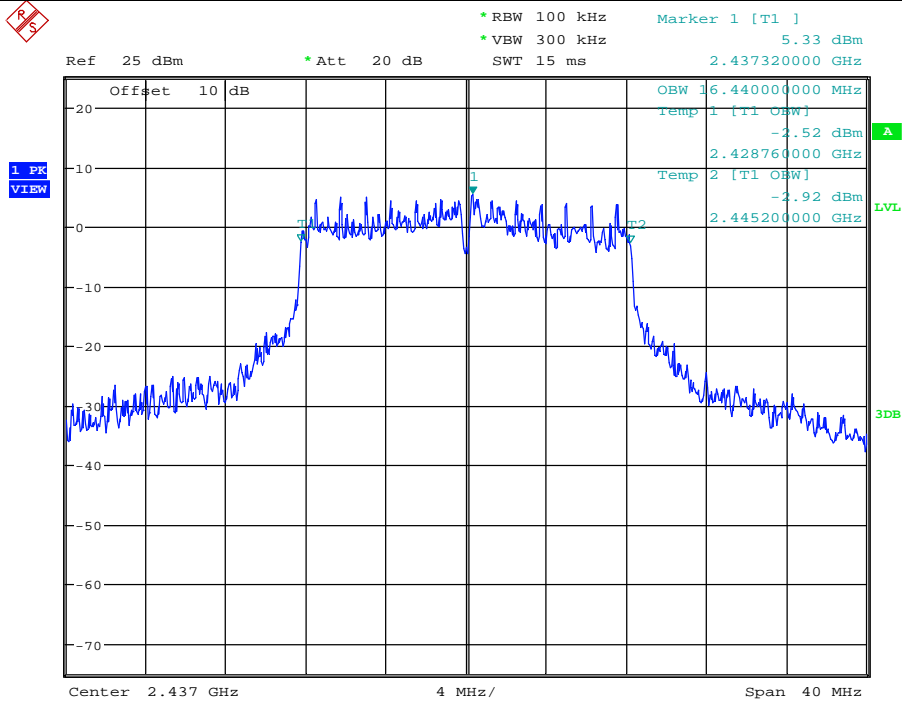

Date: 26.DEC.2017 21:31:17

### Occupied Bandwidth\_11G\_2462\_Ant1

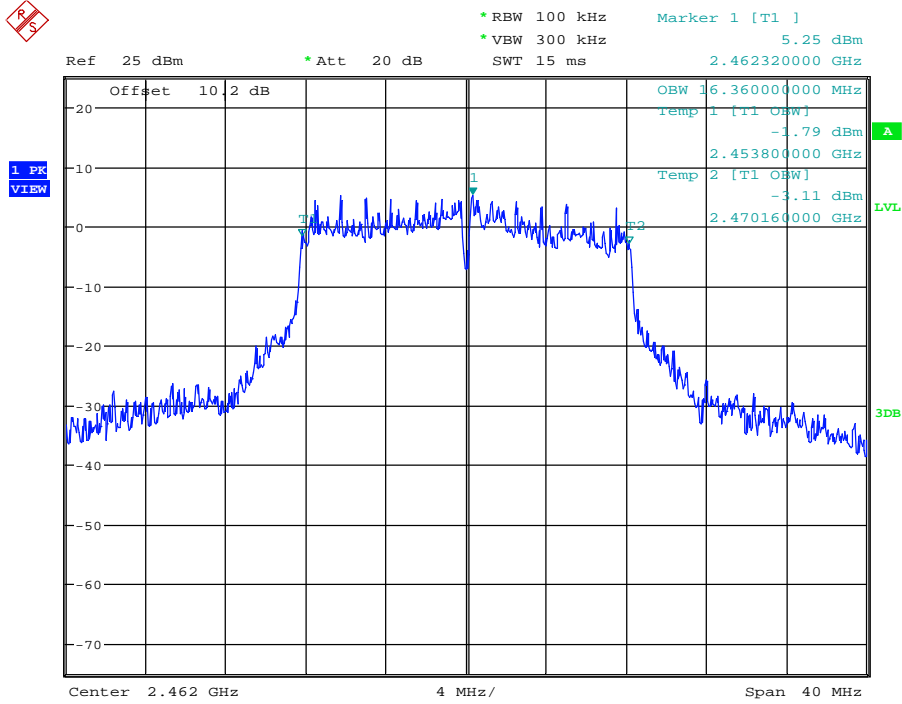

Date: 26.DEC.2017 21:09:04

### Occupied Bandwidth\_11G\_2462\_Ant2

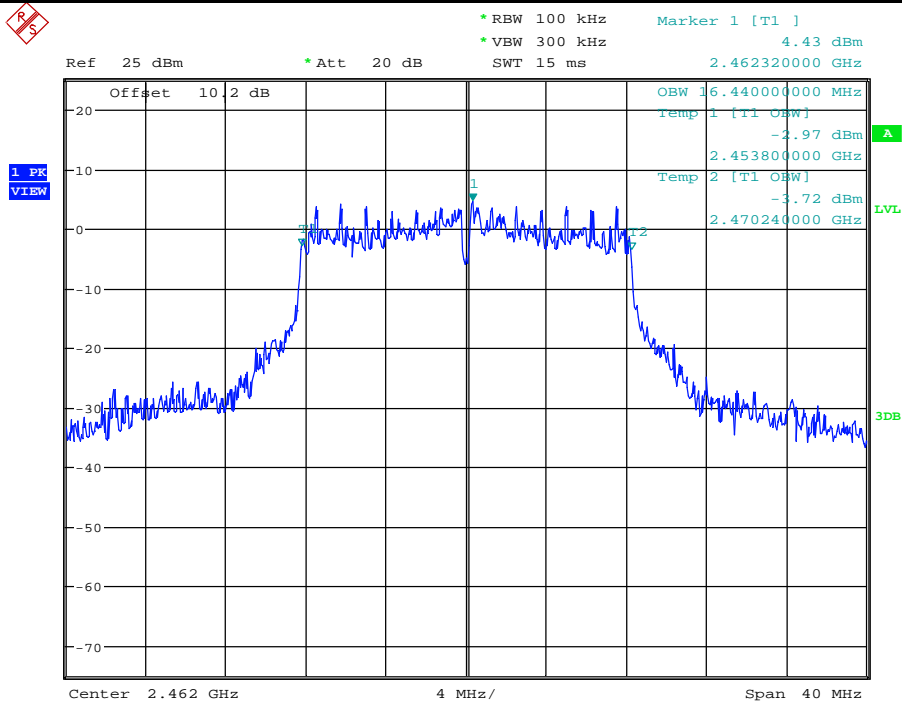

Date: 26.DEC.2017 21:34:16

### Occupied Bandwidth\_11N20SISO\_2412\_Ant1

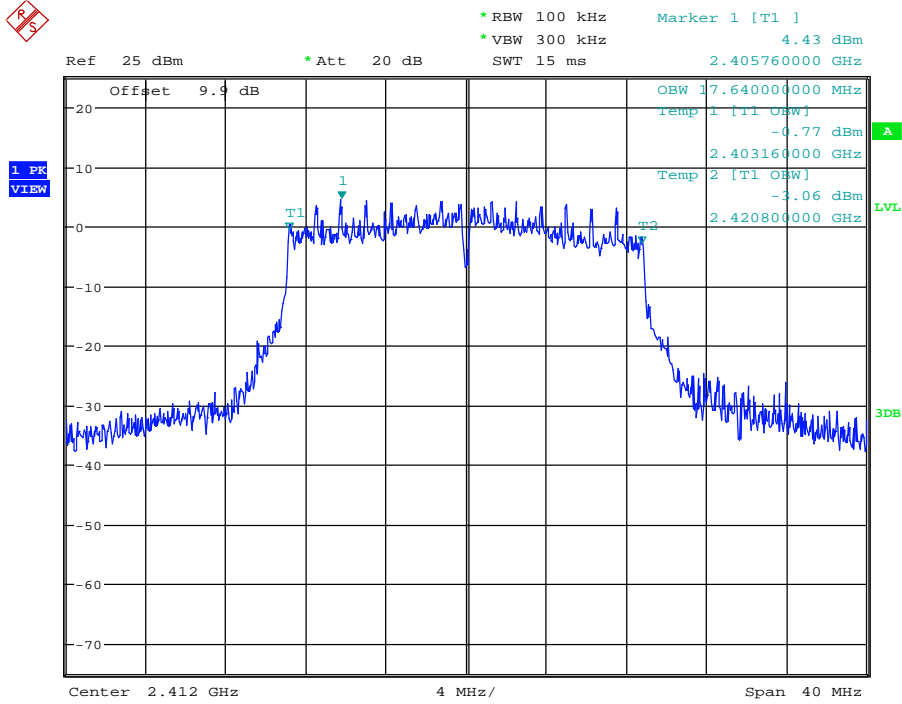

Date: 26.DEC.2017 21:12:05

### Occupied Bandwidth\_11N20SISO\_2412\_Ant2

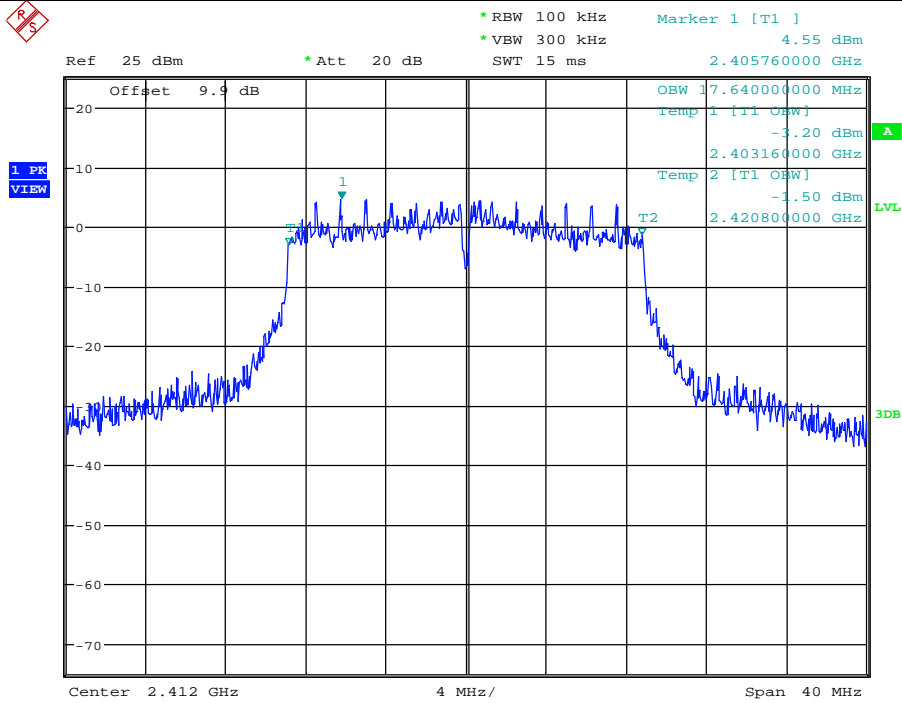

Date: 26.DEC.2017 21:37:31

### Occupied Bandwidth\_11N20SISO\_2437\_Ant1

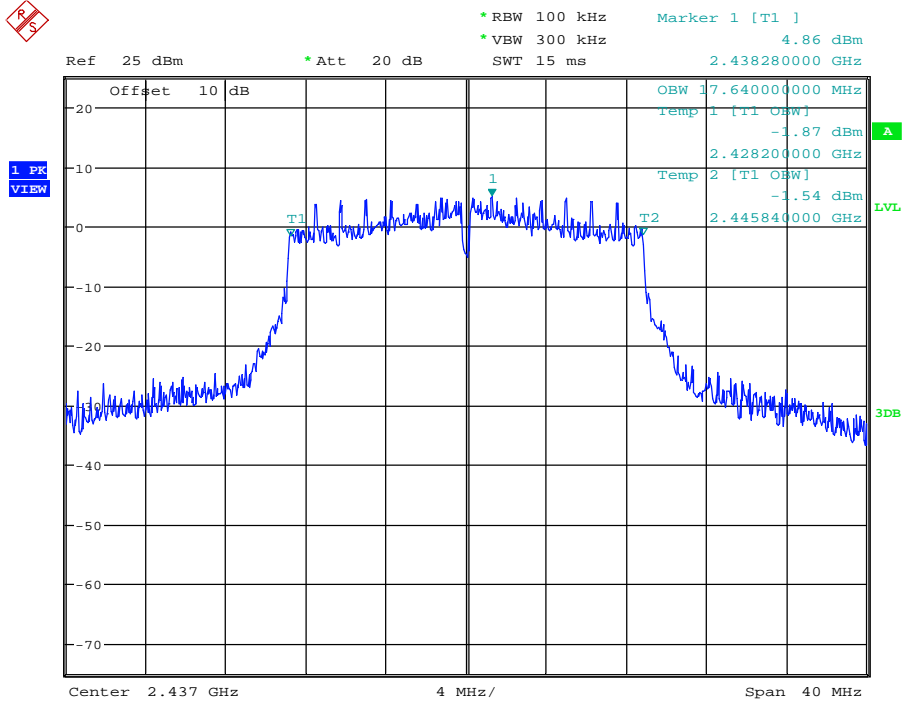

Date: 26.DEC.2017 21:15:25

### Occupied Bandwidth\_11N20SISO\_2437\_Ant2

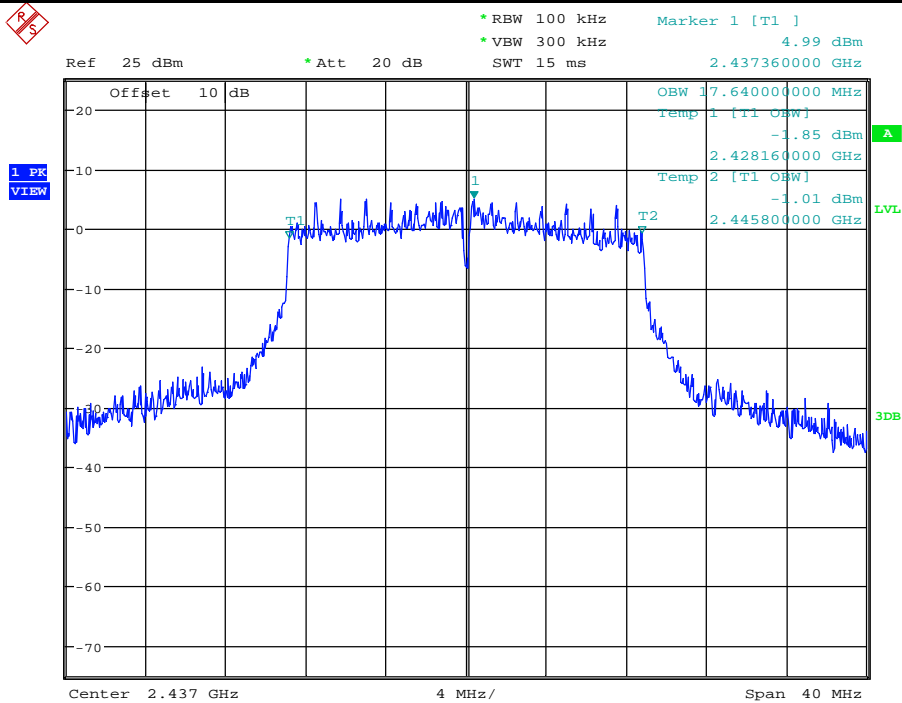

Date: 26.DEC.2017 21:40:24

### Occupied Bandwidth\_11N20SISO\_2462\_Ant1

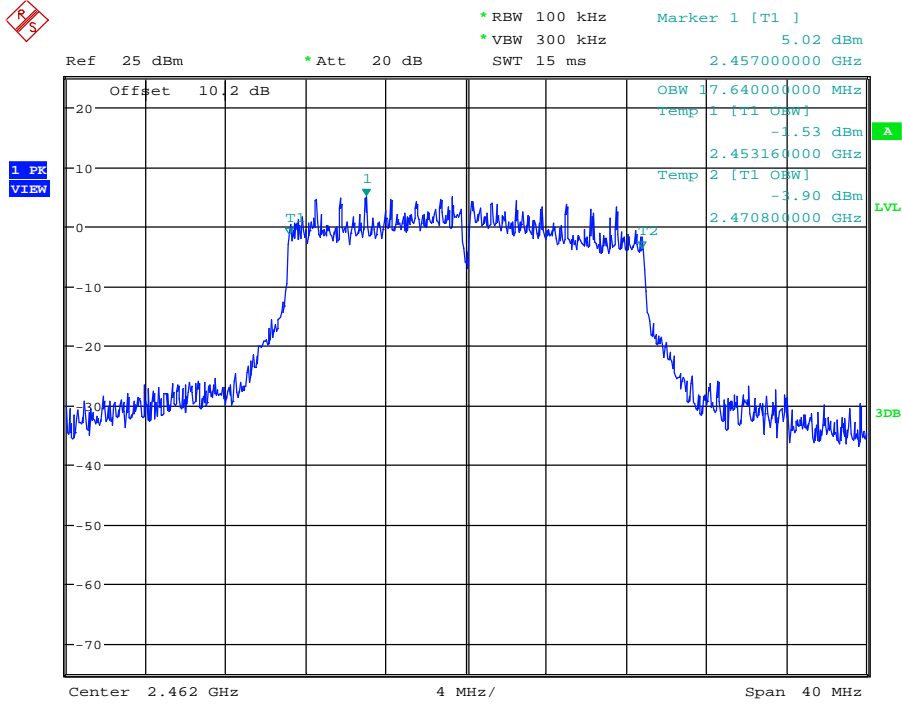

Date: 26.DEC.2017 21:17:17

### Occupied Bandwidth\_11N20SISO\_2462\_Ant2

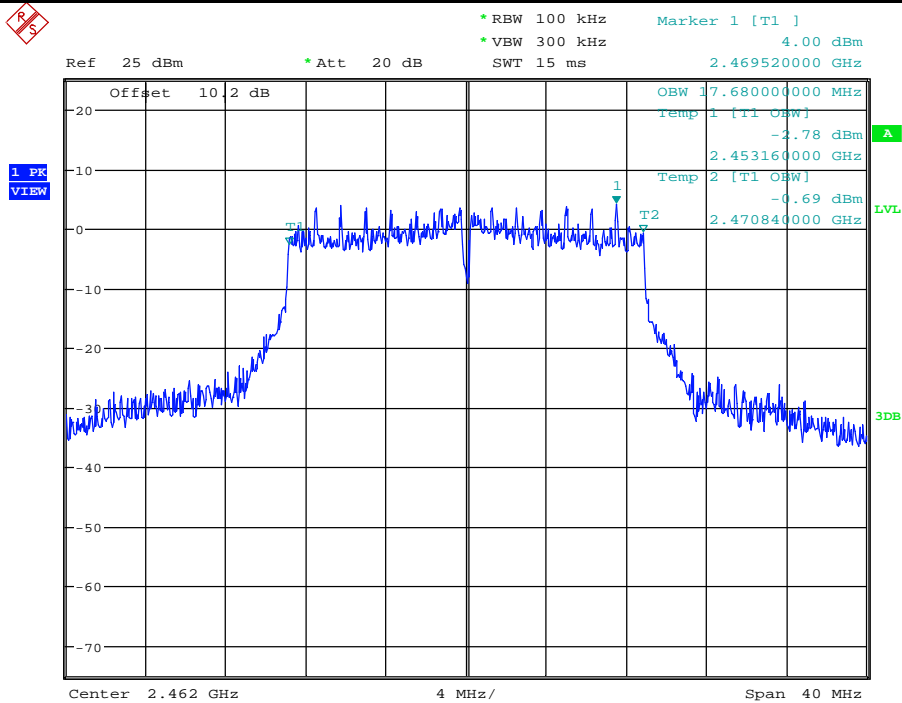

Date: 26.DEC.2017 21:42:02

## 5. Conducted peak Output Power

### 5.1. Block diagram of test setup

Same as section 4.1

### 5.2. Limits

For systems using digital modulation in the 902-928 MHz, 2400-2483.5 MHz, and 5725-5850 MHz bands: 1 Watt. If transmitting antennas of directional gain greater than 6 dBi are used, the conducted output power from the intentional radiator shall be reduced below the stated values as appropriate, by the amount in dB that the directional gain of the antenna exceeds 6 dBi.

### 5.3. Test Procedure

Connect each EUT's antenna output to power sensor by RF cable and attenuator

Measure the PK output power of each antenna port by power sensor.

### 5.4. Test Result

Test Mode	Test	Ant	Power[dBm]	Limit[dBm]	Verdict
11B	2412	Ant1	24.29	30	PASS
11B	2412	Ant2	24.15	30	PASS
11B	2437	Ant1	24.8	30	PASS
11B	2437	Ant2	24.51	30	PASS
11B	2462	Ant1	24.5	30	PASS
11B	2462	Ant2	23.71	30	PASS
11G	2412	Ant1	23.22	30	PASS
11G	2412	Ant2	23.28	30	PASS
11G	2437	Ant1	23.94	30	PASS
11G	2437	Ant2	23.7	30	PASS
11G	2462	Ant1	23.51	30	PASS
11G	2462	Ant2	23.05	30	PASS
11N20	2412	Ant1	23.84	30	PASS
11N20	2412	Ant2	24.05	30	PASS
11N20	2437	Ant1	24.57	30	PASS
11N20	2437	Ant2	24.37	30	PASS
11N20	2462	Ant1	24.11	30	PASS
11N20	2462	Ant2	23.45	30	PASS

## 6. Power Spectral Density

### 6.1. Block diagram of test setup

Same as section 4.1

### 6.2. Limits

For digitally modulated systems, the power spectral density conducted from the intentional radiator to the antenna shall not be greater than 8dBm in any 3 kHz band during any time interval of continuous transmission.

### 6.3. Test Procedure

- (1) Connect EUT's antenna output to spectrum analyzer by RF cable.
- (2) Set the spectrum analyzer as follows:
 

Center frequency	DTS Channel center frequency
RBW:	$3 \text{ kHz} \leq \text{RBW} \leq 100 \text{ kHz}$
VBW:	$\geq 3\text{RBW}$
Span	1.5times the DTS bandwidth
Detector Mode:	RMS
Sweep time:	auto
Trace mode	Max hold
- (3) Allow the trace to stabilize, use the peak marker function to determine the maximum amplitude level within the RBW.
- (4) If measured value exceeds limit, reduce RBW (no less than 3 kHz) and repeat.

### 6.4. Test Result

Test Mode	Test	Ant	PSD[dBm]	Limit[dBm/KHz]	Verdict
11B	2412	Ant1	4.1	8.00	PASS
11B	2412	Ant2	3.9	8.00	PASS
11B	2437	Ant1	4.87	8.00	PASS
11B	2437	Ant2	4.61	8.00	PASS
11B	2462	Ant1	4.64	8.00	PASS
11B	2462	Ant2	3.33	8.00	PASS
11G	2412	Ant1	0.43	8.00	PASS
11G	2412	Ant2	0.31	8.00	PASS
11G	2437	Ant1	1.12	8.00	PASS
11G	2437	Ant2	0.75	8.00	PASS
11G	2462	Ant1	0.67	8.00	PASS
11G	2462	Ant2	-0.16	8.00	PASS
11N20	2412	Ant1	0.87	8.00	PASS
11N20	2412	Ant2	1.87	8.00	PASS



11N20	2437	Ant1	1.49	8.00	PASS
11N20	2437	Ant2	1.32	8.00	PASS
11N20	2462	Ant1	1.4	8.00	PASS
11N20	2462	Ant2	-0.1	8.00	PASS

6.5. original test data

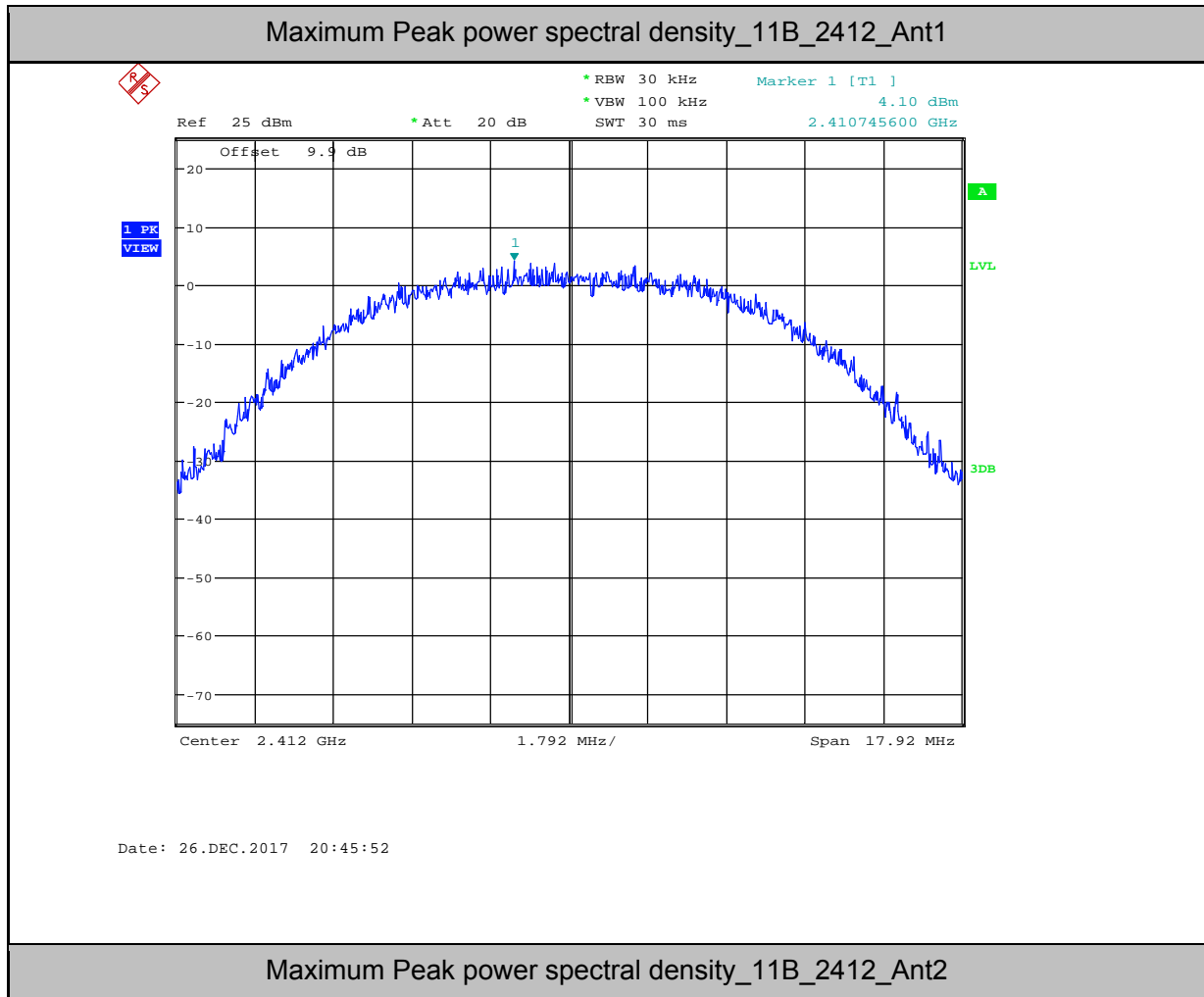

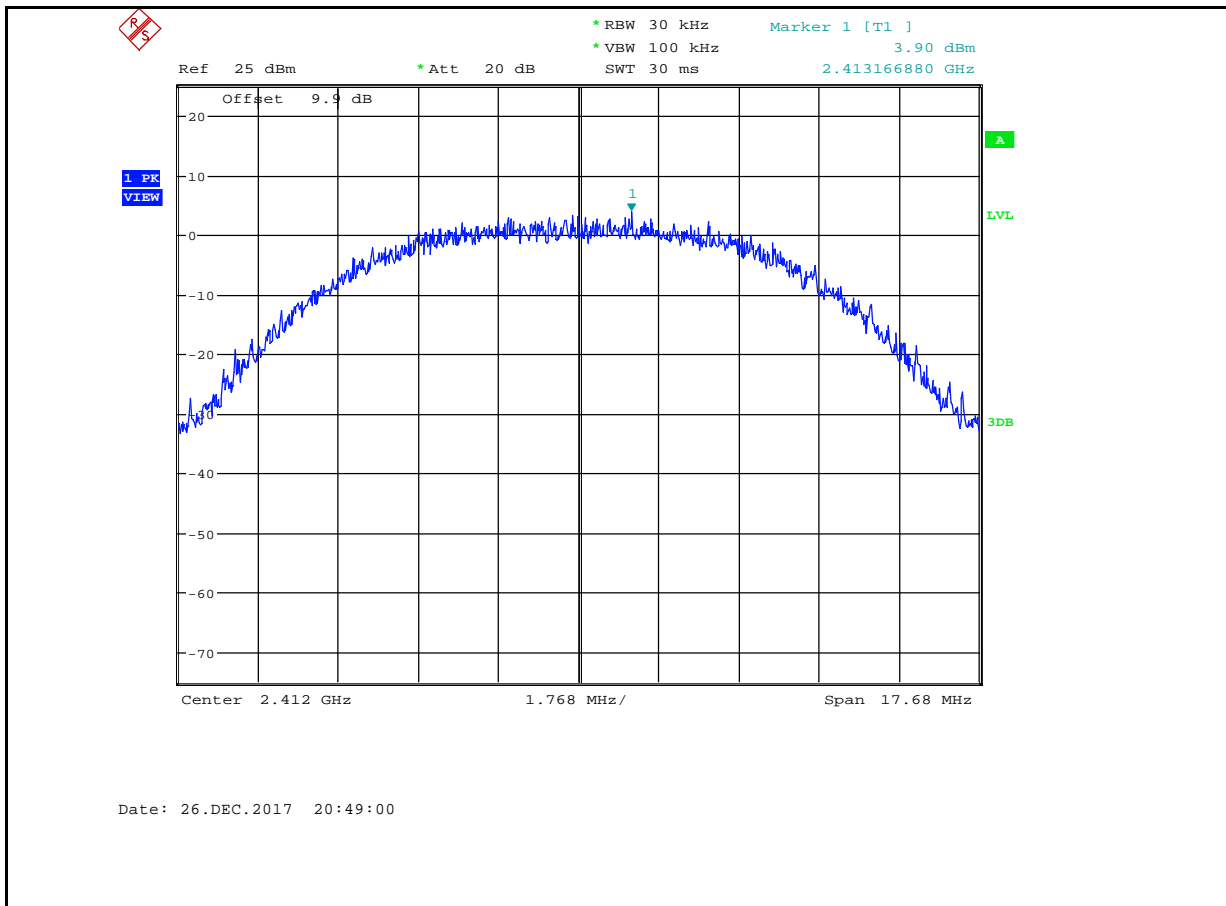

Maximum Peak power spectral density\_11B\_2437\_Ant1

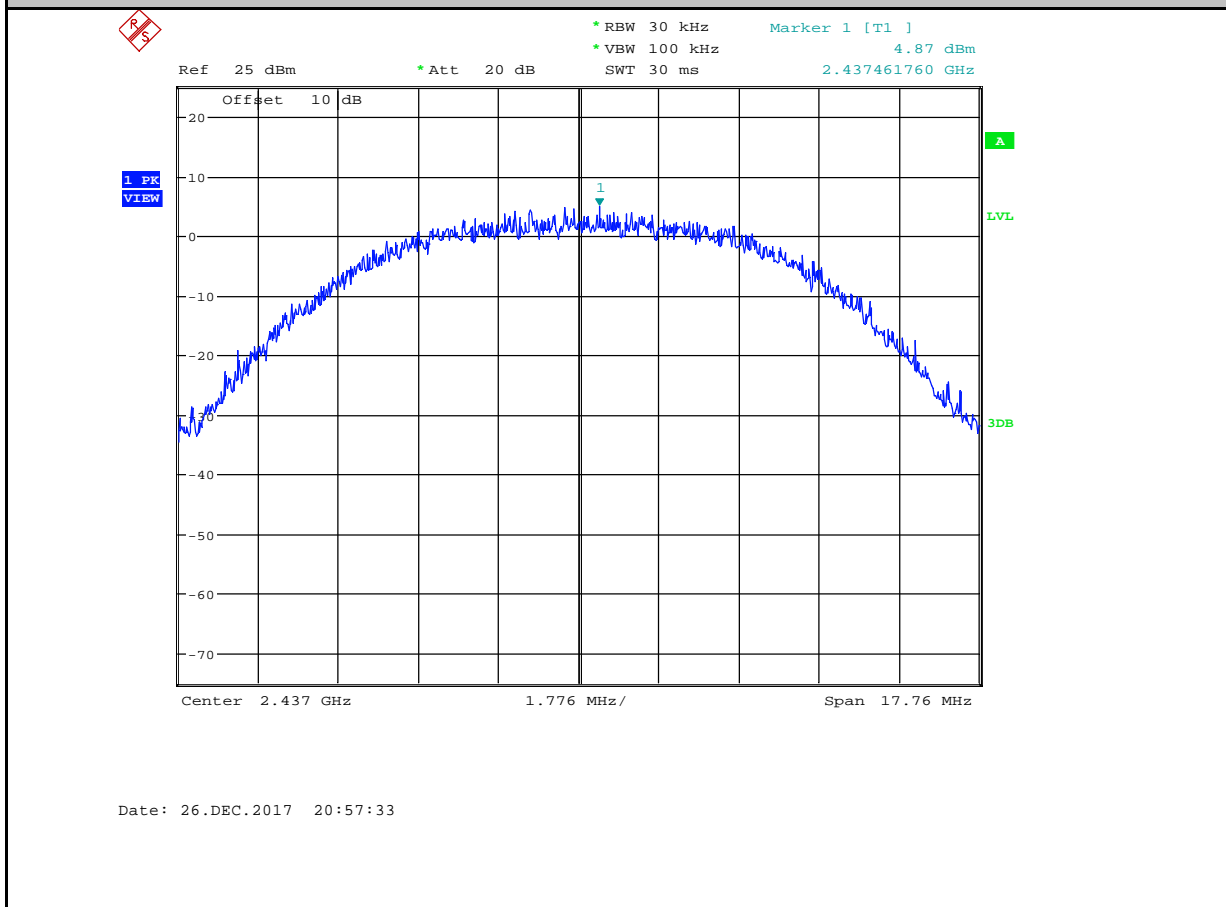

Maximum Peak power spectral density\_11B\_2437\_Ant2

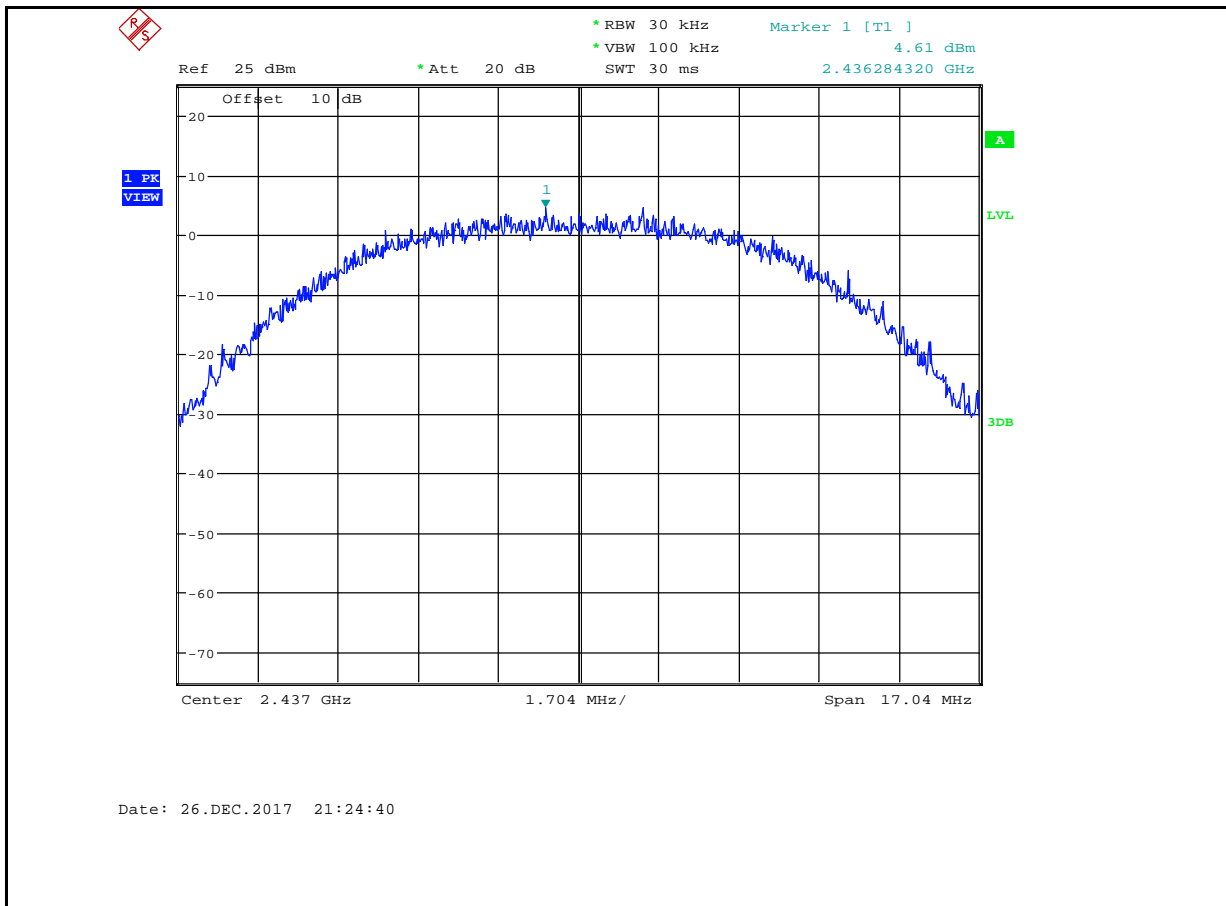

Maximum Peak power spectral density\_11B\_2462\_Ant1

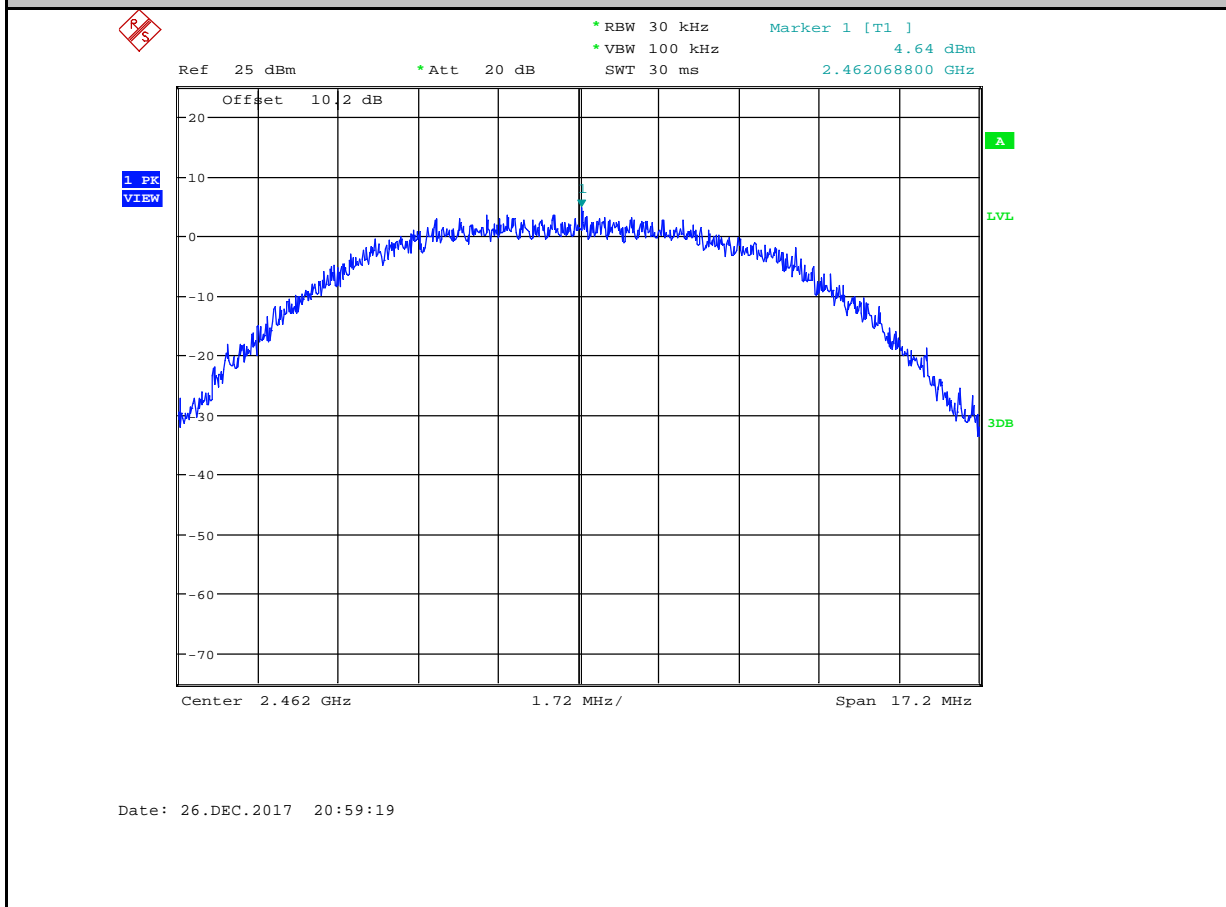

Maximum Peak power spectral density\_11B\_2462\_Ant2

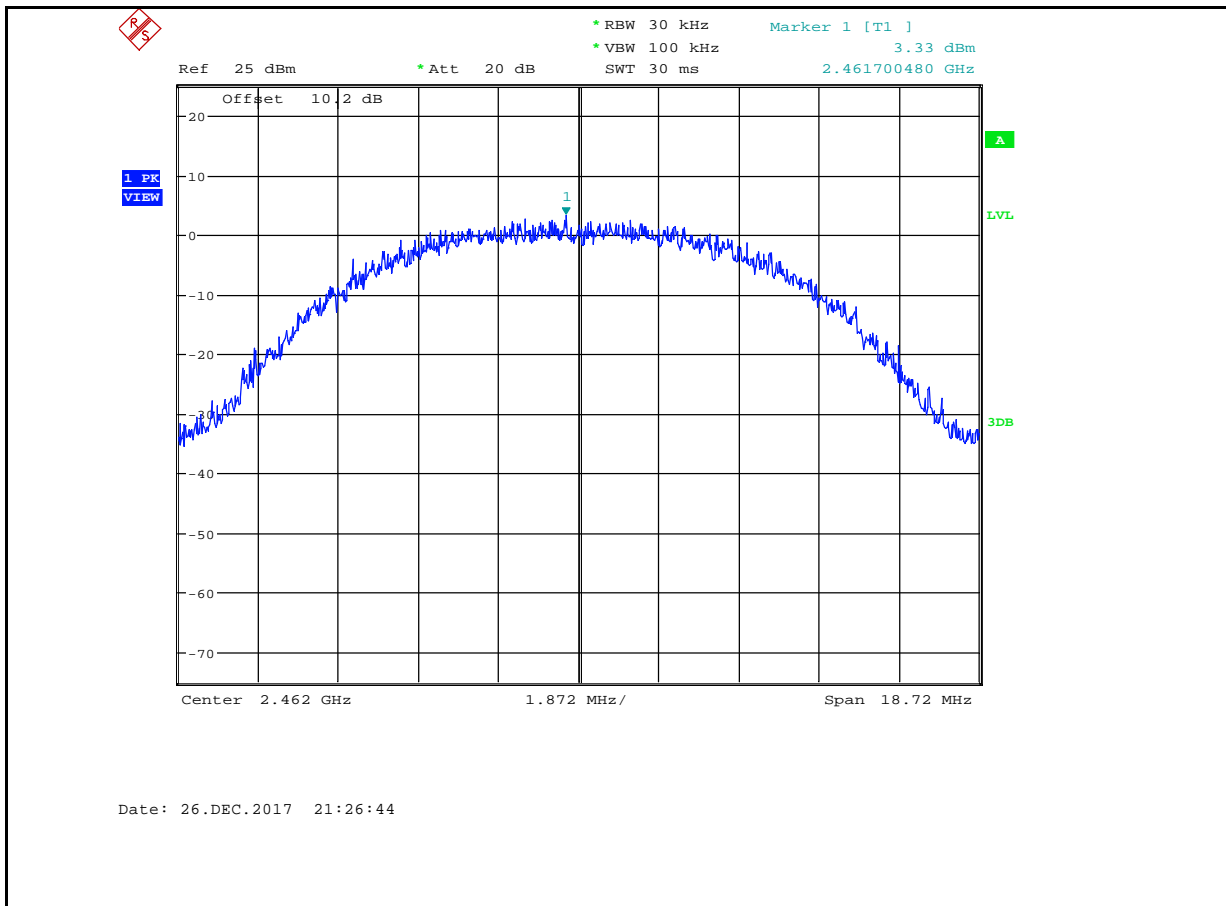

Maximum Peak power spectral density\_11G\_2412\_Ant1

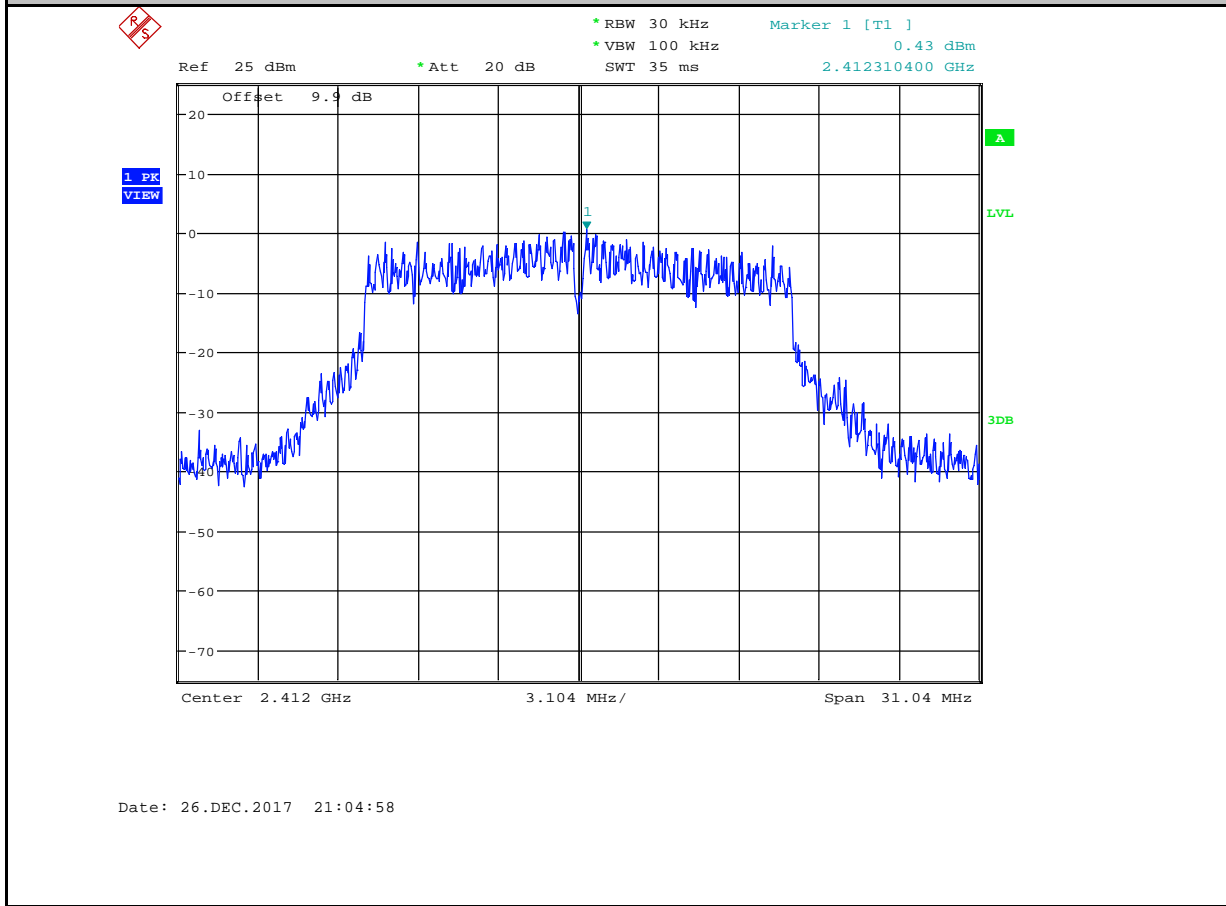

Maximum Peak power spectral density\_11G\_2412\_Ant2

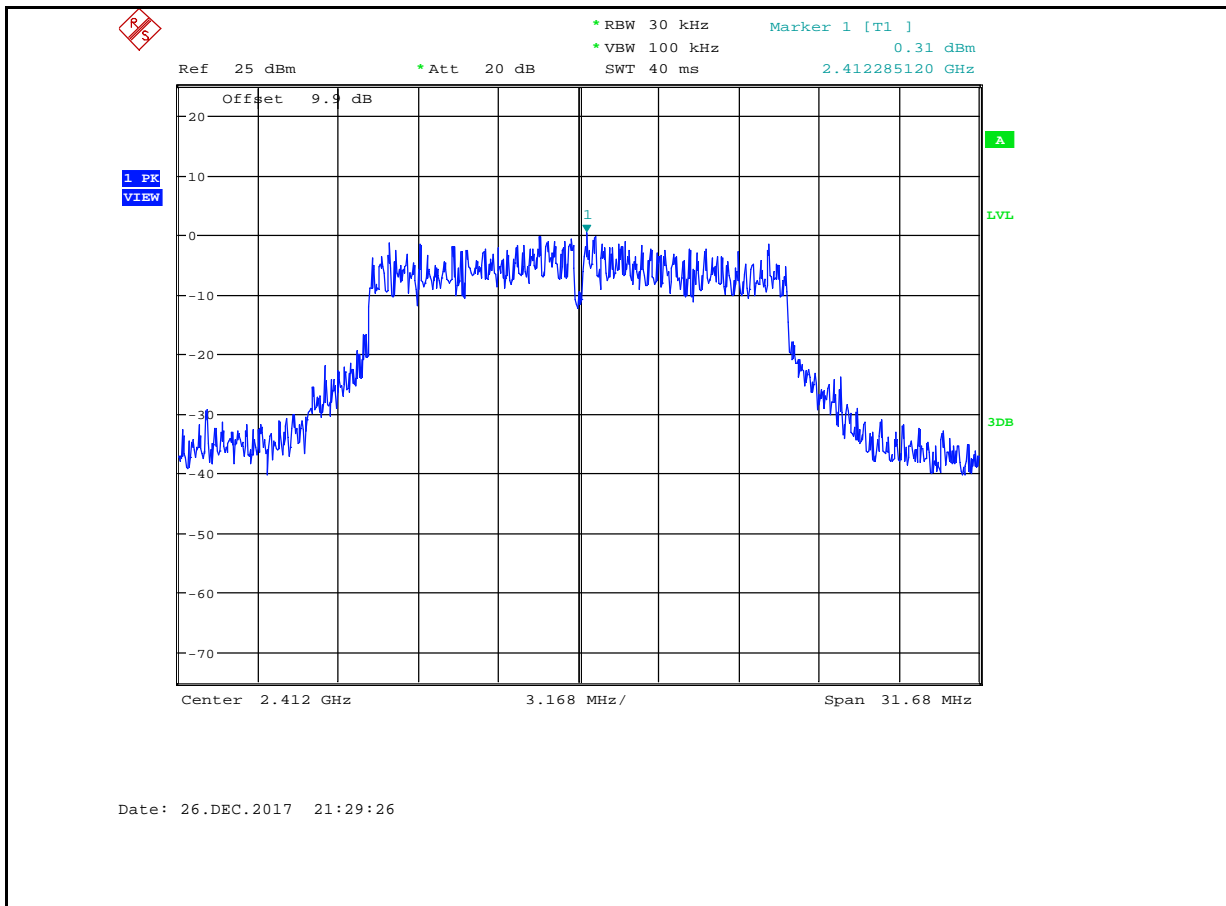

Maximum Peak power spectral density\_11G\_2437\_Ant1

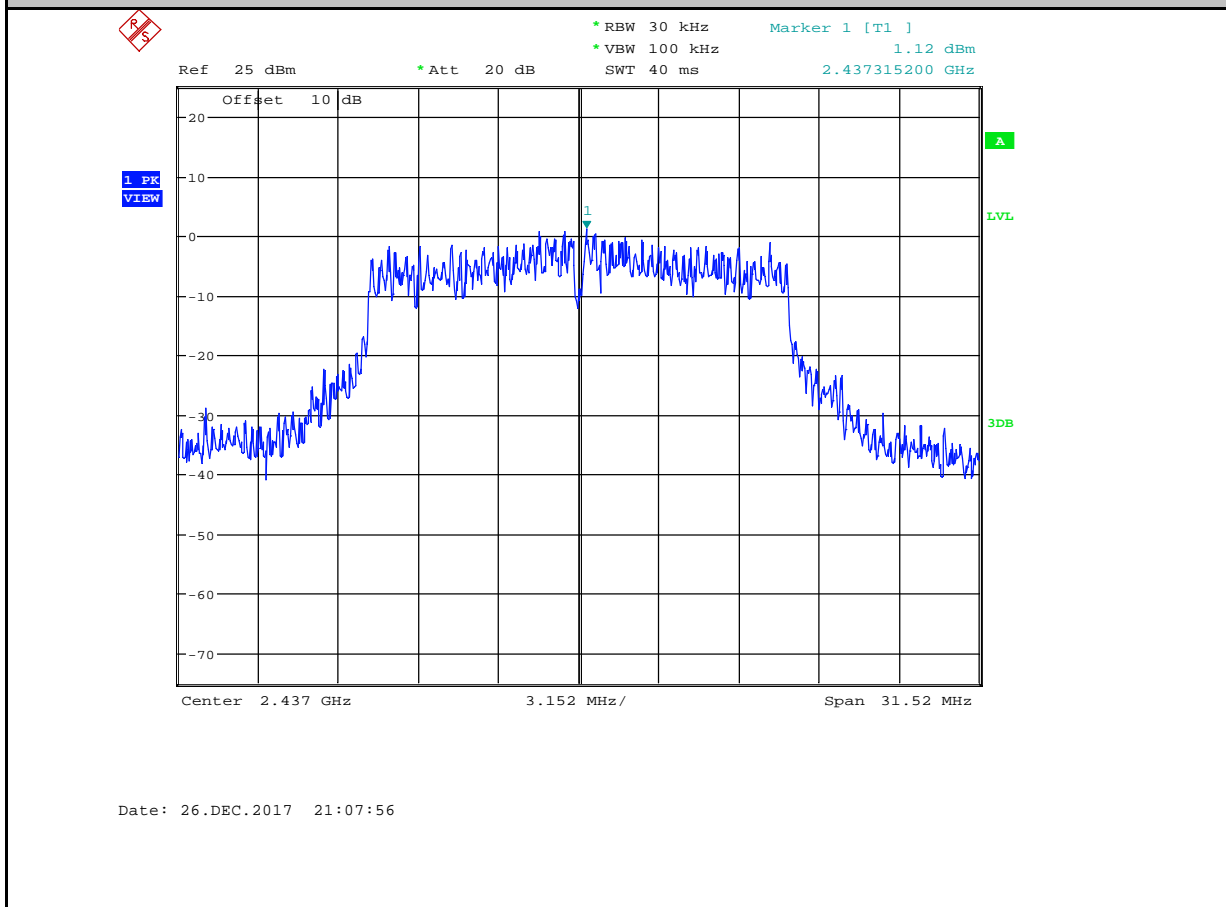

Maximum Peak power spectral density\_11G\_2437\_Ant2

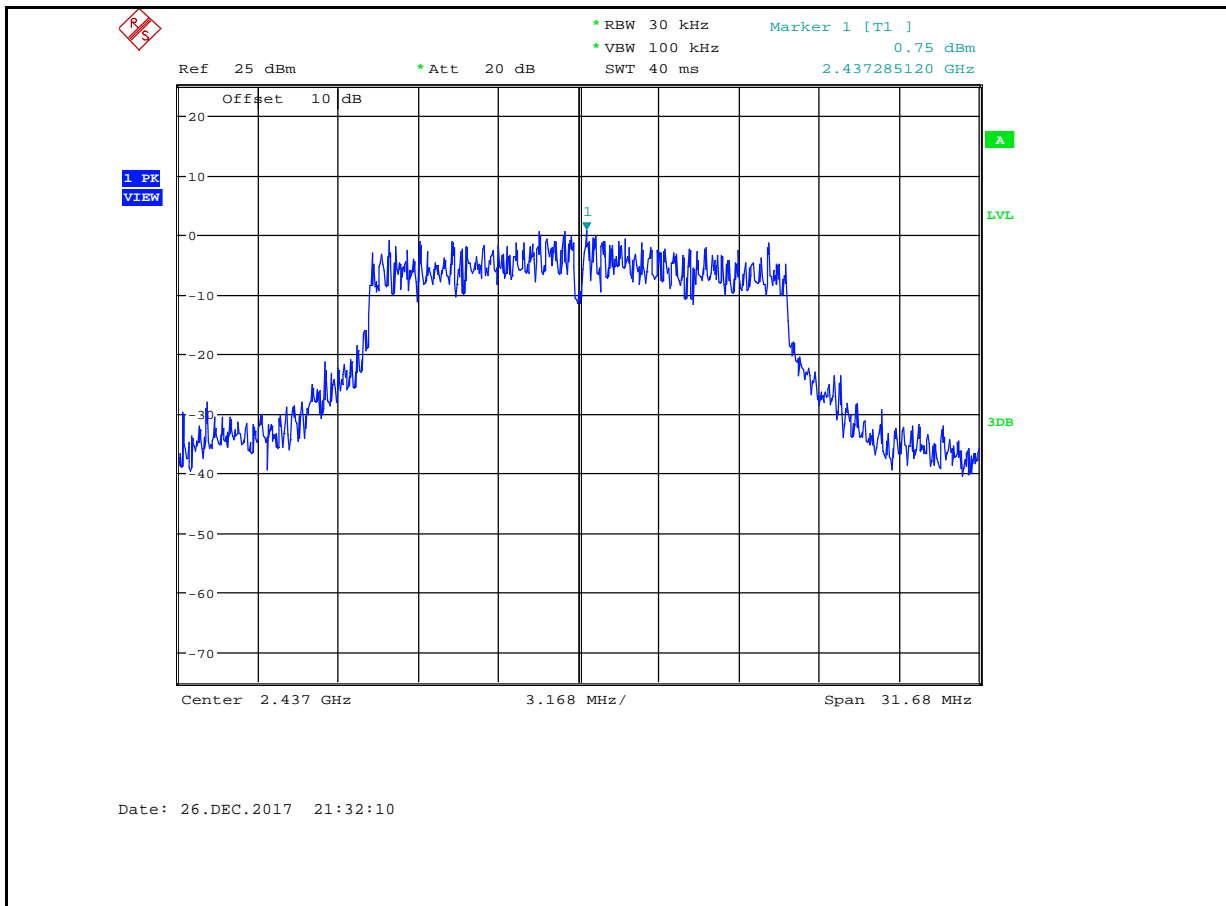

Maximum Peak power spectral density\_11G\_2462\_Ant1

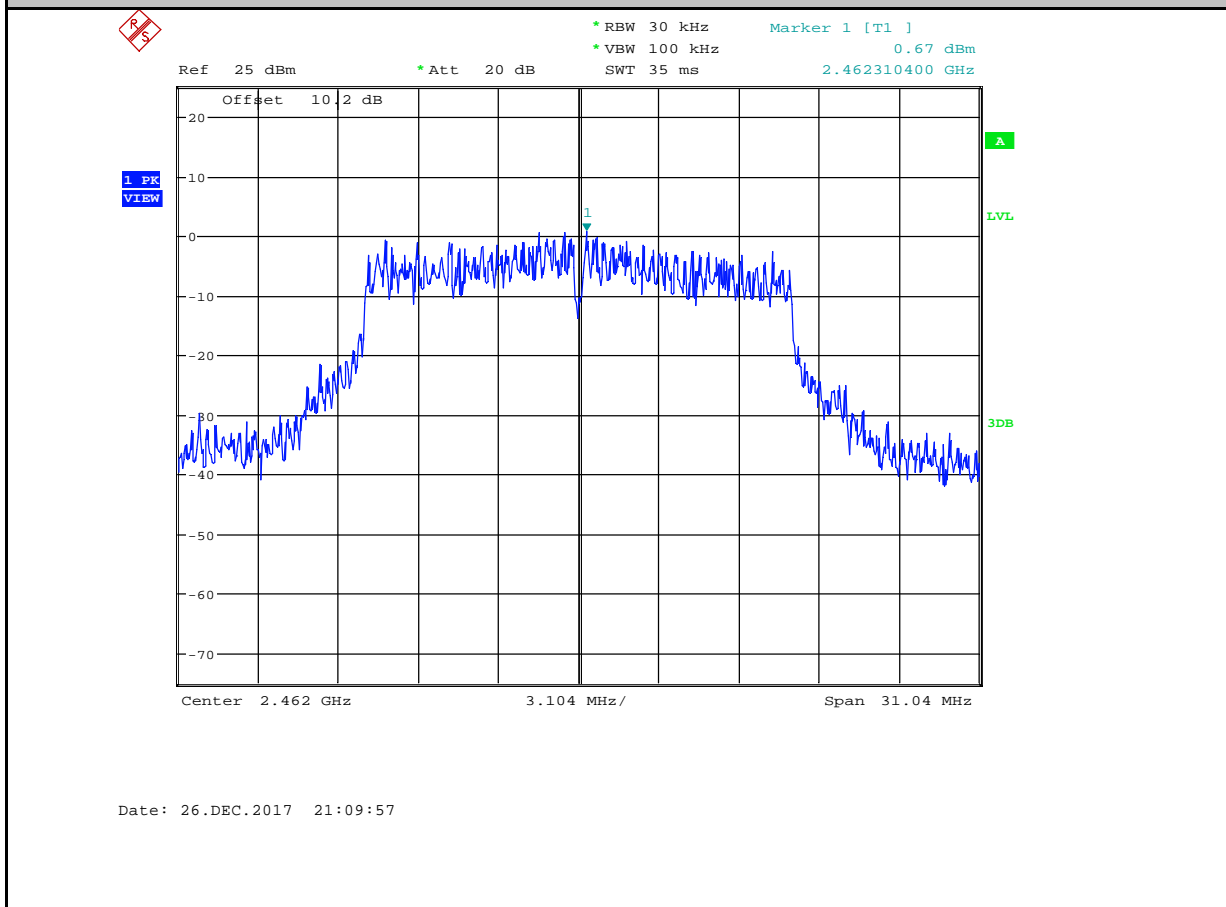

Maximum Peak power spectral density\_11G\_2462\_Ant2

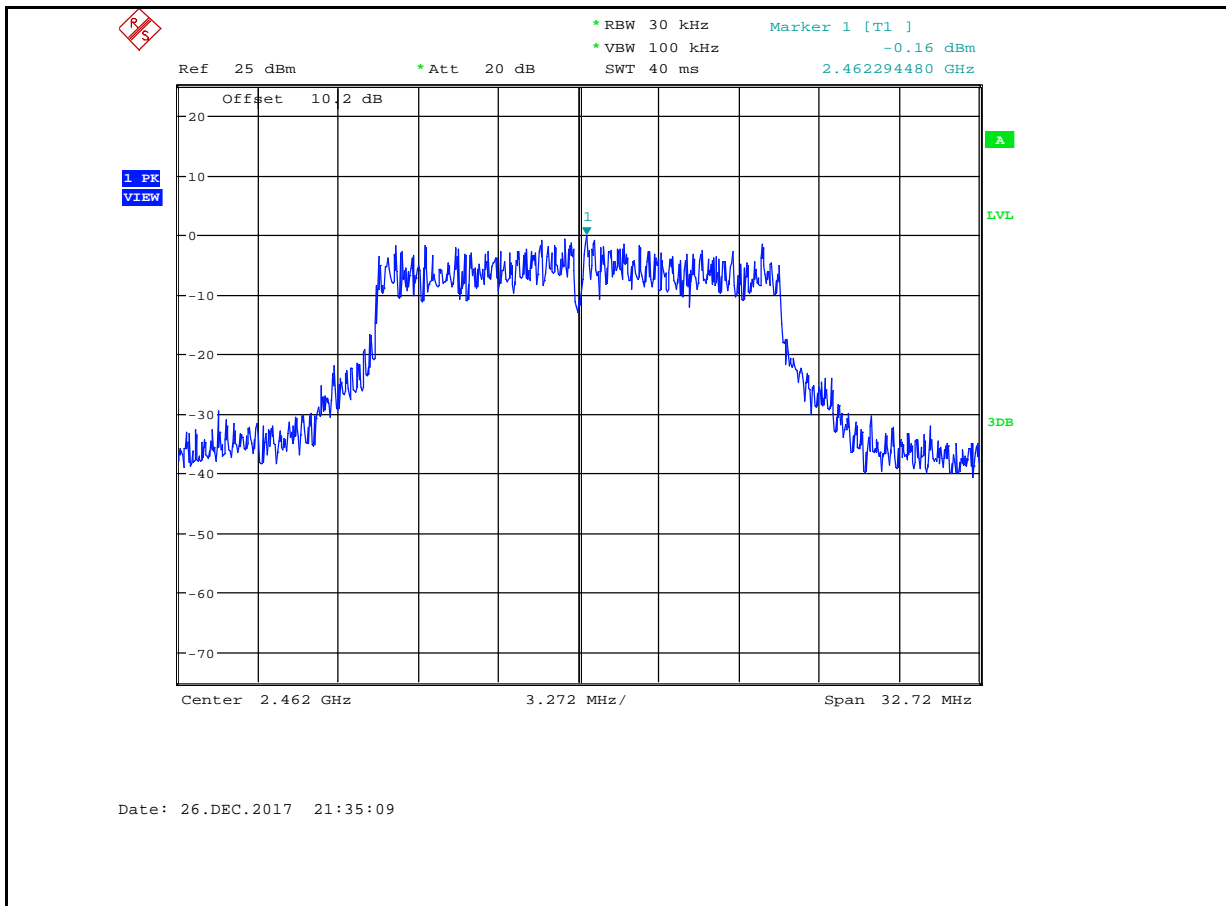

Maximum Peak power spectral density\_11N20SISO\_2412\_Ant1

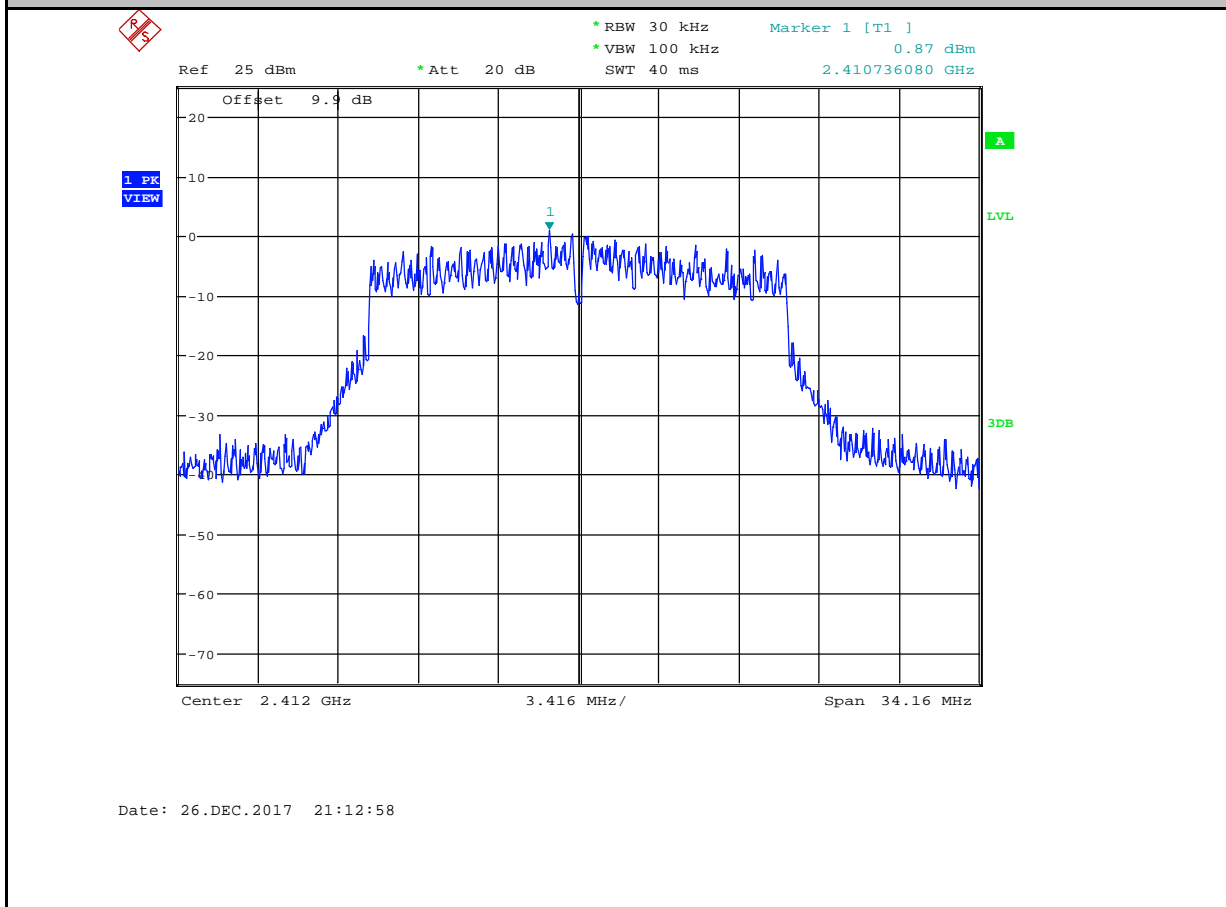

Maximum Peak power spectral density\_11N20SISO\_2412\_Ant2

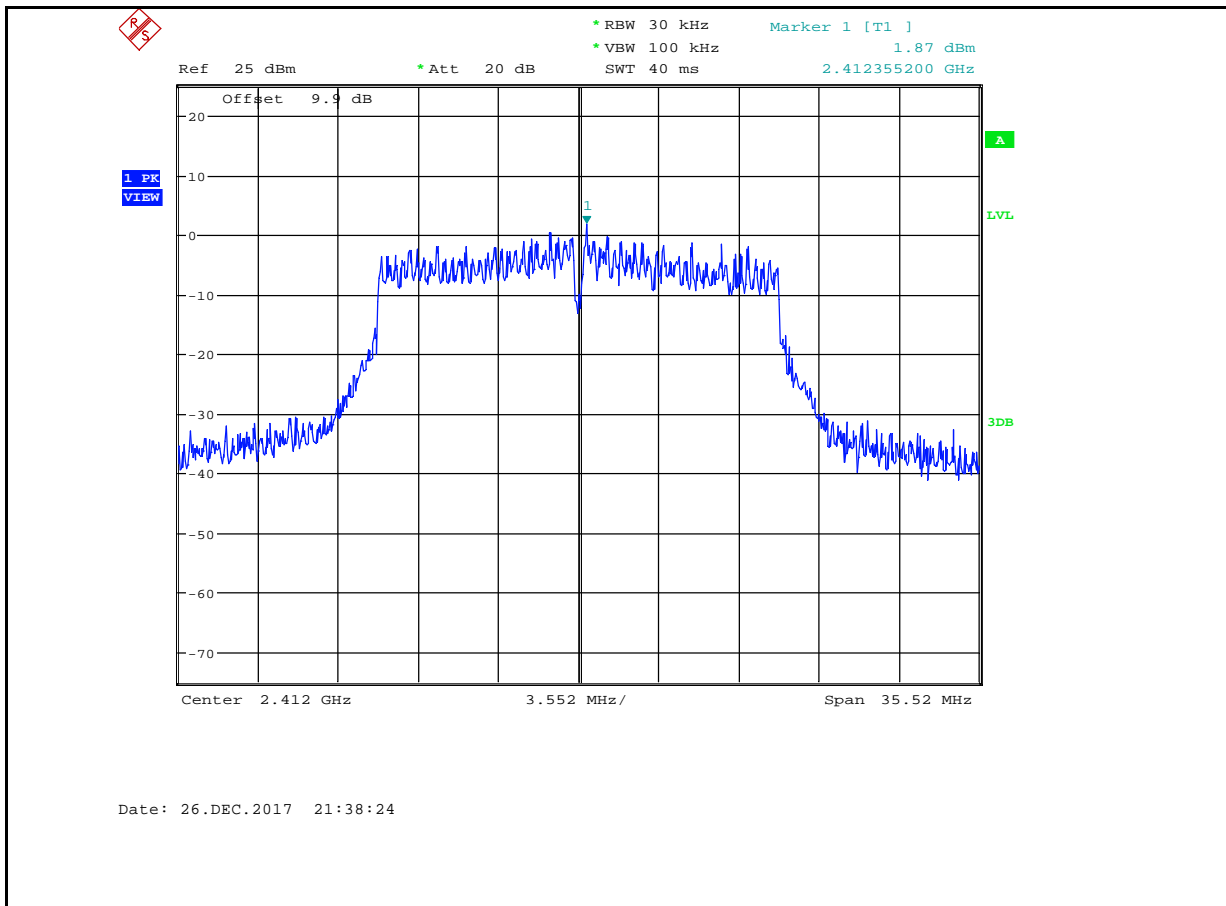

Maximum Peak power spectral density\_11N20SISO\_2437\_Ant1

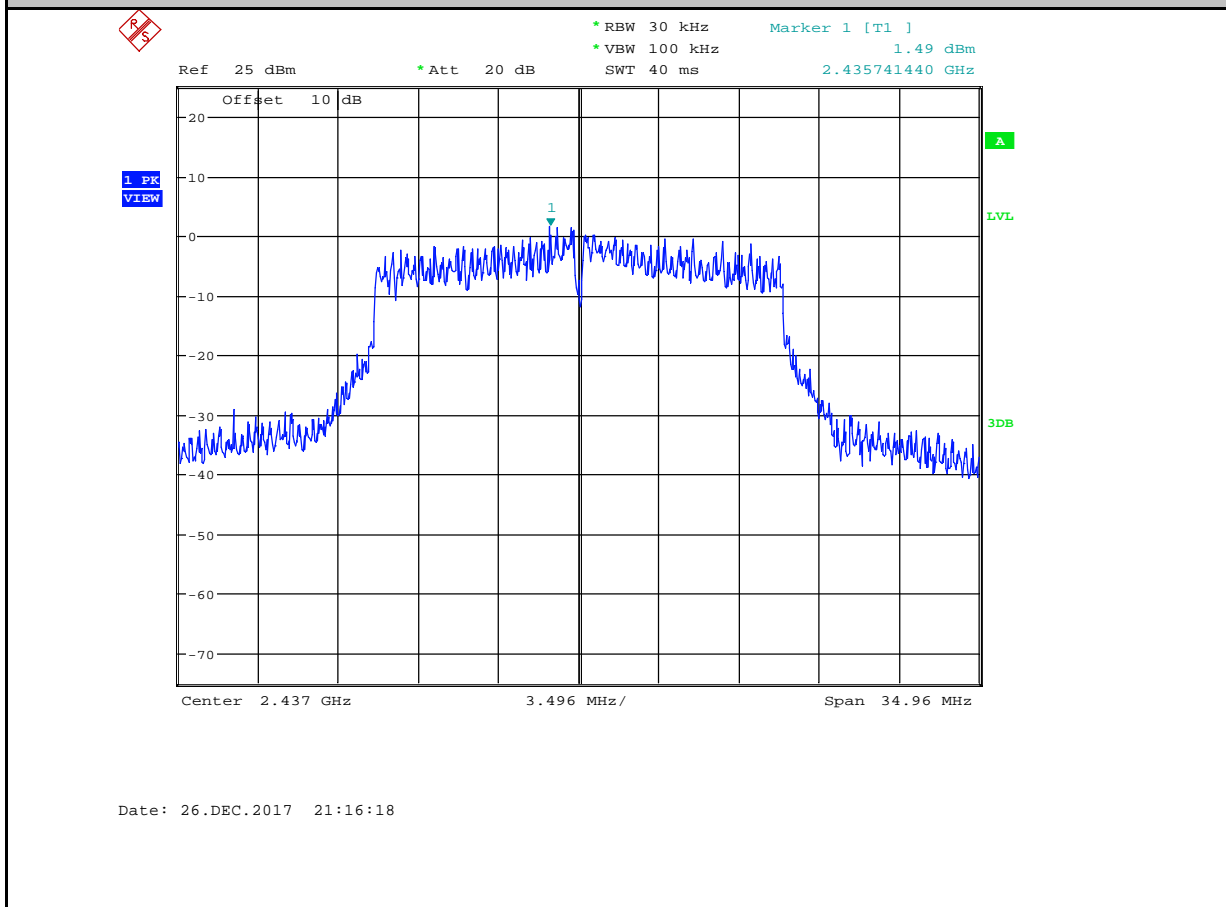

Maximum Peak power spectral density\_11N20SISO\_2437\_Ant2



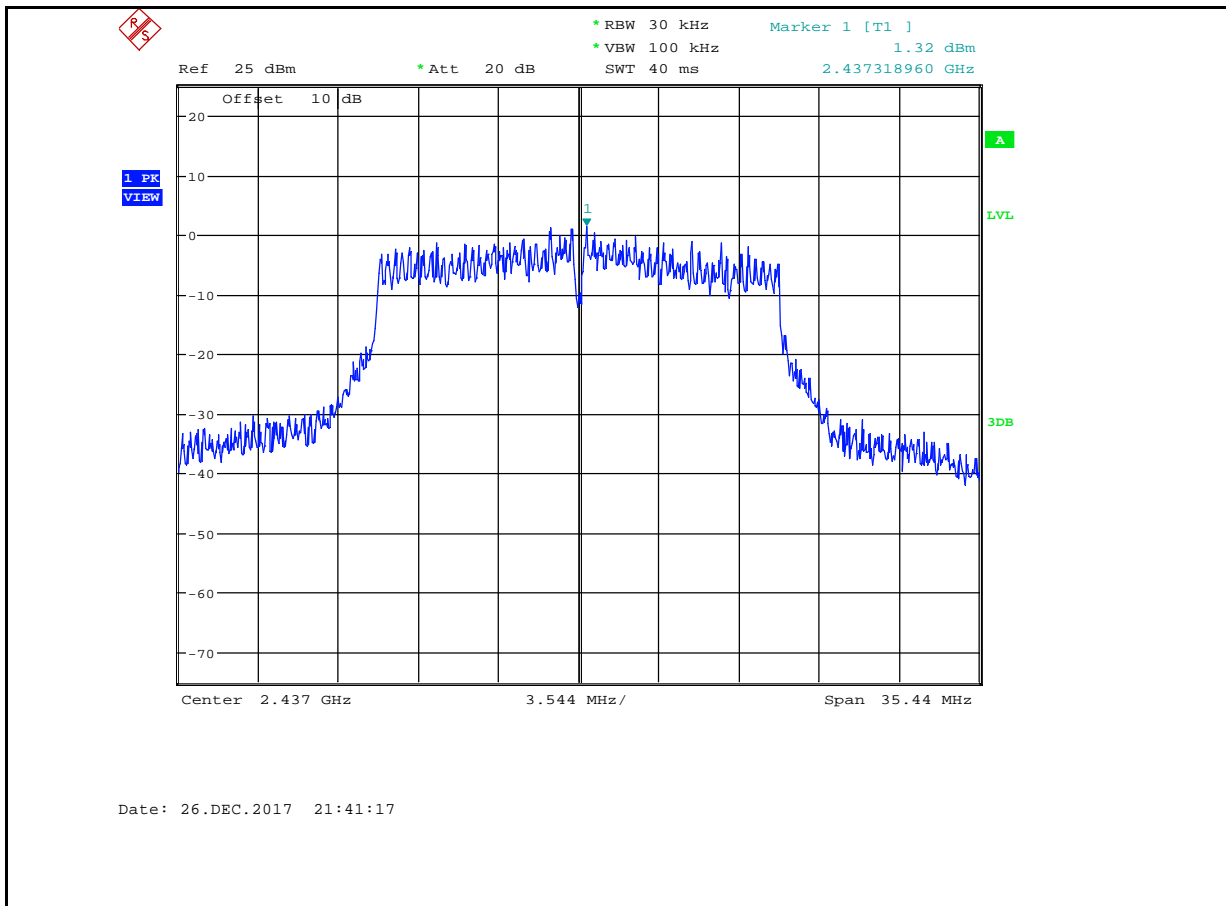

Maximum Peak power spectral density\_11N20SISO\_2462\_Ant1

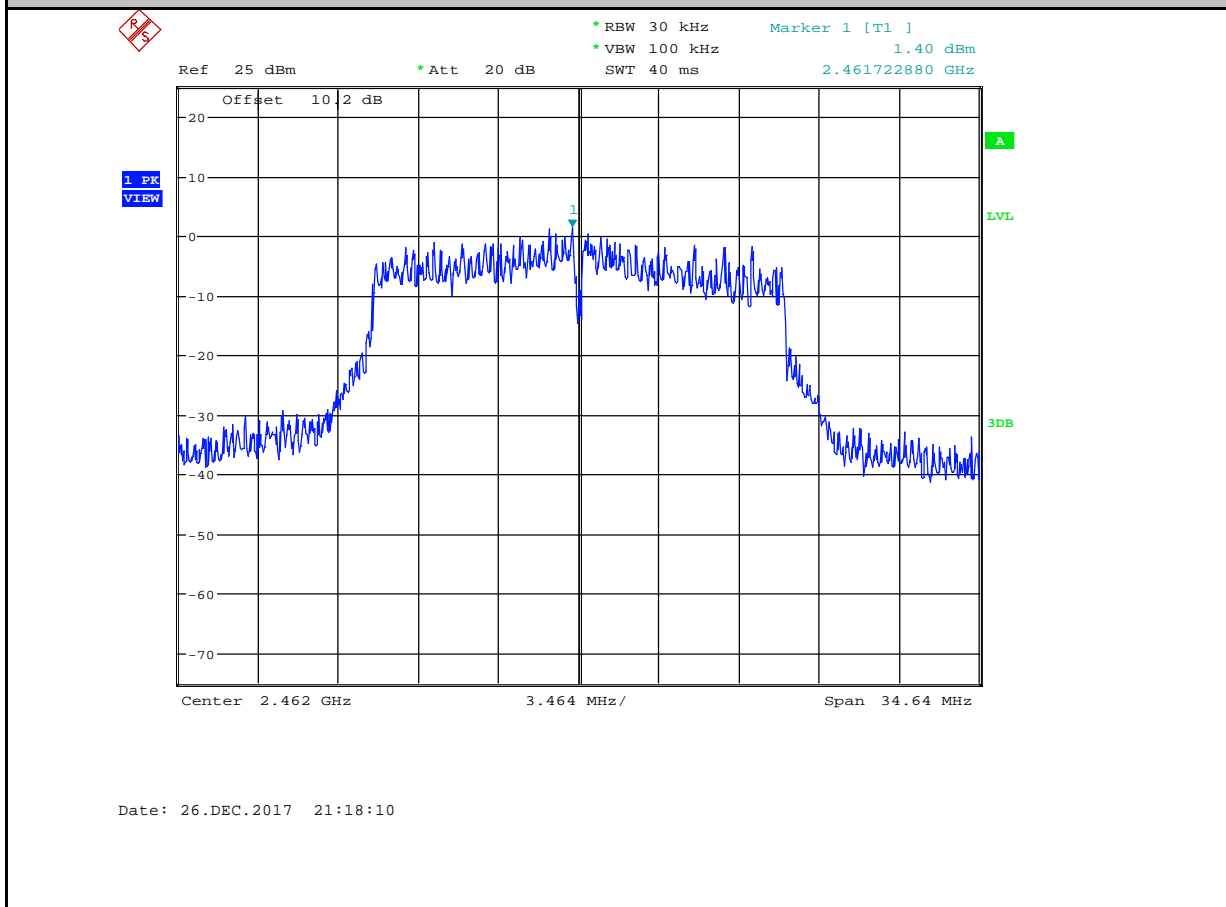

Maximum Peak power spectral density\_11N20SISO\_2462\_Ant2

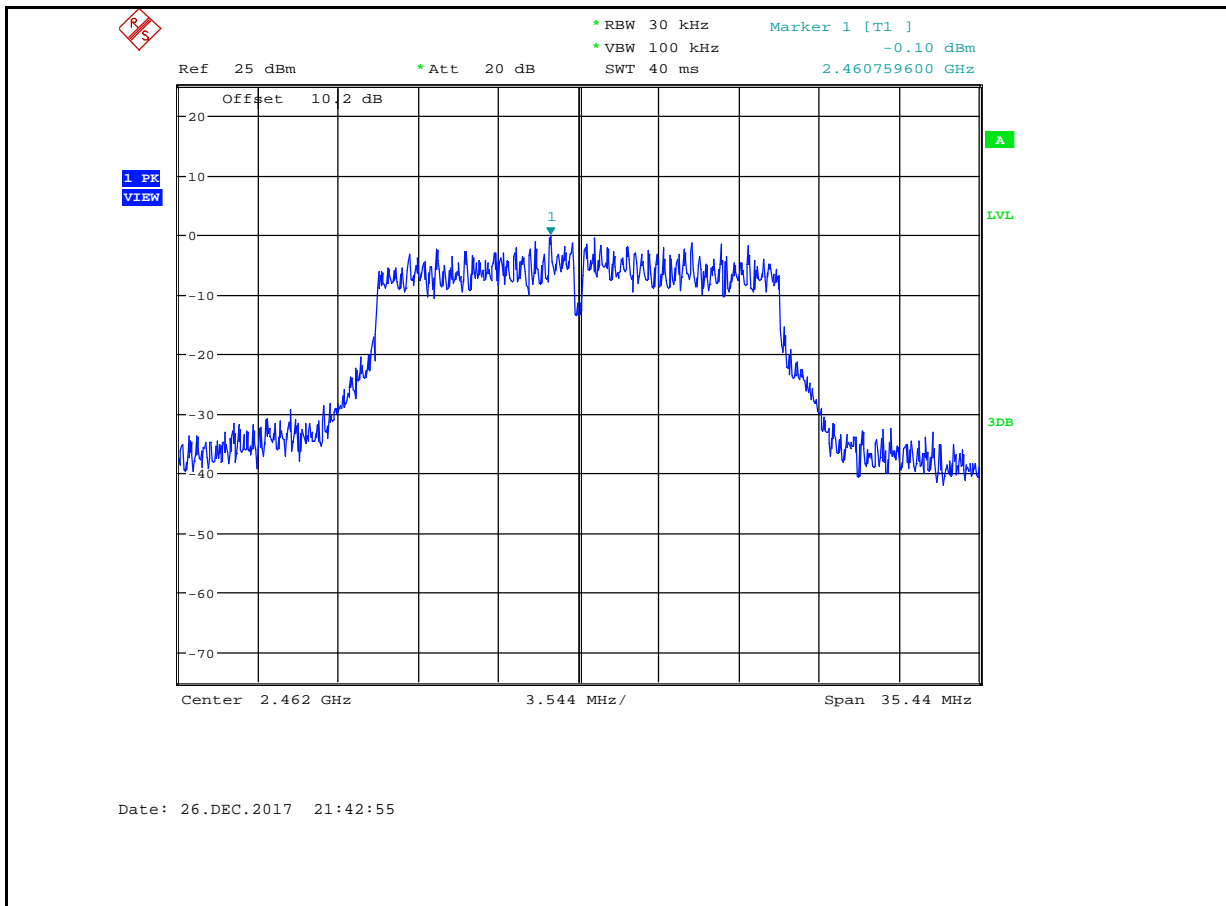

## 6.6. Band Edge and Spurious Emissions (Conducted)

### 6.7. Block diagram of test setup

Same as section 4.1

### 6.8. Limits

In any 100kHz bandwidth outside the frequency bands in which the spread spectrum intentional radiator is operating, the radio frequency power that is produced by the intentional radiator shall be at least 30dB below that in the 100kHz bandwidth within the band that contains the highest level of the desired power.

### 6.9. Test Procedure

(1) Connect EUT's antenna output to spectrum analyzer by RF cable.

(2) Establish a reference level by using the following procedure:

Center frequency	DTS Channel center frequency
RBW:	100KHz
VBW:	300KHz
Span	1.5times the DTS bandwidth
Detector Mode:	Peak
Sweep time:	auto
Trace mode	Max hold

(3) Allow the trace to stabilize, use the peak marker function to determine the maximum peak power level to establish the reference level.

(4) Set the spectrum analyzer as follows:

RBW:	100KHz
VBW:	300KHz
Span	Encompass frequency range to be measured
Number of measurement points	$\geq \text{span/RBW}$
Detector Mode:	Peak
Sweep time:	auto
Trace mode	Max hold

(5) Allow the trace to stabilize, use the peak marker function to determine the maximum amplitude of all unwanted emissions outside of the authorized frequency band

**6.10. Test Result**

EUT Set Mode	CH or Frequency	Ant1 Result (dBm)	EUT Set Mode	CH or Frequency	Ant1 Result (dBm)
11b	CH1	PASS	11n HT 20	CH1	PASS
	CH6	PASS		CH6	PASS
	CH11	PASS		CH11	PASS
11g	CH1	PASS	/	/	/
	CH6	PASS		/	/
	CH11	PASS		/	/

EUT Set Mode	CH or Frequency	Ant2 Result (dBm)	EUT Set Mode	CH or Frequency	Ant2 Result (dBm)
11b	CH1	PASS	11n HT 20	CH1	PASS
	CH6	PASS		CH6	PASS
	CH11	PASS		CH11	PASS
11g	CH1	PASS	/	/	/
	CH6	PASS		/	/
	CH11	PASS		/	/

**6.11. original test data**

Band Edge

Band-edge for RF Conducted Emissions\_11B\_2412\_Ant1

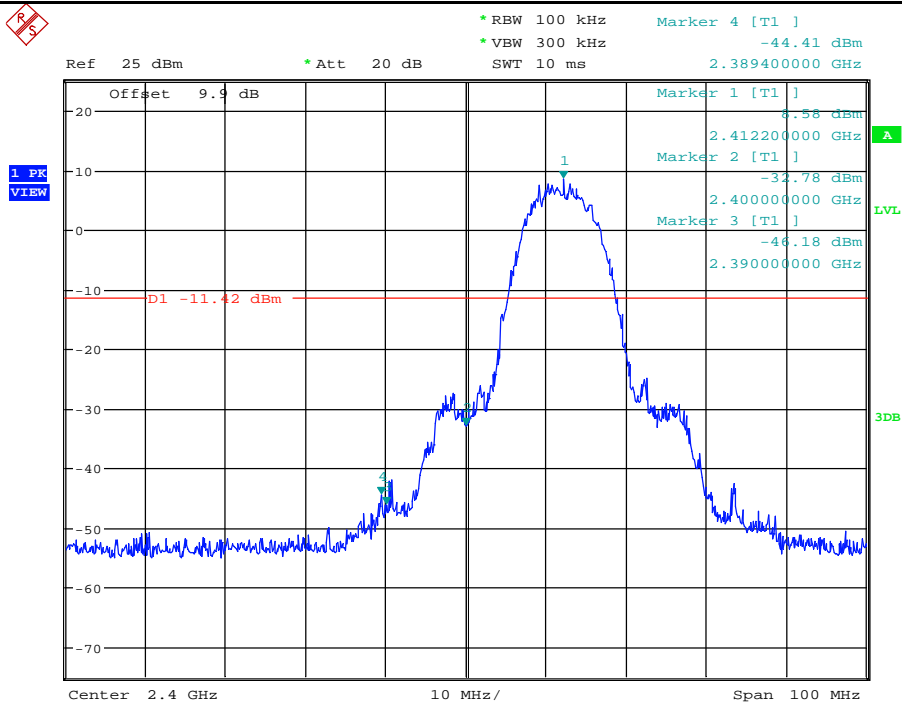

Date: 26.DEC.2017 20:46:07

Band-edge for RF Conducted Emissions\_11B\_2412\_Ant2

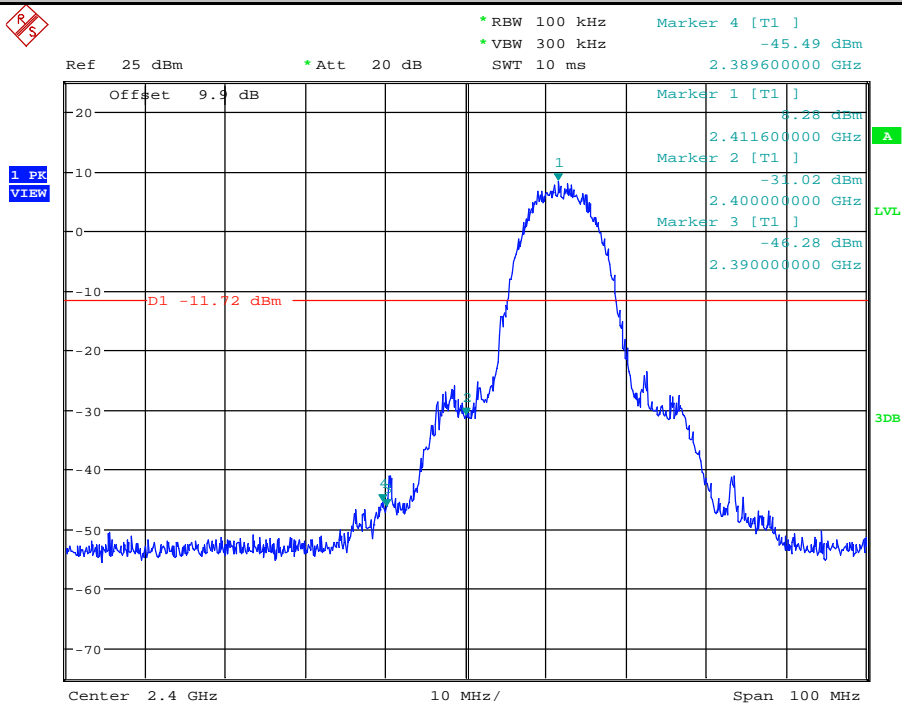

Date: 26.DEC.2017 20:49:16

Band-edge for RF Conducted Emissions\_11B\_2462\_Ant1

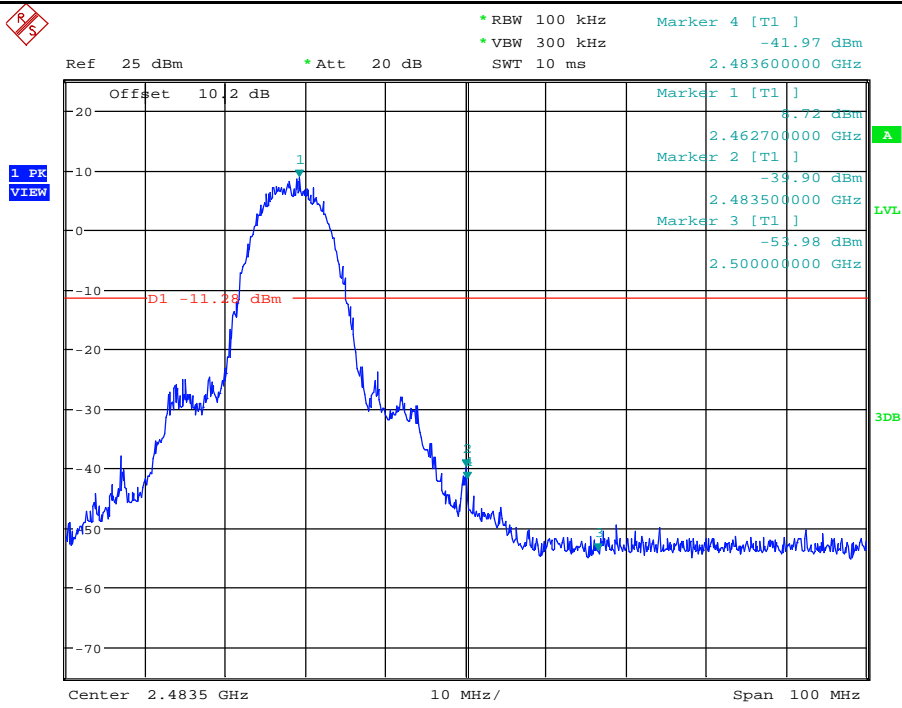

Date: 26.DEC.2017 20:59:34

Band-edge for RF Conducted Emissions\_11B\_2462\_Ant2

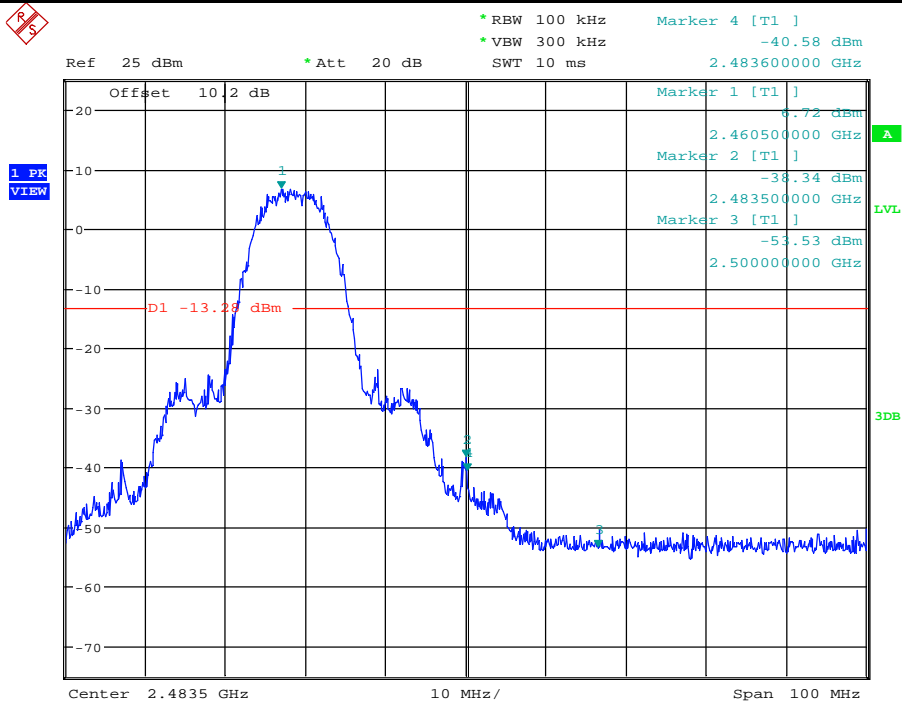

Date: 26.DEC.2017 21:26:59

Band-edge for RF Conducted Emissions\_11G\_2412\_Ant1

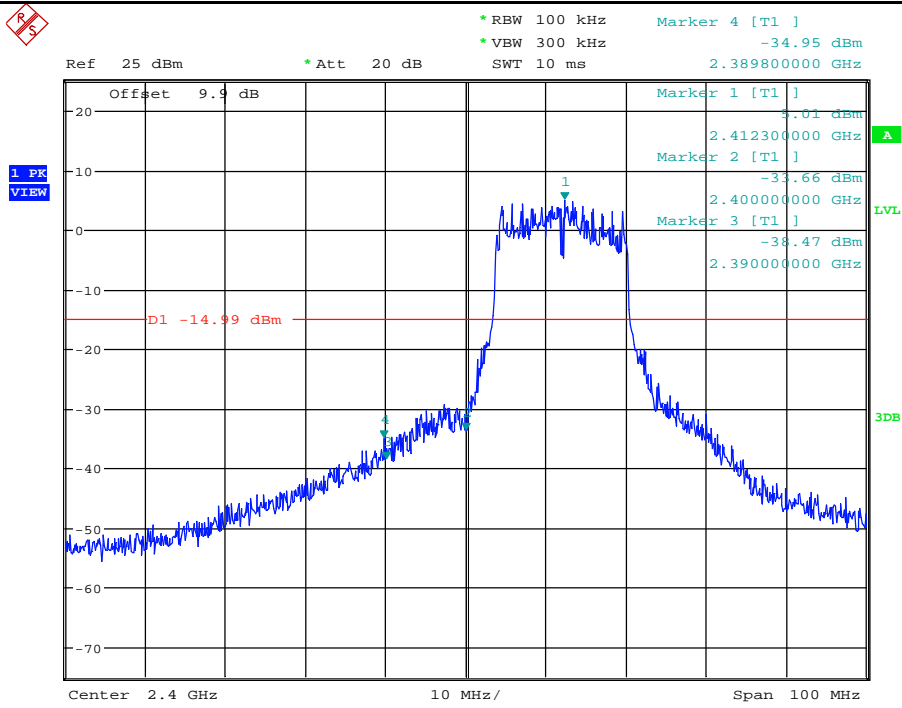

Date: 26.DEC.2017 21:05:13

### Band-edge for RF Conducted Emissions\_11G\_2412\_Ant2

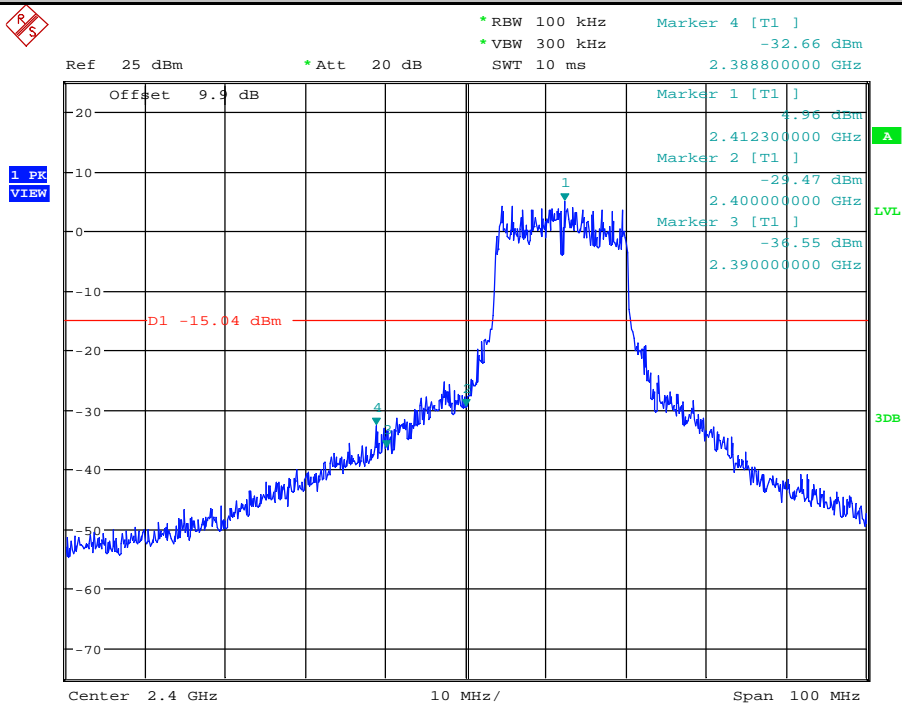

Date: 26.DEC.2017 21:29:41

### Band-edge for RF Conducted Emissions\_11G\_2462\_Ant1

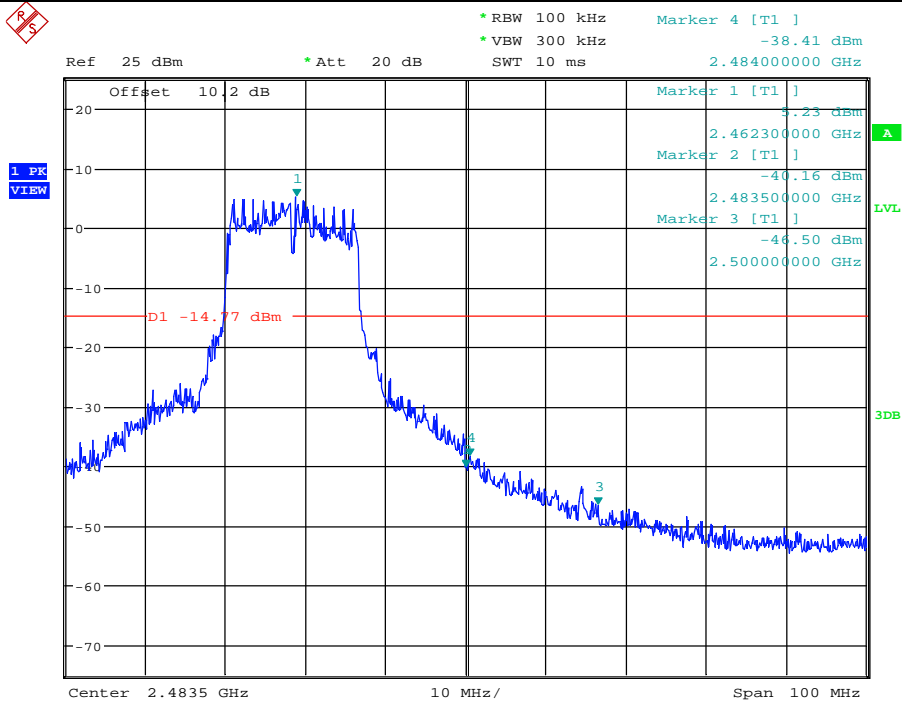

Date: 26.DEC.2017 21:10:13

Band-edge for RF Conducted Emissions\_11G\_2462\_Ant2

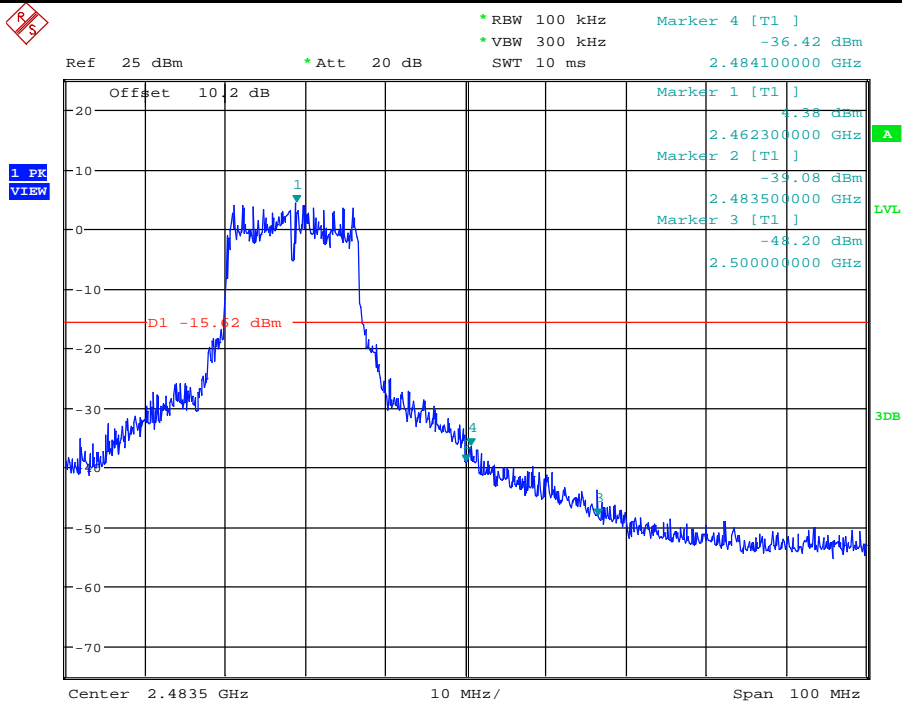

Date: 26.DEC.2017 21:35:24

Band-edge for RF Conducted Emissions\_11N20SISO\_2412\_Ant1



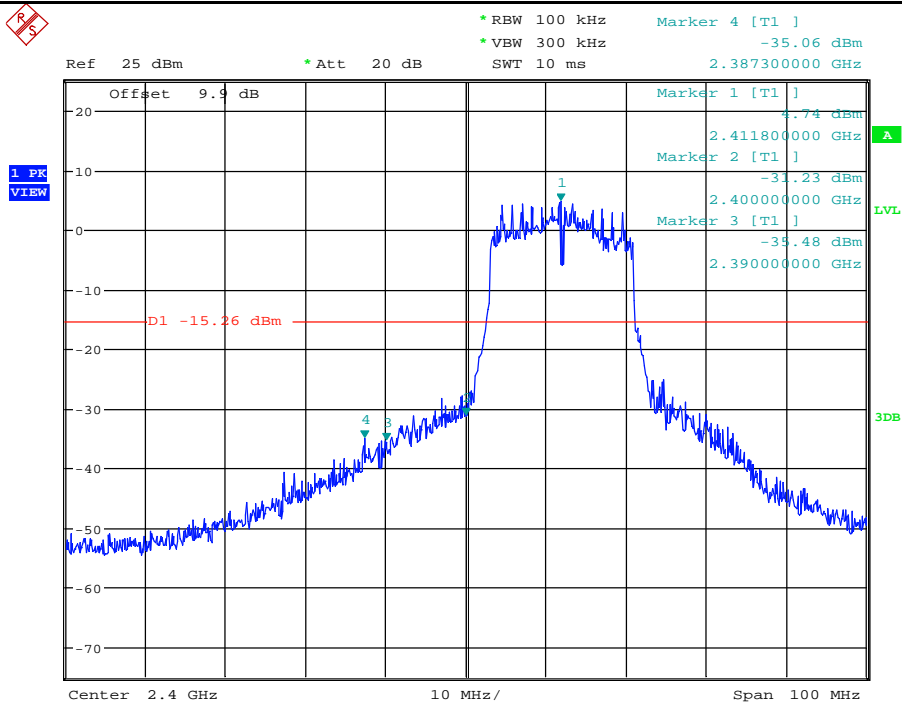

Date: 26.DEC.2017 21:13:14

Band-edge for RF Conducted Emissions\_11N20SISO\_2412\_Ant2

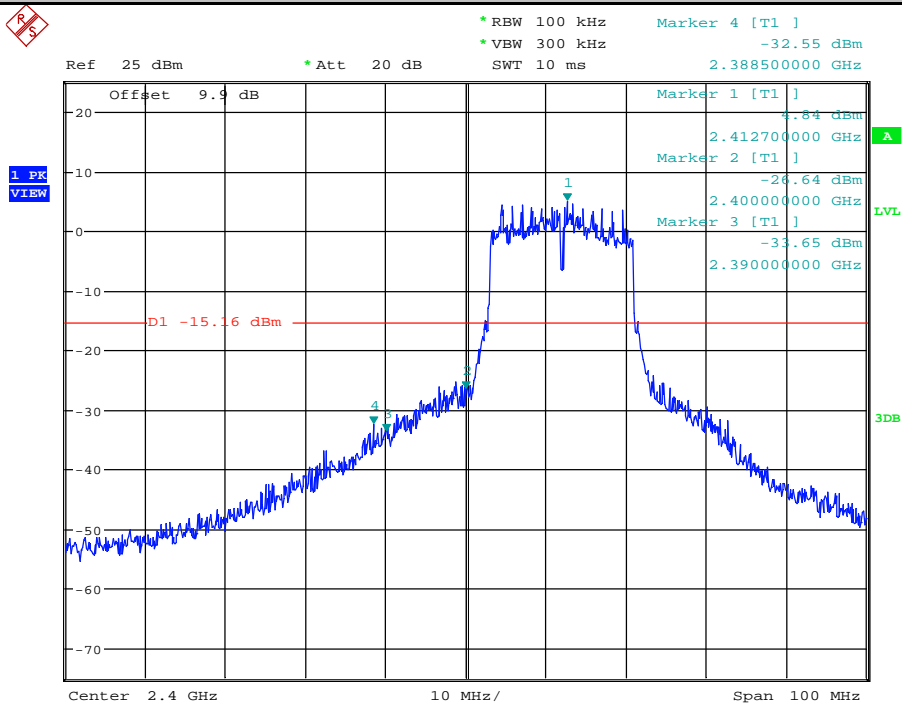

Date: 26.DEC.2017 21:38:40

Band-edge for RF Conducted Emissions\_11N20SISO\_2462\_Ant1

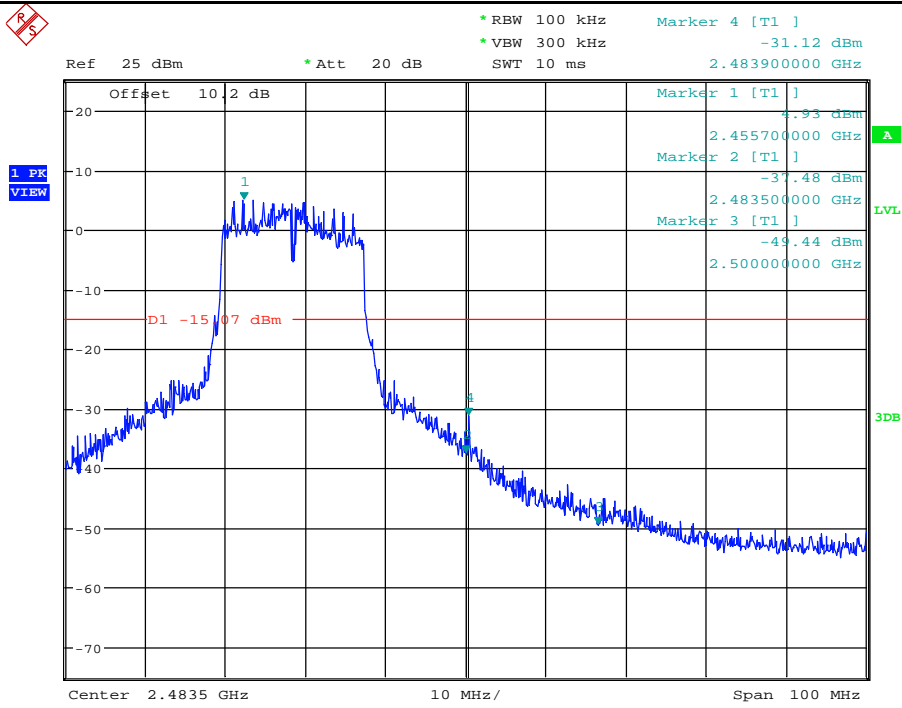

Date: 26.DEC.2017 21:18:25

Band-edge for RF Conducted Emissions\_11N20SISO\_2462\_Ant2

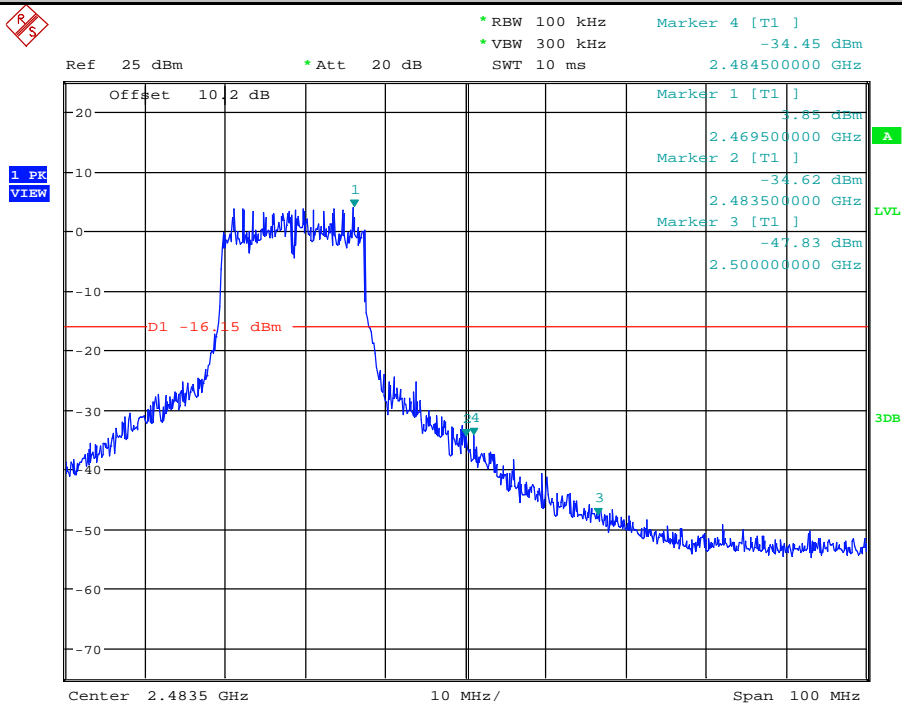

Date: 26.DEC.2017 21:43:11

Spurious Emissions

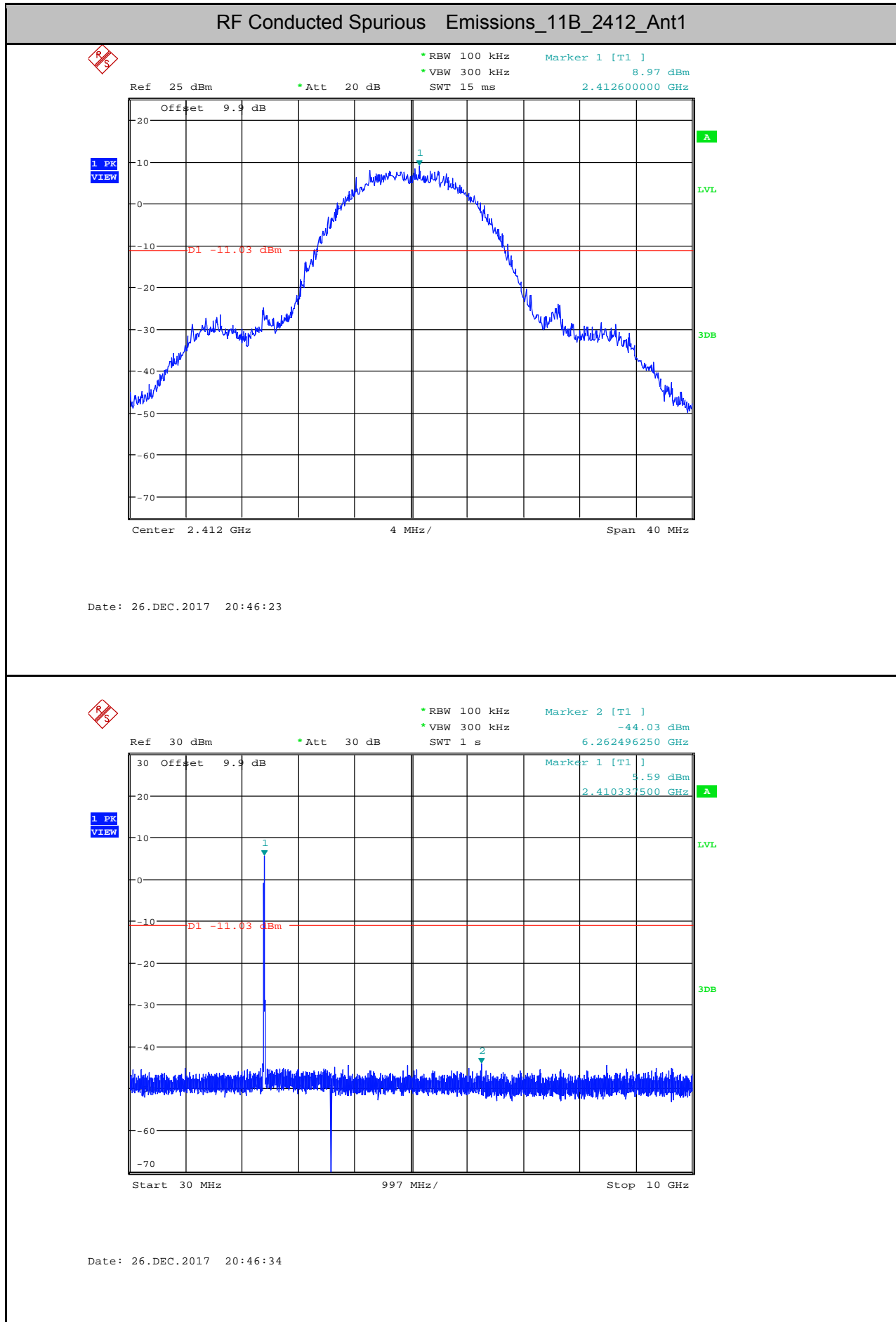

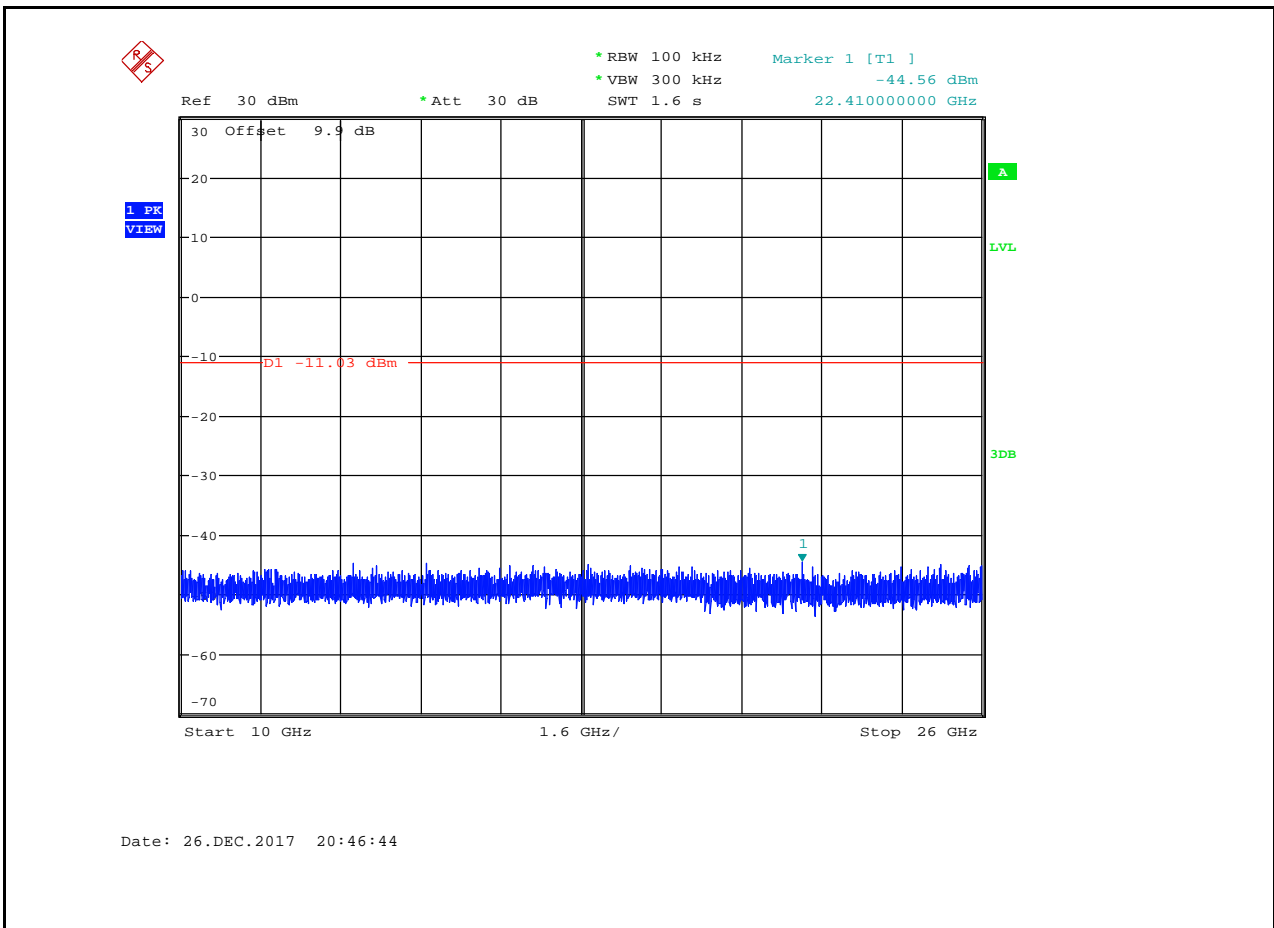

RF Conducted Spurious Emissions\_11B\_2412\_Ant2

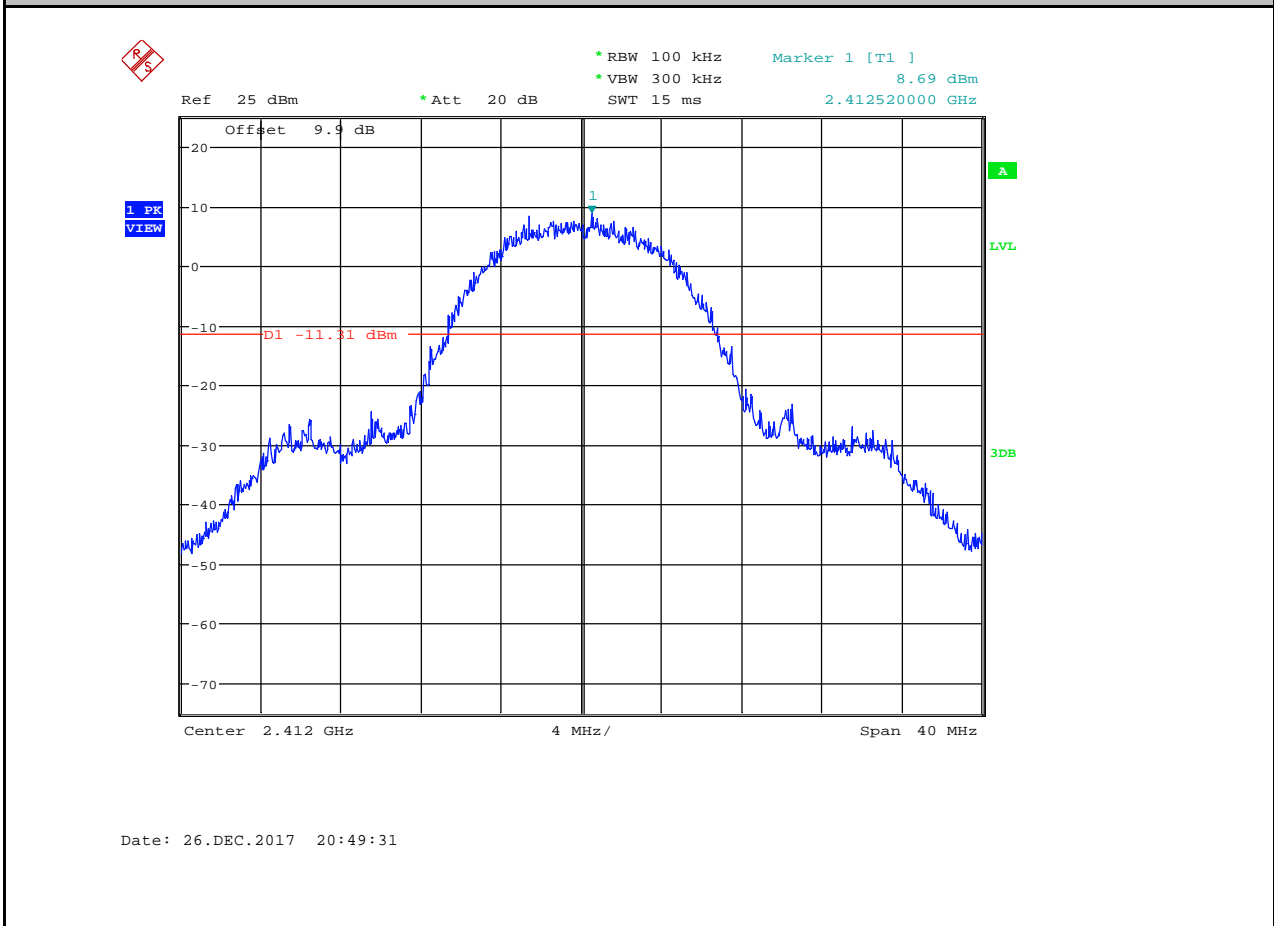

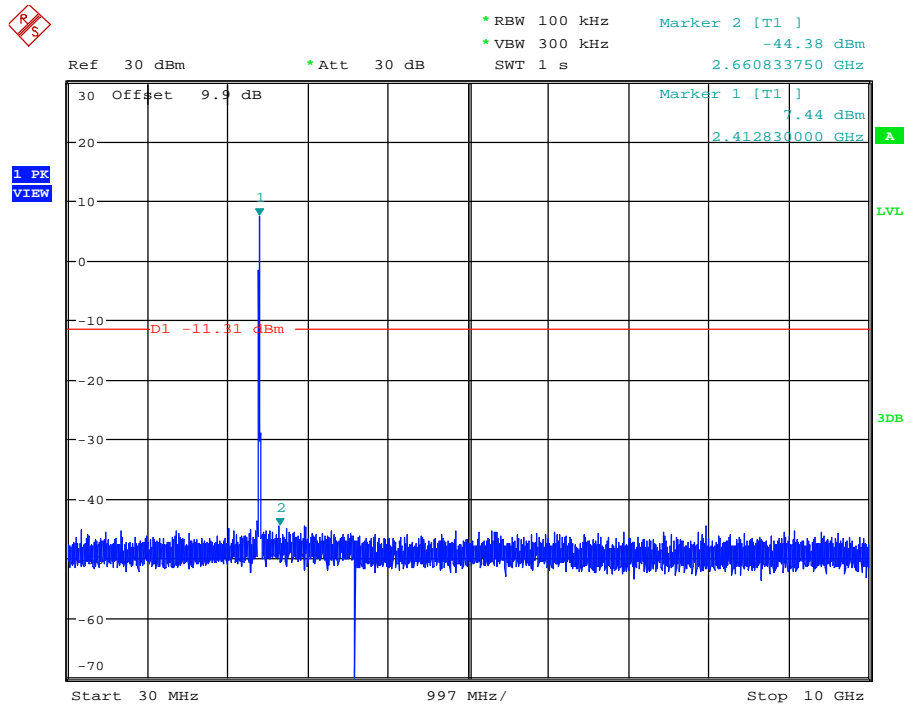

Date: 26.DEC.2017 20:49:43

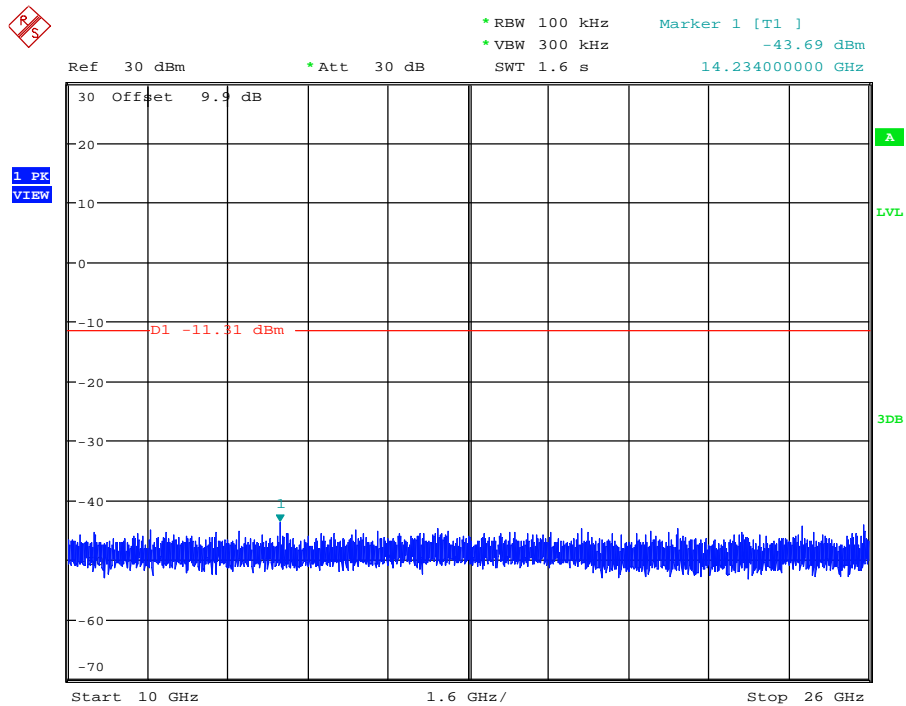

Date: 26.DEC.2017 20:49:53

RF Conducted Spurious Emissions\_11B\_2462\_Ant1

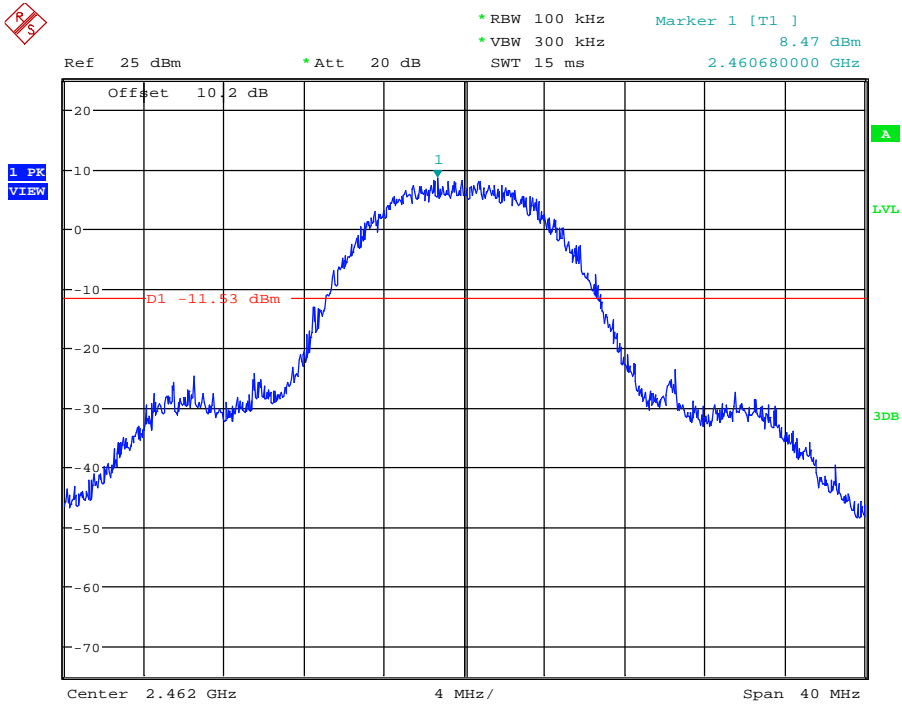

Date: 26.DEC.2017 20:59:50

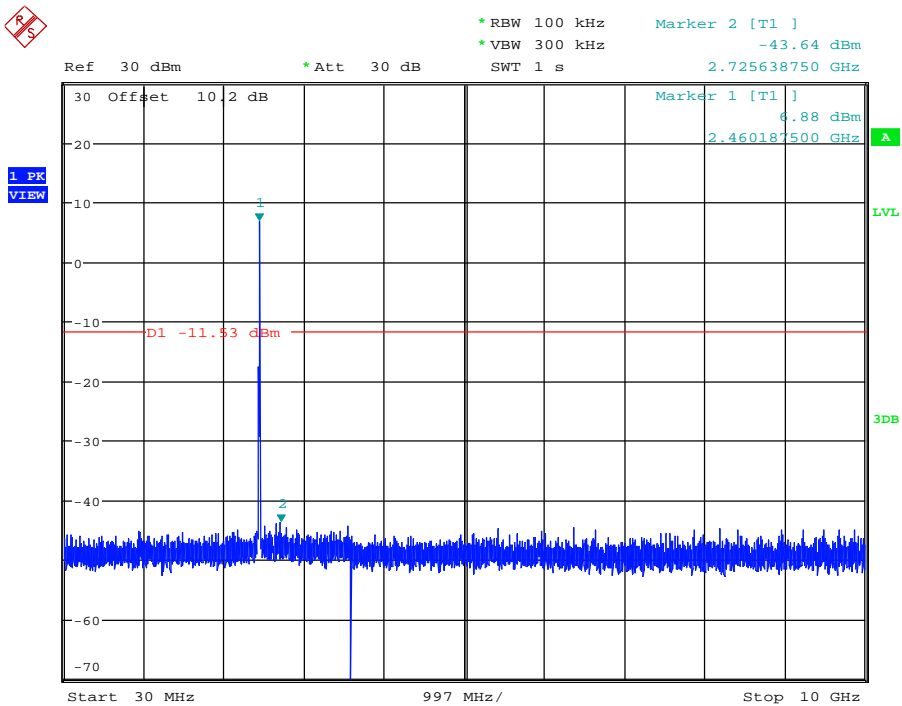

Date: 26.DEC.2017 21:00:01

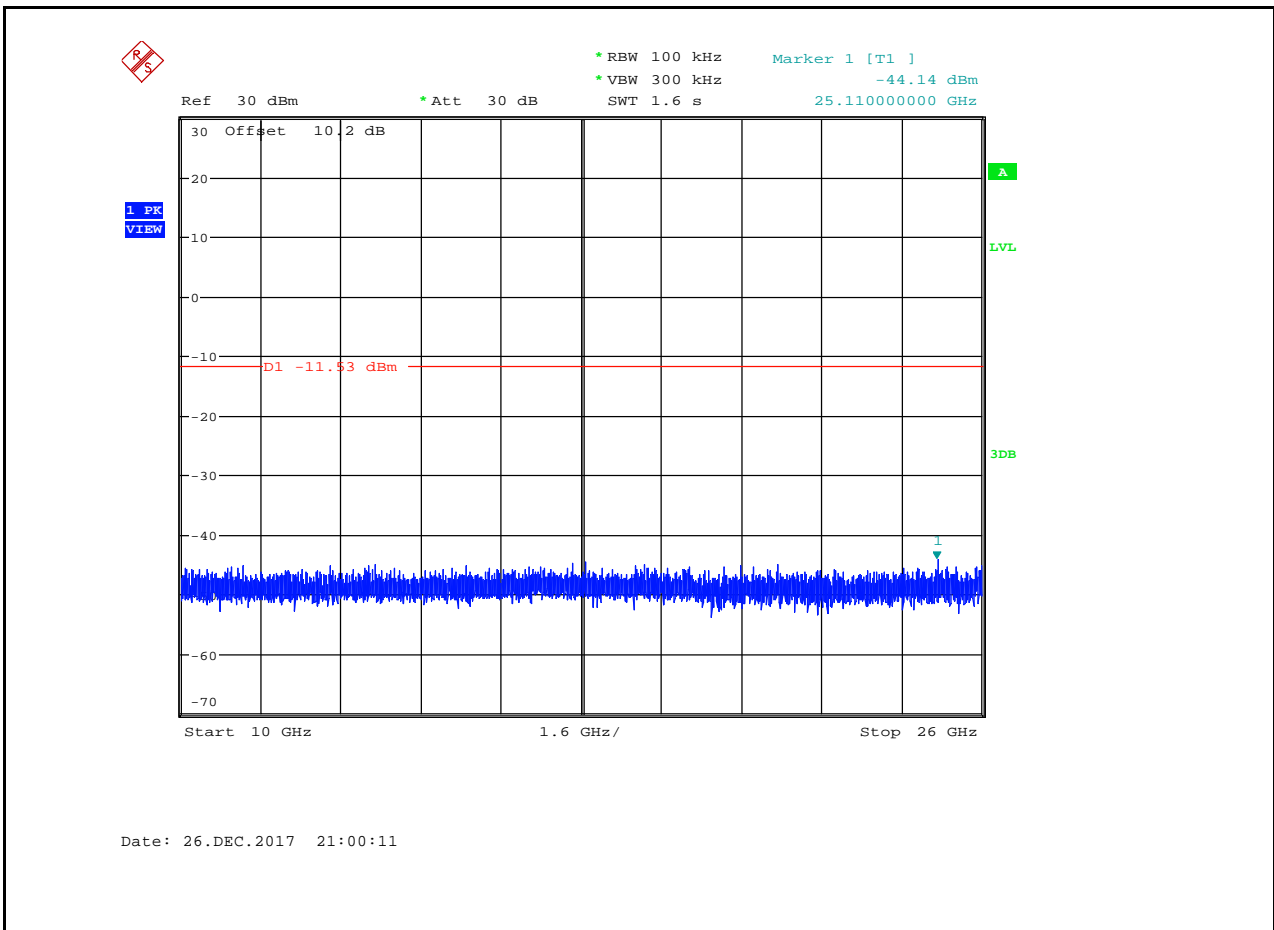

RF Conducted Spurious Emissions\_11B\_2462\_Ant2

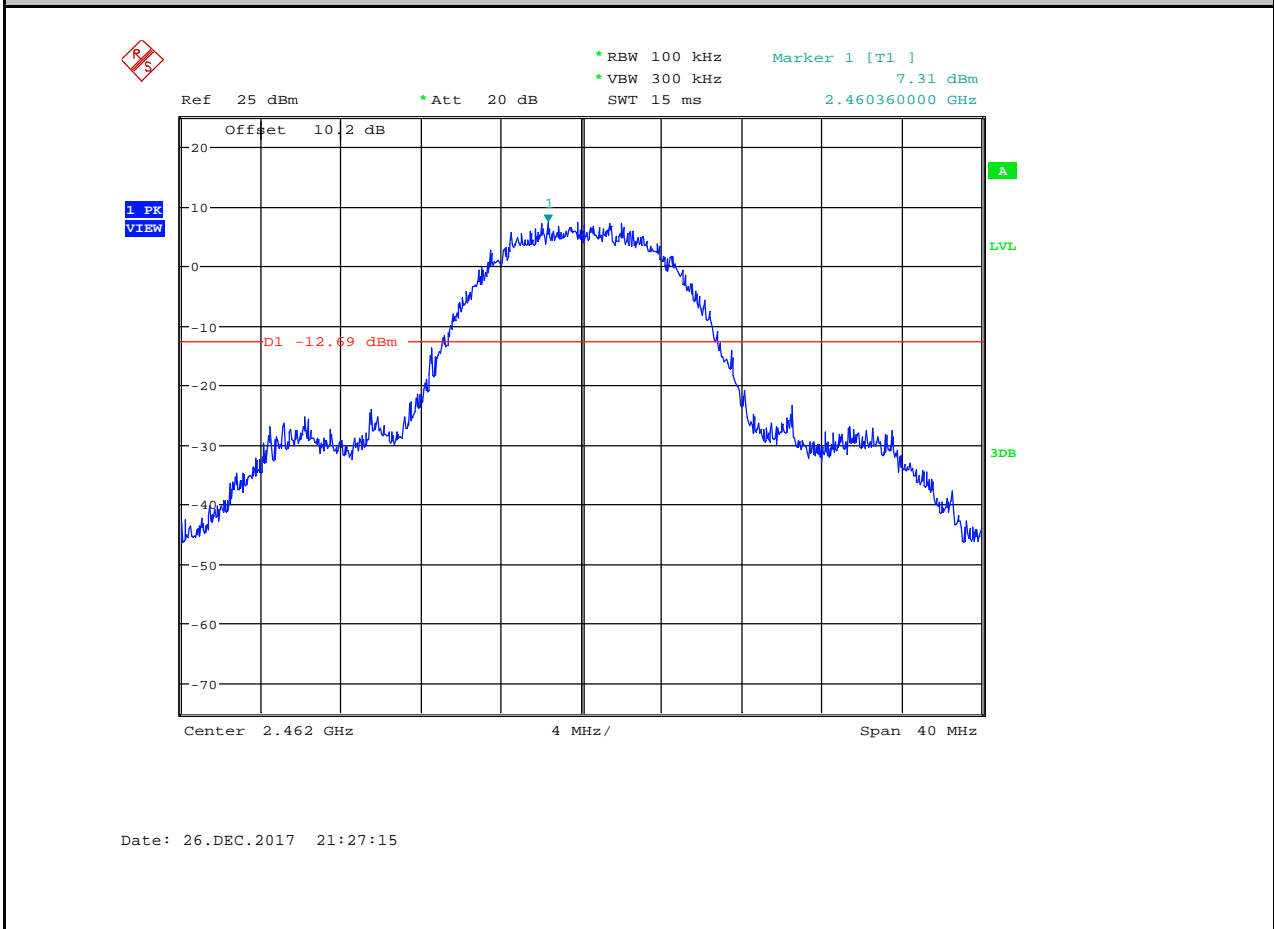

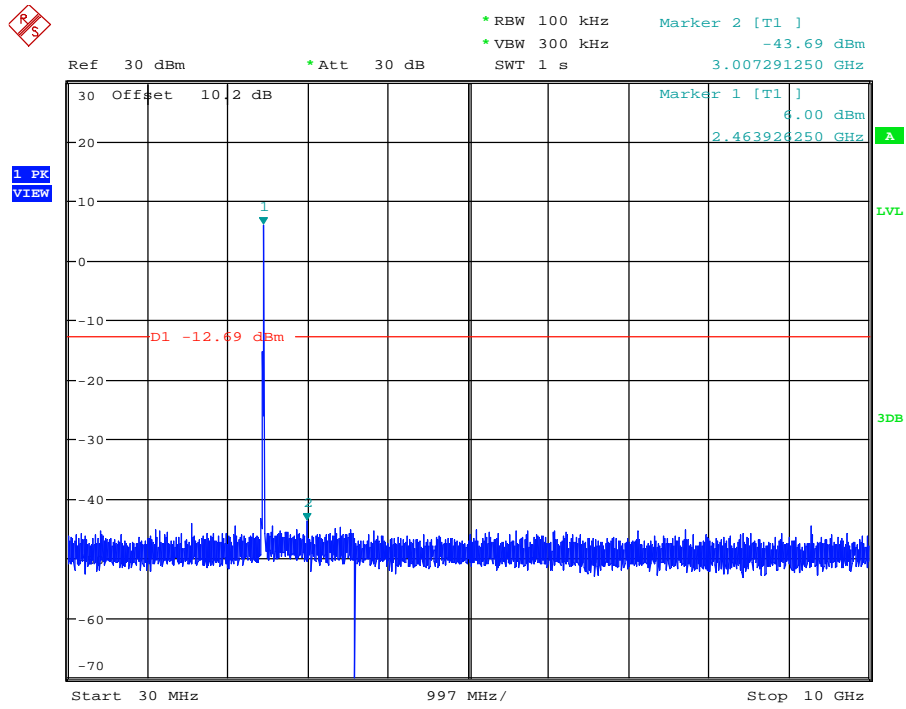

Date: 26.DEC.2017 21:27:26

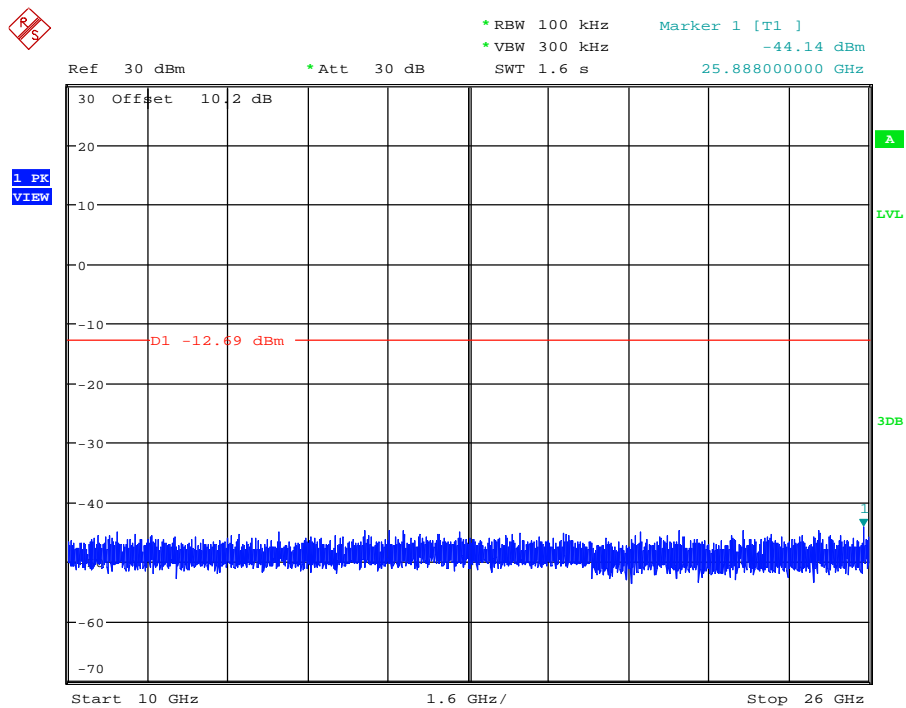

Date: 26.DEC.2017 21:27:43

RF Conducted Spurious Emissions\_11G\_2412\_Ant1



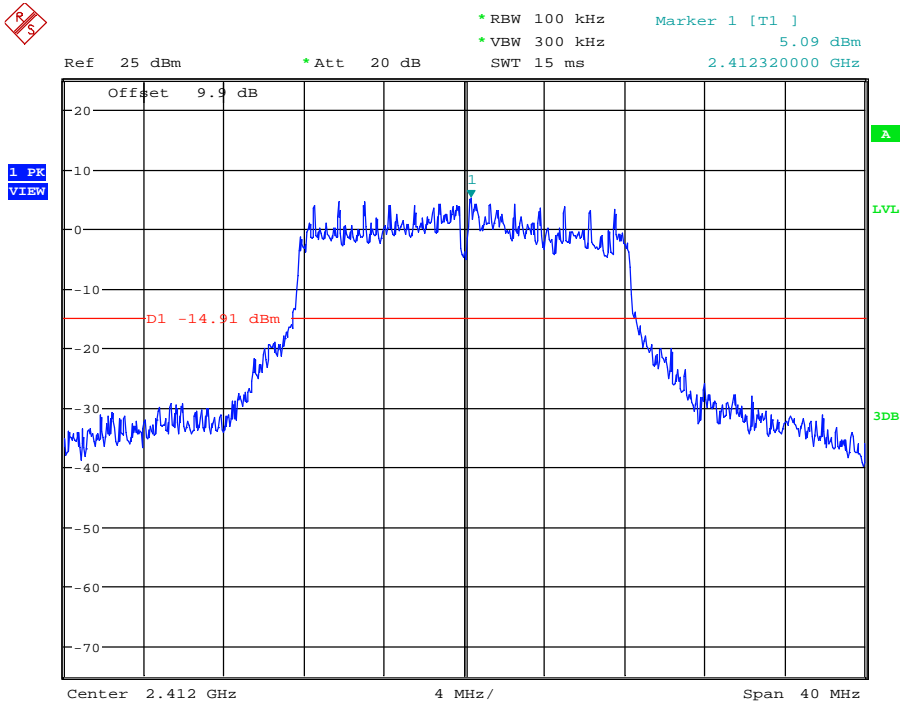

Date: 26.DEC.2017 21:05:29

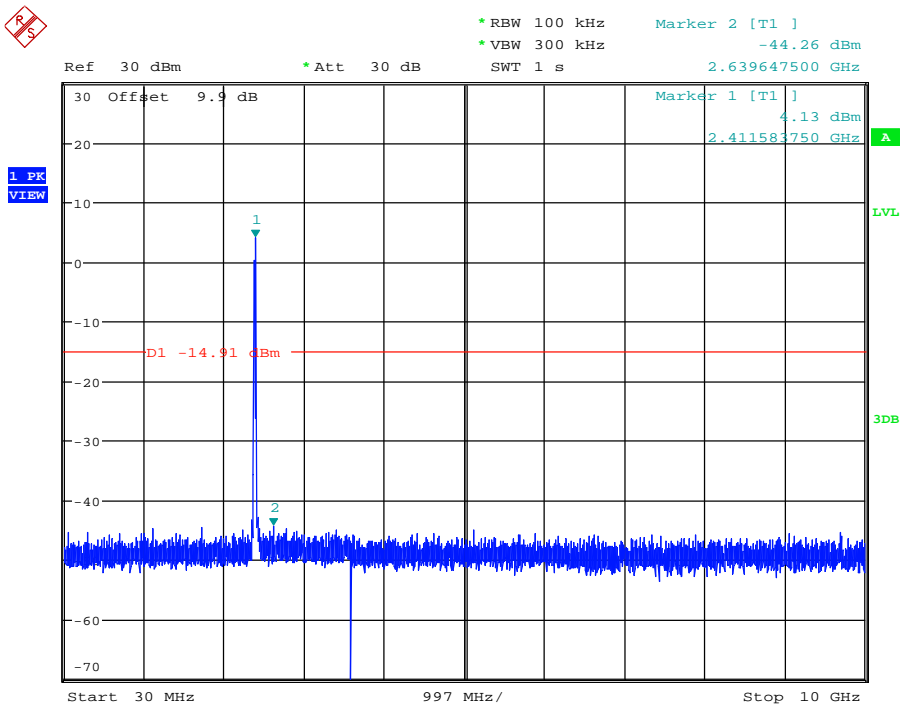

Date: 26.DEC.2017 21:05:40

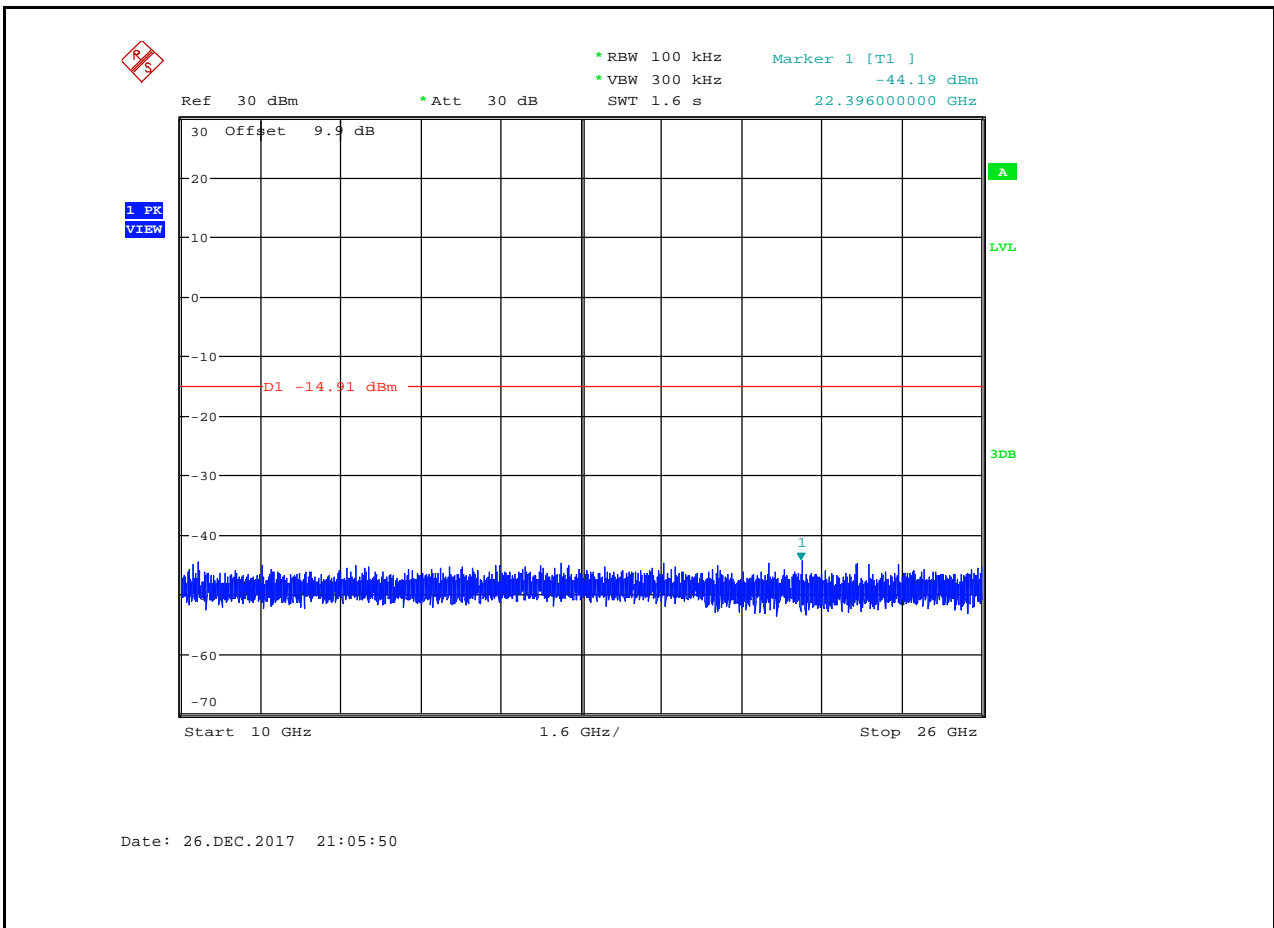

RF Conducted Spurious Emissions\_11G\_2412\_Ant2

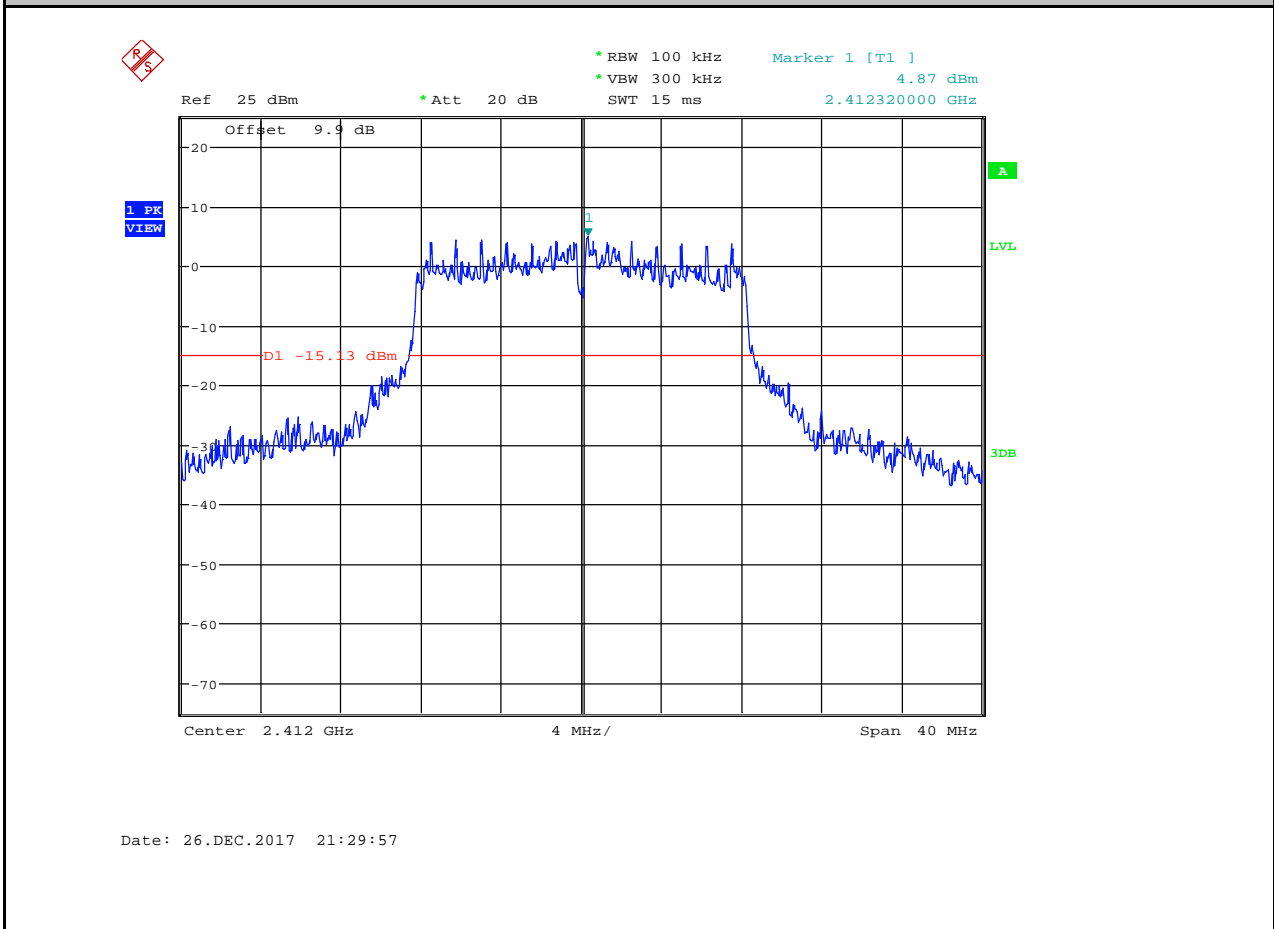

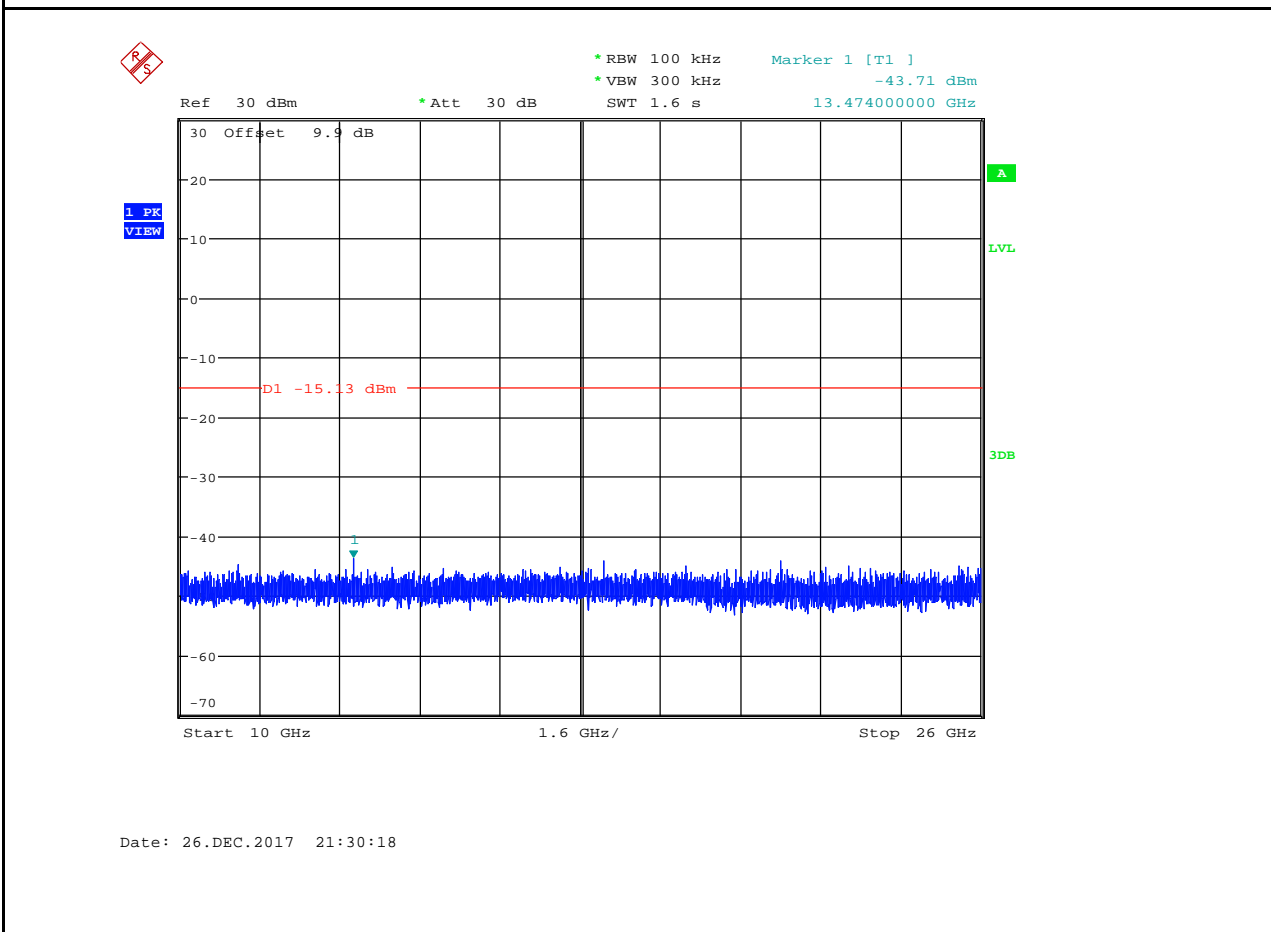
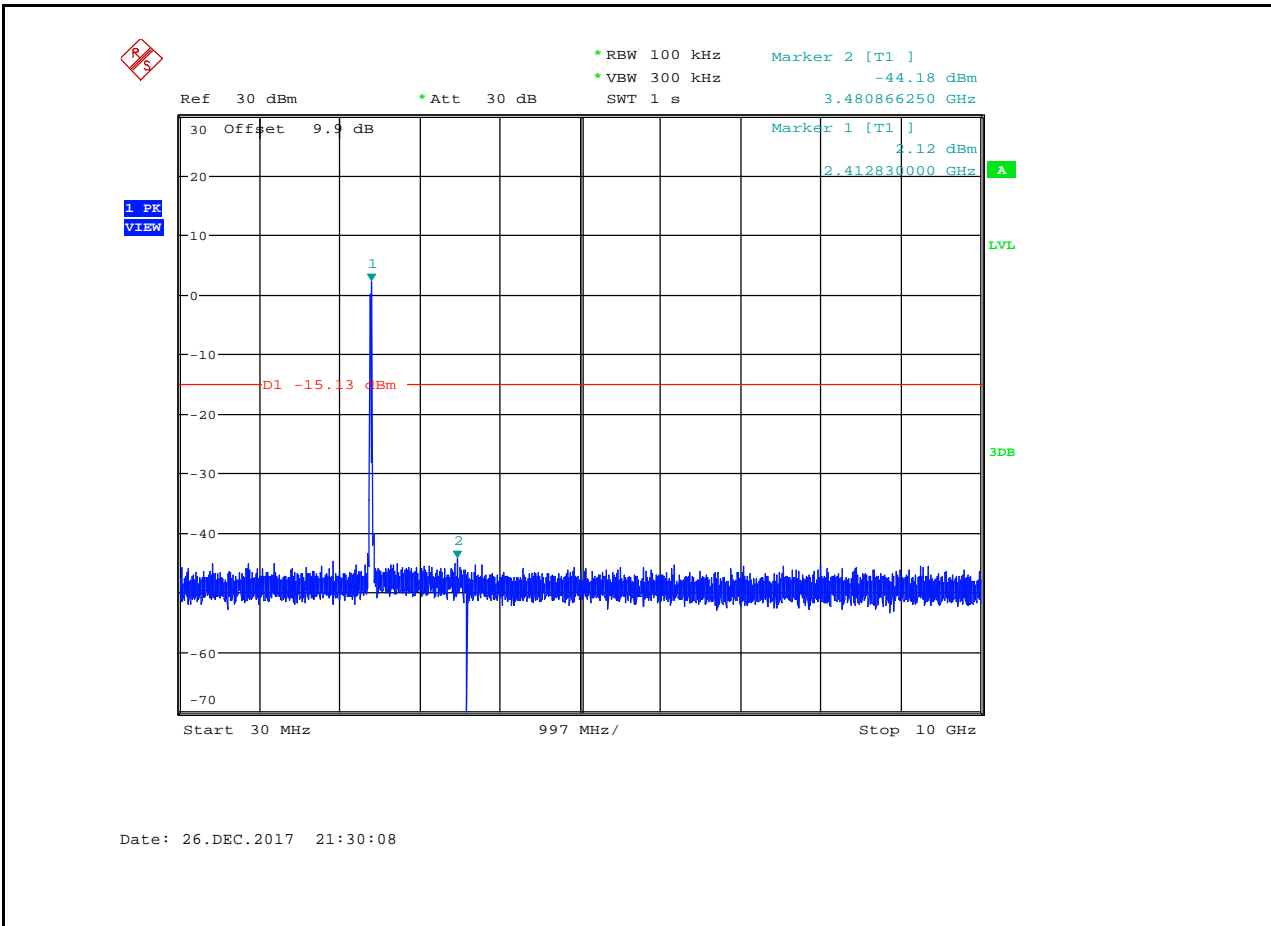

RF Conducted Spurious Emissions\_11G\_2462\_Ant1

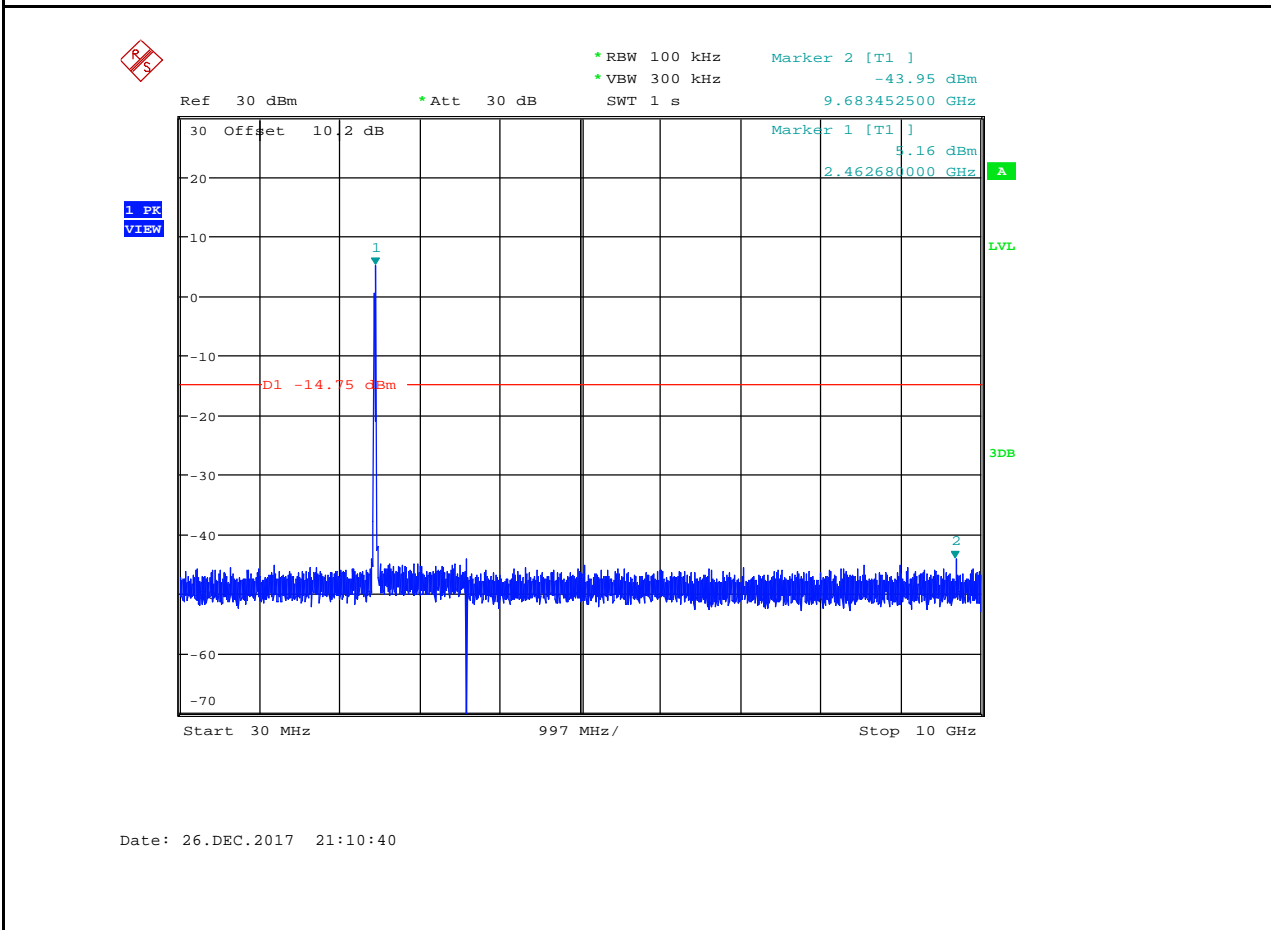
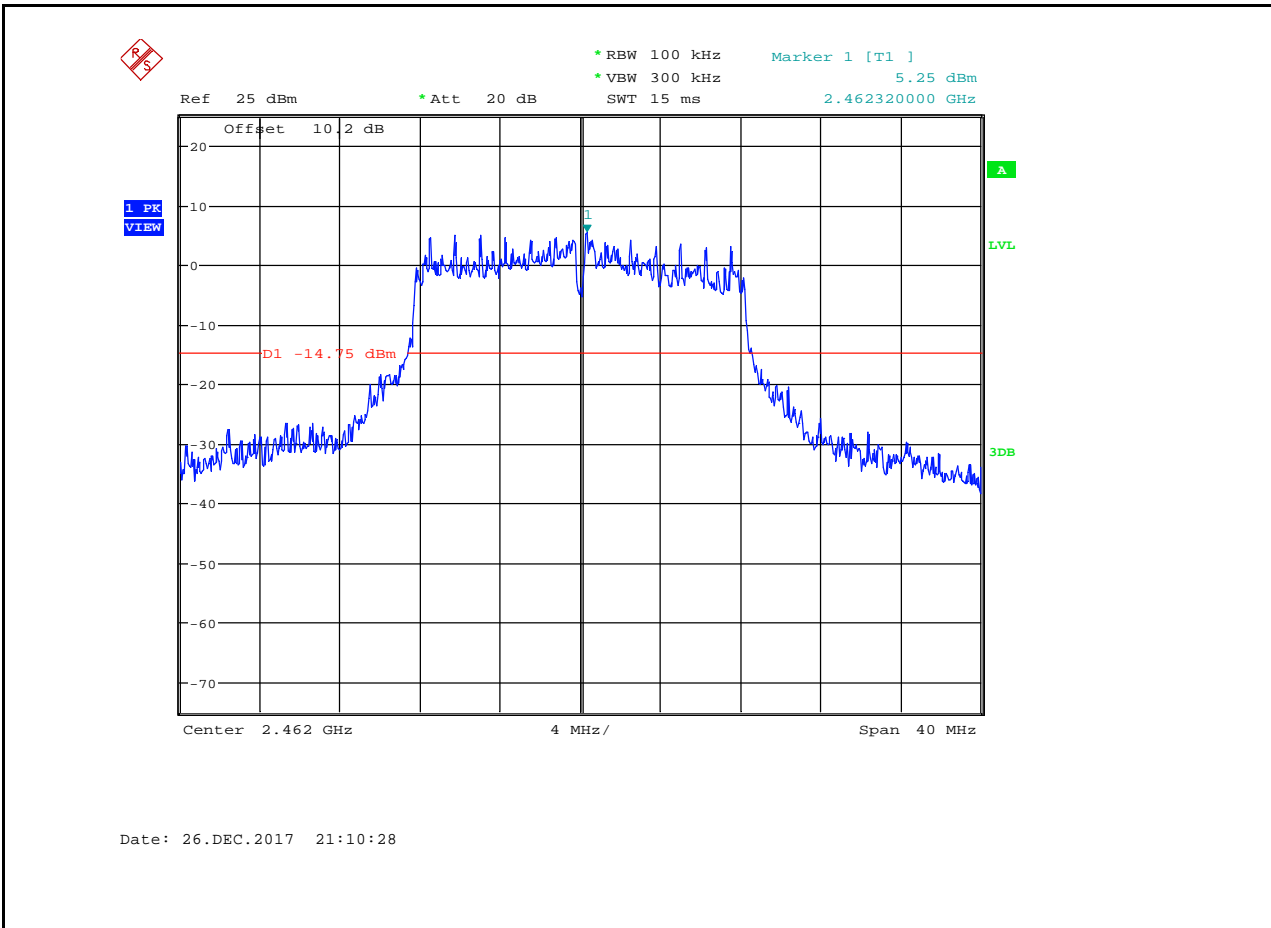

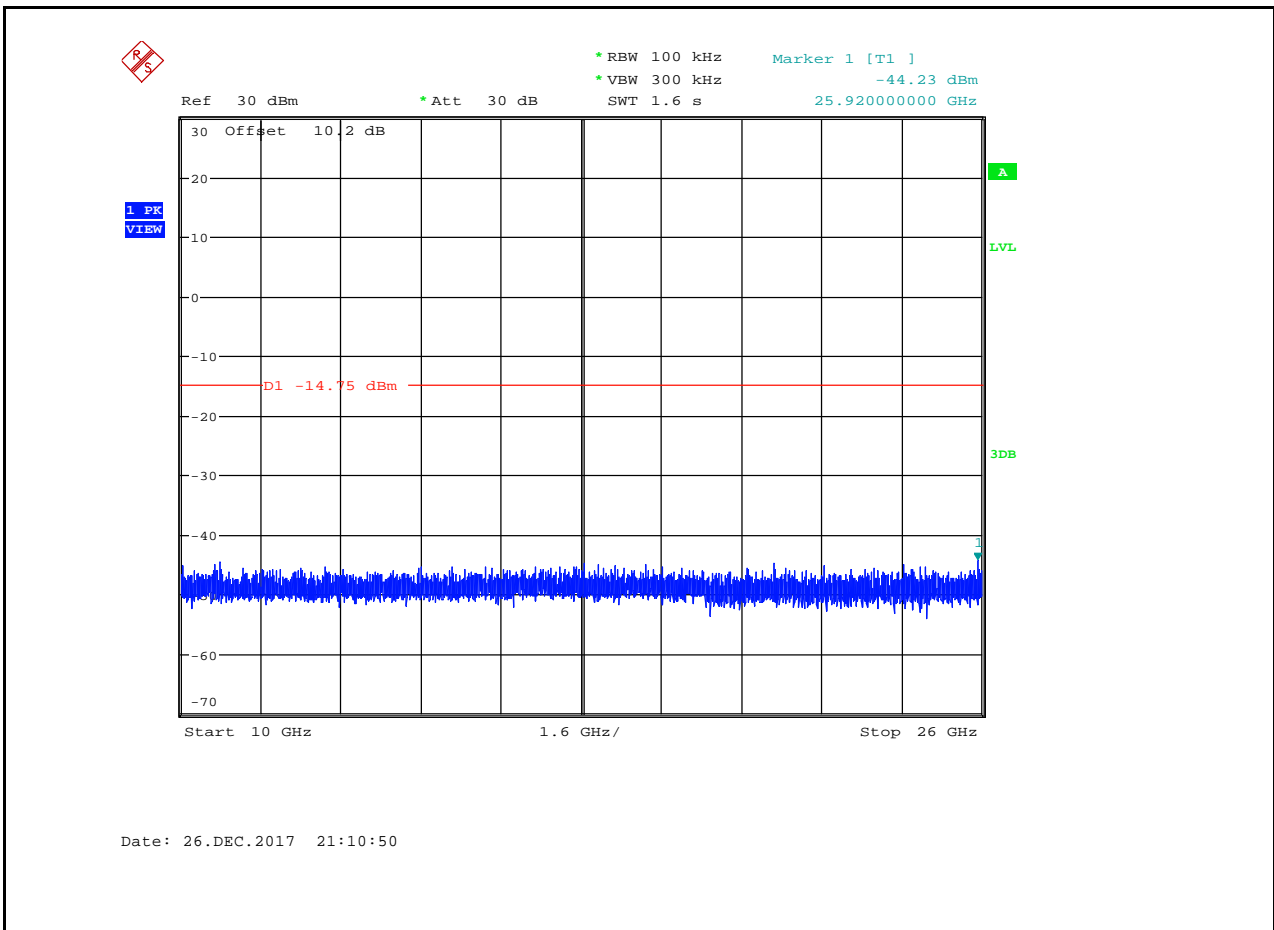

RF Conducted Spurious Emissions\_11G\_2462\_Ant2

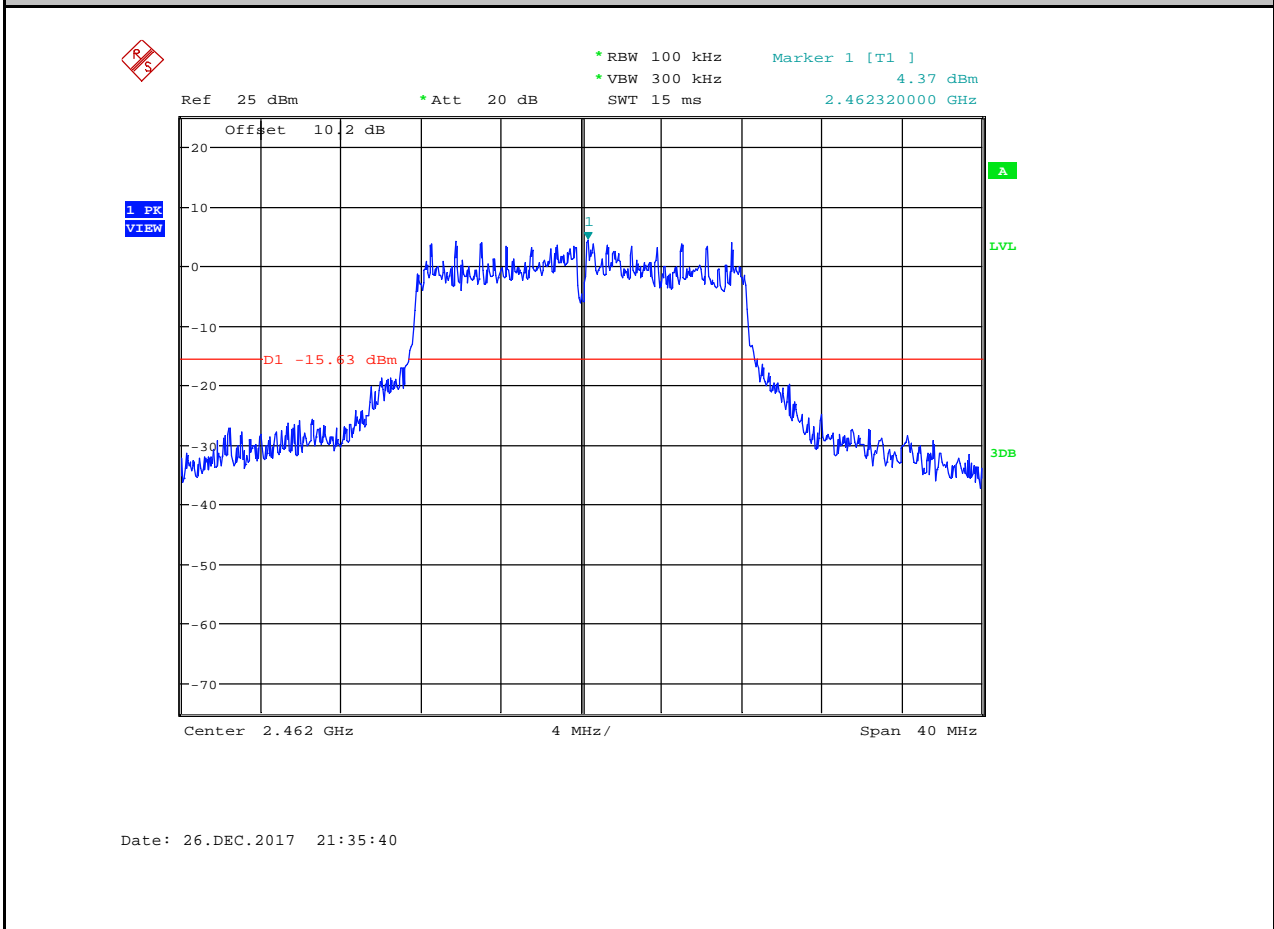

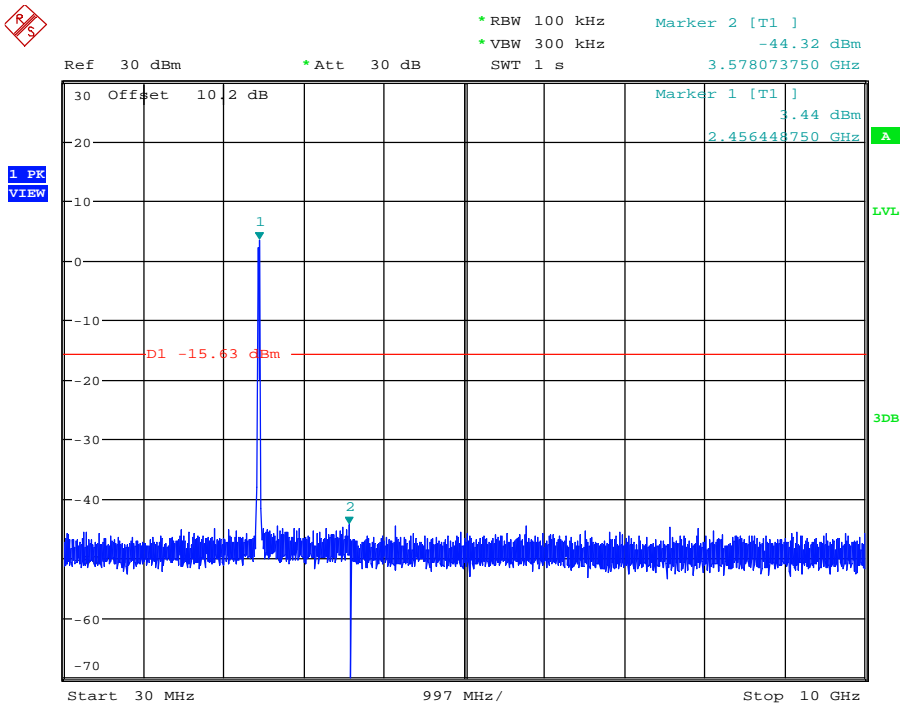

Date: 26.DEC.2017 21:35:51

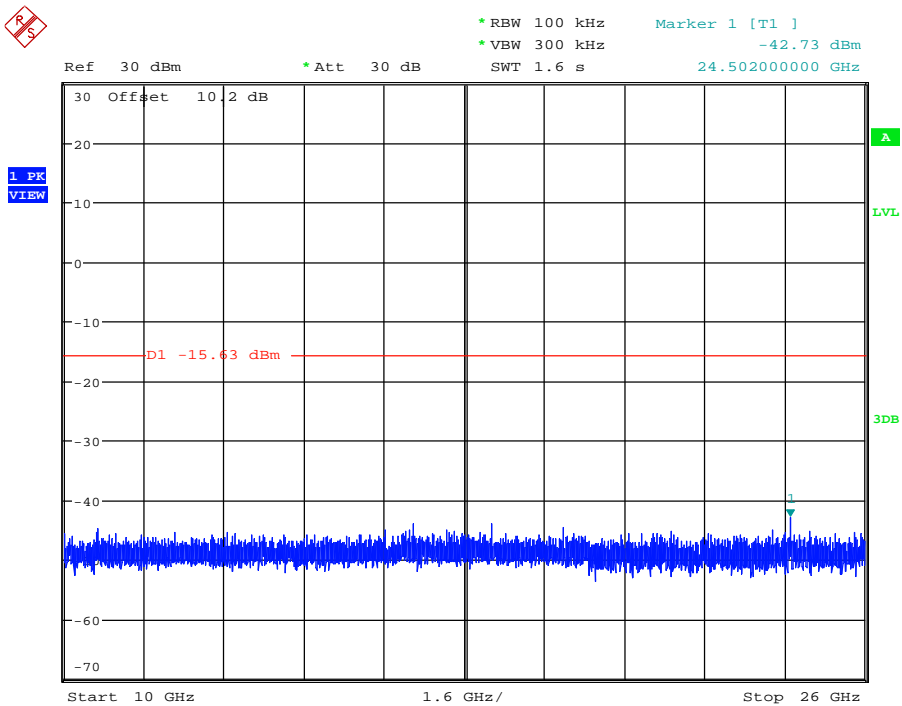

Date: 26.DEC.2017 21:36:01

RF Conducted Spurious Emissions\_11N20SISO\_2412\_Ant1

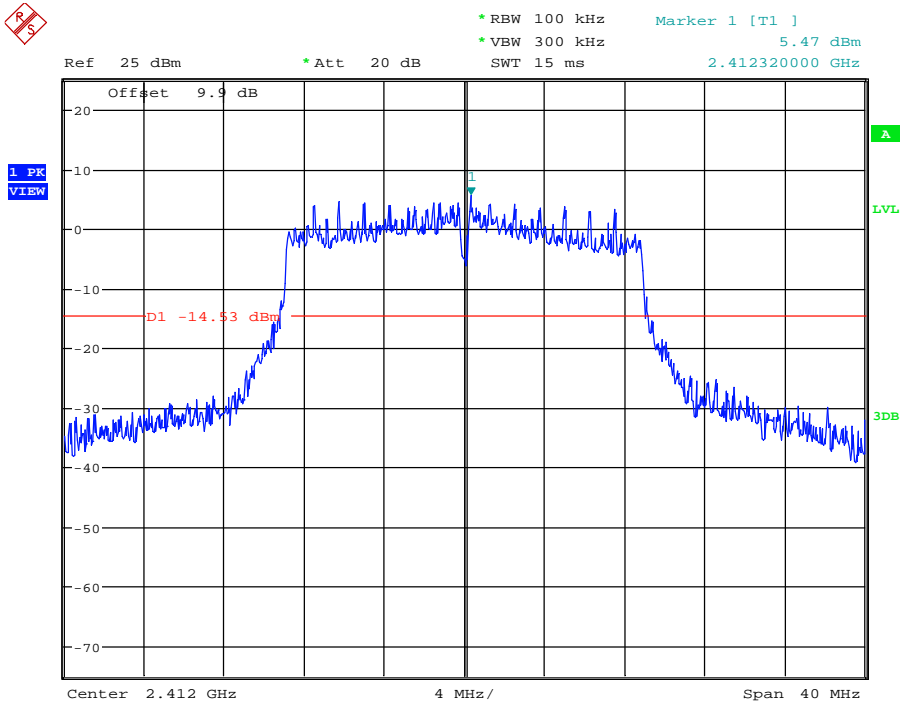

Date: 26.DEC.2017 21:13:30

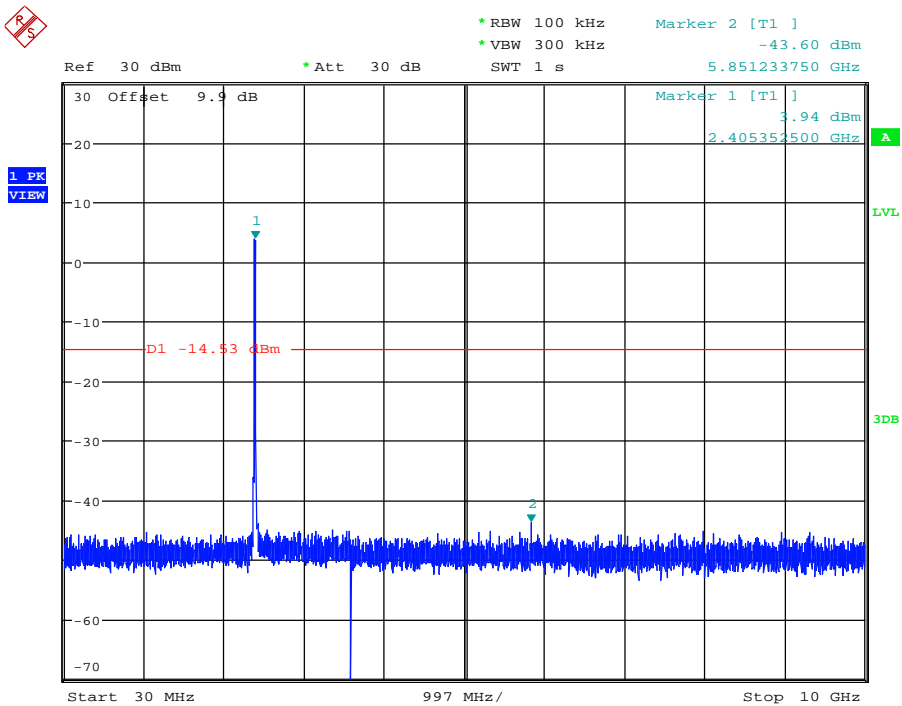

Date: 26.DEC.2017 21:13:41

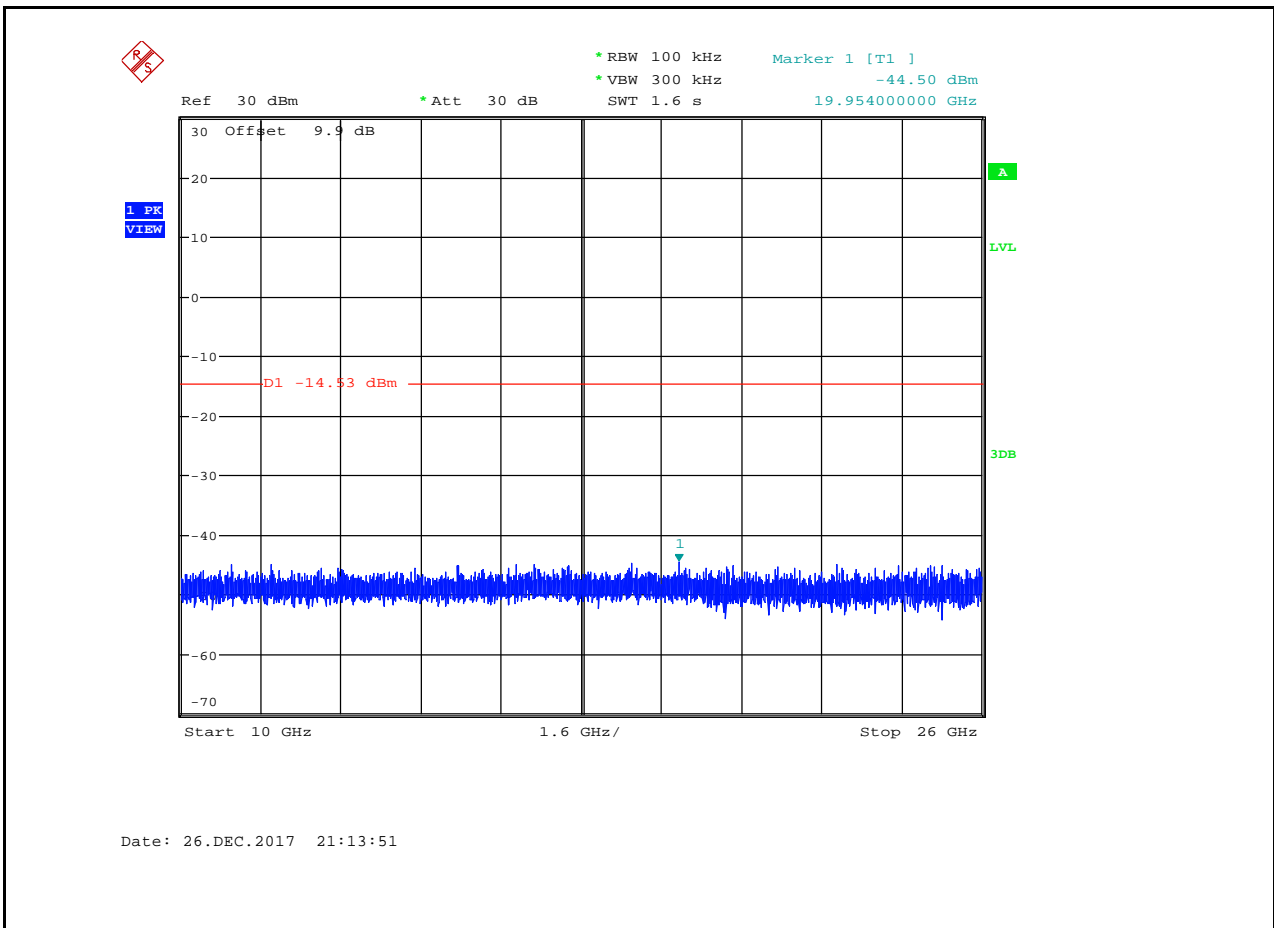

RF Conducted Spurious Emissions\_11N20SISO\_2412\_Ant2

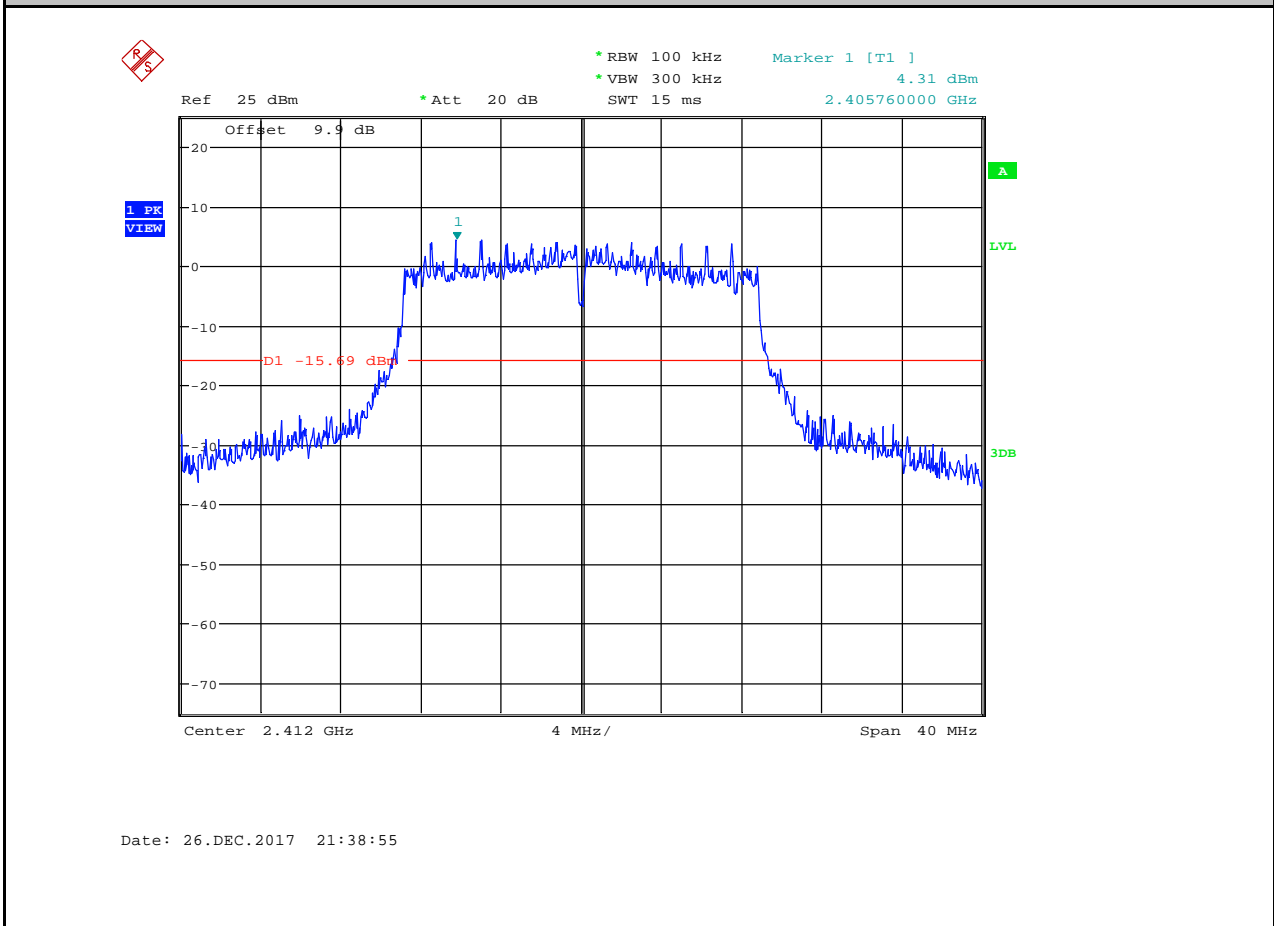



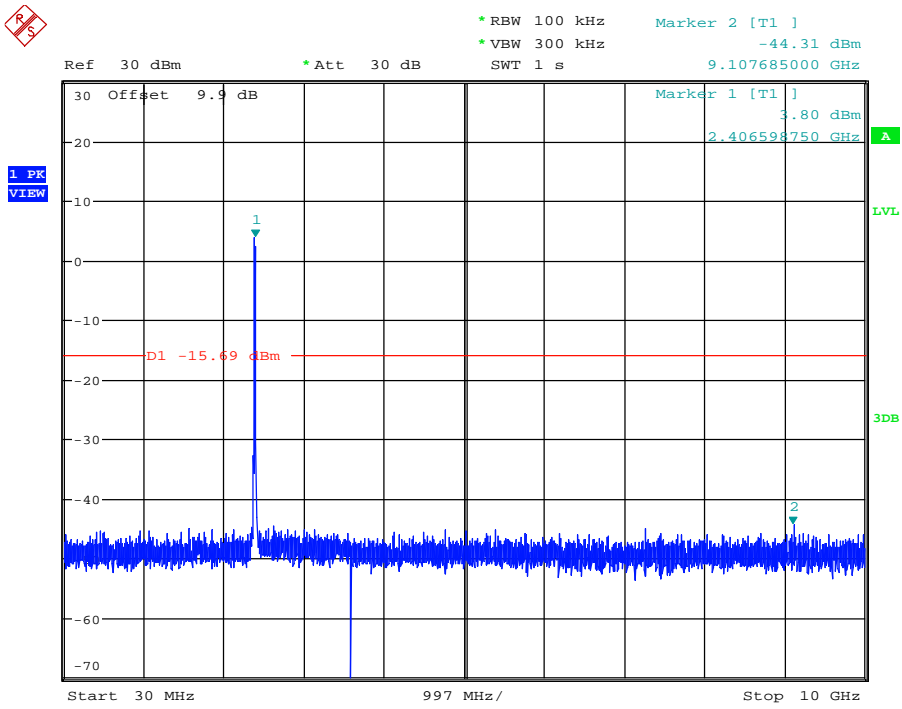

Date: 26.DEC.2017 21:39:07

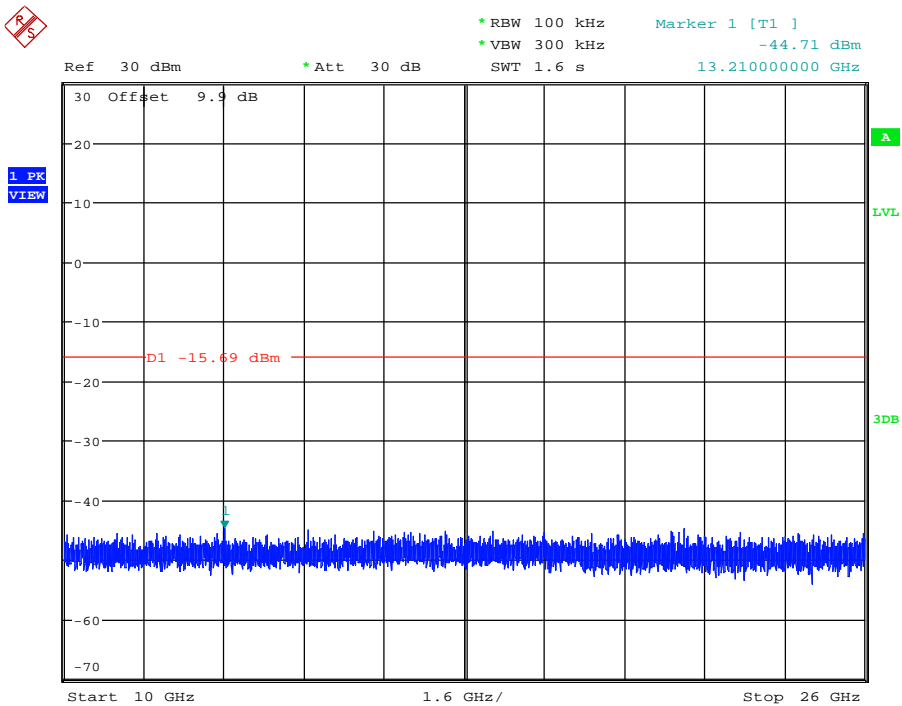

Date: 26.DEC.2017 21:39:17

RF Conducted Spurious Emissions\_11N20SISO\_2462\_Ant1

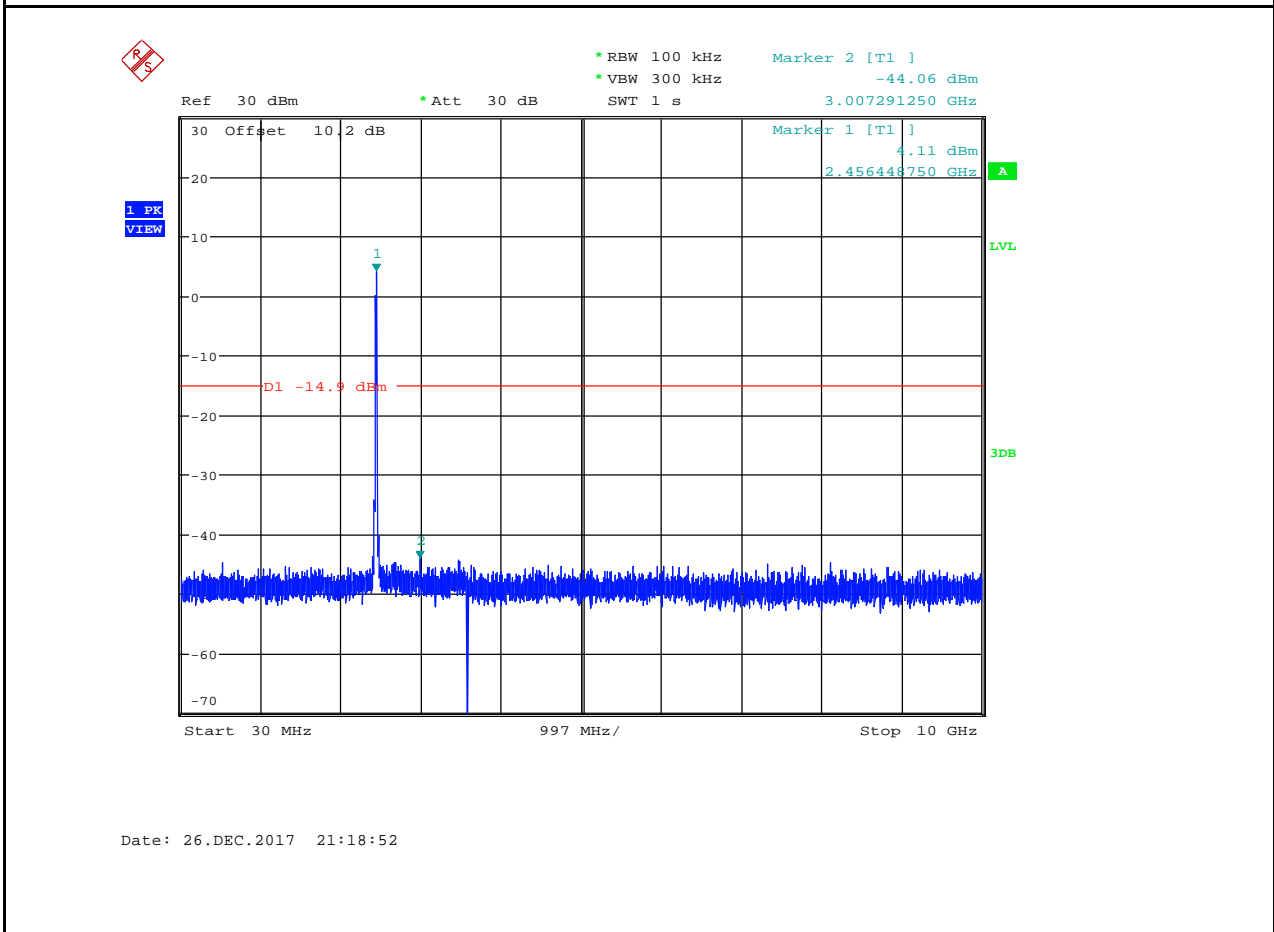
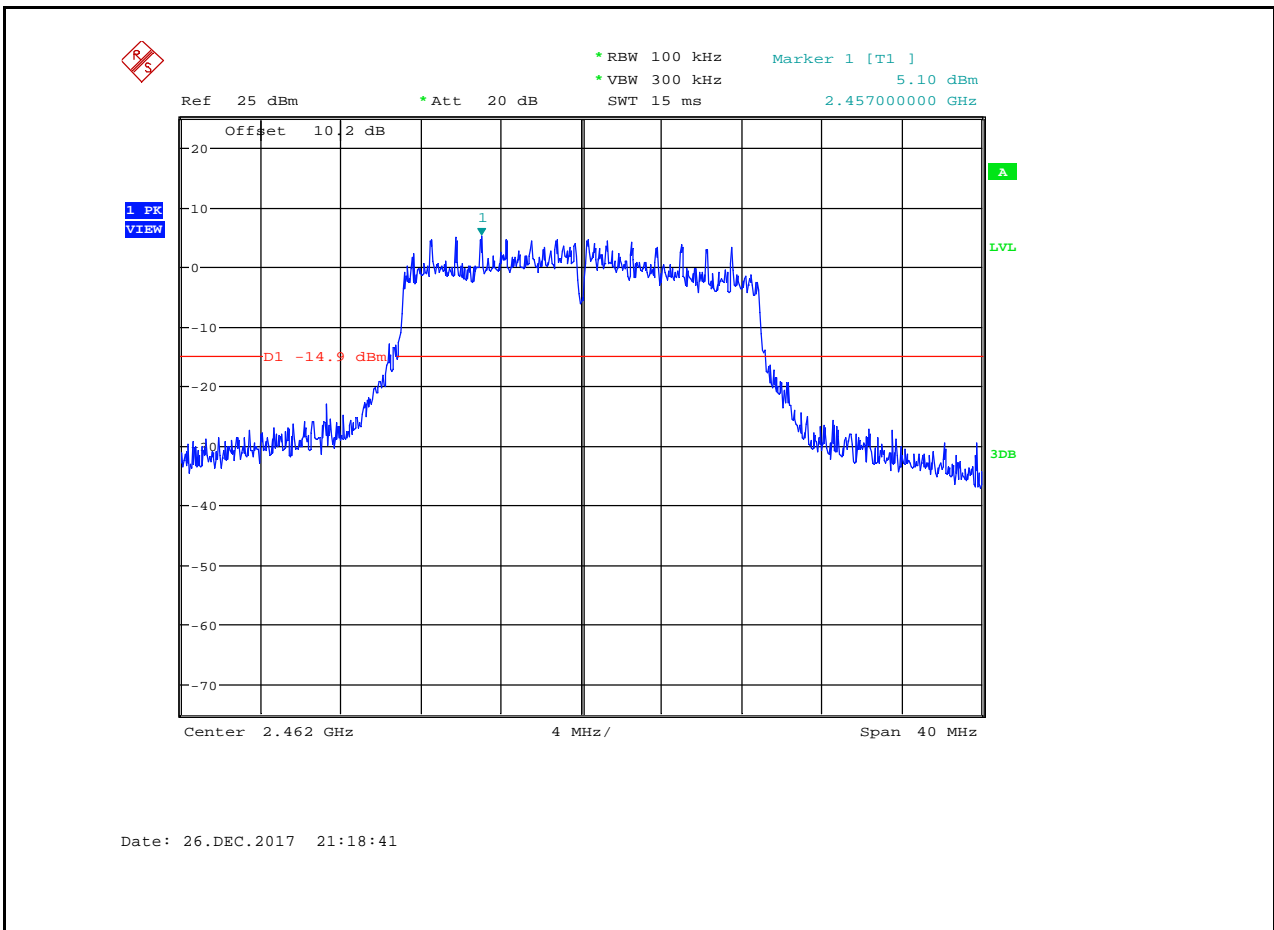

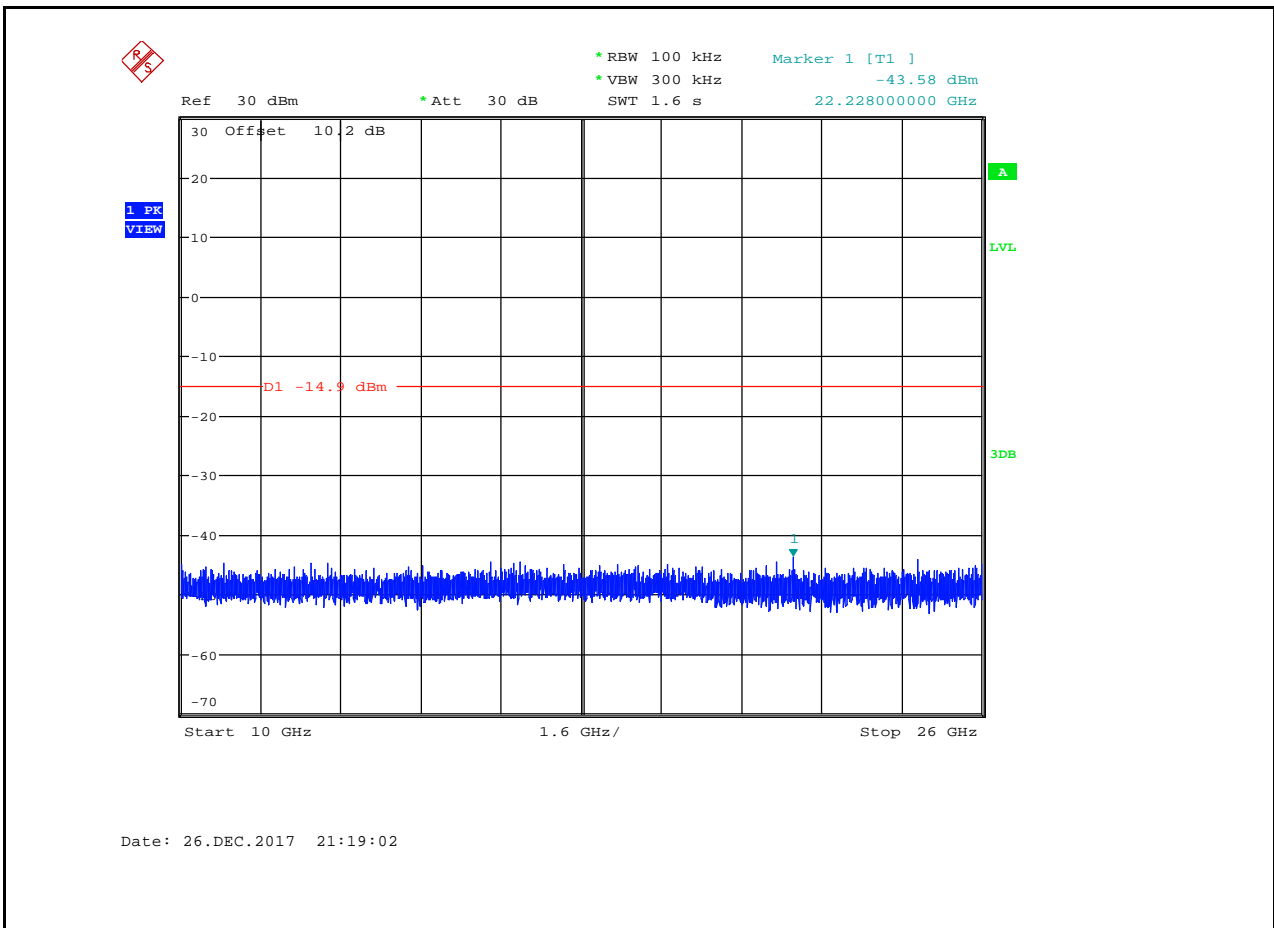

RF Conducted Spurious Emissions\_11N20SISO\_2462\_Ant2

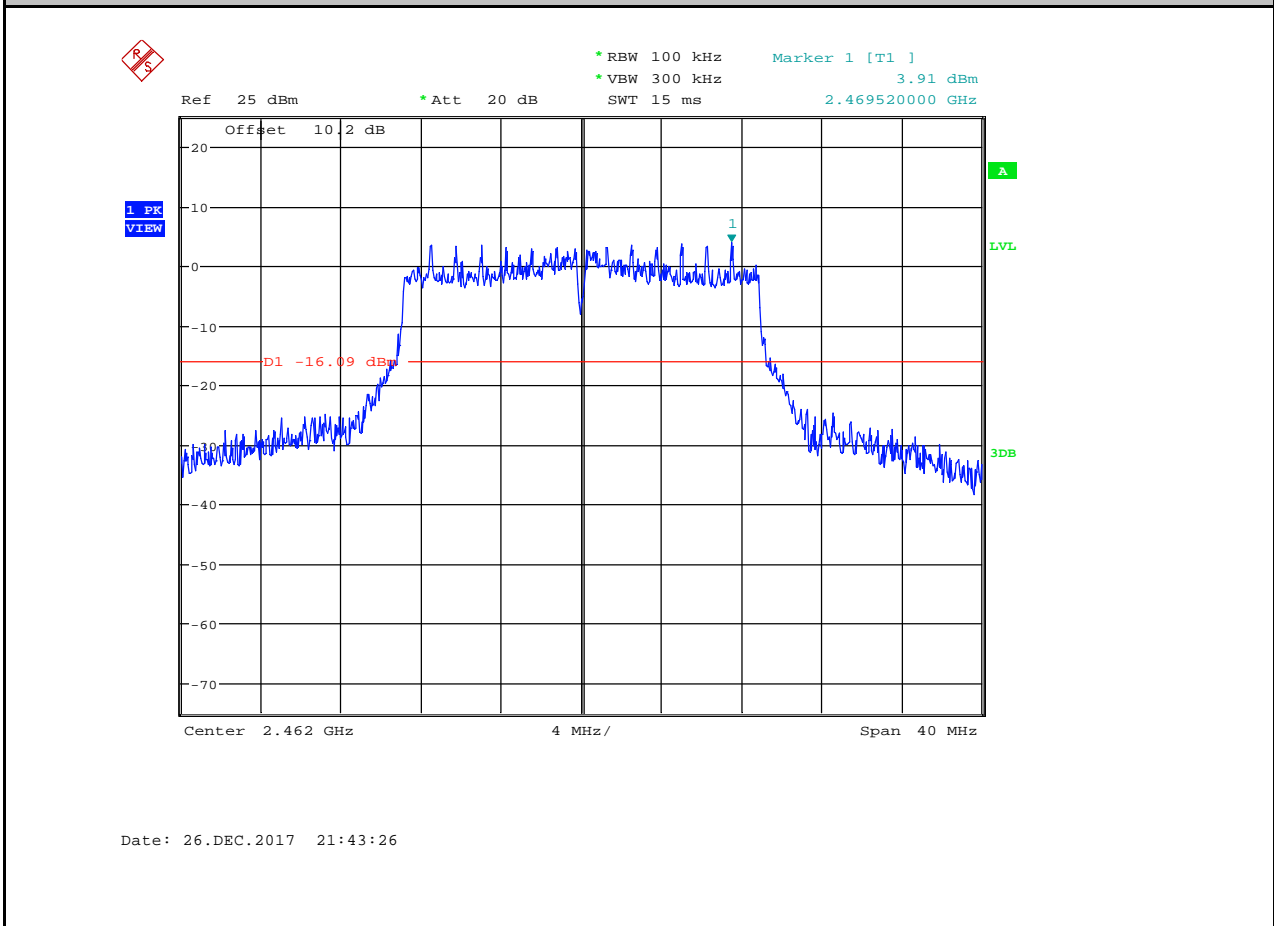

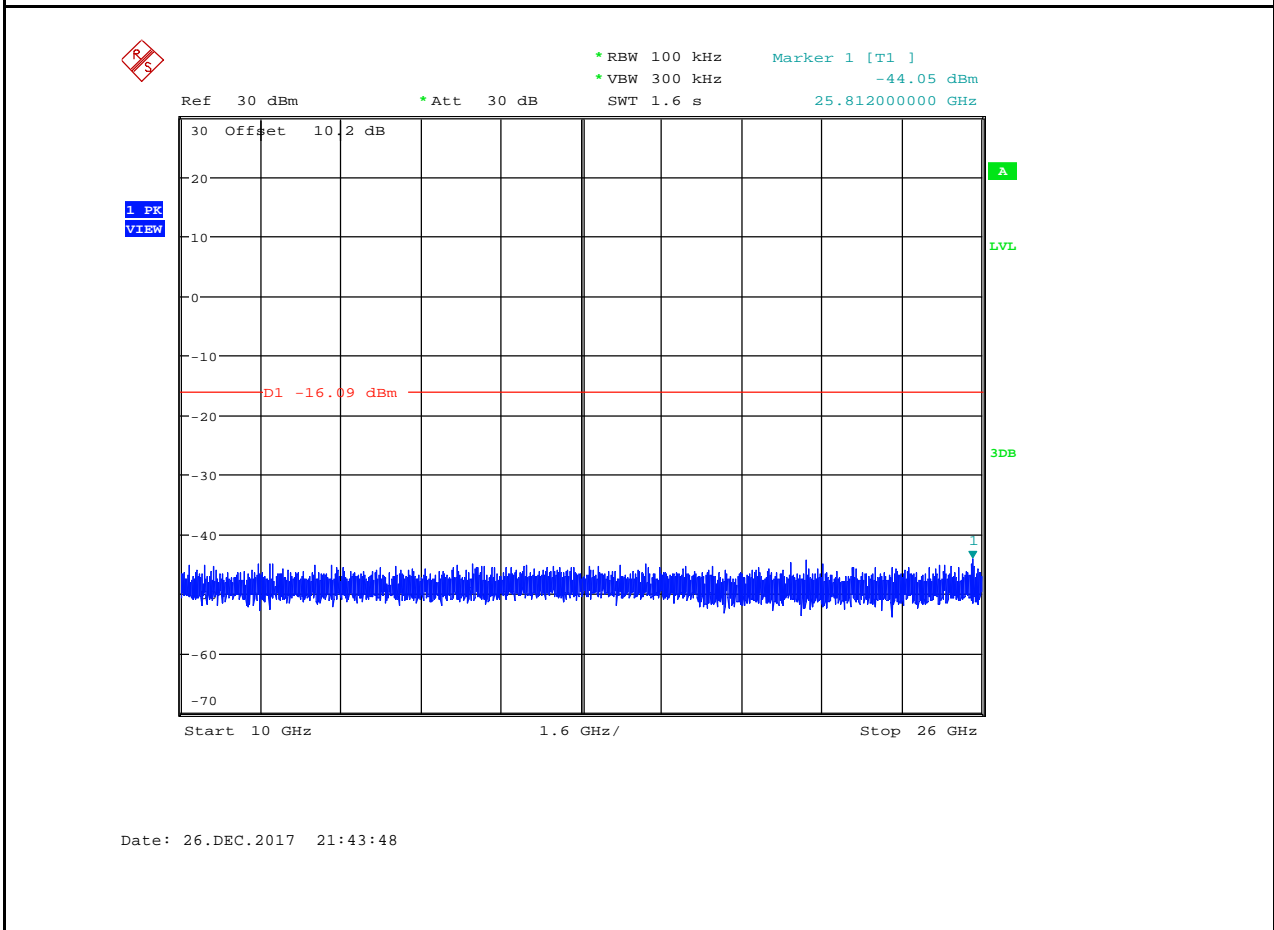
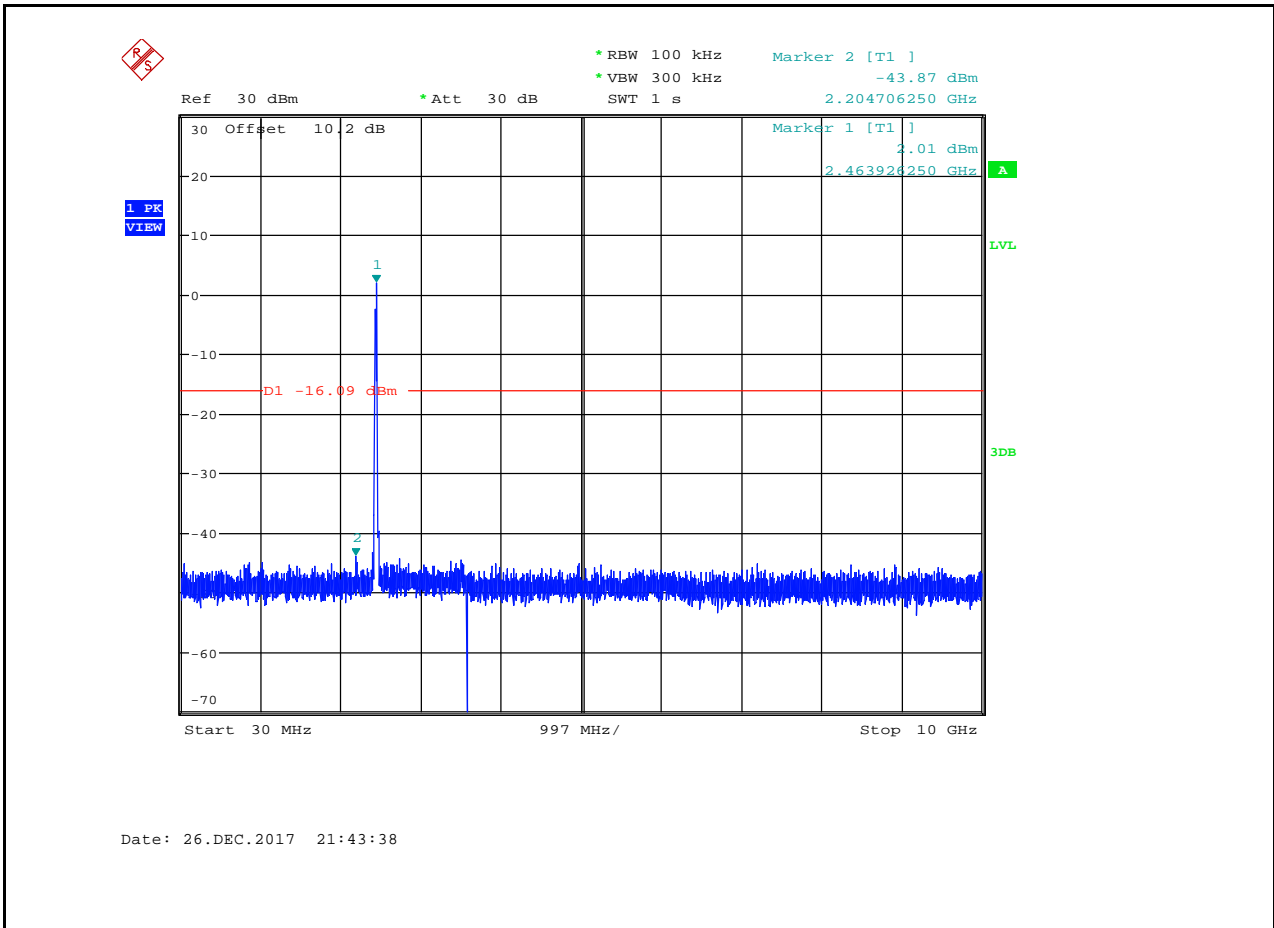

## 7. Radiated Spurious Emissions

### 7.1. Block diagram of test setup

In 3m Anechoic Chamber Test Setup Diagram for 9KHz-30MHz

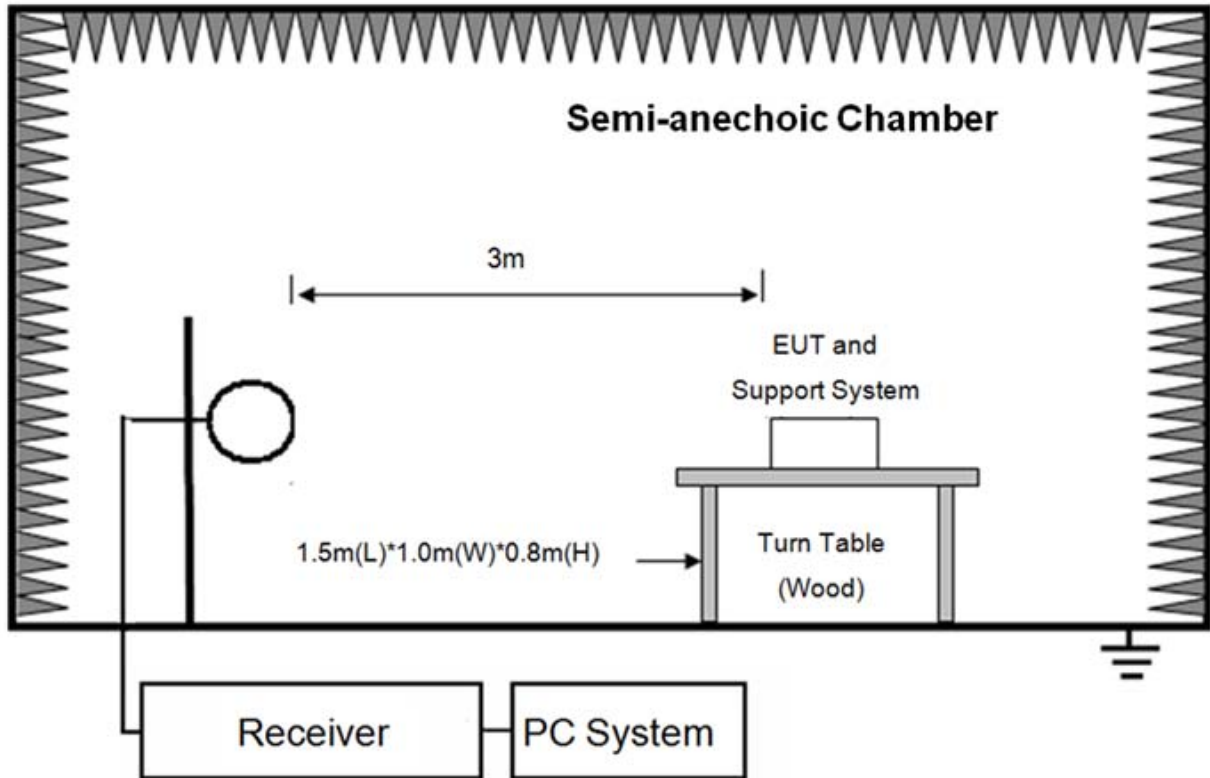

In 3m Anechoic Chamber Test Setup Diagram for 30MHz-1GHz

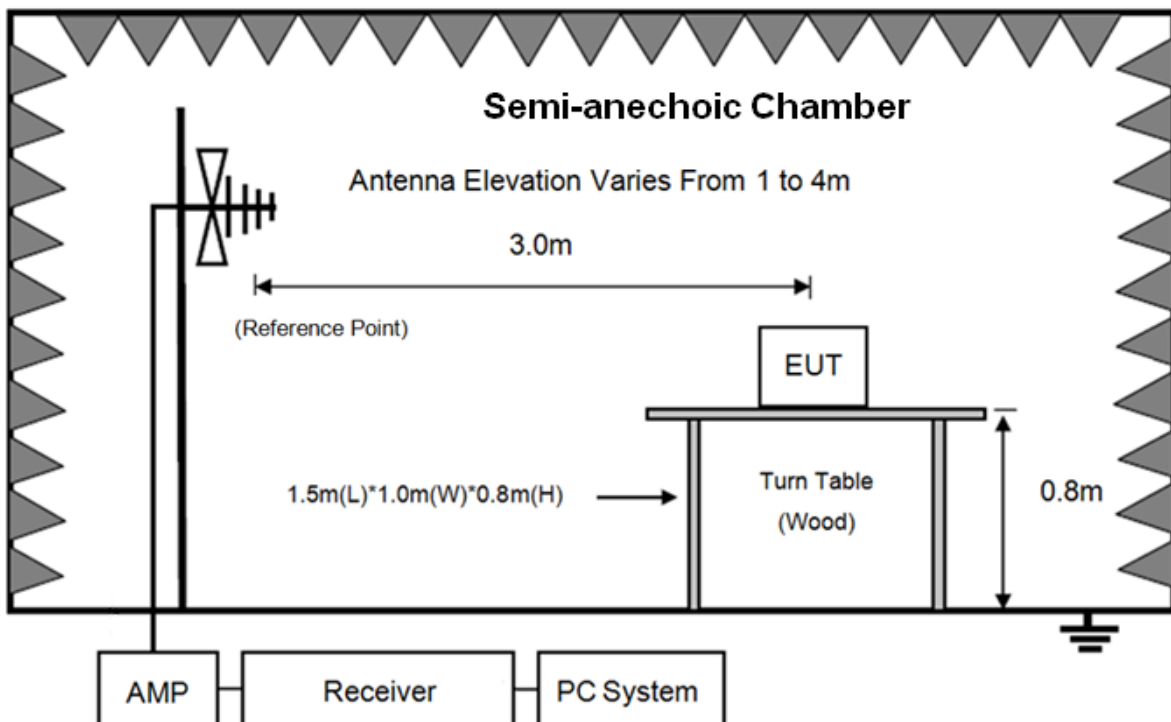

In 3m Anechoic Chamber Test Setup Diagram for frequency above 1GHz

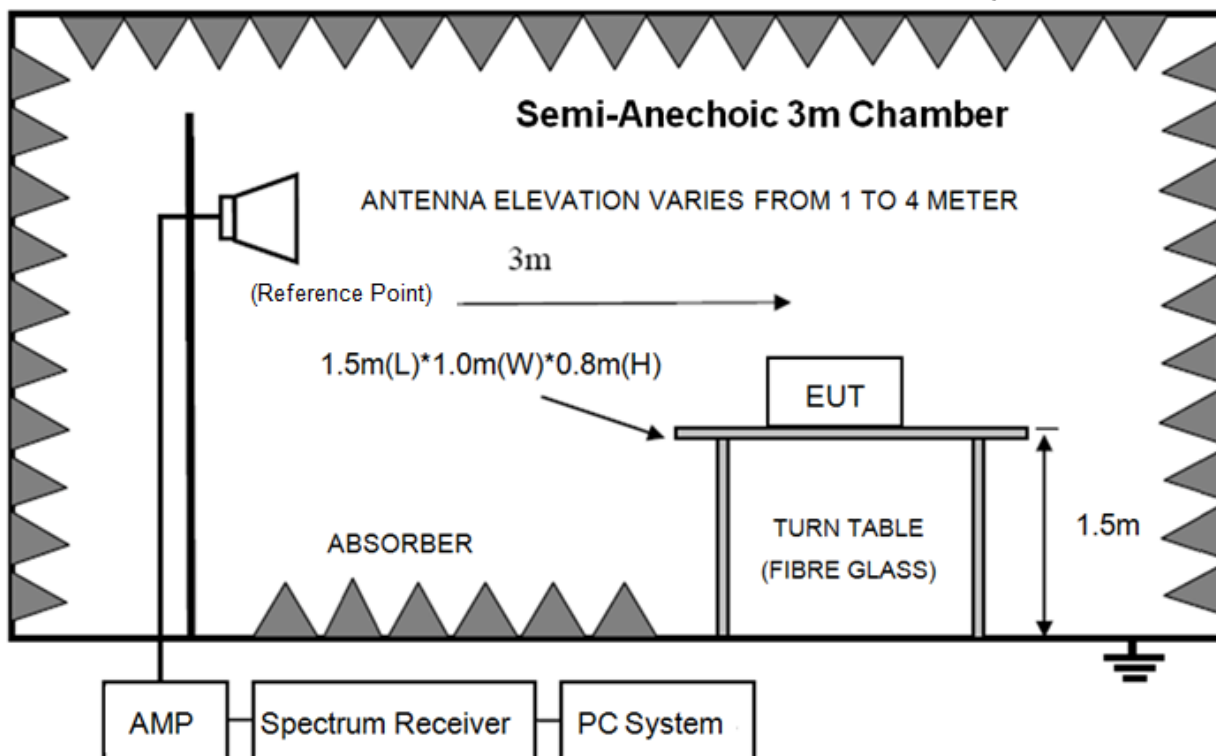

Note: For harmonic emissions test a appropriate high pass filter was inserted in the input port of AMP.

**7.2. Limit**

8.2.1 FCC 15.205 Restricted frequency band

MHz	MHz	MHz	GHz
0.090-0.110	16.42-16.423	399.9-410	4.5-5.15
10.495-0.505	16.69475-16.69525	608-614	5.35-5.46
2.1735-2.1905	16.80425-16.80475	960-1240	7.25-7.75
4.125-4.128	25.5-25.67	1300-1427	8.025-8.5
4.1772&4.17775	37.5-38.25	1435-1626.5	9.0-9.2
4.2072&4.20775	73-74.6	1645.5-1646.5	9.3-9.5
6.215-6.218	74.8-75.2	1660-1710	10.6-12.7
6.26775-6.26825	108-121.94	1718.8-1722.2	13.25-13.4
6.31175-6.31225	123-138	2200-2300	14.47-14.5
8.291-8.294	149.9-150.05	2310-2390	15.35-16.2
8.362-8.366	156.52475-156.52525	2483.5-2500	17.7-21.4
8.37625-8.38675	156.7-156.9	2690-2900	22.01-23.12
8.41425-8.41475	162.0125-167.17	3260-3267	23.6-24.G
12.29-12.293	167.72-173.2	3332-3339	31.2-31.8
12.51975-12.52025	240-285	3345.8-3358	36.43-36.5
12.57675-12.57725	322-335.4	3600-4400	( <sup>2</sup> )
13.36-13.41			

## 8.2.2 FCC 15.209 Limit.

FREQUENCY MHz	DISTANCE Meters	FIELD STRENGTHS LIMIT	
		$\mu\text{V}/\text{m}$	$\text{dB}(\mu\text{V})/\text{m}$
0.009 ~ 0.490	300	2400/F(KHz)	67.6-20log(F)
0.490 ~ 1.705	30	24000/F(KHz)	87.6-20log(F)
1.705 ~ 30.0	30	30	29.54
30 ~ 88	3	100	40.0
88 ~ 216	3	150	43.5
216 ~ 960	3	200	46.0
960 ~ 1000	3	500	54.0
Above 1000	3	74.0 $\text{dB}(\mu\text{V})/\text{m}$ (Peak) 54.0 $\text{dB}(\mu\text{V})/\text{m}$ (Average)	

Note: (1) The emission limits shown in the above table are based on measurements employing a CISPR QP detector except for the frequency bands 9-90KHz, 110-490KHz and above 1000MHz. Radiated emissions limits in these three bands are based on measurements employing an average detector.

(2) At frequencies below 30MHz, measurement may be performed at a distance closer than that specified, and the limit at closer measurement distance can be extrapolated by below formula:

$$\text{Limit}_{3\text{m}}(\text{dB}\mu\text{V}/\text{m}) = \text{Limit}_{30\text{m}}(\text{dB}\mu\text{V}/\text{m}) + 40\text{Log}(30\text{m}/3\text{m})$$

## 8.2.3 Limit for this EUT

All the emissions appearing within 15.205 restricted frequency bands shall not exceed the limits shown in 15.209, all the other emissions shall be at least 20dB below the fundamental emissions, or comply with 15.209 limits.

## 7.3. Test Procedure

(1) EUT height should be 0.8m for below 1GHz at a semi - anechoic chamber while EUT height should be 1.5m for above 1GHz at full chamber or semi - anechoic chamber ground with absorbers.

(2) The antenna used as below table.

Test frequency range	Test antenna used	Measuring distance
9KHz-30MHz	Active Loop antenna	3 m
30MHz-1GHz	Trilog Broadband Antenna	3 m
1GHz-18GHz	Double Ridged Horn Antenna(1GHz-18GHz)	3 m
18GHz-40GHz	Horn Antenna(18GHz-40GHz)	1 m

According ANSI C63.10:2013 clause 6.4.4.2 and 6.5.3, for measurements below 30 MHz, the loop antenna was positioned with its plane vertical from the EUT and rotated about its vertical axis for maximum response at each azimuth position around the EUT. And the loop antenna also be positioned with its plane horizontal at the specified distance from the EUT. The center of the loop is 1 m above the ground. for measurement above 30MHz, the Trilog Broadband Antenna or Horn Antenna was located 3m from EUT, Measurements were made with the antenna positioned in both the horizontal and vertical planes of Polarization, and the measurement antenna was varied from 1 m to 4 m. in height above the reference

ground plane to obtain the maximum signal strength.

(3) Below pre-scan procedure was first performed in order to find prominent frequency spectrum radiated emissions from 9KHz to 25GHz:

(a) Scanning the peak frequency spectrum with the antenna specified in step (3), and the EUT was rotated 360 degree, the antenna height was varied from 1m to 4m(Except loop antenna, it's fixed 1m above ground.)

(b) Change work frequency or channel of device if practicable.

(c) Change modulation type of device if practicable.

(d) Change power supply range from 85% to 115% of the rated supply voltage

(e) Rotated EUT though three orthogonal axes to determine the attitude of EUT arrangement produces highest emissions.

Spectrum frequency from 9KHz to 25GHz (tenth harmonic of fundamental frequency) was investigated, and no any obvious emission were detected from 18GHz to 25GHz, so below final test was performed with frequency range from 9KHz to 18GHz.

(4) For final emissions measurements at each frequency of interest, the EUT was rotated and the antenna height was varied between 1m and 4m in order to maximize the emission. Measurements in both horizontal and vertical polarities were made and the data was recorded. In order to find the maximum emission, the relative positions of equipments and all of the interface cables were changed according to ANSI C63.10 2013 on Radiated Emission test.

(5) The emissions from 9KHz to 1GHz were measured based on CISPR QP detector except for the frequency bands 9-90KHz, 110-490KHz, for emissions from 9KHz-90KHz,110KHz-490KHz and above 1GHz were measured based on average detector, for emissions above 1GHz, peak emissions also be measured and need comply with Peak limit.

(6) The emissions from 9KHz to 1GHz, QP or average values were measured with EMI receiver with below RBW

Frequency band	RBW
9KHz-150KHz	200Hz
150KHz-30MHz	9KHz
30MHz-1GHz	120KHz

(7) For emissions above 1GHz, both Peak and Average level were measured with Spectrum Analyzer, and the RBW is set at 1MHz, VBW is set at 3MHz for Peak measure; RMS detector RBW 1MHz VBW 3MHz for Average measure(according ANSI C63.10:2013 clause 4.2.3.2.3 procedure for average measure).

## 7.4. Test result

### **PASS. (See below detailed test result)**

All the emissions except fundamental emission from 9KHz to 25GHz were comply with 15.209 limit.

Note1: According exploratory test no any obvious emission were detected from 9kHz to 30MHz and 18GHz to 25GHz, so the final test was performed with frequency range from 30MHz to 18GHz and recorded in below.



Note2: For emissions below 1GHz, according exploratory explorer test, when change Tx mode and channel, have no distinct influence on emissions level, so for emissions below 1GHz, the final test was only performed with EUT working in ANT2, 11b, Tx CH6 mode.

Radiated Emission test (below 1GHz)

# TR-4-E-009 Radiated Emission Test Result

<b>Test Site</b>	: DDT 3m Chamber 1#	D:\2017 RE1# Report Data\Q17112903-1E\Q17112903-1E FCC 30M-1G.EM6
<b>Test Date</b>	: 2017-12-26	<b>Tested By</b> : TALENT
<b>EUT</b>	: Wireless speaker	<b>Model Number</b> : ALLURE PORTABLE
<b>Power Supply</b>	: AC120V/60Hz	<b>Test Mode</b> : TX mode
<b>Condition</b>	: Temp:24.5°C,Humi:55%, Press:100.1kPa	<b>Antenna/Distance</b> : 2017 VULB 9163 1#/3m/HORIZONTAL
<b>Memo</b>	:	

Data: 5

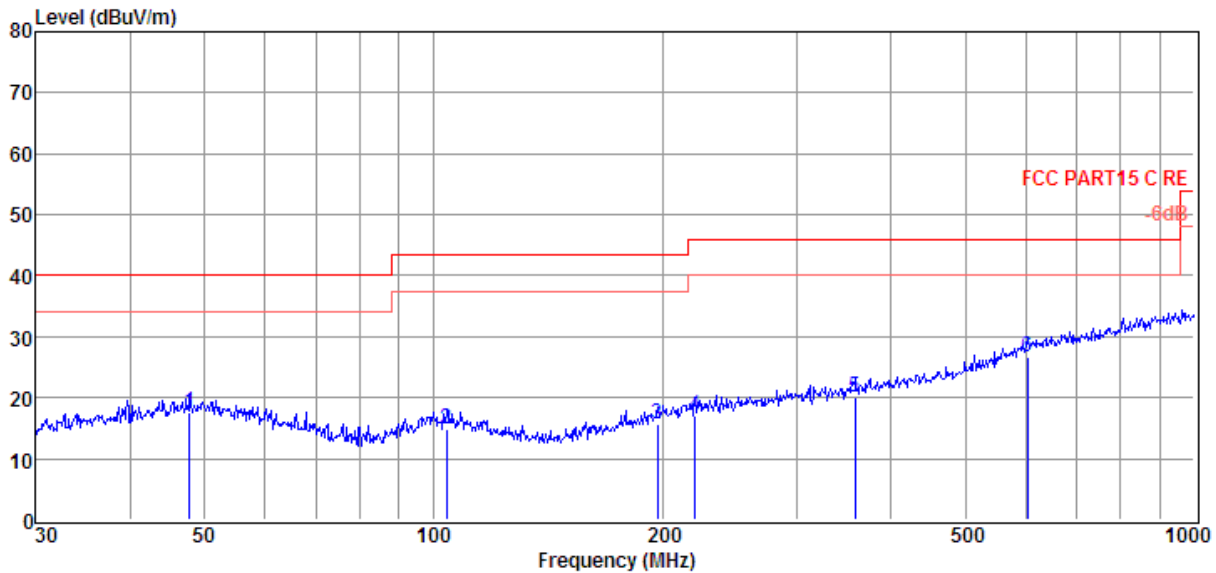

Item (Mark)	Freq. (MHz)	Read Level (dBuV)	Antenna Factor (dB/m)	Cable Loss (dB)	Result Level (dBuV/m)	Limit Line (dBuV/m)	Over Limit (dB)	Detector	Polarization
1	47.83	0.03	13.56	3.97	17.56	40.00	-22.44	QP	HORIZONTAL
2	104.17	-0.52	10.98	4.45	14.91	43.50	-28.59	QP	HORIZONTAL
3	197.20	-0.73	11.26	5.01	15.54	43.50	-27.96	QP	HORIZONTAL
4	220.62	0.00	11.94	5.14	17.08	46.00	-28.92	QP	HORIZONTAL
5	357.93	-0.22	14.47	5.78	20.03	46.00	-25.97	QP	HORIZONTAL
6	603.54	0.65	19.41	6.68	26.74	46.00	-19.26	QP	HORIZONTAL

- Note: 1. Result Level = Read Level + Antenna Factor + Cable loss.  
 2. If Peak Result complies with QP limit, QP Result is deemed to comply with QP limit.  
 3. Test setup: RBW: 120 kHz, VBW: 300 kHz, Sweep time: auto.

# TR-4-E-009 Radiated Emission Test Result

<b>Test Site</b>	: DDT 3m Chamber 1#	D:\2017 RE1# Report Data\Q17112903-1E\Q17112903-1E FCC 30M-1G.EM6
<b>Test Date</b>	: 2017-12-26	<b>Tested By</b> : TALENT
<b>EUT</b>	: Wireless speaker	<b>Model Number</b> : ALLURE PORTABLE
<b>Power Supply</b>	: AC120V/60Hz	<b>Test Mode</b> : TX mode
<b>Condition</b>	: Temp:24.5°C,Humi:55%, Press:100.1kPa	<b>Antenna/Distance</b> : 2017 VULB 9163 1#/3m/VERTICAL
<b>Memo</b>	:	

Data: 6

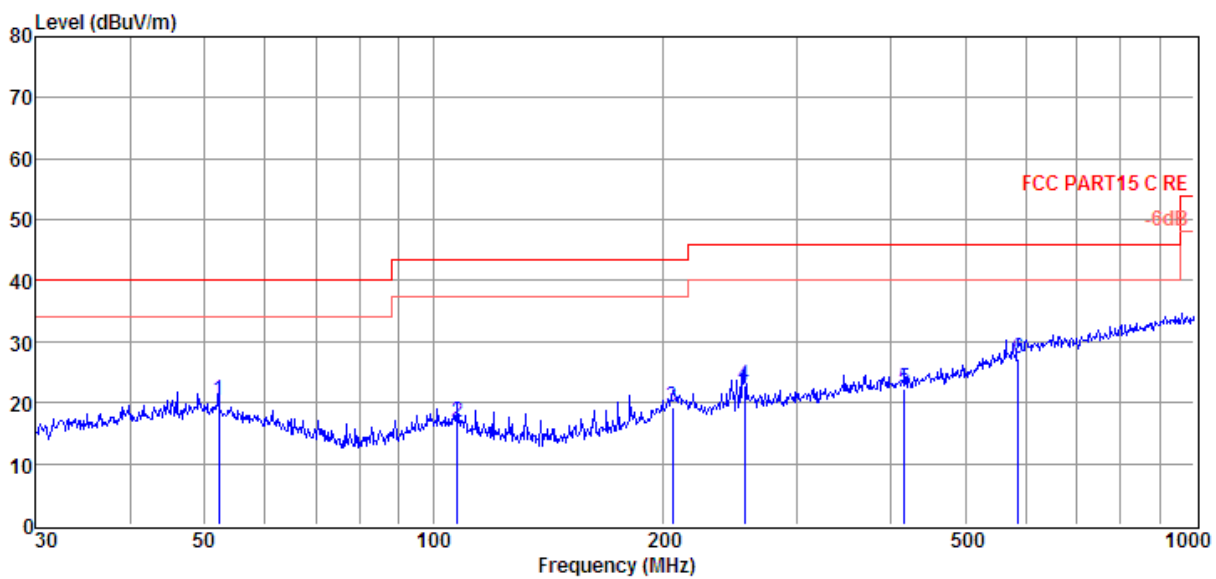

Item (Mark)	Freq. (MHz)	Read Level (dBµV)	Antenna Factor (dB/m)	Cable Loss (dB)	Result Level (dBµV/m)	Limit Line (dBµV/m)	Over Limit (dB)	Detector	Polarization
1	52.21	3.10	13.23	4.02	20.35	40.00	-19.65	QP	VERTICAL
2	107.51	1.79	10.59	4.47	16.85	43.50	-26.65	QP	VERTICAL
3	206.40	2.41	11.64	5.06	19.11	43.50	-24.39	QP	VERTICAL
4	256.52	4.93	12.60	5.33	22.86	46.00	-23.14	QP	VERTICAL
5	416.18	0.83	15.61	5.84	22.28	46.00	-23.72	QP	VERTICAL
6	586.84	1.67	19.17	6.51	27.35	46.00	-18.65	QP	VERTICAL

Note: 1. Result Level = Read Level + Antenna Factor + Cable loss.  
 2. If Peak Result complies with QP limit, QP Result is deemed to comply with QP limit.  
 3. Test setup: RBW: 120 kHz, VBW: 300 kHz, Sweep time: auto.

**Radiated Emission test (above 1GHz)**

Freq (MHz)	Read level (dB $\mu$ V)	Antenna Factor (dB/m)	PRM Factor (dB)	Cable Loss (dB)	Result Level (dB $\mu$ V/m)	Limit (dB $\mu$ V/m)	Margin (dB)	Detector type	Polarization
<b>11b CH1</b>									
4825.00	39.99	34.72	29.32	7.40	52.79	74.00	-21.21	Peak	HORIZONTAL
6151.00	35.06	35.70	29.31	8.23	49.68	74.00	-24.32	Peak	HORIZONTAL
7800.00	35.52	37.12	31.04	9.05	50.65	74.00	-23.35	Peak	HORIZONTAL
9925.00	34.91	38.12	32.89	10.85	50.99	74.00	-23.01	Peak	HORIZONTAL
11336.00	35.23	38.67	34.38	11.03	50.55	74.00	-23.45	Peak	HORIZONTAL
13444.00	35.88	39.74	35.28	11.80	52.14	74.00	-21.86	Peak	HORIZONTAL
6100.00	35.06	35.70	29.27	8.22	49.71	74.00	-24.29	Peak	VERTICAL
7324.00	36.42	36.93	30.59	8.62	51.38	74.00	-22.62	Peak	VERTICAL
8514.00	35.43	37.31	31.78	9.82	50.78	74.00	-23.22	Peak	VERTICAL
9415.00	35.01	37.67	32.57	10.59	50.70	74.00	-23.30	Peak	VERTICAL
10469.00	34.92	38.48	33.25	10.97	51.12	74.00	-22.88	Peak	VERTICAL
12951.00	35.56	39.25	35.70	11.33	50.44	74.00	-23.56	Peak	VERTICAL
<b>11b CH6</b>									
6066.00	35.05	35.70	29.24	8.22	49.73	74.00	-24.27	Peak	HORIZONTAL
7375.00	35.49	36.95	30.65	8.67	50.46	74.00	-23.54	Peak	HORIZONTAL
7749.00	35.98	37.10	31.00	9.00	51.08	74.00	-22.92	Peak	HORIZONTAL
10180.00	35.04	38.31	33.03	10.92	51.24	74.00	-22.76	Peak	HORIZONTAL
10775.00	34.46	38.67	33.59	11.02	50.56	74.00	-23.44	Peak	HORIZONTAL
13104.00	36.34	39.40	35.64	11.46	51.56	74.00	-22.44	Peak	HORIZONTAL
5896.00	34.88	35.66	29.20	8.14	49.48	74.00	-24.52	Peak	VERTICAL
8140.00	35.92	37.23	31.24	9.39	51.30	74.00	-22.70	Peak	VERTICAL
9585.00	35.25	37.78	32.71	10.67	50.99	74.00	-23.01	Peak	VERTICAL
10146.00	34.75	38.29	33.01	10.91	50.94	74.00	-23.06	Peak	VERTICAL
11319.00	34.25	38.67	34.38	11.03	49.57	74.00	-24.43	Peak	VERTICAL
13206.00	35.07	39.51	35.54	11.56	50.60	74.00	-23.40	Peak	VERTICAL
<b>11b CH11</b>									
6440.00	35.71	35.70	29.74	8.26	49.93	74.00	-24.07	Peak	HORIZONTAL
8021.00	35.14	37.20	31.17	9.25	50.42	74.00	-23.58	Peak	HORIZONTAL
9364.00	34.99	37.65	32.52	10.56	50.68	74.00	-23.32	Peak	HORIZONTAL
10928.00	33.65	38.76	33.80	11.05	49.66	74.00	-24.34	Peak	HORIZONTAL
11880.00	34.57	38.83	34.73	10.98	49.65	74.00	-24.35	Peak	HORIZONTAL
13410.00	35.40	39.71	35.38	11.76	51.49	74.00	-22.51	Peak	HORIZONTAL
5845.00	35.52	35.64	29.20	8.11	50.07	74.00	-23.93	Peak	VERTICAL
7800.00	35.35	37.12	31.04	9.05	50.48	74.00	-23.52	Peak	VERTICAL
9364.00	34.57	37.65	32.52	10.56	50.26	74.00	-23.74	Peak	VERTICAL
10571.00	34.22	38.54	33.33	10.99	50.42	74.00	-23.58	Peak	VERTICAL
12016.00	35.01	38.90	34.80	10.98	50.09	74.00	-23.91	Peak	VERTICAL
13716.00	34.77	39.89	34.95	12.07	51.78	74.00	-22.22	Peak	VERTICAL

Note: 1.30MHz~25GHz: (Scan with 11b mode ANT 1 and ANT 2, 11g mode ANT 1 and ANT 2, 11n HT20 mode ANT 1 and ANT 2, the worst case is 11b ANT 2 mode)

2. Result Level = Read Level + Antenna Factor + Cable loss - PRM Factor.

3. Test setup: RBW: 1 MHz, VBW: 3 MHz, Sweep time: auto.

4: For emissions above 1GHz. If peak results comply with AV limit, AV Result is deemed to comply with AV limit.

## 8. Radiated Band Edge Compliance

### 8.1. Block diagram of test setup

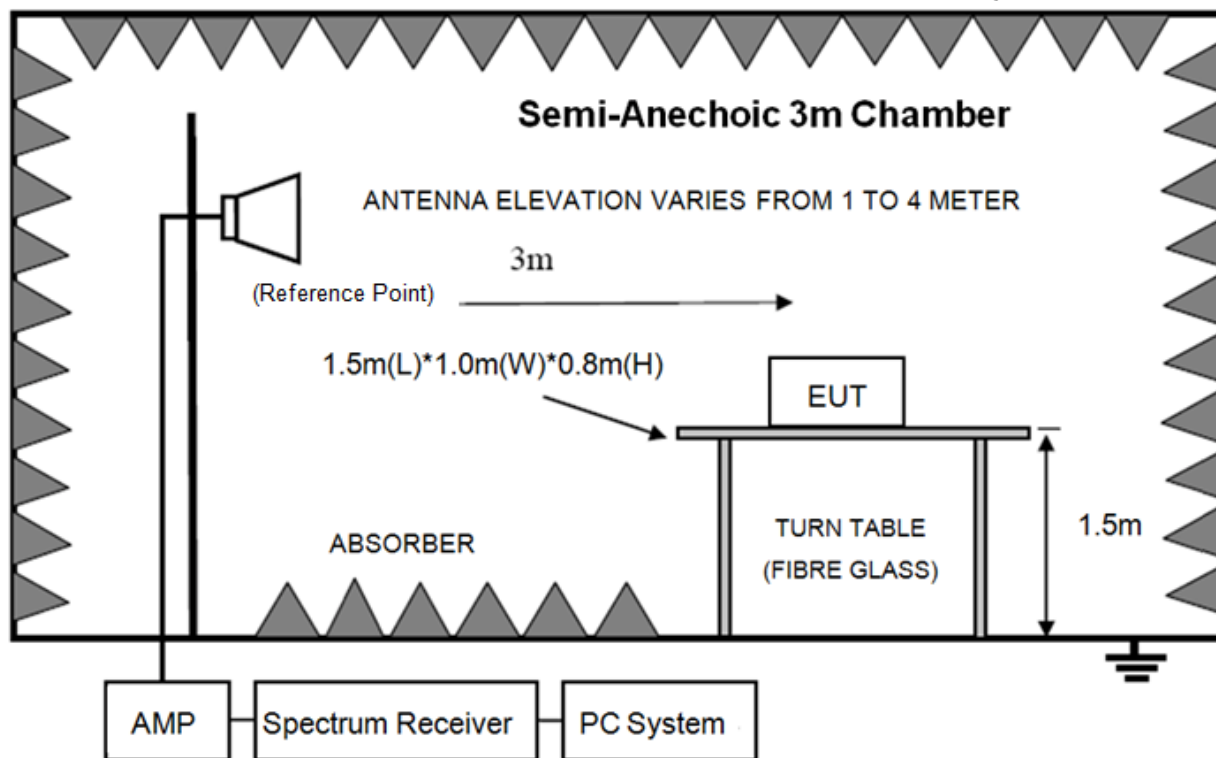

### 8.2. Limit

All restricted frequency bands shall not exceed the limits shown in 15.209, all the other emissions outside operation frequency band 2400MHz to 2483.5MHz shall be at least 20dB below the fundamental emissions, or comply with RSS-Gen Issue 3 clause 7.2.5 (Same as FCC 15.209) limits.

### 8.3. Test Procedure

Same with clause 8.3 except change investigated frequency range from 2100MHz to 2450MHz and 2450MHz to 2500MHz.

Remark: All restriction band have been tested, and only the worse case is shown in report.

### 8.4. Test result

#### **PASS. (See below detailed test result)**

Note: 11b, 11g, n20 mode ANT 1 and ANT 2 mode all have been tested, only Ant 2 mode is worse case and reported.

# TR-4-E-009 Radiated Emission Test Result

**Test Site** : DDT 3m Chamber 1# D:\2017 RE1# Report Data\Q17112903-1E\FCC ID 1-18G BT 2.4G WIFI.EM6  
**Test Date** : 2017-12-29 **Tested By** : Sunny  
**EUT** : Wireless speaker **Model Number** : ALLURE PORTABLE  
**Power Supply** : AC 120V/60Hz **Test Mode** : TX mode 11B 2412Hz  
**Condition** : Temp:24.5'C,Humi:55%,  
 Press:100.1kPa **Antenna/Distance** : 2017 HF907/3m/VERTICAL  
**Memo** :

Data: 25

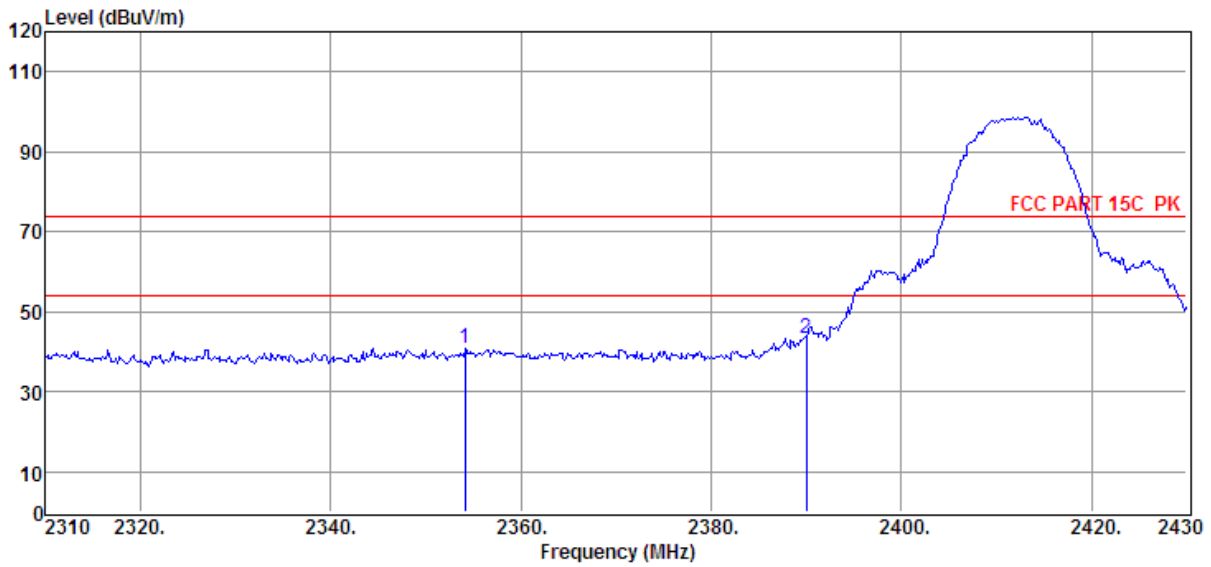

Item	Freq.	Read Level	Antenna Factor	PRM Factor	Cable Loss	Result Level	Limit Line	Over Limit	Detector	Polarization
(Mark)	(MHz)	(dBuV)	(dB/m)	dB	dB	(dBuV/m)	(dBuV/m)	(dB)		
1	2354.16	38.29	26.87	29.34	5.07	40.89	74.00	-33.11	Peak	VERTICAL
2	2390.00	40.80	27.00	29.42	5.11	43.49	74.00	-30.51	Peak	VERTICAL

Note: 1. Result Level = Read Level + Antenna Factor + Cable loss - PRM Factor.  
 2. If Peak Result complies with AV limit, AV Result is deemed to comply with AV limit.  
 3. Test setup: RBW: 1 MHz, VBW: 3 MHz, Sweep time: auto.

# TR-4-E-009 Radiated Emission Test Result

**Test Site** : DDT 3m Chamber 1# D:\2017 RE1# Report Data\Q17112903-1E\FCC ID 1-18G BT 2.4G WIFI.EM6  
**Test Date** : 2017-12-29 **Tested By** : Sunny  
**EUT** : Wireless speaker **Model Number** : ALLURE PORTABLE  
**Power Supply** : AC 120V/60Hz **Test Mode** : TX mode 11B 2412Hz  
**Condition** : Temp:24.5'C,Humi:55%,  
 Press:100.1kPa **Antenna/Distance** : 2017 HF907/3m/HORIZONTAL  
**Memo** :

Data: 26

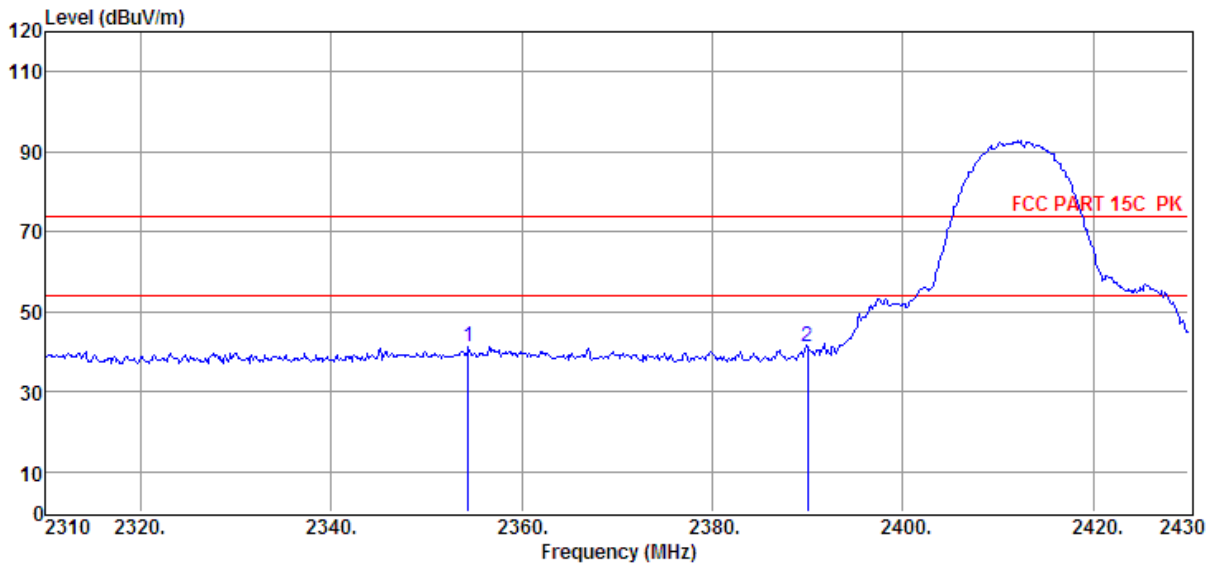

Item	Freq.	Read Level	Antenna Factor	PRM Factor	Cable Loss	Result Level	Limit Line	Over Limit	Detector	Polarization
(Mark)	(MHz)	(dBμV)	(dB/m)	dB	dB	(dBμV/m)	(dBμV/m)	(dB)		
1	2354.40	38.71	26.88	29.34	5.07	41.32	74.00	-32.68	Peak	HORIZONTAL
2	2390.00	38.60	27.00	29.42	5.11	41.29	74.00	-32.71	Peak	HORIZONTAL

- Note: 1. Result Level = Read Level + Antenna Factor + Cable loss - PRM Factor.  
 2. If Peak Result complies with AV limit, AV Result is deemed to comply with AV limit.  
 3. Test setup: RBW: 1 MHz, VBW: 3 MHz, Sweep time: auto.

# TR-4-E-009 Radiated Emission Test Result

**Test Site** : DDT 3m Chamber 1# D:\2017 RE1# Report Data\Q17112903-1E\FCC ID 1-18G BT 2.4G WIFI.EM6  
**Test Date** : 2017-12-29 **Tested By** : Sunny  
**EUT** : Wireless speaker **Model Number** : ALLURE PORTABLE  
**Power Supply** : AC 120V/60Hz **Test Mode** : TX mode 11B 2462Hz  
**Condition** : Temp:24.5'C,Humi:55%,  
 Press:100.1kPa **Antenna/Distance** : 2017 HF907/3m/VERTICAL  
**Memo** :

Data: 33

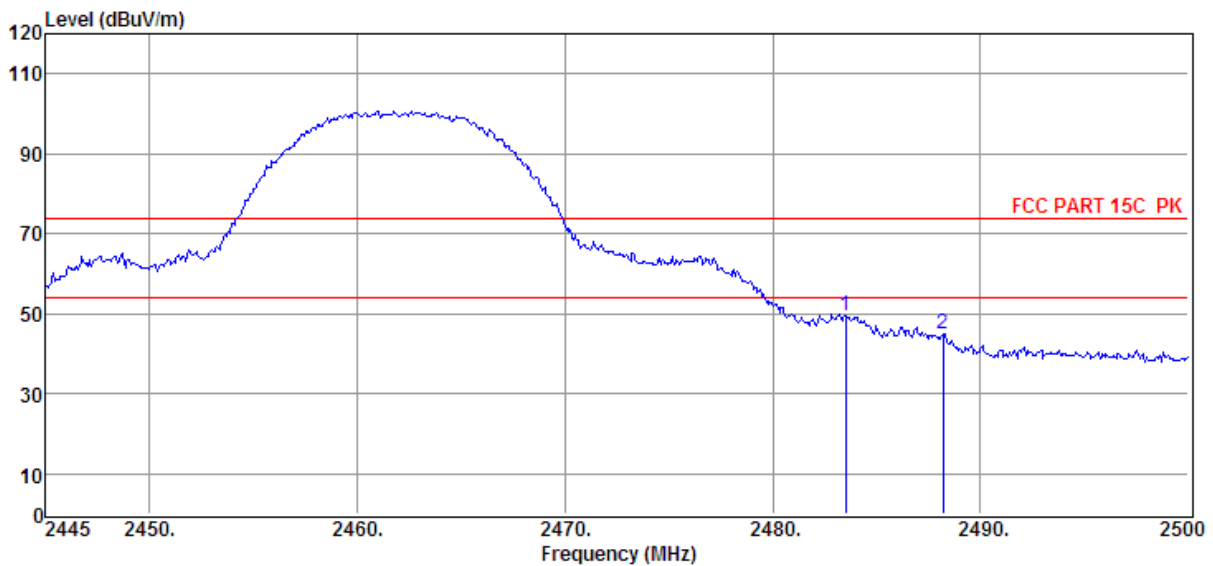

Item	Freq.	Read Level	Antenna Factor	PRM Factor	Cable Loss	Result Level	Limit Line	Over Limit	Detector	Polarization
(Mark)	(MHz)	(dBμV)	(dB/m)	dB	dB	(dBμV/m)	(dBμV/m)	(dB)		
1	2483.50	46.70	27.34	29.71	5.21	49.54	74.00	-24.46	Peak	VERTICAL
2	2488.18	42.18	27.36	29.71	5.22	45.05	74.00	-28.95	Peak	VERTICAL

Note: 1. Result Level = Read Level + Antenna Factor + Cable loss - PRM Factor.  
 2. If Peak Result complies with AV limit, AV Result is deemed to comply with AV limit.  
 3. Test setup: RBW: 1 MHz, VBW: 3 MHz, Sweep time: auto.



# TR-4-E-009 Radiated Emission Test Result

**Test Site** : DDT 3m Chamber 1# D:\2017 RE1# Report Data\Q17112903-1E\FCC ID 1-18G BT 2.4G WIFI.EM6  
**Test Date** : 2017-12-29 **Tested By** : Sunny  
**EUT** : Wireless speaker **Model Number** : ALLURE PORTABLE  
**Power Supply** : AC 120V/60Hz **Test Mode** : TX mode 11B 2462Hz  
**Condition** : Temp:24.5'C,Humi:55%,  
 Press:100.1kPa **Antenna/Distance** : 2017 HF907/3m/HORIZONTAL  
**Memo** :

Data: 34

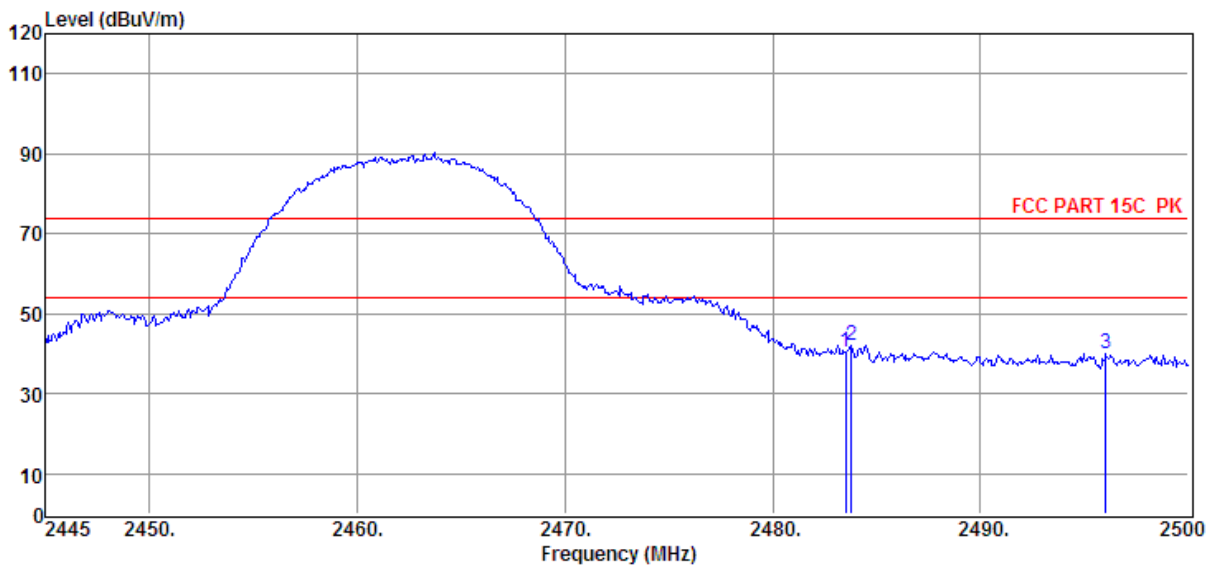

Item (Mark)	Freq. (MHz)	Read Level (dBμV)	Antenna Factor (dB/m)	PRM Facto r dB	Cable Loss dB	Result Level (dBμV/m)	Limit Line (dBμV/m)	Over Limit (dB)	Detector	Polarization
1	2483.50	37.48	27.34	29.71	5.21	40.32	74.00	-33.68	Peak	HORIZONTAL
2	2483.78	39.41	27.34	29.71	5.21	42.25	74.00	-31.75	Peak	HORIZONTAL
3	2496.04	37.07	27.39	29.73	5.23	39.96	74.00	-34.04	Peak	HORIZONTAL

- Note: 1. Result Level = Read Level + Antenna Factor + Cable loss - PRM Factor.  
 2. If Peak Result complies with AV limit, AV Result is deemed to comply with AV limit.  
 3. Test setup: RBW: 1 MHz, VBW: 3 MHz, Sweep time: auto.

# TR-4-E-009 Radiated Emission Test Result

**Test Site** : DDT 3m Chamber 1# D:\2017 RE1# Report Data\Q17112903-1E\FCC ID 1-18G BT 2.4G WIFI.EM6  
**Test Date** : 2017-12-29 **Tested By** : Sunny  
**EUT** : Wireless speaker **Model Number** : ALLURE PORTABLE  
**Power Supply** : AC 120V/60Hz **Test Mode** : TX mode 11G 2412Hz  
**Condition** : Temp:24.5'C,Humi:55%,  
 Press:100.1kPa **Antenna/Distance** : 2017 HF907/3m/HORIZONTAL  
**Memo** :

Data: 35

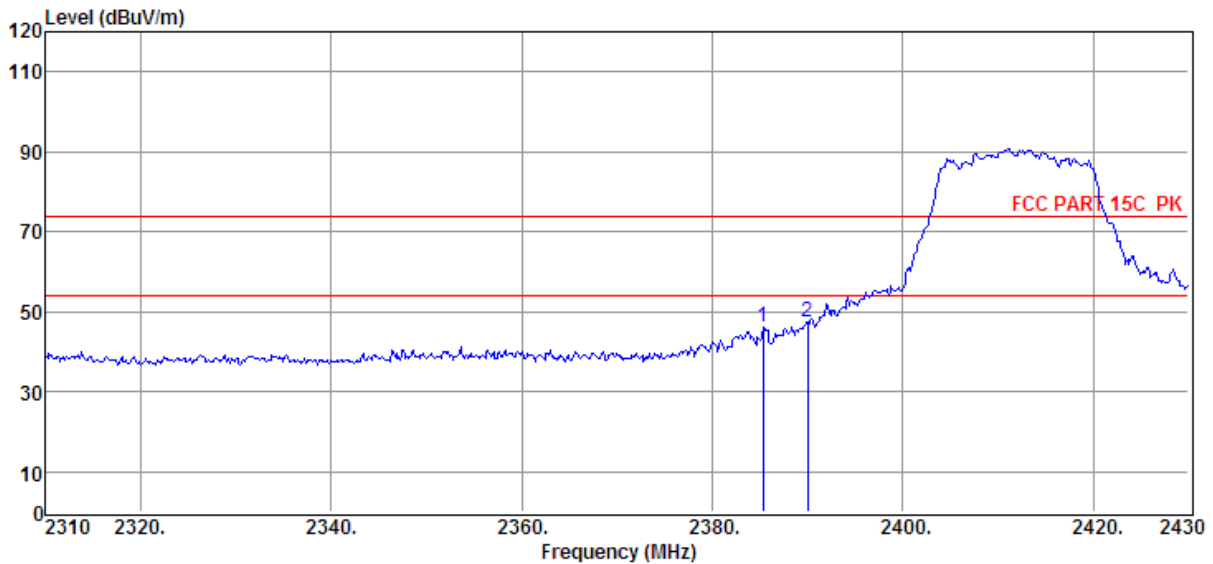

Item	Freq.	Read Level	Antenna Factor	PRM Factor	Cable Loss	Result Level	Limit Line	Over Limit	Detector	Polarization
(Mark)	(MHz)	(dBμV)	(dB/m)	dB	dB	(dBμV/m)	(dBμV/m)	(dB)		
1	2385.36	43.41	26.99	29.41	5.10	46.09	74.00	-27.91	Peak	HORIZONTAL
2	2390.04	44.89	27.00	29.42	5.11	47.58	74.00	-26.42	Peak	HORIZONTAL

Note: 1. Result Level = Read Level + Antenna Factor + Cable loss - PRM Factor.  
 2. If Peak Result complies with AV limit, AV Result is deemed to comply with AV limit.  
 3. Test setup: RBW: 1 MHz, VBW: 3 MHz, Sweep time: auto.

# TR-4-E-009 Radiated Emission Test Result

**Test Site** : DDT 3m Chamber 1# D:\2017 RE1# Report Data\Q17112903-1E\FCC ID 1-18G BT 2.4G WIFI.EM6  
**Test Date** : 2017-12-29 **Tested By** : Sunny  
**EUT** : Wireless speaker **Model Number** : ALLURE PORTABLE  
**Power Supply** : AC 120V/60Hz **Test Mode** : TX mode 11G 2412Hz  
**Condition** : Temp:24.5'C,Humi:55%,  
 Press:100.1kPa **Antenna/Distance** : 2017 HF907/3m/VERTICAL  
**Memo** :

Data: 36

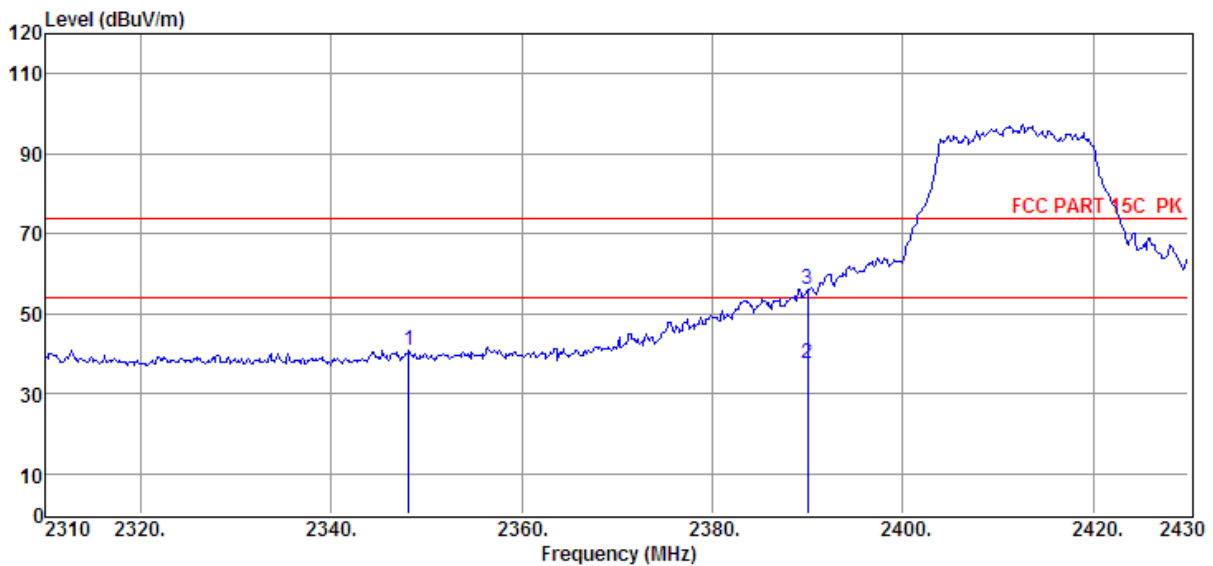

Item (Mark)	Freq. (MHz)	Read Level (dBμV)	Antenna Factor (dB/m)	PRM Facto r dB	Cable Loss dB	Result Level (dBμV/m)	Limit Line (dBμV/m)	Over Limit (dB)	Detector	Polarization
1	2348.16	38.38	26.85	29.33	5.06	40.96	74.00	-33.04	Peak	VERTICAL
2	2390.00	34.69	27.00	29.42	5.11	37.38	54.00	-16.62	Average	VERTICAL
3	2390.00	53.54	27.00	29.42	5.11	56.23	74.00	-17.77	Peak	VERTICAL

- Note: 1. Result Level = Read Level + Antenna Factor + Cable loss - PRM Factor.  
 2. If Peak Result complies with AV limit, AV Result is deemed to comply with AV limit.  
 3. Test setup: RBW: 1 MHz, VBW: 3 MHz, Sweep time: auto.

# TR-4-E-009 Radiated Emission Test Result

**Test Site** : DDT 3m Chamber 1# D:\2017 RE1# Report Data\Q17112903-1E\FCC ID 1-18G BT 2.4G WIFI.EM6  
**Test Date** : 2017-12-29 **Tested By** : Sunny  
**EUT** : Wireless speaker **Model Number** : ALLURE PORTABLE  
**Power Supply** : AC 120V/60Hz **Test Mode** : TX mode 11G 2462Hz  
**Condition** : Temp:24.5'C,Humi:55%,  
 Press:100.1kPa **Antenna/Distance** : 2017 HF907/3m/HORIZONTAL  
**Memo** :

Data: 43

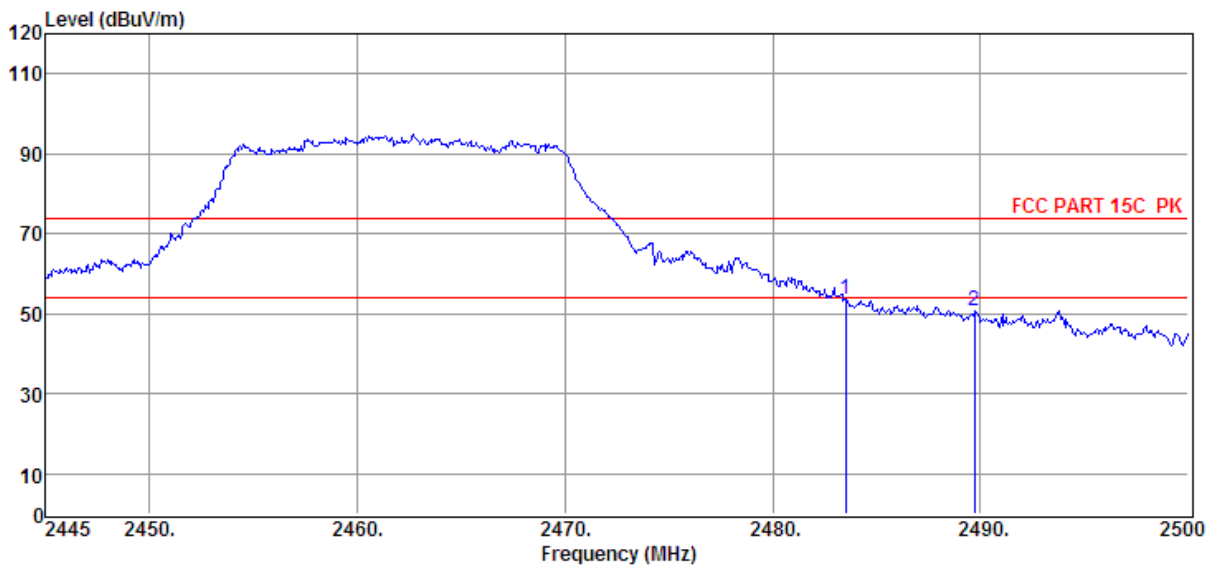

Item	Freq.	Read Level	Antenna Factor	PRM Factor	Cable Loss	Result Level	Limit Line	Over Limit	Detector	Polarization
(Mark)	(MHz)	(dBμV)	(dB/m)	dB	dB	(dBμV/m)	(dBμV/m)	(dB)		
1	2483.50	50.81	27.34	29.71	5.21	53.65	74.00	-20.35	Peak	HORIZONTAL
2	2489.72	47.86	27.36	29.71	5.22	50.73	74.00	-23.27	Peak	HORIZONTAL

Note: 1. Result Level = Read Level + Antenna Factor + Cable loss - PRM Factor.  
 2. If Peak Result complies with AV limit, AV Result is deemed to comply with AV limit.  
 3. Test setup: RBW: 1 MHz, VBW: 3 MHz, Sweep time: auto.

# TR-4-E-009 Radiated Emission Test Result

**Test Site** : DDT 3m Chamber 1# D:\2017 RE1# Report Data\Q17112903-1E\FCC ID 1-18G BT 2.4G WIFI.EM6  
**Test Date** : 2017-12-29 **Tested By** : Sunny  
**EUT** : Wireless speaker **Model Number** : ALLURE PORTABLE  
**Power Supply** : AC 120V/60Hz **Test Mode** : TX mode 11G 2462Hz  
**Condition** : Temp:24.5'C,Humi:55%,  
 Press:100.1kPa **Antenna/Distance** : 2017 HF907/3m/HORIZONTAL  
**Memo** :

Data: 44

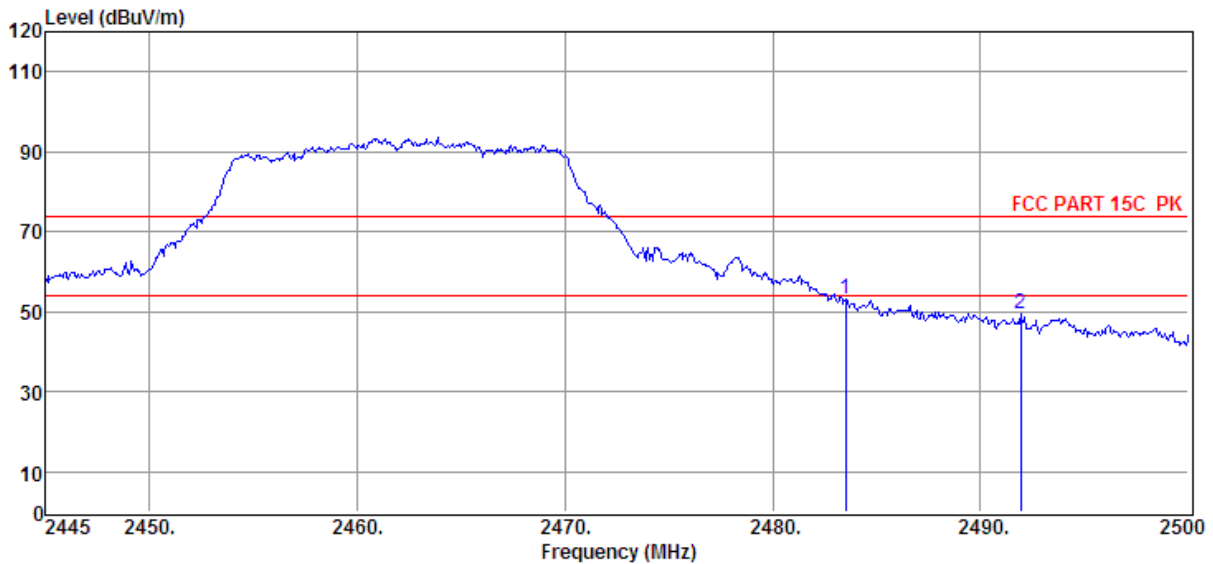

Item	Freq.	Read Level	Antenna Factor	PRM Factor	Cable Loss	Result Level	Limit Line	Over Limit	Detector	Polarization
(Mark)	(MHz)	(dBμV)	(dB/m)	dB	dB	(dBμV/m)	(dBμV/m)	(dB)		
1	2483.50	50.29	27.34	29.71	5.21	53.13	74.00	-20.87	Peak	HORIZONTAL
2	2491.92	46.72	27.37	29.73	5.22	49.58	74.00	-24.42	Peak	HORIZONTAL

Note: 1. Result Level = Read Level + Antenna Factor + Cable loss - PRM Factor.  
 2. If Peak Result complies with AV limit, AV Result is deemed to comply with AV limit.  
 3. Test setup: RBW: 1 MHz, VBW: 3 MHz, Sweep time: auto.

# TR-4-E-009 Radiated Emission Test Result

**Test Site** : DDT 3m Chamber 1# D:\2017 RE1# Report Data\Q17112903-1E\FCC ID 1-18G BT 2.4G WIFI.EM6  
**Test Date** : 2018-01-04 **Tested By** : Sunny  
**EUT** : Wireless speaker **Model Number** : ALLURE PORTABLE  
**Power Supply** : AC 120V/60Hz **Test Mode** : TX mode 11N20 2412Hz  
**Condition** : Temp:24.5'C,Humi:55%,  
 Press:100.1kPa **Antenna/Distance** : 2017 HF907/3m/VERTICAL  
**Memo** :

Data: 45

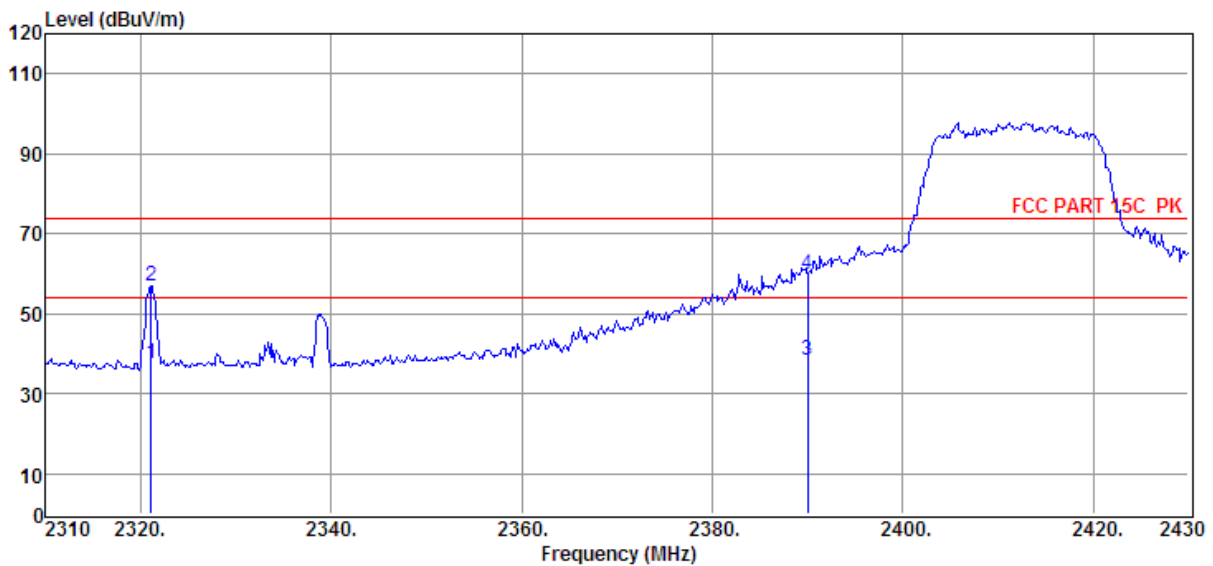

Item (Mark)	Freq. (MHz)	Read Level (dBμV)	Antenna Factor (dB/m)	PRM Factor (dB)	Cable Loss (dB)	Result Level (dBμV/m)	Limit Line (dBμV/m)	Over Limit (dB)	Detector	Polarization
1	2321.04	35.14	26.76	29.30	5.03	37.63	54.00	-16.37	Average	VERTICAL
2	2321.04	54.24	26.76	29.30	5.03	56.73	74.00	-17.27	Peak	VERTICAL
3	2390.00	35.62	27.00	29.42	5.11	38.31	54.00	-15.69	Average	VERTICAL
4	2390.00	57.18	27.00	29.42	5.11	59.87	74.00	-14.13	Peak	VERTICAL

Note: 1. Result Level = Read Level + Antenna Factor + Cable loss - PRM Factor.  
 2. If Peak Result complies with AV limit, AV Result is deemed to comply with AV limit.  
 3. Test setup: RBW: 1 MHz, VBW: 3 MHz, Sweep time: auto.

# TR-4-E-009 Radiated Emission Test Result

**Test Site** : DDT 3m Chamber 1# D:\2017 RE1# Report Data\Q17112903-1E\FCC ID 1-18G BT 2.4G WIFI.EM6  
**Test Date** : 2018-01-04 **Tested By** : Sunny  
**EUT** : Wireless speaker **Model Number** : ALLURE PORTABLE  
**Power Supply** : AC 120V/60Hz **Test Mode** : TX mode 11N20 2412Hz  
**Condition** : Temp:24.5'C,Humi:55%,  
 Press:100.1kPa **Antenna/Distance** : 2017 HF907/3m/HORIZONTAL  
**Memo** :

Data: 46

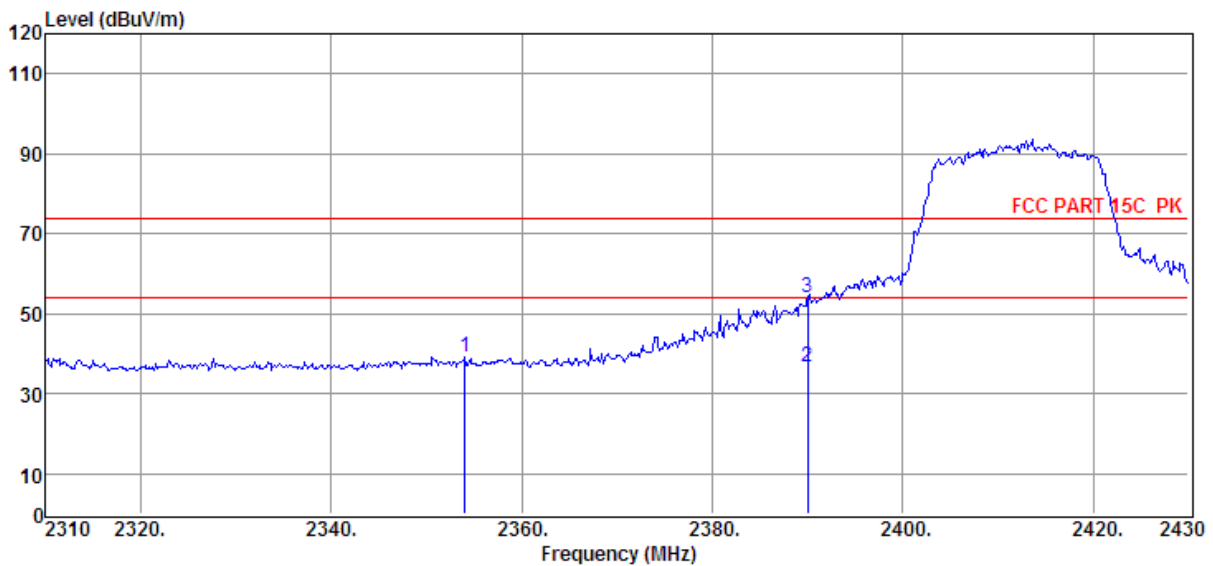

Item (Mark)	Freq. (MHz)	Read Level (dBμV)	Antenna Factor (dB/m)	PRM Facto r dB	Cable Loss dB	Result Level (dBμV/m)	Limit Line (dBμV/m)	Over Limit (dB)	Detector	Polarization
1	2354.04	36.73	26.87	29.34	5.07	39.33	74.00	-34.67	Peak	HORIZONTAL
2	2390.00	34.14	27.00	29.42	5.11	36.83	54.00	-17.17	Average	HORIZONTAL
3	2390.00	51.49	27.00	29.42	5.11	54.18	74.00	-19.82	Peak	HORIZONTAL

- Note: 1. Result Level = Read Level + Antenna Factor + Cable loss - PRM Factor.  
 2. If Peak Result complies with AV limit, AV Result is deemed to comply with AV limit.  
 3. Test setup: RBW: 1 MHz, VBW: 3 MHz, Sweep time: auto.

# TR-4-E-009 Radiated Emission Test Result

**Test Site** : DDT 3m Chamber 1# D:\2017 RE1# Report Data\Q17112903-1E\FCC ID 1-18G BT 2.4G WIFI.EM6  
**Test Date** : 2018-01-04 **Tested By** : Sunny  
**EUT** : Wireless speaker **Model Number** : ALLURE PORTABLE  
**Power Supply** : AC 120V/60Hz **Test Mode** : TX mode 11N20 2462Hz  
**Condition** : Temp:24.5'C,Humi:55%,  
 Press:100.1kPa **Antenna/Distance** : 2017 HF907/3m/VERTICAL  
**Memo** :

Data: 53

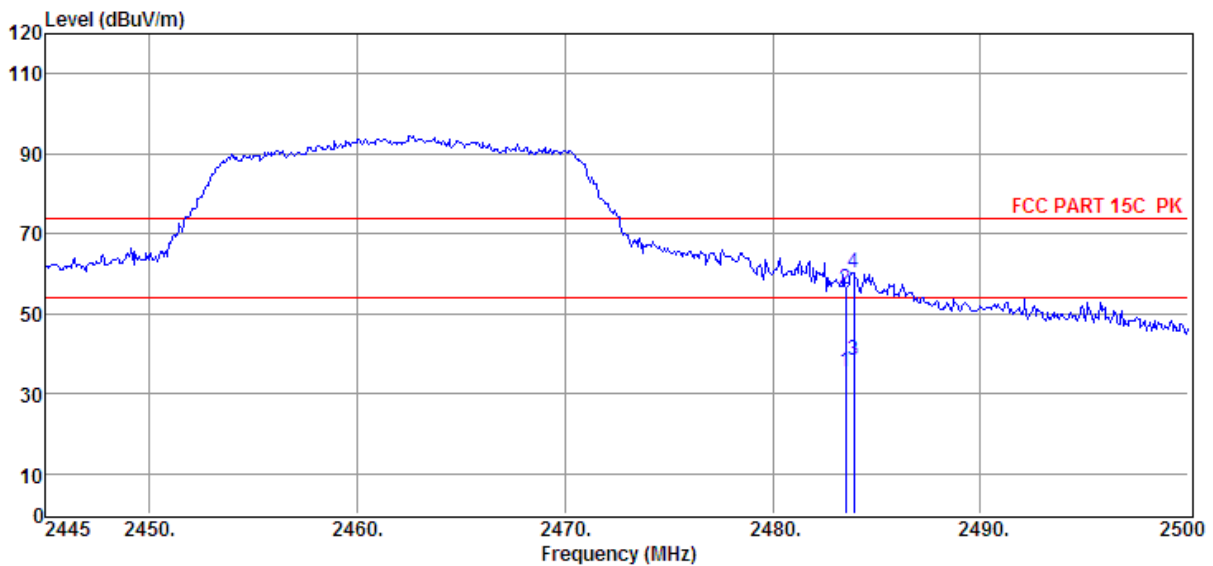

Item (Mark)	Freq. (MHz)	Read Level (dBμV)	Antenna Factor (dB/m)	PRM Factor (dB)	Cable Loss (dB)	Result Level (dBμV/m)	Limit Line (dBμV/m)	Over Limit (dB)	Detector	Polarization
1	2483.50	32.68	27.34	29.71	5.21	35.52	54.00	-18.48	Average	VERTICAL
2	2483.50	53.31	27.34	29.71	5.21	56.15	74.00	-17.85	Peak	VERTICAL
3	2483.89	35.58	27.34	29.71	5.21	38.42	54.00	-15.58	Average	VERTICAL
4	2483.89	57.43	27.34	29.71	5.21	60.27	74.00	-13.73	Peak	VERTICAL

- Note: 1. Result Level = Read Level + Antenna Factor + Cable loss - PRM Factor.  
 2. If Peak Result complies with AV limit, AV Result is deemed to comply with AV limit.  
 3. Test setup: RBW: 1 MHz, VBW: 3 MHz, Sweep time: auto.



# TR-4-E-009 Radiated Emission Test Result

**Test Site** : DDT 3m Chamber 1# D:\2017 RE1# Report Data\Q17112903-1E\FCC ID 1-18G BT 2.4G WIFI.EM6  
**Test Date** : 2018-01-04 **Tested By** : Sunny  
**EUT** : Wireless speaker **Model Number** : ALLURE PORTABLE  
**Power Supply** : AC 120V/60Hz **Test Mode** : TX mode 11N20 2462Hz  
**Condition** : Temp:24.5'C,Humi:55%,  
 Press:100.1kPa **Antenna/Distance** : 2017 HF907/3m/HORIZONTAL  
**Memo** :

Data: 54

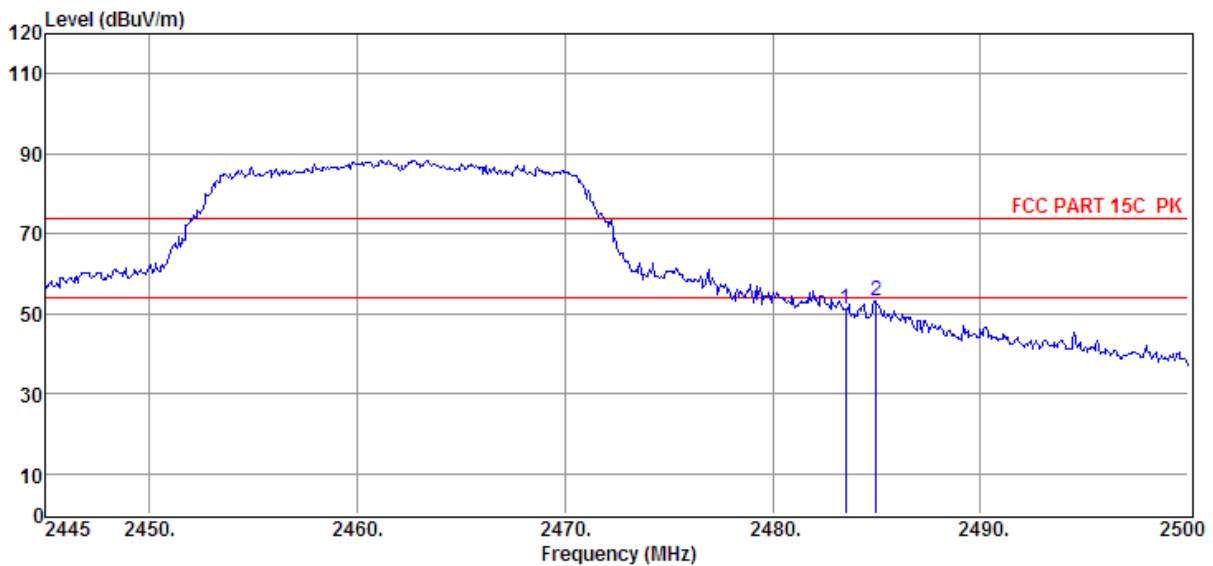

Item	Freq.	Read Level	Antenna Factor	PRM Factor	Cable Loss	Result Level	Limit Line	Over Limit	Detector	Polarization
(Mark)	(MHz)	(dBμV)	(dB/m)	dB	dB	(dBμV/m)	(dBμV/m)	(dB)		
1	2483.50	48.44	27.34	29.71	5.21	51.28	74.00	-22.72	Peak	HORIZONTAL
2	2484.99	50.48	27.35	29.71	5.21	53.33	74.00	-20.67	Peak	HORIZONTAL

Note: 1. Result Level = Read Level + Antenna Factor + Cable loss - PRM Factor.  
 2. If Peak Result complies with AV limit, AV Result is deemed to comply with AV limit.  
 3. Test setup: RBW: 1 MHz, VBW: 3 MHz, Sweep time: auto.

## 9. Power Line Conducted Emission

### 9.1. Block diagram of test setup

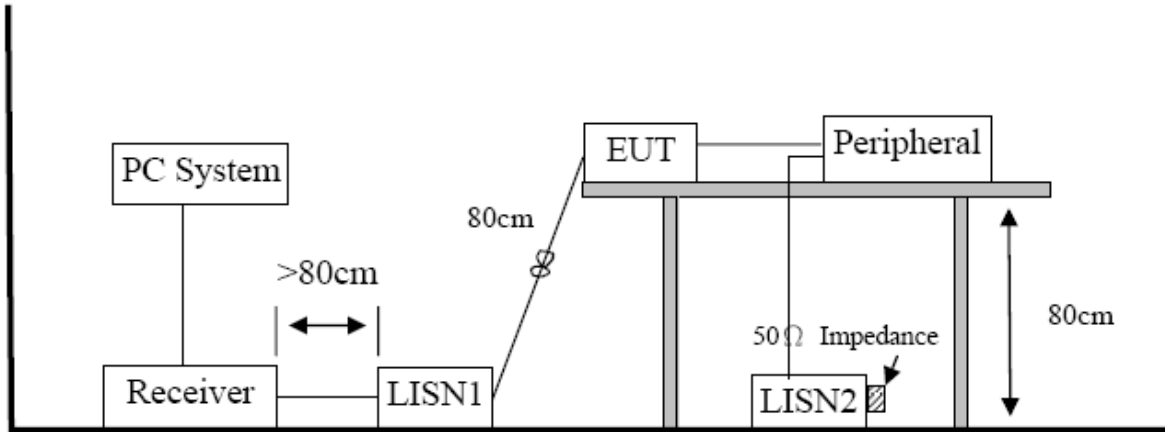

### 9.2. Power Line Conducted Emission Limits(Class B)

Frequency	Quasi-Peak Level dB(μV)	Average Level dB(μV)
150kHz ~ 500kHz	66 ~ 56*	56 ~ 46*
500kHz ~ 5MHz	56	46
5MHz ~ 30MHz	60	50

Note 1: \* Decreasing linearly with logarithm of frequency.

Note 2: The lower limit shall apply at the transition frequencies.

### 9.3. Test Procedure

The EUT and Support equipment, if needed, were put placed on a non-metallic table, 80cm above the ground plane.

All I/O cables were positioned to simulate typical actual usage as per ANSI C63.4.

All support equipment power received from a second LISN.

Emissions were measured on each current carrying line of the EUT using an EMI Test Receiver connected to the LISN powering the EUT.

The Receiver scanned from 150 kHz to 30MHz for emissions in each of the test modes.

During the above scans, the emissions were maximized by cable manipulation.

After the preliminary scan, we found the test mode producing the highest emission level.

The EUT configuration and worse cable configuration of the above highest emission levels were recorded for reference of the final test.

EUT and support equipment were set up on the test bench as per the configuration with highest emission level in the preliminary test.

A scan was taken on both power lines, Neutral and Line, recording at least the six highest emissions.

Emission frequency and amplitude were recorded into a computer in which correction factors were used to calculate the emission level and compare reading to the applicable limit.

The test data of the worst-case condition(s) was recorded.

The bandwidth of test receiver is set at 9 KHz.

#### **9.4. Test Result**

**PASS. (See below detailed test result)**

Note1: All emissions not reported below are too low against the prescribed limits.

Note2: "----" means peak detection; "----" means average detection

Note3: Pre-test AC conducted emission at both voltage AC 120V/60Hz and AC 240V/50Hz, recorded worst case (AC 120V/60Hz).

# TR-4-E-010 Conducted Emission Test Result

**Test Site** : DDT 1# Shield Room E:\2017 CE report data\Q17112903-1E\CE.EM6  
**Test Date** : 2017-12-22 **Tested By** : Sincere  
**EUT** : Wireless Speaker **Model Number** : ALLURE PORTABLE  
**Power Supply** : AC 120V/60Hz **Test Mode** : TX mode  
**Condition** : Temp:24.5°C,Humi:55%,  
 Press:100.1kPa **LISN** : 2017 ENV216/NEUTRAL  
**Memo** :

Data: 18

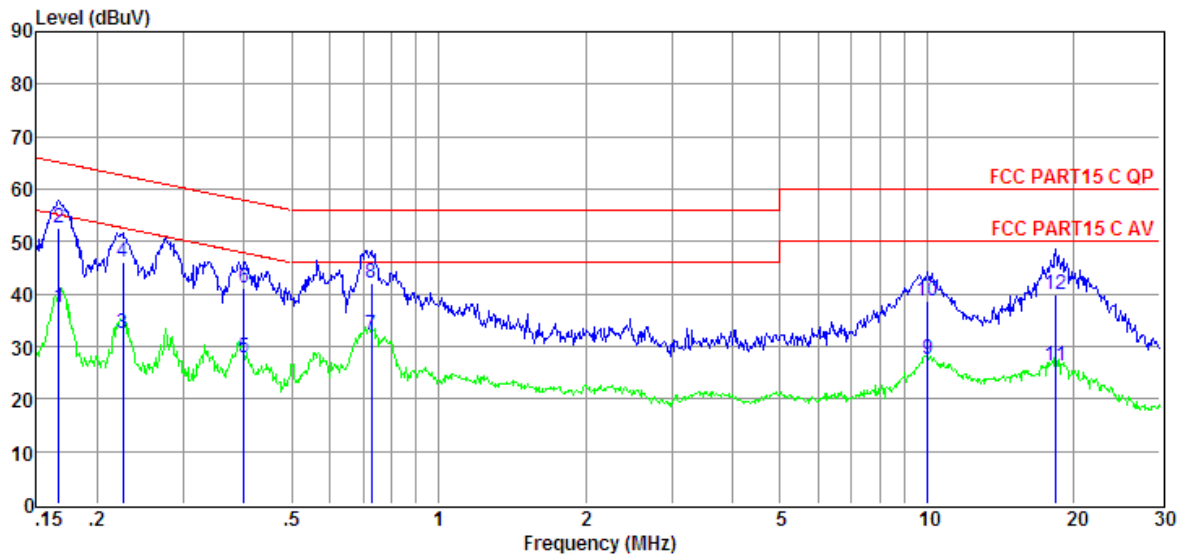

Item (Mark)	Freq. (MHz)	Read Level (dBμV)	LISN Factor (dB)	Cable Loss (dB)	Pulse Limiter Factor (dB)	Result Level (dBμV)	Limit Line (dBμV)	Over Limit (dB)	Detector	Phase
1	0.17	18.09	9.47	-0.04	9.86	37.38	55.12	-17.74	Average	NEUTRAL
2	0.17	33.18	9.47	-0.04	9.86	52.47	65.12	-12.65	QP	NEUTRAL
3	0.23	13.35	9.43	-0.04	9.86	32.60	52.61	-20.01	Average	NEUTRAL
4	0.23	26.81	9.43	-0.04	9.86	46.06	62.61	-16.55	QP	NEUTRAL
5	0.40	8.68	9.37	-0.04	9.83	27.84	47.86	-20.02	Average	NEUTRAL
6	0.40	22.02	9.37	-0.04	9.83	41.18	57.86	-16.68	QP	NEUTRAL
7	0.73	13.08	9.32	-0.09	9.86	32.17	46.00	-13.83	Average	NEUTRAL
8	0.73	23.10	9.32	-0.09	9.86	42.19	56.00	-13.81	QP	NEUTRAL
9	10.02	8.16	9.44	-0.12	9.89	27.37	50.00	-22.63	Average	NEUTRAL
10	10.02	19.47	9.44	-0.12	9.89	38.68	60.00	-21.32	QP	NEUTRAL
11	18.33	6.97	9.47	-0.11	9.93	26.26	50.00	-23.74	Average	NEUTRAL
12	18.33	20.62	9.47	-0.11	9.93	39.91	60.00	-20.09	QP	NEUTRAL

- Note: 1. Result Level = Read Level +LISN Factor + Pulse Limiter Factor + Cable loss.  
 2. If QP Result complies with AV limit, AV Result is deemed to comply with AV limit.  
 3. Test setup: RBW: 200 Hz (9 kHz—150 kHz), 9 kHz (150 kHz—30 MHz).  
 4. Step size: 80Hz (0.009MHz-0.15MHz), 4 kHz (0.15MHz-30MHz), Scan time: auto.

# TR-4-E-010 Conducted Emission Test Result

**Test Site** : DDT 1# Shield Room E:\2017 CE report data\Q17112903-1E\CE.EM6  
**Test Date** : 2017-12-22 **Tested By** : Sincere  
**EUT** : Wireless Speaker **Model Number** : ALLURE PORTABLE  
**Power Supply** : AC 120V/60Hz **Test Mode** : TX mode  
**Condition** : Temp:24.5°C,Humi:55%,  
**LISN** : 2017 ENV216/LINE  
 Press:100.1kPa  
**Memo** :

Data: 20

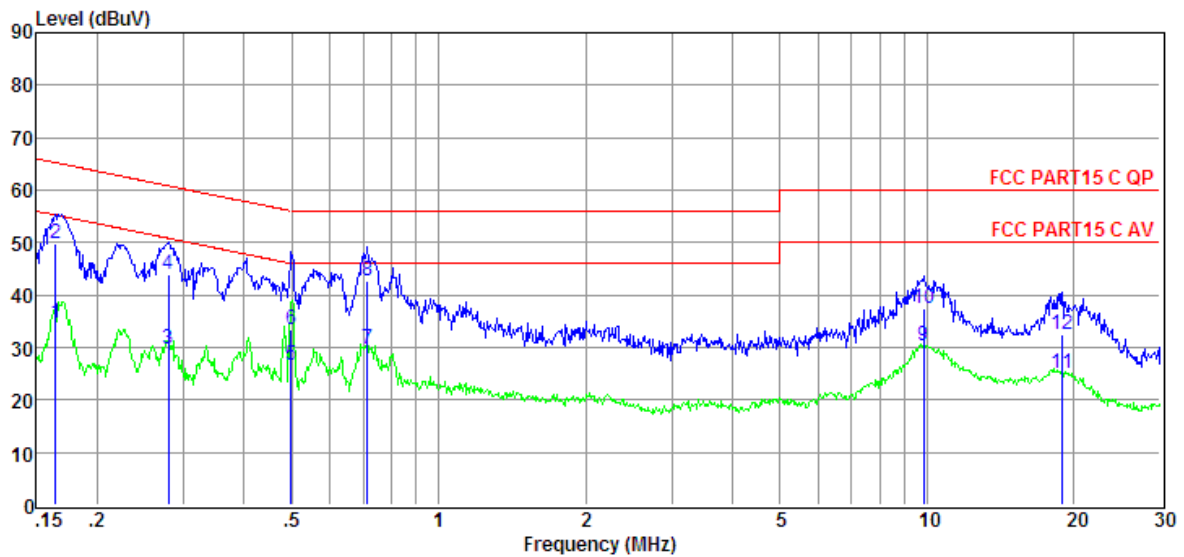

Item (Mark)	Freq. (MHz)	Read Level (dBµV)	LISN Factor (dB)	Cable Loss (dB)	Pulse Limiter Factor (dB)	Result Level (dBµV)	Limit Line (dBµV)	Over Limit (dB)	Detector	Phase
1	0.16	15.39	9.52	-0.04	9.86	34.73	55.25	-20.52	Average	LINE
2	0.16	30.55	9.52	-0.04	9.86	49.89	65.25	-15.36	QP	LINE
3	0.28	10.23	9.53	-0.04	9.86	29.58	50.81	-21.23	Average	LINE
4	0.28	24.70	9.53	-0.04	9.86	44.05	60.81	-16.76	QP	LINE
5	0.50	7.44	9.54	-0.04	9.80	26.74	46.01	-19.27	Average	LINE
6	0.50	13.96	9.54	-0.04	9.80	33.26	56.01	-22.75	QP	LINE
7	0.72	10.52	9.55	-0.09	9.86	29.84	46.00	-16.16	Average	LINE
8	0.72	23.45	9.55	-0.09	9.86	42.77	56.00	-13.23	QP	LINE
9	9.86	10.77	9.82	-0.12	9.89	30.36	50.00	-19.64	Average	LINE
10	9.86	17.96	9.82	-0.12	9.89	37.55	60.00	-22.45	QP	LINE
11	18.92	5.24	9.89	-0.11	9.94	24.96	50.00	-25.04	Average	LINE
12	18.92	12.79	9.89	-0.11	9.94	32.51	60.00	-27.49	QP	LINE

Note: 1. Result Level = Read Level + LISN Factor + Pulse Limiter Factor + Cable loss.  
 2. If QP Result complies with AV limit, AV Result is deemed to comply with AV limit.  
 3. Test setup: RBW: 200 Hz (9 kHz—150 kHz), 9 kHz (150 kHz—30 MHz).  
 4. Step size: 80Hz (0.009MHz-0.15MHz), 4 kHz (0.15MHz-30MHz), Scan time: auto.

## **10. Antenna Requirements**

### **10.1. Limit**

For intentional device, according to FCC 47 CFR Section 15.203, an intentional radiator shall be designed to ensure that no antenna other than that furnished by the responsible party shall be used with the device. And according to FCC 47 CFR Section 15.247 (b), if transmitting antennas of directional gain greater than 6dBi are used, the power shall be reduced by the amount in dB that the directional gain of the antenna exceeds 6dBi.

### **10.2. Result**

The antennas used for this product are integrated antenna and other than that furnished by the responsible party shall be used with the device, the maximum peak gain of the transmit antenna is only 2.25dBi.

**END OF REPORT**