

### Occupied Bandwidth Measurement\_11N20MIMO\_5240\_Ant1

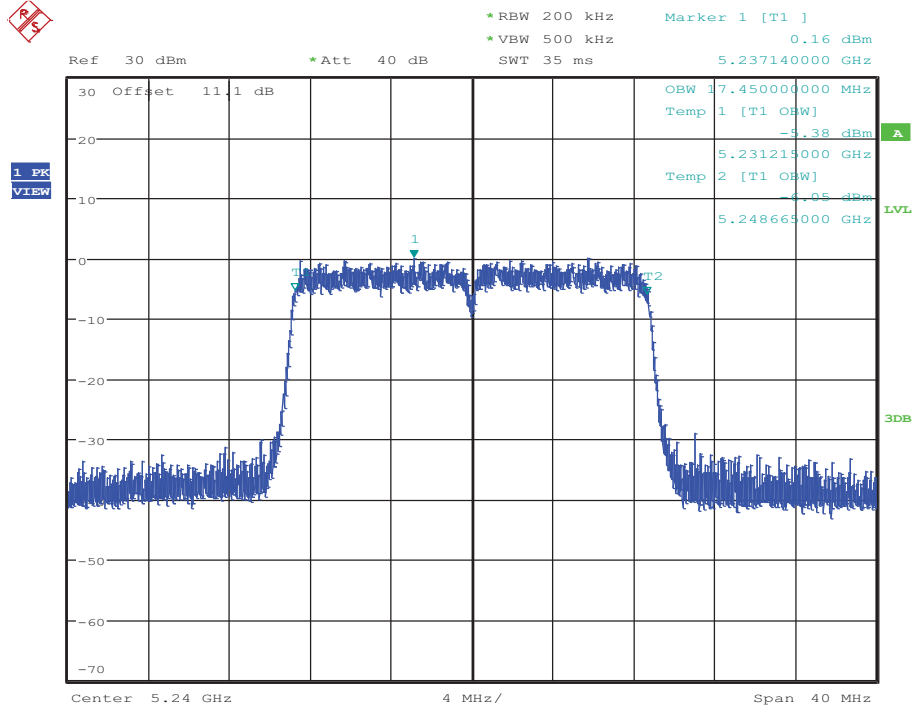

Date: 14.OCT.2017 14:07:24

### Occupied Bandwidth Measurement\_11N20MIMO\_5240\_Ant2

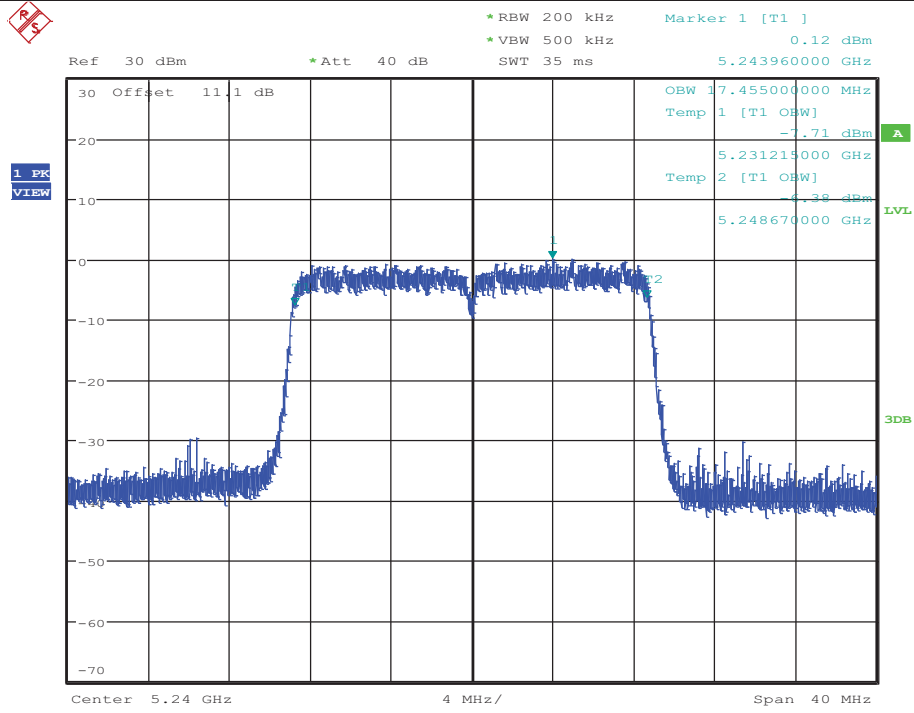

Date: 14.OCT.2017 14:14:02

### Occupied Bandwidth Measurement\_11N20MIMO\_5260\_Ant1

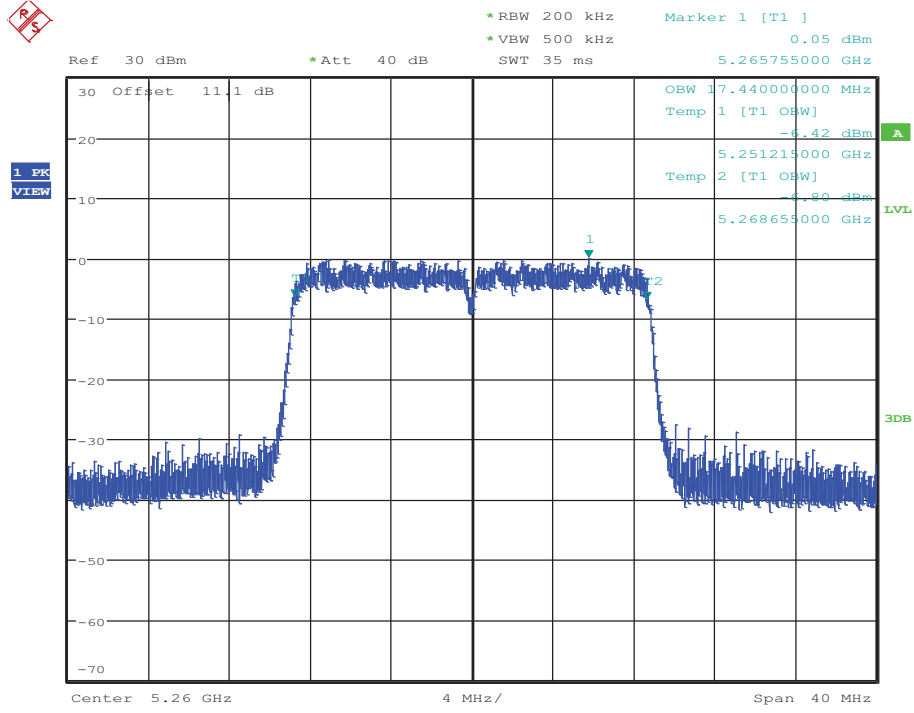

Date: 14.OCT.2017 16:04:27

### Occupied Bandwidth Measurement\_11N20MIMO\_5260\_Ant2

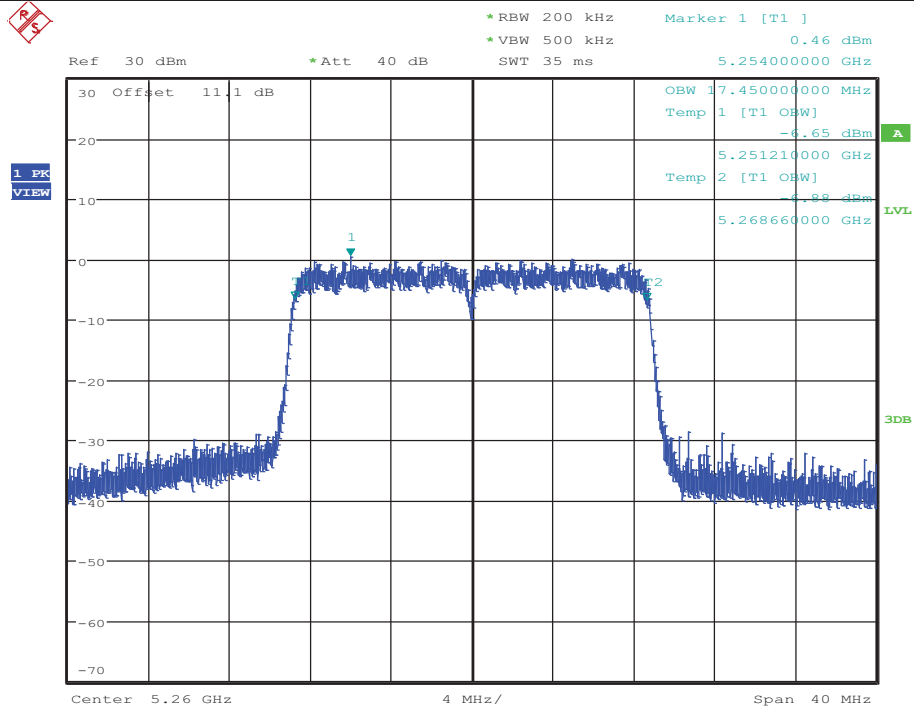

Date: 14.OCT.2017 16:12:29

### Occupied Bandwidth Measurement\_11N20MIMO\_5280\_Ant1

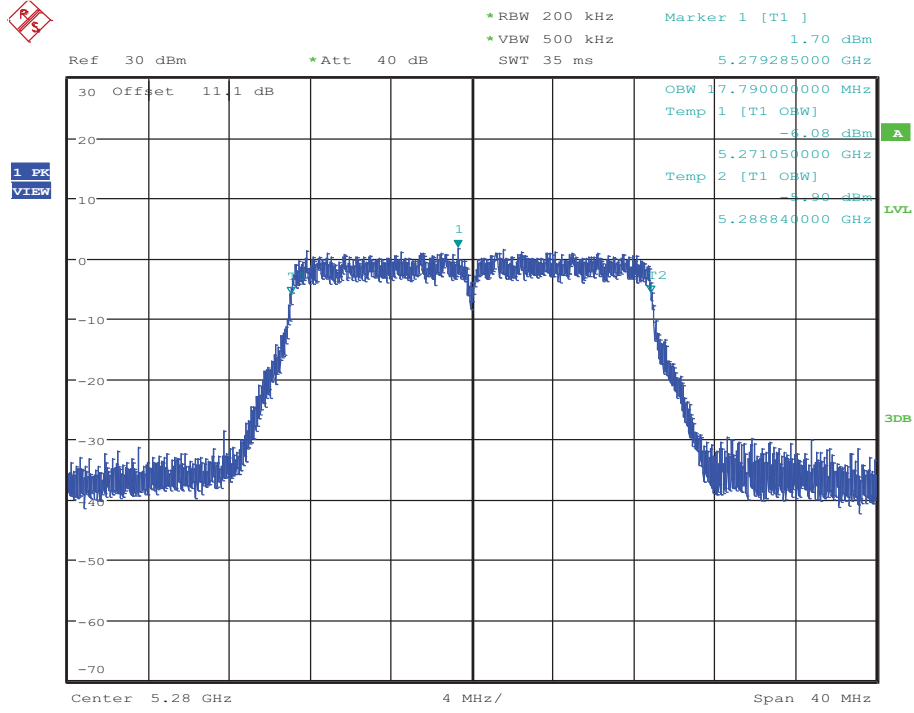

Date: 16.OCT.2017 17:35:49

### Occupied Bandwidth Measurement\_11N20MIMO\_5280\_Ant2

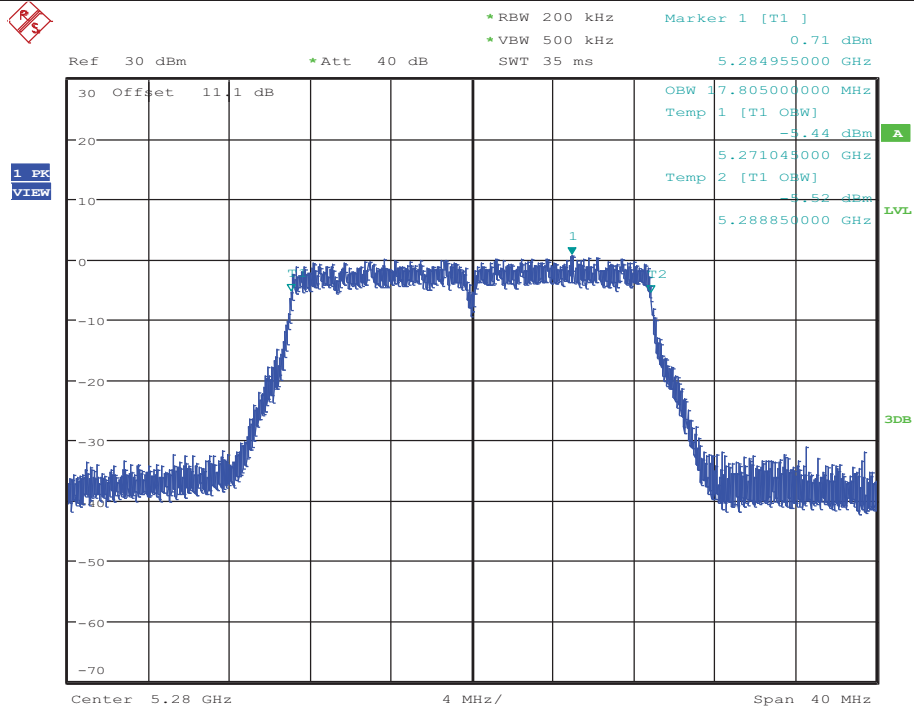

Date: 16.OCT.2017 17:40:13

### Occupied Bandwidth Measurement\_11N20MIMO\_5320\_Ant1

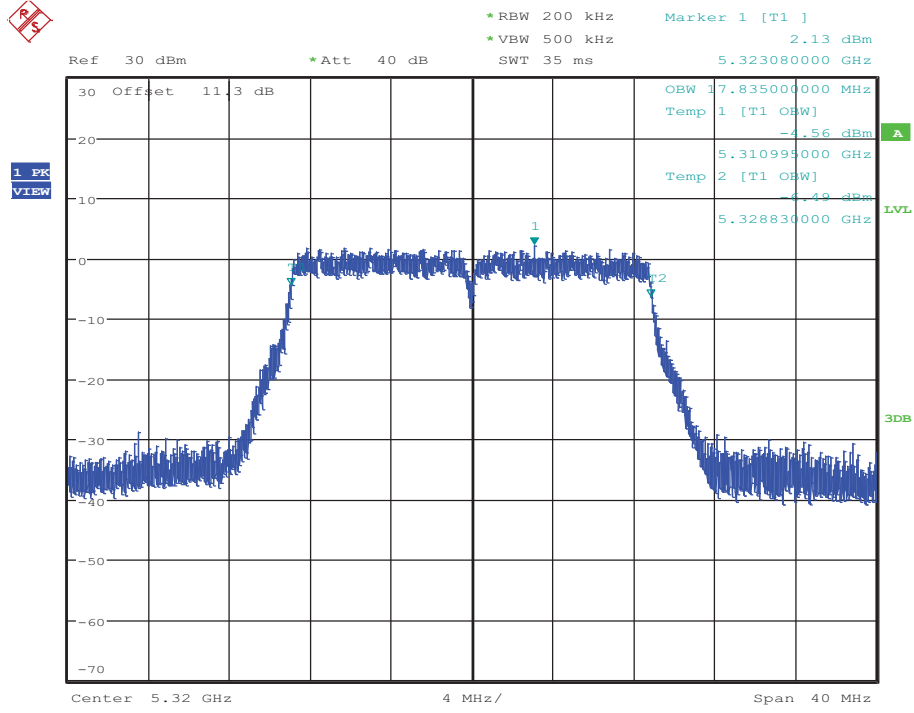

Date: 16.OCT.2017 17:45:25

### Occupied Bandwidth Measurement\_11N20MIMO\_5320\_Ant2

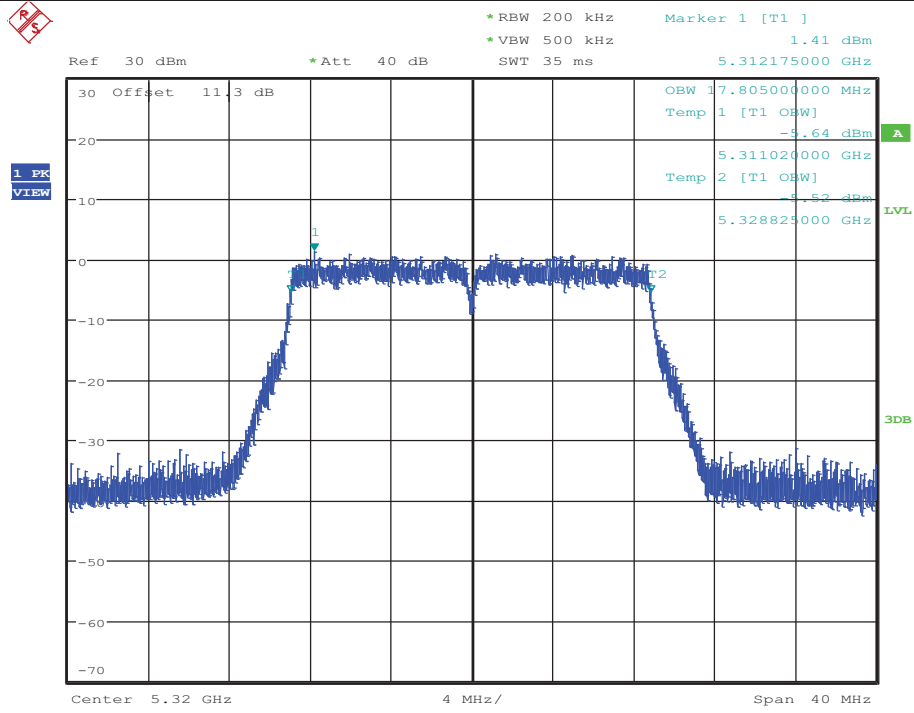

Date: 16.OCT.2017 17:51:40

### Occupied Bandwidth Measurement\_11N20MIMO\_5500\_Ant1

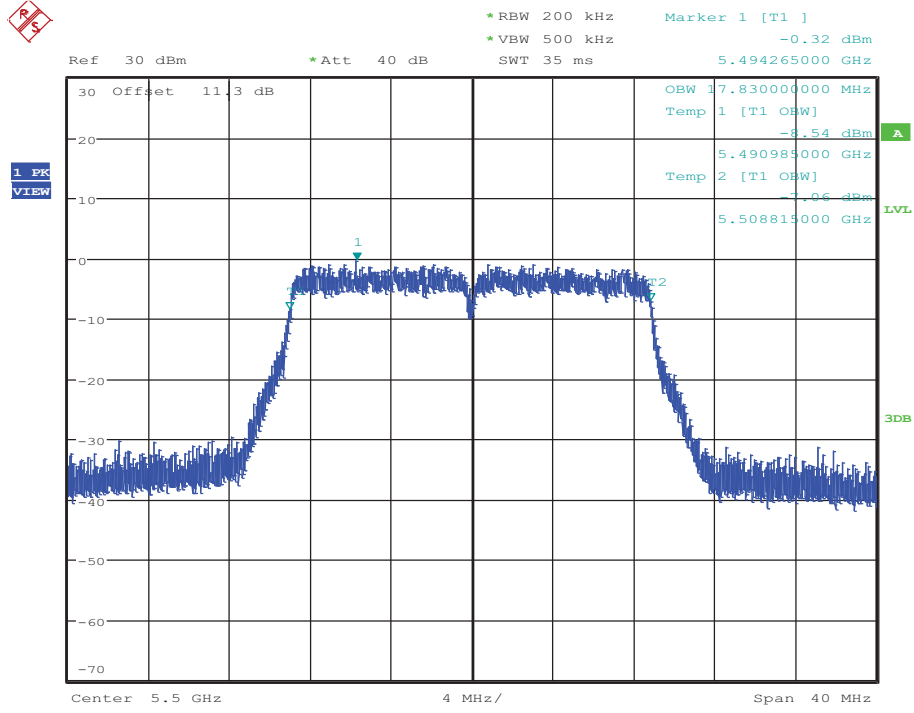

Date: 16.OCT.2017 17:57:21

### Occupied Bandwidth Measurement\_11N20MIMO\_5500\_Ant2

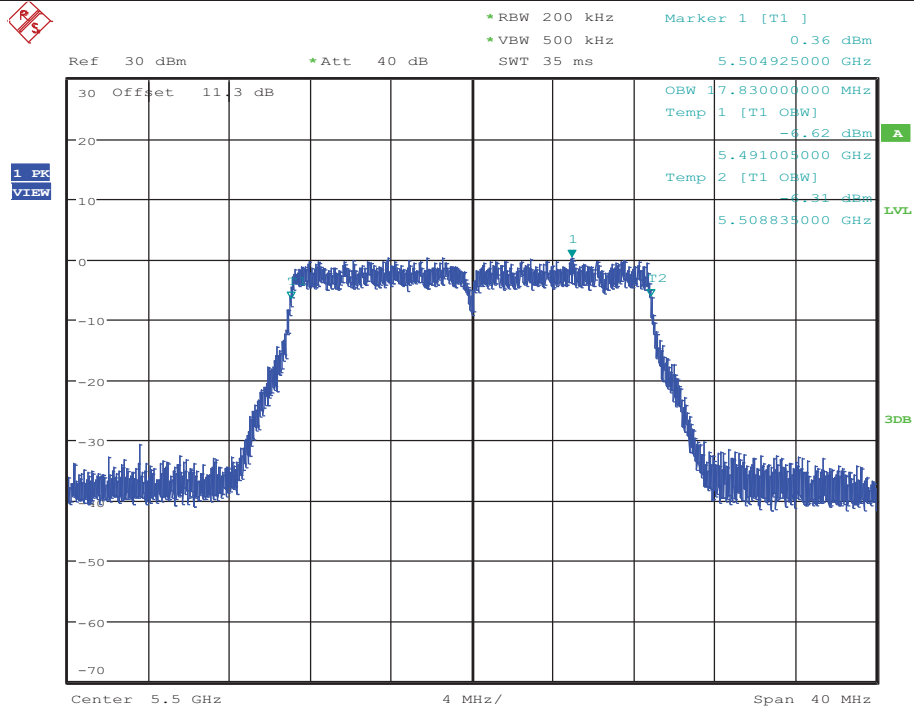

Date: 16.OCT.2017 18:02:58

### Occupied Bandwidth Measurement\_11N20MIMO\_5580\_Ant1

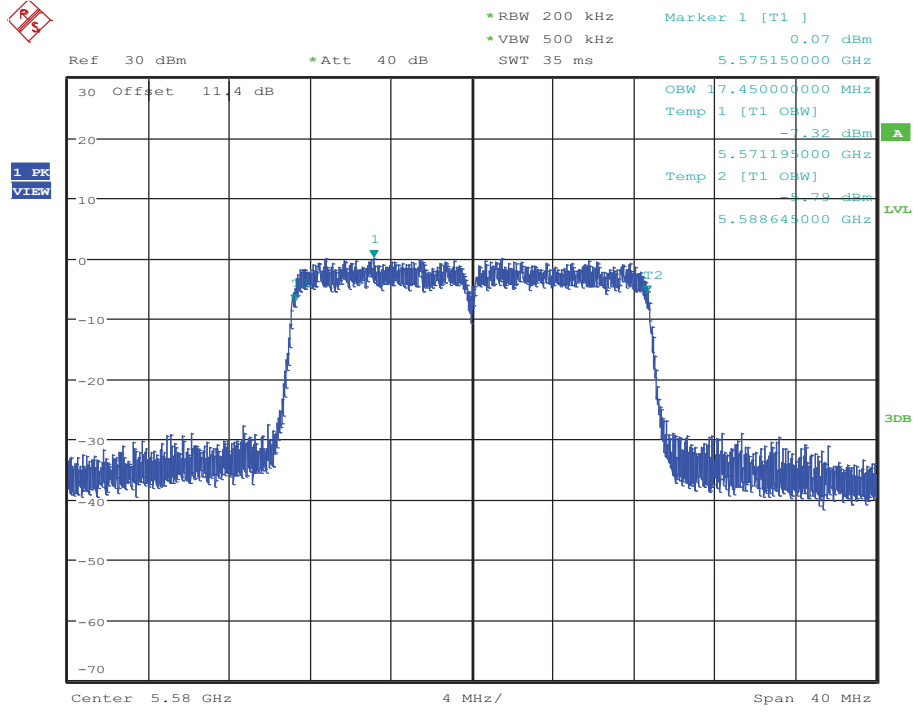

Date: 16.OCT.2017 18:10:41

### Occupied Bandwidth Measurement\_11N20MIMO\_5580\_Ant2

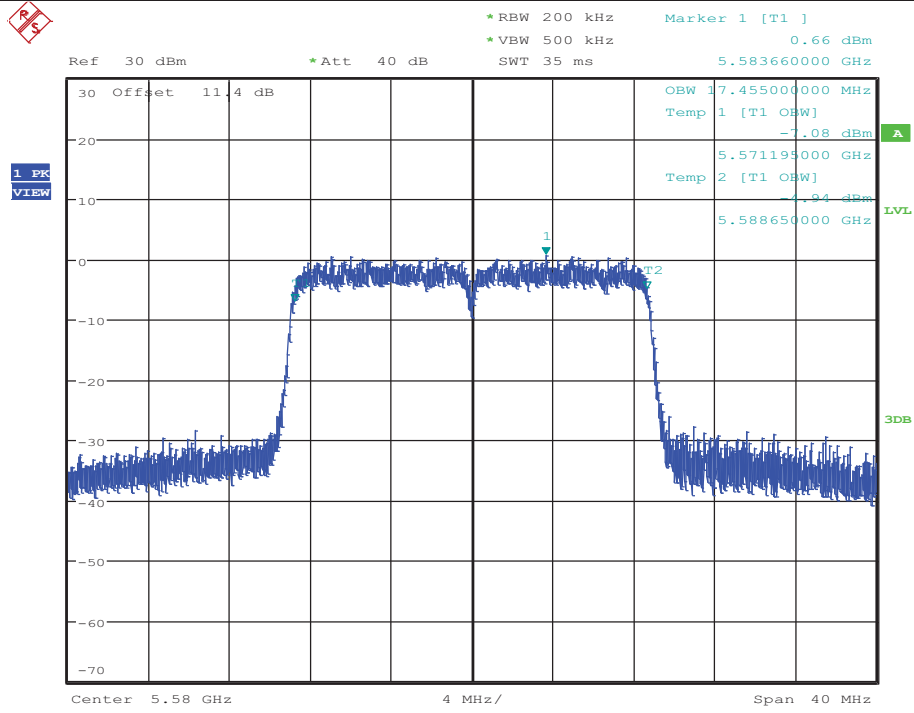

Date: 16.OCT.2017 18:15:04

### Occupied Bandwidth Measurement\_11N20MIMO\_5700\_Ant1

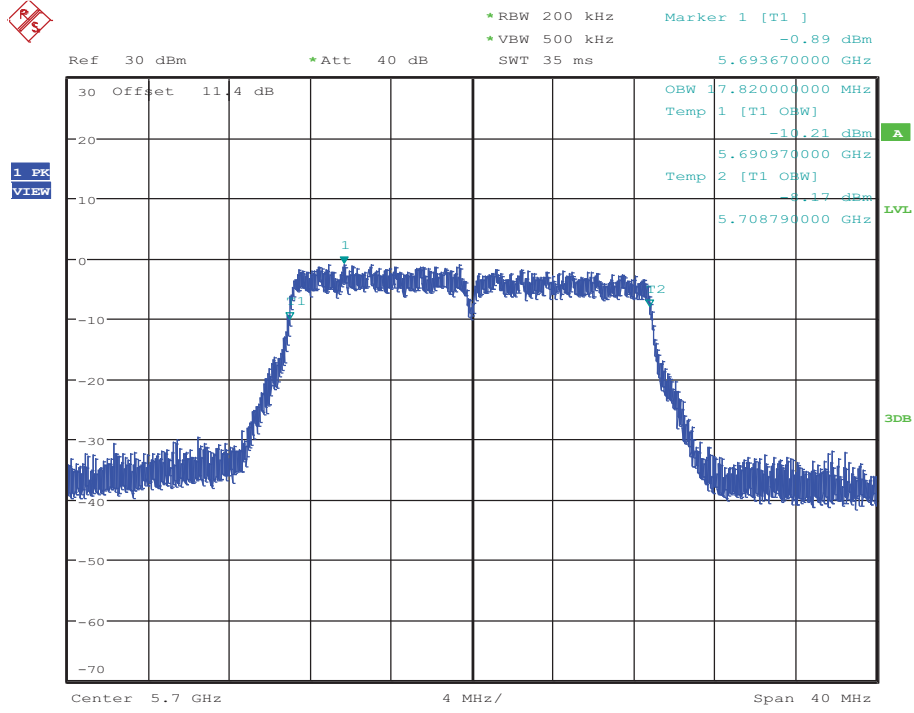

Date: 16.OCT.2017 18:51:49

### Occupied Bandwidth Measurement\_11N20MIMO\_5700\_Ant2

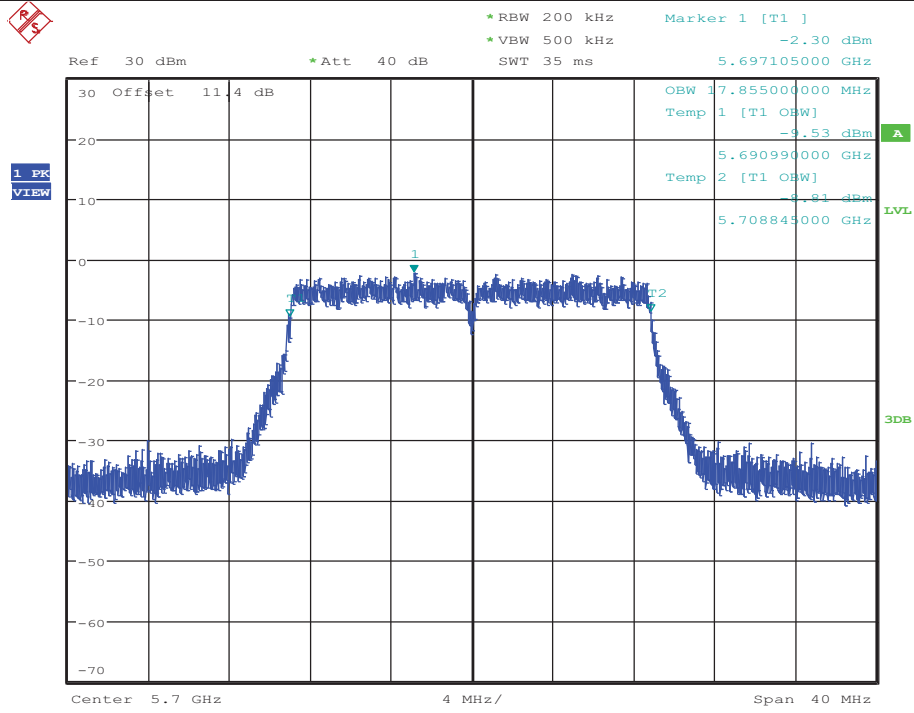

Date: 16.OCT.2017 18:58:35

### Occupied Bandwidth Measurement\_11N20MIMO\_5745\_Ant1

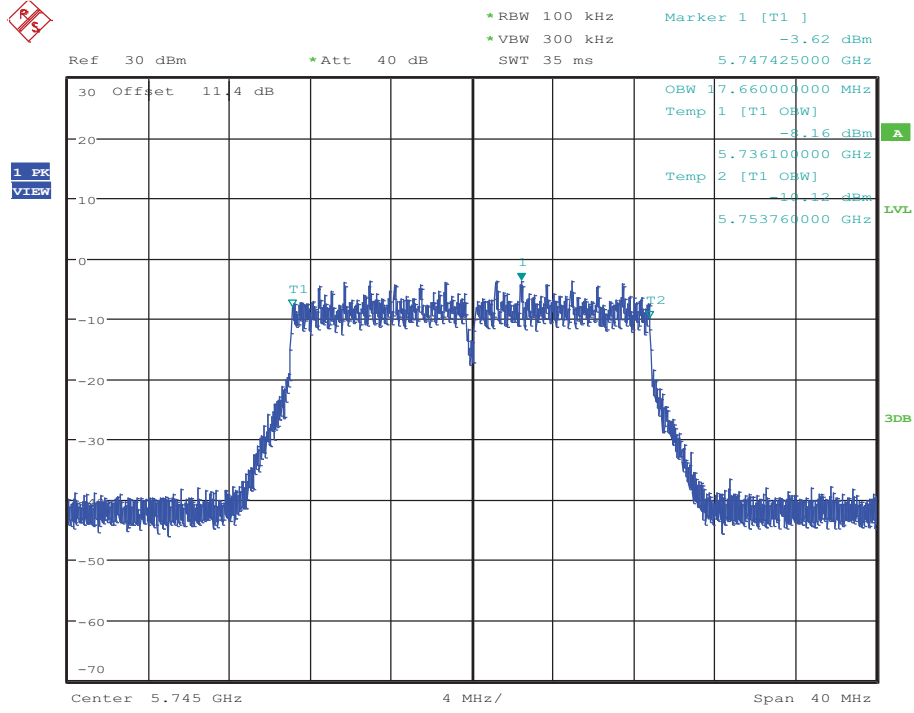

Date: 16.OCT.2017 19:04:04

### Occupied Bandwidth Measurement\_11N20MIMO\_5745\_Ant2

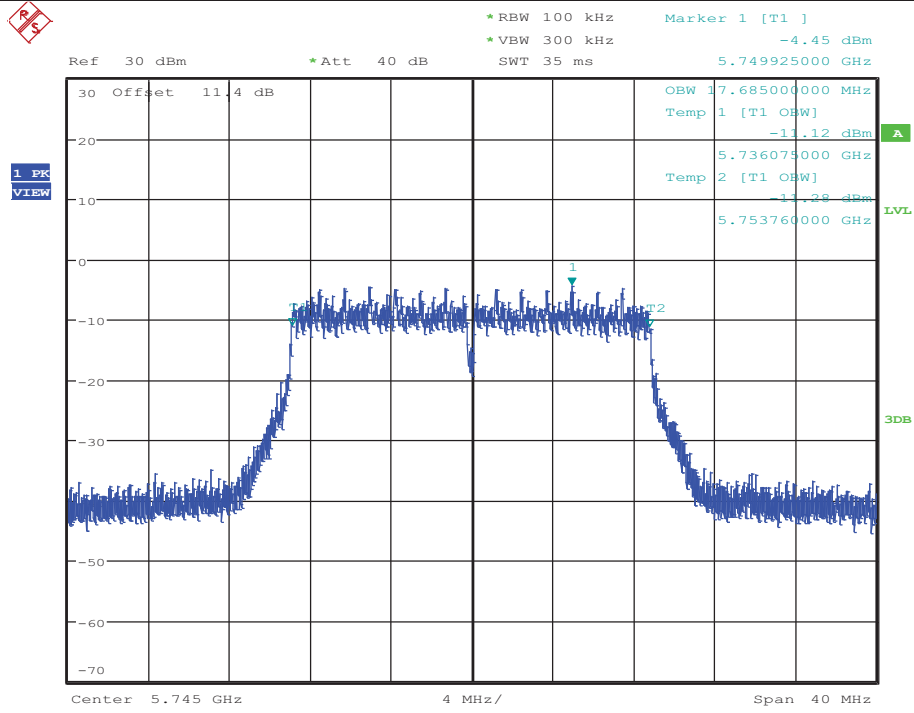

Date: 16.OCT.2017 19:07:55



### Occupied Bandwidth Measurement\_11N20MIMO\_5785\_Ant1

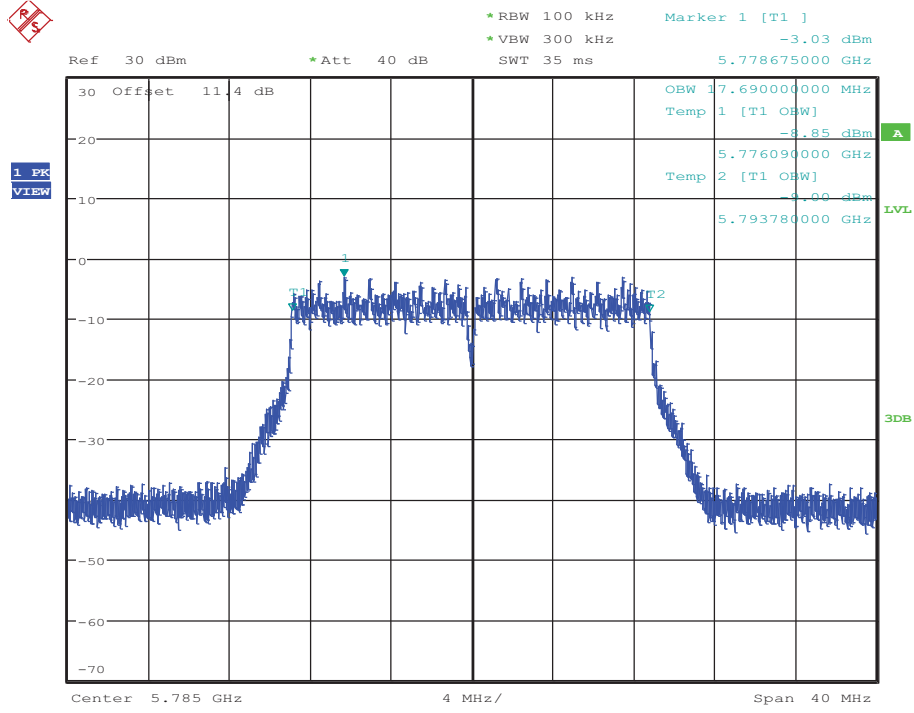

Date: 16.OCT.2017 19:12:24

### Occupied Bandwidth Measurement\_11N20MIMO\_5785\_Ant2

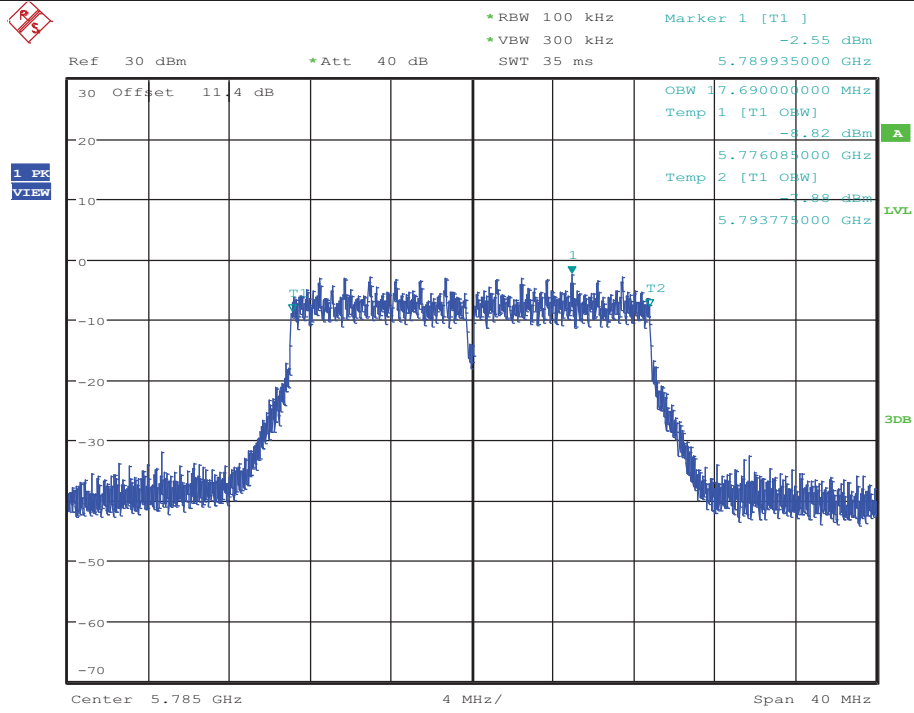

Date: 16.OCT.2017 19:15:51

### Occupied Bandwidth Measurement\_11N20MIMO\_5825\_Ant1

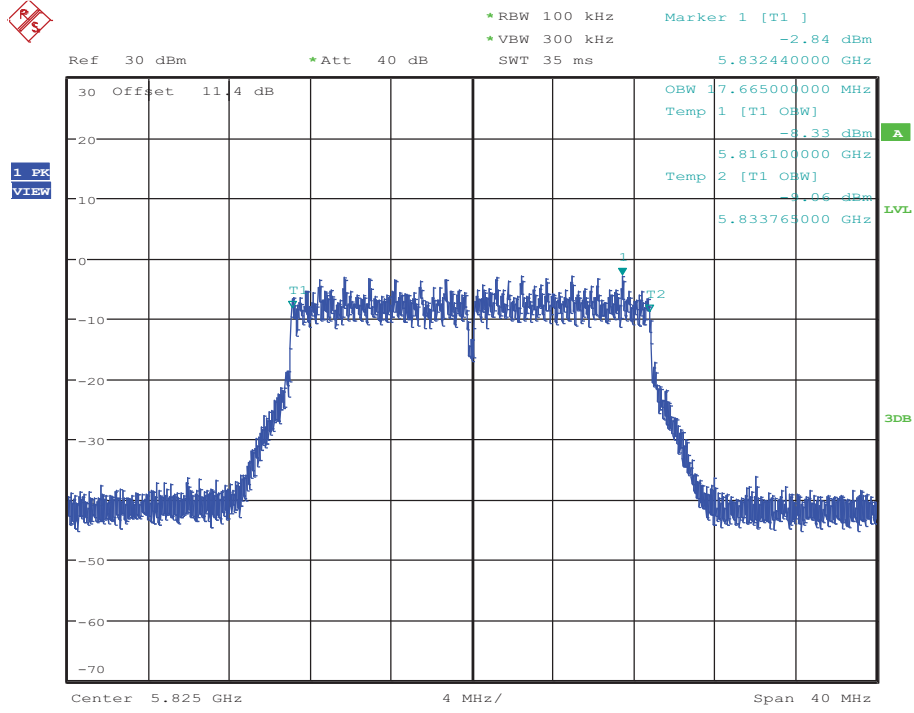

Date: 16.OCT.2017 19:20:00

### Occupied Bandwidth Measurement\_11N20MIMO\_5825\_Ant2

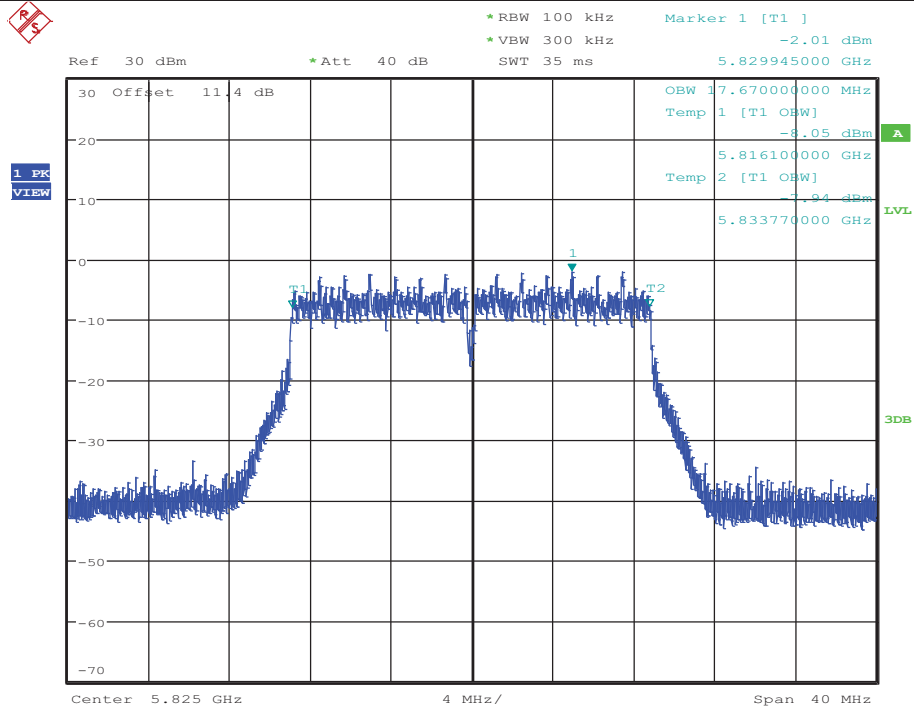

Date: 16.OCT.2017 19:23:50

### Occupied Bandwidth Measurement\_11N40MIMO\_5190\_Ant1

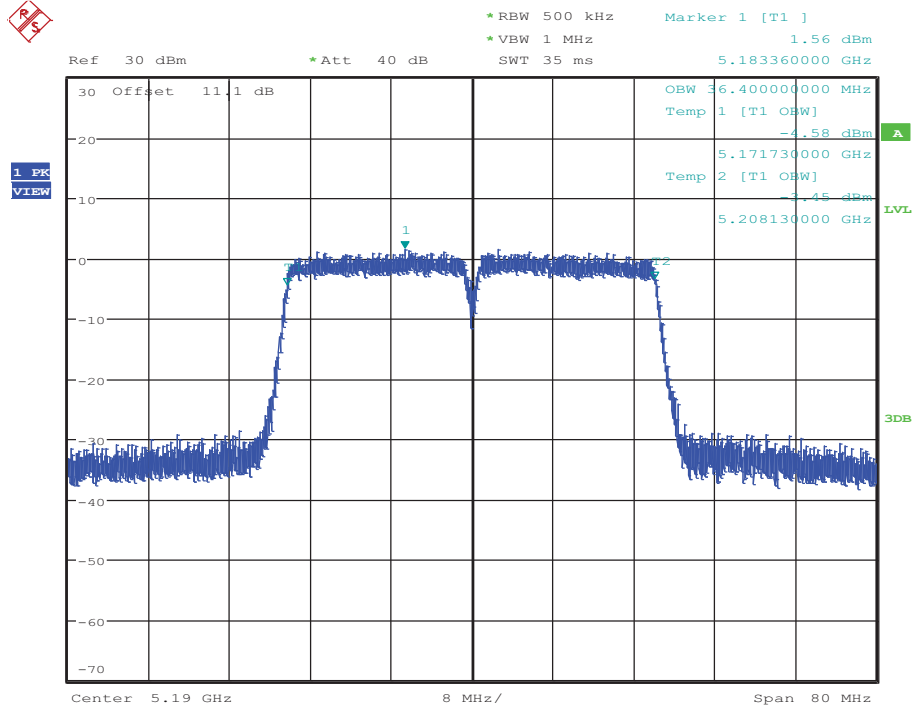

Date: 16.OCT.2017 19:29:20

### Occupied Bandwidth Measurement\_11N40MIMO\_5190\_Ant2

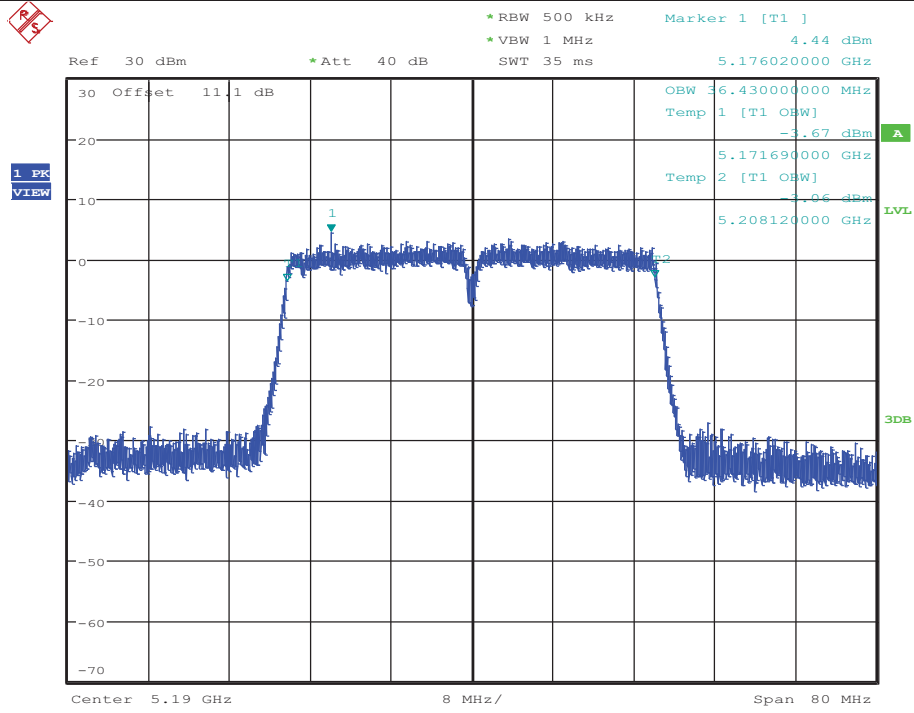

Date: 16.OCT.2017 19:33:36

### Occupied Bandwidth Measurement\_11N40MIMO\_5230\_Ant1

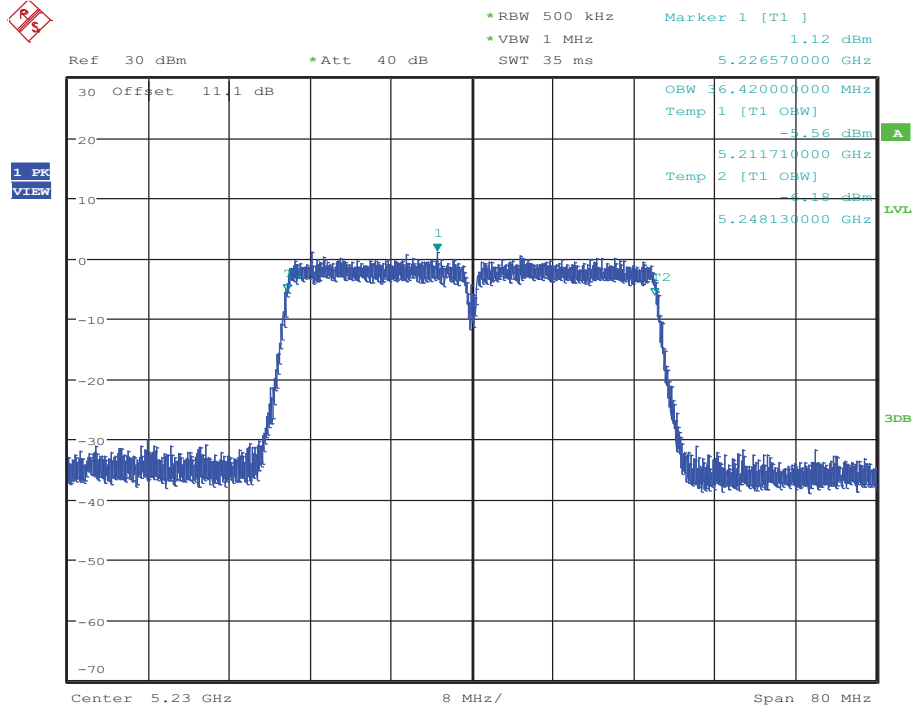

Date: 16.OCT.2017 19:43:28

### Occupied Bandwidth Measurement\_11N40MIMO\_5230\_Ant2

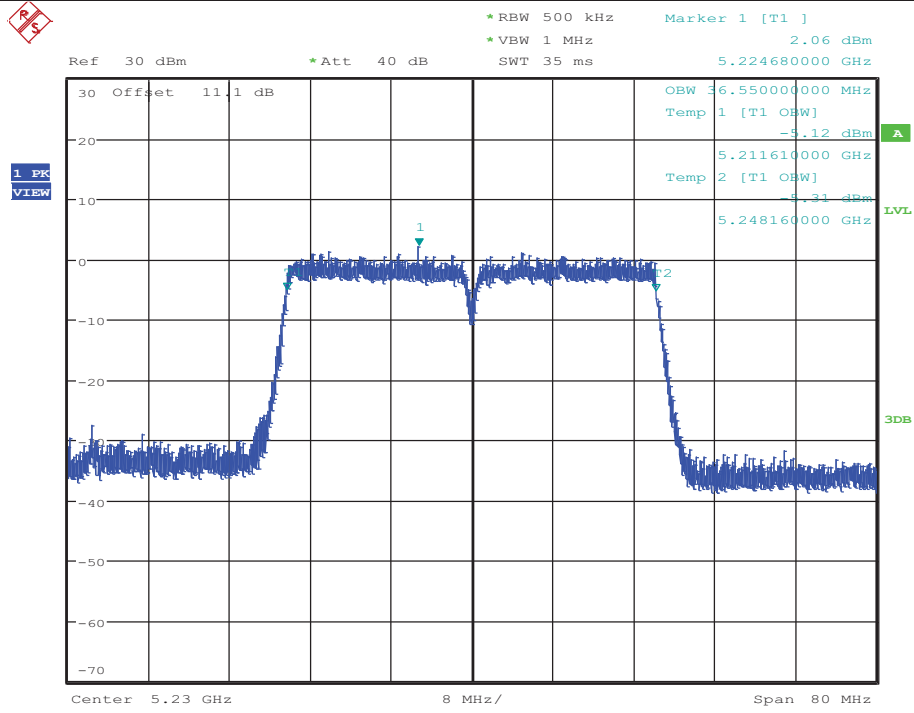

Date: 16.OCT.2017 19:47:44

### Occupied Bandwidth Measurement\_11N40MIMO\_5270\_Ant1

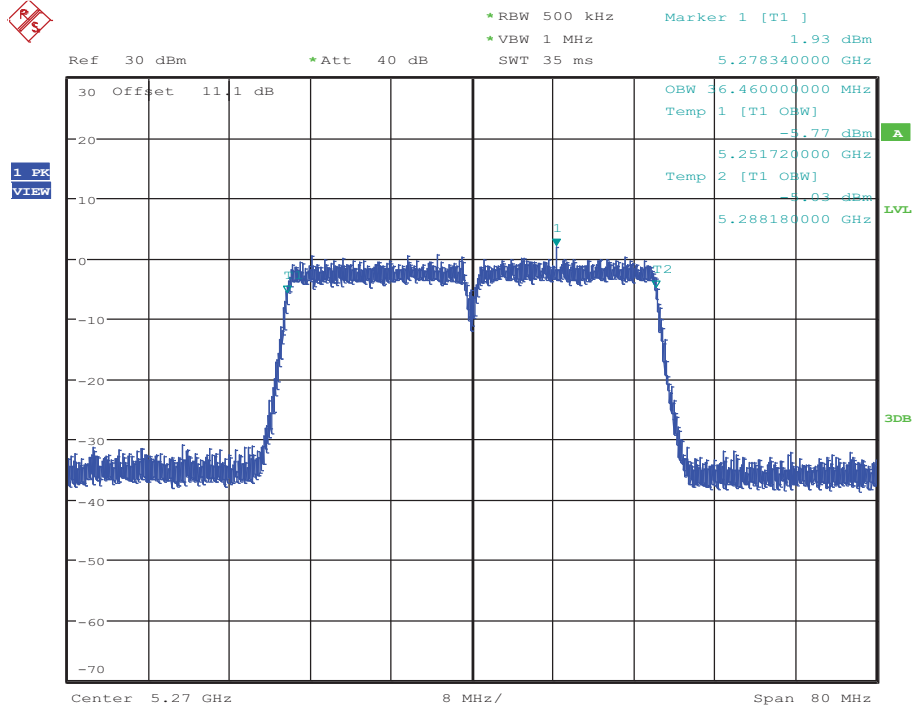

Date: 16.OCT.2017 19:54:48

### Occupied Bandwidth Measurement\_11N40MIMO\_5270\_Ant2

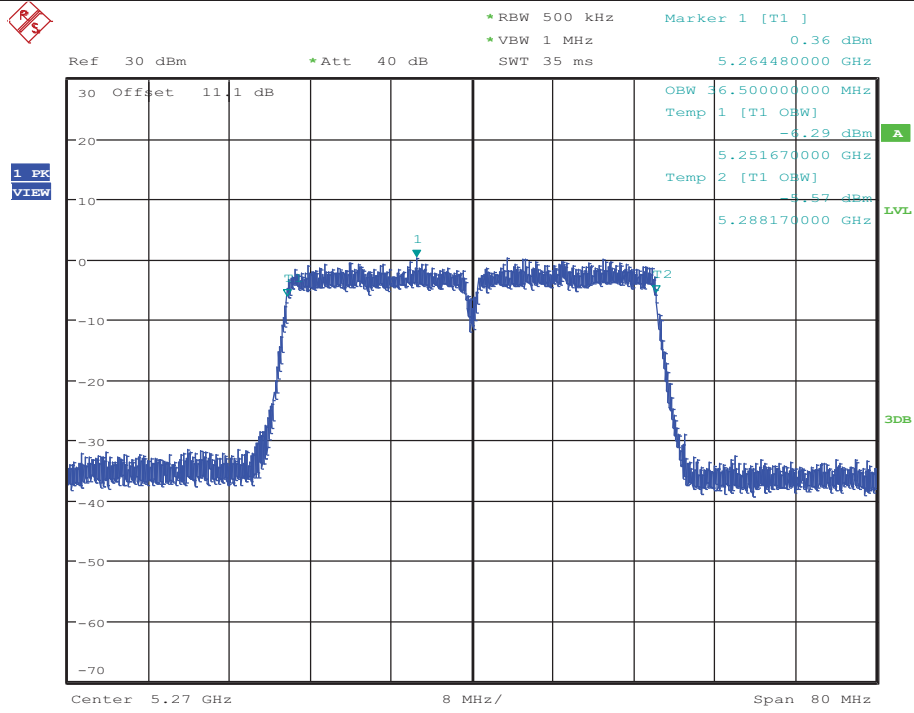

Date: 16.OCT.2017 19:59:05

### Occupied Bandwidth Measurement\_11N40MIMO\_5310\_Ant1

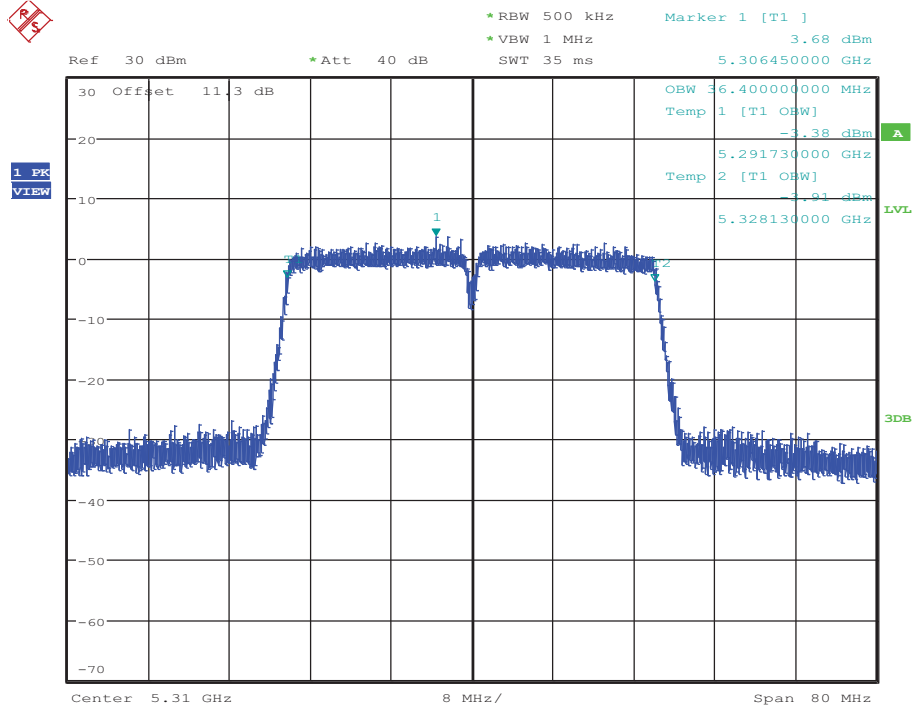

Date: 16.OCT.2017 20:04:12

### Occupied Bandwidth Measurement\_11N40MIMO\_5310\_Ant2

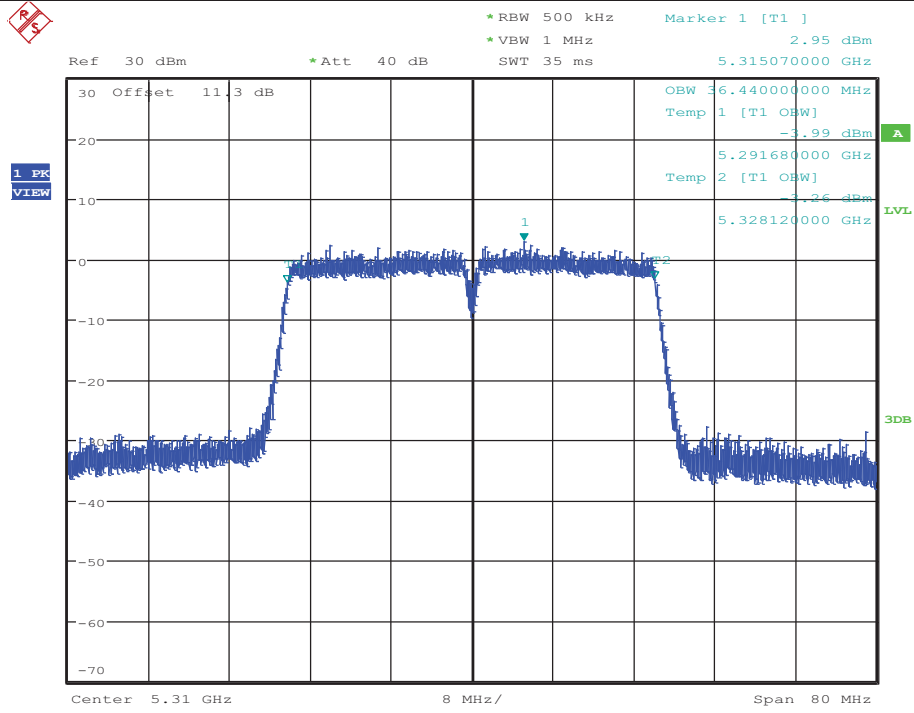

Date: 16.OCT.2017 20:08:28

### Occupied Bandwidth Measurement\_11N40MIMO\_5510\_Ant1

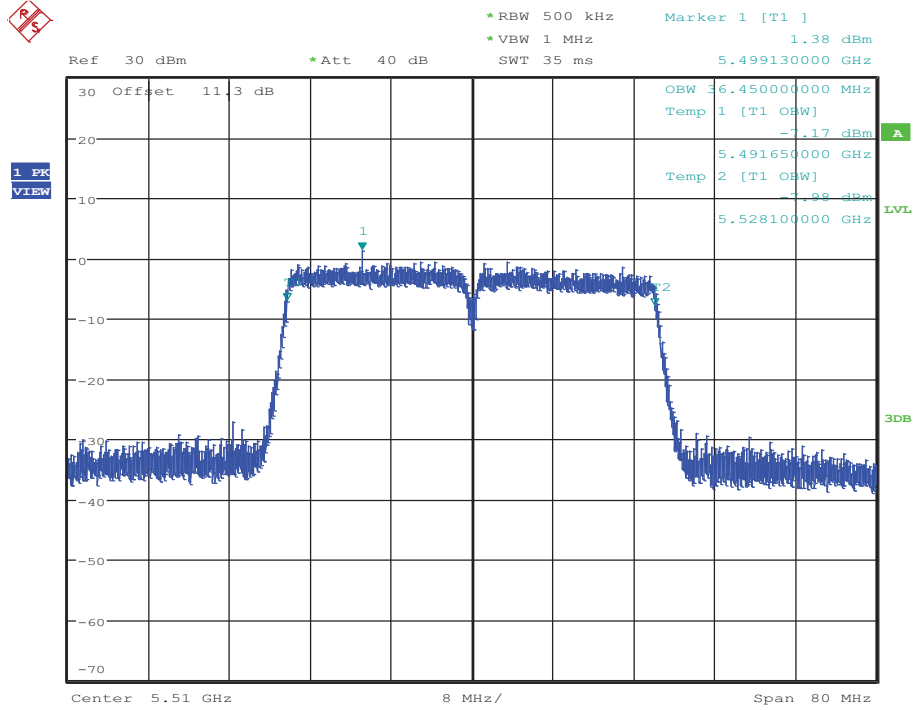

Date: 16.OCT.2017 20:13:30

### Occupied Bandwidth Measurement\_11N40MIMO\_5510\_Ant2

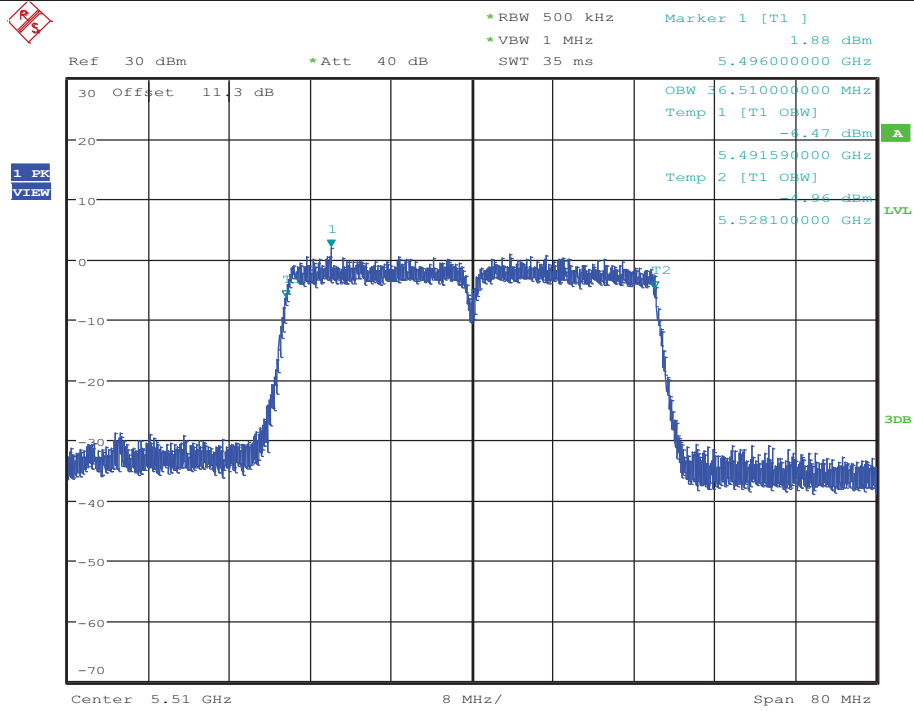

Date: 16.OCT.2017 20:19:54

### Occupied Bandwidth Measurement\_11N40MIMO\_5550\_Ant1

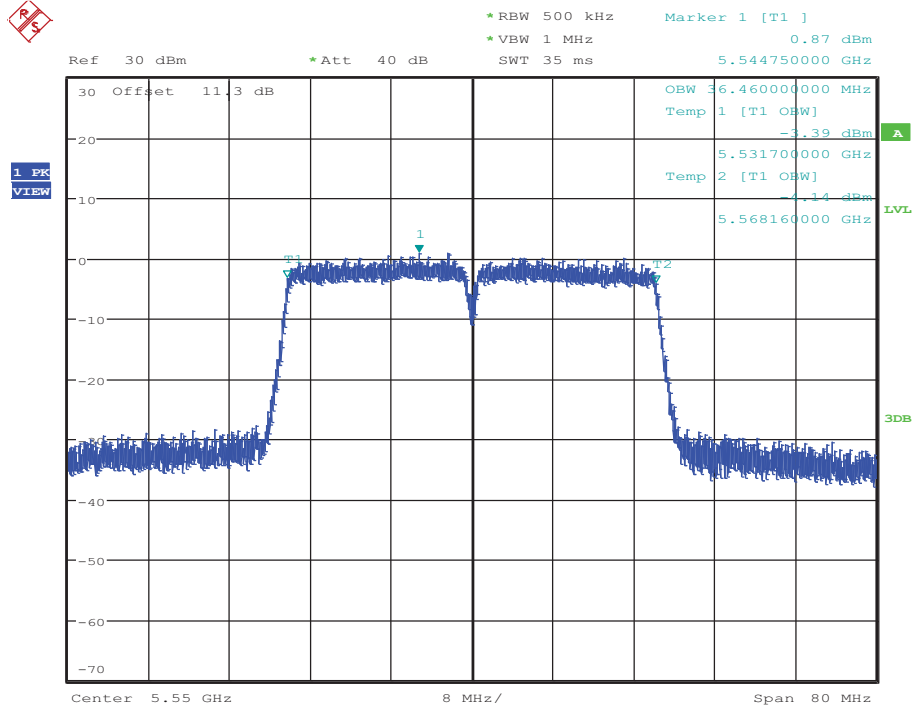

Date: 16.OCT.2017 20:30:29

### Occupied Bandwidth Measurement\_11N40MIMO\_5550\_Ant2

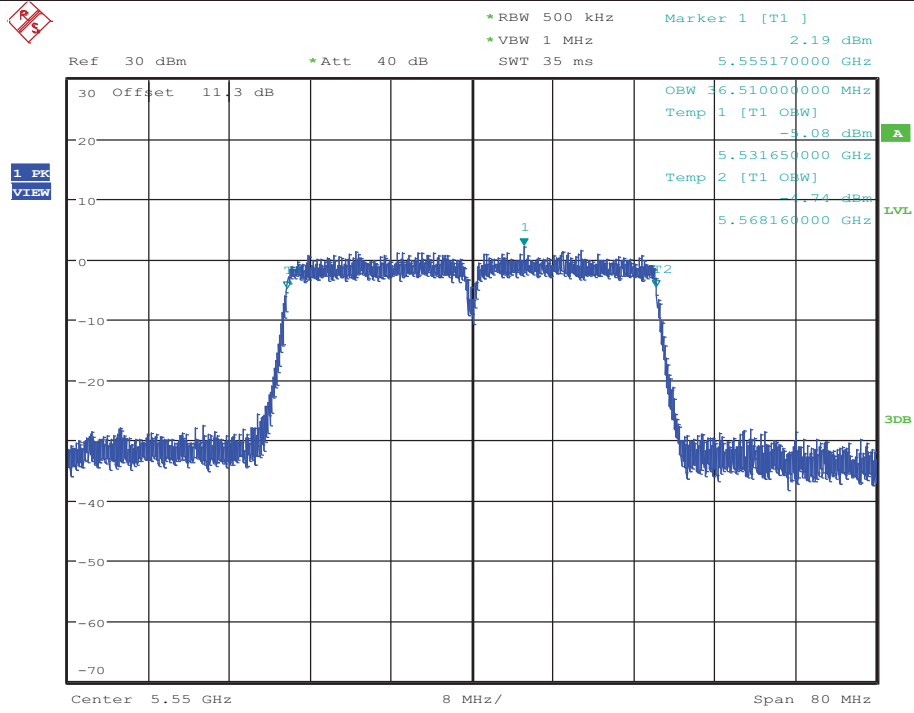

Date: 16.OCT.2017 20:34:20



### Occupied Bandwidth Measurement\_11N40MIMO\_5670\_Ant1

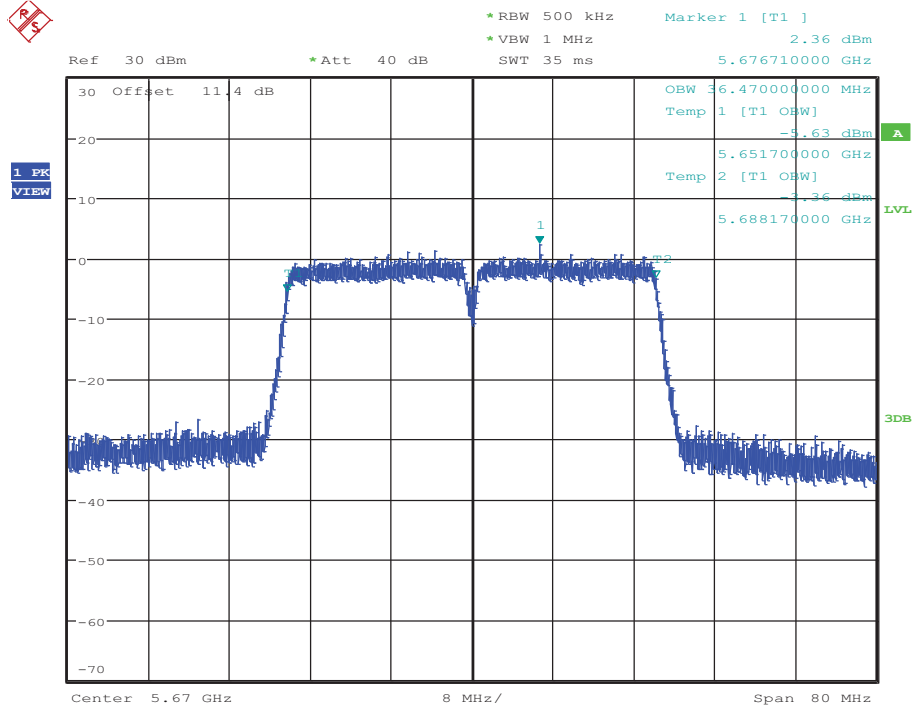

Date: 17.OCT.2017 08:52:44

### Occupied Bandwidth Measurement\_11N40MIMO\_5670\_Ant2

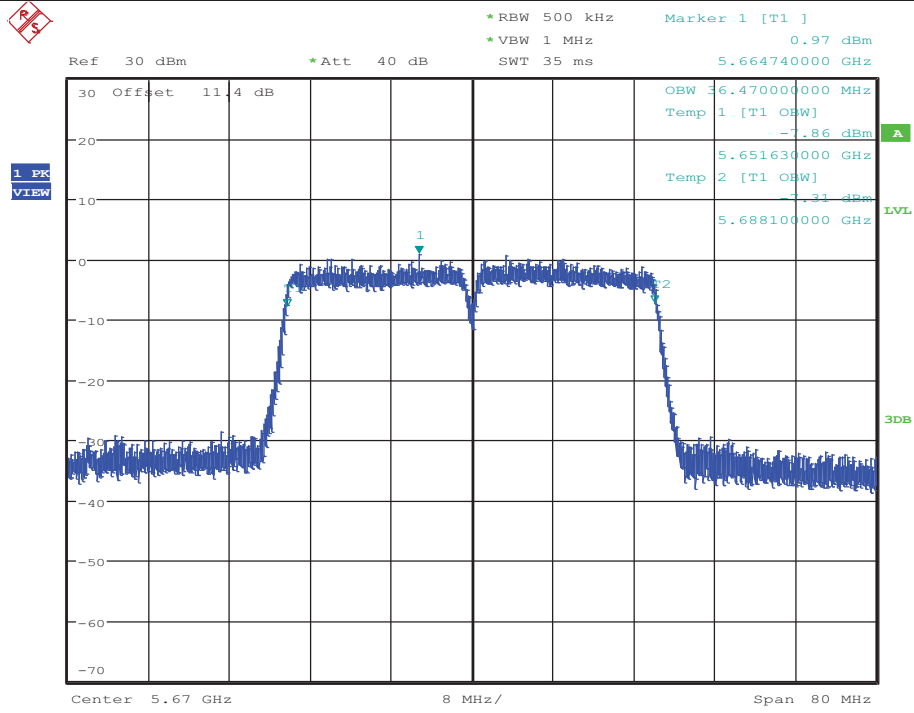

Date: 17.OCT.2017 11:43:48

### Occupied Bandwidth Measurement\_11N40MIMO\_5755\_Ant1

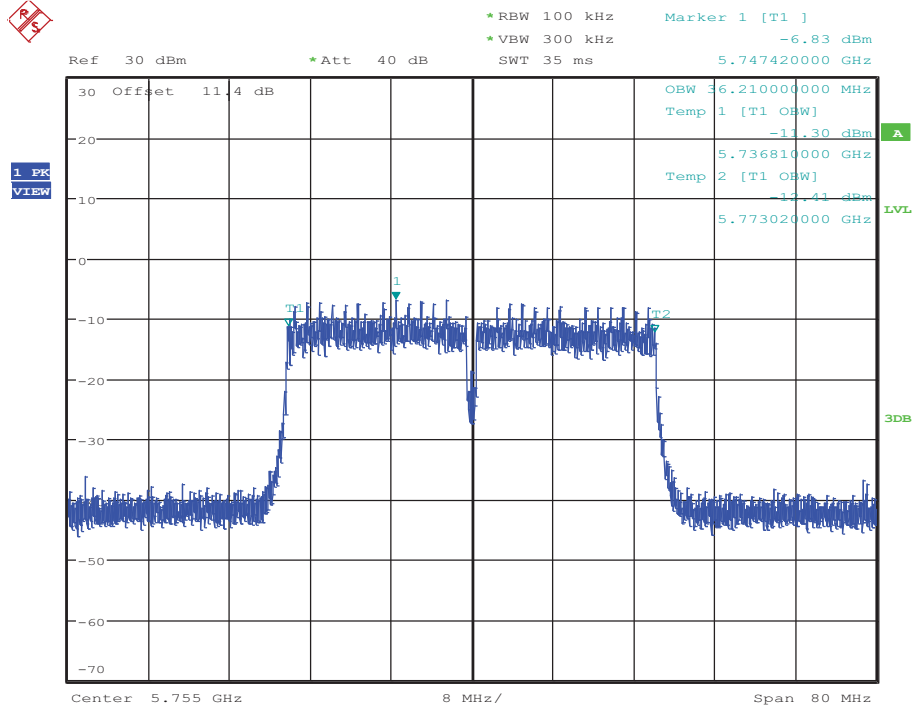

Date: 17.OCT.2017 08:58:19

### Occupied Bandwidth Measurement\_11N40MIMO\_5755\_Ant2

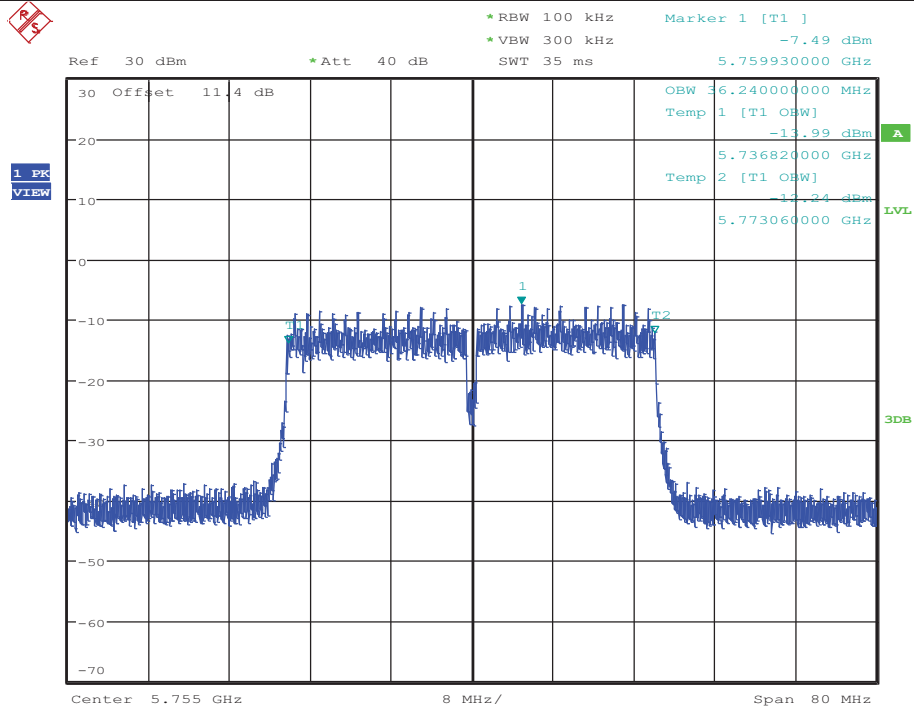

Date: 17.OCT.2017 11:53:53

### Occupied Bandwidth Measurement\_11N40MIMO\_5795\_Ant1

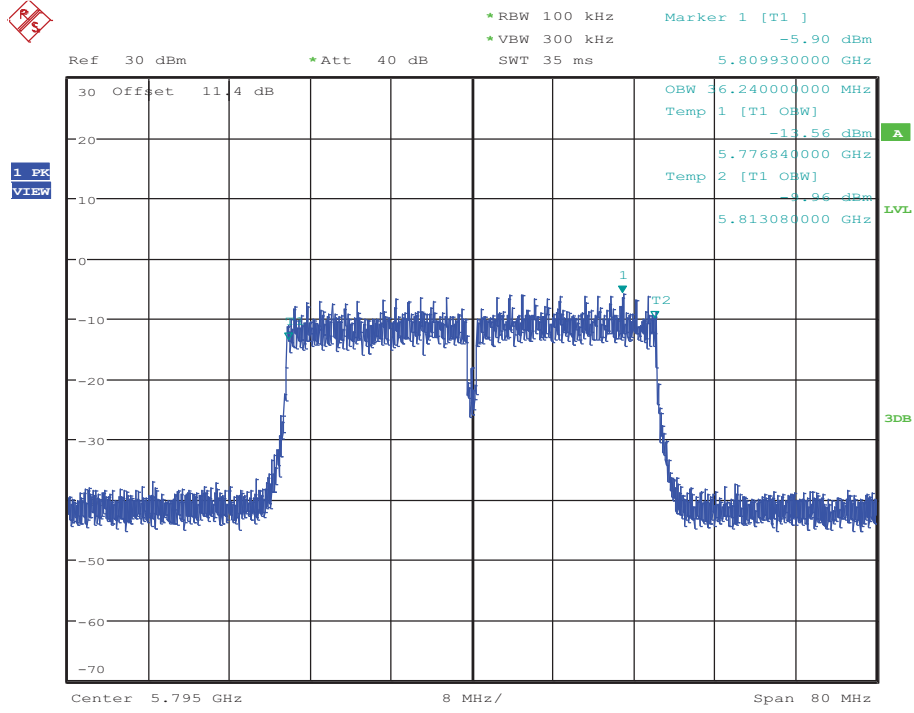

Date: 17.OCT.2017 09:03:42

### Occupied Bandwidth Measurement\_11N40MIMO\_5795\_Ant2

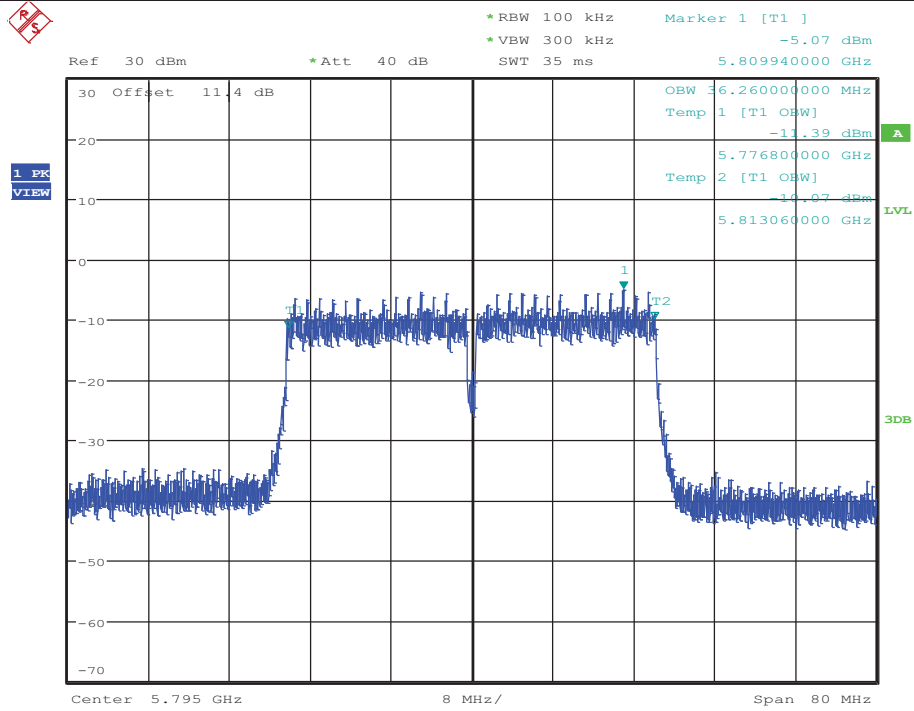

Date: 17.OCT.2017 13:33:31

### Occupied Bandwidth Measurement\_11AC20MIMO\_5180\_Ant1

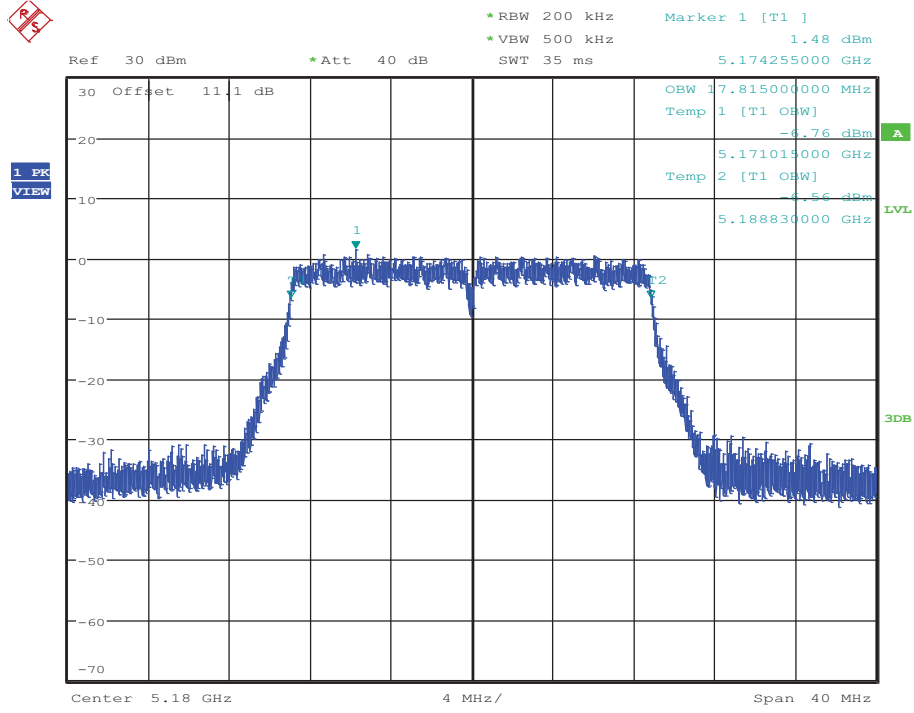

Date: 17.OCT.2017 09:10:10

### Occupied Bandwidth Measurement\_11AC20MIMO\_5180\_Ant2

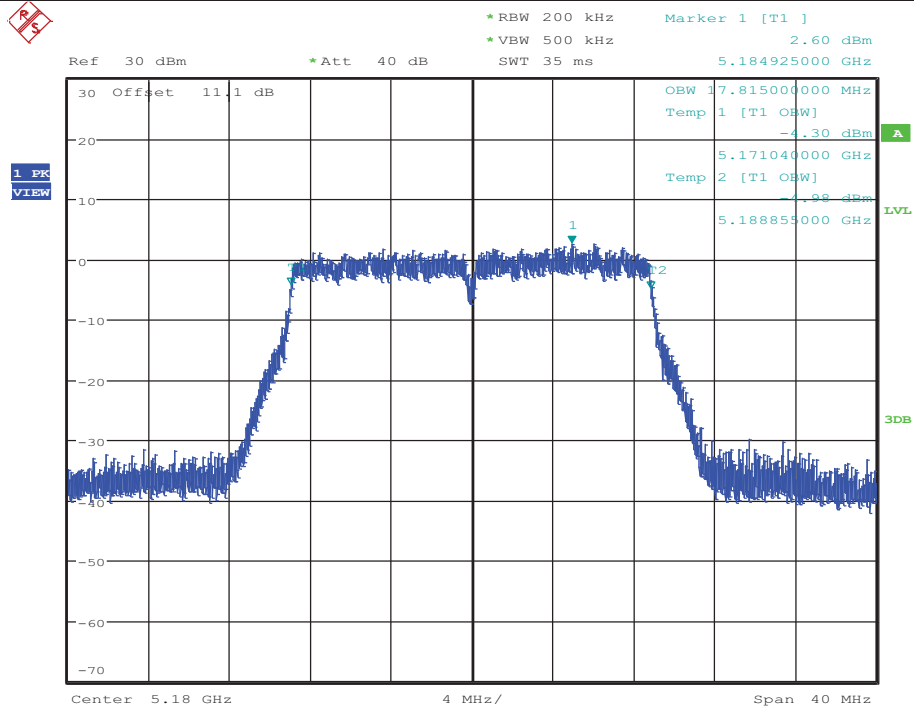

Date: 17.OCT.2017 14:22:19

### Occupied Bandwidth Measurement\_11AC20MIMO\_5200\_Ant1

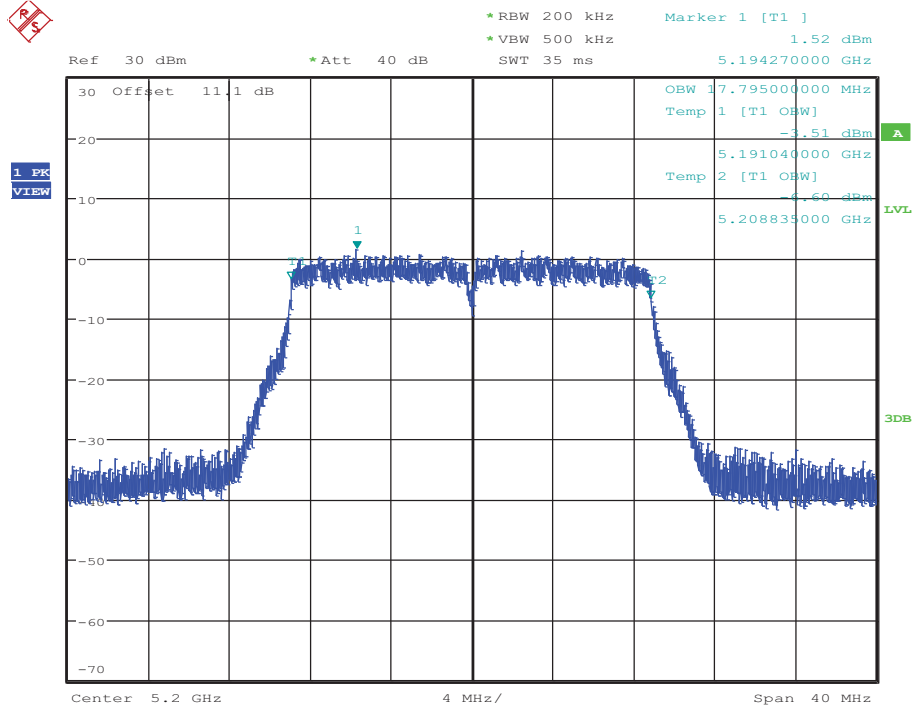

Date: 17.OCT.2017 09:18:13

### Occupied Bandwidth Measurement\_11AC20MIMO\_5200\_Ant2

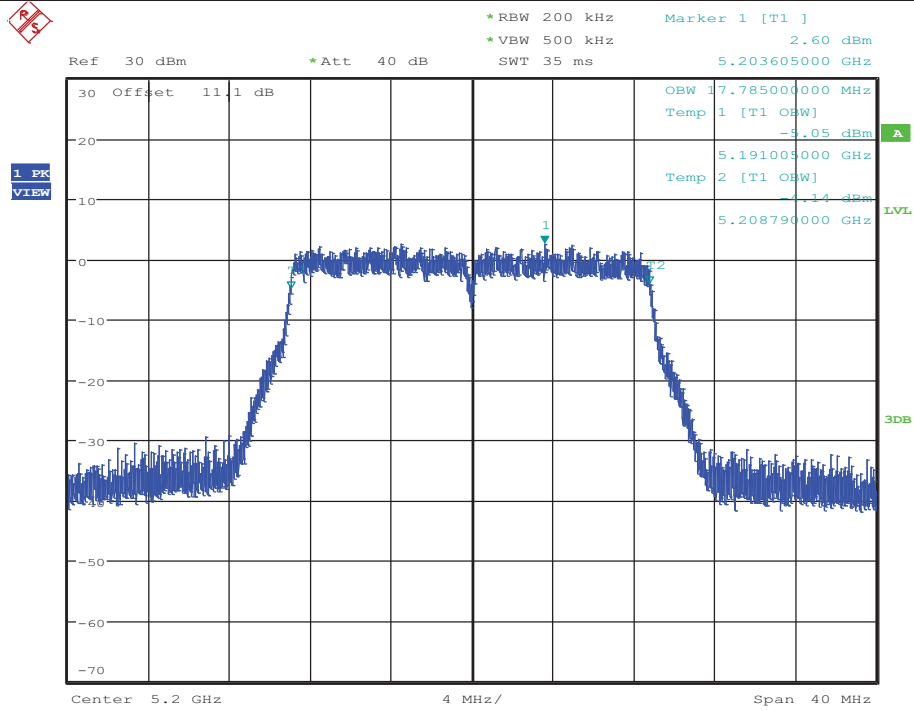

Date: 17.OCT.2017 14:27:35

### Occupied Bandwidth Measurement\_11AC20MIMO\_5240\_Ant1

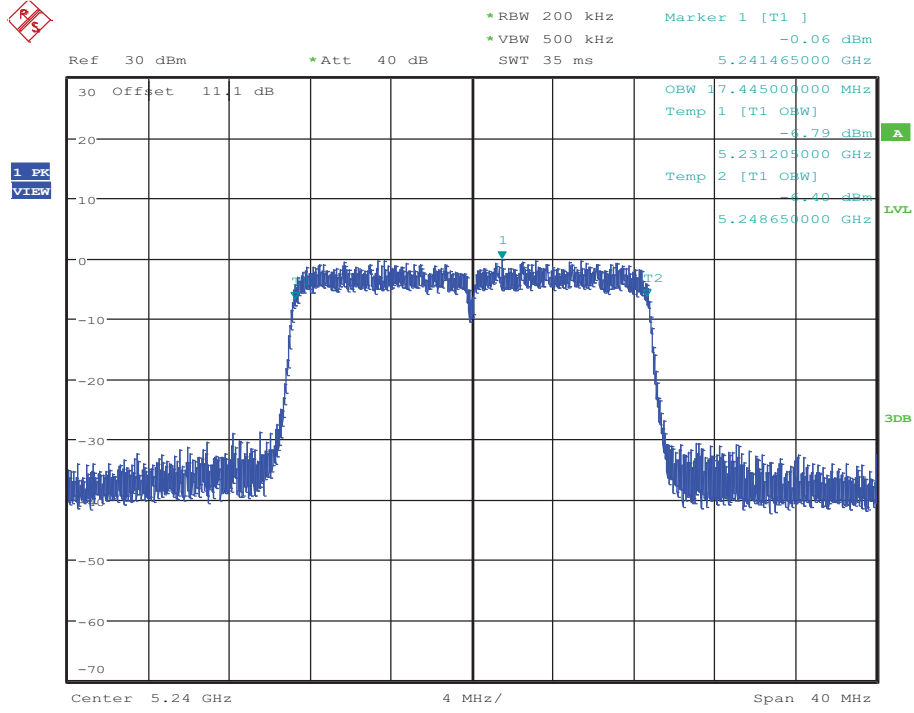

Date: 17.OCT.2017 09:22:55

### Occupied Bandwidth Measurement\_11AC20MIMO\_5240\_Ant2

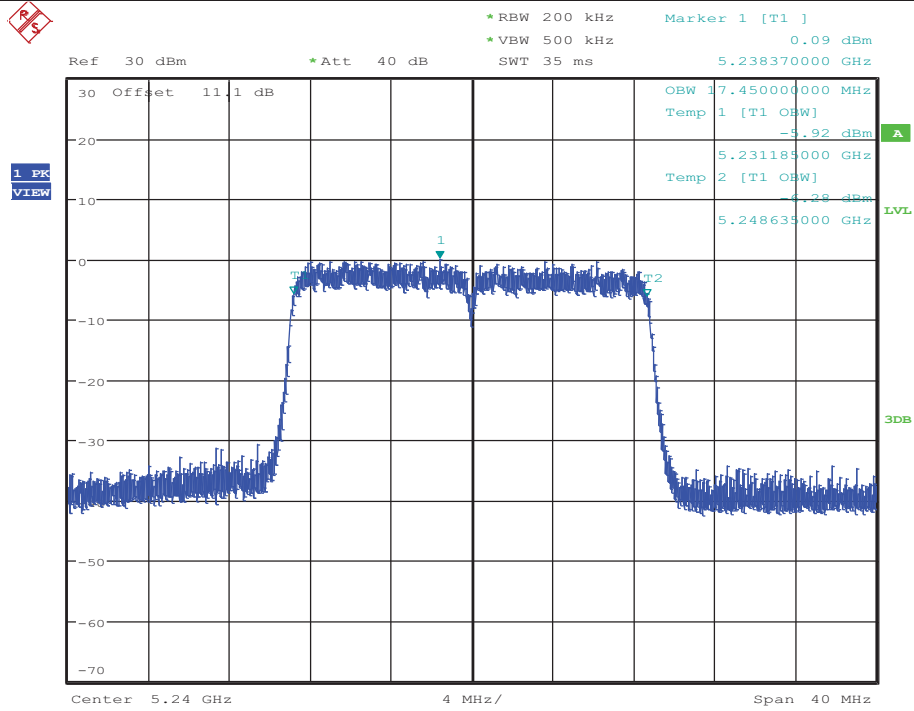

Date: 17.OCT.2017 14:32:19

### Occupied Bandwidth Measurement\_11AC20MIMO\_5260\_Ant1

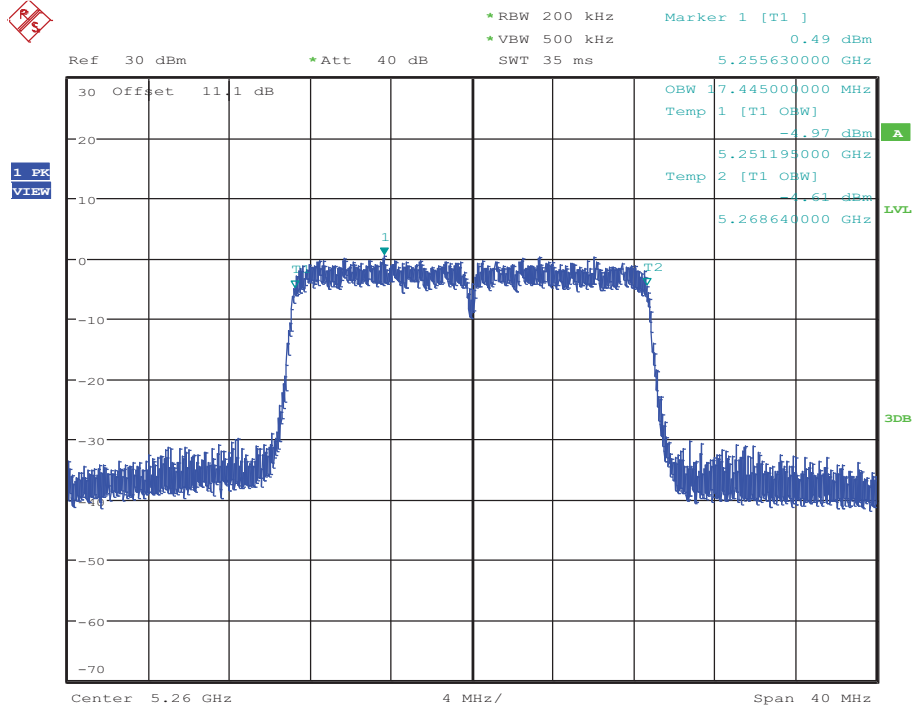

Date: 17.OCT.2017 09:28:03

### Occupied Bandwidth Measurement\_11AC20MIMO\_5260\_Ant2

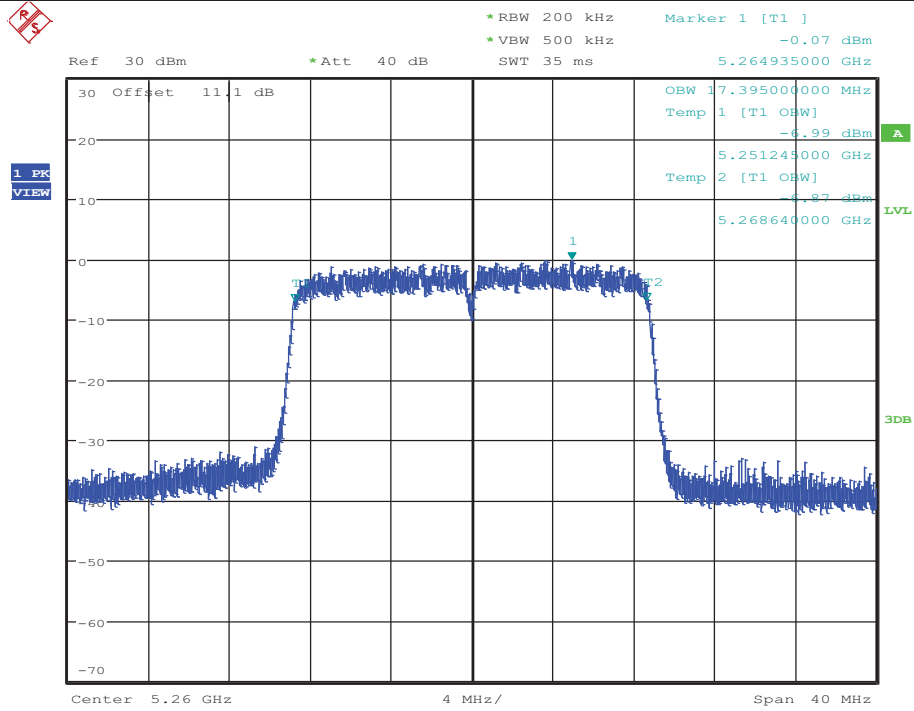

Date: 17.OCT.2017 14:37:27

### Occupied Bandwidth Measurement\_11AC20MIMO\_5280\_Ant1

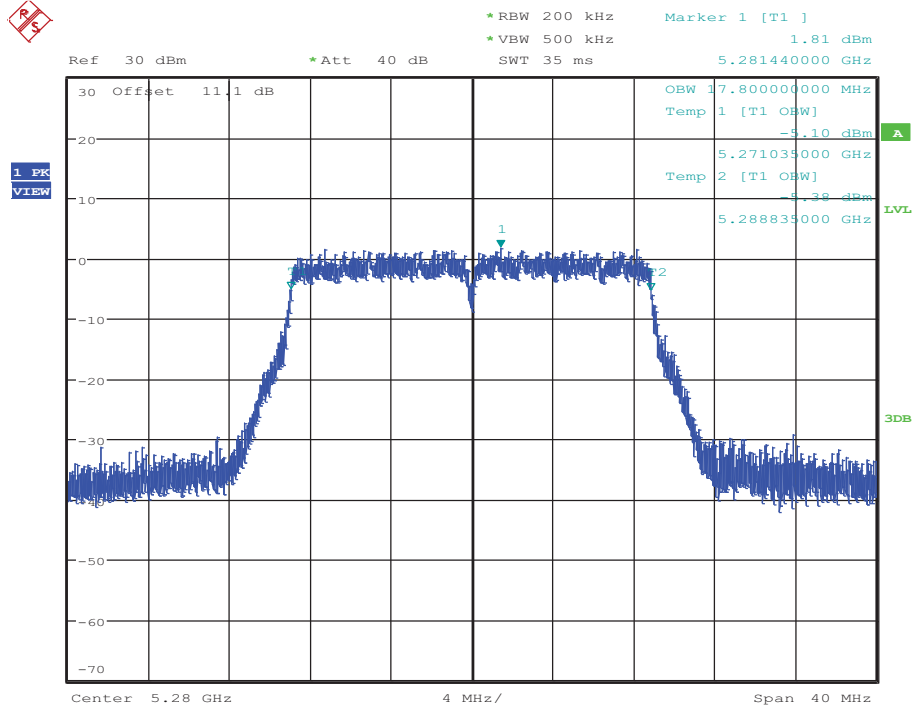

Date: 17.OCT.2017 09:33:20

### Occupied Bandwidth Measurement\_11AC20MIMO\_5280\_Ant2

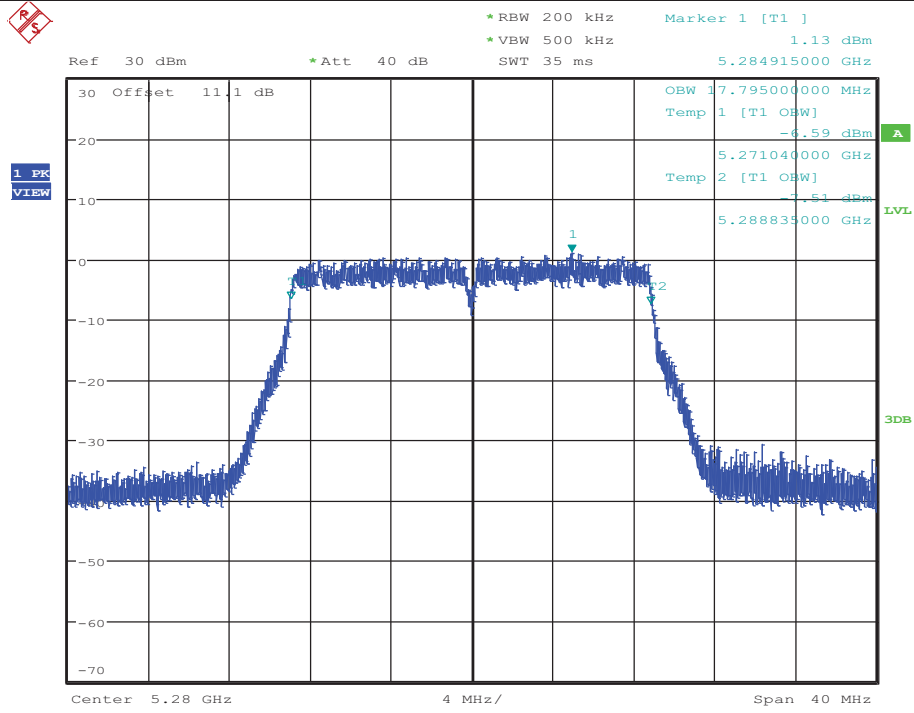

Date: 17.OCT.2017 14:42:40



### Occupied Bandwidth Measurement\_11AC20MIMO\_5320\_Ant1

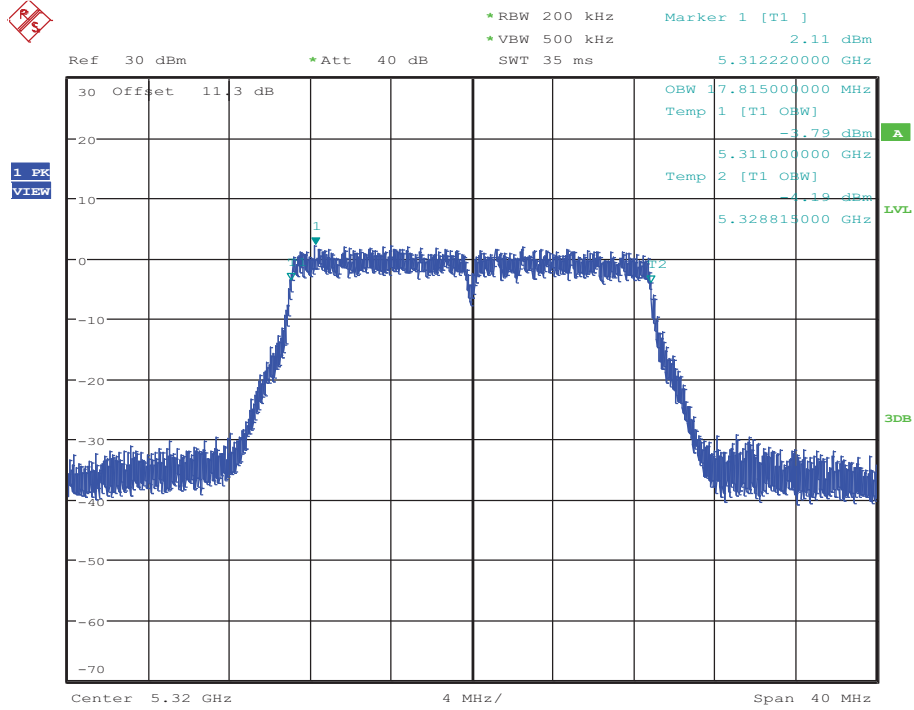

Date: 17.OCT.2017 09:38:26

### Occupied Bandwidth Measurement\_11AC20MIMO\_5320\_Ant2

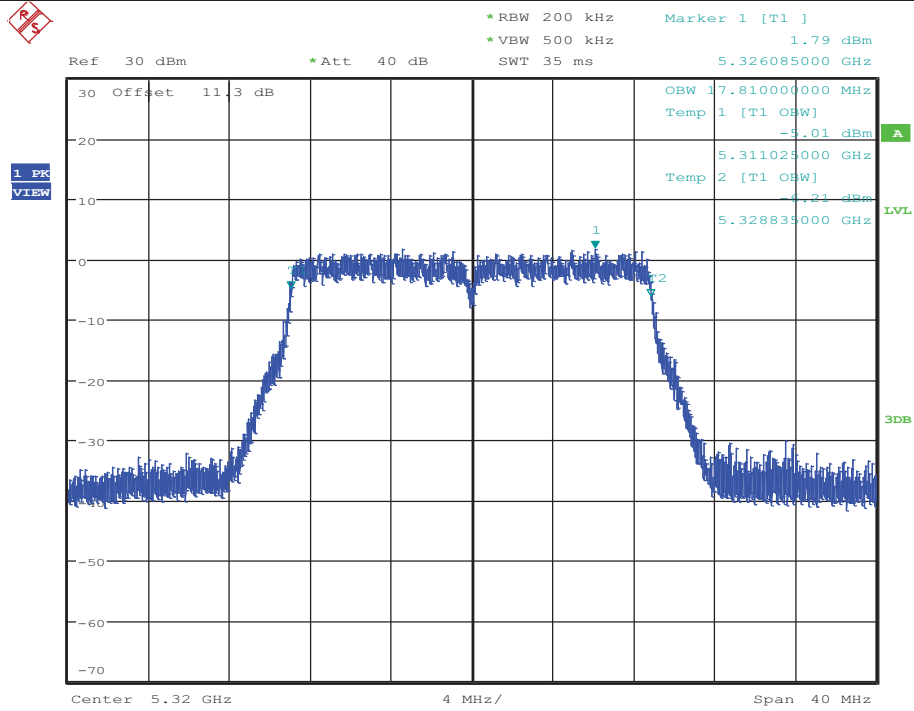

Date: 17.OCT.2017 14:47:29

### Occupied Bandwidth Measurement\_11AC20MIMO\_5500\_Ant1

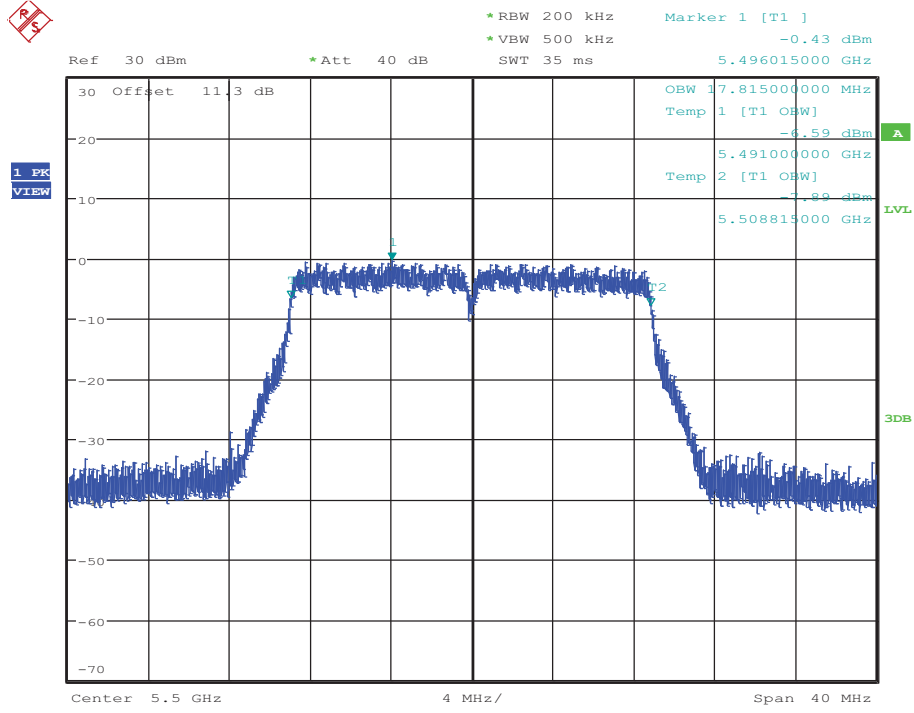

Date: 17.OCT.2017 09:43:37

### Occupied Bandwidth Measurement\_11AC20MIMO\_5500\_Ant2

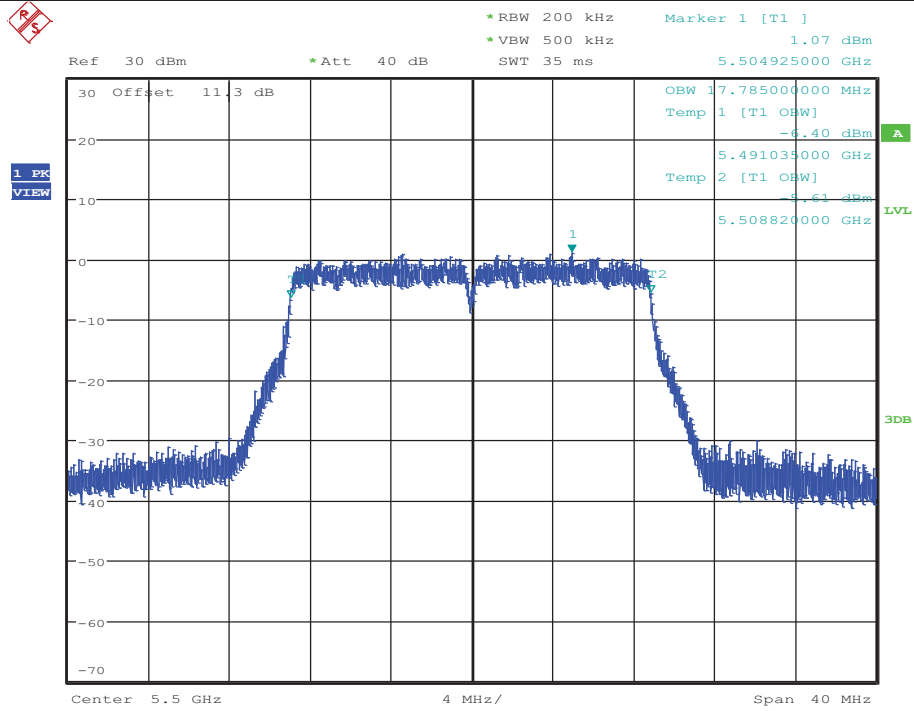

Date: 17.OCT.2017 14:52:48

### Occupied Bandwidth Measurement\_11AC20MIMO\_5580\_Ant1

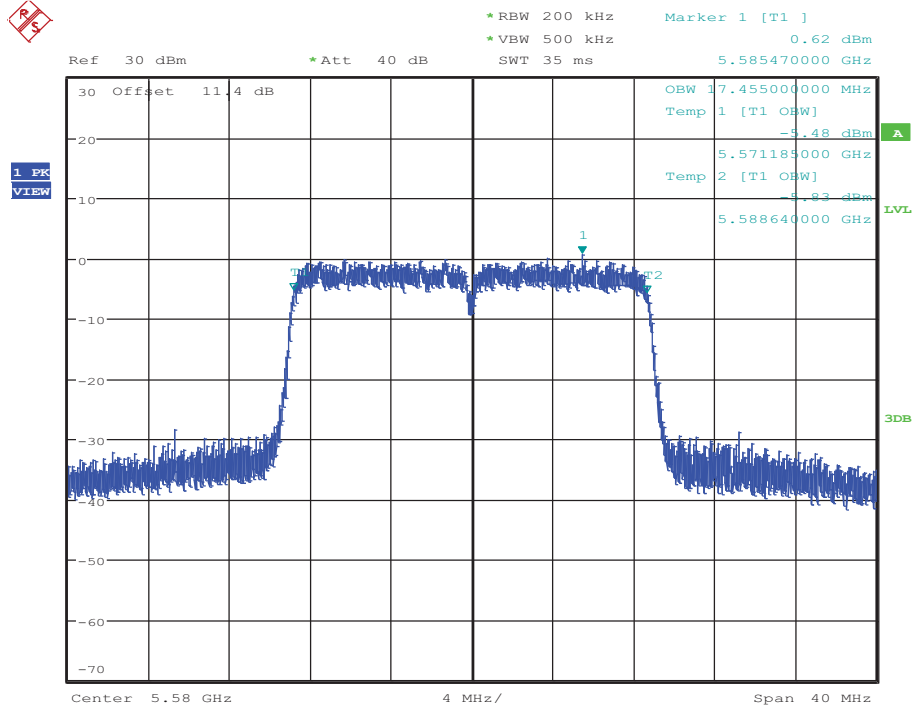

Date: 17.OCT.2017 09:49:49

### Occupied Bandwidth Measurement\_11AC20MIMO\_5580\_Ant2

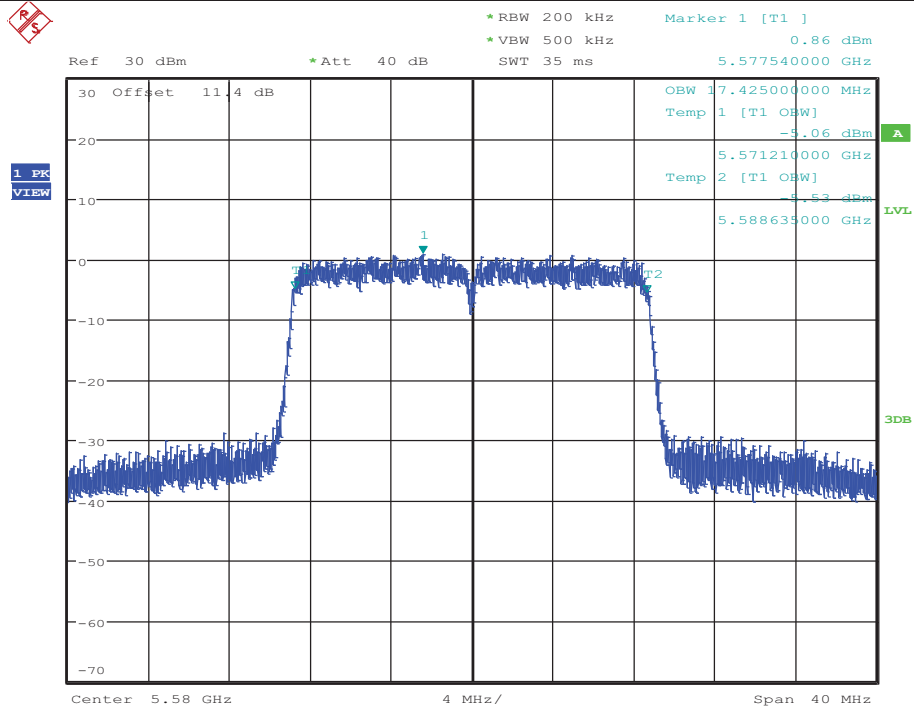

Date: 17.OCT.2017 14:58:03

### Occupied Bandwidth Measurement\_11AC20MIMO\_5700\_Ant1

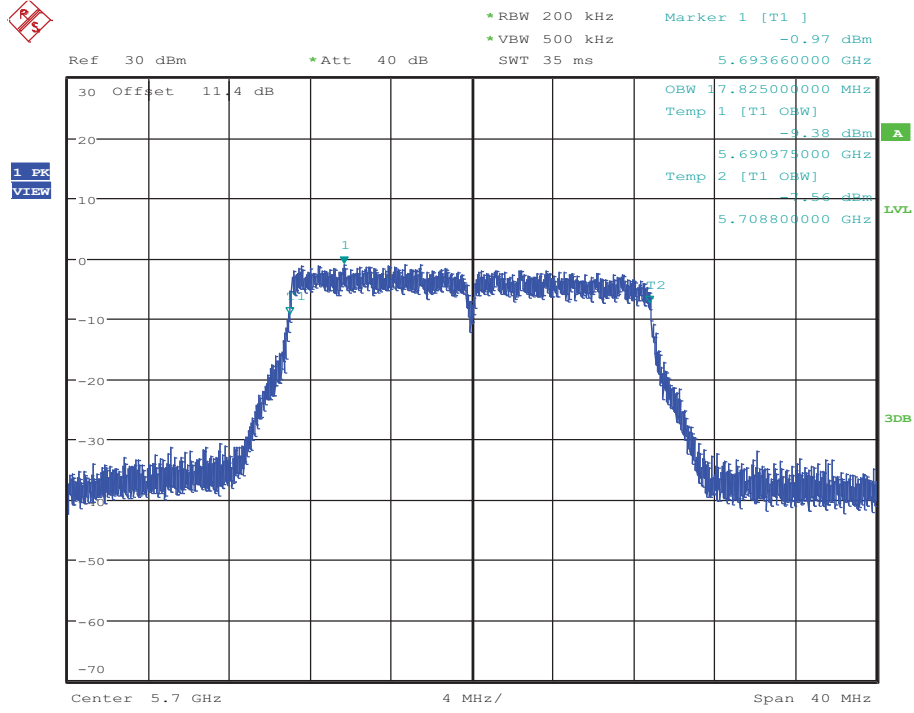

Date: 17.OCT.2017 09:54:49

### Occupied Bandwidth Measurement\_11AC20MIMO\_5700\_Ant2

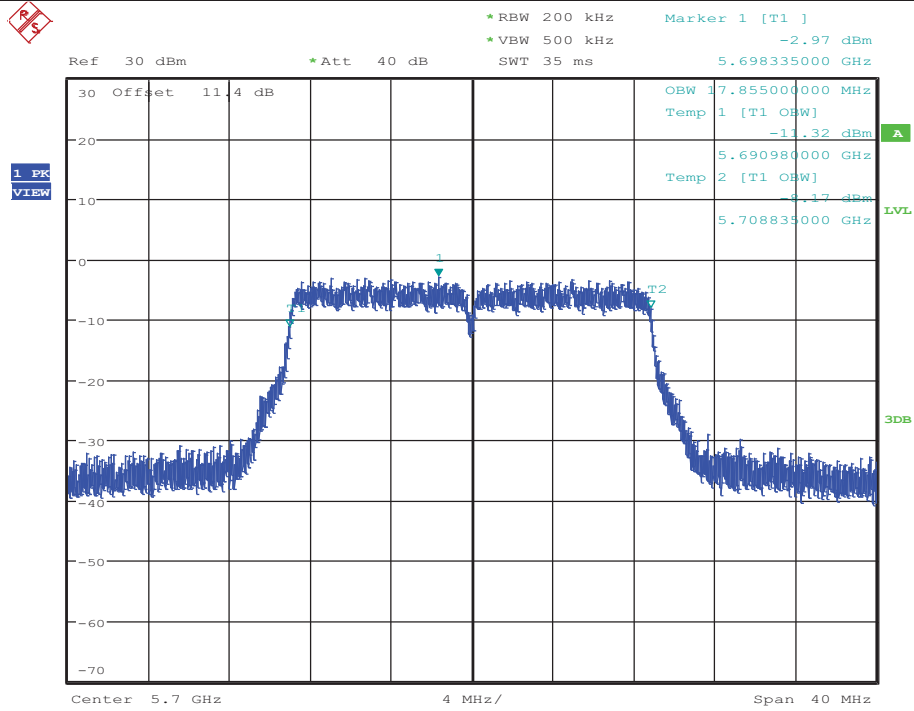

Date: 17.OCT.2017 15:02:59

Occupied Bandwidth Measurement\_11AC20MIMO\_5745\_Ant1

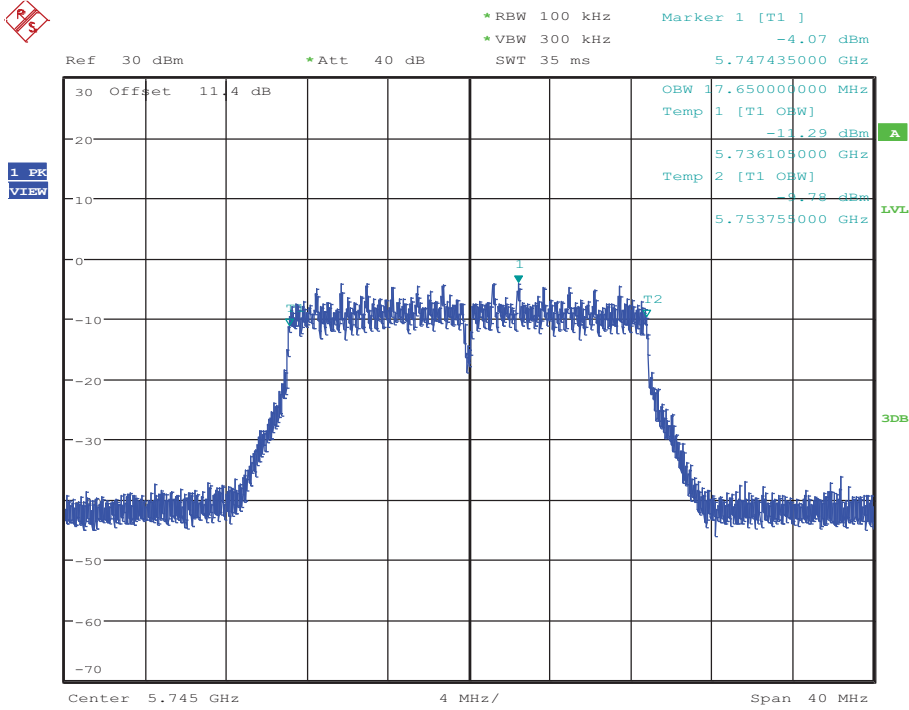

Date: 17.OCT.2017 10:04:35

Occupied Bandwidth Measurement\_11AC20MIMO\_5745\_Ant2

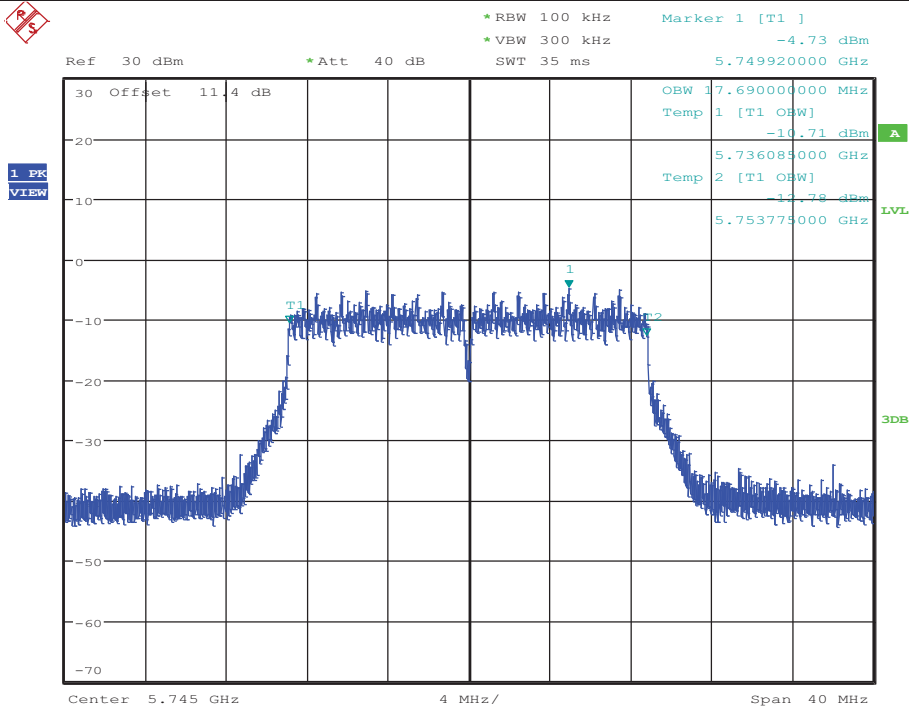

Date: 17.OCT.2017 15:07:49

### Occupied Bandwidth Measurement\_11AC20MIMO\_5785\_Ant1

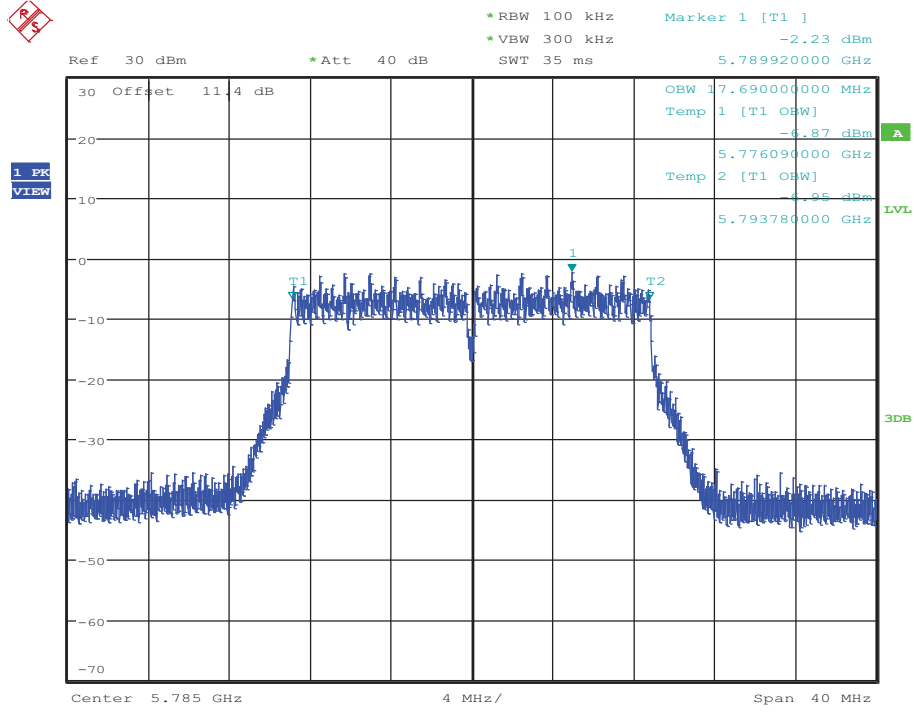

Date: 17.OCT.2017 10:10:21

### Occupied Bandwidth Measurement\_11AC20MIMO\_5785\_Ant2

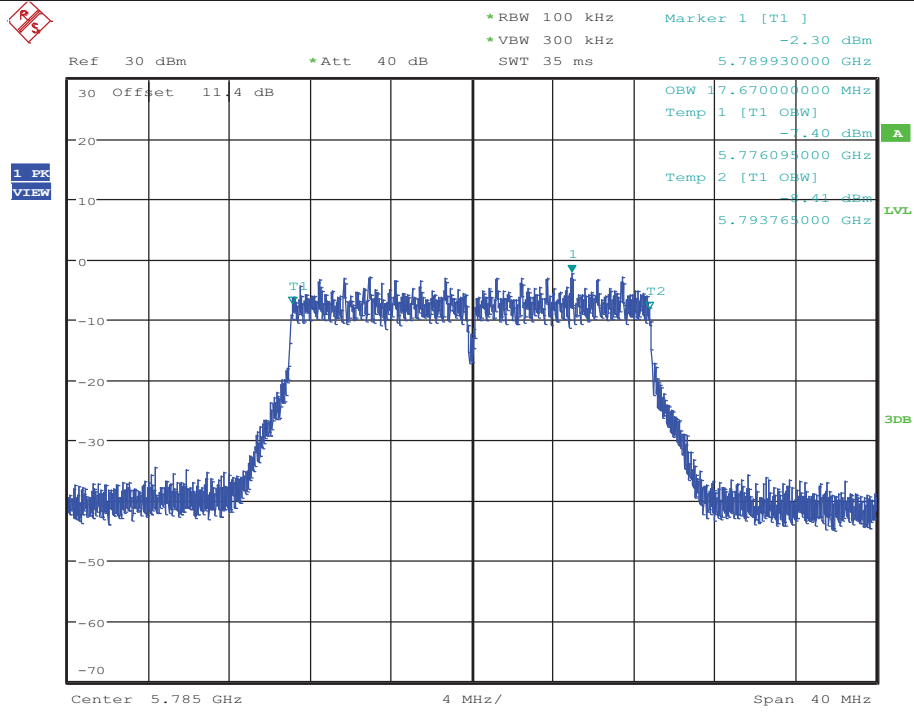

Date: 17.OCT.2017 15:12:02

### Occupied Bandwidth Measurement\_11AC20MIMO\_5825\_Ant1

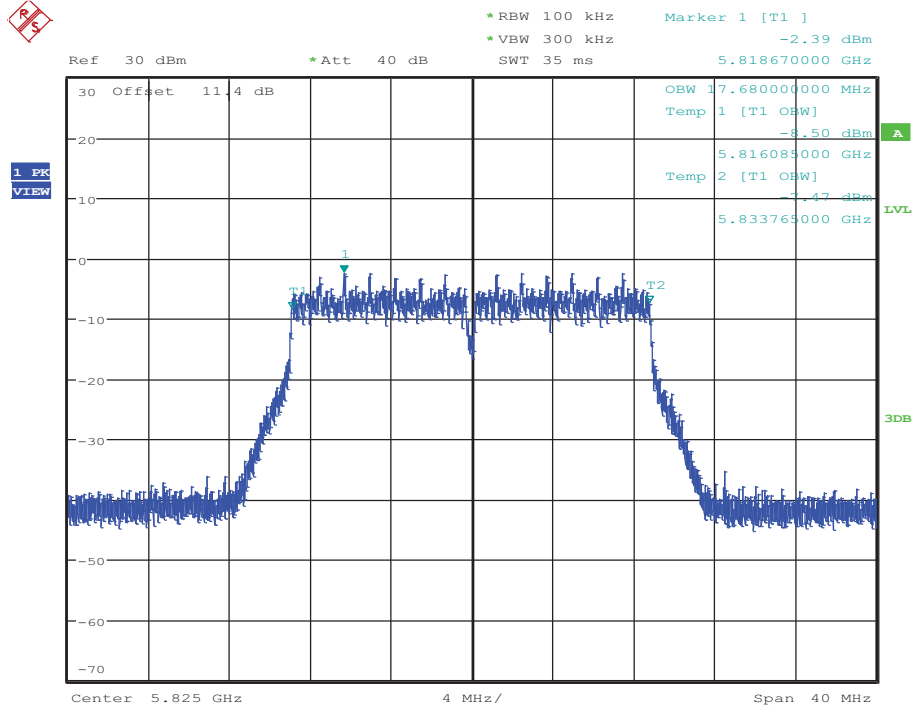

Date: 17.OCT.2017 10:14:05

### Occupied Bandwidth Measurement\_11AC20MIMO\_5825\_Ant2

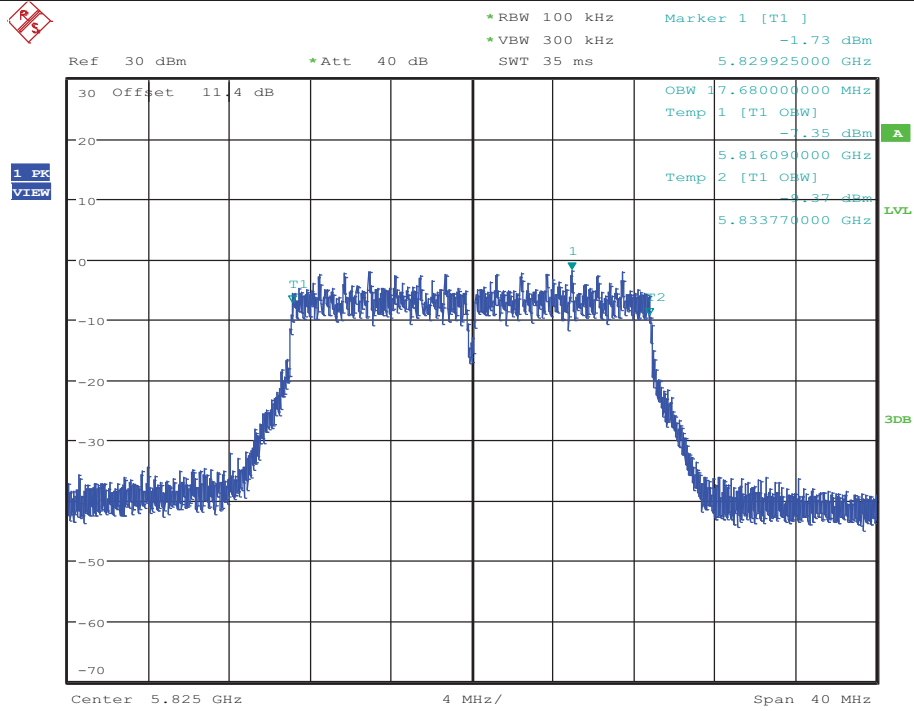

Date: 17.OCT.2017 15:15:55

### Occupied Bandwidth Measurement\_11AC40MIMO\_5190\_Ant1

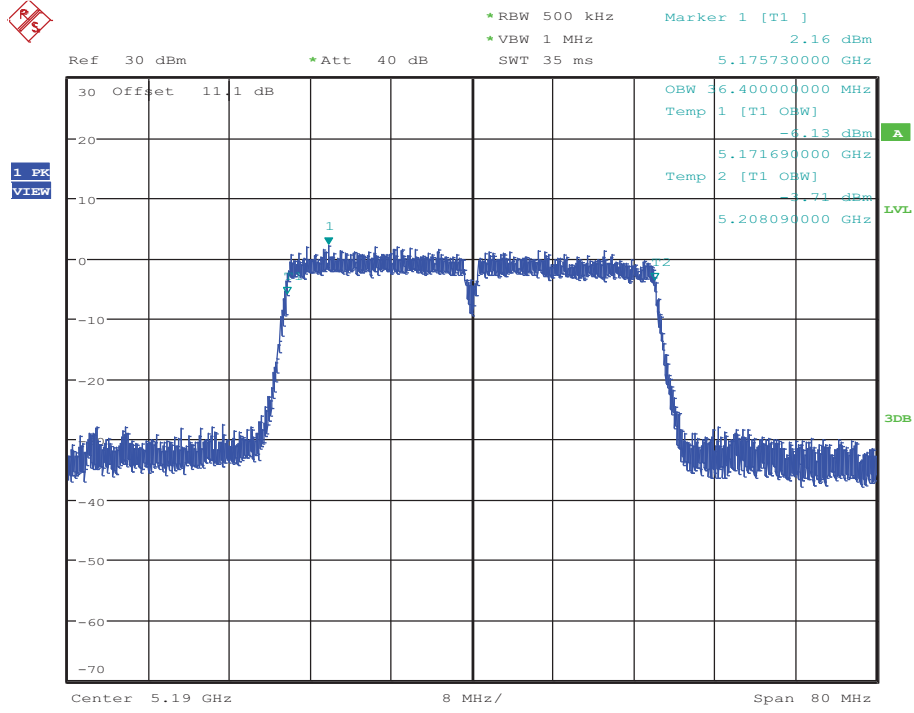

Date: 17.OCT.2017 10:22:25

### Occupied Bandwidth Measurement\_11AC40MIMO\_5190\_Ant2

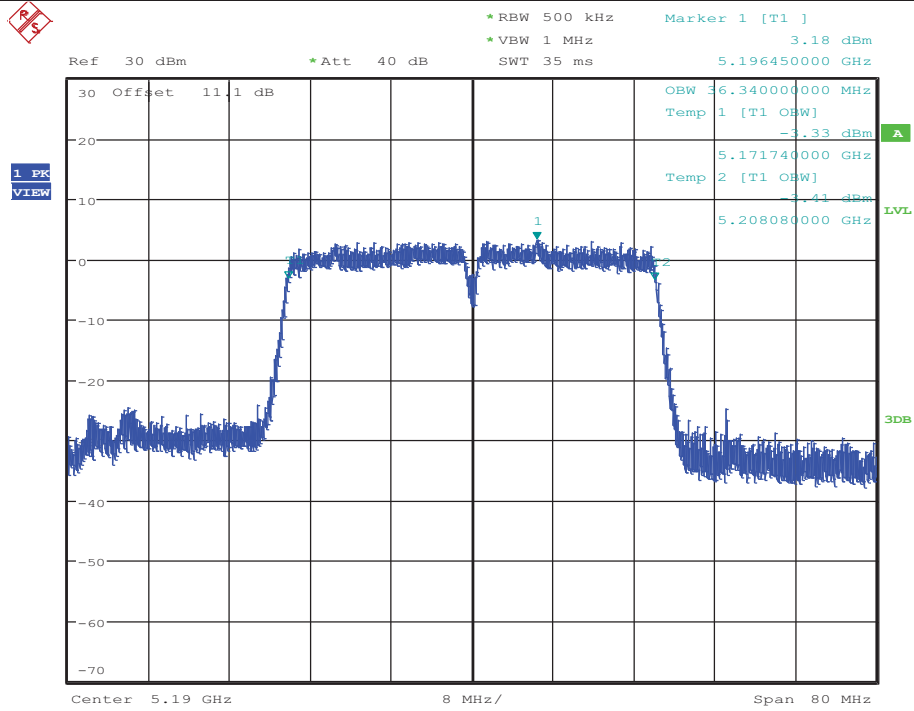

Date: 17.OCT.2017 15:20:18



### Occupied Bandwidth Measurement\_11AC40MIMO\_5230\_Ant1

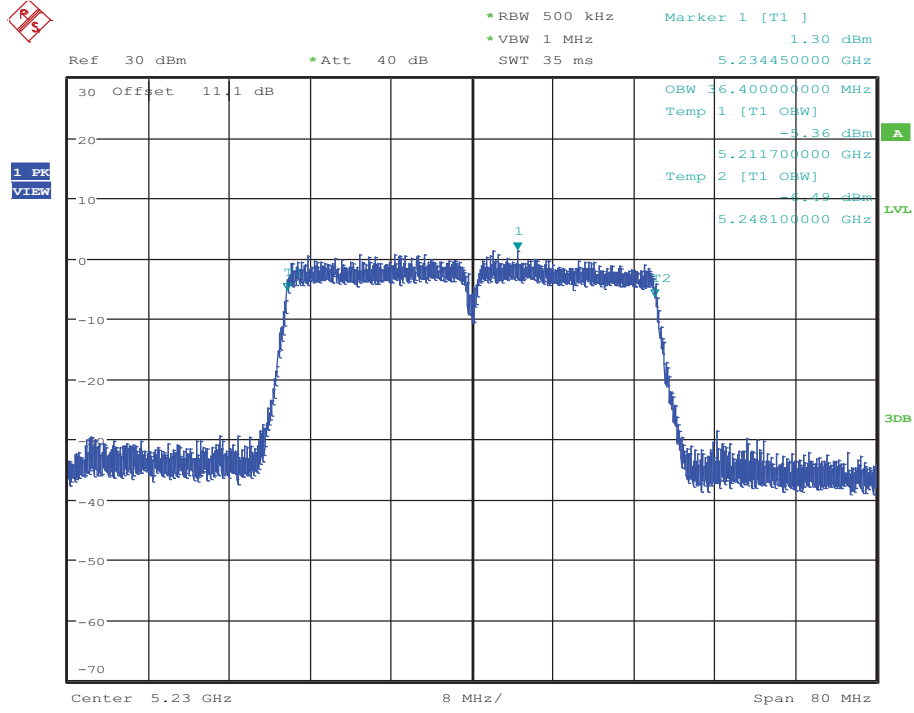

Date: 17.OCT.2017 10:27:14

### Occupied Bandwidth Measurement\_11AC40MIMO\_5230\_Ant2

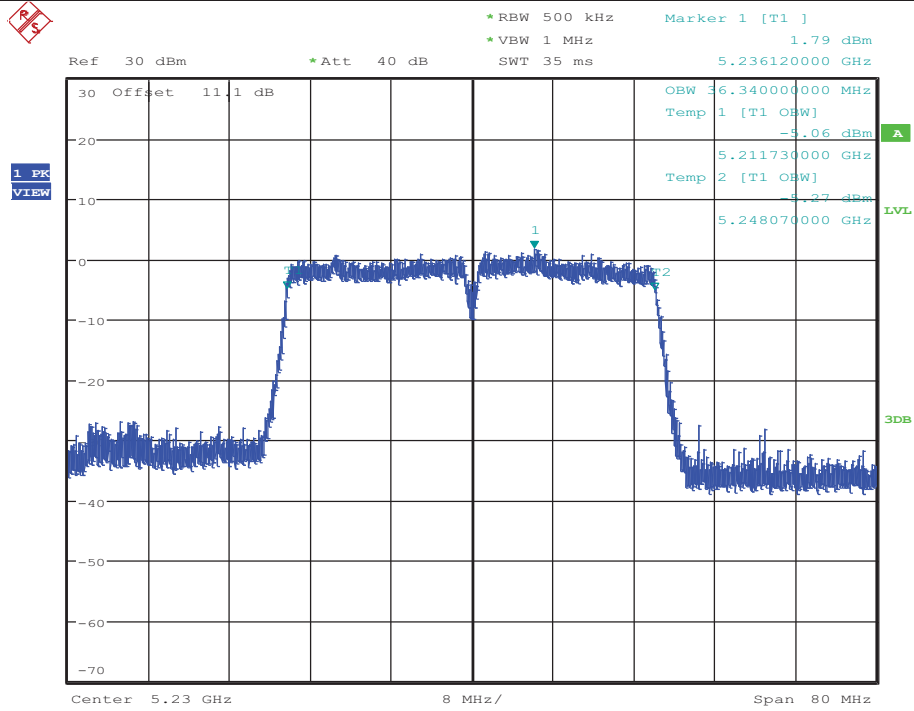

Date: 17.OCT.2017 15:24:50

### Occupied Bandwidth Measurement\_11AC40MIMO\_5270\_Ant1

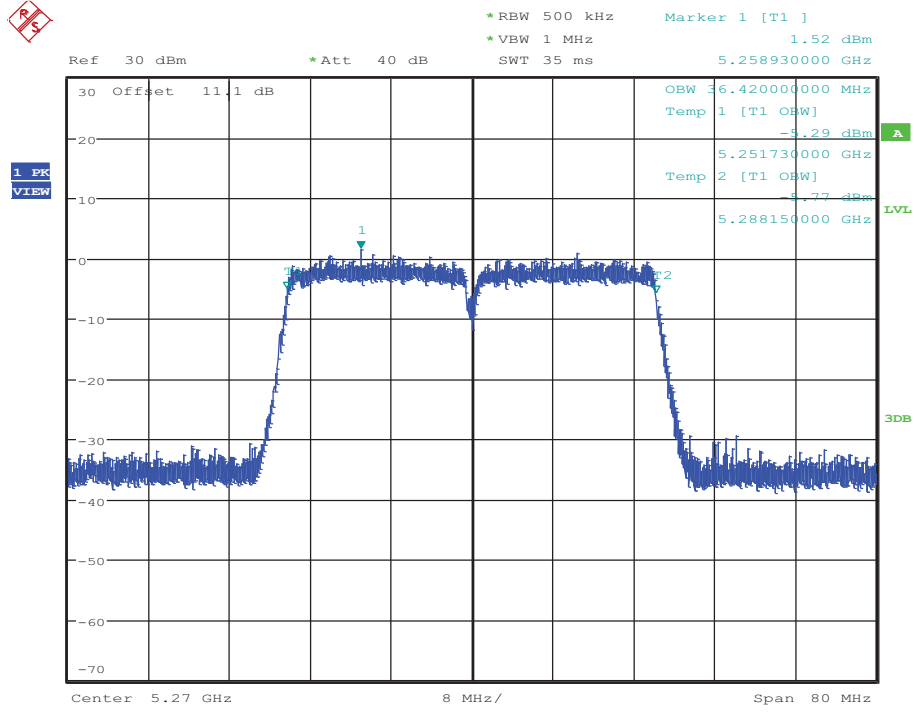

Date: 17.OCT.2017 10:32:00

### Occupied Bandwidth Measurement\_11AC40MIMO\_5270\_Ant2

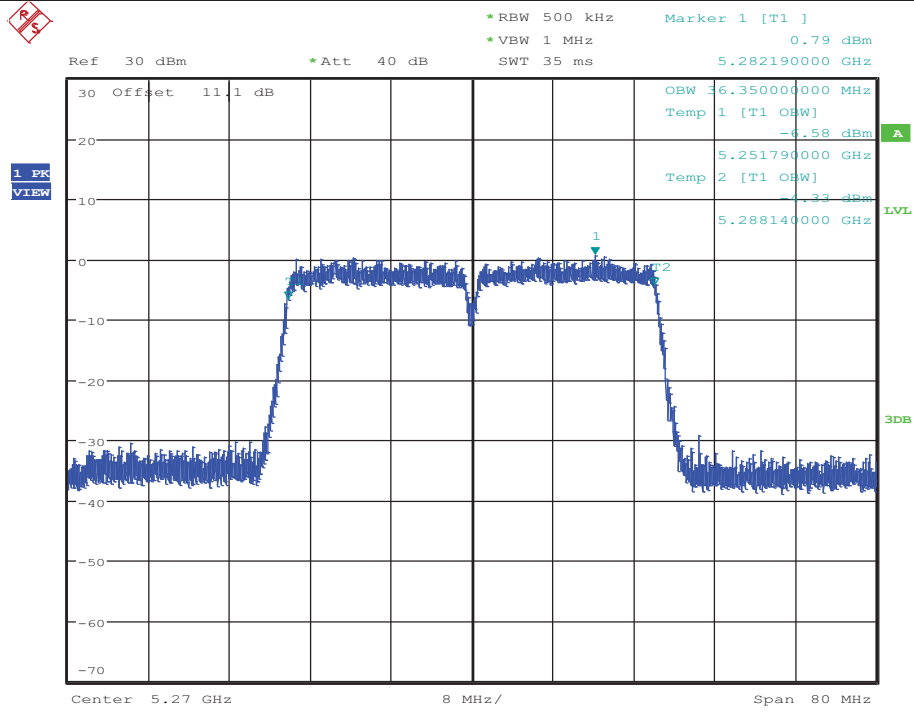

Date: 17.OCT.2017 17:08:37

### Occupied Bandwidth Measurement\_11AC40MIMO\_5310\_Ant1

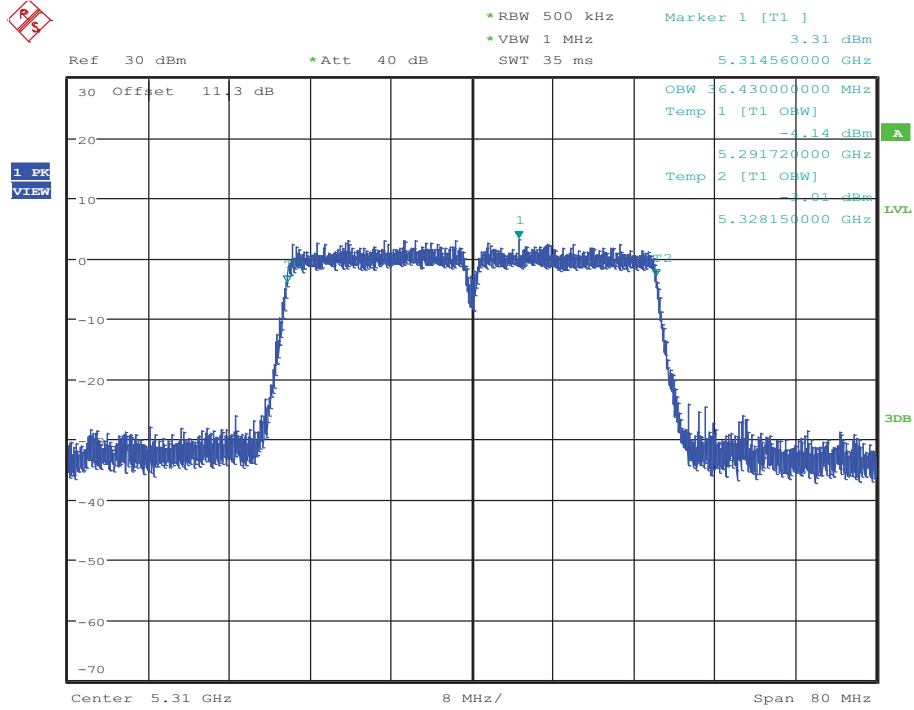

Date: 17.OCT.2017 10:38:59

### Occupied Bandwidth Measurement\_11AC40MIMO\_5310\_Ant2

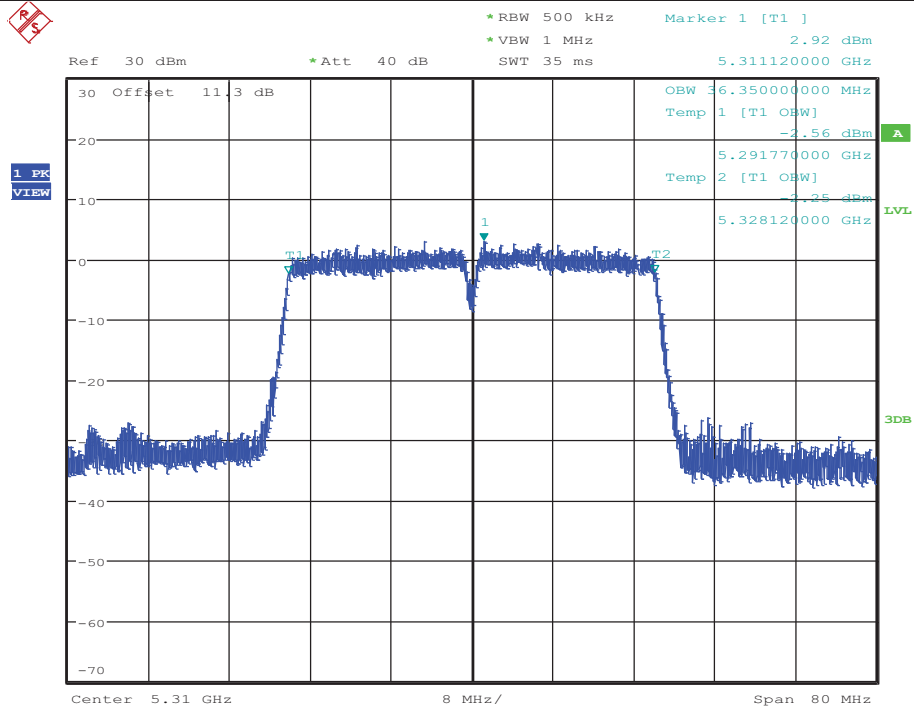

Date: 17.OCT.2017 17:13:32

### Occupied Bandwidth Measurement\_11AC40MIMO\_5510\_Ant1

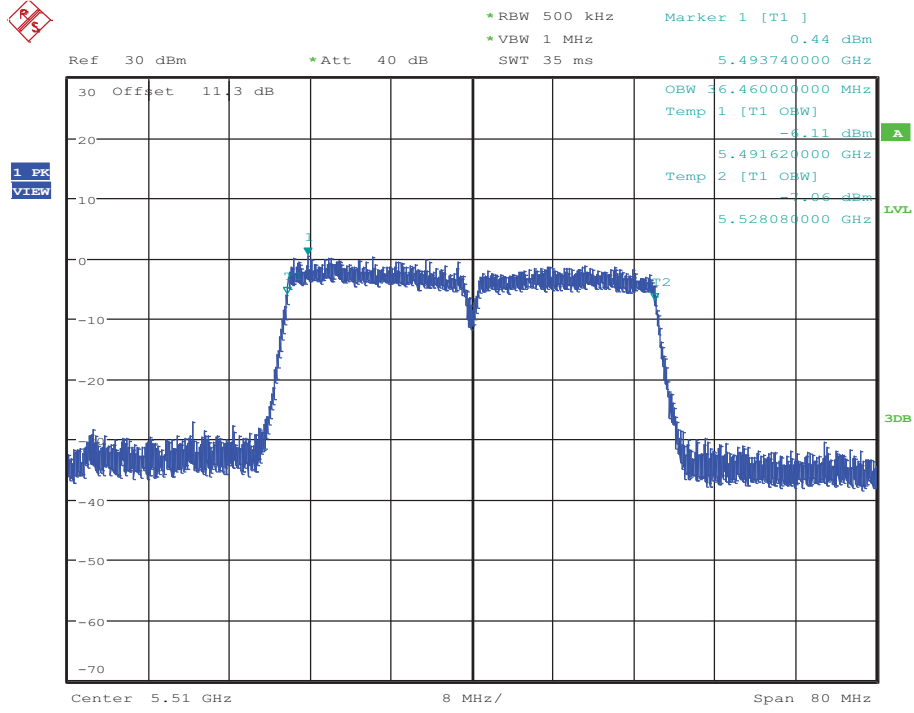

Date: 17.OCT.2017 10:45:12

### Occupied Bandwidth Measurement\_11AC40MIMO\_5510\_Ant2

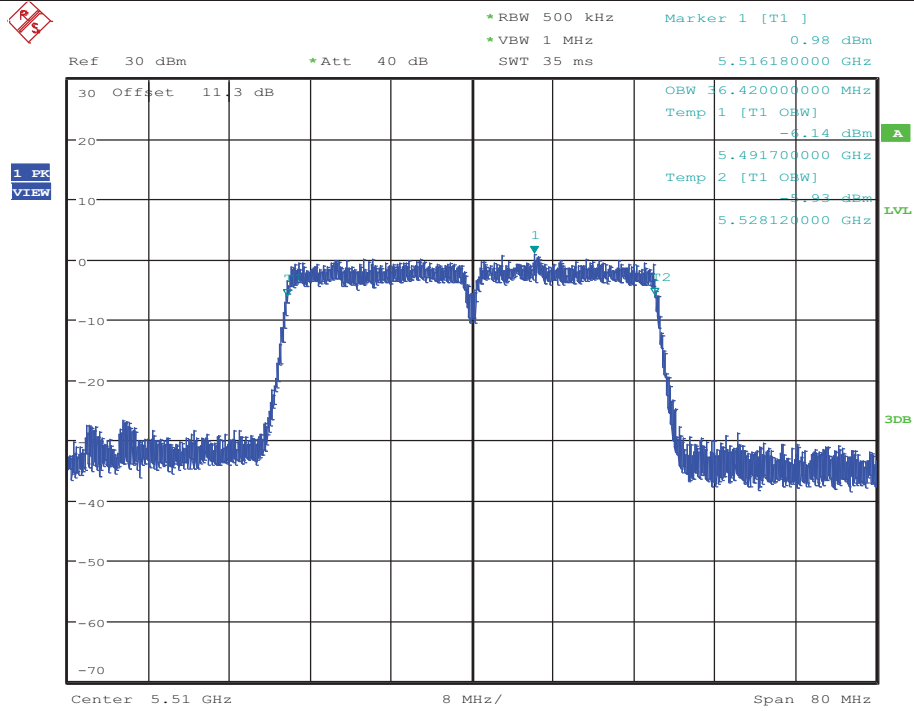

Date: 17.OCT.2017 17:18:57

### Occupied Bandwidth Measurement\_11AC40MIMO\_5550\_Ant1

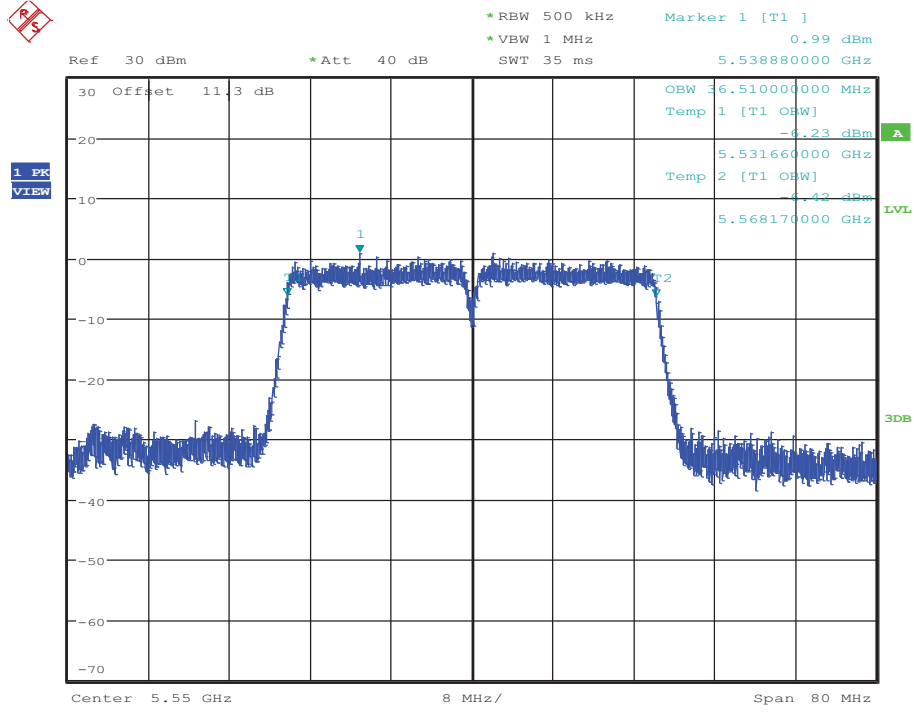

Date: 17.OCT.2017 10:51:55

### Occupied Bandwidth Measurement\_11AC40MIMO\_5550\_Ant2

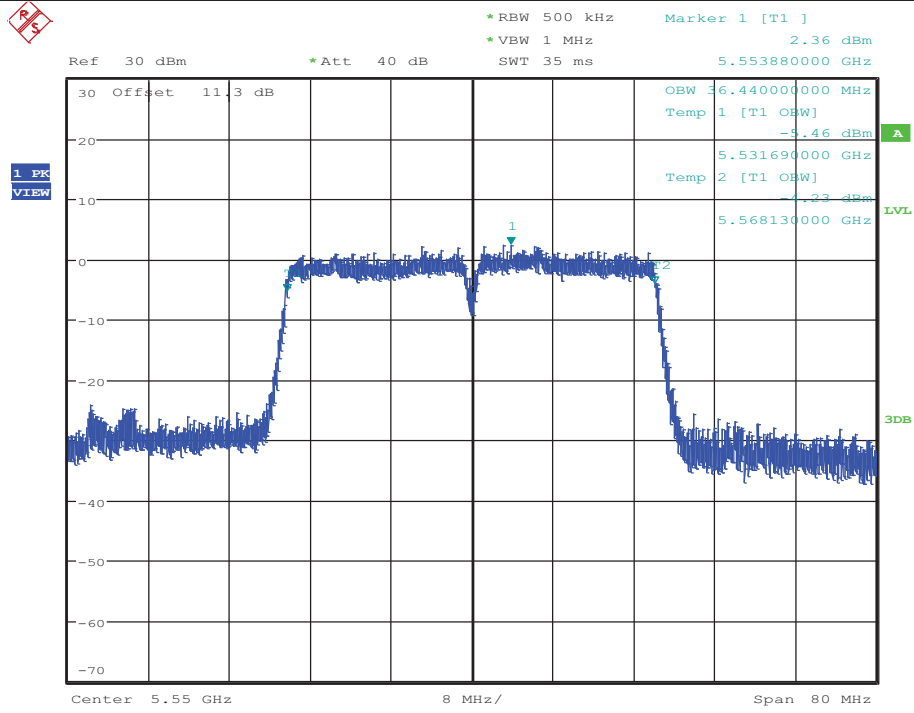

Date: 17.OCT.2017 17:23:34

### Occupied Bandwidth Measurement\_11AC40MIMO\_5670\_Ant1

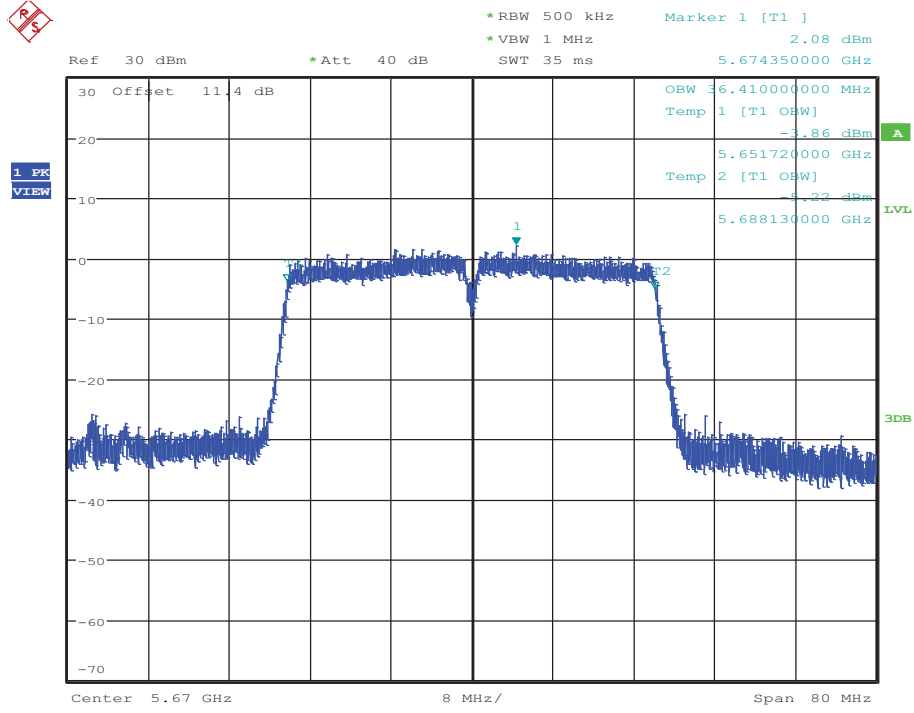

Date: 17.OCT.2017 10:56:36

### Occupied Bandwidth Measurement\_11AC40MIMO\_5670\_Ant2

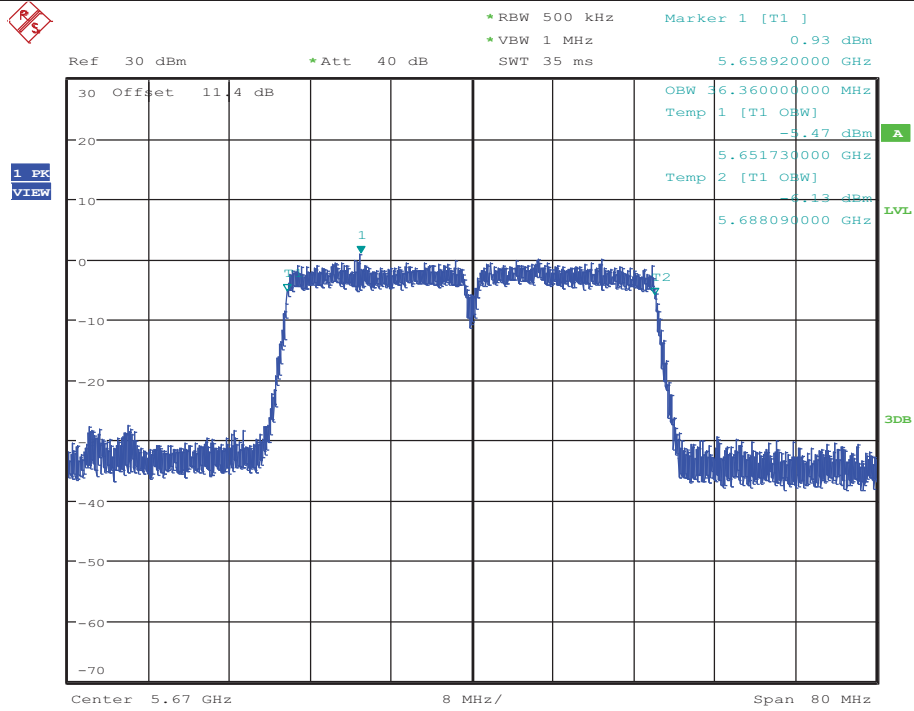

Date: 17.OCT.2017 17:29:00

Occupied Bandwidth Measurement\_11AC40MIMO\_5755\_Ant1

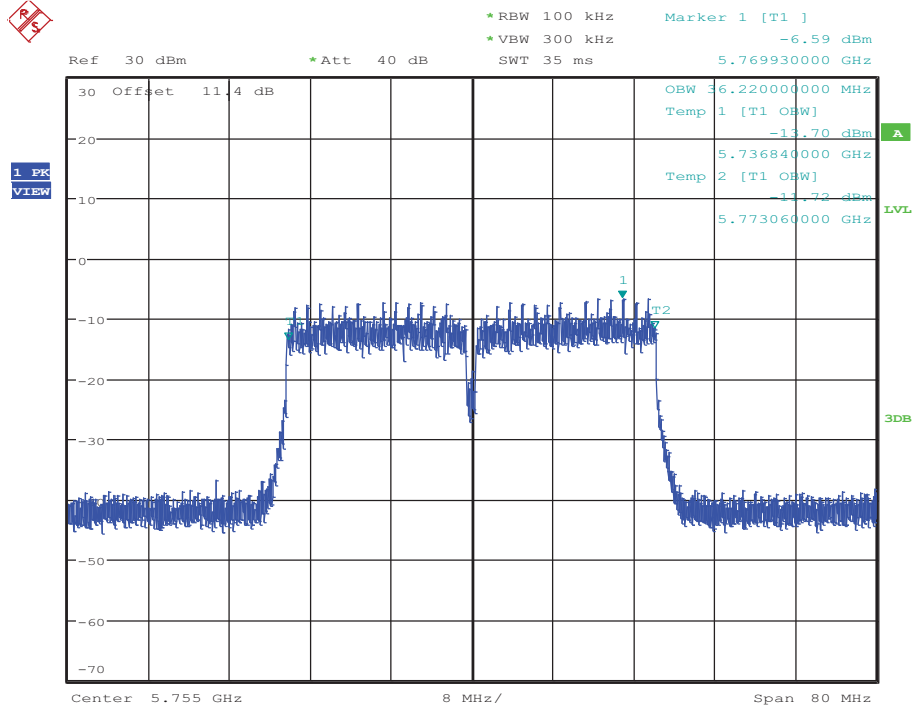

Date: 17.OCT.2017 11:02:09

Occupied Bandwidth Measurement\_11AC40MIMO\_5755\_Ant2

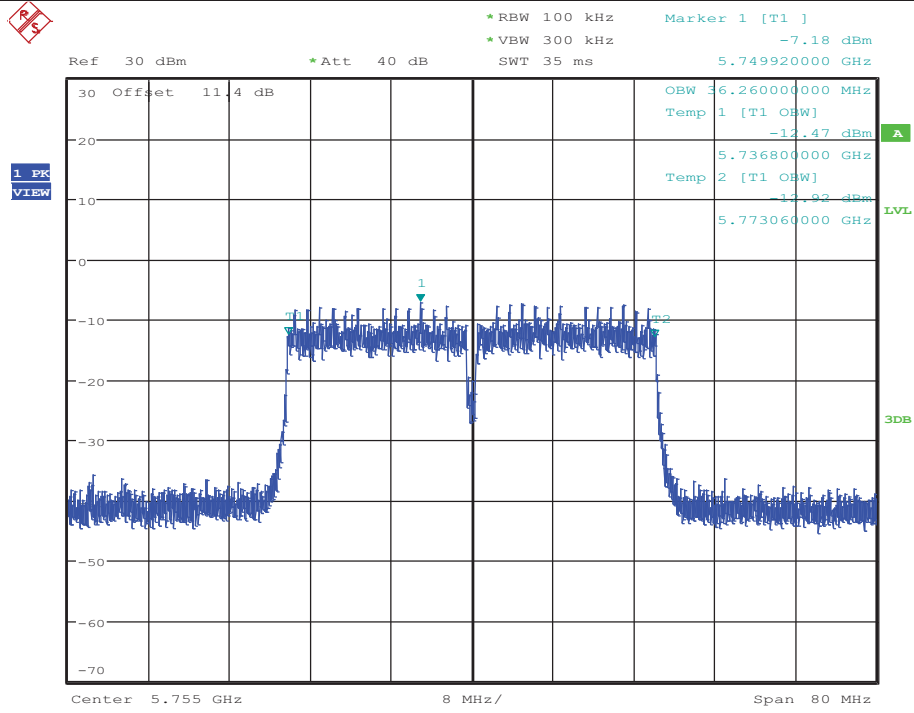

Date: 17.OCT.2017 17:33:49

### Occupied Bandwidth Measurement\_11AC40MIMO\_5795\_Ant1

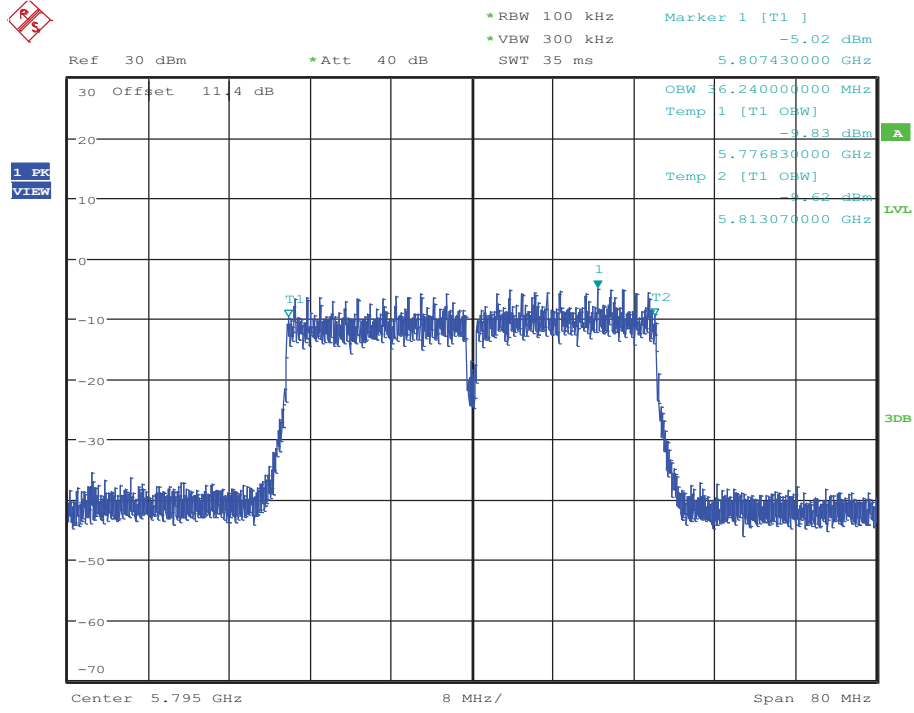

Date: 17.OCT.2017 11:06:47

### Occupied Bandwidth Measurement\_11AC40MIMO\_5795\_Ant2

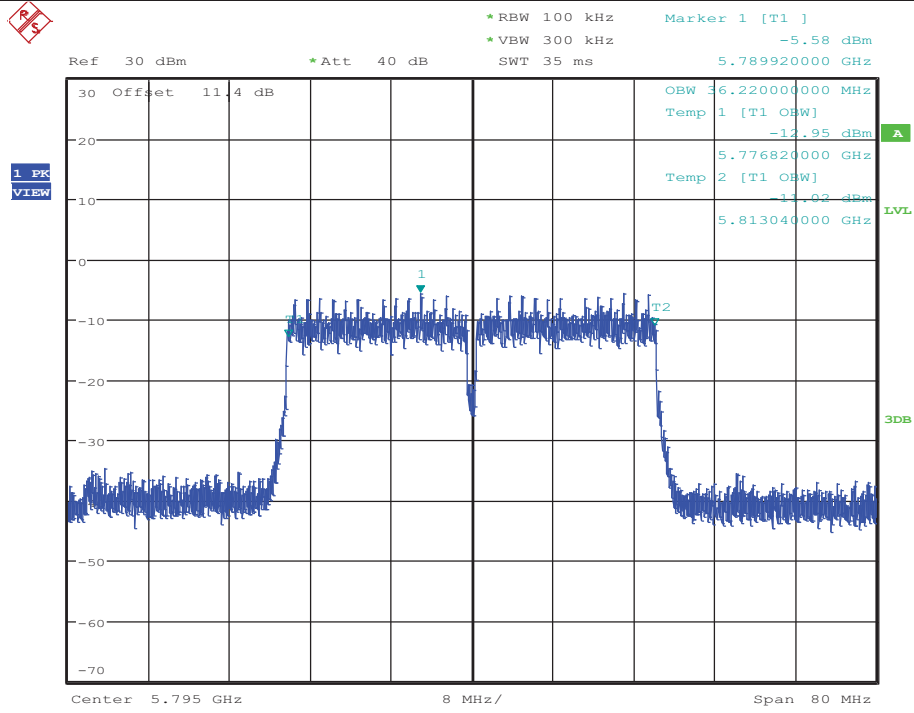

Date: 17.OCT.2017 17:38:26



### Occupied Bandwidth Measurement\_11AC80MIMO\_5210\_Ant1

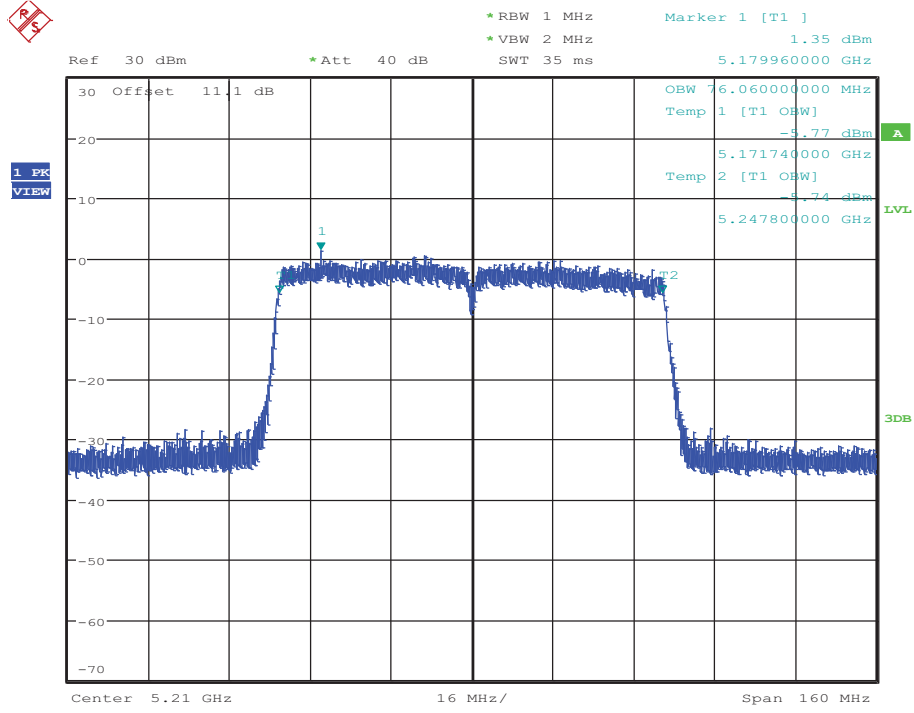

Date: 17.OCT.2017 11:11:39

### Occupied Bandwidth Measurement\_11AC80MIMO\_5210\_Ant2

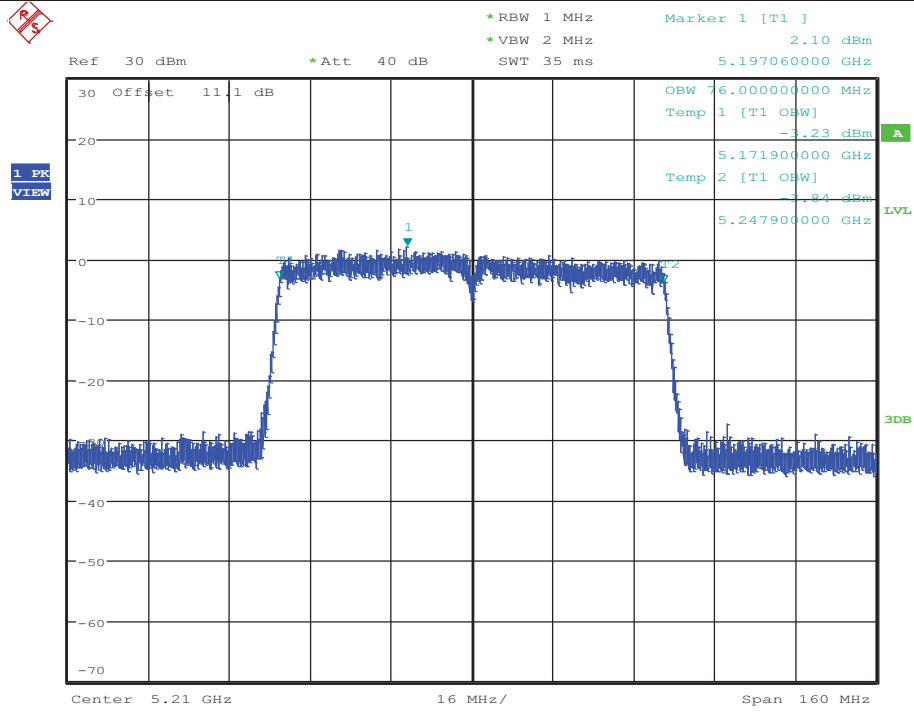

Date: 17.OCT.2017 17:43:17

### Occupied Bandwidth Measurement\_11AC80MIMO\_5290\_Ant1

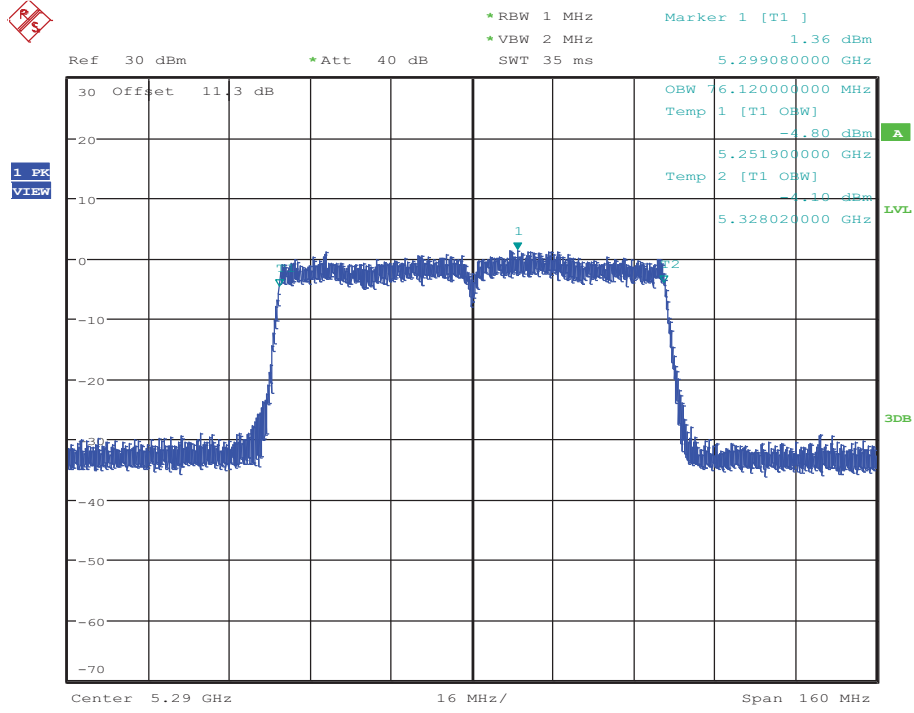

Date: 17.OCT.2017 11:22:40

### Occupied Bandwidth Measurement\_11AC80MIMO\_5290\_Ant2

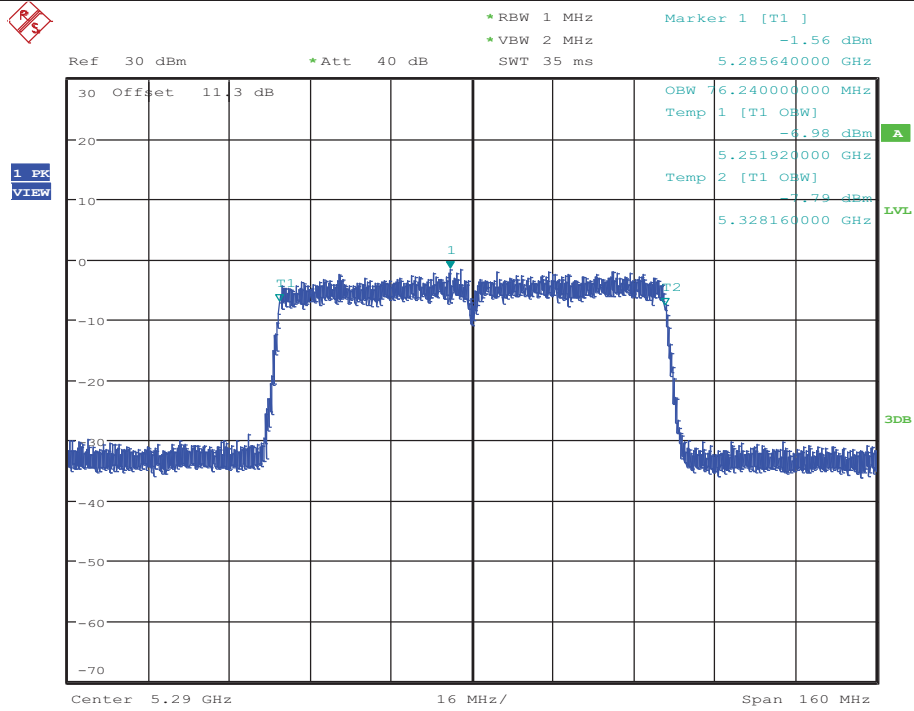

Date: 17.OCT.2017 18:47:34

### Occupied Bandwidth Measurement\_11AC80MIMO\_5530\_Ant1

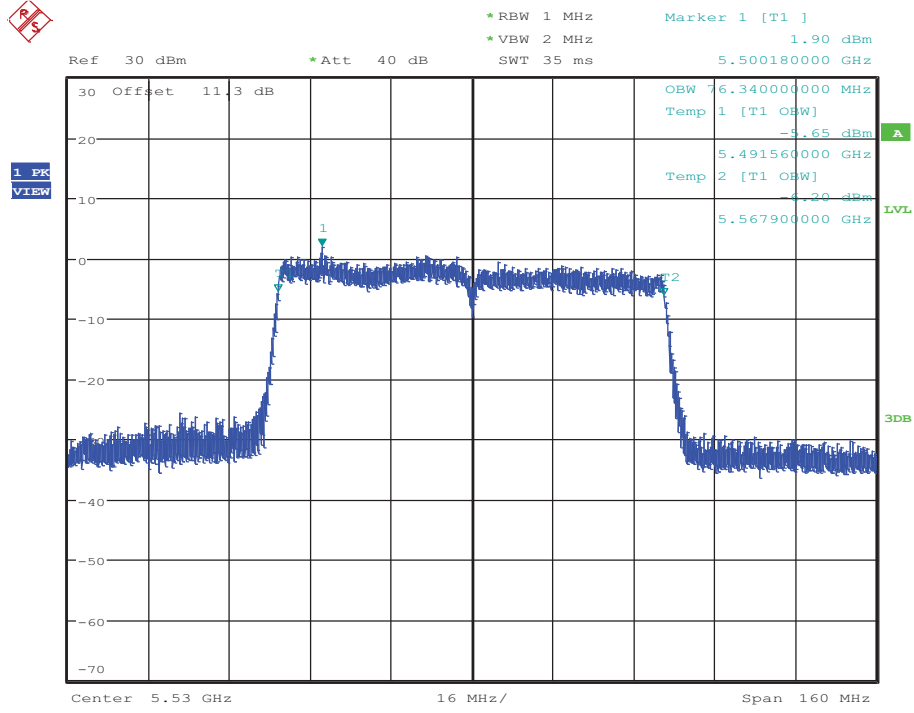

Date: 17.OCT.2017 11:28:06

### Occupied Bandwidth Measurement\_11AC80MIMO\_5530\_Ant2

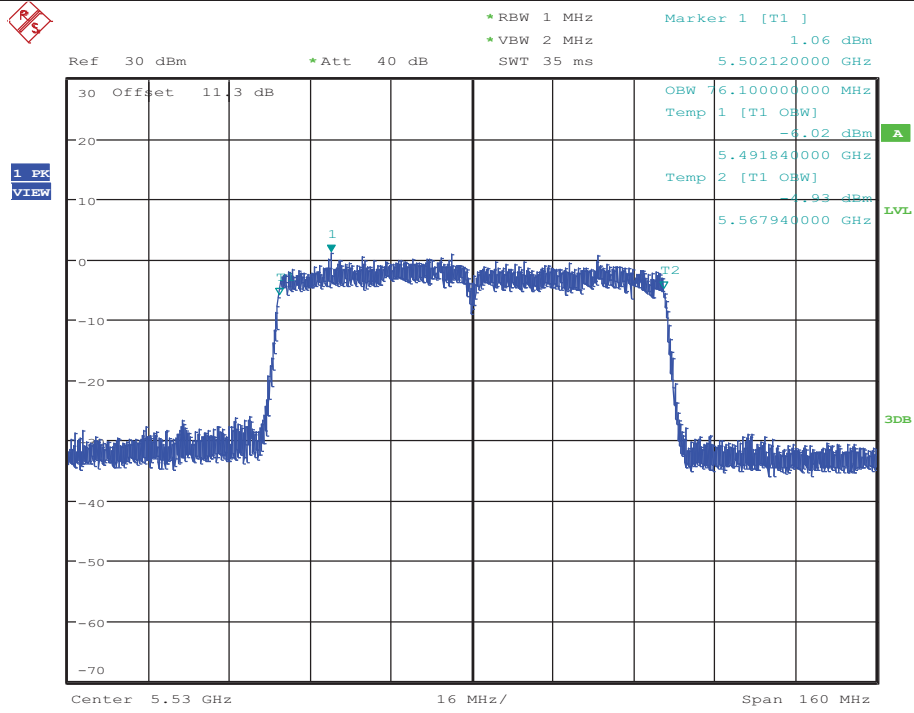

Date: 17.OCT.2017 18:53:14

### Occupied Bandwidth Measurement\_11AC80MIMO\_5775\_Ant1

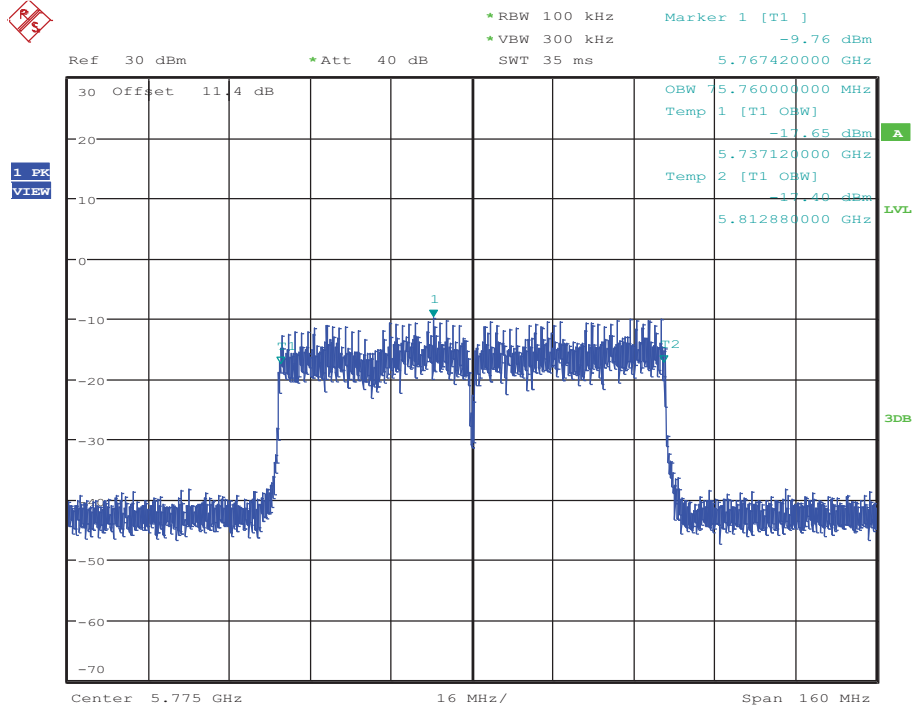

Date: 17.OCT.2017 11:35:50

### Occupied Bandwidth Measurement\_11AC80MIMO\_5775\_Ant2

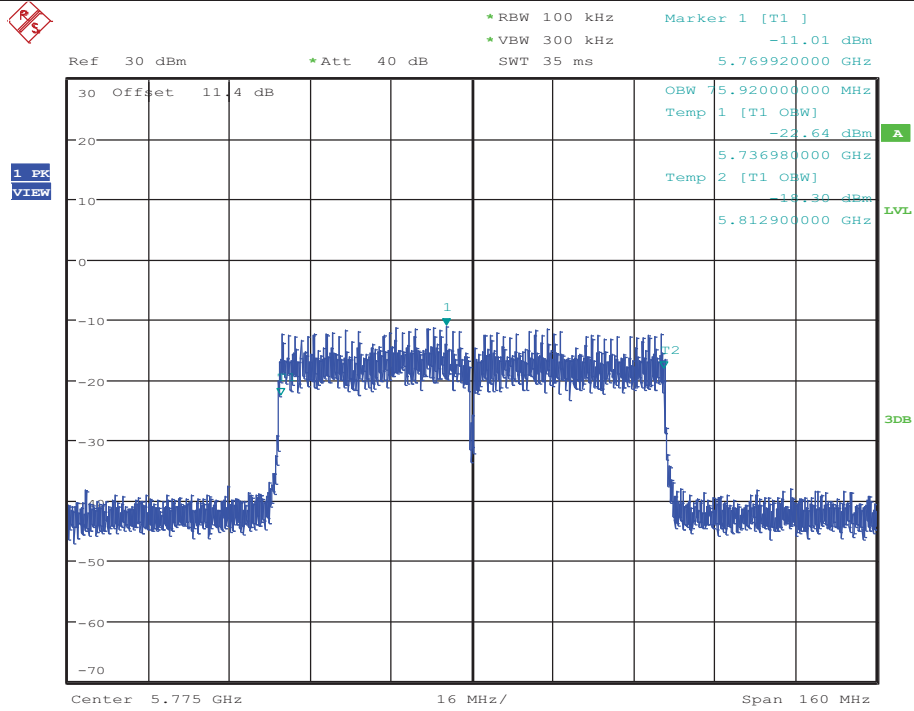

Date: 17.OCT.2017 18:59:17

### Occupied Bandwidth Measurement\_11AMIMO\_5180\_Ant1

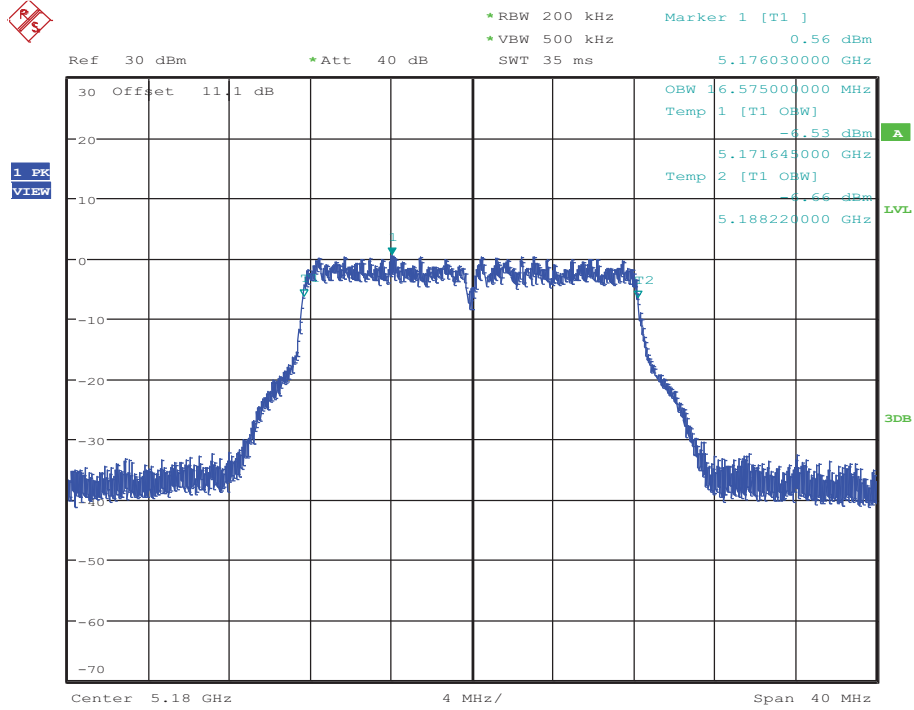

Date: 13.OCT.2017 19:34:27

### Occupied Bandwidth Measurement\_11AMIMO\_5180\_Ant2

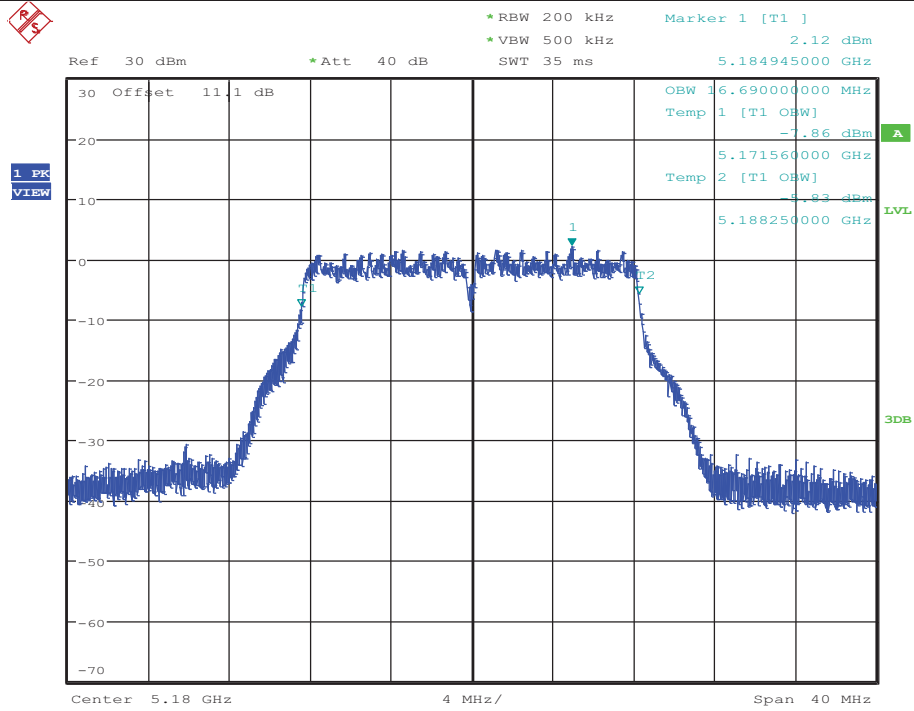

Date: 13.OCT.2017 19:40:27

### Occupied Bandwidth Measurement\_11AMIMO\_5200\_Ant1

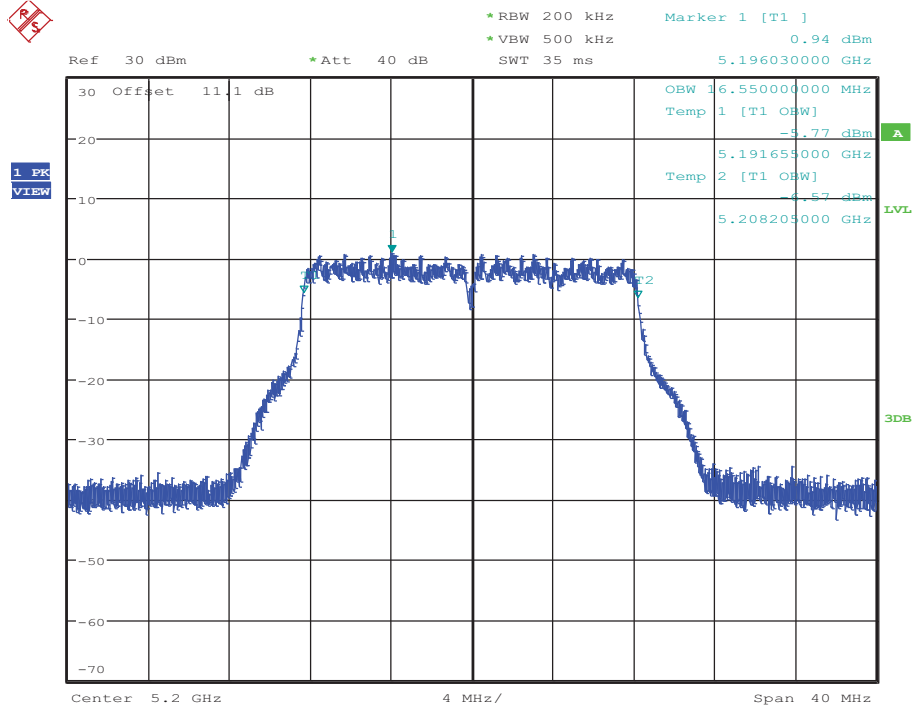

Date: 13.OCT.2017 19:47:17

### Occupied Bandwidth Measurement\_11AMIMO\_5200\_Ant2

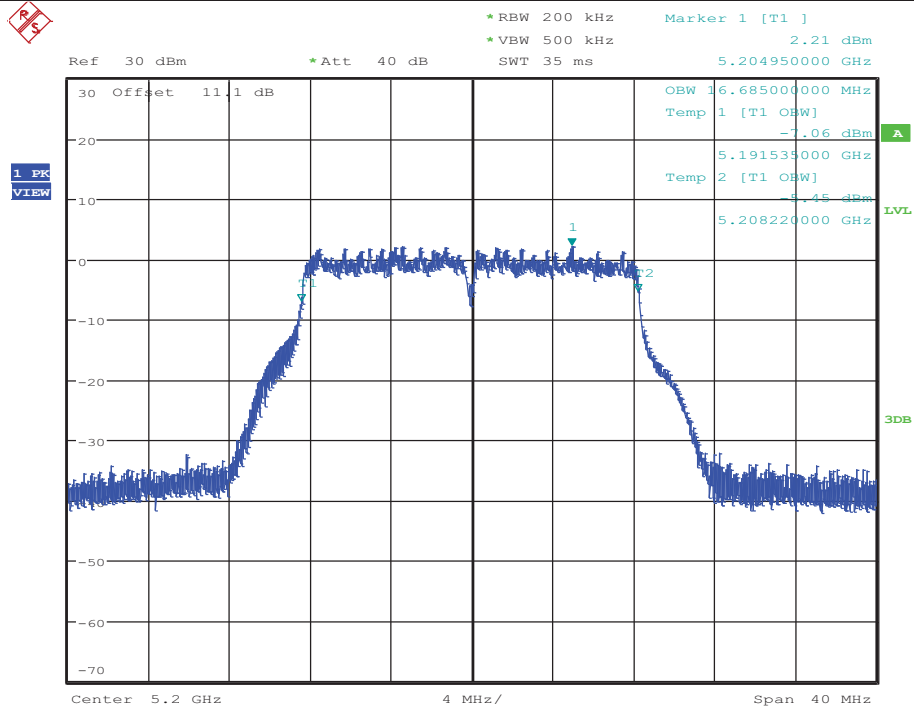

Date: 13.OCT.2017 19:51:41

### Occupied Bandwidth Measurement\_11AMIMO\_5240\_Ant1

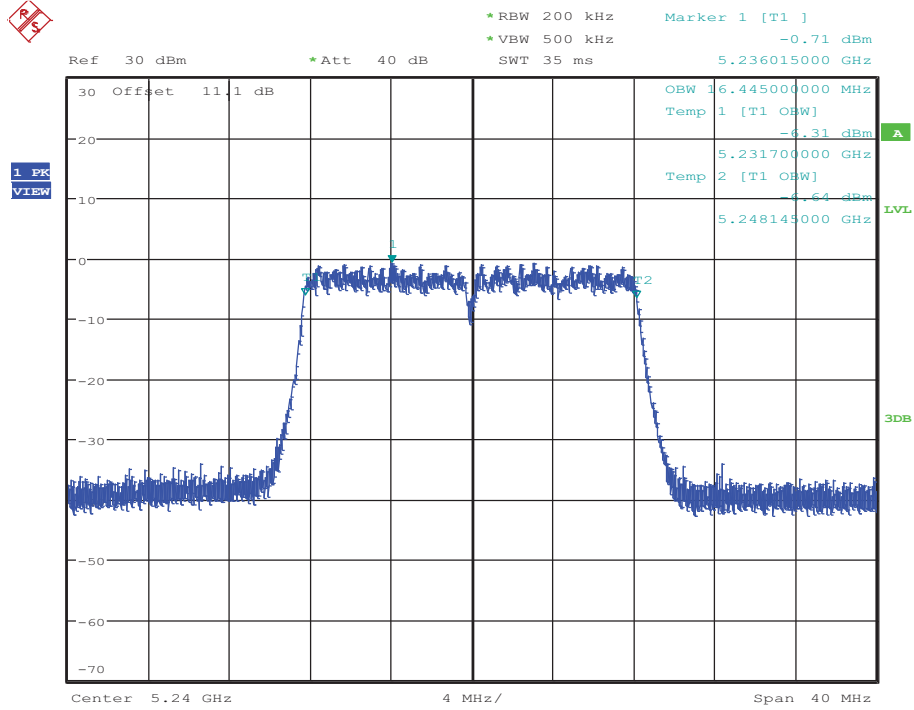

Date: 14.OCT.2017 09:24:05

### Occupied Bandwidth Measurement\_11AMIMO\_5240\_Ant2

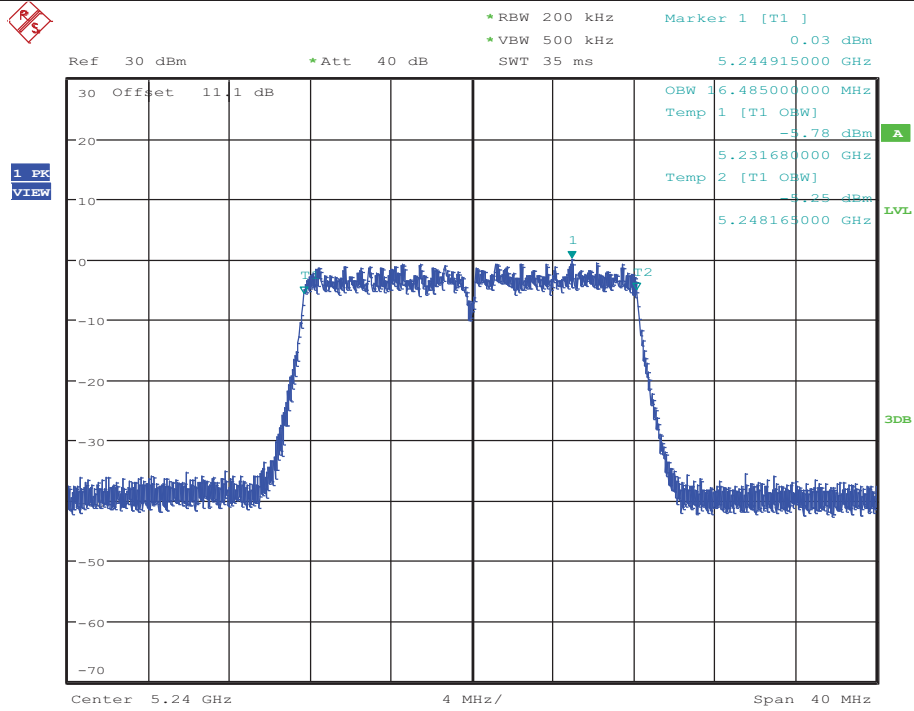

Date: 14.OCT.2017 09:31:20

### Occupied Bandwidth Measurement\_11AMIMO\_5260\_Ant1

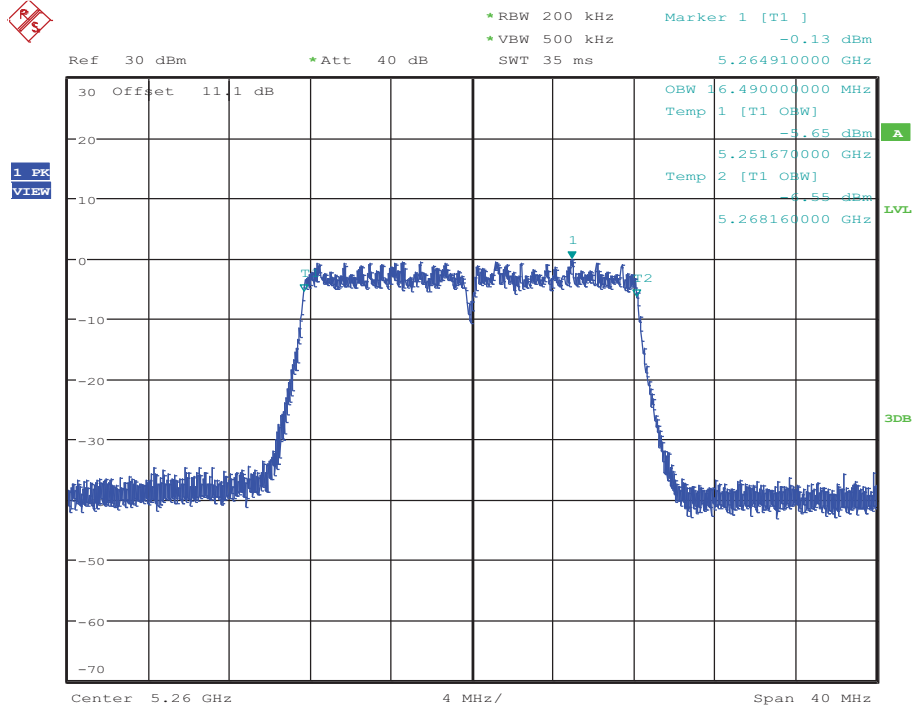

Date: 14.OCT.2017 09:42:02

### Occupied Bandwidth Measurement\_11AMIMO\_5260\_Ant2

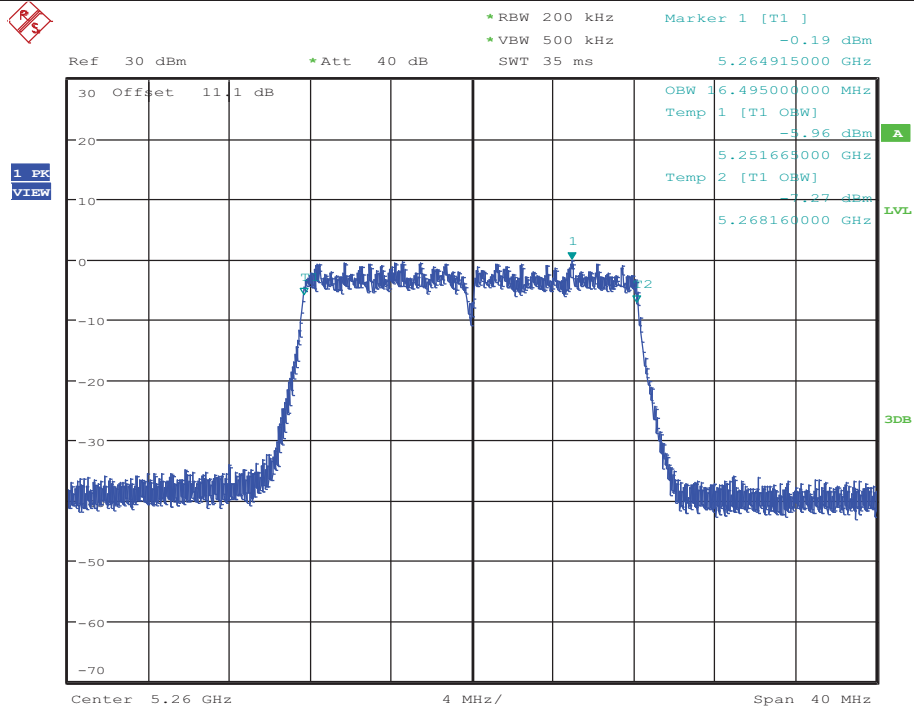

Date: 14.OCT.2017 09:57:48



### Occupied Bandwidth Measurement\_11AMIMO\_5280\_Ant1

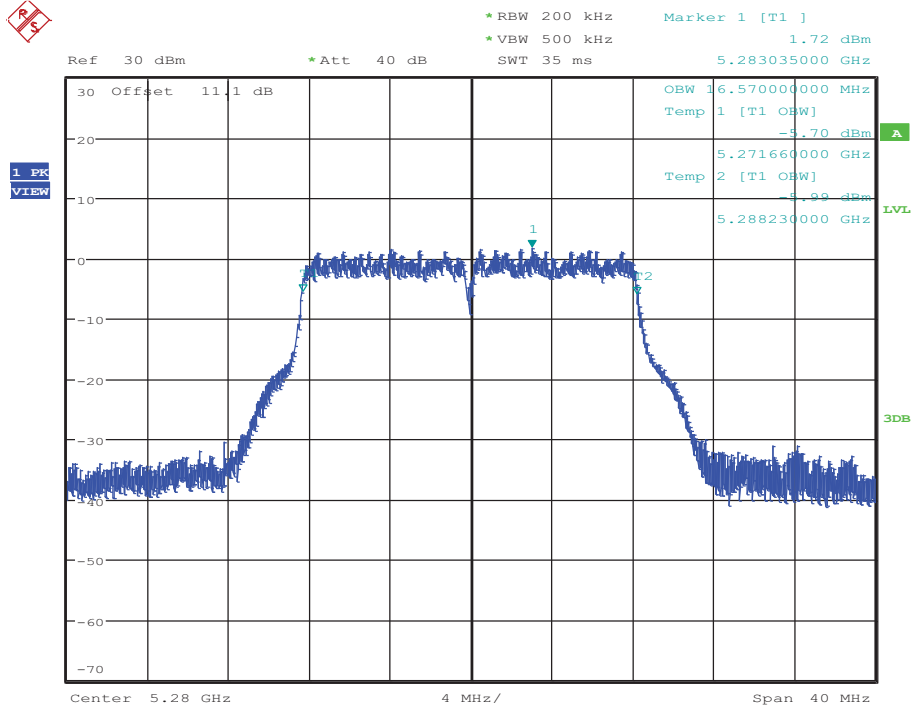

Date: 14.OCT.2017 10:04:25

### Occupied Bandwidth Measurement\_11AMIMO\_5280\_Ant2

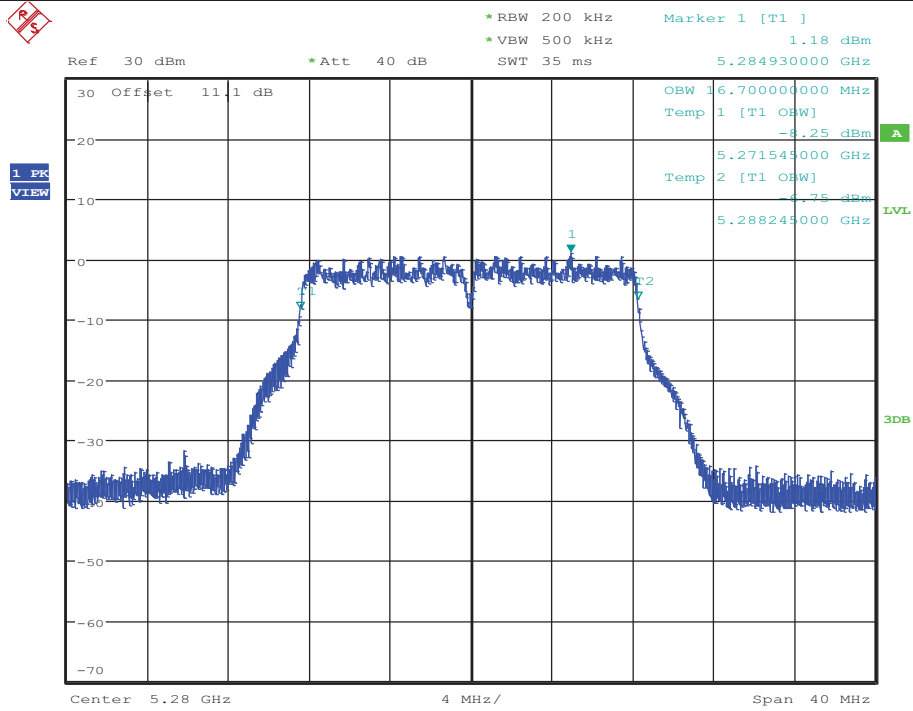

Date: 14.OCT.2017 10:09:33

### Occupied Bandwidth Measurement\_11AMIMO\_5320\_Ant1

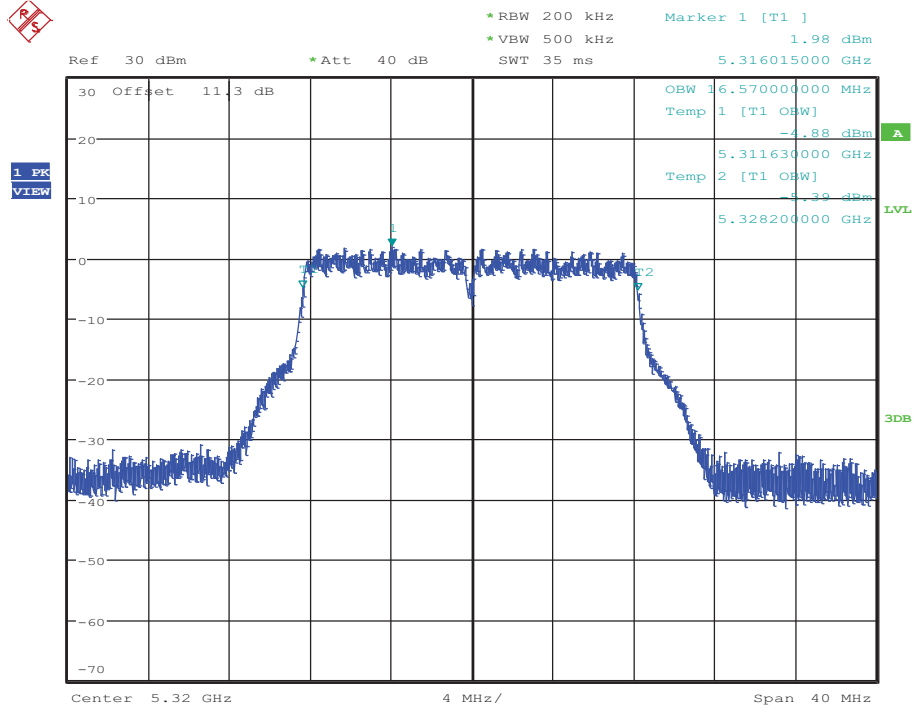

Date: 14.OCT.2017 10:28:34

### Occupied Bandwidth Measurement\_11AMIMO\_5320\_Ant2

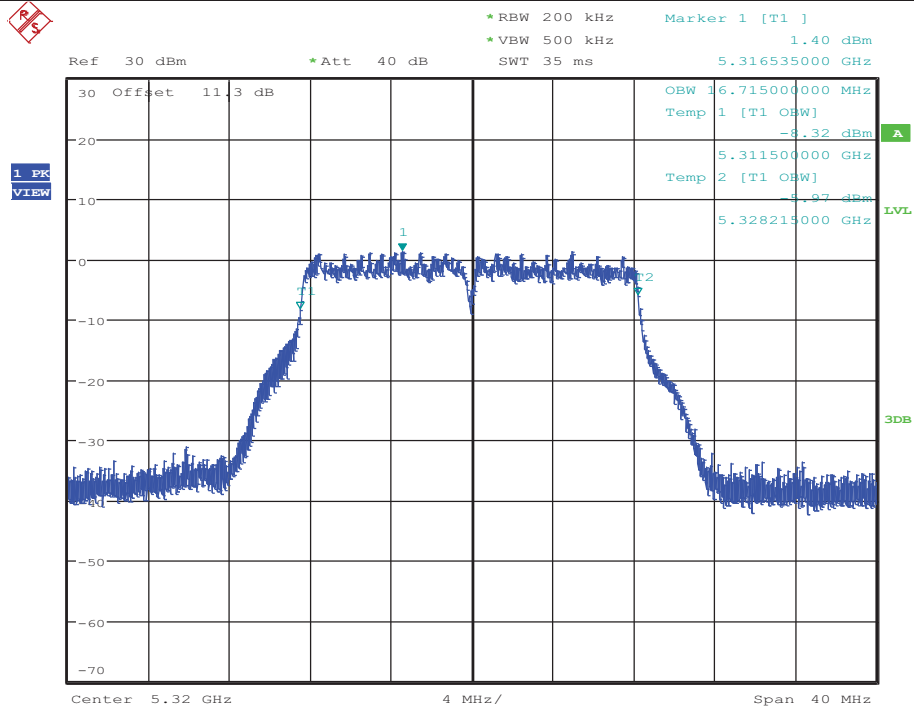

Date: 14.OCT.2017 10:33:29

### Occupied Bandwidth Measurement\_11AMIMO\_5500\_Ant1

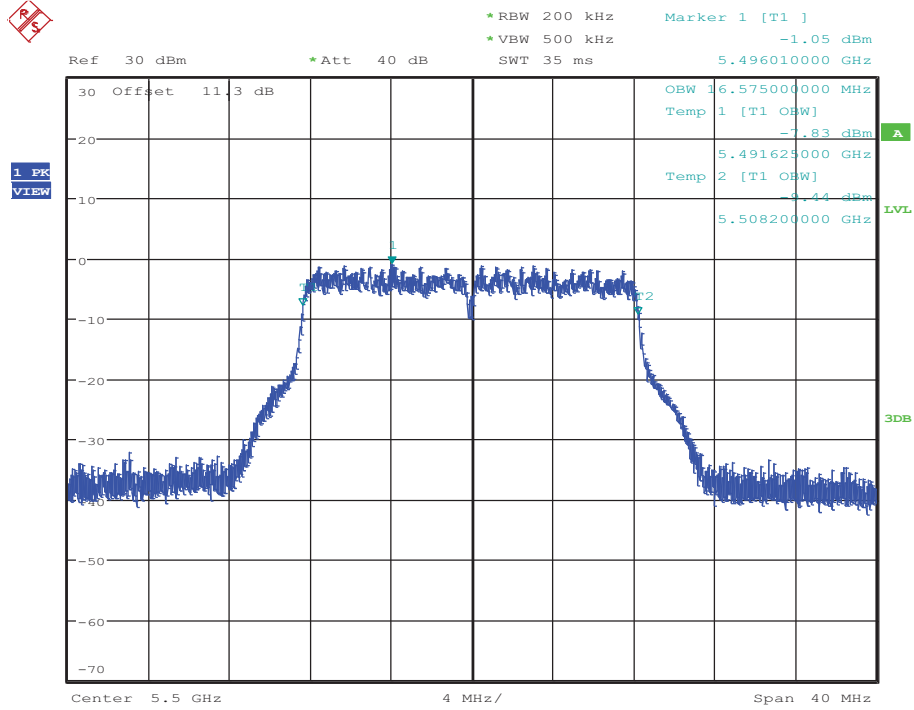

Date: 14.OCT.2017 10:47:29

### Occupied Bandwidth Measurement\_11AMIMO\_5500\_Ant2

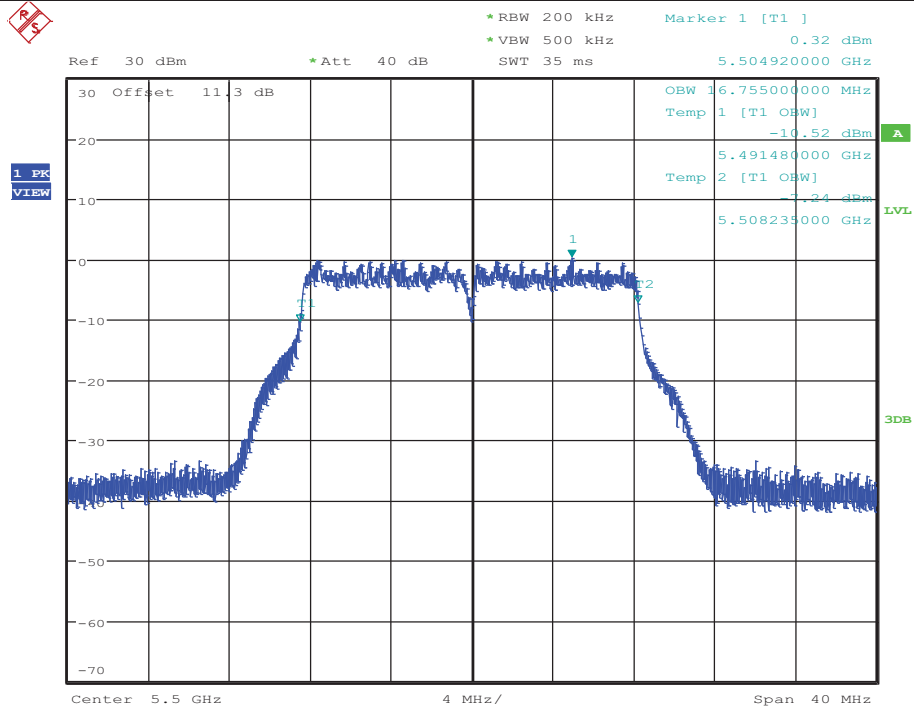

Date: 14.OCT.2017 10:52:24

### Occupied Bandwidth Measurement\_11AMIMO\_5580\_Ant1

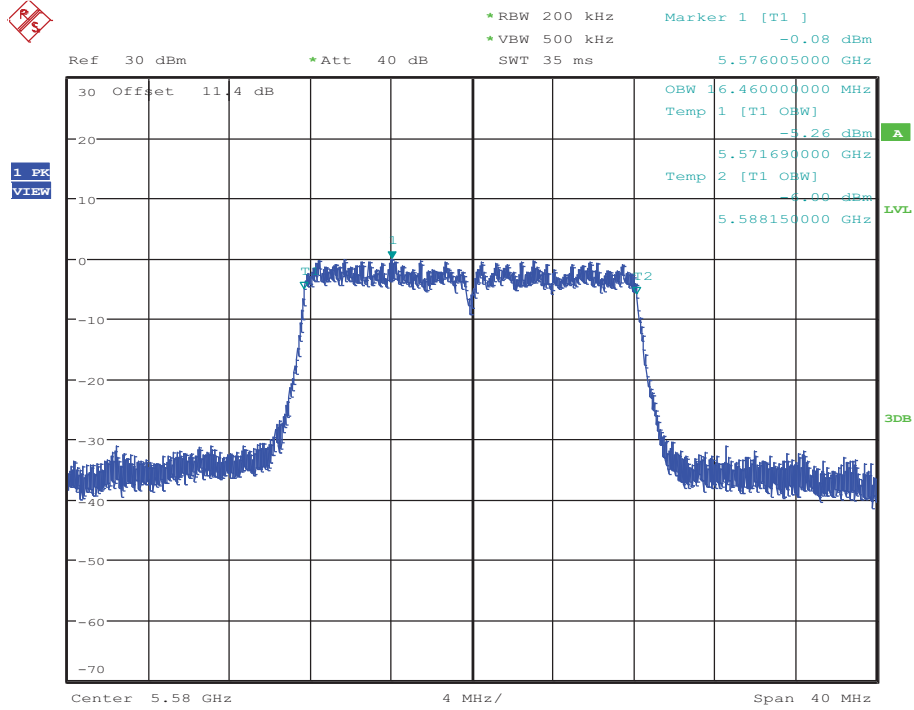

Date: 14.OCT.2017 10:59:47

### Occupied Bandwidth Measurement\_11AMIMO\_5580\_Ant2

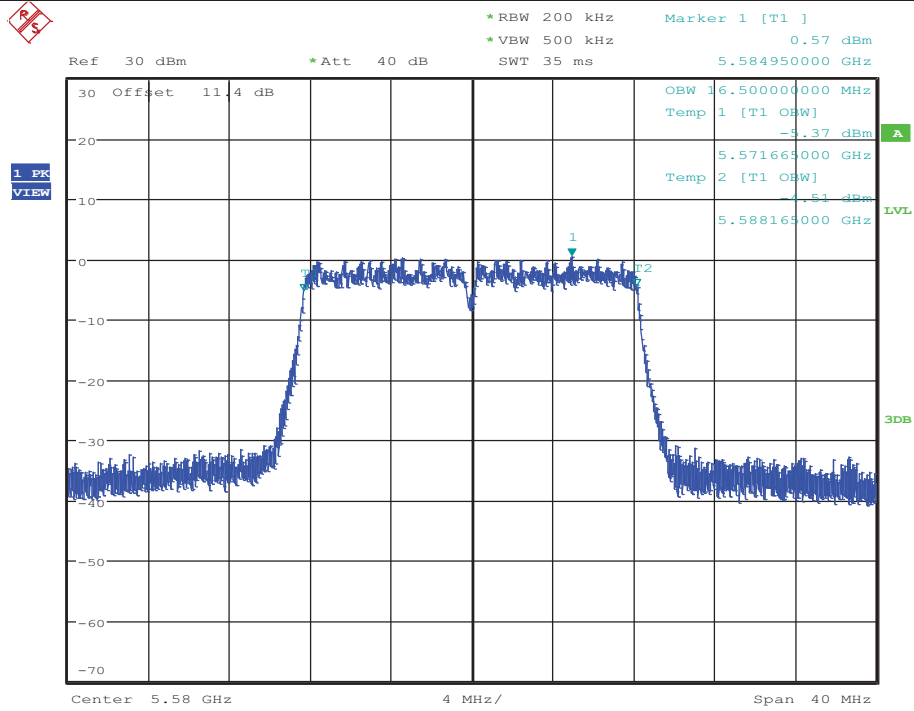

Date: 14.OCT.2017 11:52:24

### Occupied Bandwidth Measurement\_11AMIMO\_5700\_Ant1

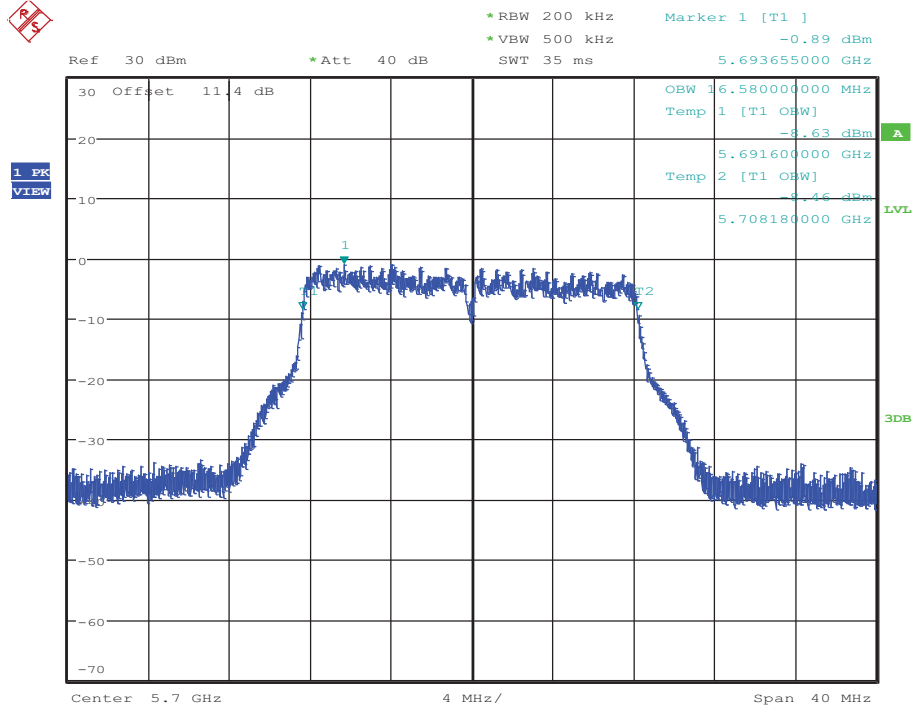

Date: 14.OCT.2017 11:08:40

### Occupied Bandwidth Measurement\_11AMIMO\_5700\_Ant2

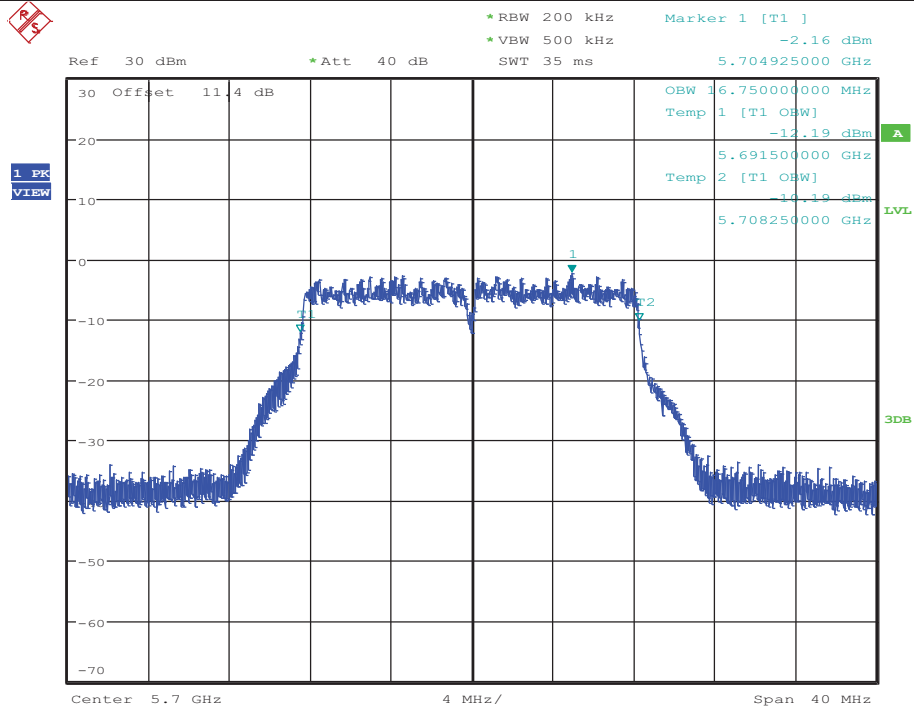

Date: 14.OCT.2017 11:58:03

### Occupied Bandwidth Measurement\_11AMIMO\_5745\_Ant1

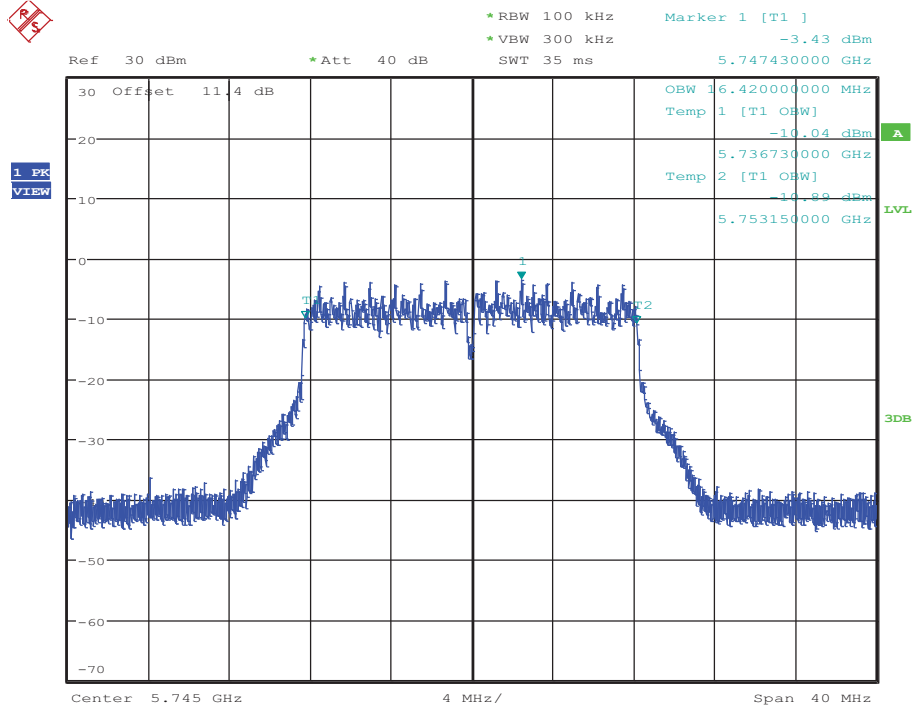

Date: 14.OCT.2017 11:19:57

### Occupied Bandwidth Measurement\_11AMIMO\_5745\_Ant2

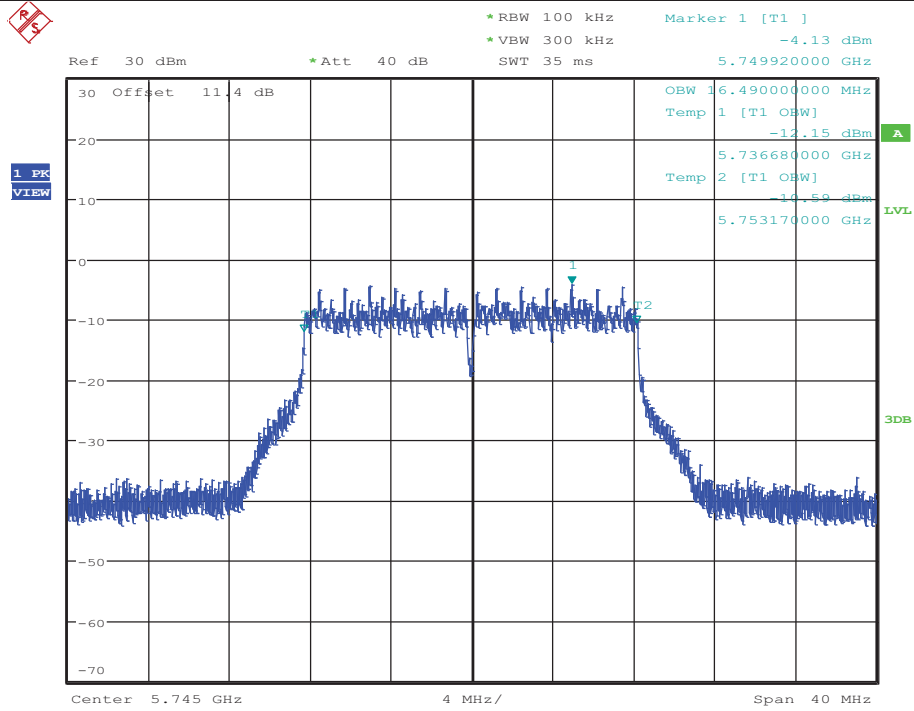

Date: 14.OCT.2017 12:04:50

### Occupied Bandwidth Measurement\_11AMIMO\_5785\_Ant1

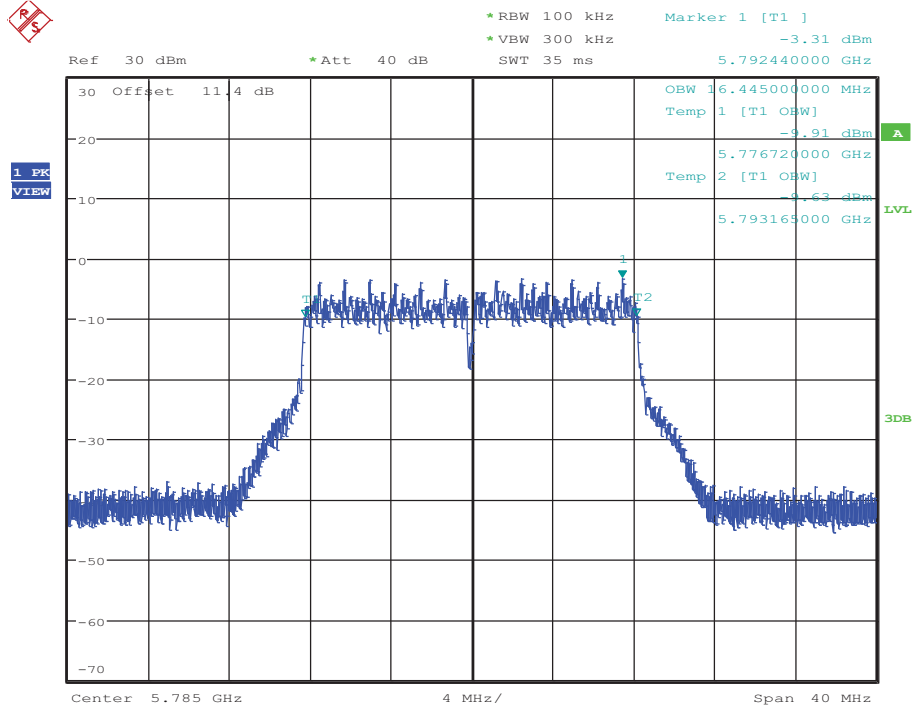

Date: 14.OCT.2017 11:38:40

### Occupied Bandwidth Measurement\_11AMIMO\_5785\_Ant2

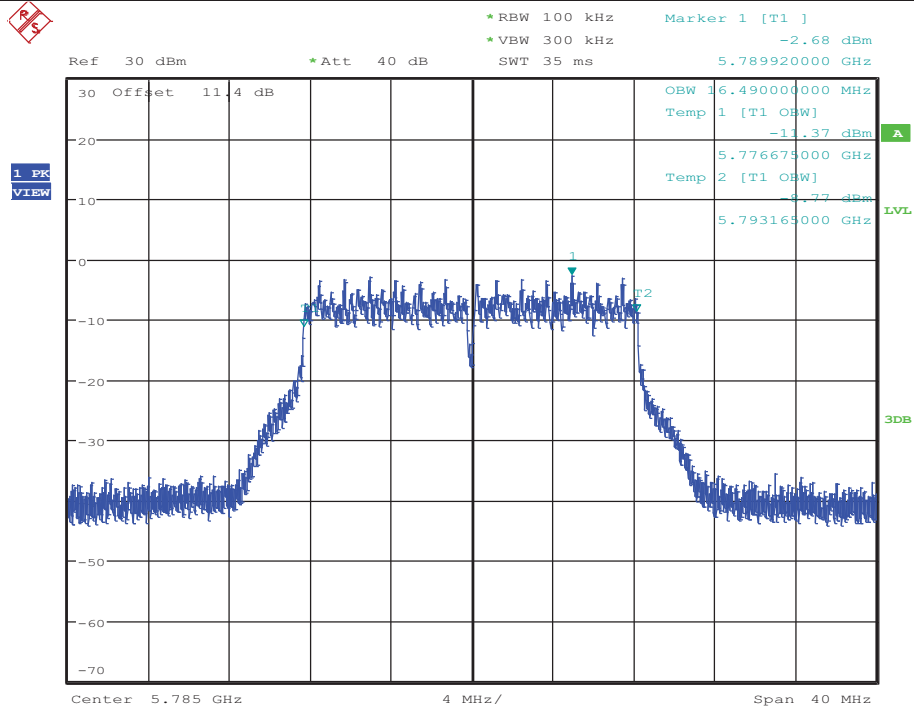

Date: 14.OCT.2017 12:09:59

Occupied Bandwidth Measurement\_11AMIMO\_5825\_Ant1

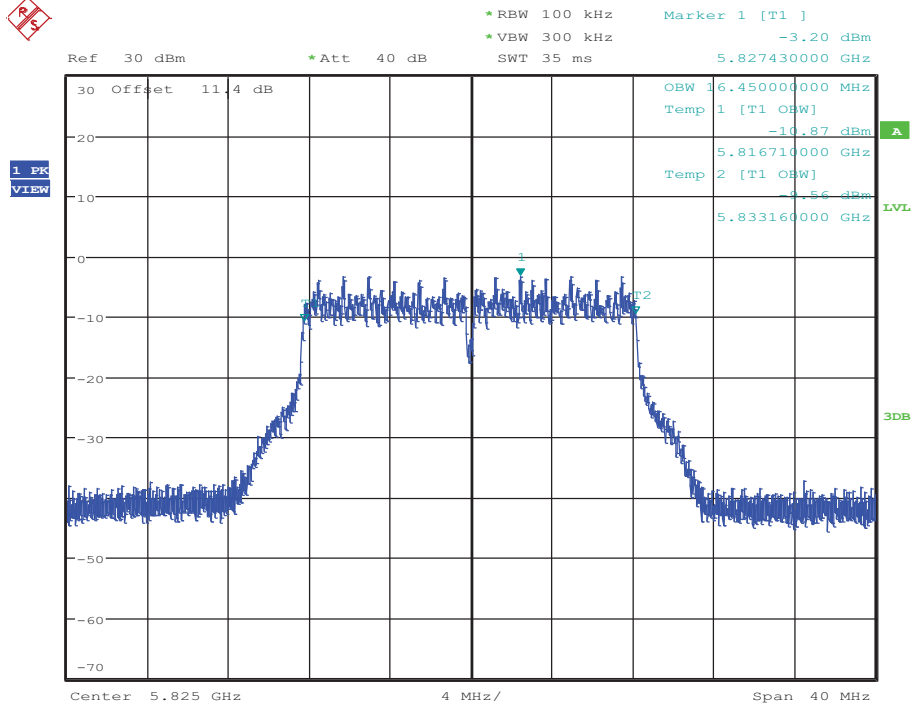

Date: 14.OCT.2017 11:44:04

Occupied Bandwidth Measurement\_11AMIMO\_5825\_Ant2

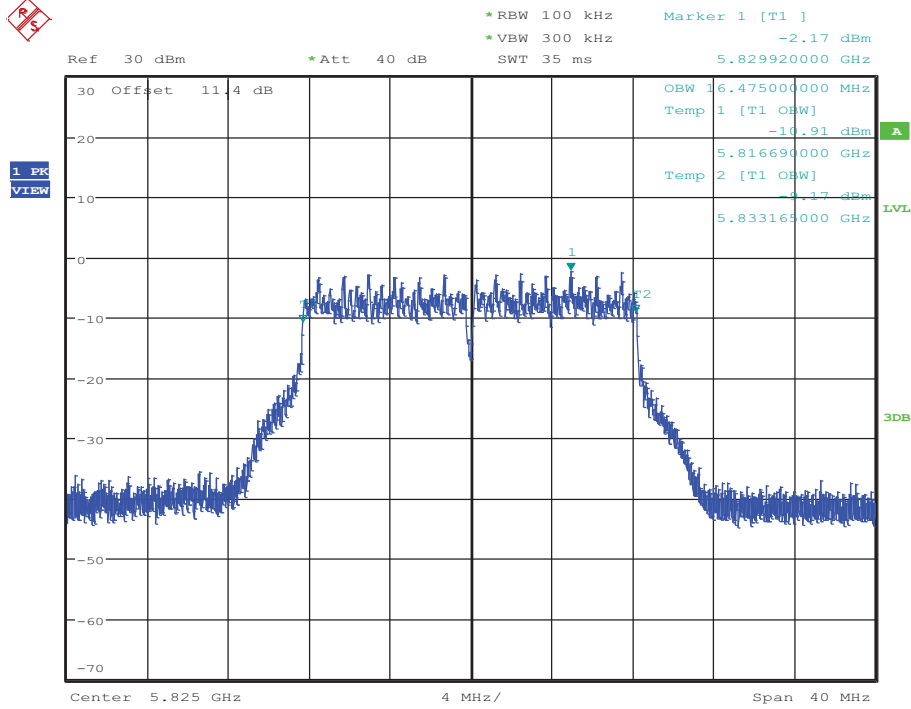

Date: 14.OCT.2017 13:27:04



## 6. Maximum Output Power

### 6.1. Block diagram of test setup

Same as section 4.1

### 6.2. Limits

FCC Part15, Subpart E/ RSS-247		
Test Item	Limit	Frequency Range (MHz)
Conducted Output Power	For FCC client devices :250mW (24dBm)	5150-5250
	For RSS:e.i.r.p. power: not exceed 200 mW(23dBm) or $10 + 10 \log_{10} B$	
	250mW (24dBm) or $11 + 10 \log_{10} B$	5250-5350
	250mW (24dBm) or $11 + 10 \log_{10} B$	For FCC:5470-5725 For IC:5470-5600 5650-5725
	1 Watt (30dBm)	5725-5850
Note: For FCC: B=26dB bandwidth, ISSED: B=99% bandwidth.		

### 6.3. Test Procedure

- (1) Connect each EUT's antenna output to power sensor by RF cable and attenuator
- (2) Add each antenna port's results to get the total output power of EUT.

### 6.4. Test Result (Average)

(5150-5250)

Test Mode	Test Channel	Ant	Level [dBm]	$10\log(1/x)$ Factor [dB]	Output Power [dBm]	EIRP [dBm]	FCC LIMIT	ISED LIMIT (EIRP10 + $10 \log_{10} B$ )
11N20MIMO	5180	Ant1	11.47	0.50	11.97	14.78	23.98	22.15
11N20MIMO	5180	Ant2	13.2	0.50	13.70	19.11	23.98	22.15
11N20MIMO	5180	Ant1+Ant2	15.43	---	15.93	20.47	23.98	22.15
11N20MIMO	5200	Ant1	11.89	0.48	12.37	15.18	23.98	22.15
11N20MIMO	5200	Ant2	13.45	0.48	13.93	19.34	23.98	22.15
11N20MIMO	5200	Ant1+Ant2	15.75	---	16.23	20.75	23.98	22.15
11N20MIMO	5240	Ant1	10.82	0.48	11.30	14.11	23.98	22.15
11N20MIMO	5240	Ant2	10.67	0.50	11.17	16.58	23.98	22.15
11N20MIMO	5240	Ant1+Ant2	13.76	---	14.25	18.53	23.98	22.15
11N40MIMO	5190	Ant1	11.3	0.83	12.13	14.94	23.98	22.15
11N40MIMO	5190	Ant2	12.81	0.82	13.63	19.04	23.98	22.15
11N40MIMO	5190	Ant1+Ant2	15.13	---	15.95	20.47	23.98	22.15

11N40MIMO	5230	Ant1	10.25	0.82	11.07	13.88	23.98	22.15
11N40MIMO	5230	Ant2	10.53	0.86	11.39	16.8	23.98	22.15
11N40MIMO	5230	Ant1+Ant2	13.4	---	14.24	18.59	23.98	22.15
11AC20MIMO	5180	Ant1	11.8	0.55	12.35	15.16	23.98	22.15
11AC20MIMO	5180	Ant2	13.14	0.58	13.72	19.13	23.98	22.15
11AC20MIMO	5180	Ant1+Ant2	15.53	---	16.10	20.59	23.98	22.15
11AC20MIMO	5200	Ant1	11.98	0.55	12.53	15.34	23.98	22.15
11AC20MIMO	5200	Ant2	13.39	0.58	13.97	19.38	23.98	22.15
11AC20MIMO	5200	Ant1+Ant2	15.75	---	16.32	20.82	23.98	22.15
11AC20MIMO	5240	Ant1	10.6	0.58	11.18	13.99	23.98	22.15
11AC20MIMO	5240	Ant2	10.68	0.55	11.23	16.64	23.98	22.15
11AC20MIMO	5240	Ant1+Ant2	13.65	---	14.22	18.52	23.98	22.15
11AC40MIMO	5190	Ant1	11.27	0.94	12.21	15.02	23.98	22.15
11AC40MIMO	5190	Ant2	12.83	0.94	13.77	19.18	23.98	22.15
11AC40MIMO	5190	Ant1+Ant2	15.13	---	16.07	20.59	23.98	22.15
11AC40MIMO	5230	Ant1	9.96	0.98	10.94	13.75	23.98	22.15
11AC40MIMO	5230	Ant2	10.86	0.94	11.80	17.21	23.98	22.15
11AC40MIMO	5230	Ant1+Ant2	13.44	---	14.40	18.83	23.98	22.15
11AC80MIMO	5210	Ant1	9.27	1.48	10.75	13.56	23.98	22.15
11AC80MIMO	5210	Ant2	10.77	1.48	12.25	17.66	23.98	22.15
11AC80MIMO	5210	Ant1+Ant2	13.09	---	14.57	19.09	23.98	22.15
11AMIMO	5180	Ant1	11.29	0.44	11.73	14.54	23.98	22.15
11AMIMO	5180	Ant2	12.6	0.46	13.06	18.47	23.98	22.15
11AMIMO	5180	Ant1+Ant2	15	---	15.46	19.95	23.98	22.15
11AMIMO	5200	Ant1	11.56	0.44	12.00	14.81	23.98	22.15
11AMIMO	5200	Ant2	13.03	0.44	13.47	18.88	23.98	22.15
11AMIMO	5200	Ant1+Ant2	15.37	---	15.81	20.32	23.98	22.15
11AMIMO	5240	Ant1	10.23	0.46	10.69	13.5	23.98	22.15
11AMIMO	5240	Ant2	10.43	0.46	10.89	16.3	23.98	22.15
11AMIMO	5240	Ant1+Ant2	13.34	---	13.80	18.13	23.98	22.15

**(5250-5350, 5470-5725, 5725-5850)**

Test Mode	Test Channel	Ant	Level [dBm]	10log(1/x) Factor [dB]	Power [dBm]	Limit [dBm]	Verdict
11N20MIMO	5260	Ant1	10.78	0.50	11.28	23.78	PASS
11N20MIMO	5260	Ant2	11	0.50	11.50	23.79	PASS
11N20MIMO	5260	Ant1+Ant2	13.9	---	14.40	23.79	PASS
11N20MIMO	5280	Ant1	12.44	0.48	12.92	23.98	PASS
11N20MIMO	5280	Ant2	11.59	0.50	12.09	23.98	PASS
11N20MIMO	5280	Ant1+Ant2	15.05	---	15.54	23.98	PASS
11N20MIMO	5320	Ant1	12.96	0.50	13.46	23.98	PASS

11N20MIMO	5320	Ant2	11.93	0.48	12.41	23.98	PASS
11N20MIMO	5320	Ant1+Ant2	15.49	---	15.98	23.98	PASS
11N20MIMO	5500	Ant1	10.31	0.50	10.81	23.98	PASS
11N20MIMO	5500	Ant2	11.37	0.48	11.85	23.98	PASS
11N20MIMO	5500	Ant1+Ant2	13.88	---	14.37	23.98	PASS
11N20MIMO	5580	Ant1	11.03	0.50	11.53	23.80	PASS
11N20MIMO	5580	Ant2	11.34	0.50	11.84	23.79	PASS
11N20MIMO	5580	Ant1+Ant2	14.2	---	14.70	23.79	PASS
11N20MIMO	5700	Ant1	9.97	0.50	10.47	23.98	PASS
11N20MIMO	5700	Ant2	8.63	0.50	9.13	23.98	PASS
11N20MIMO	5700	Ant1+Ant2	12.36	---	12.86	23.98	PASS
11N20MIMO	5745	Ant1	8.72	0.50	9.22	30.00	PASS
11N20MIMO	5745	Ant2	7.93	0.50	8.43	30.00	PASS
11N20MIMO	5745	Ant1+Ant2	11.35	---	11.85	30.00	PASS
11N20MIMO	5785	Ant1	9.4	0.50	9.90	30.00	PASS
11N20MIMO	5785	Ant2	9.66	0.50	10.16	30.00	PASS
11N20MIMO	5785	Ant1+Ant2	12.54	---	13.04	30.00	PASS
11N20MIMO	5825	Ant1	9.51	0.50	10.01	30.00	PASS
11N20MIMO	5825	Ant2	10.13	0.48	10.61	30.00	PASS
11N20MIMO	5825	Ant1+Ant2	12.84	---	13.33	30.00	PASS
11N40MIMO	5270	Ant1	10.03	0.82	10.85	23.98	PASS
11N40MIMO	5270	Ant2	9.35	0.86	10.21	23.98	PASS
11N40MIMO	5270	Ant1+Ant2	12.71	---	13.55	23.98	PASS
11N40MIMO	5310	Ant1	12.39	0.82	13.21	23.98	PASS
11N40MIMO	5310	Ant2	11.56	0.86	12.42	23.98	PASS
11N40MIMO	5310	Ant1+Ant2	15.01	---	15.84	23.98	PASS
11N40MIMO	5510	Ant1	9	0.82	9.82	23.98	PASS
11N40MIMO	5510	Ant2	10.08	0.86	10.94	23.98	PASS
11N40MIMO	5510	Ant1+Ant2	12.58	---	13.43	23.98	PASS
11N40MIMO	5550	Ant1	10.11	0.86	10.97	23.98	PASS
11N40MIMO	5550	Ant2	11.07	0.86	11.93	23.98	PASS
11N40MIMO	5550	Ant1+Ant2	13.63	---	14.49	23.98	PASS
11N40MIMO	5670	Ant1	10.42	0.86	11.28	23.98	PASS
11N40MIMO	5670	Ant2	9.59	0.82	10.41	23.98	PASS
11N40MIMO	5670	Ant1+Ant2	13.04	---	13.88	23.98	PASS
11N40MIMO	5755	Ant1	8.46	0.82	9.28	30.00	PASS
11N40MIMO	5755	Ant2	7.89	0.86	8.75	30.00	PASS
11N40MIMO	5755	Ant1+Ant2	11.19	---	12.03	30.00	PASS
11N40MIMO	5795	Ant1	9.28	0.82	10.10	30.00	PASS
11N40MIMO	5795	Ant2	9.93	0.86	10.79	30.00	PASS

11N40MIMO	5795	Ant1+Ant2	12.63	---	13.47	30.00	PASS
11AC20MIMO	5260	Ant1	11.16	0.58	11.74	23.77	PASS
11AC20MIMO	5260	Ant2	10.51	0.58	11.09	23.73	PASS
11AC20MIMO	5260	Ant1+Ant2	13.86	---	14.44	23.73	PASS
11AC20MIMO	5280	Ant1	12.7	0.58	13.28	23.98	PASS
11AC20MIMO	5280	Ant2	11.82	0.58	12.40	23.98	PASS
11AC20MIMO	5280	Ant1+Ant2	15.29	---	15.87	23.98	PASS
11AC20MIMO	5320	Ant1	13.18	0.58	13.76	23.98	PASS
11AC20MIMO	5320	Ant2	12.52	0.58	13.10	23.98	PASS
11AC20MIMO	5320	Ant1+Ant2	15.87	---	16.45	23.98	PASS
11AC20MIMO	5500	Ant1	10.63	0.57	11.20	23.98	PASS
11AC20MIMO	5500	Ant2	11.85	0.58	12.43	23.98	PASS
11AC20MIMO	5500	Ant1+Ant2	14.29	---	14.87	23.98	PASS
11AC20MIMO	5580	Ant1	11.27	0.58	11.85	23.78	PASS
11AC20MIMO	5580	Ant2	11.8	0.55	12.35	23.76	PASS
11AC20MIMO	5580	Ant1+Ant2	14.55	---	15.12	23.76	PASS
11AC20MIMO	5700	Ant1	9.93	0.58	10.51	23.98	PASS
11AC20MIMO	5700	Ant2	7.87	0.55	8.42	23.98	PASS
11AC20MIMO	5700	Ant1+Ant2	12.03	---	12.60	23.98	PASS
11AC20MIMO	5745	Ant1	8.43	0.55	8.98	30.00	PASS
11AC20MIMO	5745	Ant2	7.42	0.58	8.00	30.00	PASS
11AC20MIMO	5745	Ant1+Ant2	10.96	---	11.53	30.00	PASS
11AC20MIMO	5785	Ant1	10.16	0.55	10.71	30.00	PASS
11AC20MIMO	5785	Ant2	9.98	0.58	10.56	30.00	PASS
11AC20MIMO	5785	Ant1+Ant2	13.08	---	13.65	30.00	PASS
11AC20MIMO	5825	Ant1	10.02	0.55	10.57	30.00	PASS
11AC20MIMO	5825	Ant2	10.45	0.58	11.03	30.00	PASS
11AC20MIMO	5825	Ant1+Ant2	13.25	---	13.82	30.00	PASS
11AC40MIMO	5270	Ant1	10.04	0.98	11.02	23.98	PASS
11AC40MIMO	5270	Ant2	9.89	0.98	10.87	23.98	PASS
11AC40MIMO	5270	Ant1+Ant2	12.98	---	13.96	23.98	PASS
11AC40MIMO	5310	Ant1	12.4	0.94	13.34	23.98	PASS
11AC40MIMO	5310	Ant2	12.09	0.94	13.03	23.98	PASS
11AC40MIMO	5310	Ant1+Ant2	15.26	---	16.20	23.98	PASS
11AC40MIMO	5510	Ant1	9.18	0.94	10.12	23.98	PASS
11AC40MIMO	5510	Ant2	10.21	0.98	11.19	23.98	PASS
11AC40MIMO	5510	Ant1+Ant2	12.74	---	13.70	23.98	PASS
11AC40MIMO	5550	Ant1	9.84	0.94	10.78	23.98	PASS
11AC40MIMO	5550	Ant2	11.42	0.94	12.36	23.98	PASS
11AC40MIMO	5550	Ant1+Ant2	13.71	---	14.65	23.98	PASS

11AC40MIMO	5670	Ant1	10.93	0.94	11.87	23.98	PASS
11AC40MIMO	5670	Ant2	9.82	0.94	10.76	23.98	PASS
11AC40MIMO	5670	Ant1+Ant2	13.42	---	14.36	23.98	PASS
11AC40MIMO	5755	Ant1	8.56	0.94	9.50	30.00	PASS
11AC40MIMO	5755	Ant2	8.17	0.97	9.14	30.00	PASS
11AC40MIMO	5755	Ant1+Ant2	11.38	---	12.33	30.00	PASS
11AC40MIMO	5795	Ant1	10.05	0.98	11.03	30.00	PASS
11AC40MIMO	5795	Ant2	9.5	0.98	10.48	30.00	PASS
11AC40MIMO	5795	Ant1+Ant2	12.79	---	13.77	30.00	PASS
11AC80MIMO	5290	Ant1	10.19	1.46	11.65	23.98	PASS
11AC80MIMO	5290	Ant2	7.3	1.46	8.76	23.98	PASS
11AC80MIMO	5290	Ant1+Ant2	11.99	---	13.45	23.98	PASS
11AC80MIMO	5530	Ant1	9.32	1.46	10.78	23.98	PASS
11AC80MIMO	5530	Ant2	9.25	1.46	10.71	23.98	PASS
11AC80MIMO	5530	Ant1+Ant2	12.3	---	13.76	23.98	PASS
11AC80MIMO	5775	Ant1	8.16	1.48	9.64	30.00	PASS
11AC80MIMO	5775	Ant2	6.87	1.46	8.33	30.00	PASS
11AC80MIMO	5775	Ant1+Ant2	10.57	---	12.04	30.00	PASS
11AMIMO	5260	Ant1	10.85	0.46	11.31	23.69	PASS
11AMIMO	5260	Ant2	10.49	0.46	10.95	23.70	PASS
11AMIMO	5260	Ant1+Ant2	13.68	---	14.14	23.70	PASS
11AMIMO	5280	Ant1	12.44	0.44	12.88	23.98	PASS
11AMIMO	5280	Ant2	11.67	0.44	12.11	23.98	PASS
11AMIMO	5280	Ant1+Ant2	15.08	---	15.52	23.98	PASS
11AMIMO	5320	Ant1	12.63	0.46	13.09	23.98	PASS
11AMIMO	5320	Ant2	12.16	0.46	12.62	23.98	PASS
11AMIMO	5320	Ant1+Ant2	15.41	---	15.87	23.98	PASS
11AMIMO	5500	Ant1	9.75	0.46	10.21	23.98	PASS
11AMIMO	5500	Ant2	10.95	0.46	11.41	23.98	PASS
11AMIMO	5500	Ant1+Ant2	13.4	---	13.86	23.98	PASS
11AMIMO	5580	Ant1	10.65	0.44	11.09	23.64	PASS
11AMIMO	5580	Ant2	11.23	0.46	11.69	23.70	PASS
11AMIMO	5580	Ant1+Ant2	13.96	---	14.41	23.70	PASS
11AMIMO	5700	Ant1	9.53	0.44	9.97	23.98	PASS
11AMIMO	5700	Ant2	8.27	0.44	8.71	23.98	PASS
11AMIMO	5700	Ant1+Ant2	11.96	---	12.40	23.98	PASS
11AMIMO	5745	Ant1	8.5	0.46	8.96	30.00	PASS
11AMIMO	5745	Ant2	7.77	0.44	8.21	30.00	PASS
11AMIMO	5745	Ant1+Ant2	11.16	---	11.61	30.00	PASS
11AMIMO	5785	Ant1	8.88	0.44	9.32	30.00	PASS

11AMIMO	5785	Ant2	9.12	0.46	9.58	30.00	PASS
11AMIMO	5785	Ant1+Ant2	12.01	---	12.46	30.00	PASS
11AMIMO	5825	Ant1	8.92	0.44	9.36	30.00	PASS
11AMIMO	5825	Ant2	9.49	0.46	9.95	30.00	PASS
11AMIMO	5825	Ant1+Ant2	12.22	---	12.68	30.00	PASS

## 7. Power Spectral Density

### 7.1. Block diagram of test setup

Same with 4.1

### 7.2. Limits

FCC Part15, Subpart E/ RSS-247		
Test Item	Limit	Frequency Range (MHz)
Power Spectral Density	For FCC: Other then Mobile and portable: 17dBm/MHz Mobile and portable: 11dBm/MHz	5150-5250
	For RSS eirp: 10dBm/MHz	
	11dBm/MHz	5250-5350
	11dBm/MHz	For FCC: 5470-5725 For IC: 5470-5600 5650-5725
	30dBm/500kHz	5725-5850

### 7.3. Test Procedure

The transmitter output was connected to a spectrum analyzer. Power density was measured by spectrum analyzer with 1MHz RBW and 3MHz VBW.

Connect the UUT to the spectrum analyser and use the following settings:

5150MHz~5250MHz, 5250MHz~5350MHz, 5470MHz~5725MHz

Center Frequency	The centre frequency of the channel under test
Detector	RMS
RBW	1MHz
VBW	$\geq 3 \times \text{RBW}$
Span	Encompass the entire emissions bandwidth (EBW) of the signal
Trace	Max hold
Sweep time	Auto

5725MHz-5850MHz

Center Frequency	The centre frequency of the channel under test
Detector	RMS
RBW	500KHz
VBW	$\geq 3 \times \text{RBW}$
Span	Encompass the entire emissions bandwidth (EBW) of the signal
Trace	Max hold
Sweep time	Auto

Note:

1. For UNII-3, according to KDB publication 789033 D02 General UNII Test Procedures New Rules v01, section

II.F.5., it is acceptable to set RBW at 1MHz and VBW at 3MHz if the spectrum analyzer does not have 500kHz RBW.

2. The value measured with RBW=1MHz is to be added with  $10\log(500\text{kHz}/1\text{MHz})$  which is - 3dB. For example, if the measured value is +10dBm using RBW=1MHz (that is +10dBm/MHz), then the converted value will be +7dBm/500kHz.

Allow trace to fully stabilize and use the peak marker function to determine the maximum amplitude level within the RBW.

## 7.4. Test Result

(5150-5250)

Test Mode	Test Channel	Ant	Level [dBm/MHz]	$10\log(1/x)$ Factor [dB]	PSD [dBm/MHz]	PSD eirp [dBm/MHz]	FCC Limit [dBm/MHz]	ISED Limit [dBm/MHz]
11N20MIMO	5180	Ant1	0.65	0.50	1.15	3.96	11.00	10.00
11N20MIMO	5180	Ant2	2.39	0.50	2.89	8.30	11.00	10.00
11N20MIMO	5180	Ant1+Ant2	4.62	---	5.12	9.66	11.00	10.00
11N20MIMO	5200	Ant1	1.36	0.48	1.84	4.65	11.00	10.00
11N20MIMO	5200	Ant2	2.00	0.48	2.48	7.89	11.00	10.00
11N20MIMO	5200	Ant1+Ant2	5.30	---	5.78	9.58	11.00	10.00
11N20MIMO	5240	Ant1	-0.03	0.48	0.45	3.26	11.00	10.00
11N20MIMO	5240	Ant2	-0.14	0.50	0.36	5.77	11.00	10.00
11N20MIMO	5240	Ant1+Ant2	2.93	---	3.42	7.70	11.00	10.00
11N40MIMO	5190	Ant1	-2.59	0.83	-1.76	1.05	11.00	10.00
11N40MIMO	5190	Ant2	-1.10	0.82	-0.28	5.13	11.00	10.00
11N40MIMO	5190	Ant1+Ant2	1.23	---	2.05	6.56	11.00	10.00
11N40MIMO	5230	Ant1	-3.32	0.82	-2.50	0.31	11.00	10.00
11N40MIMO	5230	Ant2	-3.02	0.86	-2.16	3.25	11.00	10.00
11N40MIMO	5230	Ant1+Ant2	-0.16	---	0.68	5.03	11.00	10.00
11AC20MIMO	5180	Ant1	1.51	0.55	2.06	4.87	11.00	10.00
11AC20MIMO	5180	Ant2	1.48	0.58	2.06	7.47	11.00	10.00
11AC20MIMO	5180	Ant1+Ant2	5.09	---	5.66	9.37	11.00	10.00
11AC20MIMO	5200	Ant1	1.66	0.55	2.21	5.02	11.00	10.00
11AC20MIMO	5200	Ant2	1.54	0.58	2.12	7.53	11.00	10.00
11AC20MIMO	5200	Ant1+Ant2	5.26	---	5.83	9.46	11.00	10.00
11AC20MIMO	5240	Ant1	0.21	0.58	0.79	3.60	11.00	10.00
11AC20MIMO	5240	Ant2	0.13	0.55	0.68	6.09	11.00	10.00
11AC20MIMO	5240	Ant1+Ant2	3.18	---	3.75	8.03	11.00	10.00
11AC40MIMO	5190	Ant1	-2.25	0.94	-1.31	1.50	11.00	10.00
11AC40MIMO	5190	Ant2	-0.67	0.94	0.27	5.68	11.00	10.00
11AC40MIMO	5190	Ant1+Ant2	1.62	---	2.56	7.08	11.00	10.00
11AC40MIMO	5230	Ant1	-3.56	0.98	-2.58	0.23	11.00	10.00



11AC40MIMO	5230	Ant2	-2.56	0.94	-1.62	3.79	11.00	10.00
11AC40MIMO	5230	Ant1+Ant2	-0.02	---	0.94	5.38	11.00	10.00
11AC80MIMO	5210	Ant1	-7.08	1.48	-5.60	-2.79	11.00	10.00
11AC80MIMO	5210	Ant2	-5.42	1.48	-3.94	1.47	11.00	10.00
11AC80MIMO	5210	Ant1+Ant2	-3.16	---	-1.68	2.85	11.00	10.00
11AMIMO	5180	Ant1	0.65	0.44	1.09	3.90	11.00	10.00
11AMIMO	5180	Ant2	2.72	0.46	3.18	8.59	11.00	10.00
11AMIMO	5180	Ant1+Ant2	4.82	---	5.27	9.86	11.00	10.00
11AMIMO	5200	Ant1	1.02	0.44	1.46	4.27	11.00	10.00
11AMIMO	5200	Ant2	2.00	0.44	2.44	7.85	11.00	10.00
11AMIMO	5200	Ant1+Ant2	5.12	---	5.56	9.43	11.00	10.00
11AMIMO	5240	Ant1	-0.46	0.46	0.00	2.81	11.00	10.00
11AMIMO	5240	Ant2	0.04	0.46	0.50	5.91	11.00	10.00
11AMIMO	5240	Ant1+Ant2	2.81	---	3.27	7.64	11.00	10.00

**(5250-5350, 5470-5725, 5725-5850)**

Test Mode	Test Channel	Ant	Level [dBm/MHz]	10log(1/x) Factor [dB]	PSD [dBm/MHz]	Limit [dBm/MHz]	Verdict
11N20MIMO	5260	Ant1	-0.17	0.50	0.33	11.00	PASS
11N20MIMO	5260	Ant2	0.26	0.50	0.76	11.00	PASS
11N20MIMO	5260	Ant1+Ant2	3.06	---	3.56	11.00	PASS
11N20MIMO	5280	Ant1	1.96	0.48	2.44	11.00	PASS
11N20MIMO	5280	Ant2	0.75	0.50	1.25	11.00	PASS
11N20MIMO	5280	Ant1+Ant2	4.41	---	4.90	11.00	PASS
11N20MIMO	5320	Ant1	1.98	0.50	2.48	11.00	PASS
11N20MIMO	5320	Ant2	1.03	0.48	1.51	11.00	PASS
11N20MIMO	5320	Ant1+Ant2	4.54	---	5.03	11.00	PASS
11N20MIMO	5500	Ant1	-0.55	0.50	-0.05	11.00	PASS
11N20MIMO	5500	Ant2	0.49	0.48	0.97	11.00	PASS
11N20MIMO	5500	Ant1+Ant2	3.01	---	3.50	11.00	PASS
11N20MIMO	5580	Ant1	0.22	0.50	0.72	11.00	PASS
11N20MIMO	5580	Ant2	0.70	0.50	1.20	11.00	PASS
11N20MIMO	5580	Ant1+Ant2	3.48	---	3.98	11.00	PASS
11N20MIMO	5700	Ant1	-0.72	0.50	-0.22	11.00	PASS
11N20MIMO	5700	Ant2	-2.27	0.50	-1.77	11.00	PASS
11N20MIMO	5700	Ant1+Ant2	1.58	---	2.08	11.00	PASS
11N40MIMO	5270	Ant1	-3.67	0.82	-2.85	11.00	PASS
11N40MIMO	5270	Ant2	-4.38	0.86	-3.52	11.00	PASS
11N40MIMO	5270	Ant1+Ant2	-1.00	---	-0.16	11.00	PASS

11N40MIMO	5310	Ant1	-1.21	0.82	-0.39	11.00	PASS
11N40MIMO	5310	Ant2	-2.14	0.86	-1.28	11.00	PASS
11N40MIMO	5310	Ant1+Ant2	1.36	---	2.20	11.00	PASS
11N40MIMO	5510	Ant1	-4.41	0.82	-3.59	11.00	PASS
11N40MIMO	5510	Ant2	-3.52	0.86	-2.66	11.00	PASS
11N40MIMO	5510	Ant1+Ant2	-0.93	---	-0.09	11.00	PASS
11N40MIMO	5550	Ant1	-2.90	0.86	-2.04	11.00	PASS
11N40MIMO	5550	Ant2	-2.61	0.86	-1.75	11.00	PASS
11N40MIMO	5550	Ant1+Ant2	0.26	---	1.12	11.00	PASS
11N40MIMO	5670	Ant1	-3.29	0.86	-2.43	11.00	PASS
11N40MIMO	5670	Ant2	-3.80	0.82	-2.98	11.00	PASS
11N40MIMO	5670	Ant1+Ant2	-0.53	---	0.31	11.00	PASS
11AC20MIMO	5260	Ant1	0.70	0.58	1.28	11.00	PASS
11AC20MIMO	5260	Ant2	0.23	0.58	0.81	11.00	PASS
11AC20MIMO	5260	Ant1+Ant2	3.48	---	4.06	11.00	PASS
11AC20MIMO	5280	Ant1	2.18	0.58	2.76	11.00	PASS
11AC20MIMO	5280	Ant2	1.30	0.58	1.88	11.00	PASS
11AC20MIMO	5280	Ant1+Ant2	4.77	---	5.35	11.00	PASS
11AC20MIMO	5320	Ant1	2.36	0.58	2.94	11.00	PASS
11AC20MIMO	5320	Ant2	1.68	0.58	2.26	11.00	PASS
11AC20MIMO	5320	Ant1+Ant2	5.04	---	5.62	11.00	PASS
11AC20MIMO	5500	Ant1	-0.13	0.57	0.44	11.00	PASS
11AC20MIMO	5500	Ant2	0.86	0.58	1.44	11.00	PASS
11AC20MIMO	5500	Ant1+Ant2	3.40	---	3.98	11.00	PASS
11AC20MIMO	5580	Ant1	0.64	0.58	1.22	11.00	PASS
11AC20MIMO	5580	Ant2	1.11	0.55	1.66	11.00	PASS
11AC20MIMO	5580	Ant1+Ant2	3.89	---	4.46	11.00	PASS
11AC20MIMO	5700	Ant1	-0.49	0.58	0.09	11.00	PASS
11AC20MIMO	5700	Ant2	-3.06	0.55	-2.51	11.00	PASS
11AC20MIMO	5700	Ant1+Ant2	1.42	---	1.99	11.00	PASS
11AC40MIMO	5270	Ant1	-3.89	0.98	-2.91	11.00	PASS
11AC40MIMO	5270	Ant2	-3.86	0.98	-2.88	11.00	PASS
11AC40MIMO	5270	Ant1+Ant2	-0.86	---	0.12	11.00	PASS
11AC40MIMO	5310	Ant1	-1.23	0.94	-0.29	11.00	PASS
11AC40MIMO	5310	Ant2	-1.62	0.94	-0.68	11.00	PASS
11AC40MIMO	5310	Ant1+Ant2	1.59	---	2.53	11.00	PASS
11AC40MIMO	5510	Ant1	-4.24	0.94	-3.30	11.00	PASS
11AC40MIMO	5510	Ant2	-3.45	0.98	-2.47	11.00	PASS
11AC40MIMO	5510	Ant1+Ant2	-0.82	---	0.15	11.00	PASS
11AC40MIMO	5550	Ant1	-3.94	0.94	-3.00	11.00	PASS

11AC40MIMO	5550	Ant2	-1.69	0.94	-0.75	11.00	PASS
11AC40MIMO	5550	Ant1+Ant2	0.34	---	1.28	11.00	PASS
11AC40MIMO	5670	Ant1	-2.24	0.94	-1.30	11.00	PASS
11AC40MIMO	5670	Ant2	-3.61	0.94	-2.67	11.00	PASS
11AC40MIMO	5670	Ant1+Ant2	0.14	---	1.08	11.00	PASS
11AC80MIMO	5290	Ant1	-6.25	1.46	-4.79	11.00	PASS
11AC80MIMO	5290	Ant2	-9.37	1.46	-7.91	11.00	PASS
11AC80MIMO	5290	Ant1+Ant2	-4.53	---	-3.07	11.00	PASS
11AC80MIMO	5530	Ant1	-6.70	1.46	-5.24	11.00	PASS
11AC80MIMO	5530	Ant2	-7.16	1.46	-5.70	11.00	PASS
11AC80MIMO	5530	Ant1+Ant2	-3.91	---	-2.45	11.00	PASS
11AMIMO	5260	Ant1	0.25	0.46	0.71	11.00	PASS
11AMIMO	5260	Ant2	0.32	0.46	0.78	11.00	PASS
11AMIMO	5260	Ant1+Ant2	3.30	---	3.76	11.00	PASS
11AMIMO	5280	Ant1	1.71	0.44	2.15	11.00	PASS
11AMIMO	5280	Ant2	1.53	0.44	1.97	11.00	PASS
11AMIMO	5280	Ant1+Ant2	4.63	---	5.07	11.00	PASS
11AMIMO	5320	Ant1	1.90	0.46	2.36	11.00	PASS
11AMIMO	5320	Ant2	2.19	0.46	2.65	11.00	PASS
11AMIMO	5320	Ant1+Ant2	5.06	---	5.52	11.00	PASS
11AMIMO	5500	Ant1	-1.12	0.46	-0.66	11.00	PASS
11AMIMO	5500	Ant2	0.68	0.46	1.14	11.00	PASS
11AMIMO	5500	Ant1+Ant2	2.88	---	3.34	11.00	PASS
11AMIMO	5580	Ant1	0.03	0.44	0.47	11.00	PASS
11AMIMO	5580	Ant2	1.06	0.46	1.52	11.00	PASS
11AMIMO	5580	Ant1+Ant2	3.59	---	4.04	11.00	PASS
11AMIMO	5700	Ant1	-0.40	0.44	0.04	11.00	PASS
11AMIMO	5700	Ant2	-1.99	0.44	-1.55	11.00	PASS
11AMIMO	5700	Ant1+Ant2	1.89	---	2.33	11.00	PASS

Test Mode	Test Channel	Ant	Level [dBm/500kHz]	10log(1/x) Factor[dB]	10log(500kHz/RBW) Factor [dB]	PSD [dBm/500kHz]	Limit [dBm/500kHz]	Verdict
11N20MIMO	5745	Ant1	-4.22	0.50	0.00	-3.72	17.00	PASS
11N20MIMO	5745	Ant2	-4.53	0.50	0.00	-4.03	17.00	PASS
11N20MIMO	5745	Ant1+Ant2	-1.36	---	---	-0.86	17.00	PASS
11N20MIMO	5785	Ant1	-3.64	0.50	0.00	-3.14	17.00	PASS
11N20MIMO	5785	Ant2	-3.29	0.50	0.00	-2.79	17.00	PASS
11N20MIMO	5785	Ant1+Ant2	-0.45	---	---	0.05	17.00	PASS
11N20MIMO	5825	Ant1	-3.26	0.50	0.00	-2.76	17.00	PASS
11N20MIMO	5825	Ant2	-2.64	0.48	0.00	-2.16	17.00	PASS

11N20MIMO	5825	Ant1+Ant2	0.07	---	---	0.56	17.00	PASS
11N40MIMO	5755	Ant1	-7.35	0.82	0.00	-6.53	17.00	PASS
11N40MIMO	5755	Ant2	-7.71	0.86	0.00	-6.85	17.00	PASS
11N40MIMO	5755	Ant1+Ant2	-4.52	---	---	-3.68	17.00	PASS
11N40MIMO	5795	Ant1	-6.87	0.82	0.00	-6.05	17.00	PASS
11N40MIMO	5795	Ant2	-5.86	0.86	0.00	-5.00	17.00	PASS
11N40MIMO	5795	Ant1+Ant2	-3.33	---	---	-2.48	17.00	PASS
11AC20MIMO	5745	Ant1	-4.55	0.55	0.00	-4.00	17.00	PASS
11AC20MIMO	5745	Ant2	-5.56	0.58	0.00	-4.98	17.00	PASS
11AC20MIMO	5745	Ant1+Ant2	-2.02	---	---	-1.45	17.00	PASS
11AC20MIMO	5785	Ant1	-2.85	0.55	0.00	-2.30	17.00	PASS
11AC20MIMO	5785	Ant2	-2.82	0.58	0.00	-2.24	17.00	PASS
11AC20MIMO	5785	Ant1+Ant2	0.18	---	---	0.74	17.00	PASS
11AC20MIMO	5825	Ant1	-2.78	0.55	0.00	-2.23	17.00	PASS
11AC20MIMO	5825	Ant2	-2.44	0.58	0.00	-1.86	17.00	PASS
11AC20MIMO	5825	Ant1+Ant2	0.40	---	---	0.97	17.00	PASS
11AC40MIMO	5755	Ant1	-7.23	0.94	0.00	-6.29	17.00	PASS
11AC40MIMO	5755	Ant2	-7.36	0.97	0.00	-6.39	17.00	PASS
11AC40MIMO	5755	Ant1+Ant2	-4.28	---	---	-3.33	17.00	PASS
11AC40MIMO	5795	Ant1	-5.57	0.98	0.00	-4.59	17.00	PASS
11AC40MIMO	5795	Ant2	-6.20	0.98	0.00	-5.22	17.00	PASS
11AC40MIMO	5795	Ant1+Ant2	-2.86	---	---	-1.88	17.00	PASS
11AC80MIMO	5775	Ant1	-10.67	1.48	0.00	-9.19	17.00	PASS
11AC80MIMO	5775	Ant2	-11.30	1.46	0.00	-9.84	17.00	PASS
11AC80MIMO	5775	Ant1+Ant2	-7.96	---	---	-6.49	17.00	PASS
11AMIMO	5745	Ant1	-3.95	0.46	0.00	-3.49	17.00	PASS
11AMIMO	5745	Ant2	-4.53	0.44	0.00	-4.09	17.00	PASS
11AMIMO	5745	Ant1+Ant2	-1.22	---	---	-0.77	17.00	PASS
11AMIMO	5785	Ant1	-3.47	0.44	0.00	-3.03	17.00	PASS
11AMIMO	5785	Ant2	-3.25	0.46	0.00	-2.79	17.00	PASS
11AMIMO	5785	Ant1+Ant2	-0.35	---	---	0.10	17.00	PASS
11AMIMO	5825	Ant1	-3.48	0.44	0.00	-3.04	17.00	PASS
11AMIMO	5825	Ant2	-2.82	0.46	0.00	-2.36	17.00	PASS
11AMIMO	5825	Ant1+Ant2	-0.13	---	---	0.32	17.00	PASS

### 7.5. Original test data

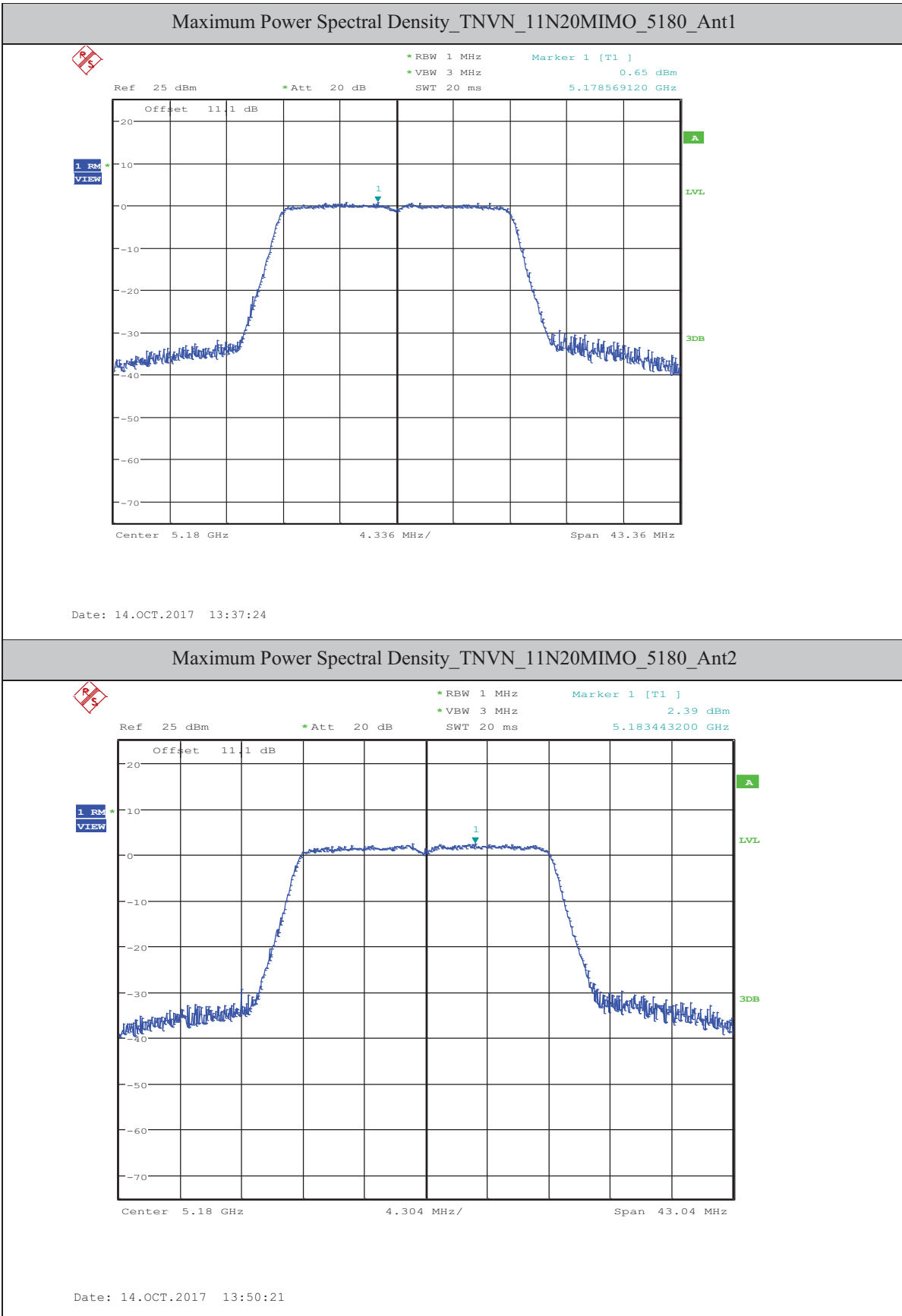

### Maximum Power Spectral Density\_TNVN\_11N20MIMO\_5200\_Ant1

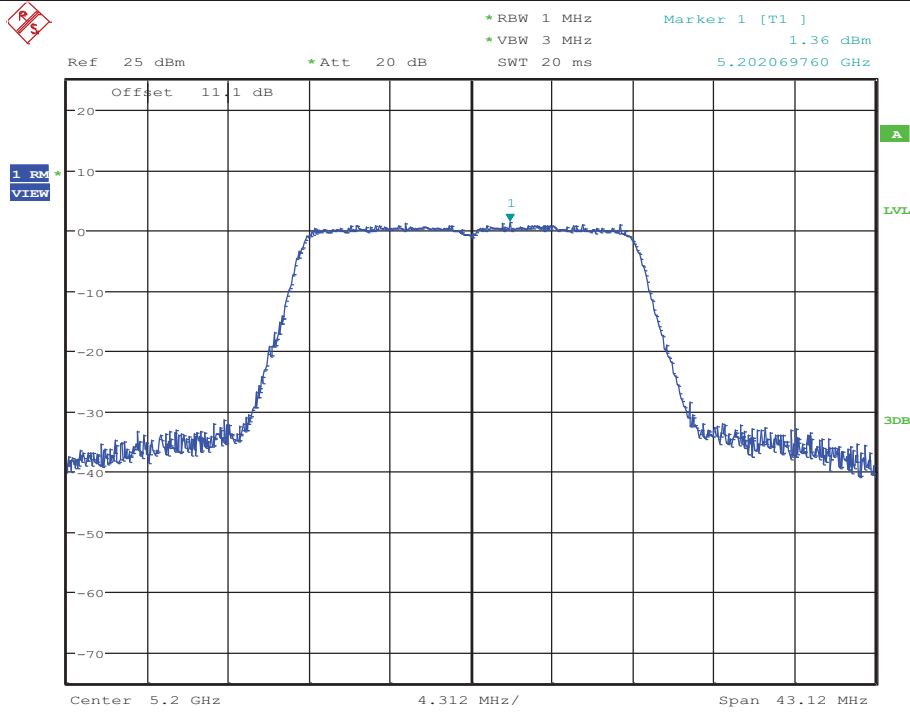

Date: 14.OCT.2017 13:56:54

### Maximum Power Spectral Density\_TNVN\_11N20MIMO\_5200\_Ant2

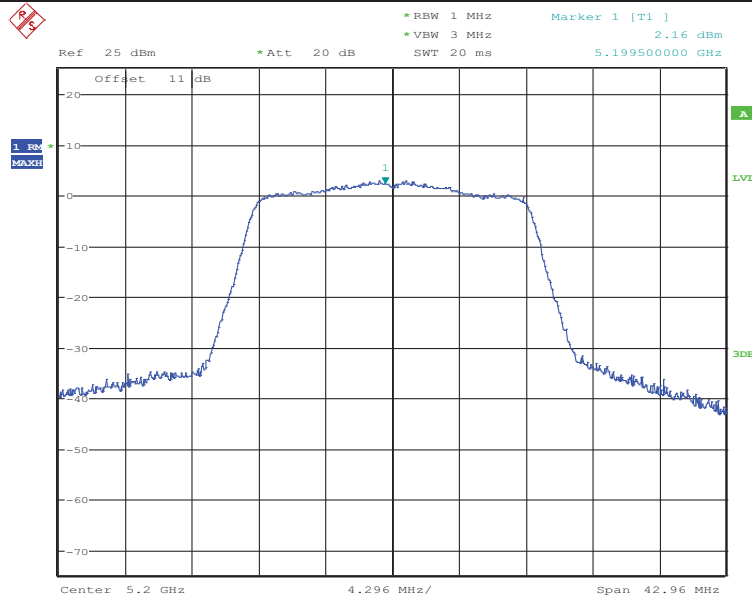

Date: 14.OCT.2017 15:38:41

Maximum Power Spectral Density\_TNVN\_11N20MIMO\_5240\_Ant1

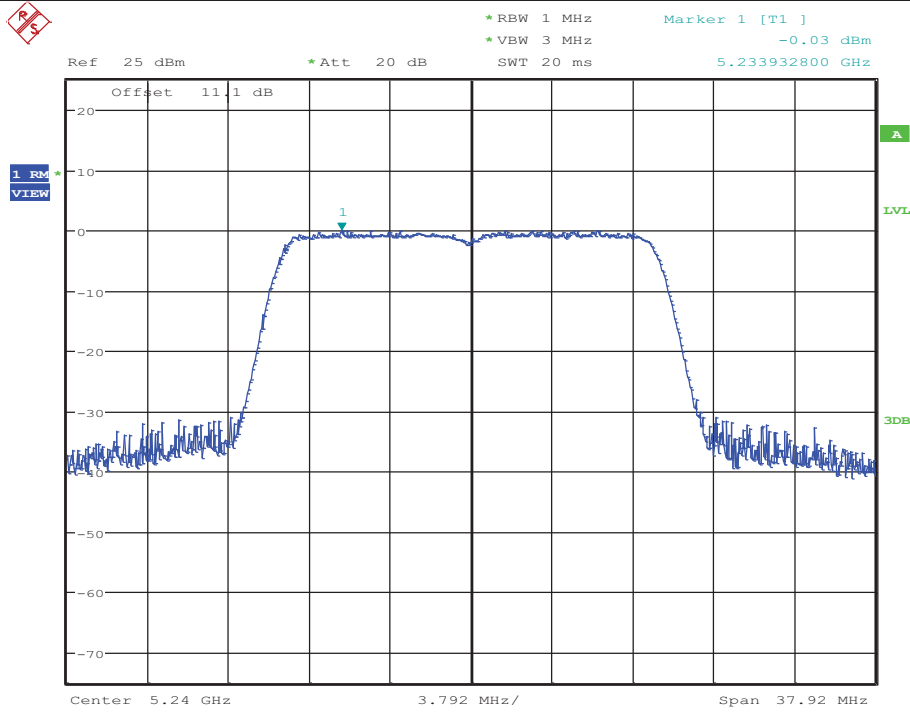

Date: 14.OCT.2017 14:10:41

Maximum Power Spectral Density\_TNVN\_11N20MIMO\_5240\_Ant2

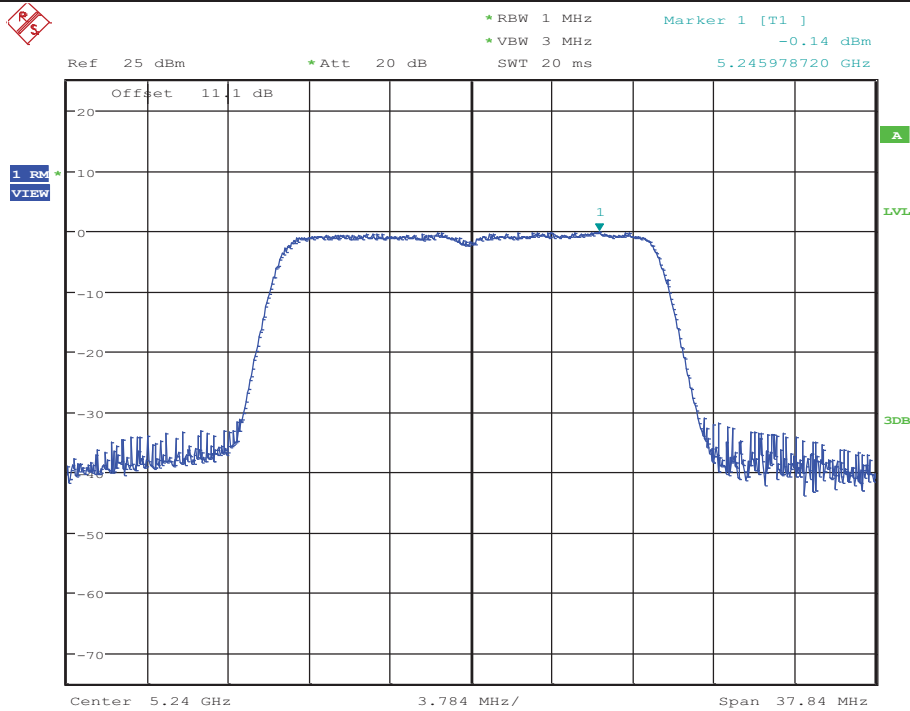

Date: 14.OCT.2017 14:17:23

### Maximum Power Spectral Density\_TNVN\_11N20MIMO\_5260\_Ant1

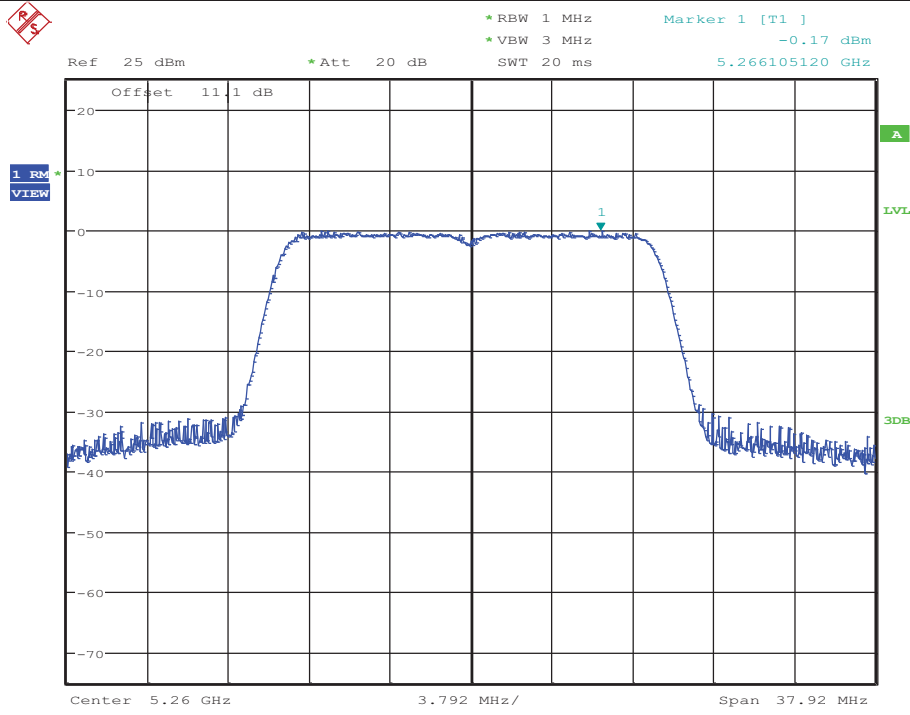

Date: 14.OCT.2017 16:06:56

### Maximum Power Spectral Density\_TNVN\_11N20MIMO\_5260\_Ant2

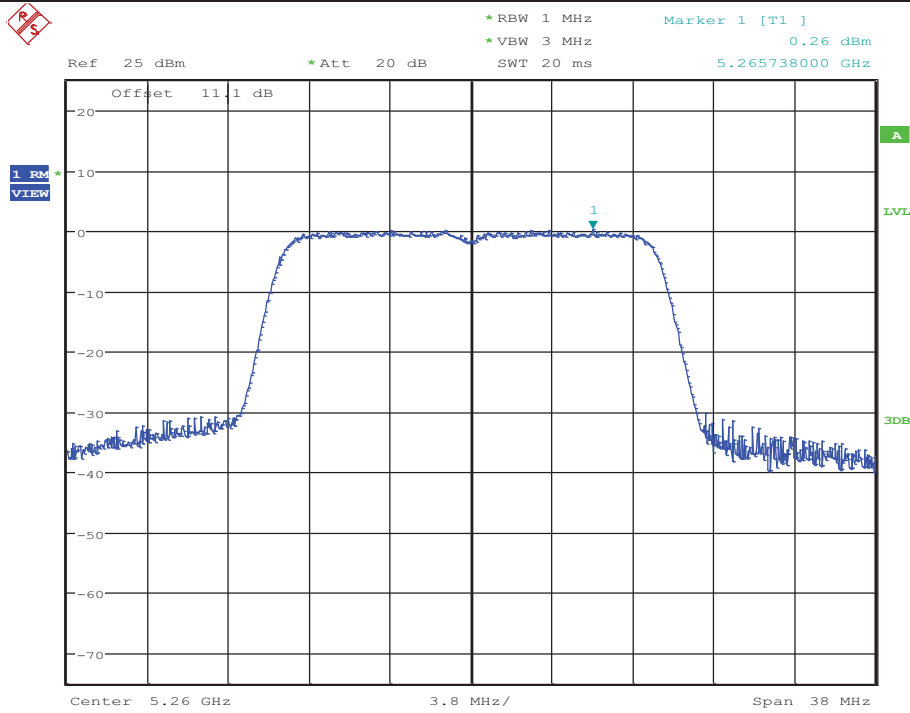

Date: 14.OCT.2017 16:14:05



### Maximum Power Spectral Density\_TNVN\_11N20MIMO\_5280\_Ant1

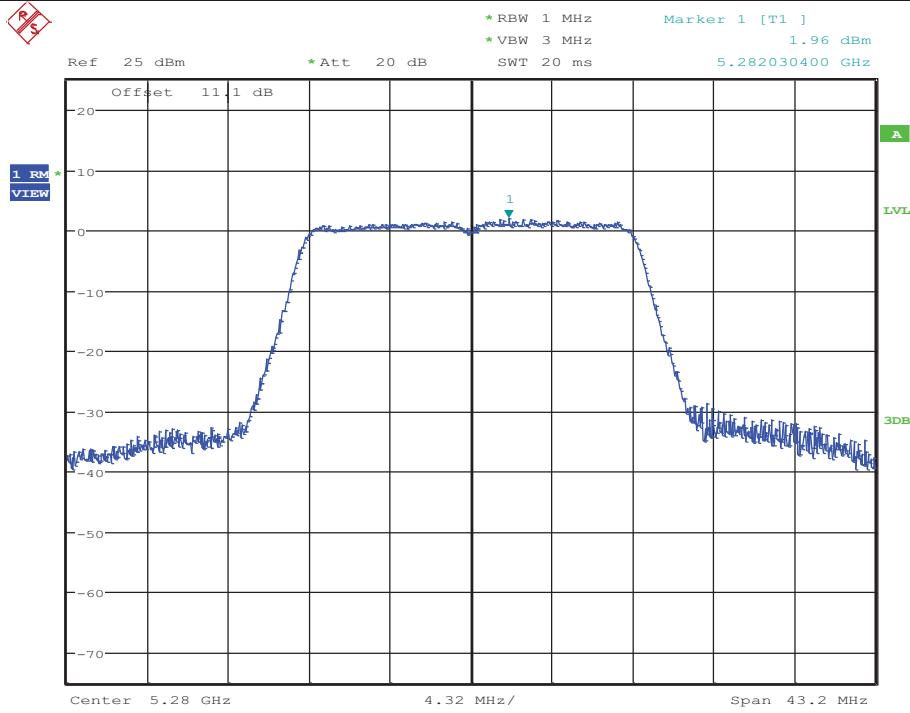

Date: 16.OCT.2017 17:37:25

### Maximum Power Spectral Density\_TNVN\_11N20MIMO\_5280\_Ant2

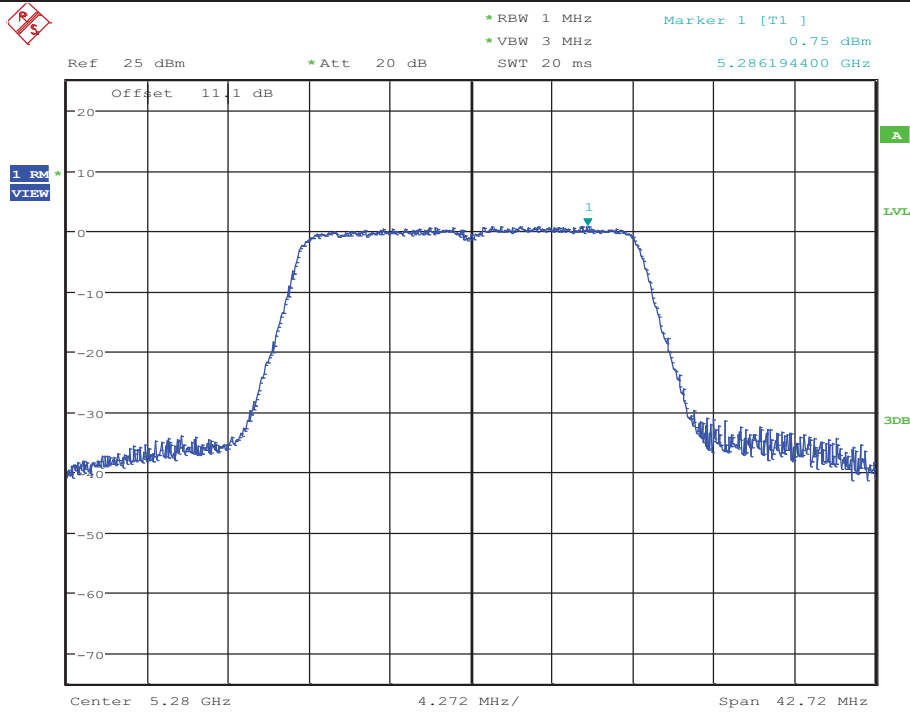

Date: 16.OCT.2017 17:41:49

### Maximum Power Spectral Density\_TNVN\_11N20MIMO\_5320\_Ant1

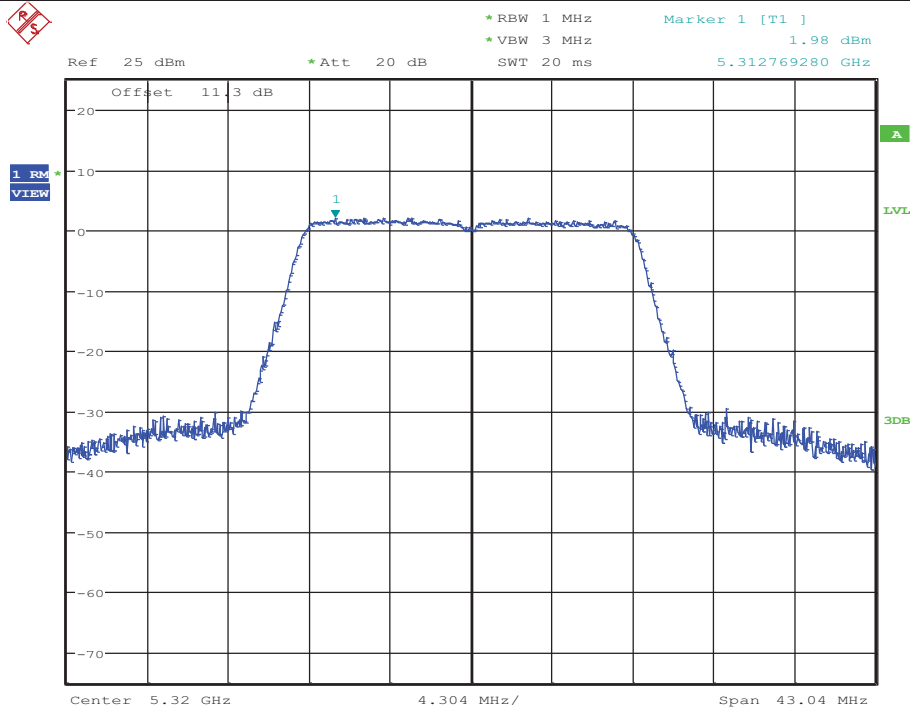

Date: 16.OCT.2017 17:47:01

### Maximum Power Spectral Density\_TNVN\_11N20MIMO\_5320\_Ant2

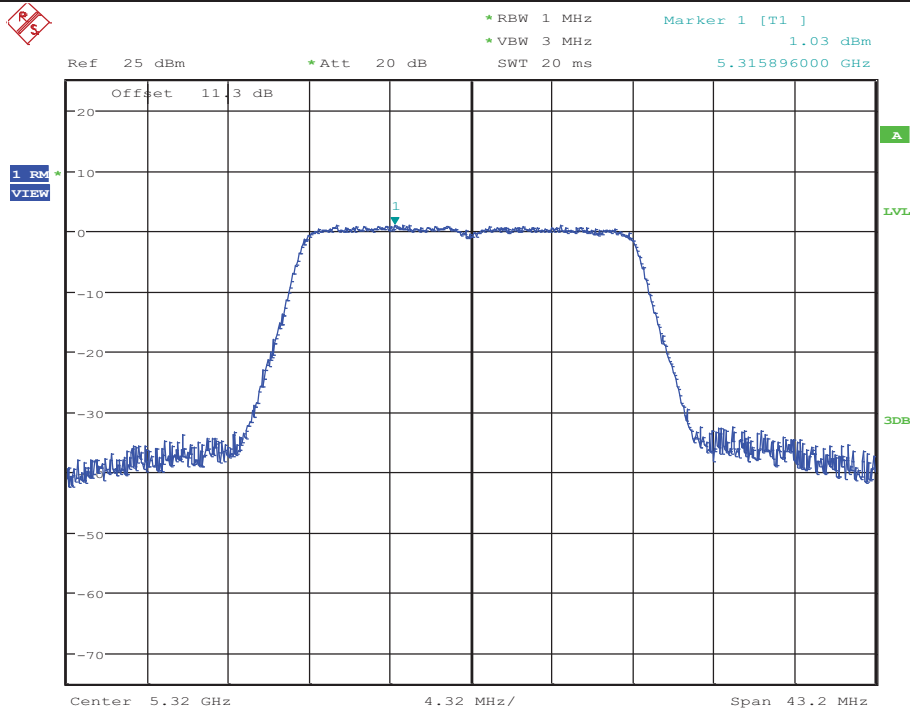

Date: 16.OCT.2017 17:53:16

### Maximum Power Spectral Density\_TNVN\_11N20MIMO\_5500\_Ant1

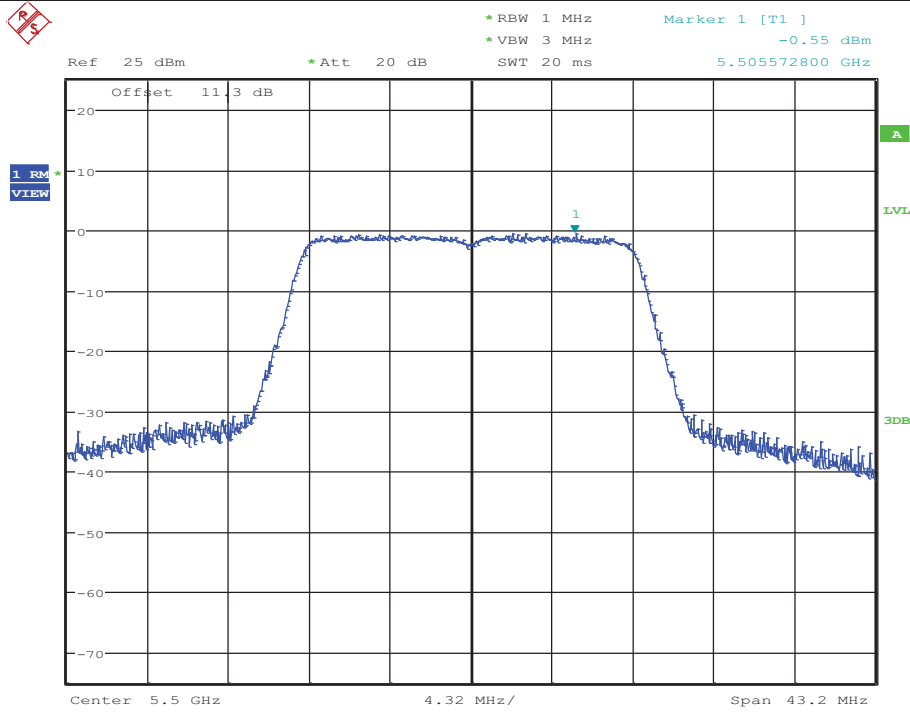

Date: 16.OCT.2017 17:58:57

### Maximum Power Spectral Density\_TNVN\_11N20MIMO\_5500\_Ant2

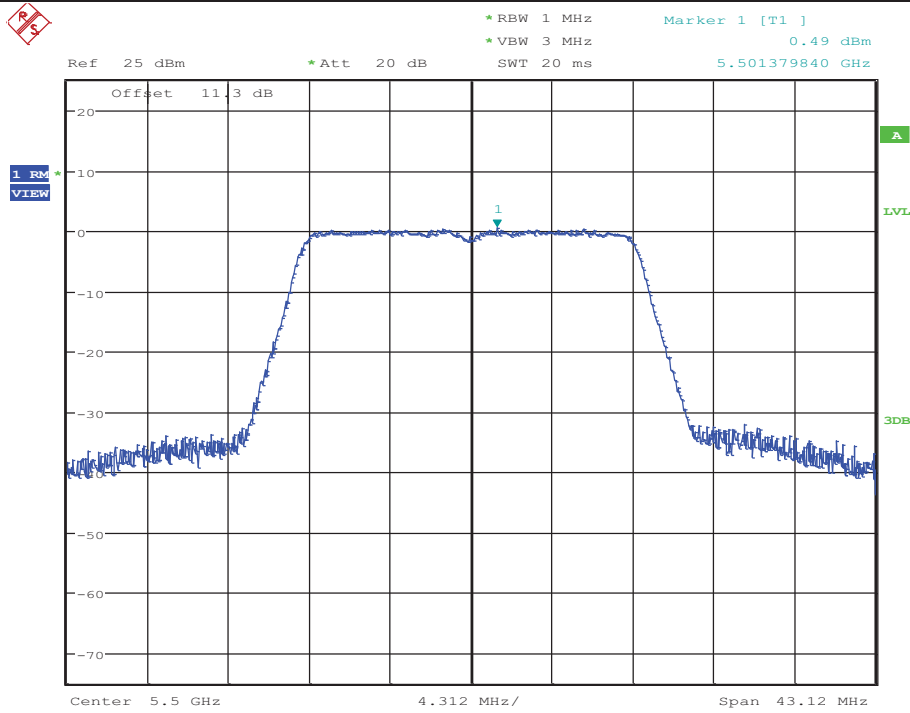

Date: 16.OCT.2017 18:04:35

### Maximum Power Spectral Density\_TNVN\_11N20MIMO\_5580\_Ant1

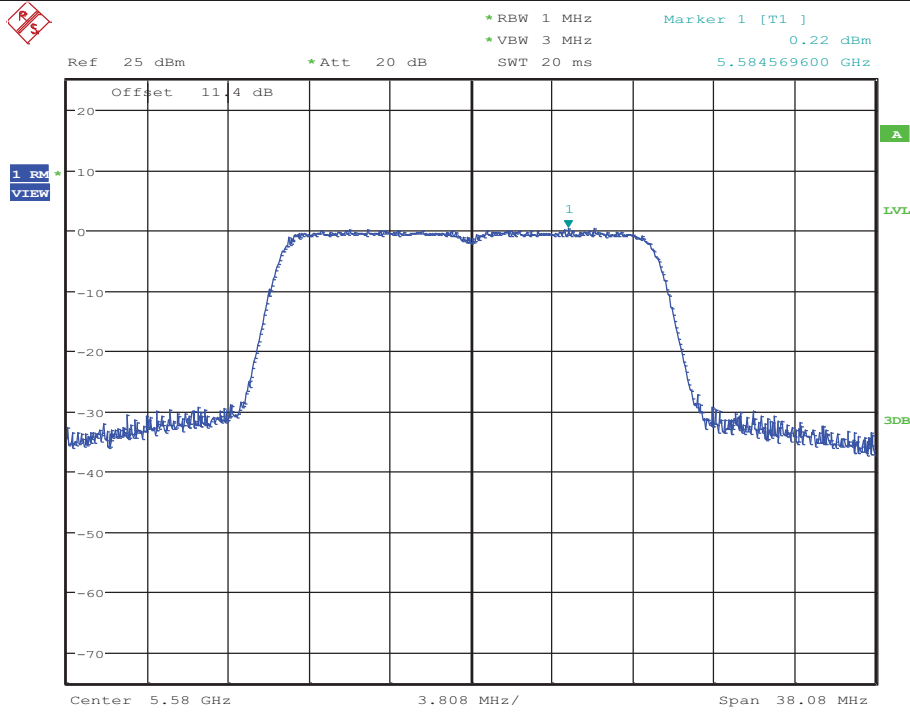

Date: 16.OCT.2017 18:12:16

### Maximum Power Spectral Density\_TNVN\_11N20MIMO\_5580\_Ant2

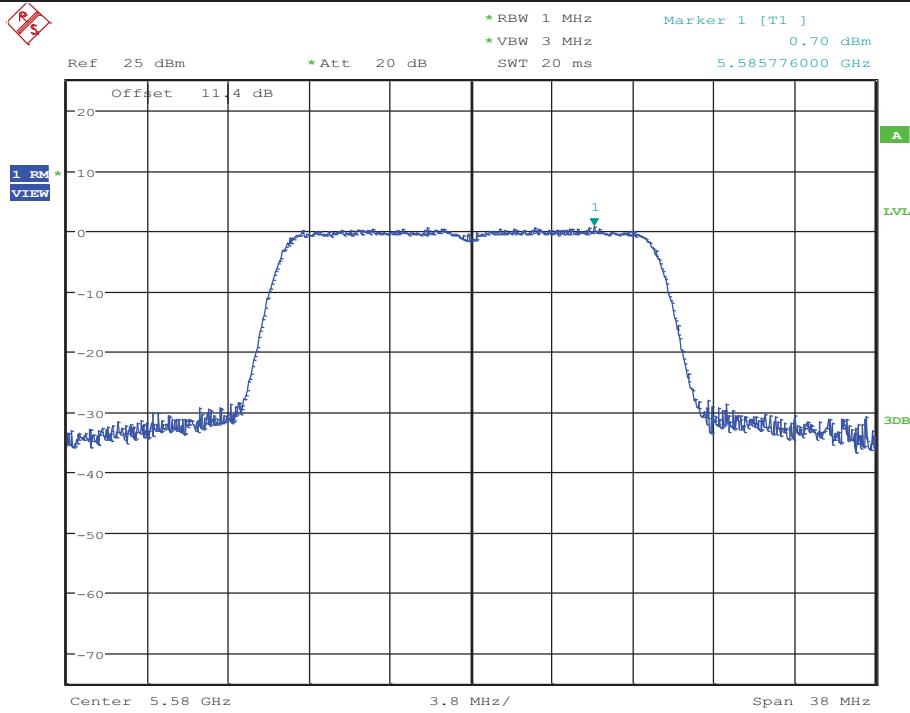

Date: 16.OCT.2017 18:16:40

### Maximum Power Spectral Density\_TNVN\_11N20MIMO\_5700\_Ant1

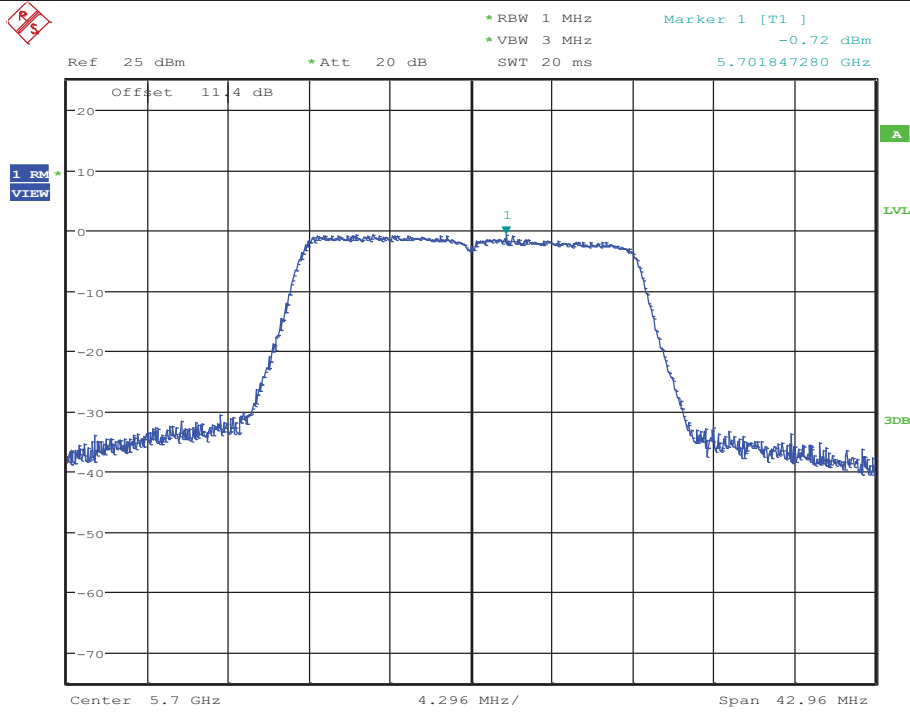

Date: 16.OCT.2017 18:53:24

### Maximum Power Spectral Density\_TNVN\_11N20MIMO\_5700\_Ant2

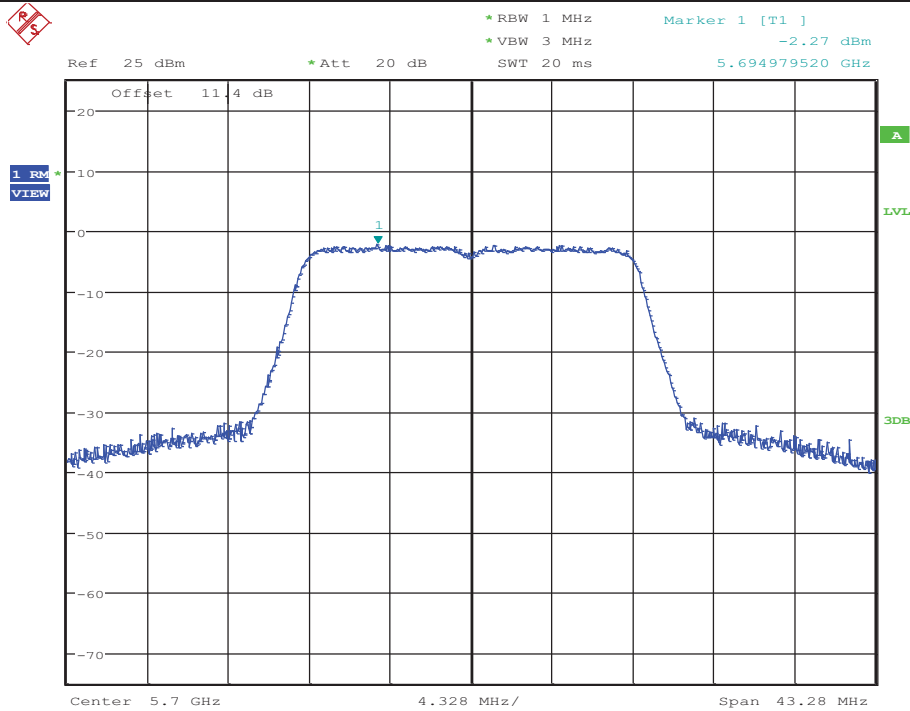

Date: 16.OCT.2017 19:00:12

Maximum Power Spectral Density\_TNVN\_11N20MIMO\_5745\_Ant1

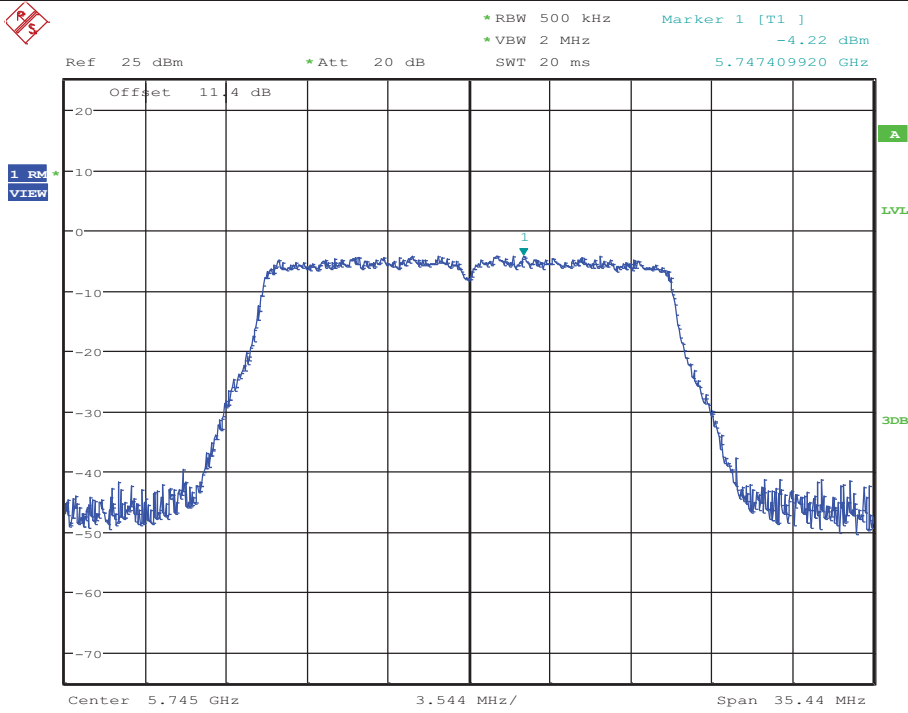

Date: 16.OCT.2017 19:05:05

Maximum Power Spectral Density\_TNVN\_11N20MIMO\_5745\_Ant2

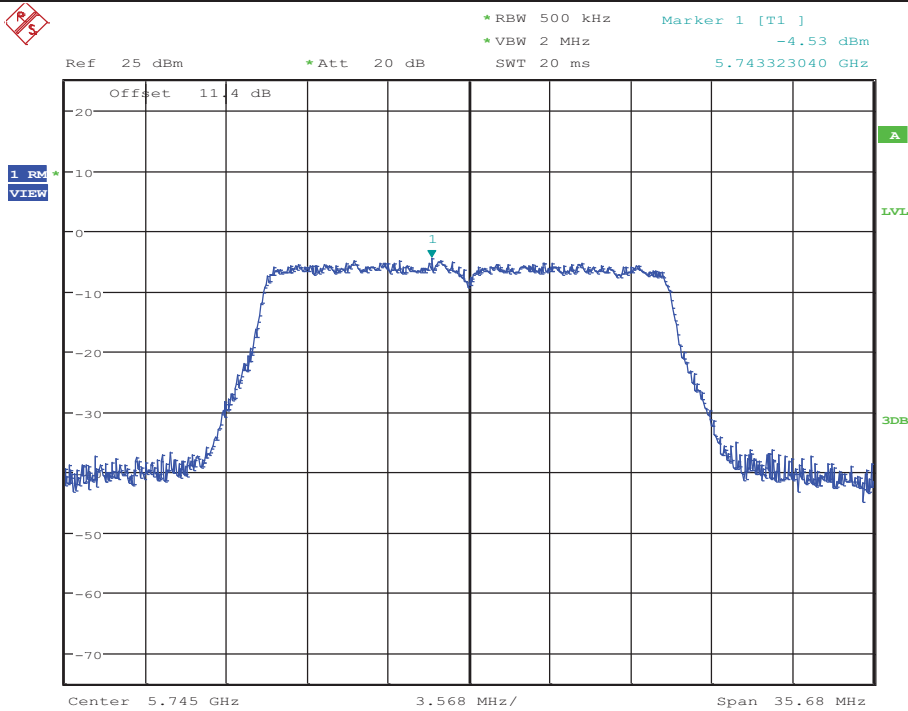

Date: 16.OCT.2017 19:08:56

### Maximum Power Spectral Density\_TNVN\_11N20MIMO\_5785\_Ant1

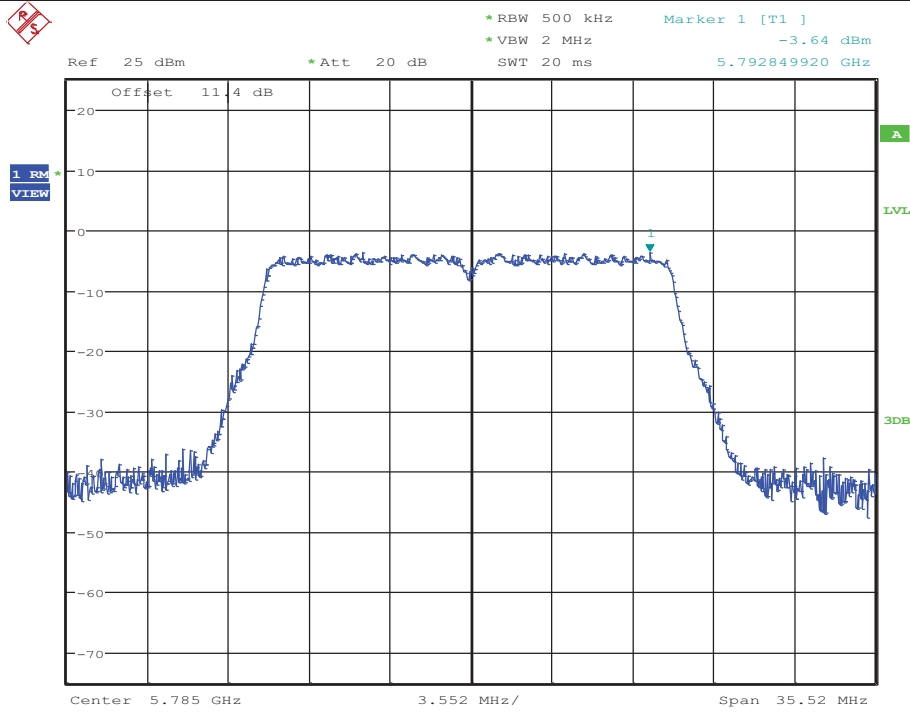

Date: 16.OCT.2017 19:13:24

### Maximum Power Spectral Density\_TNVN\_11N20MIMO\_5785\_Ant2

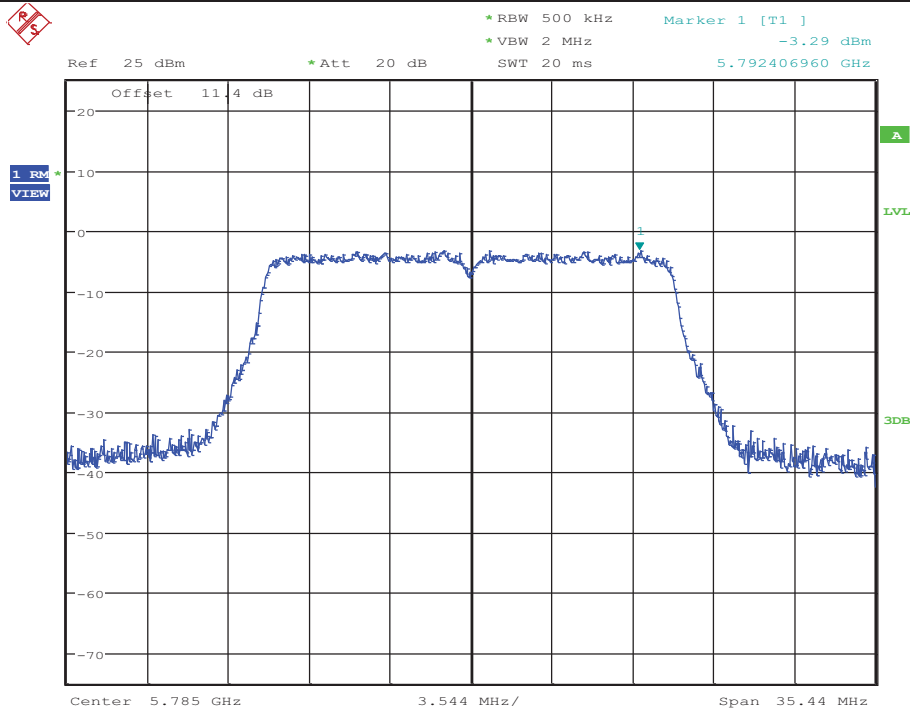

Date: 16.OCT.2017 19:16:52

### Maximum Power Spectral Density\_TNVN\_11N20MIMO\_5825\_Ant1

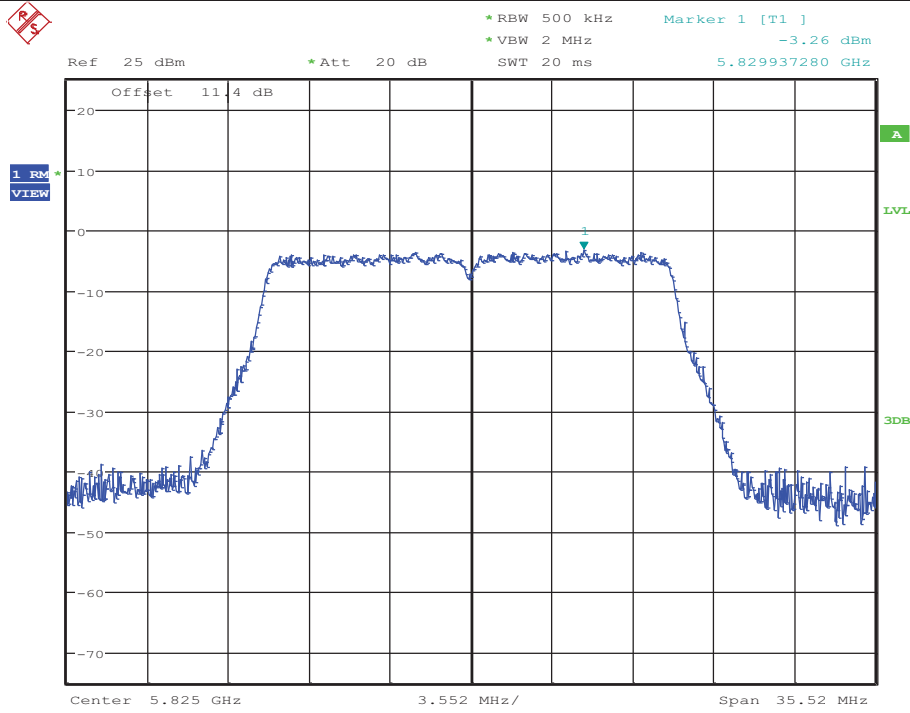

Date: 16.OCT.2017 19:21:00

### Maximum Power Spectral Density\_TNVN\_11N20MIMO\_5825\_Ant2

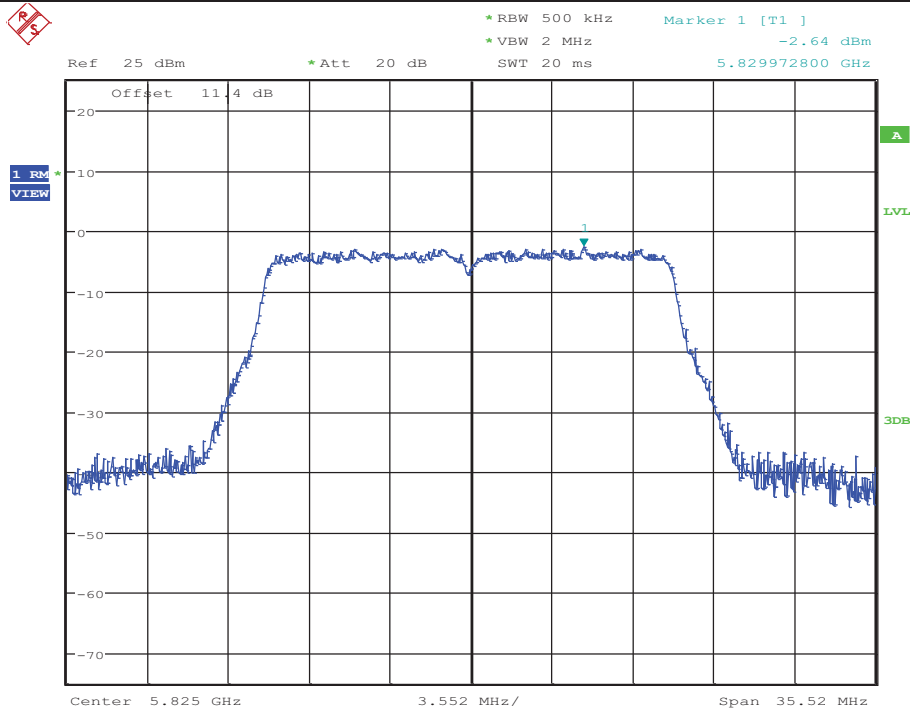

Date: 16.OCT.2017 19:24:52



Maximum Power Spectral Density\_TNVN\_11N40MIMO\_5190\_Ant1

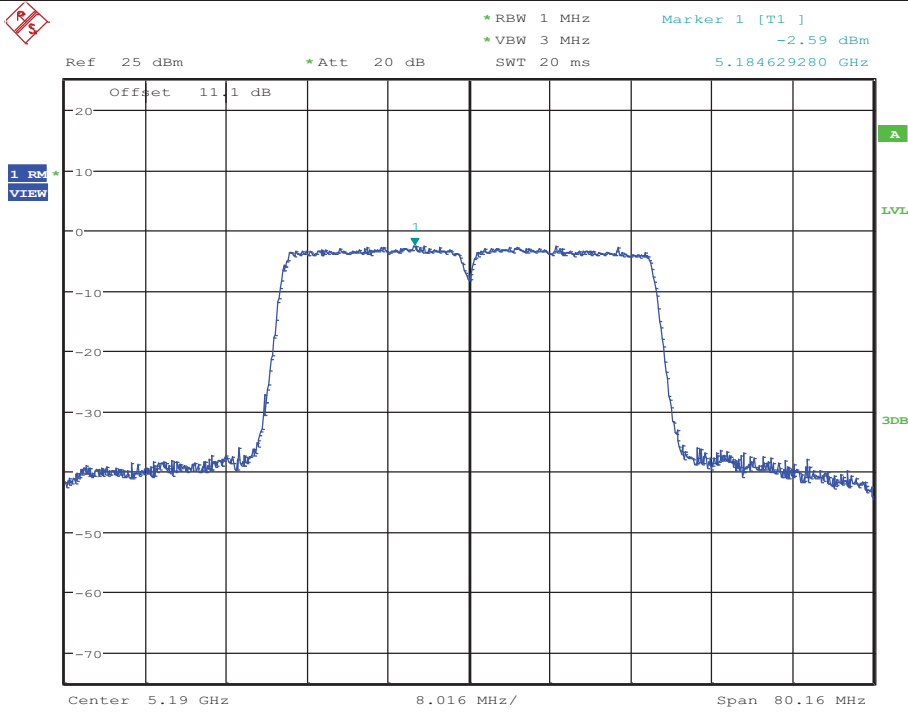

Date: 16.OCT.2017 19:30:35

Maximum Power Spectral Density\_TNVN\_11N40MIMO\_5190\_Ant2

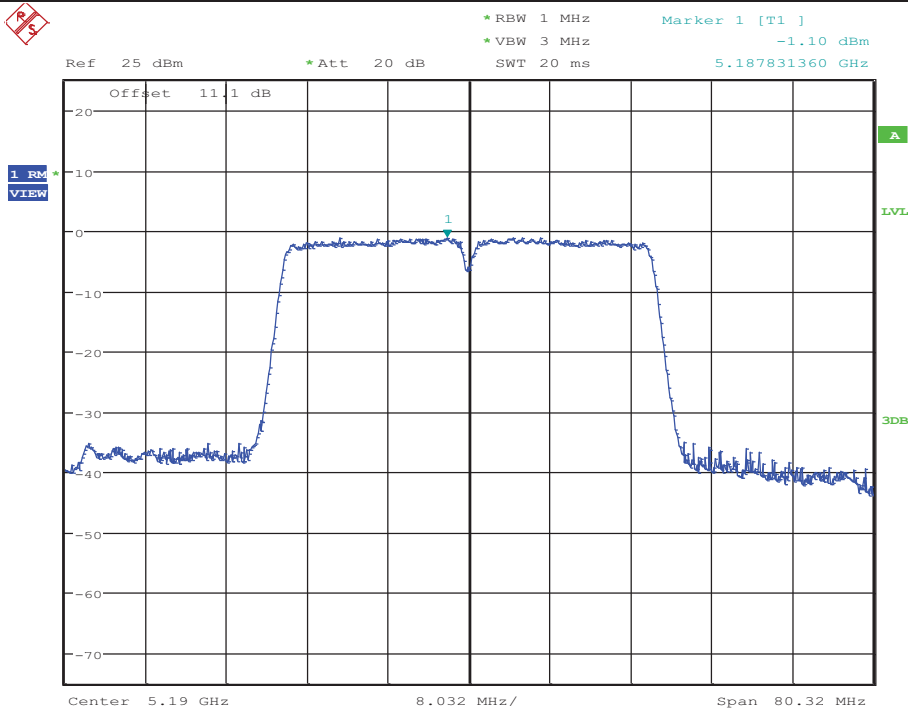

Date: 16.OCT.2017 19:38:08

### Maximum Power Spectral Density\_TNVN\_11N40MIMO\_5230\_Ant1

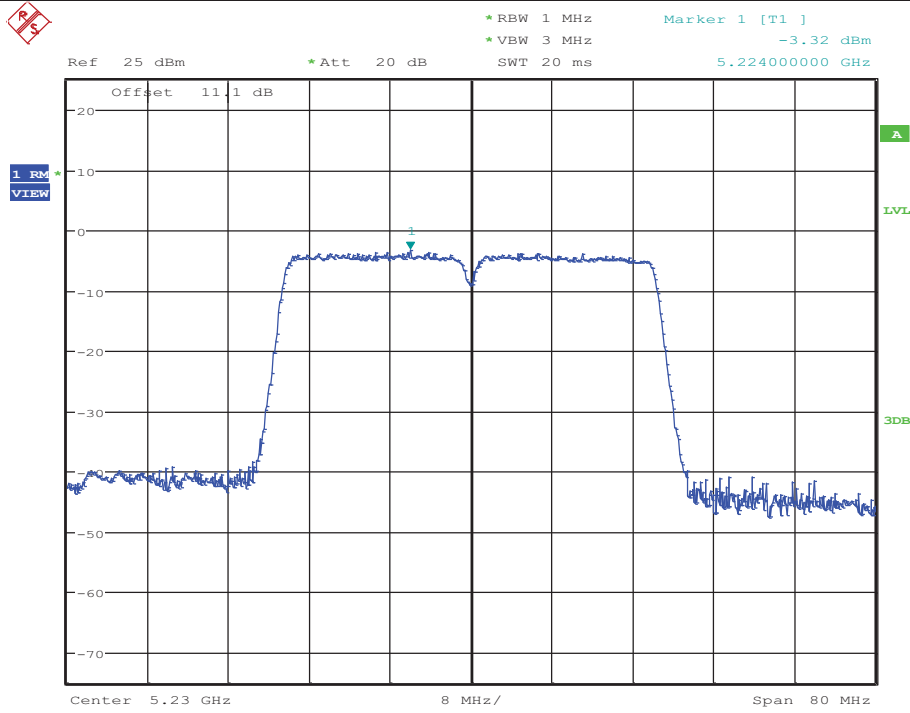

Date: 16.OCT.2017 19:44:43

### Maximum Power Spectral Density\_TNVN\_11N40MIMO\_5230\_Ant2

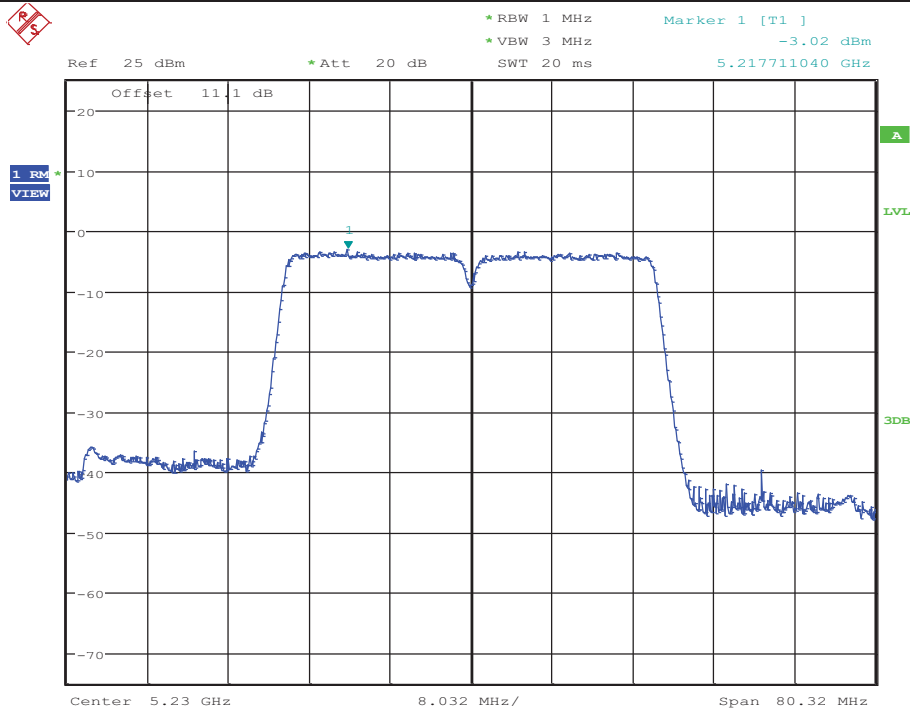

Date: 16.OCT.2017 19:49:01

### Maximum Power Spectral Density\_TNVN\_11N40MIMO\_5270\_Ant1

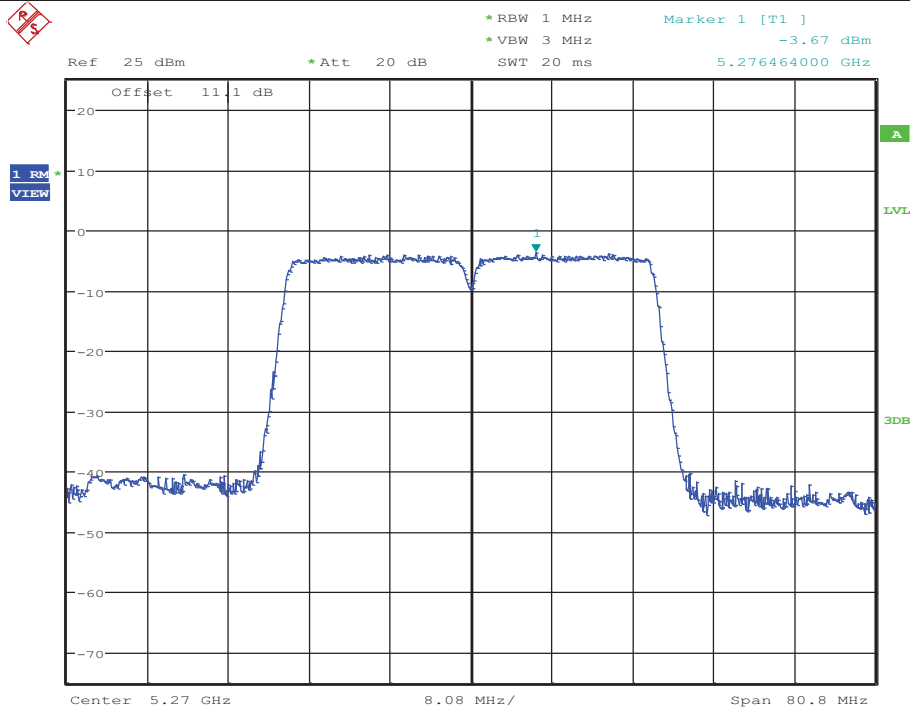

Date: 16.OCT.2017 19:56:03

### Maximum Power Spectral Density\_TNVN\_11N40MIMO\_5270\_Ant2

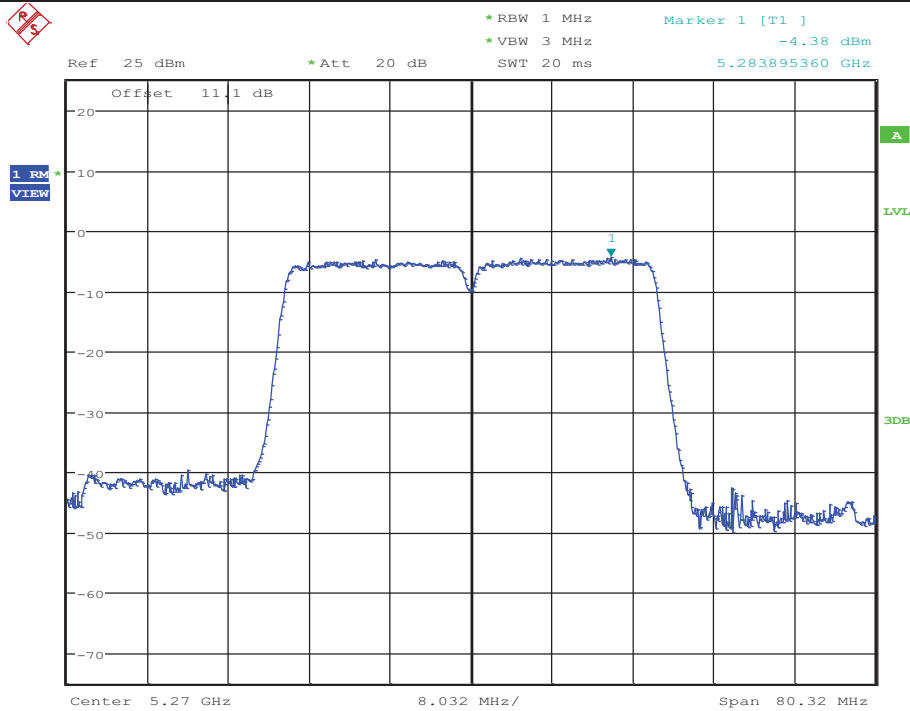

Date: 16.OCT.2017 20:00:21

Maximum Power Spectral Density\_TNVN\_11N40MIMO\_5310\_Ant1

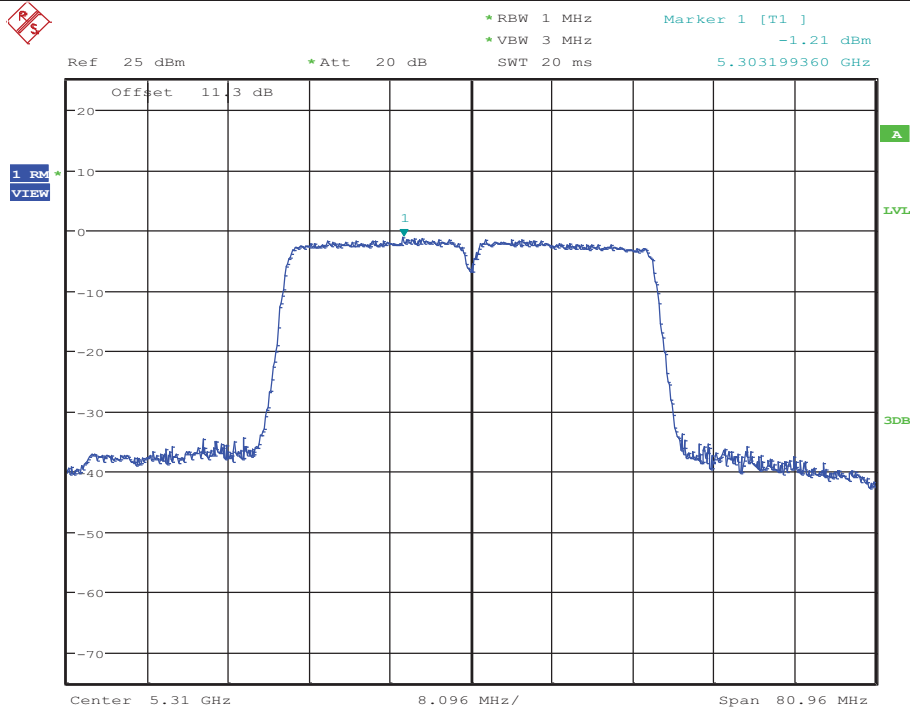

Date: 16.OCT.2017 20:05:27

Maximum Power Spectral Density\_TNVN\_11N40MIMO\_5310\_Ant2

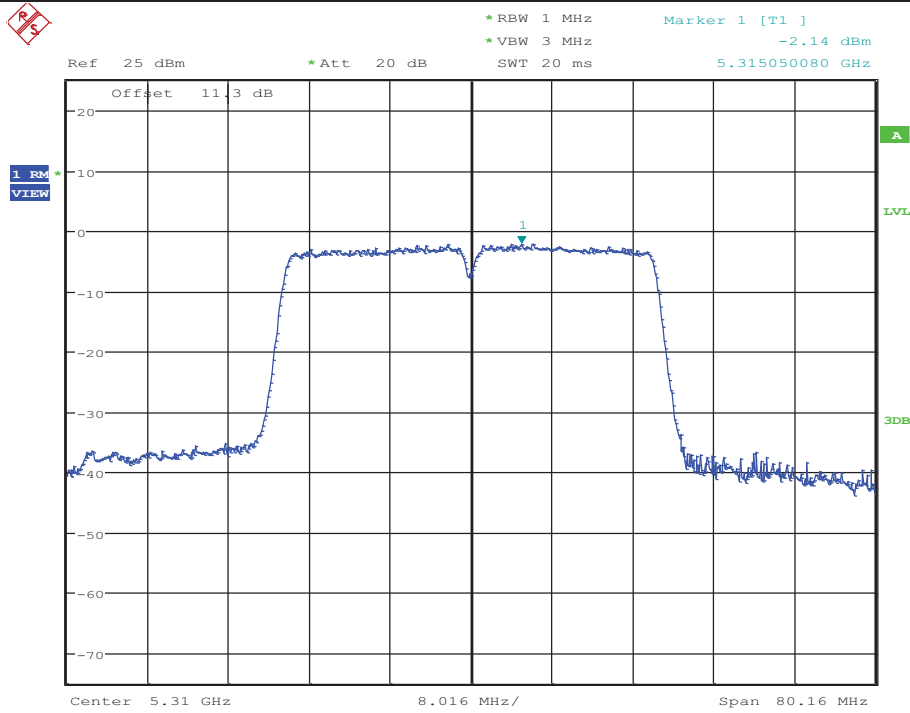

Date: 16.OCT.2017 20:09:45

### Maximum Power Spectral Density\_TNVN\_11N40MIMO\_5510\_Ant1

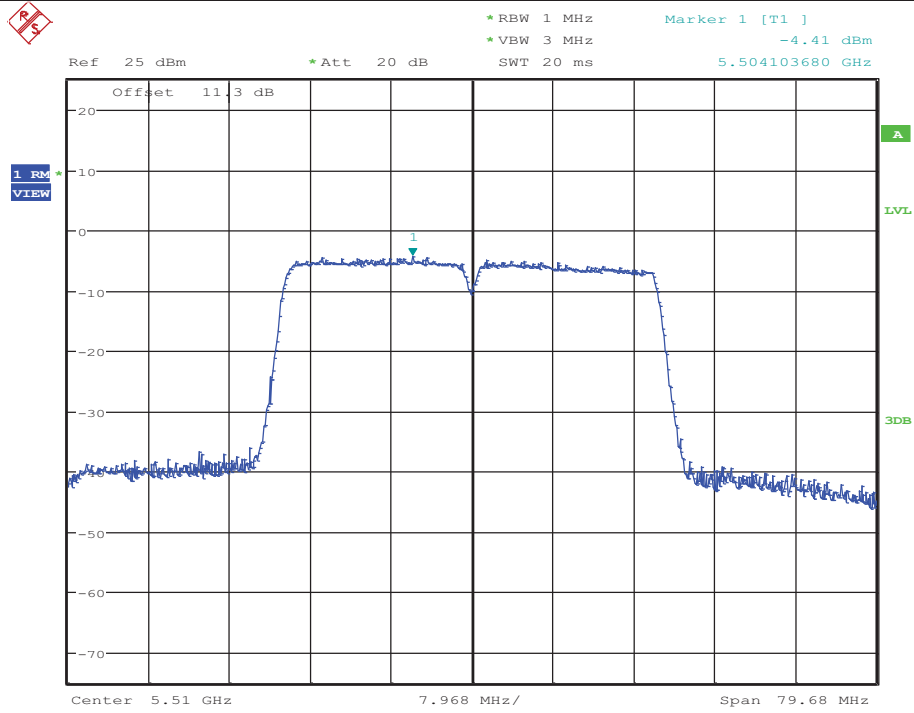

Date: 16.OCT.2017 20:14:46

### Maximum Power Spectral Density\_TNVN\_11N40MIMO\_5510\_Ant2

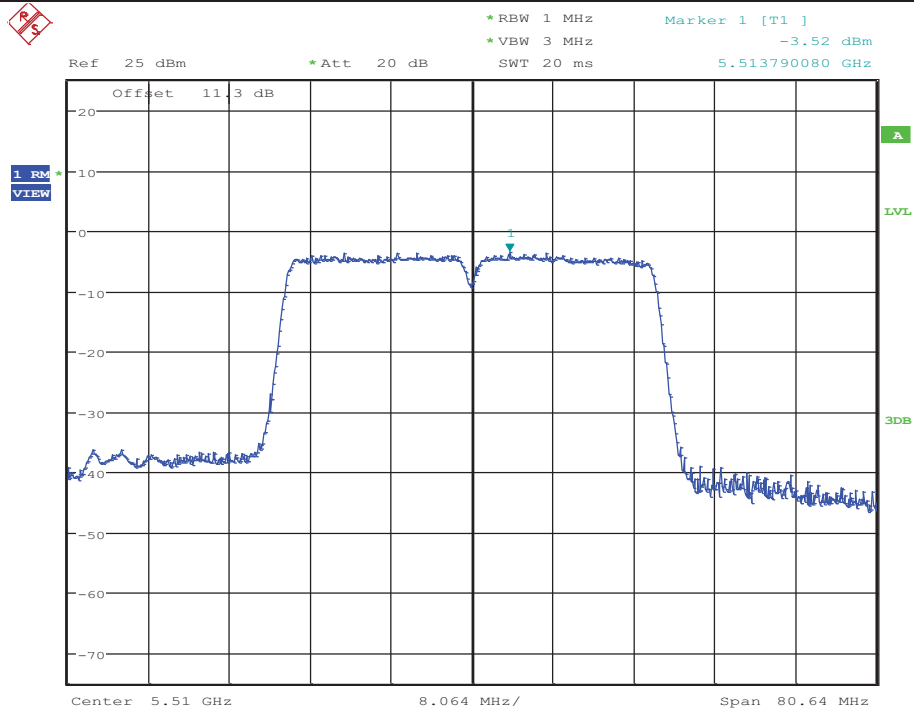

Date: 16.OCT.2017 20:21:11

### Maximum Power Spectral Density\_TNVN\_11N40MIMO\_5550\_Ant1

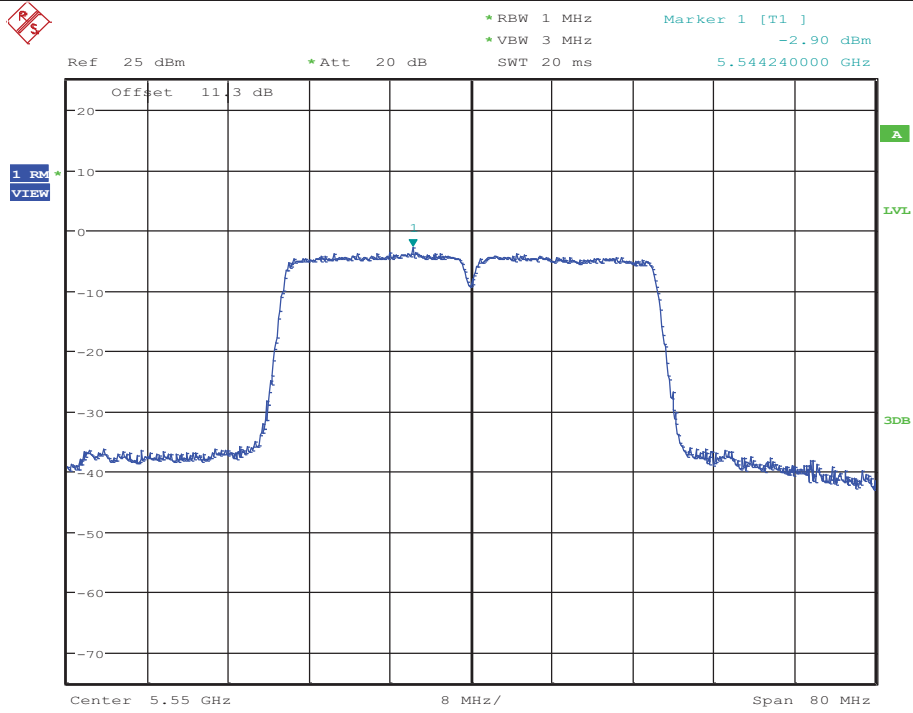

Date: 16.OCT.2017 20:31:44

### Maximum Power Spectral Density\_TNVN\_11N40MIMO\_5550\_Ant2

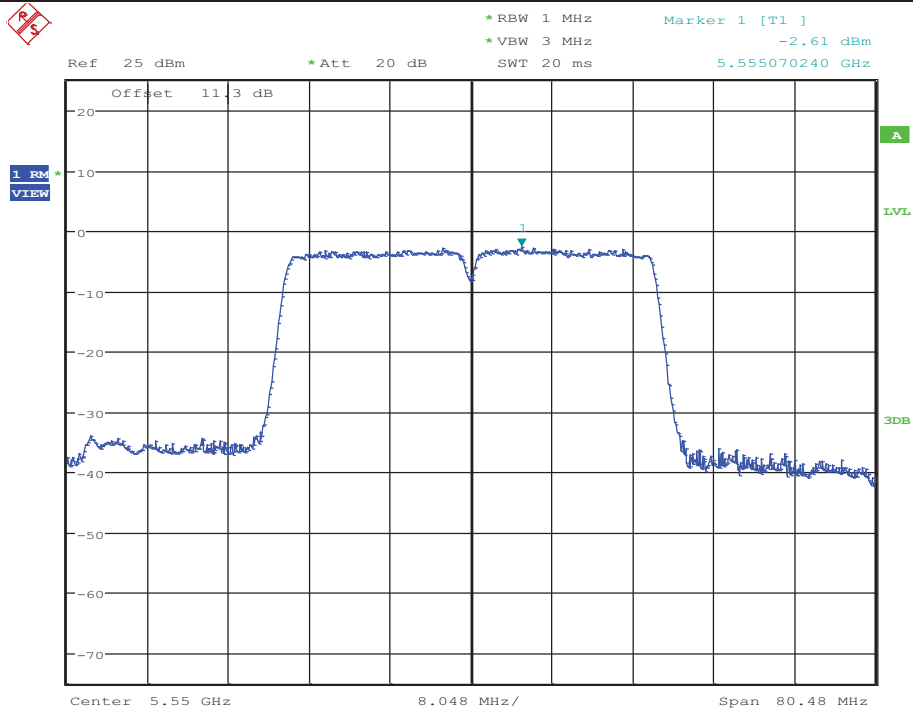

Date: 16.OCT.2017 20:35:37

### Maximum Power Spectral Density\_TNVN\_11N40MIMO\_5670\_Ant1

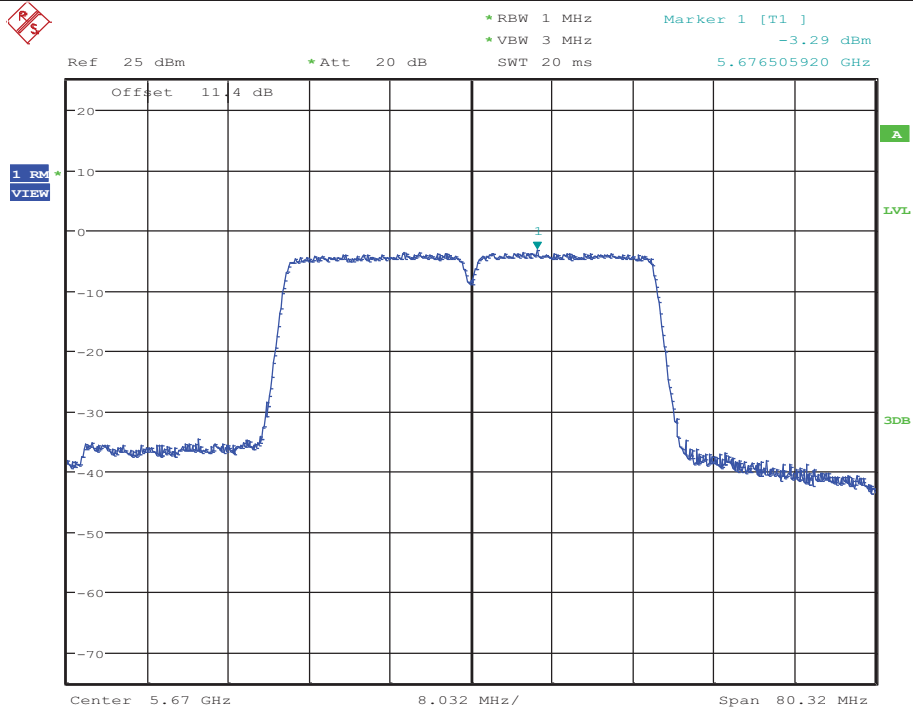

Date: 17.OCT.2017 08:53:59

### Maximum Power Spectral Density\_TNVN\_11N40MIMO\_5670\_Ant2

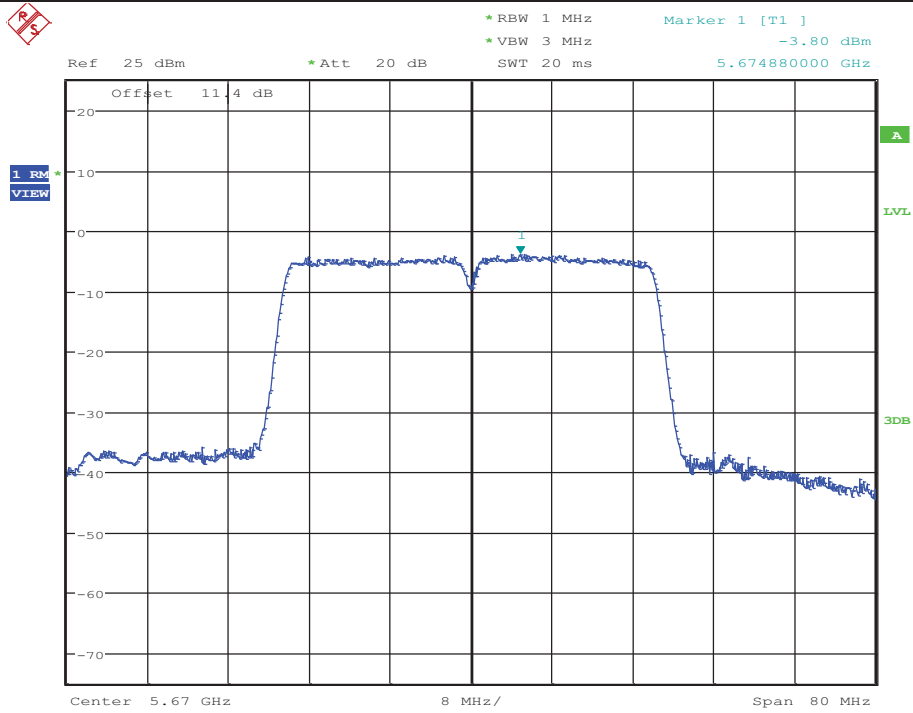

Date: 17.OCT.2017 11:45:04

Maximum Power Spectral Density\_TNVN\_11N40MIMO\_5755\_Ant1

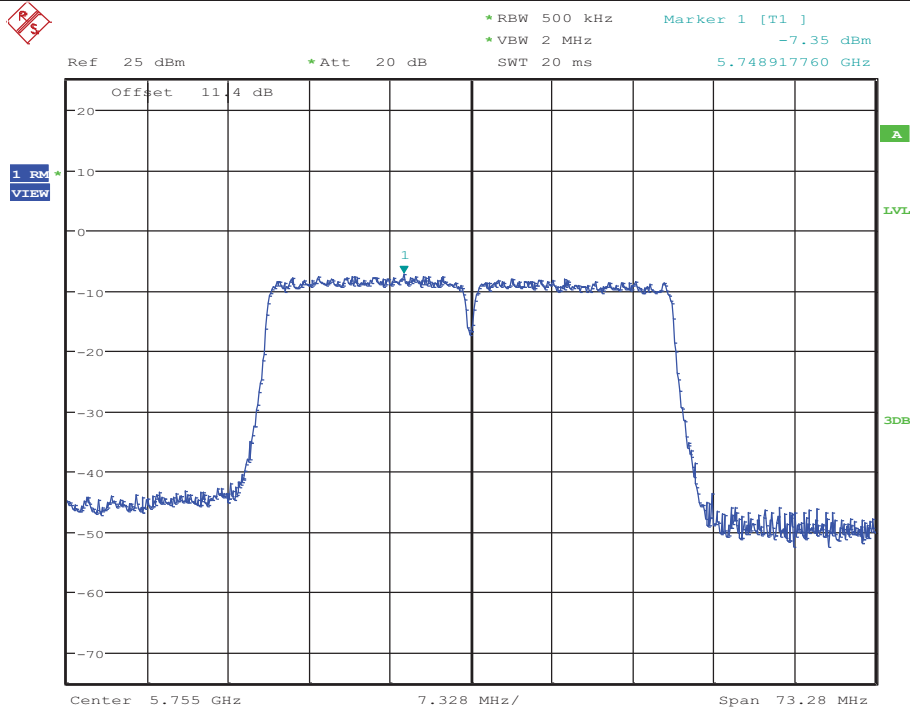

Date: 17.OCT.2017 08:59:34

Maximum Power Spectral Density\_TNVN\_11N40MIMO\_5755\_Ant2

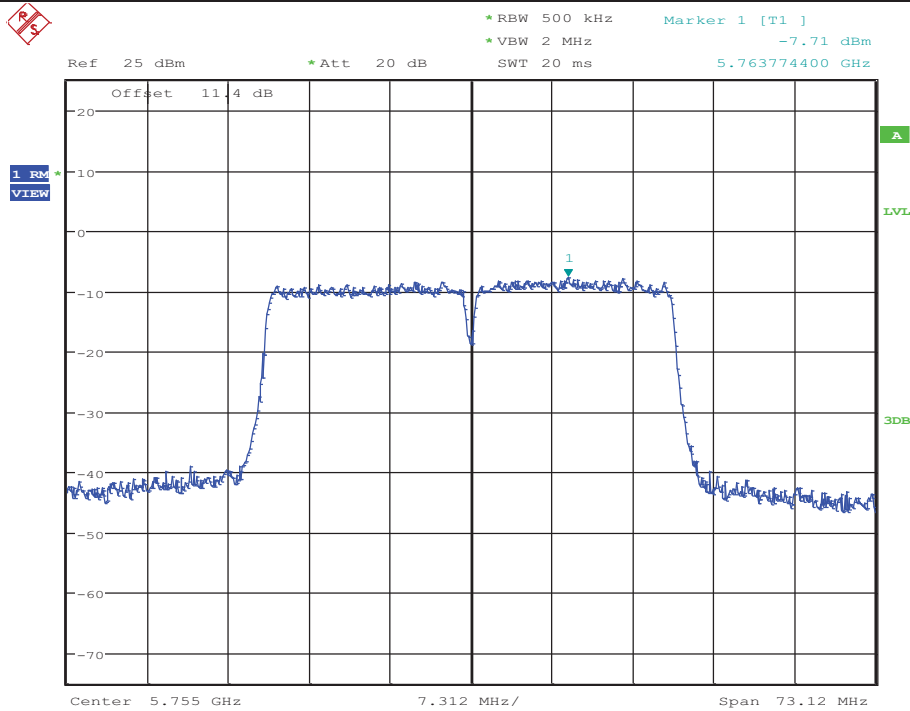

Date: 17.OCT.2017 11:55:09



### Maximum Power Spectral Density\_TNVN\_11N40MIMO\_5795\_Ant1

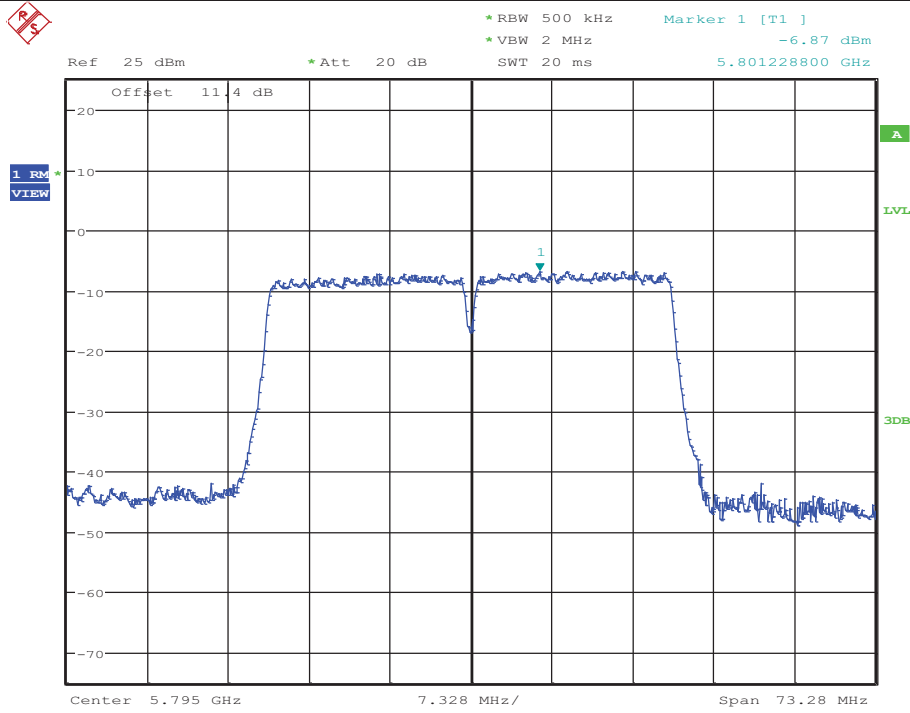

Date: 17.OCT.2017 09:04:57

### Maximum Power Spectral Density\_TNVN\_11N40MIMO\_5795\_Ant2

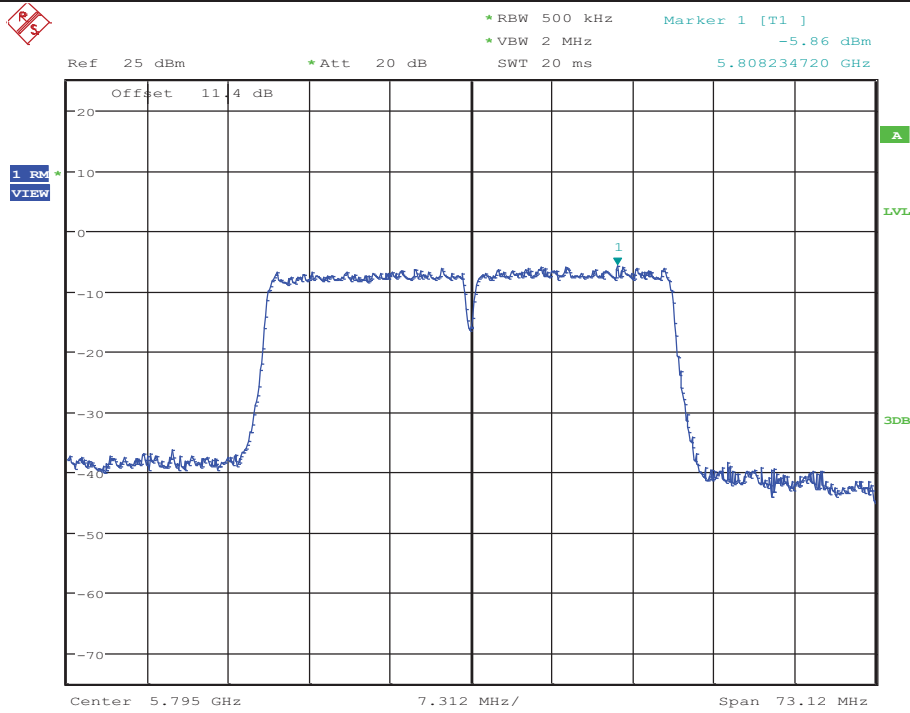

Date: 17.OCT.2017 13:34:47

Maximum Power Spectral Density\_TNVN\_11AC20MIMO\_5180\_Ant1

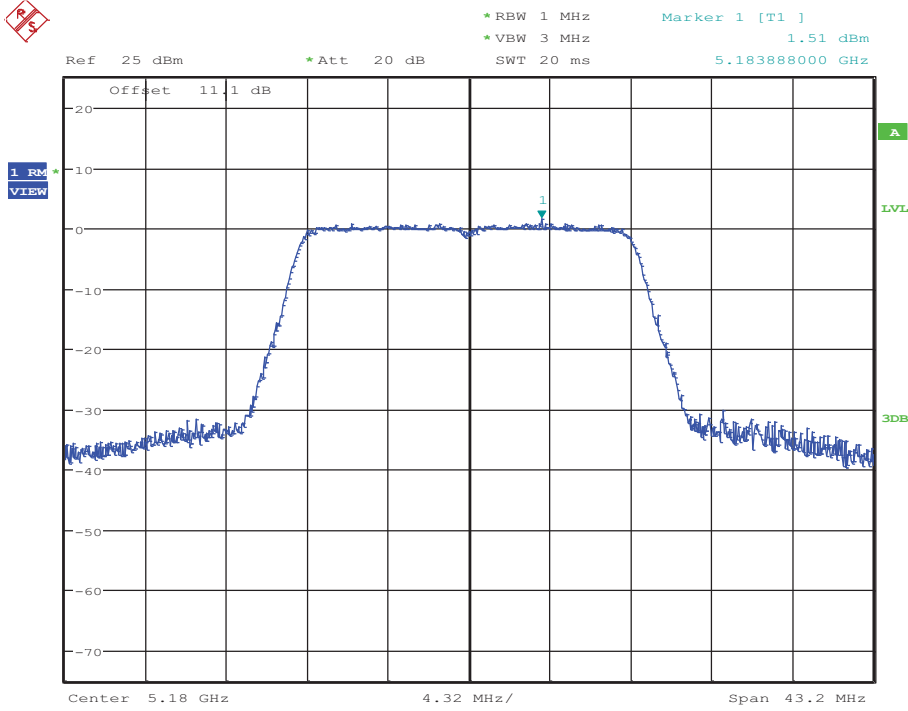

Date: 17.OCT.2017 09:11:45

Maximum Power Spectral Density\_TNVN\_11AC20MIMO\_5180\_Ant2

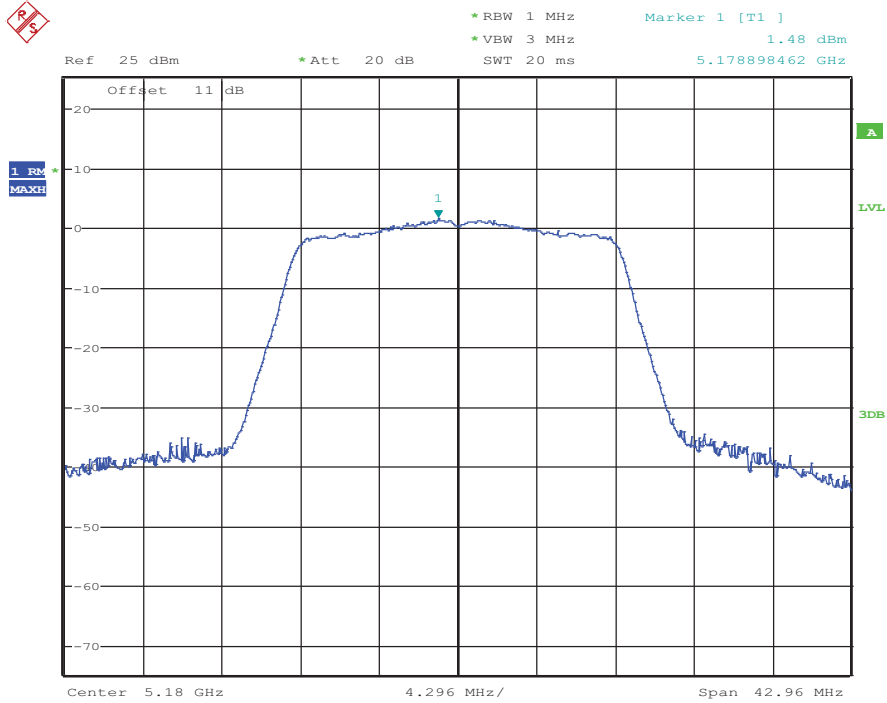

Date: 14.OCT.2017 15:51:47

Maximum Power Spectral Density\_TNVN\_11AC20MIMO\_5200\_Ant1

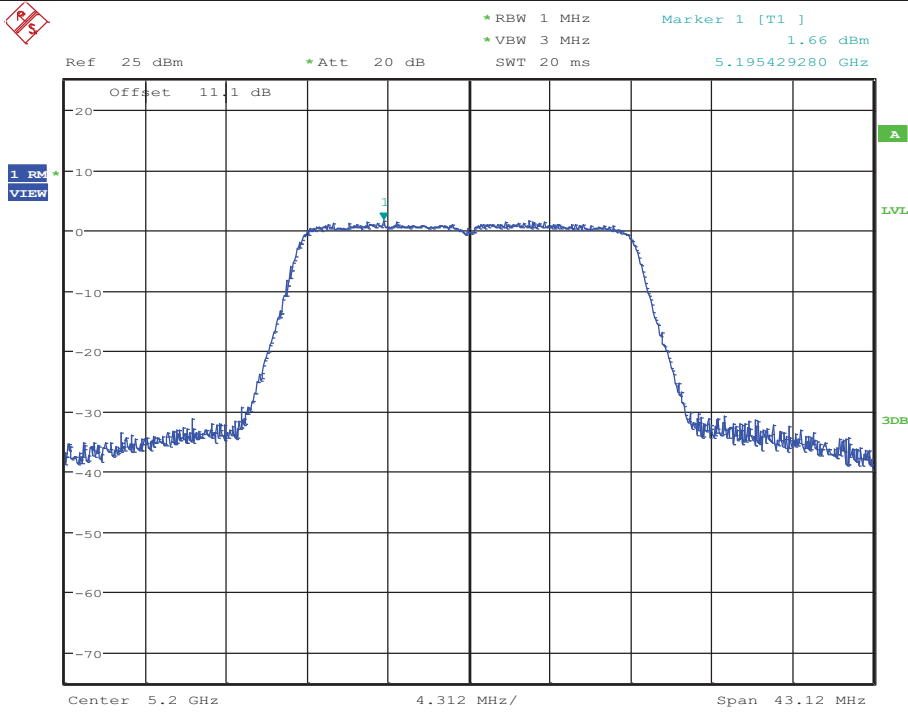

Date: 17.OCT.2017 09:19:48

Maximum Power Spectral Density\_TNVN\_11AC20MIMO\_5200\_Ant2

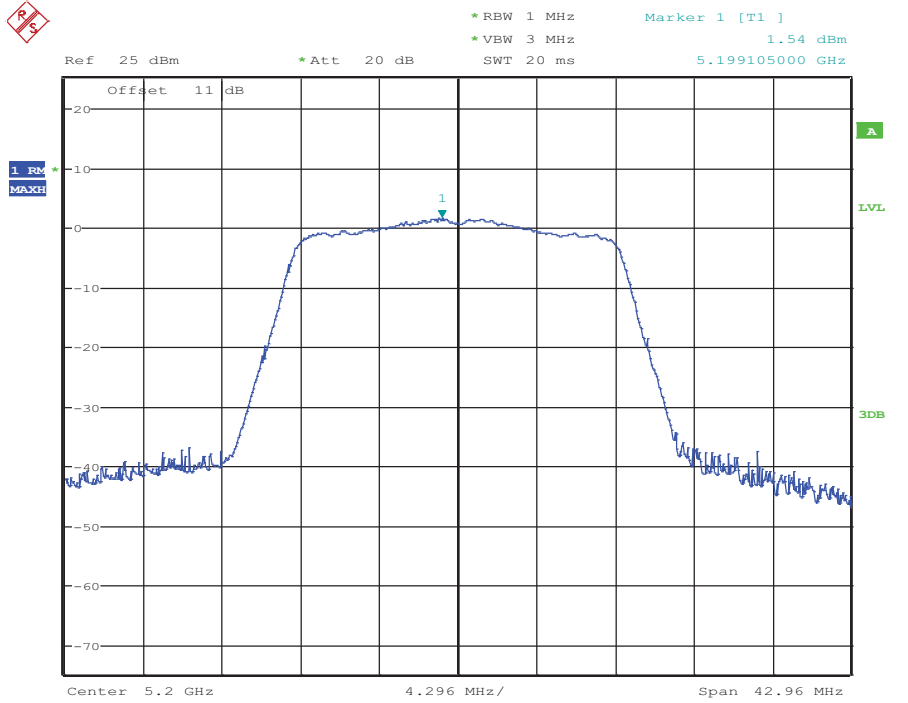

Date: 14.OCT.2017 15:52:37

Maximum Power Spectral Density\_TNVN\_11AC20MIMO\_5240\_Ant1

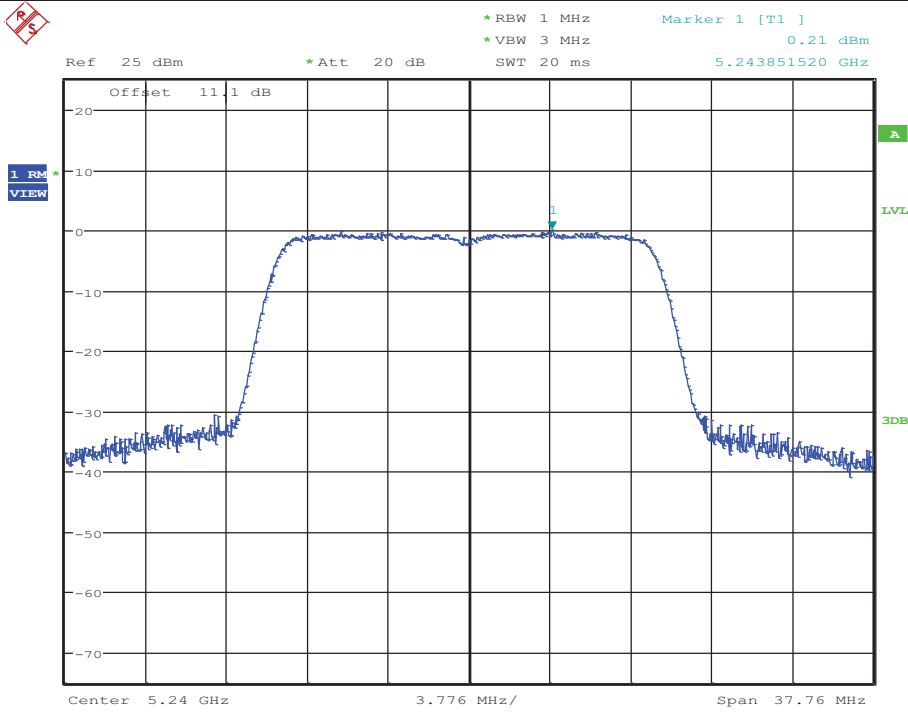

Date: 17.OCT.2017 09:24:30

Maximum Power Spectral Density\_TNVN\_11AC20MIMO\_5240\_Ant2

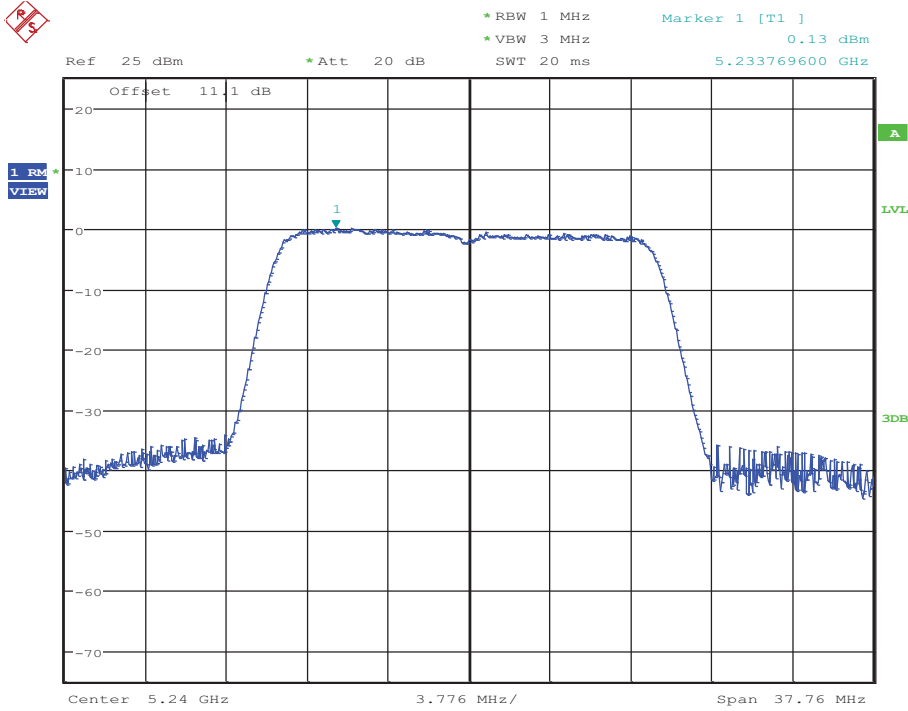

Date: 17.OCT.2017 14:33:56

Maximum Power Spectral Density\_TNVN\_11AC20MIMO\_5260\_Ant1

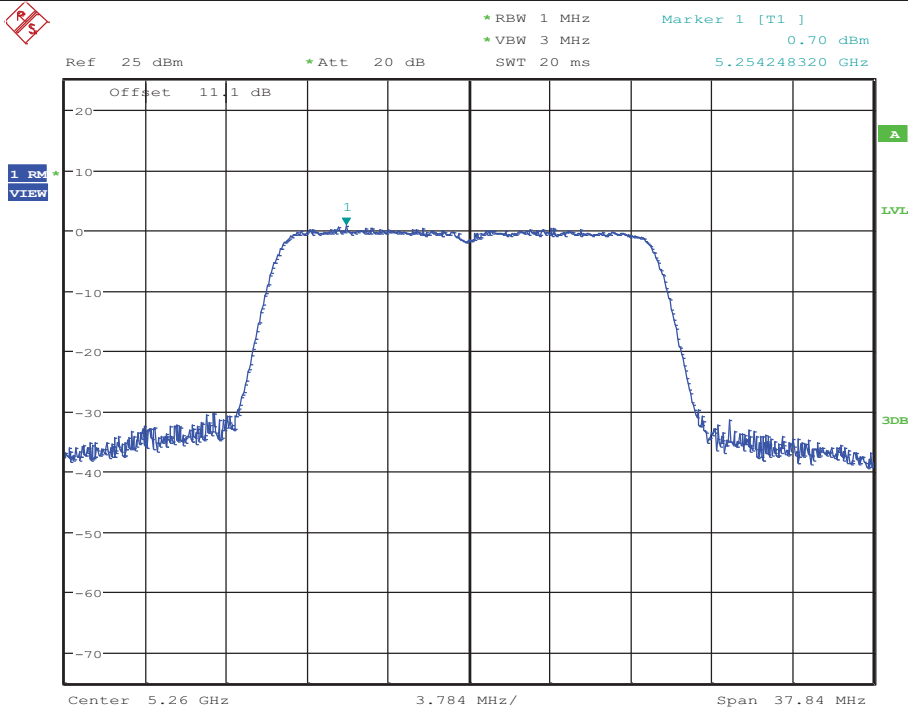

Date: 17.OCT.2017 09:29:39

Maximum Power Spectral Density\_TNVN\_11AC20MIMO\_5260\_Ant2

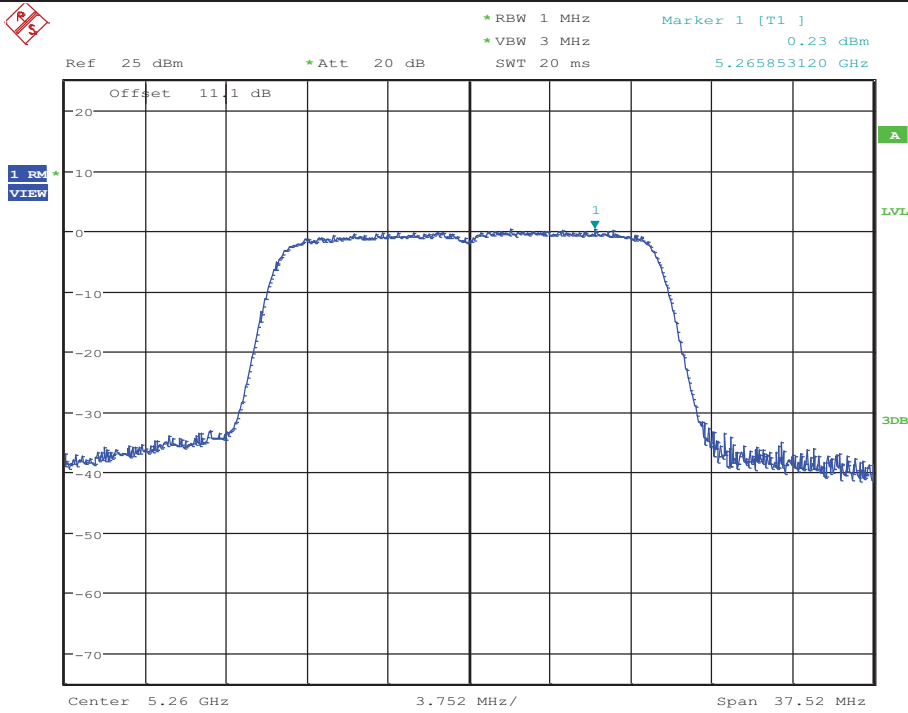

Date: 17.OCT.2017 14:39:04

Maximum Power Spectral Density\_TNVN\_11AC20MIMO\_5280\_Ant1

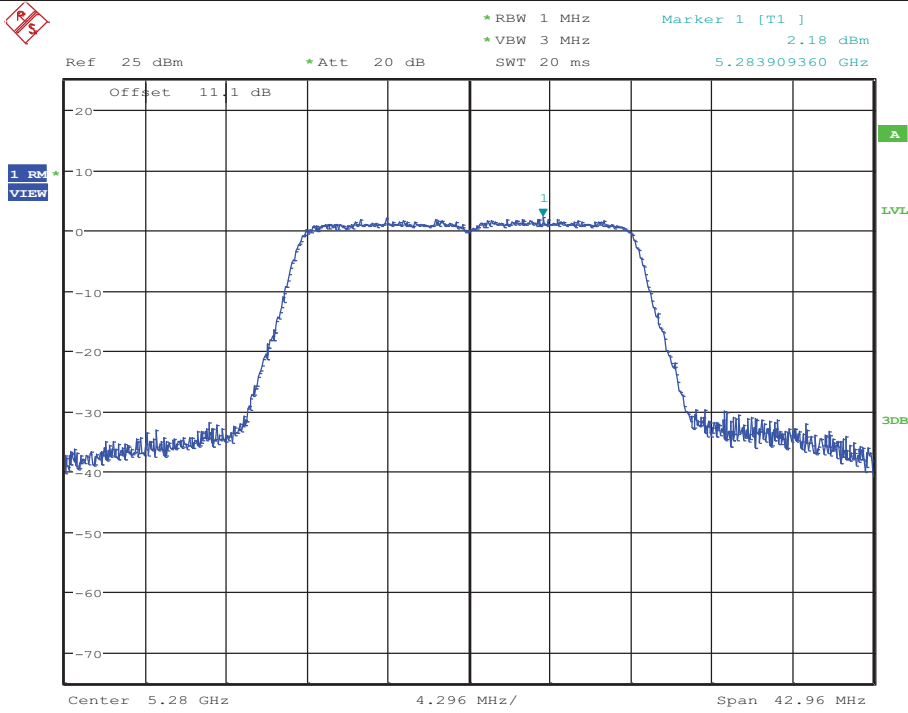

Date: 17.OCT.2017 09:34:56

Maximum Power Spectral Density\_TNVN\_11AC20MIMO\_5280\_Ant2

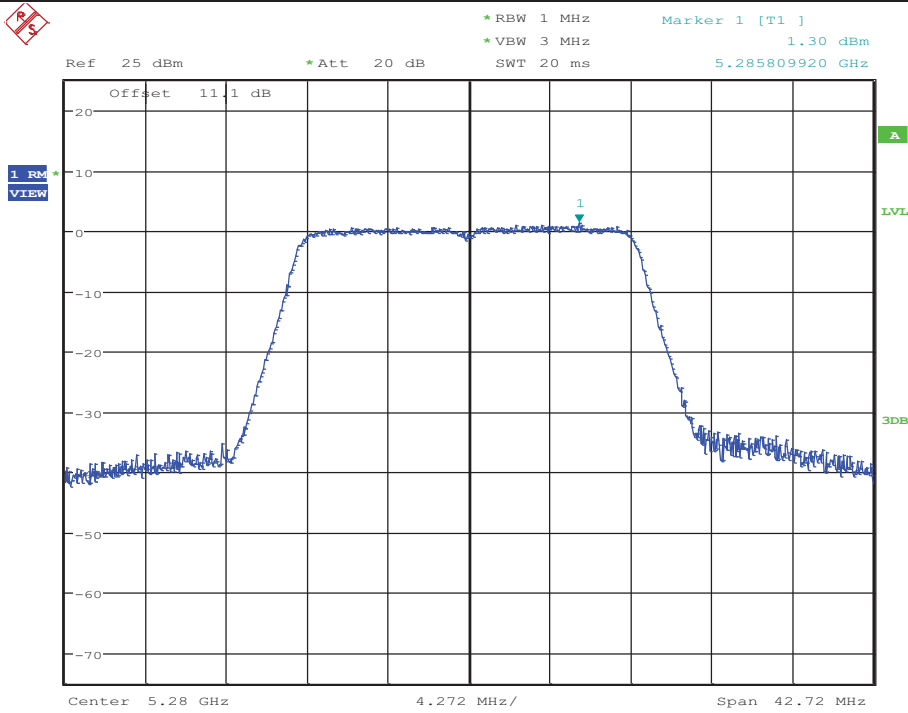

Date: 17.OCT.2017 14:44:17

Maximum Power Spectral Density\_TNVN\_11AC20MIMO\_5320\_Ant1

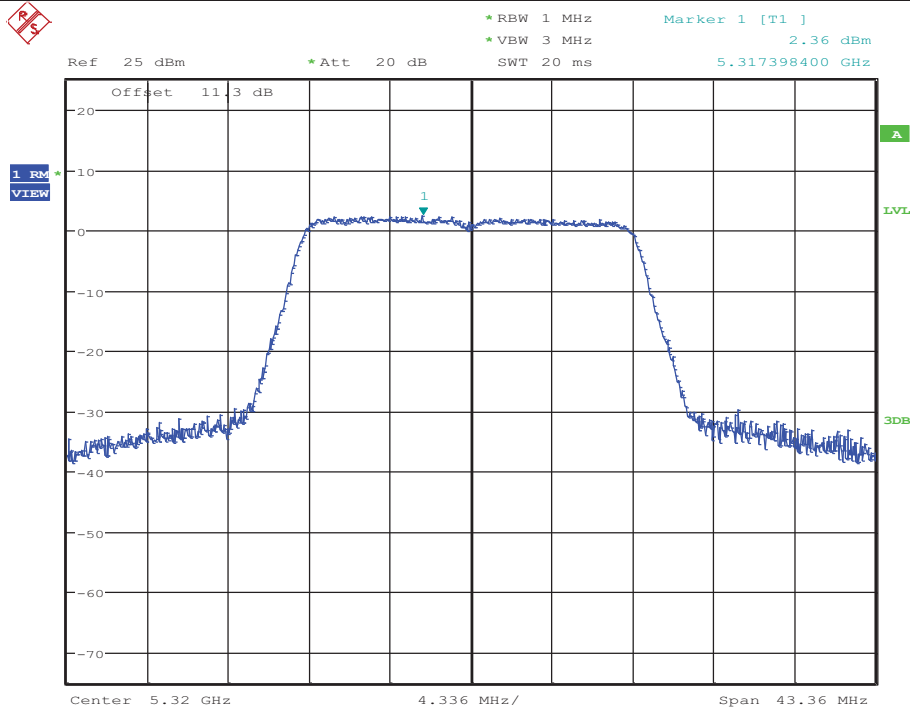

Date: 17.OCT.2017 09:40:01

Maximum Power Spectral Density\_TNVN\_11AC20MIMO\_5320\_Ant2

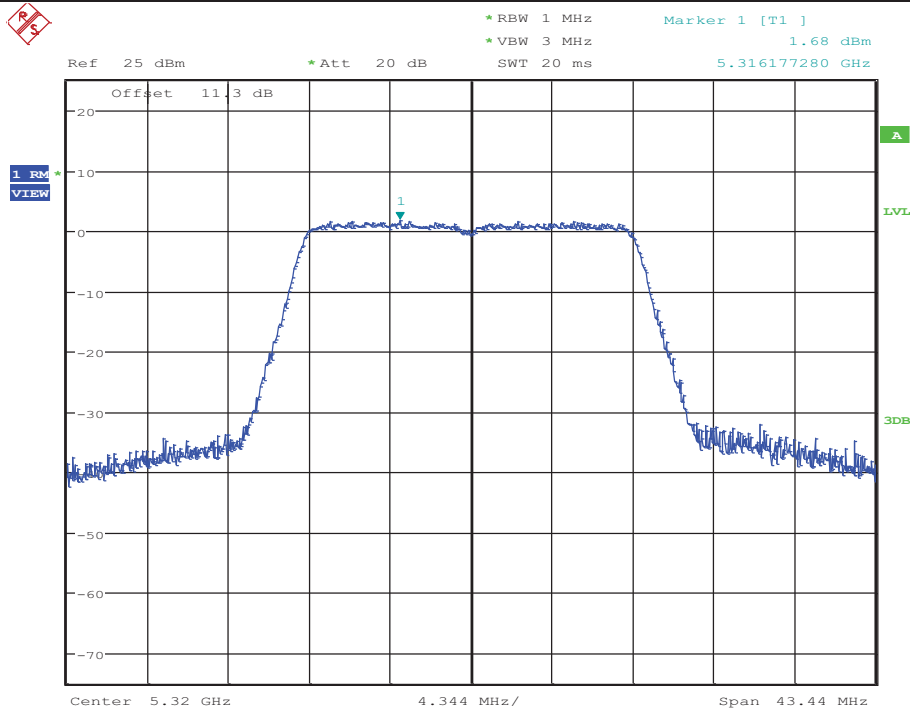

Date: 17.OCT.2017 14:49:05

Maximum Power Spectral Density\_TNVN\_11AC20MIMO\_5500\_Ant1

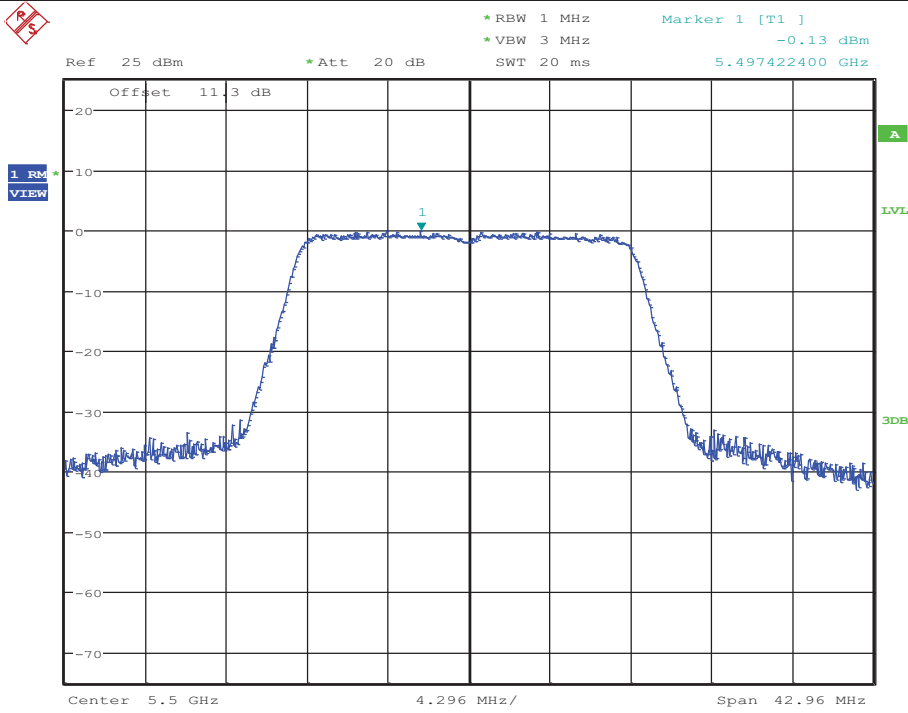

Date: 17.OCT.2017 09:45:12

Maximum Power Spectral Density\_TNVN\_11AC20MIMO\_5500\_Ant2

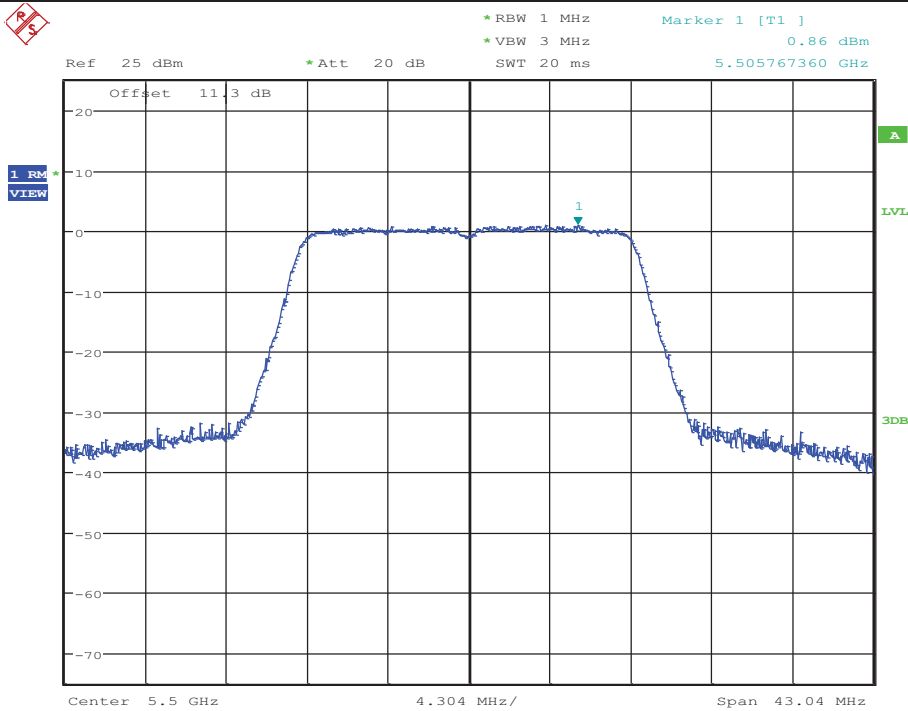

Date: 17.OCT.2017 14:54:24



Maximum Power Spectral Density\_TNVN\_11AC20MIMO\_5580\_Ant1

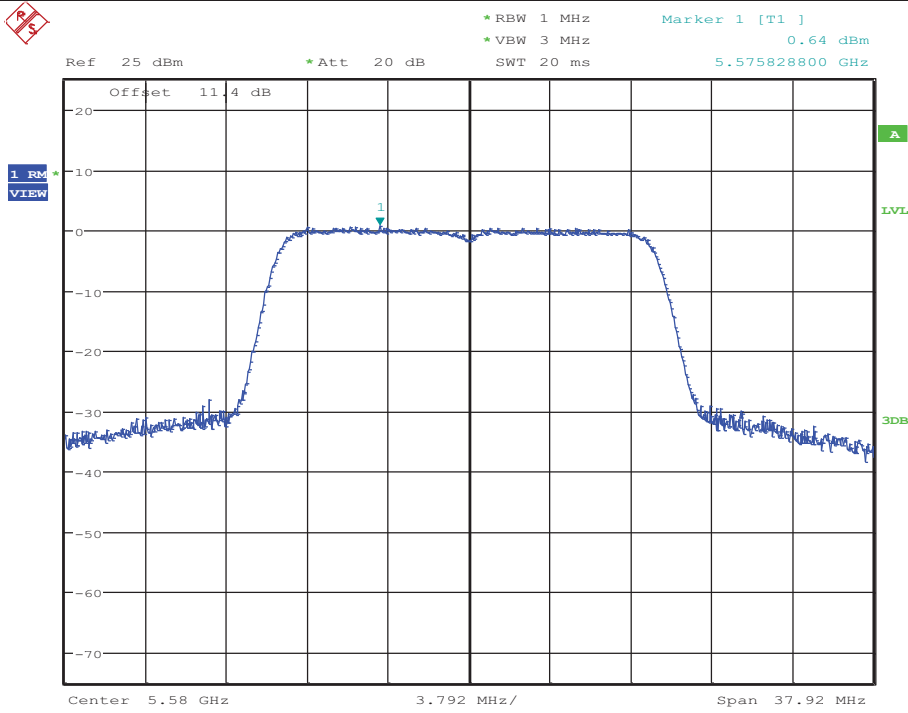

Date: 17.OCT.2017 09:51:25

Maximum Power Spectral Density\_TNVN\_11AC20MIMO\_5580\_Ant2

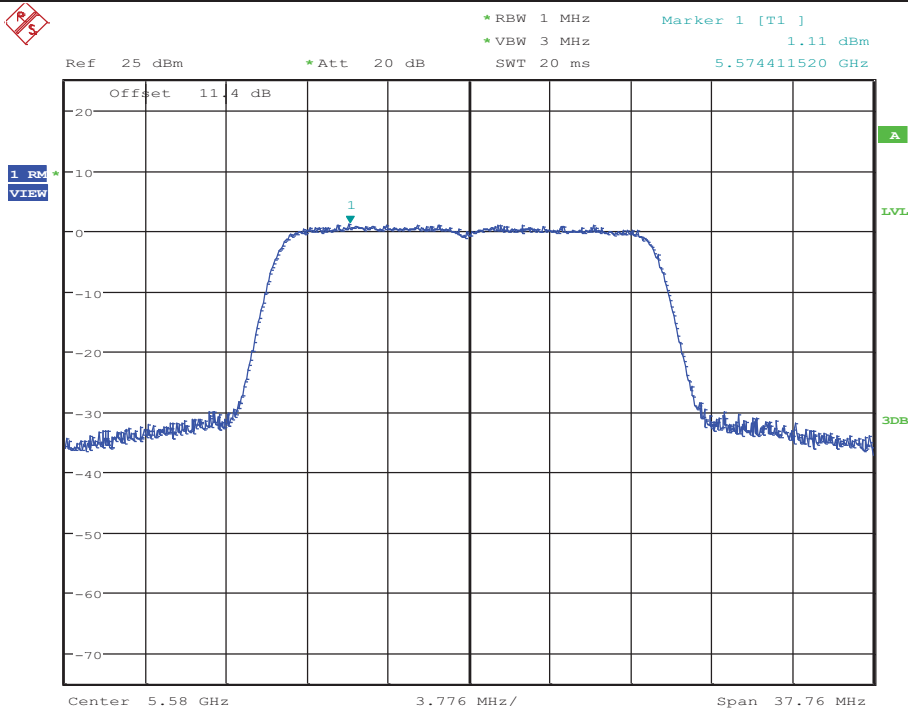

Date: 17.OCT.2017 14:59:39

Maximum Power Spectral Density\_TNVN\_11AC20MIMO\_5700\_Ant1

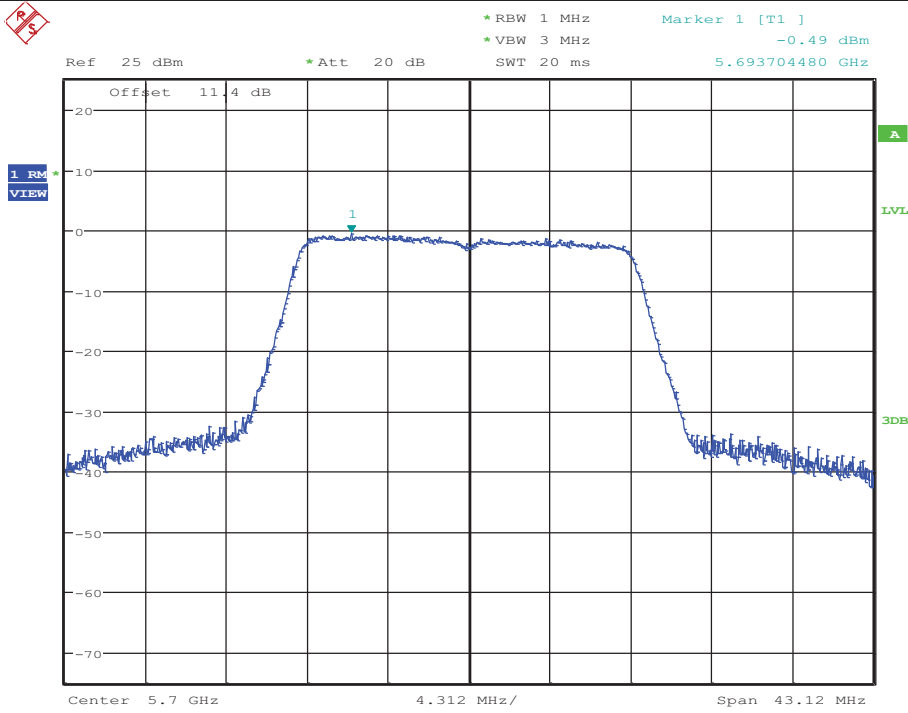

Date: 17.OCT.2017 09:56:25

Maximum Power Spectral Density\_TNVN\_11AC20MIMO\_5700\_Ant2

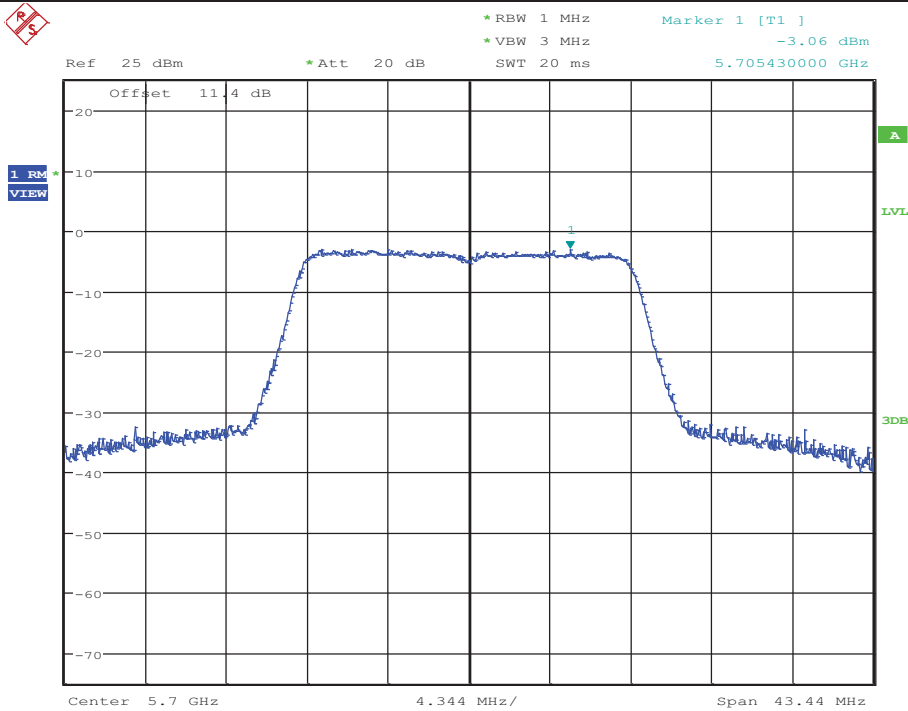

Date: 17.OCT.2017 15:04:35

Maximum Power Spectral Density\_TNVN\_11AC20MIMO\_5745\_Ant1

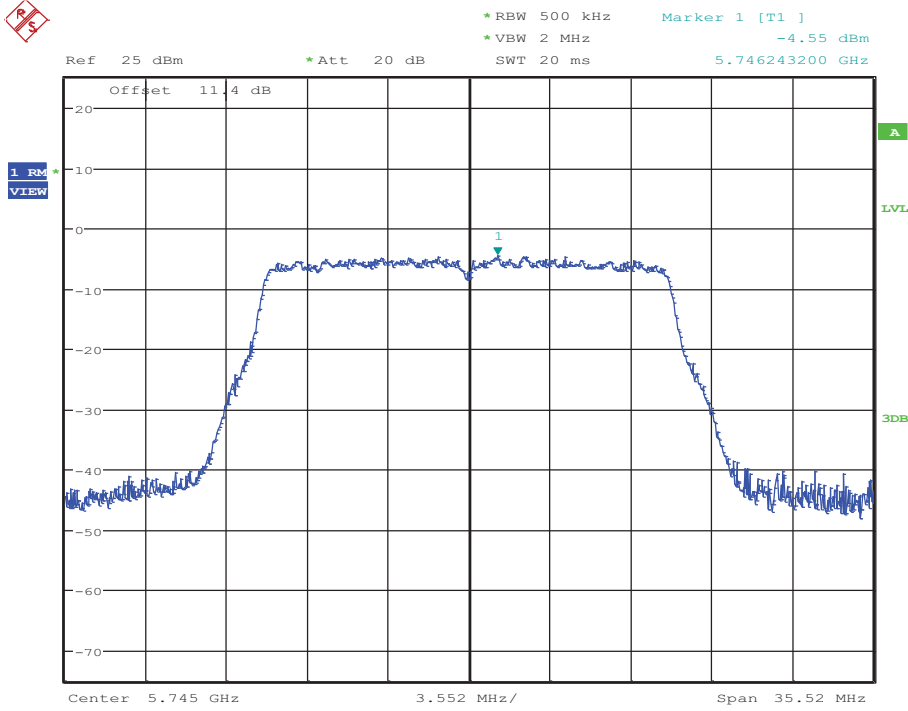

Date: 17.OCT.2017 10:05:36

Maximum Power Spectral Density\_TNVN\_11AC20MIMO\_5745\_Ant2

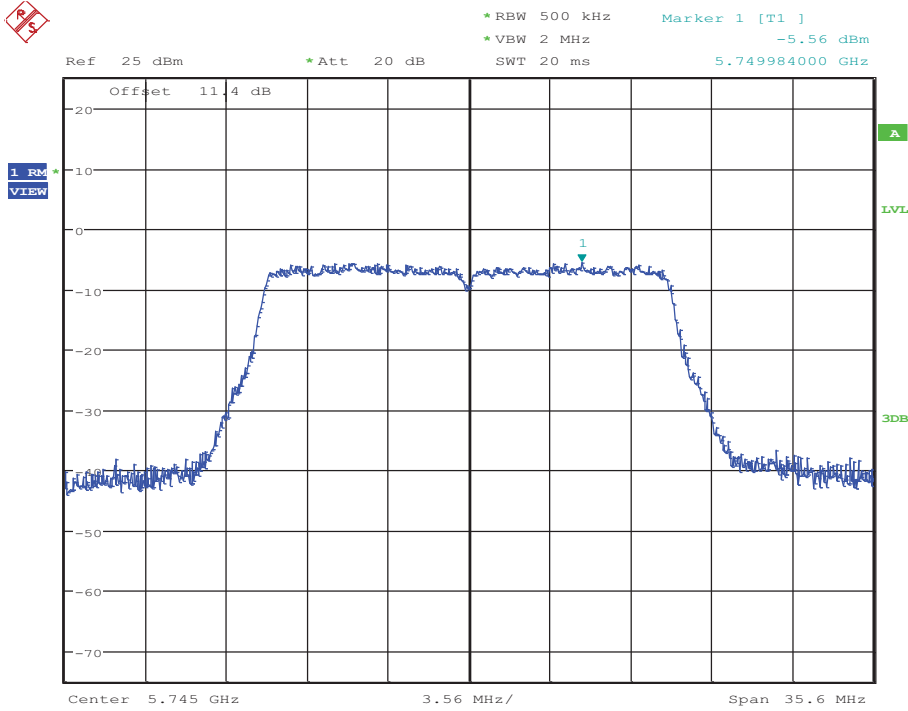

Date: 17.OCT.2017 15:08:51

Maximum Power Spectral Density\_TNVN\_11AC20MIMO\_5785\_Ant1

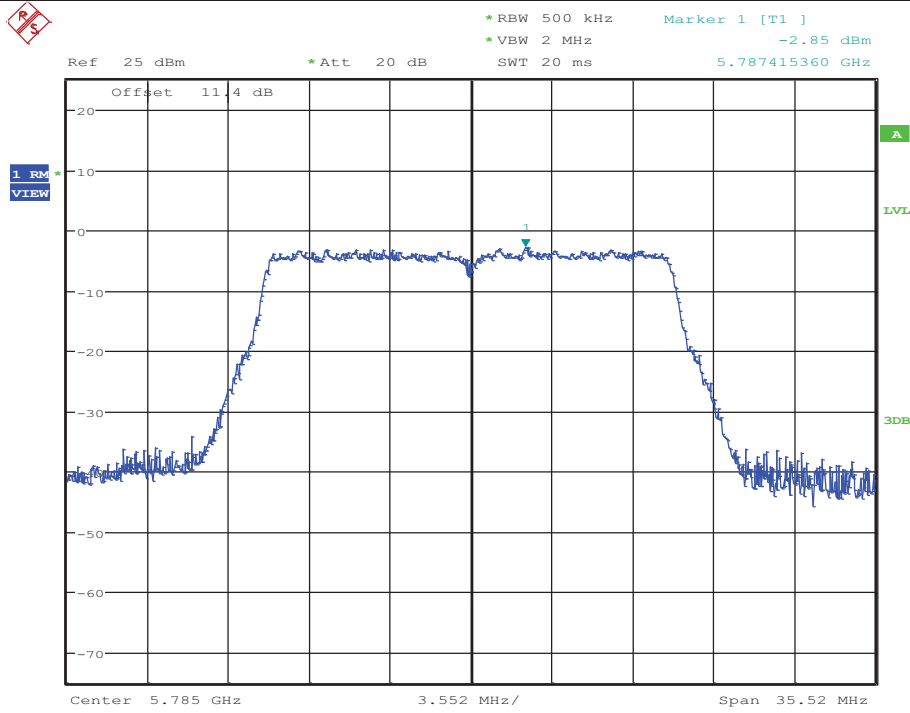

Date: 17.OCT.2017 10:11:22

Maximum Power Spectral Density\_TNVN\_11AC20MIMO\_5785\_Ant2

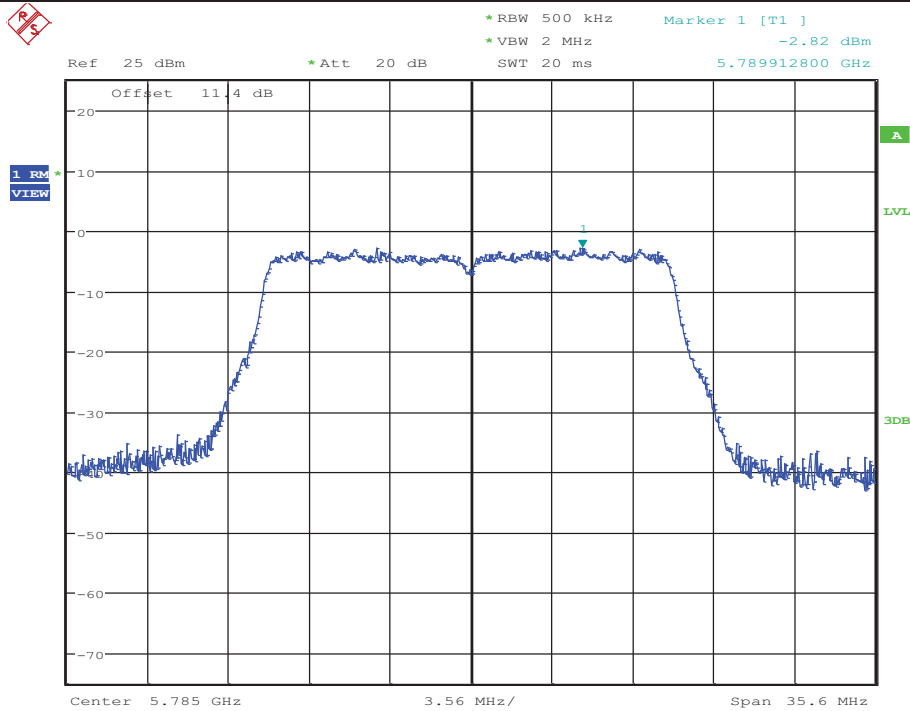

Date: 17.OCT.2017 15:13:03

### Maximum Power Spectral Density\_TNVN\_11AC20MIMO\_5825\_Ant1

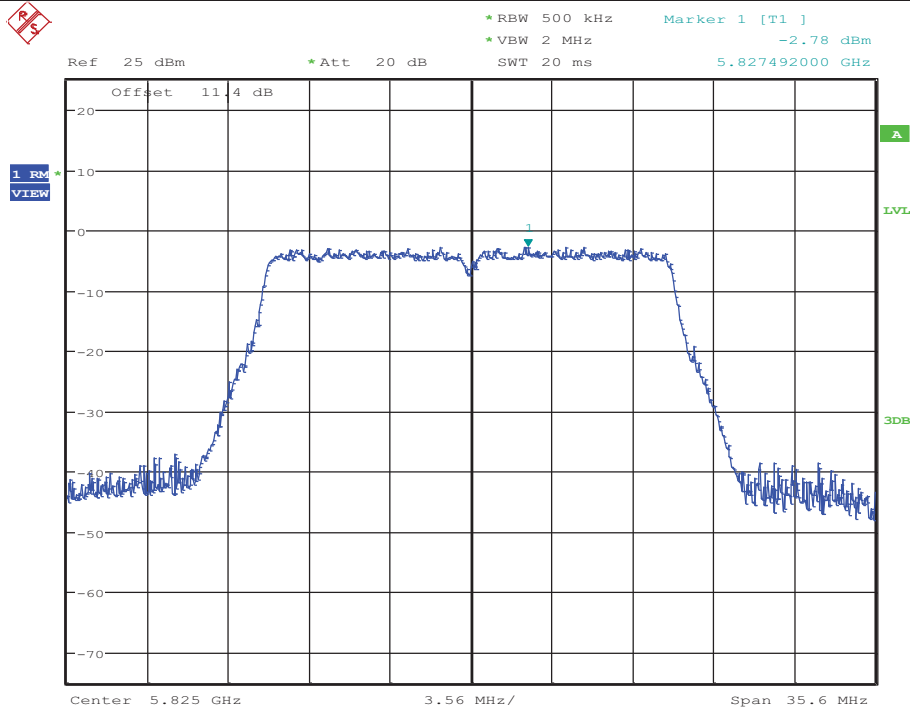

Date: 17.OCT.2017 10:15:06

### Maximum Power Spectral Density\_TNVN\_11AC20MIMO\_5825\_Ant2

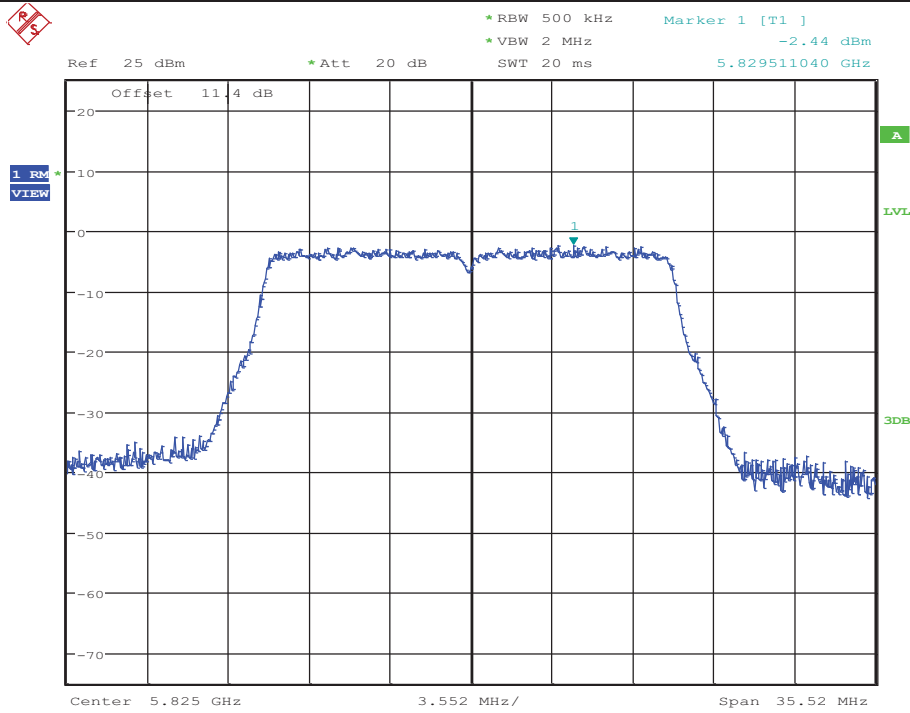

Date: 17.OCT.2017 15:16:56

Maximum Power Spectral Density\_TNVN\_11AC40MIMO\_5190\_Ant1

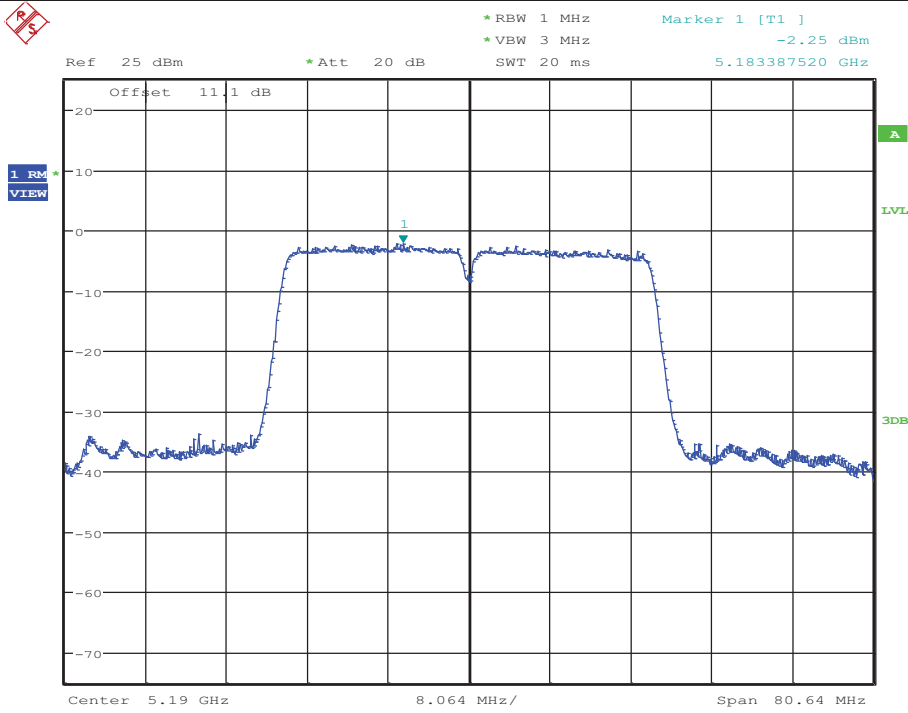

Date: 17.OCT.2017 10:23:41

Maximum Power Spectral Density\_TNVN\_11AC40MIMO\_5190\_Ant2

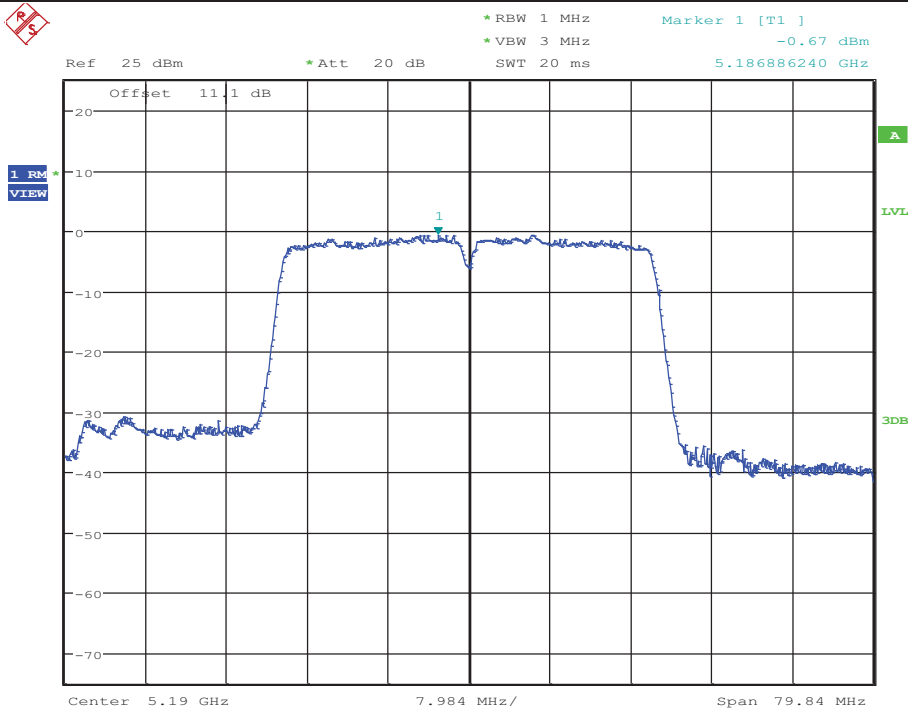

Date: 17.OCT.2017 15:21:34

### Maximum Power Spectral Density\_TNVN\_11AC40MIMO\_5230\_Ant1

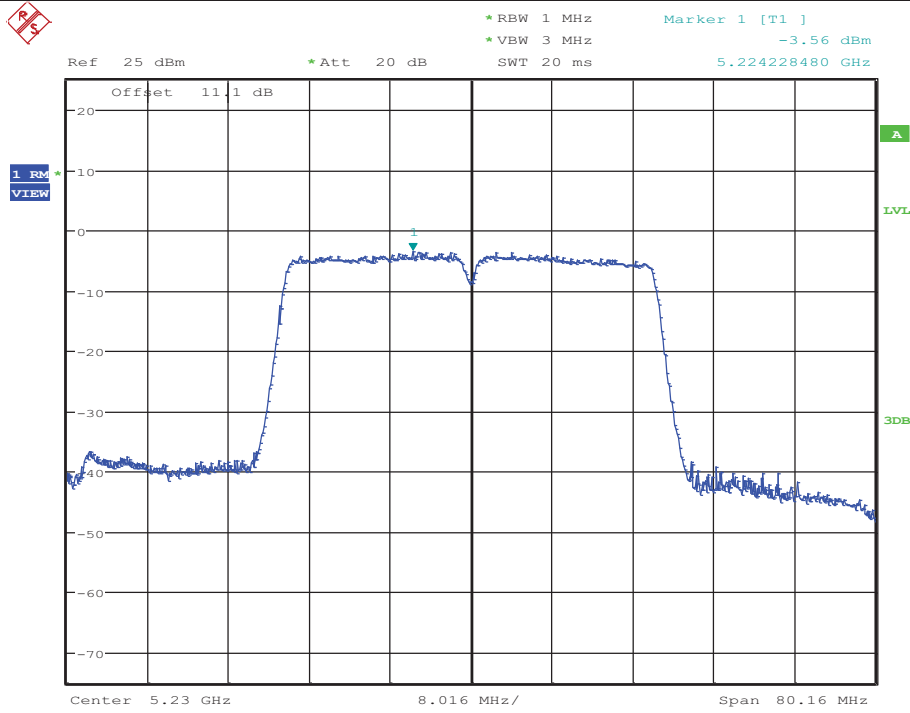

Date: 17.OCT.2017 10:28:29

### Maximum Power Spectral Density\_TNVN\_11AC40MIMO\_5230\_Ant2

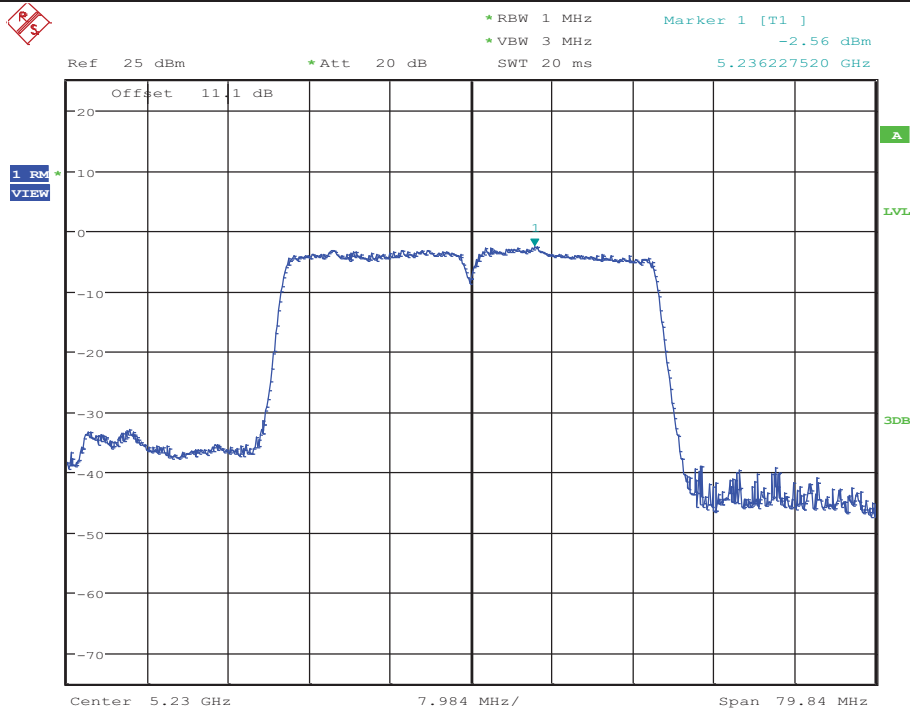

Date: 17.OCT.2017 15:26:07

Maximum Power Spectral Density\_TNVN\_11AC40MIMO\_5270\_Ant1

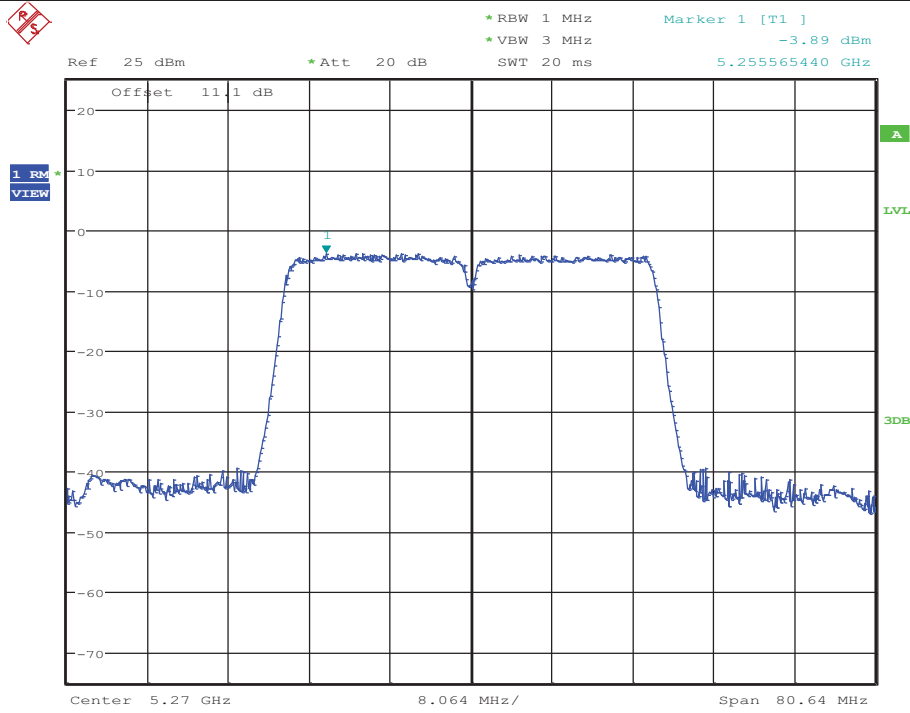

Date: 17.OCT.2017 10:33:15

Maximum Power Spectral Density\_TNVN\_11AC40MIMO\_5270\_Ant2

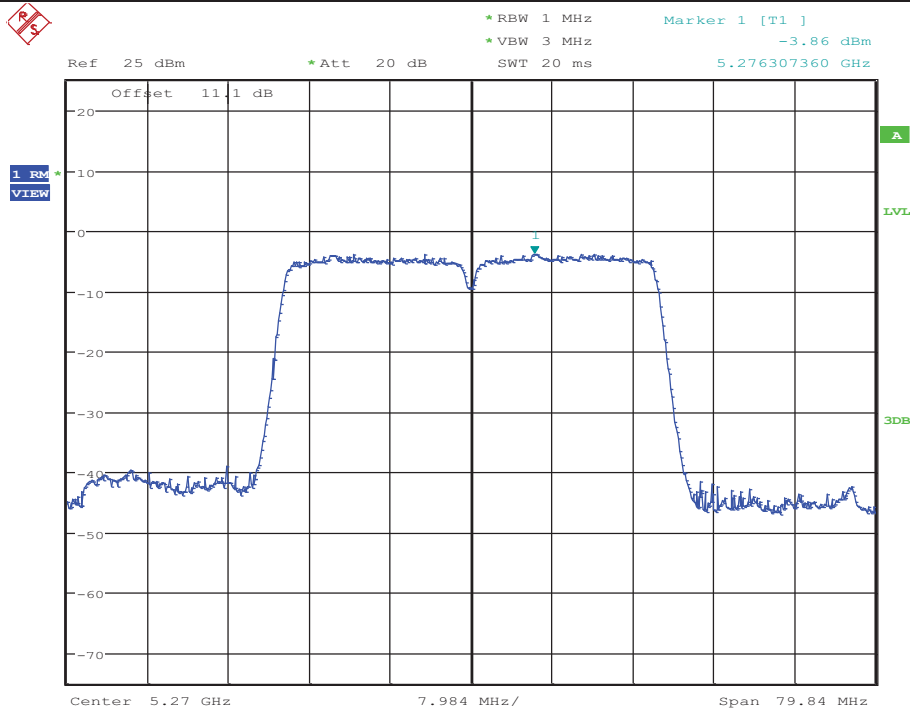

Date: 17.OCT.2017 17:09:53



Maximum Power Spectral Density\_TNVN\_11AC40MIMO\_5310\_Ant1

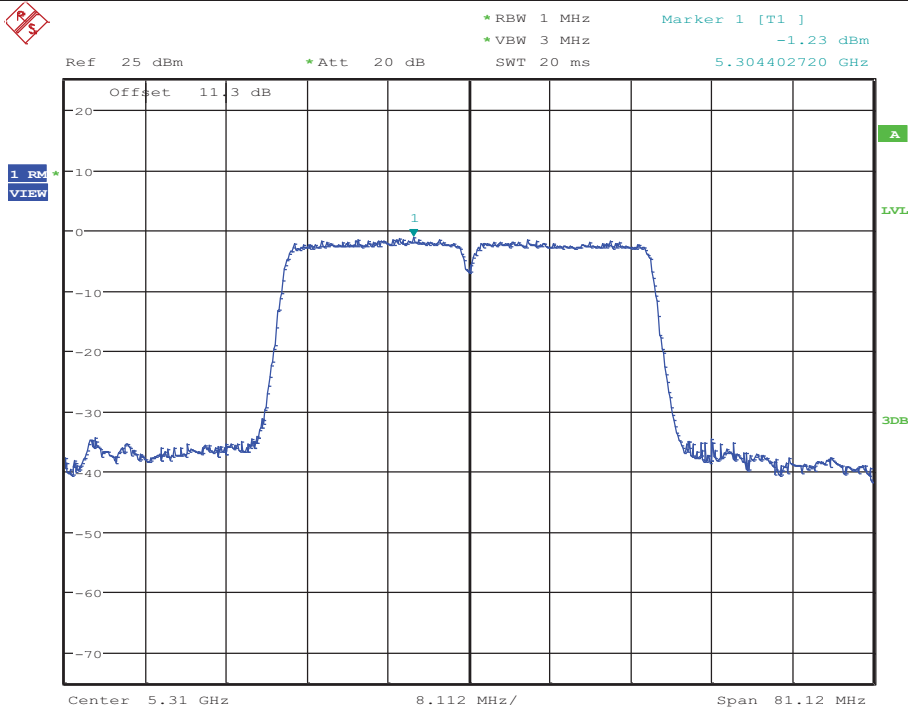

Date: 17.OCT.2017 10:40:14

Maximum Power Spectral Density\_TNVN\_11AC40MIMO\_5310\_Ant2

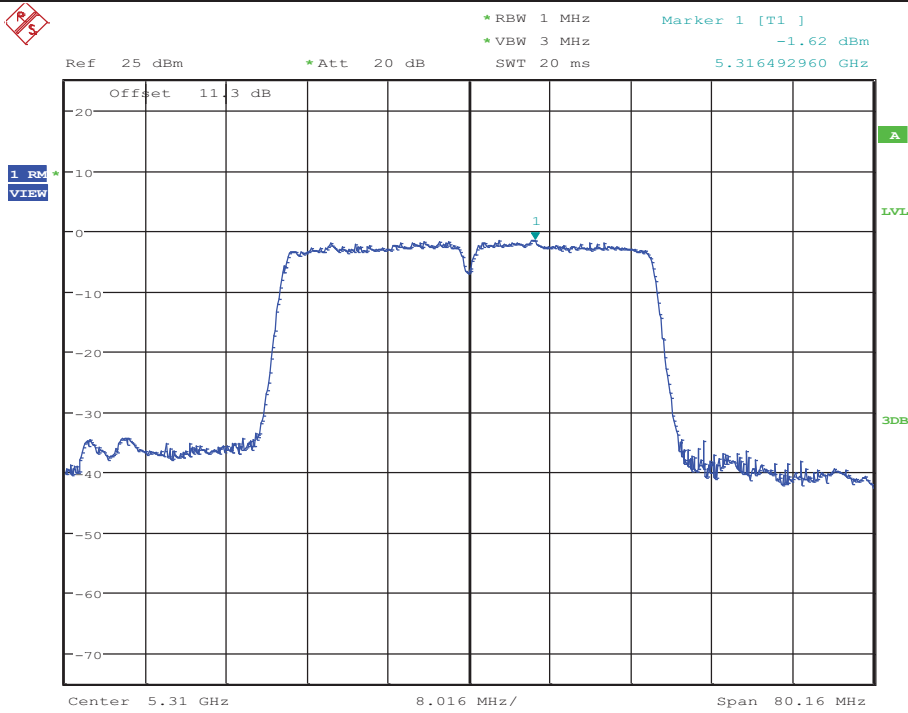

Date: 17.OCT.2017 17:14:49

Maximum Power Spectral Density\_TNVN\_11AC40MIMO\_5510\_Ant1

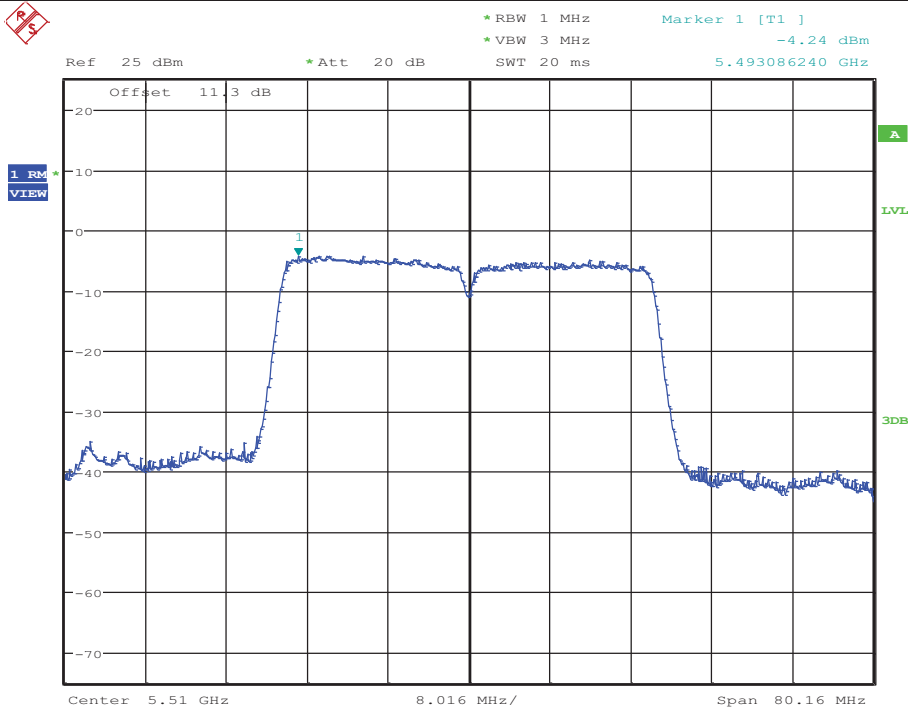

Date: 17.OCT.2017 10:46:27

Maximum Power Spectral Density\_TNVN\_11AC40MIMO\_5510\_Ant2

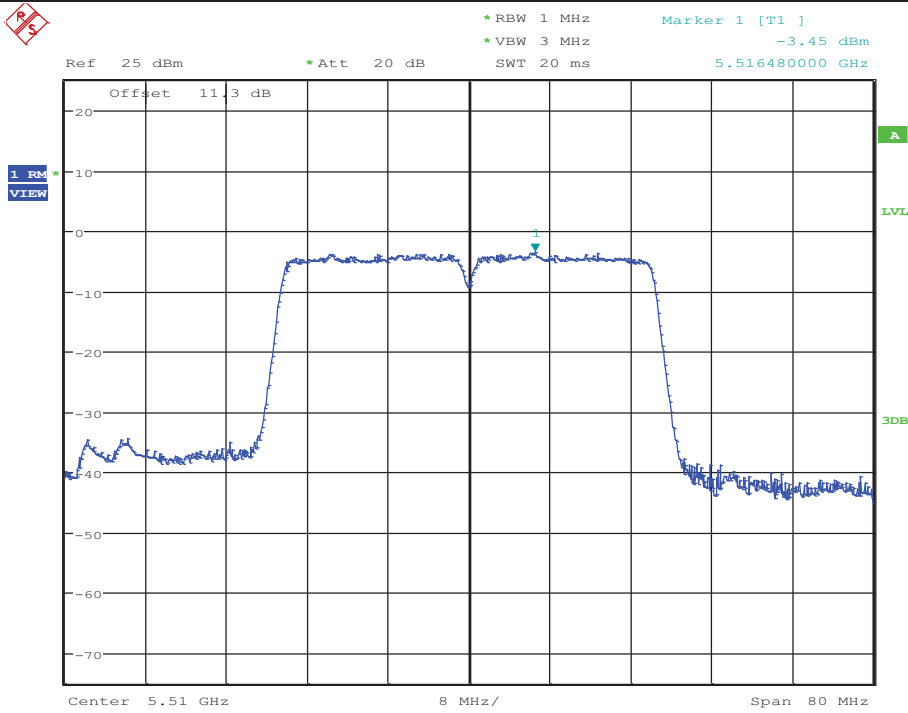

Date: 17.OCT.2017 17:20:14

### Maximum Power Spectral Density\_TNVN\_11AC40MIMO\_5550\_Ant1

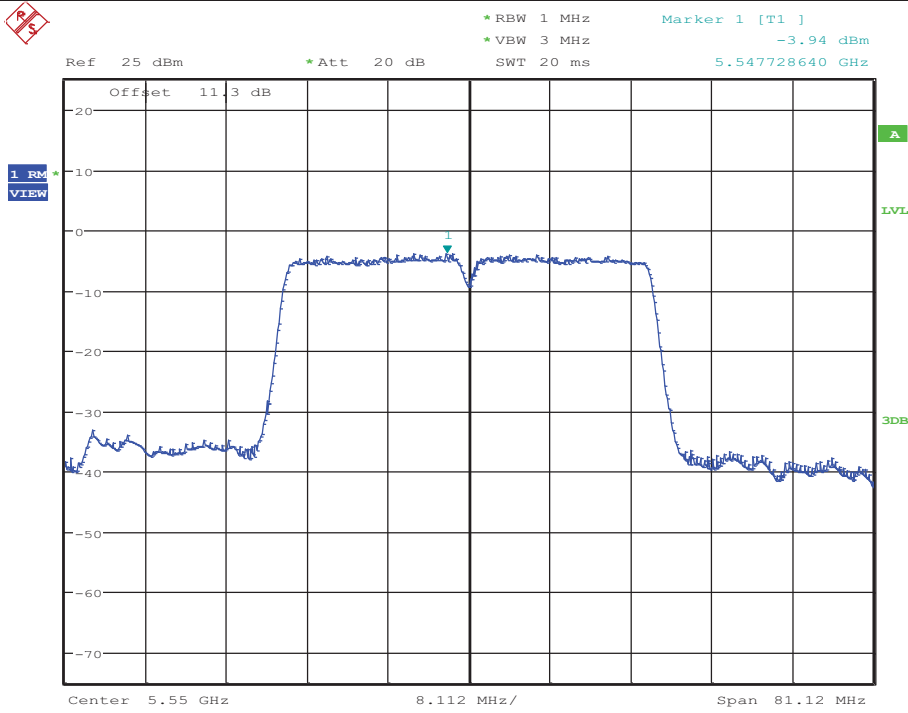

Date: 17.OCT.2017 10:53:10

### Maximum Power Spectral Density\_TNVN\_11AC40MIMO\_5550\_Ant2

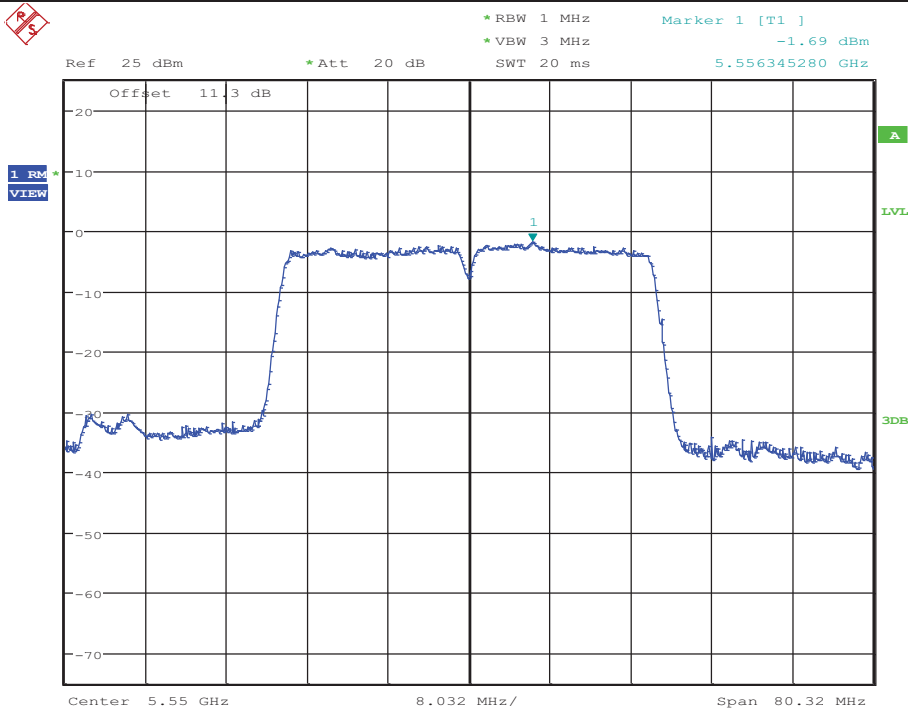

Date: 17.OCT.2017 17:24:51

### Maximum Power Spectral Density\_TNVN\_11AC40MIMO\_5670\_Ant1

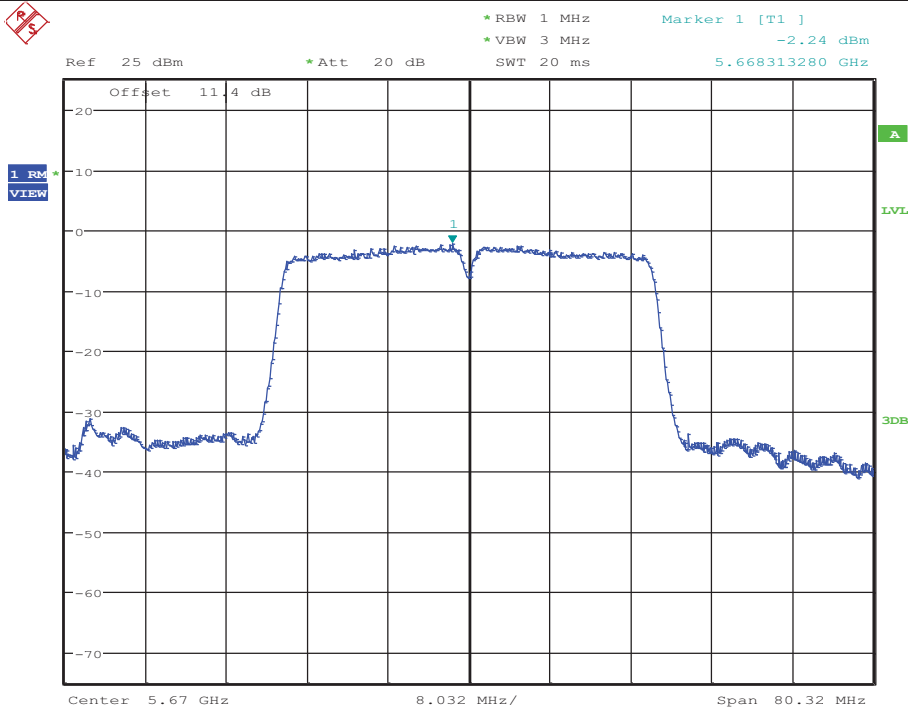

Date: 17.OCT.2017 10:57:52

### Maximum Power Spectral Density\_TNVN\_11AC40MIMO\_5670\_Ant2

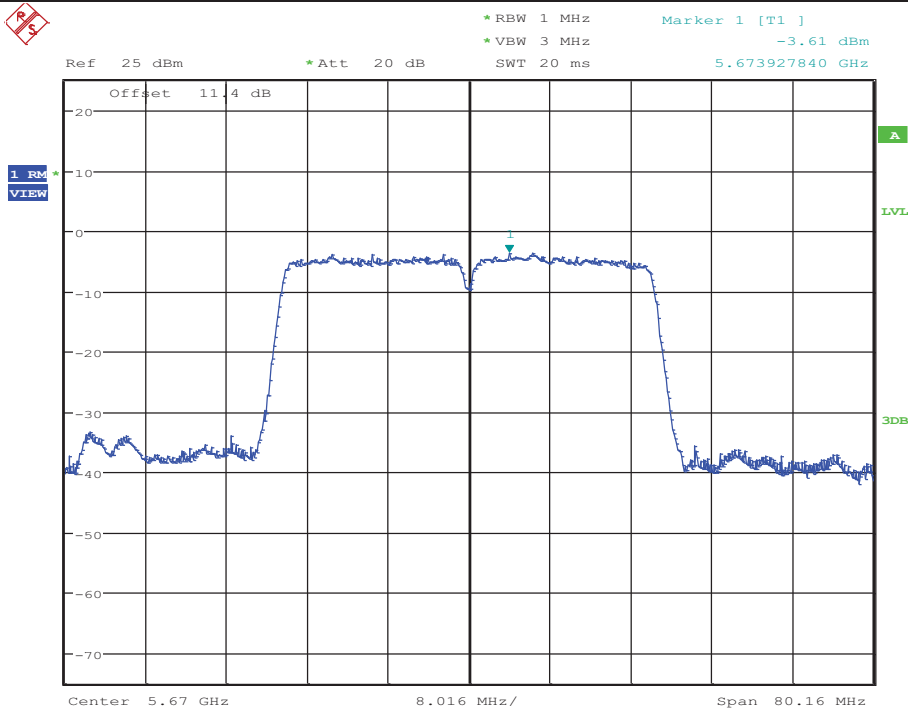

Date: 17.OCT.2017 17:30:16

Maximum Power Spectral Density\_TNVN\_11AC40MIMO\_5755\_Ant1

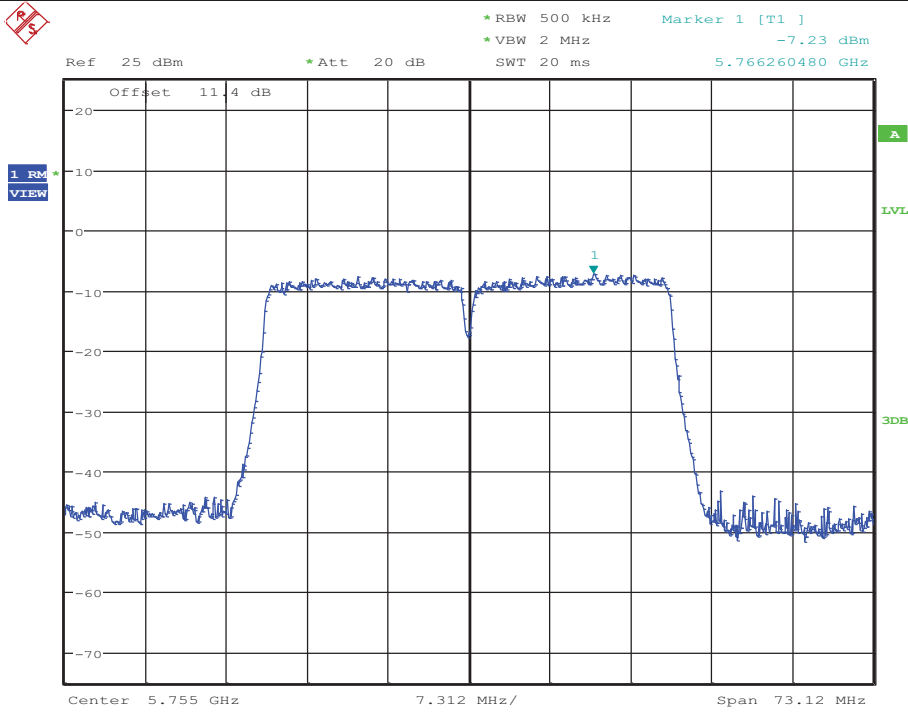

Date: 17.OCT.2017 11:03:25

Maximum Power Spectral Density\_TNVN\_11AC40MIMO\_5755\_Ant2

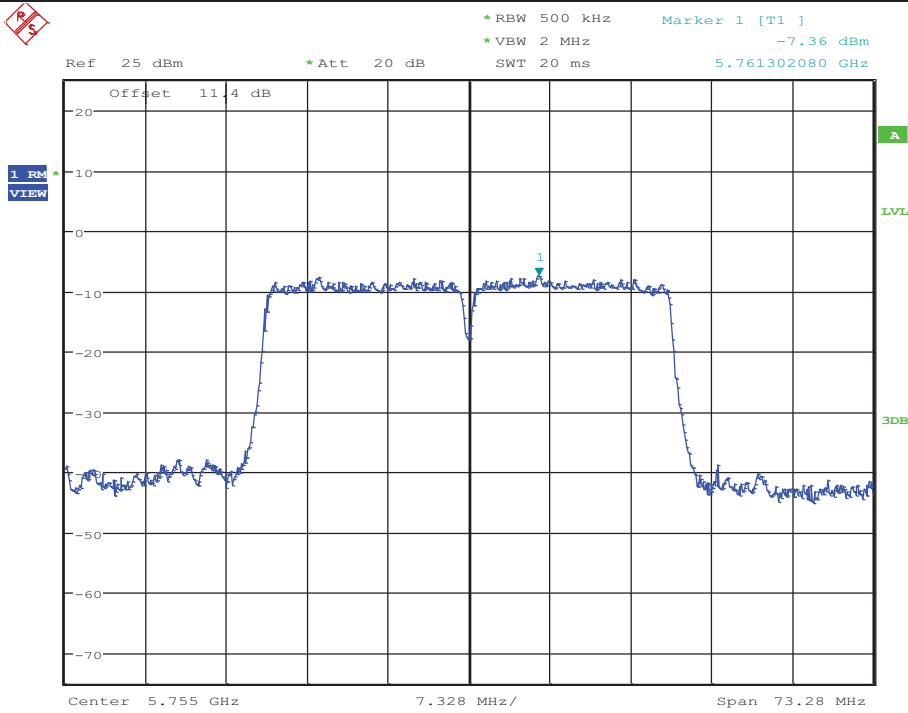

Date: 17.OCT.2017 17:35:05

Maximum Power Spectral Density\_TNVN\_11AC40MIMO\_5795\_Ant1

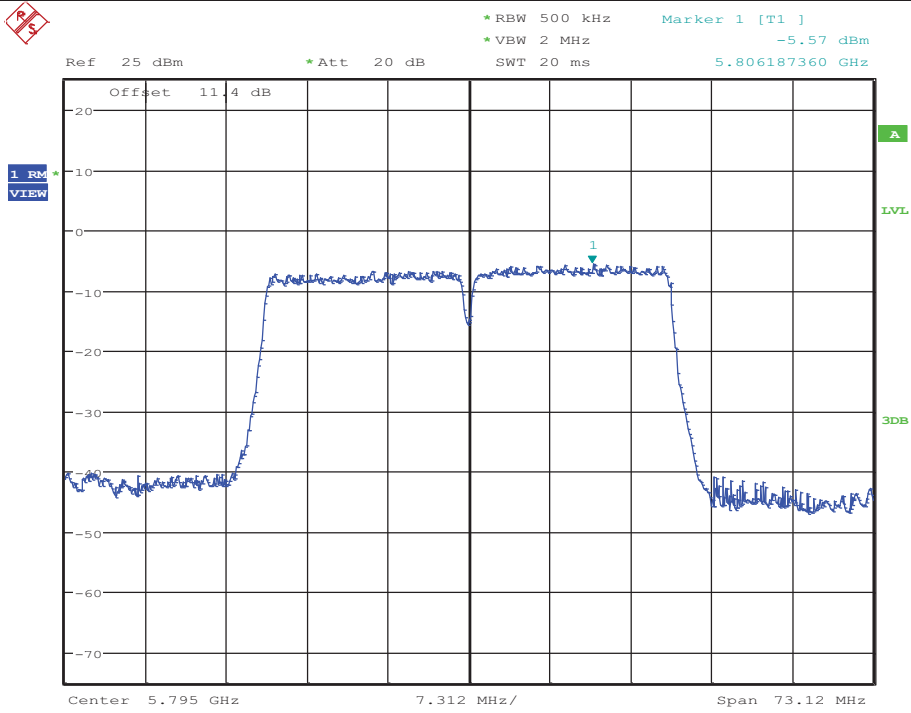

Date: 17.OCT.2017 11:08:02

Maximum Power Spectral Density\_TNVN\_11AC40MIMO\_5795\_Ant2

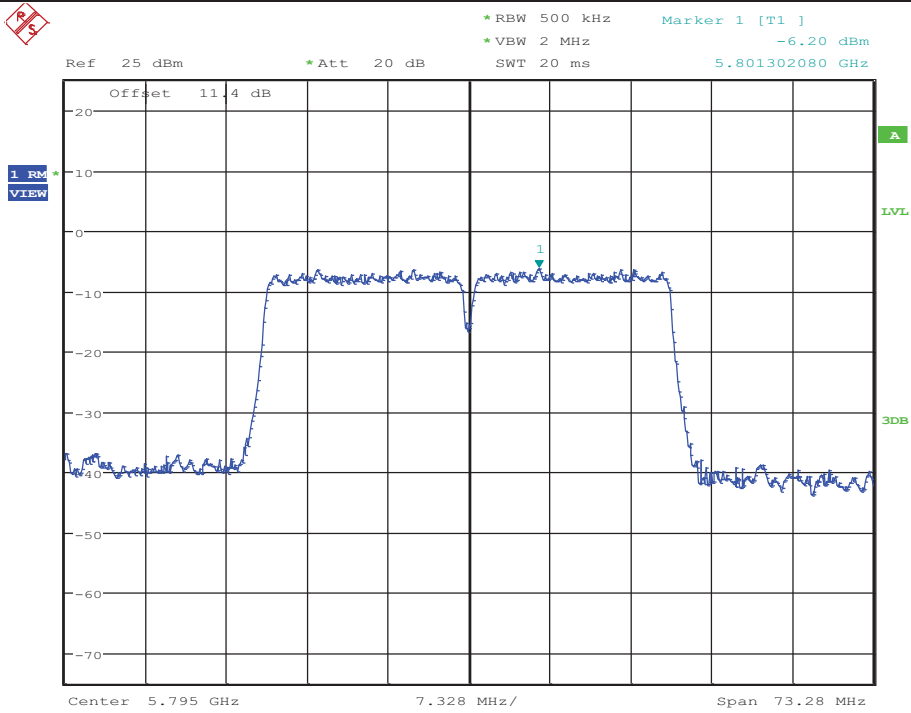

Date: 17.OCT.2017 17:39:43

### Maximum Power Spectral Density\_TNVN\_11AC80MIMO\_5210\_Ant1

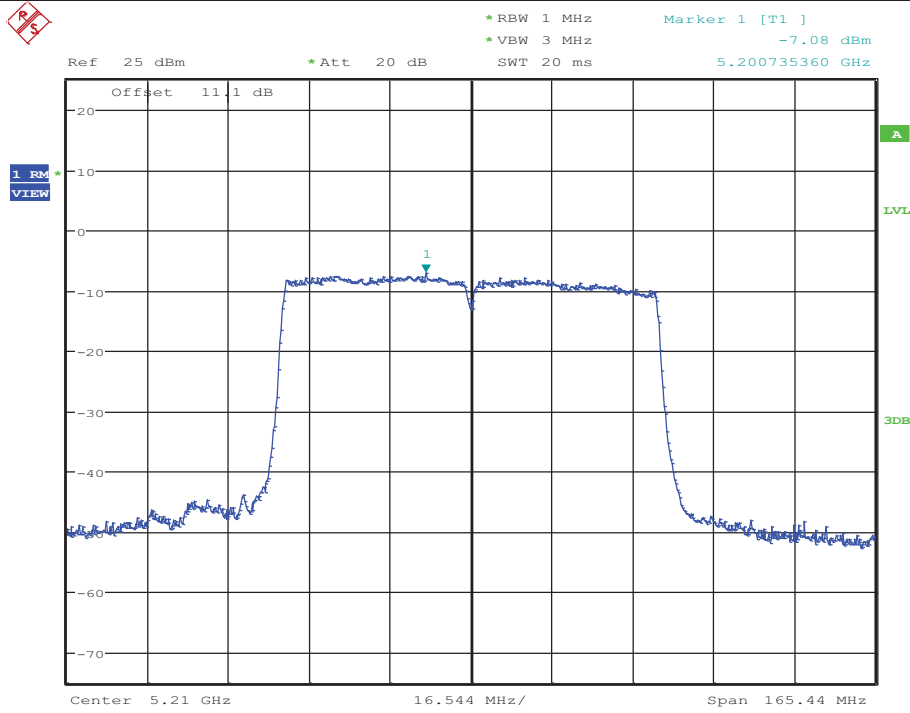

Date: 17.OCT.2017 11:13:15

### Maximum Power Spectral Density\_TNVN\_11AC80MIMO\_5210\_Ant2

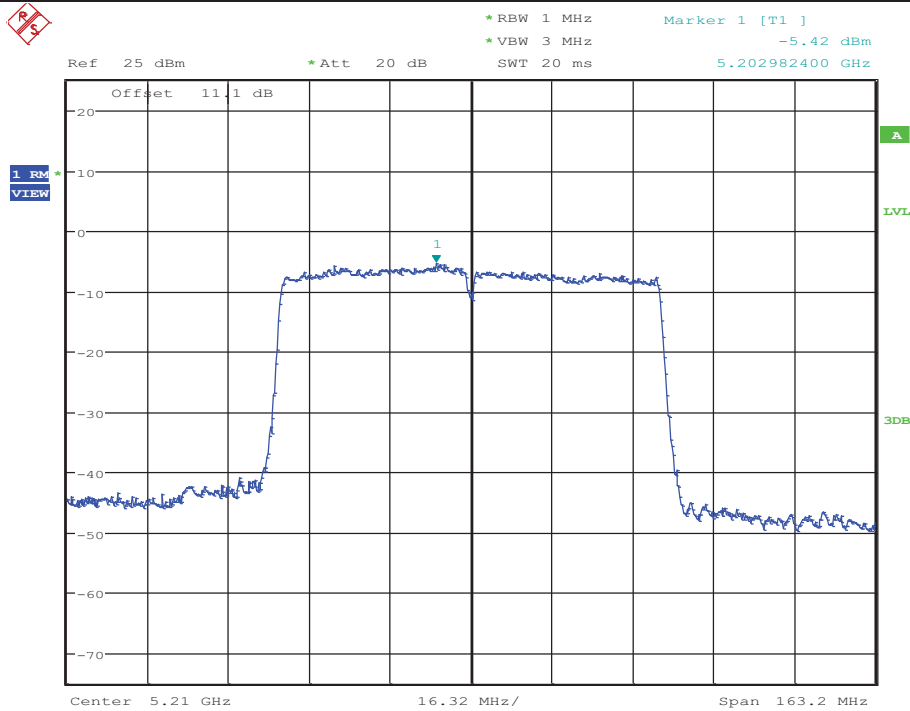

Date: 17.OCT.2017 17:44:54

Maximum Power Spectral Density\_TNVN\_11AC80MIMO\_5290\_Ant1

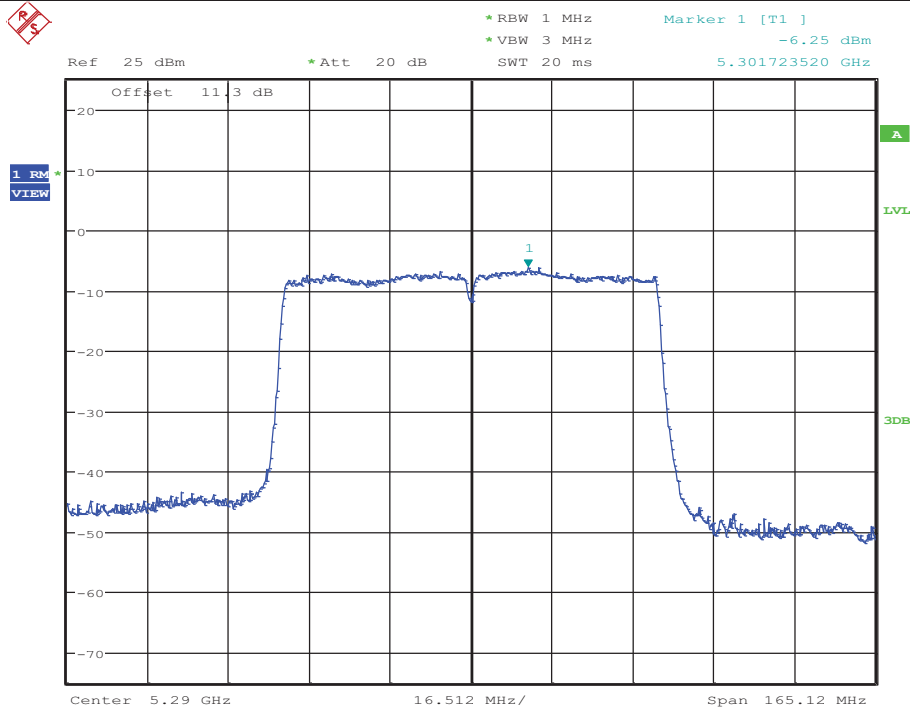

Date: 17.OCT.2017 11:24:16

Maximum Power Spectral Density\_TNVN\_11AC80MIMO\_5290\_Ant2

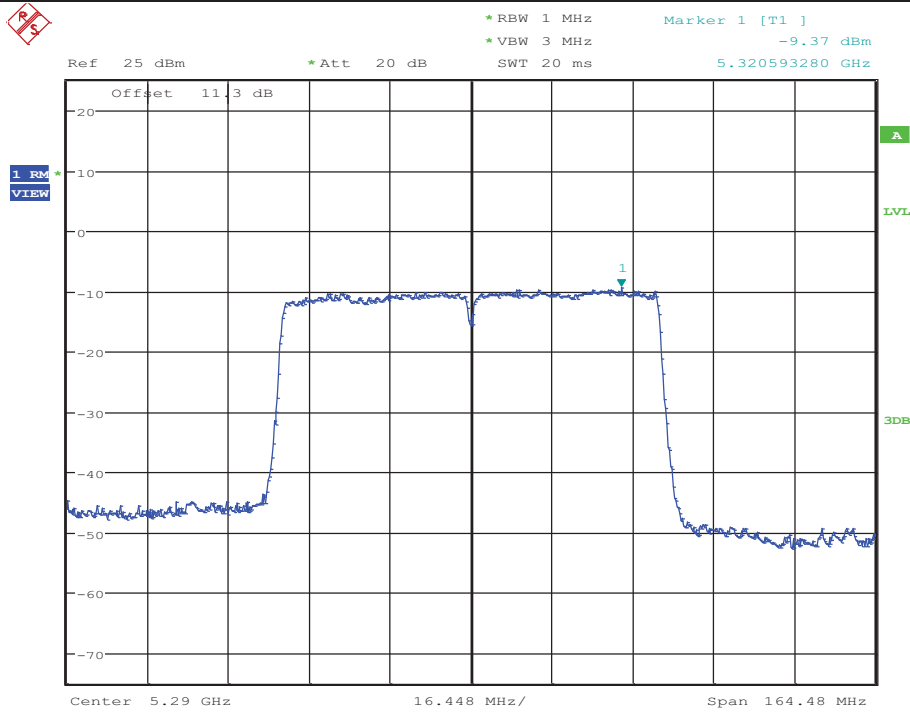

Date: 17.OCT.2017 18:49:14



Maximum Power Spectral Density\_TNVN\_11AC80MIMO\_5530\_Ant1

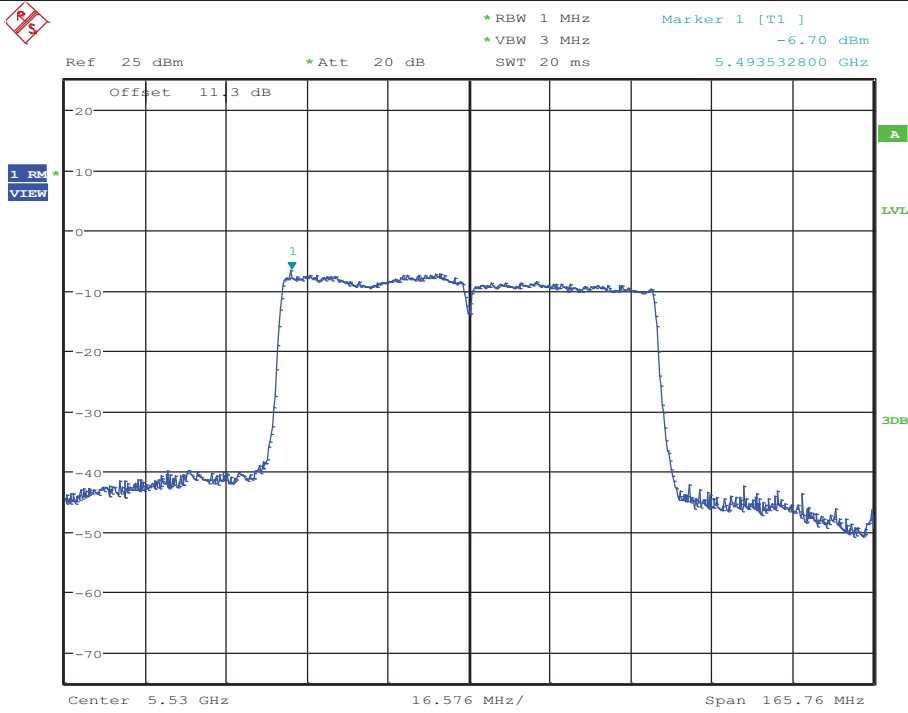

Date: 17.OCT.2017 11:29:42

Maximum Power Spectral Density\_TNVN\_11AC80MIMO\_5530\_Ant2

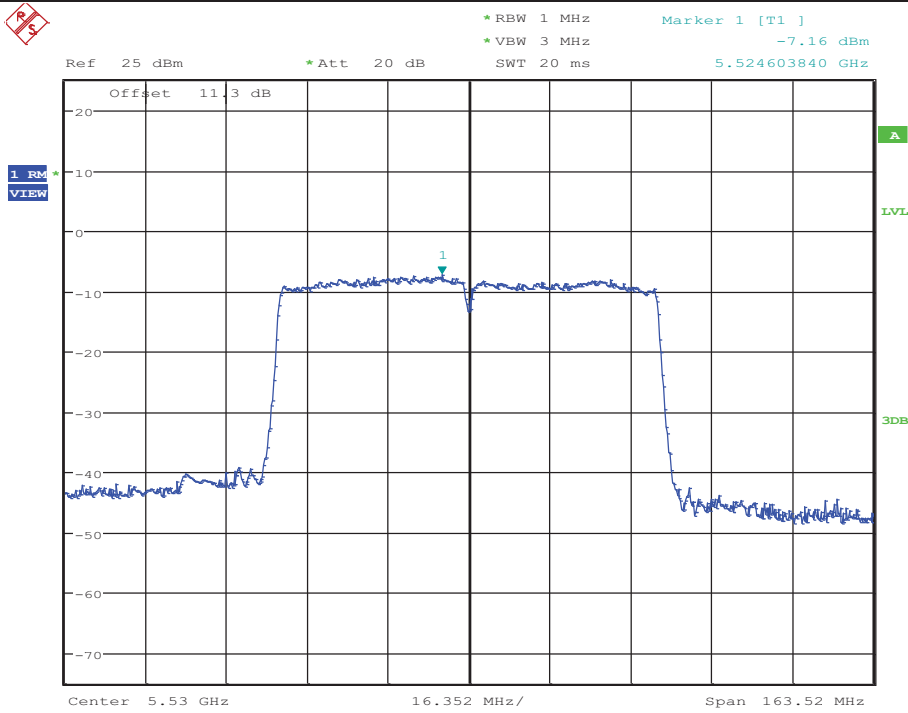

Date: 17.OCT.2017 18:54:51

Maximum Power Spectral Density\_TNVN\_11AC80MIMO\_5775\_Ant1

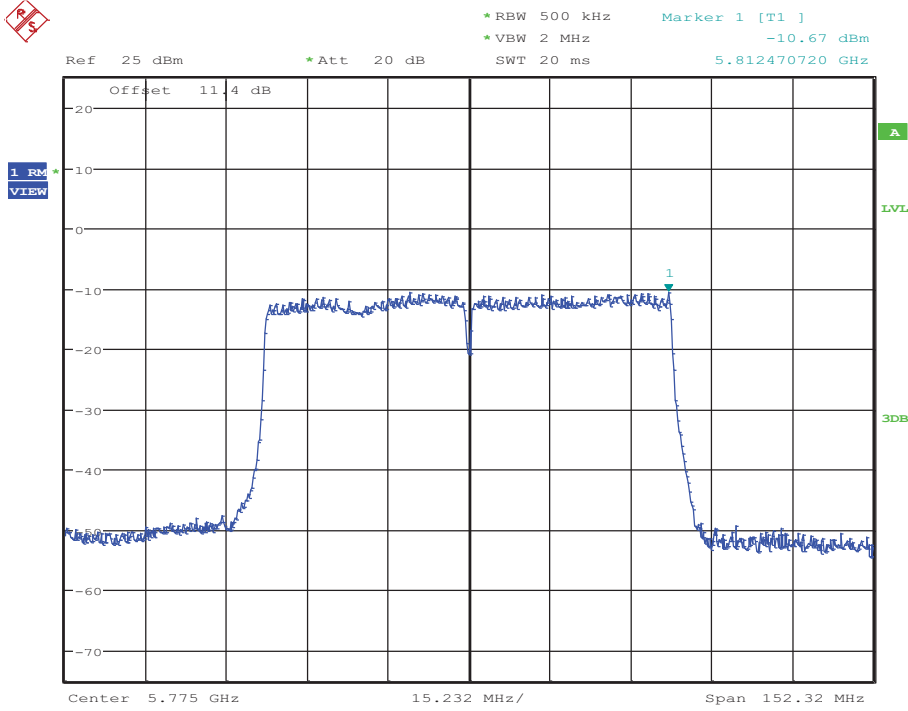

Date: 17.OCT.2017 11:37:26

Maximum Power Spectral Density\_TNVN\_11AC80MIMO\_5775\_Ant2

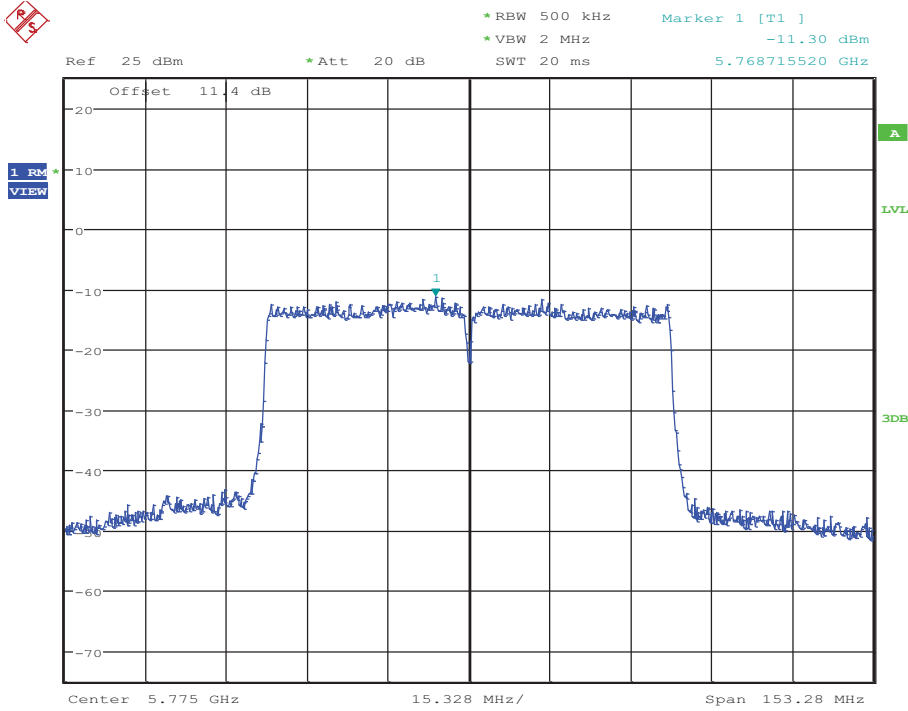

Date: 17.OCT.2017 19:00:54

### Maximum Power Spectral Density\_TNVN\_11AMIMO\_5180\_Ant1

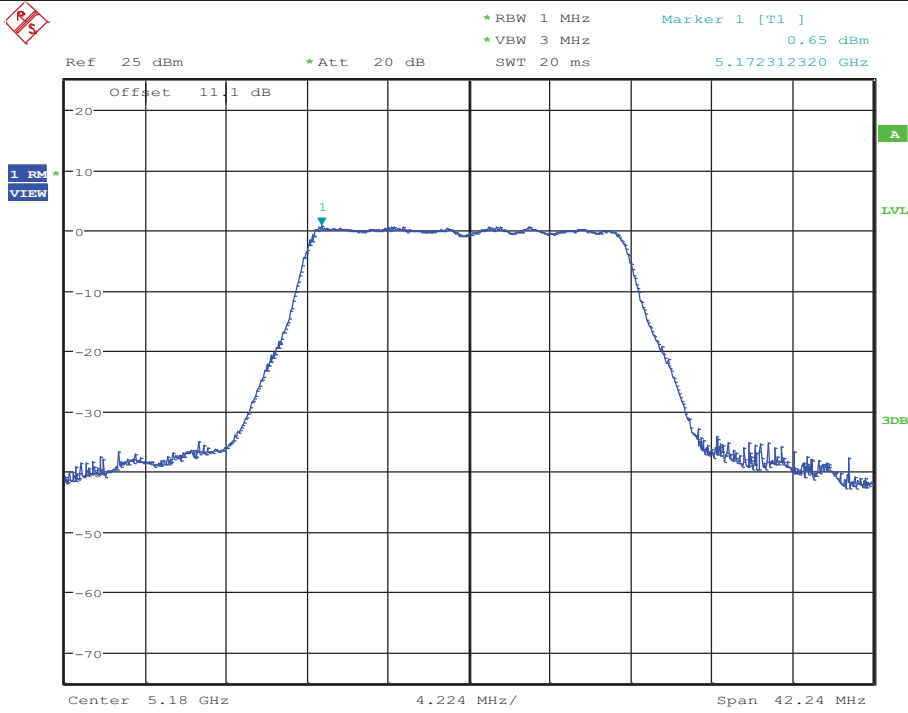

Date: 13.OCT.2017 19:36:02

### Maximum Power Spectral Density\_TNVN\_11AMIMO\_5180\_Ant2

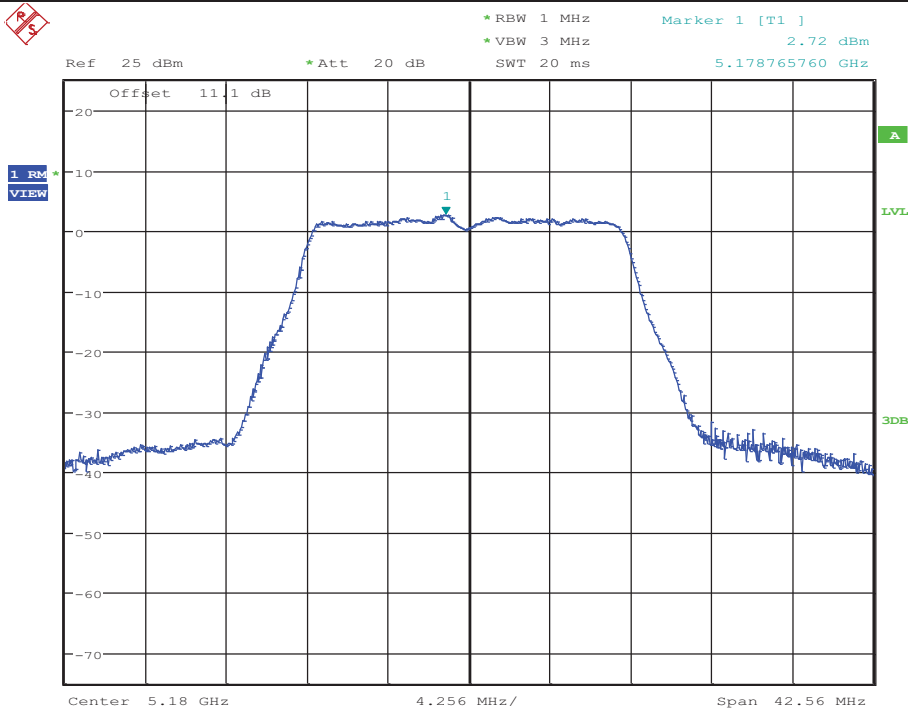

Date: 13.OCT.2017 19:42:04

### Maximum Power Spectral Density\_TNVN\_11AMIMO\_5200\_Ant1

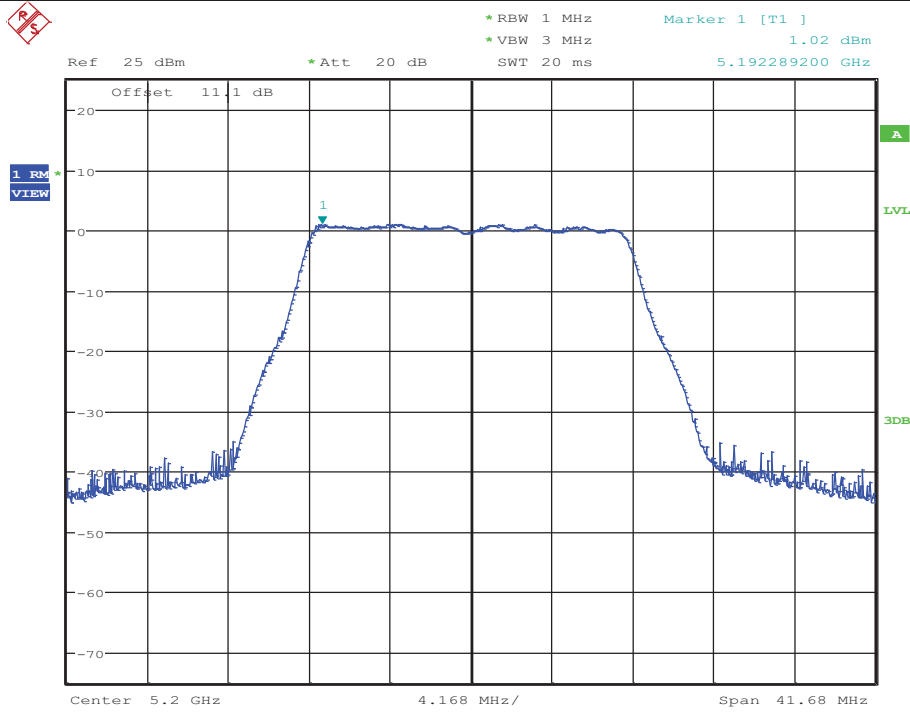

Date: 13.OCT.2017 19:48:53

### Maximum Power Spectral Density\_TNVN\_11AMIMO\_5200\_Ant2

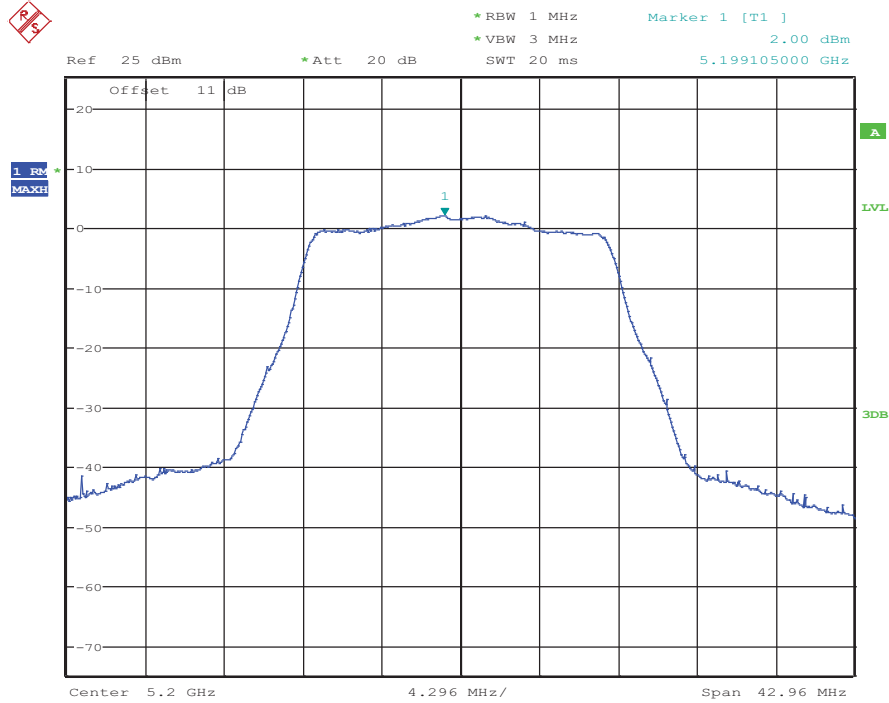

Date: 14.OCT.2017 15:48:23

### Maximum Power Spectral Density\_TNVN\_11AMIMO\_5240\_Ant1

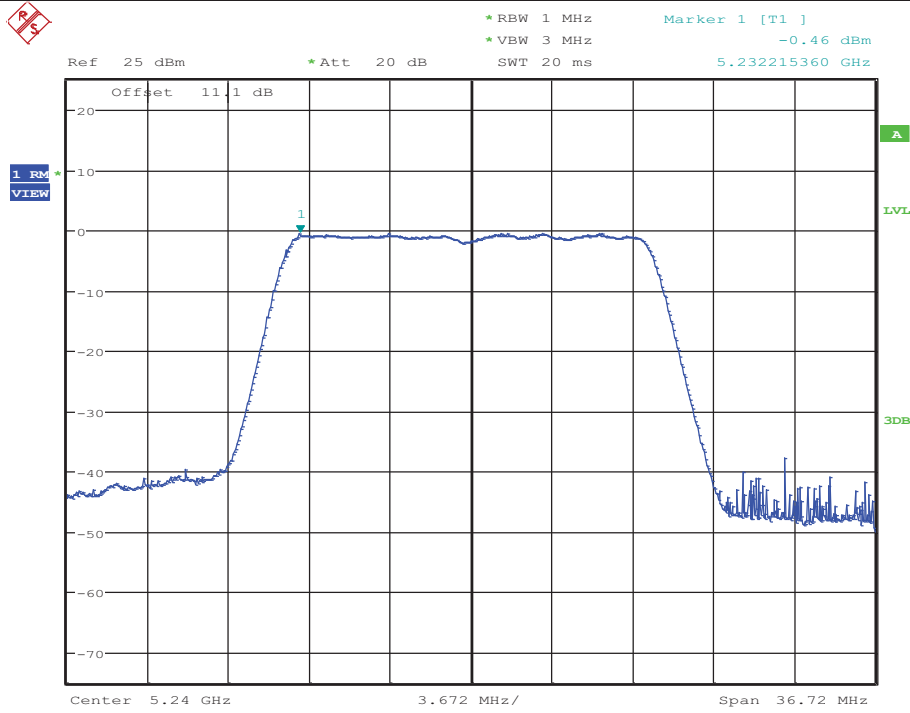

Date: 14.OCT.2017 09:27:59

### Maximum Power Spectral Density\_TNVN\_11AMIMO\_5240\_Ant2

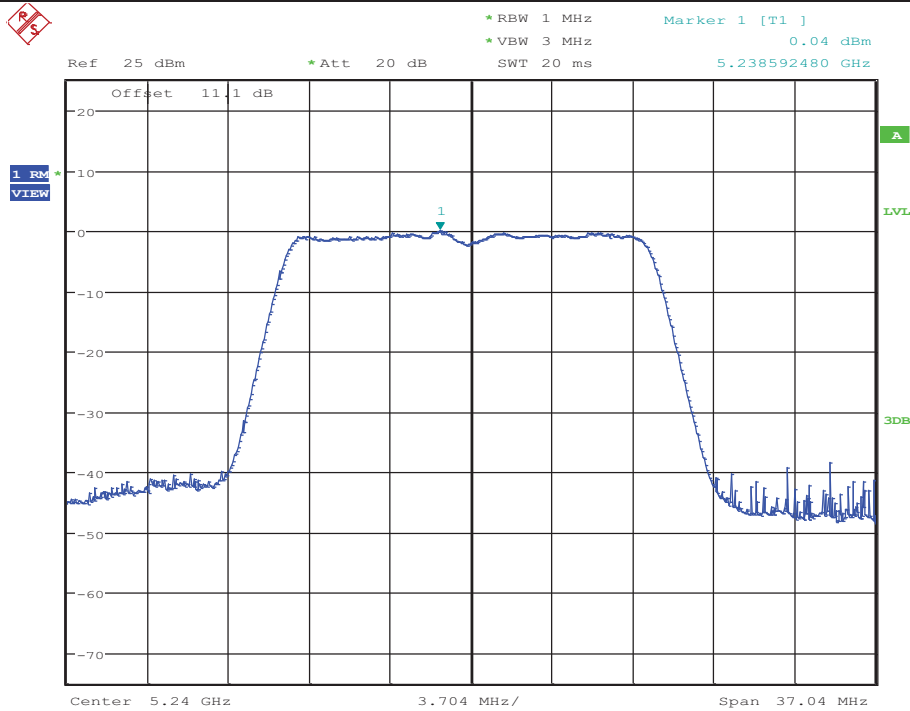

Date: 14.OCT.2017 09:32:56

### Maximum Power Spectral Density\_TNVN\_11AMIMO\_5260\_Ant1

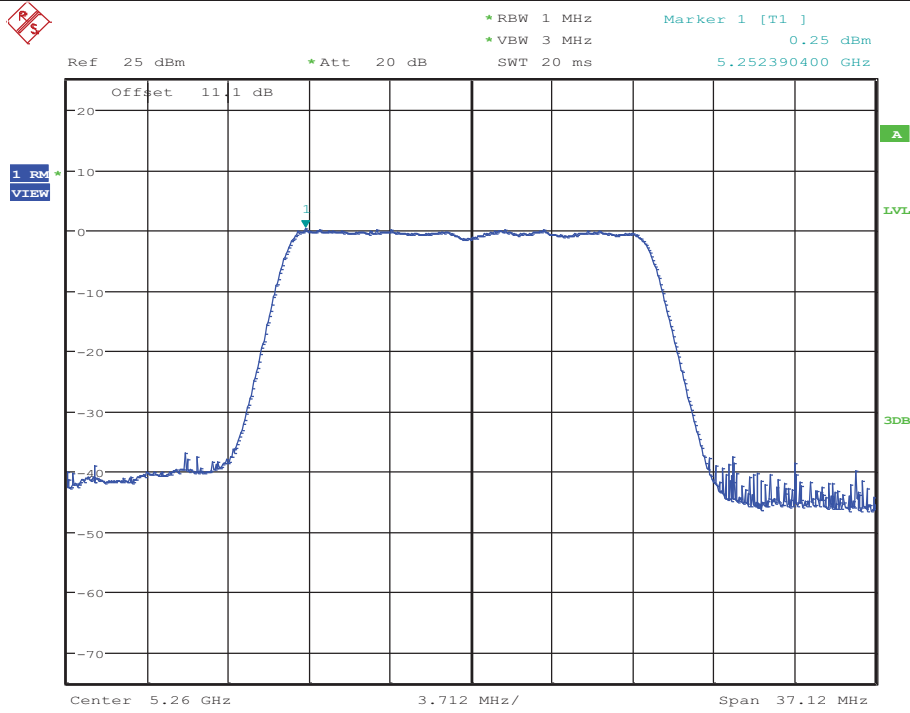

Date: 14.OCT.2017 09:43:38

### Maximum Power Spectral Density\_TNVN\_11AMIMO\_5260\_Ant2

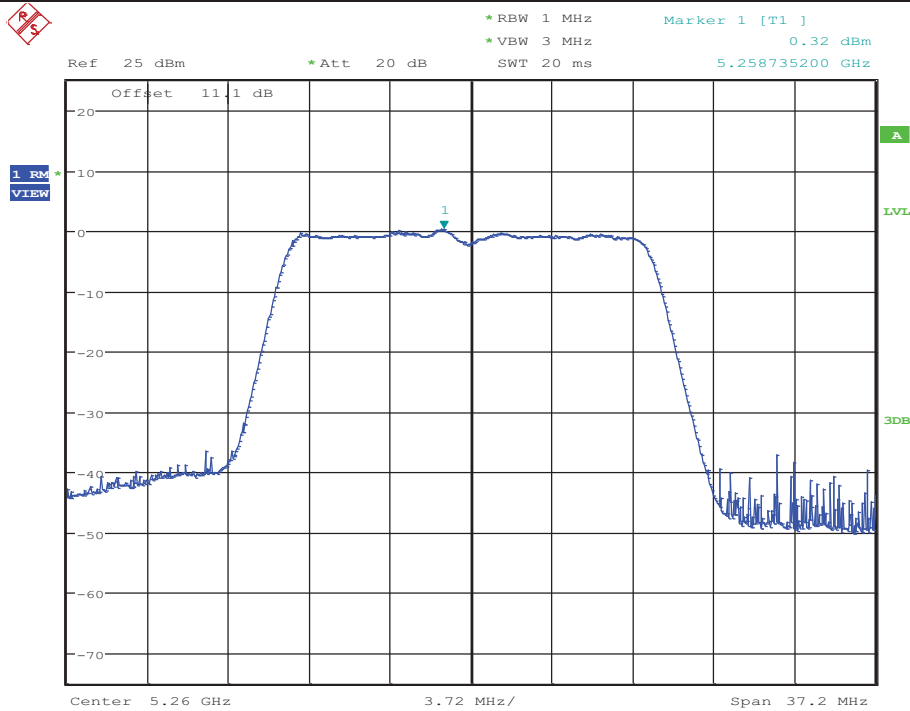

Date: 14.OCT.2017 09:59:25

### Maximum Power Spectral Density\_TNVN\_11AMIMO\_5280\_Ant1

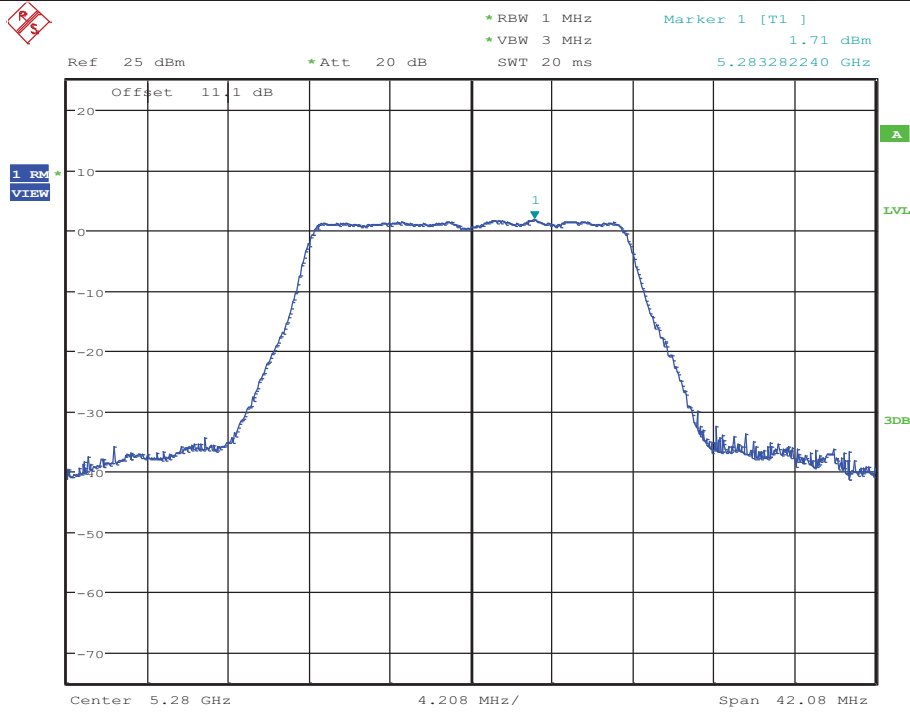

Date: 14.OCT.2017 10:06:00

### Maximum Power Spectral Density\_TNVN\_11AMIMO\_5280\_Ant2

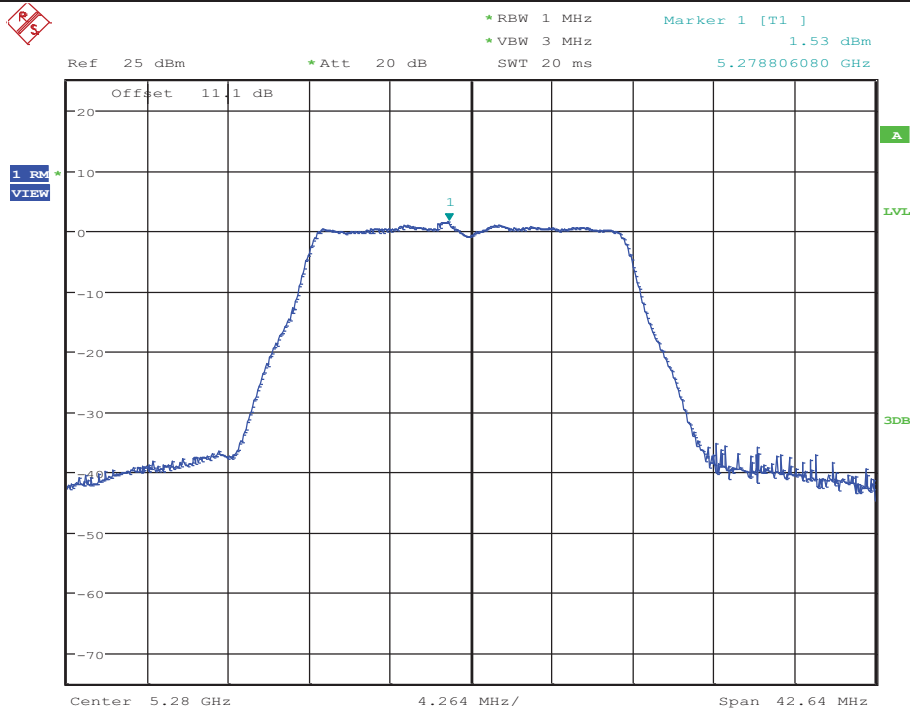

Date: 14.OCT.2017 10:15:33

### Maximum Power Spectral Density\_TNVN\_11AMIMO\_5320\_Ant1

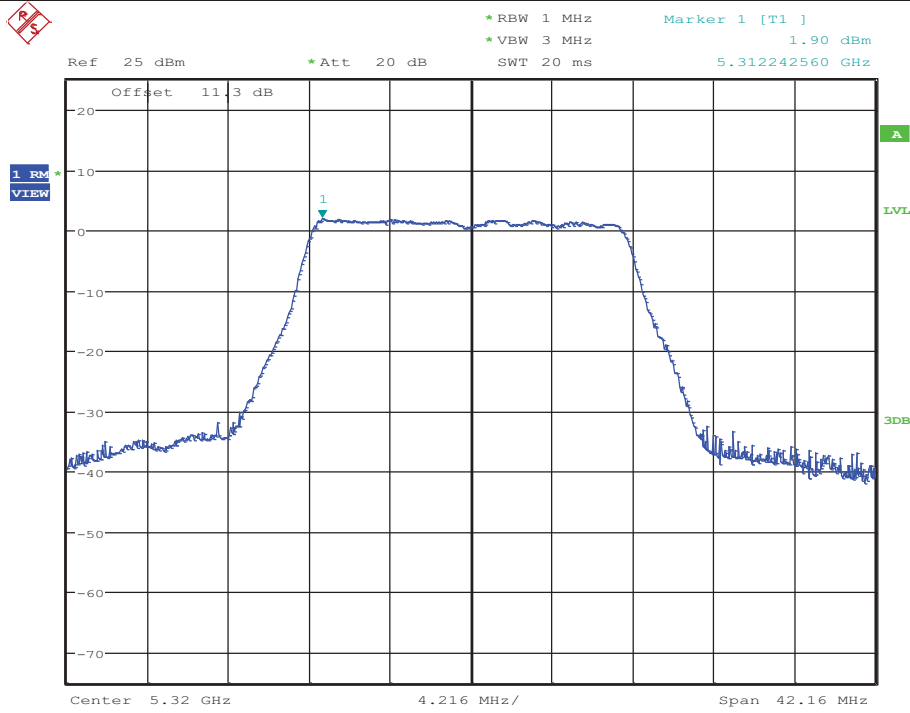

Date: 14.OCT.2017 10:30:09

### Maximum Power Spectral Density\_TNVN\_11AMIMO\_5320\_Ant2

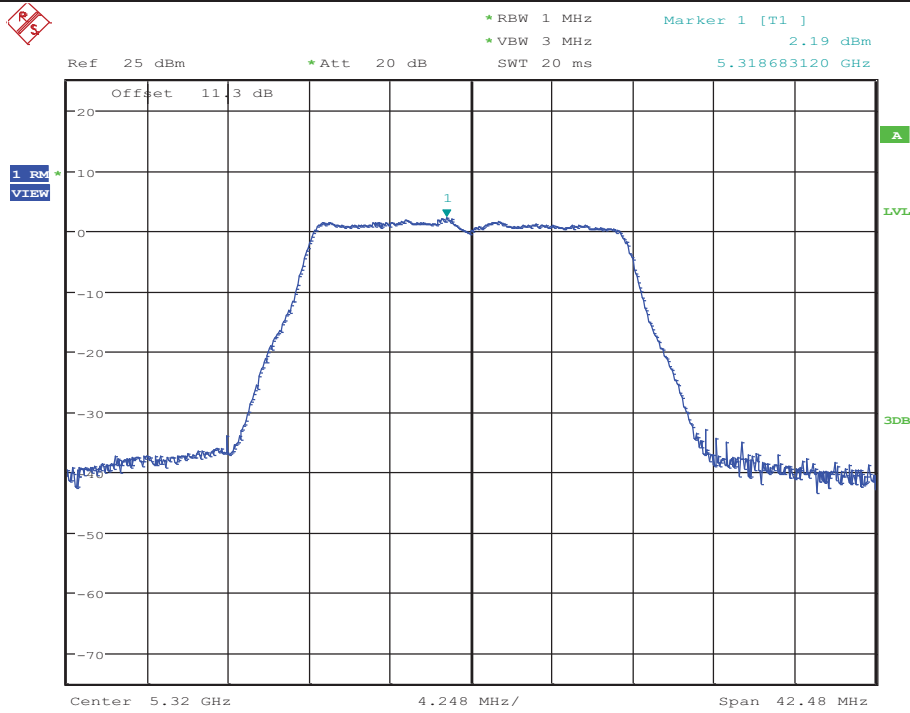

Date: 14.OCT.2017 10:57:04



### Maximum Power Spectral Density\_TNVN\_11AMIMO\_5500\_Ant1

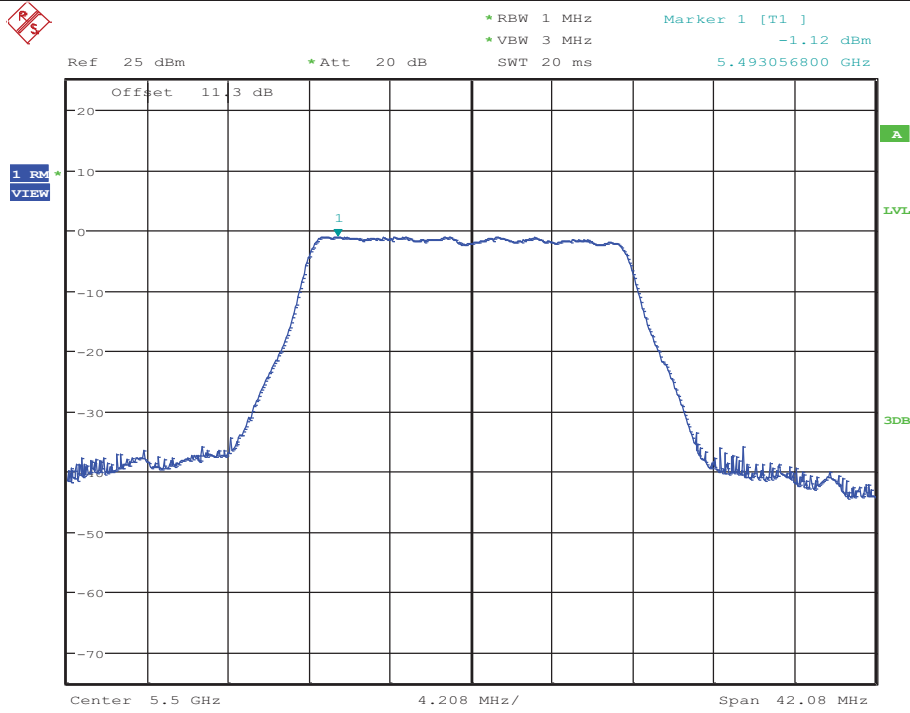

Date: 14.OCT.2017 10:49:04

### Maximum Power Spectral Density\_TNVN\_11AMIMO\_5500\_Ant2

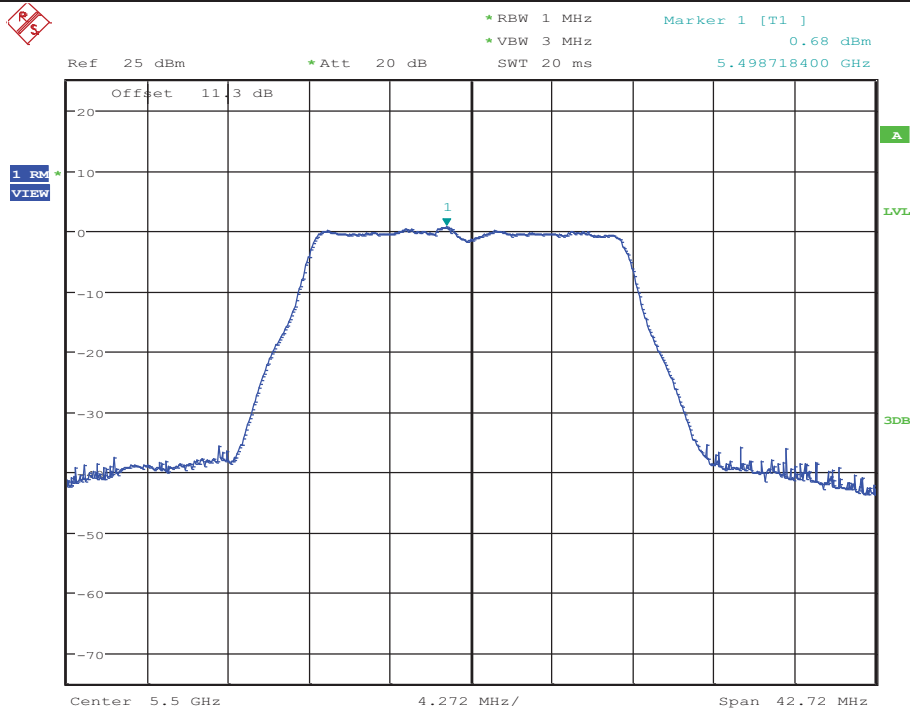

Date: 14.OCT.2017 10:54:00

### Maximum Power Spectral Density\_TNVN\_11AMIMO\_5580\_Ant1

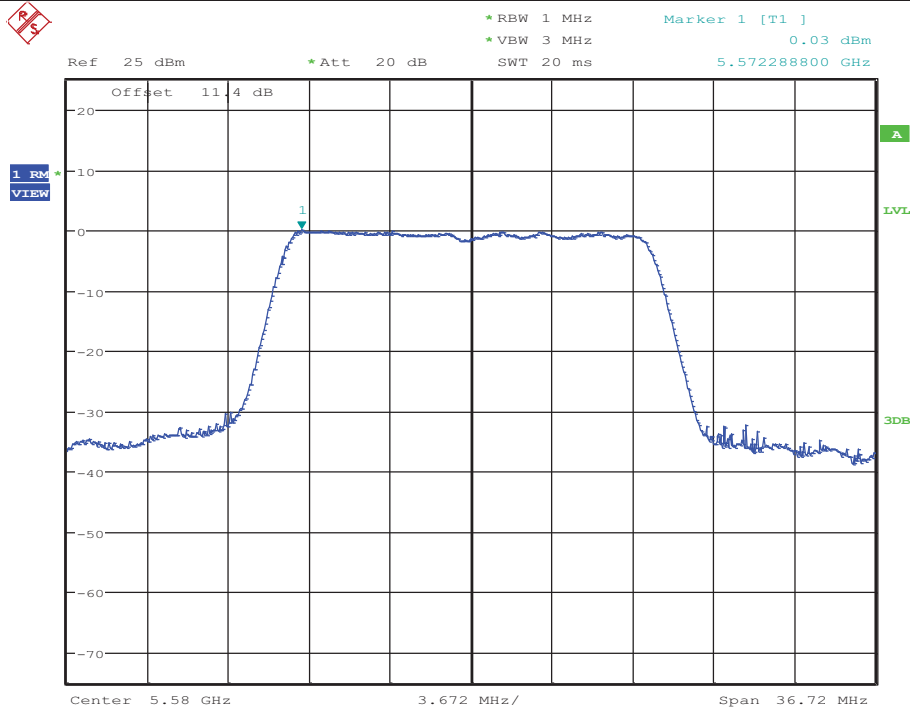

Date: 14.OCT.2017 11:03:12

### Maximum Power Spectral Density\_TNVN\_11AMIMO\_5580\_Ant2

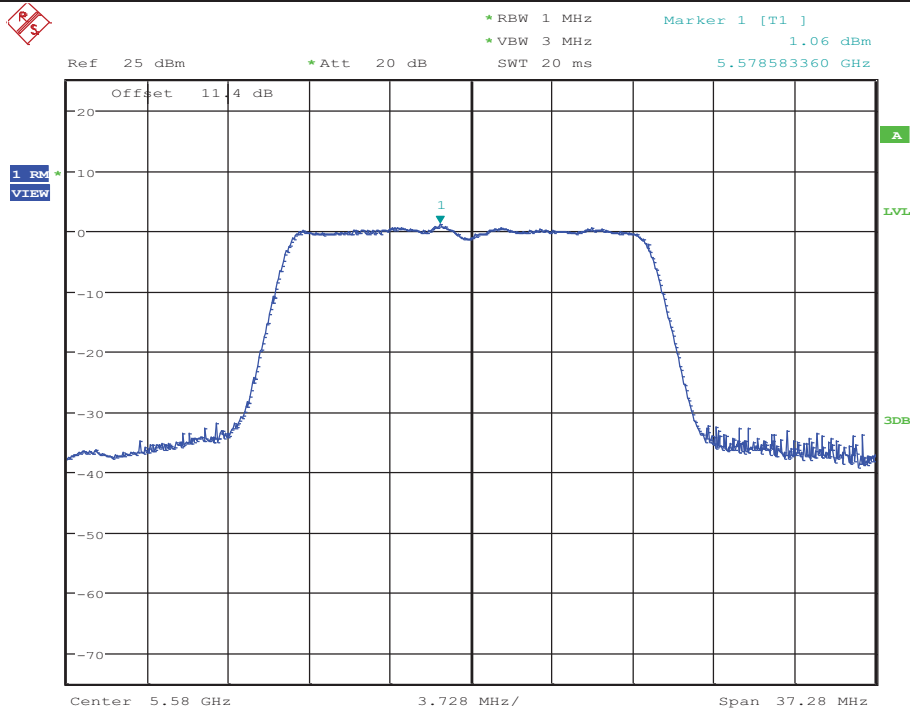

Date: 14.OCT.2017 11:54:00

### Maximum Power Spectral Density\_TNVN\_11AMIMO\_5700\_Ant1

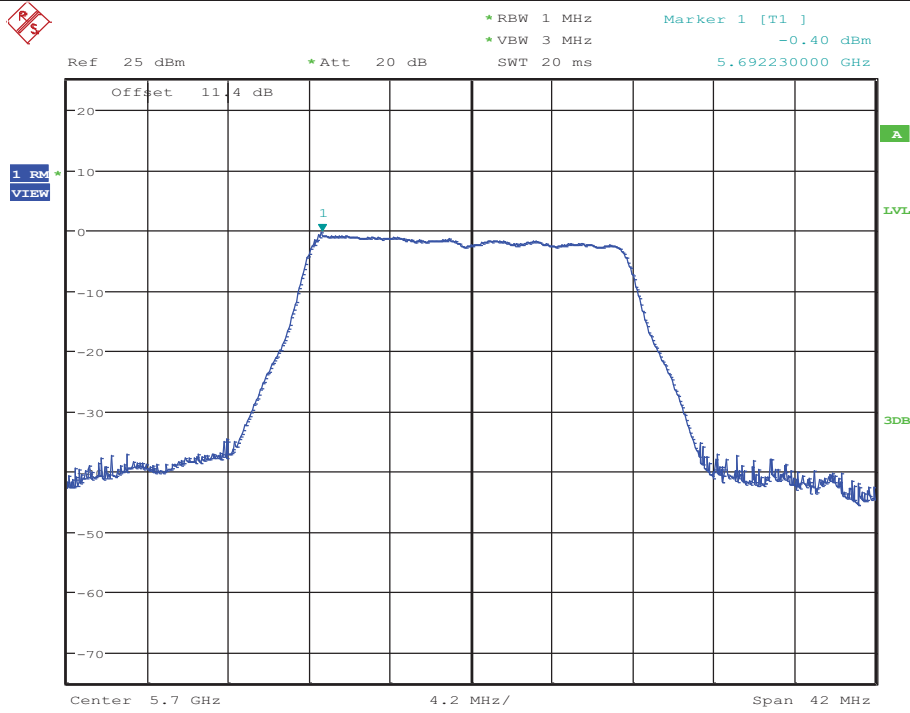

Date: 14.OCT.2017 11:11:30

### Maximum Power Spectral Density\_TNVN\_11AMIMO\_5700\_Ant2

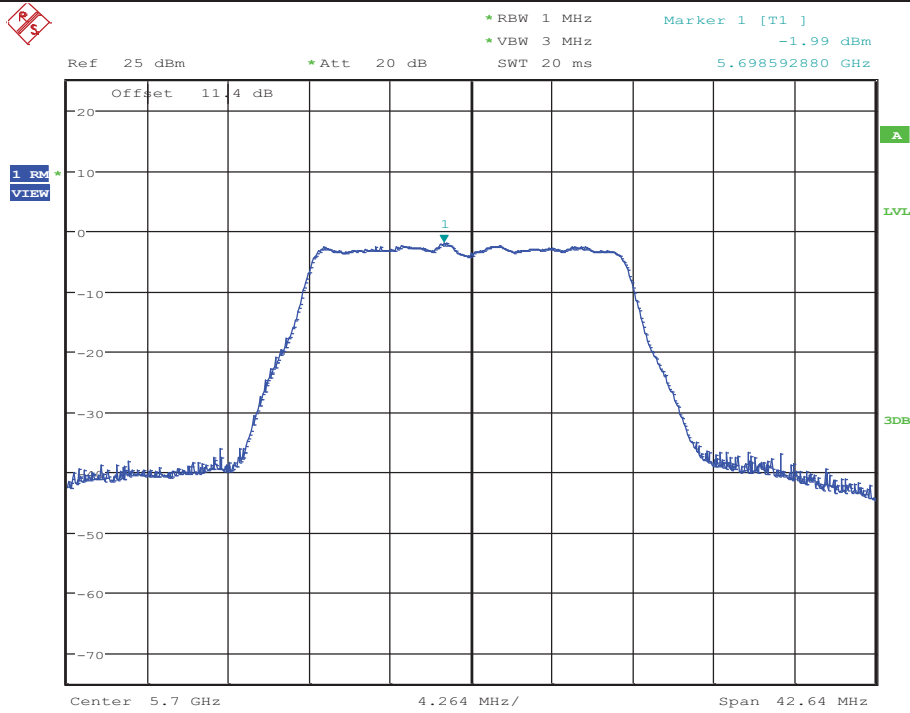

Date: 14.OCT.2017 11:59:39

### Maximum Power Spectral Density\_TNVN\_11AMIMO\_5745\_Ant1

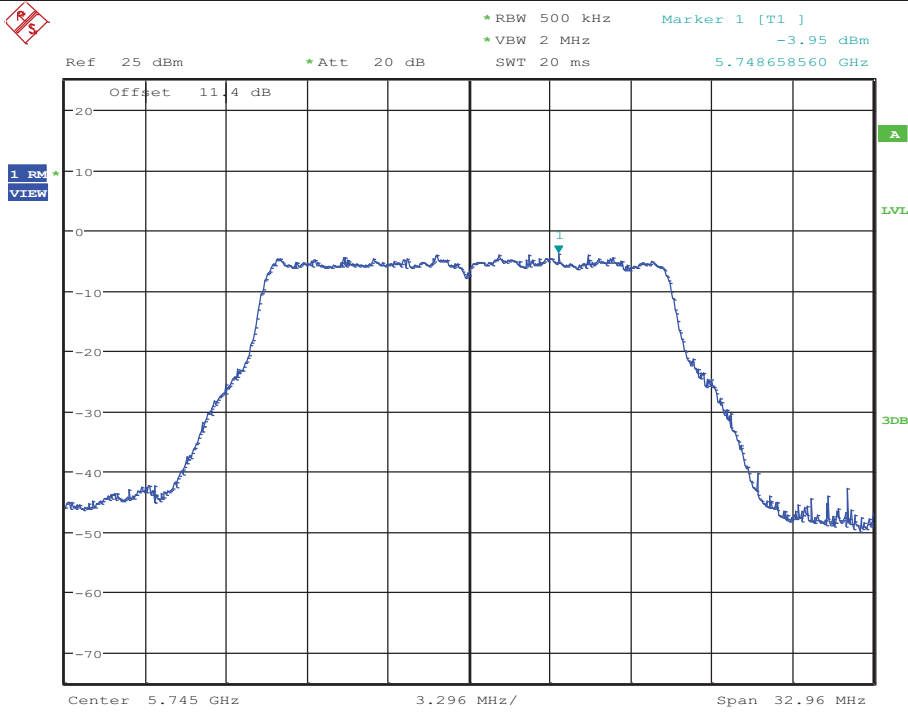

Date: 14.OCT.2017 11:20:57

### Maximum Power Spectral Density\_TNVN\_11AMIMO\_5745\_Ant2

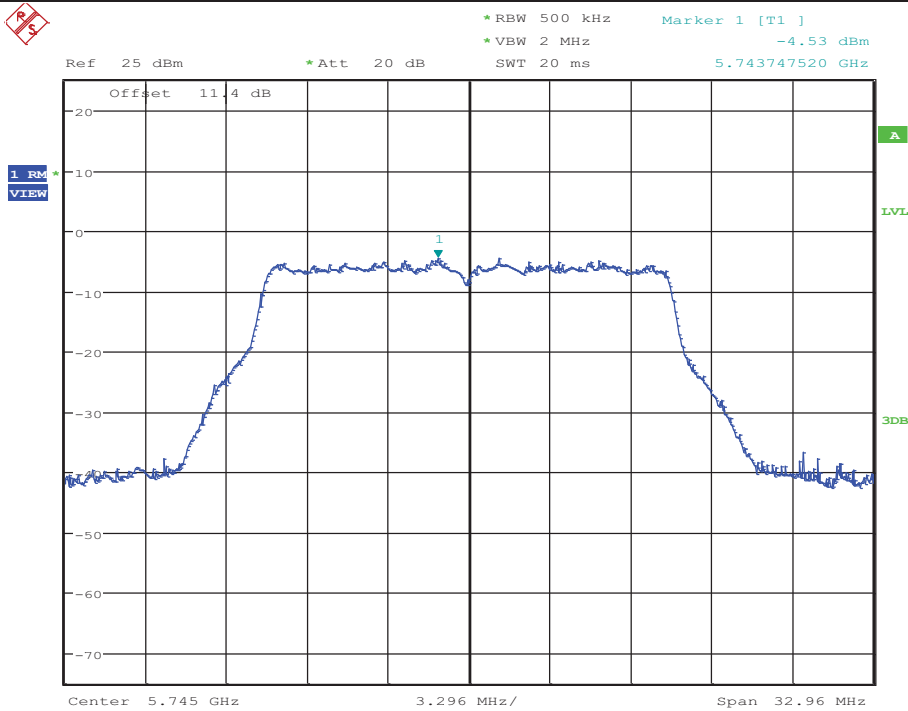

Date: 14.OCT.2017 12:05:51

### Maximum Power Spectral Density\_TNVN\_11AMIMO\_5785\_Ant1

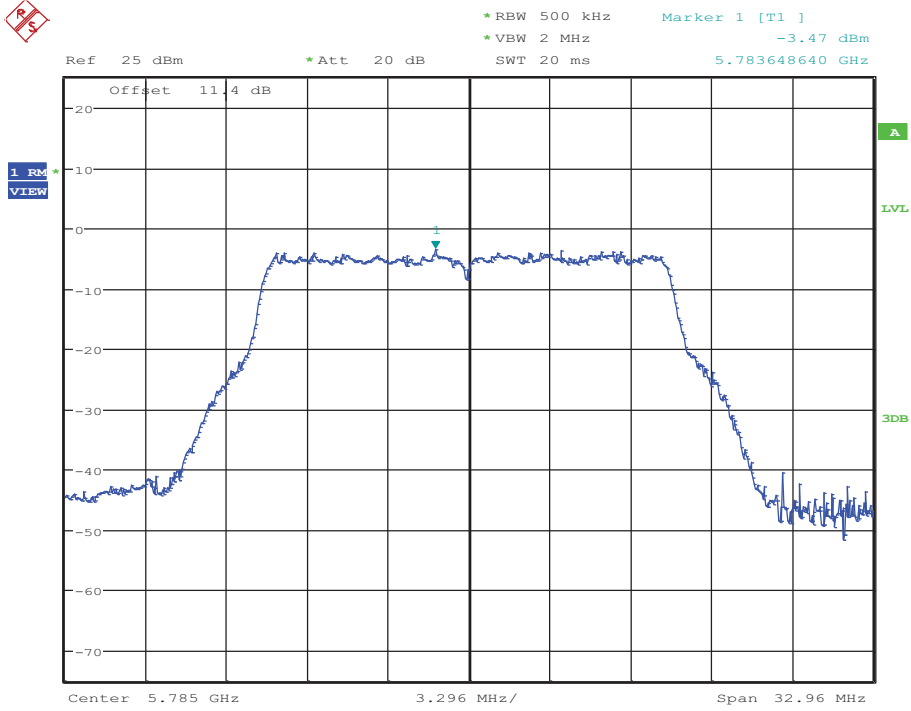

Date: 14.OCT.2017 11:39:40

### Maximum Power Spectral Density\_TNVN\_11AMIMO\_5785\_Ant2

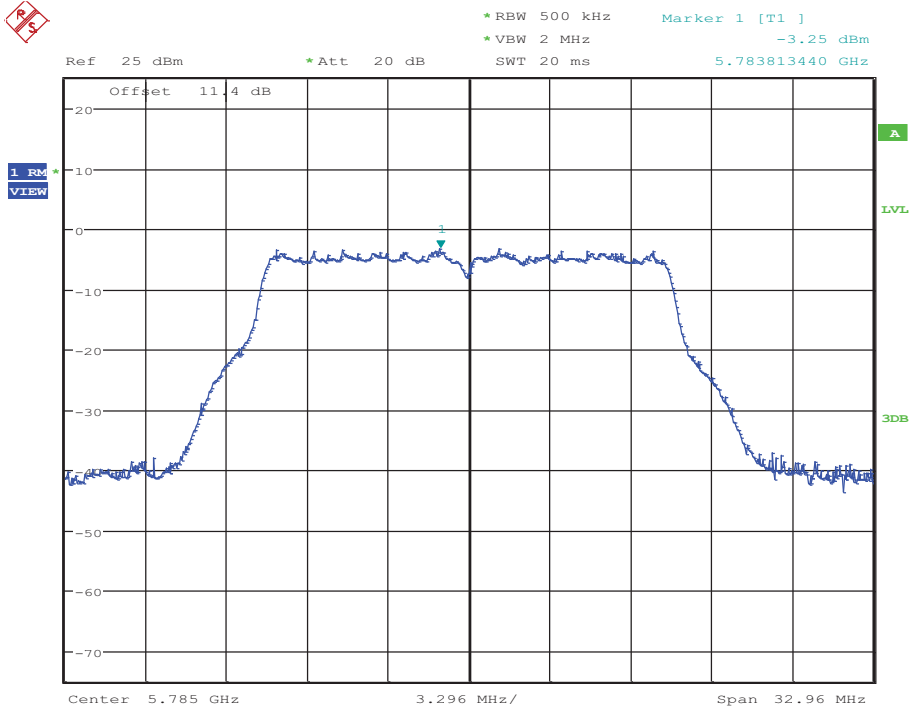

Date: 14.OCT.2017 12:12:43

### Maximum Power Spectral Density\_TNVN\_11AMIMO\_5825\_Ant1

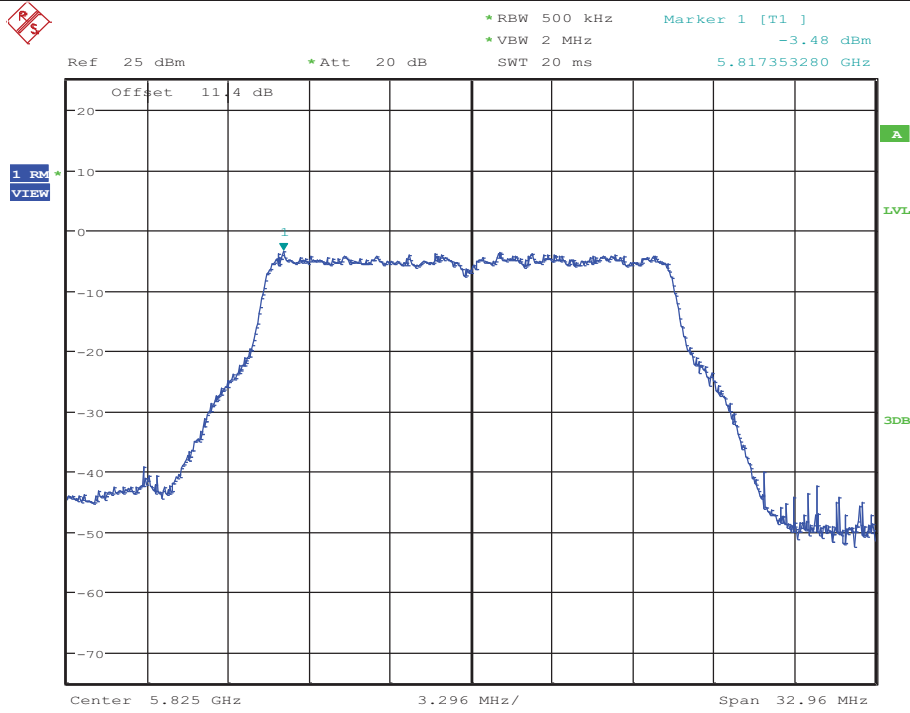

Date: 14.OCT.2017 11:45:04

### Maximum Power Spectral Density\_TNVN\_11AMIMO\_5825\_Ant2

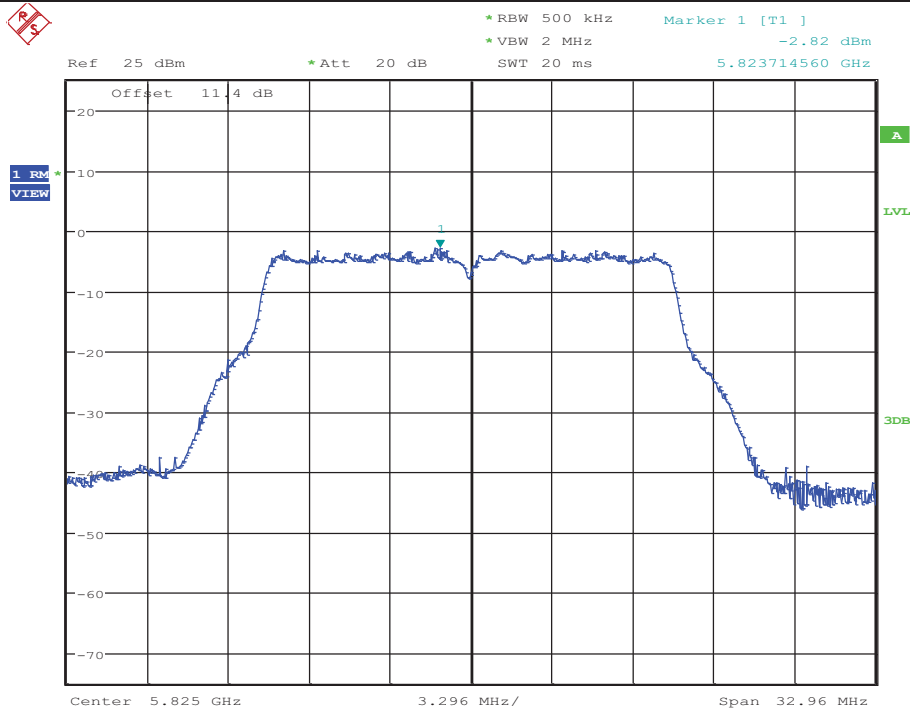

Date: 14.OCT.2017 13:28:05

## 8. Frequency Stability Measurement

### 8.1. Limit of Frequency Stability

Manufacturers of U-NII devices are responsible for ensuring frequency stability such that an emission is maintained within the band of operation under all conditions of normal operation as specified in the user's manual.

### 8.2. Measuring Instruments

The measuring equipment is listed in the section 4 of this test report.

### 8.3. Test Procedures

(1) To ensure emission at the band edge is maintained within the authorized band, those values shall be measured by radiation emissions at upper and lower frequency points, and finally compensated by frequency deviation as procedures below.

(2) The EUT was operated at the maximum output power, and connected to the spectrum analyzer, which is set to maximum hold function and peak detector. The peak value of the power envelope was measured and noted. The upper and lower frequency points were respectively measured relatively 10dB lower than the measured peak value.

(3) The frequency deviation was calculated by adding the upper frequency point and the lower frequency point divided by two. Those detailed values of frequency deviation are provided in table below.

### 8.4. Test Setup

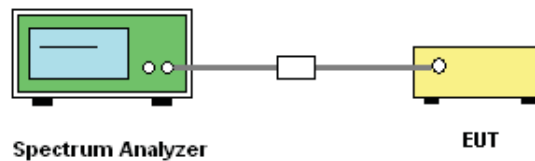

### 8.5. Test Result

Temperature vs. Frequency Stability								
Test Mode	Test Channel	Ant	Volt.	Temp.	Deviation [MHz]	Deviation [ppm]	Limit [ppm]	Verdict
11N20MIMO	5180	Ant1	VN	-30	5179.94	-11.58301	20	PASS
11N20MIMO	5180	Ant1	VN	-20	5179.94	-11.58301	20	PASS
11N20MIMO	5180	Ant1	VN	-10	5179.94	-11.58301	20	PASS
11N20MIMO	5180	Ant1	VN	0	5179.91	-17.37452	20	PASS
11N20MIMO	5180	Ant1	VN	10	5179.93	-14.47876	20	PASS
11N20MIMO	5180	Ant1	VN	20	5179.91	-17.37452	20	PASS
11N20MIMO	5180	Ant1	VN	30	5179.94	-11.58301	20	PASS
11N20MIMO	5180	Ant1	VN	40	5179.94	-11.58301	20	PASS
11N20MIMO	5180	Ant1	VN	50	5179.91	-17.37452	20	PASS
11N20MIMO	5180	Ant2	VN	-30	5179.94	-11.58301	20	PASS
11N20MIMO	5180	Ant2	VN	40	5179.97	-5.79151	20	PASS
11N20MIMO	5180	Ant2	VN	30	5179.97	-5.79151	20	PASS

11N20MIMO	5180	Ant2	VN	20	5179.96	-8.68726	20	PASS
11N20MIMO	5180	Ant2	VN	10	5179.93	-14.47876	20	PASS
11N20MIMO	5180	Ant2	VN	0	5179.97	-5.79151	20	PASS
11N20MIMO	5180	Ant2	VN	-20	5179.94	-11.58301	20	PASS
11N20MIMO	5180	Ant2	VN	50	5179.93	-14.47876	20	PASS
11N20MIMO	5180	Ant2	VN	-10	5179.93	-14.47876	20	PASS

Note: All the modes had been tested, but only the worst data were recorded in the report.



## 9. Emissions in restricted frequency bands

### 9.1. Block diagram of test setup

In 3m Anechoic Chamber Test Setup Diagram for 9KHz-30MHz

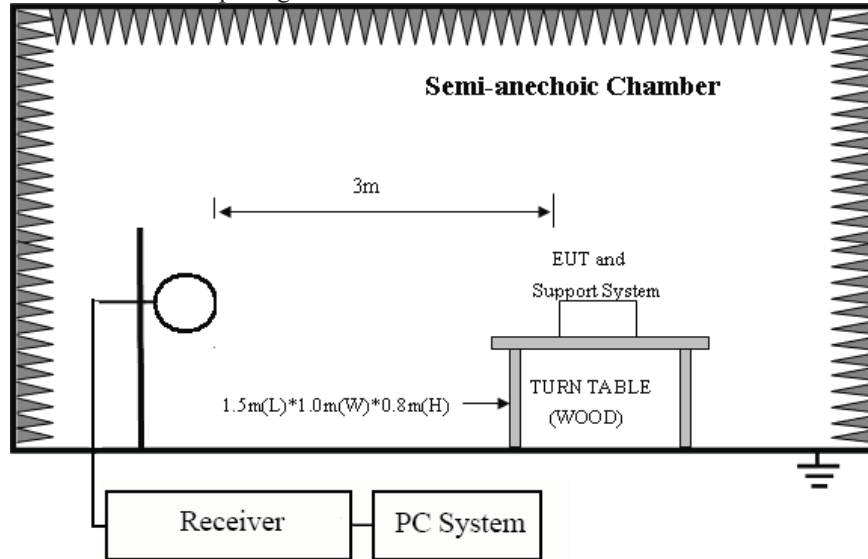

In 3m Anechoic Chamber Test Setup Diagram for 30MHz-1GHz

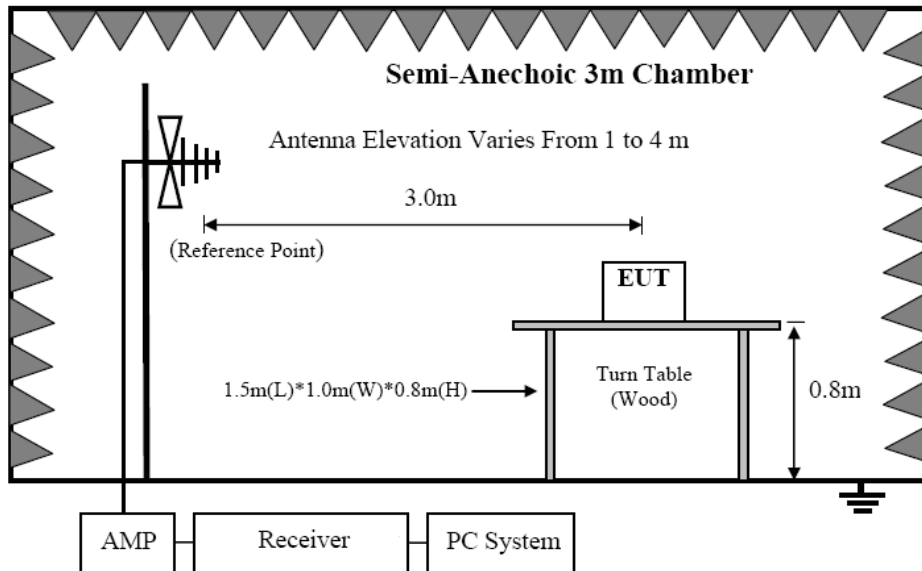

In 3m Anechoic Chamber Test Setup Diagram for frequency above 1GHz

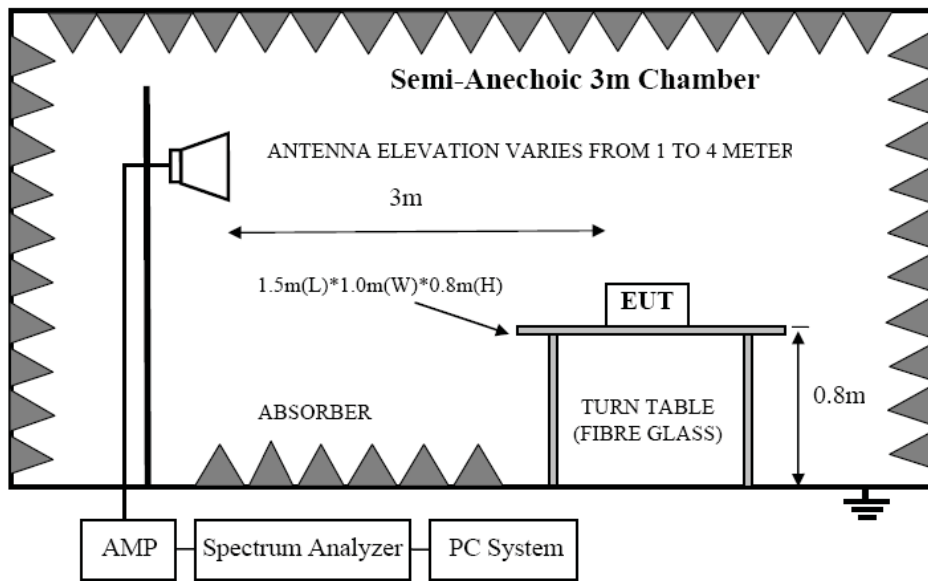

Note: For harmonic emissions test a appropriate high pass filter was inserted in the input port of AMP.

**9.2. Limit**

8.3.1 FCC 15.205 Restricted frequency band

MHz	MHz	MHz	GHz
0.090 - 0.110	16.42 - 16.423	399.9 - 410	4.5 - 5.15
<sup>1</sup> 0.495 - 0.505	16.69475 - 16.69525	608 - 614	5.35 - 5.46
2.1735 - 2.1905	16.80425 - 16.80475	960 - 1240	7.25 - 7.75
4.125 - 4.128	25.5 - 25.67	1300 - 1427	8.025 - 8.5
4.17725 - 4.17775	37.5 - 38.25	1435 - 1626.5	9.0 - 9.2
4.20725 - 4.20775	73 - 74.6	1645.5 - 1646.5	9.3 - 9.5
6.215 - 6.218	74.8 - 75.2	1660 - 1710	10.6 - 12.7
6.26775 - 6.26825	108 - 121.94	1718.8 - 1722.2	13.25 - 13.4
6.31175 - 6.31225	123 - 138	2200 - 2300	14.47 - 14.5
8.291 - 8.294	149.9 - 150.05	2310 - 2390	15.35 - 16.2
8.362 - 8.366	156.52475 - 156.52525	2483.5 - 2500	17.7 - 21.4
8.37625 - 8.38675	156.7 - 156.9	2690 - 2900	22.01 - 23.12
8.41425 - 8.41475	162.0125 - 167.17	3260 - 3267	23.6 - 24.0
12.29 - 12.293	167.72 - 173.2	3332 - 3339	31.2 - 31.8
12.51975 - 12.52025	240 - 285	3345.8 - 3358	36.43 - 36.5
12.57675 - 12.57725	322 - 335.4	3600 - 4400	( <sup>2</sup> )

8.3.2 FCC 15.209 Limit.

FREQUENCY MHz	DISTANCE Meters	FIELD STRENGTHS LIMIT	
		μV/m	dB(μV)/m
0.009 ~ 0.490	300	2400/F(KHz)	67.6-20log(F)
0.490 ~ 1.705	30	24000/F(KHz)	87.6-20log(F)
1.705 ~ 30.0	30	30	29.54
30 ~ 88	3	100	40.0
88 ~ 216	3	150	43.5
216 ~ 960	3	200	46.0
960 ~ 1000	3	500	54.0
Above 1000	3	74.0 dB(μV)/m (Peak) 54.0 dB(μV)/m (Average)	

Note: (1) The emission limits shown in the above table are based on measurements employing a CISPR QP detector except for the frequency bands 9-90KHz, 110-490KHz and above 1000MHz. Radiated emissions limits in these three bands are based on measurements employing an average detector.

(2) At frequencies below 30MHz, measurement may be performed at a distance closer than that specified, and the limit at closer measurement distance can be extrapolated by below formula:

$$\text{Limit}_{3m}(\text{dBuV/m}) = \text{Limit}_{30m}(\text{dBuV/m}) + 40\text{Log}(30m/3m)$$

### 8.3.3 Limit for this EUT

All the emissions appearing within 15.205 restricted frequency bands shall not exceed the limits shown in 15.209, all the other emissions shall be at least 20dB below the fundamental emissions, or comply with 15.209 limits.

## 9.3. Test Procedure

- (1) EUT height should be 0.8m for below 1GHz at a semi-anechoic chamber while EUT height should be 1.5m for above 1GHz at full chamber or semi-anechoic chamber ground with absorbers
- (2) Setup EUT and assistant system according clause 2.3 and 8.2
- (3) Test antenna was located 3m from the EUT on an adjustable mast, and the antenna used as below table.

Test frequency range	Test antenna used	Test distance
9KHz-30MHz	Active Loop antenna	3m
30MHz-1GHz	Trilog Broadband Antenna	3m
1GHz-18GHz	Double Ridged Horn Antenna(1GHz-18GHz)	3m
18GHz-40GHz	Horn Antenna(18GHz-40GHz)	1m

According ANSI C63.10:2013 clause 6.4.4.2 and 6.5.3, for measurements below 30 MHz, the loop antenna was positioned with its plane vertical from the EUT and rotated about its vertical axis for maximum response at each azimuth position around the EUT. And the loop antenna also be positioned with its plane horizontal at the specified distance from the EUT. The center of the loop is 1 m above the ground. for measurement above 30MHz, the Trilog Broadband Antenna or Horn Antenna was located 3m from EUT, Measurements were made with the antenna positioned in both the horizontal and vertical planes of Polarization, and the measurement antenna was varied from 1 m to 4 m. in height above the reference ground plane to obtain the maximum signal strength.

(4) Below pre-scan procedure was first performed in order to find prominent frequency spectrum radiated emissions from 9KHz to 25GHz:

- (a) Scanning the peak frequency spectrum with the antenna specified in step (3), and the EUT was rotated 360 degree, the antenna height was varied from 1m to 4m(Except loop antenna, it's fixed 1m above ground.)
- (b) Change work frequency or channel of device if practicable.
- (c) Change modulation type of device if practicable.
- (d) Change power supply range from 85% to 115% of the rated supply voltage
- (e) Rotated EUT though three orthogonal axes to determine the attitude of EUT arrangement produces highest emissions.

Spectrum frequency from 9KHz to 25GHz (tenth harmonic of fundamental frequency) was investigated, and no any obvious emission were detected from 9KHz to 30MHz and 18GHz to 25GHz, so below final test was performed with frequency range from 30MHz to 18GHz.

- (5) For final emissions measurements at each frequency of interest, the EUT was rotated and the antenna height was varied between 1m and 4m in order to maximize the emission. Measurements in both horizontal and vertical polarities were made and the data was recorded. In order to find the maximum emission, the relative positions of equipments and all of the interface cables were changed according to ANSI C63.10 2013 on Radiated Emission test.
- (6) The emissions from 9KHz to 1GHz were measured based on CISPR QP detector except for the frequency bands 9-90KHz, 110-490KHz, for emissions from 9KHz-90KHz,110KHz-490KHz and above 1GHz were measured based on average detector, for emissions above 1GHz, peak emissions also be measured and need comply with Peak limit.
- (7) The emissions from 9KHz to 1GHz, QP or average values were measured with EMI receiver with below RBW

Frequency band	RBW
9KHz-150KHz	200Hz
150KHz-30MHz	9KHz
30MHz-1GHz	120KHz

- (8) For emissions above 1GHz, both Peak and Average level were measured with Spectrum Analyzer, and the RBW is set at 1MHz, VBW is set at 3MHz ,Peak detector for Peak measure , RMS detector for AV value

#### 9.4. Test result

##### **PASS. (See below detailed test result)**

All the emissions except fundamental emission from 9KHz to 40GHz were comply with 15.209 limit.

Note1: According exploratory test no any obvious emission were detected from 9KHz to 30MHz and 18GHz to 40GHz, so the final test was performed with frequency range from 30MHz to 18GHz and recorded in below.

Note2: For emissions below 1GHz, according exploratory explorer test, when change Tx mode and channel, have no distinct influence on emissions level, so for emissions below 1GHz, the final test was only performed with EUT working in ANT2+ANT1, 11a, Tx CH52 mode.

Note3: For below test data, when the limit tabular marked “/” means this frequency point is the fundamental emission and no need comply with this limit.

**Radiated Emission test (below 1GHz)**

**TR-4-E-009 Radiated Emission Test Result**

<b>Test Site</b>	: DDT 3m Chamber 1#	D:\2017 RE1# Report Data\Q17090505-1E\Q17090505-1E FCC 30-1G.EM6	
<b>Test Date</b>	: 2017-10-15	<b>Tested By</b>	: TALENT
<b>EUT</b>	: Wireless Adaptor and 120W Digital Amplifier	<b>Model Number</b>	: ADAPT+AMP
<b>Power Supply</b>	: AC 120V/60Hz	<b>Test Mode</b>	: TX mode
<b>Condition</b>	: Temp:24.5°C,Humi:55%, Press:100.1kPa	<b>Antenna/Distance</b>	: 2016 VULB9163 1#/3m/HORIZONTAL
<b>Memo</b>	:		

Data: 7

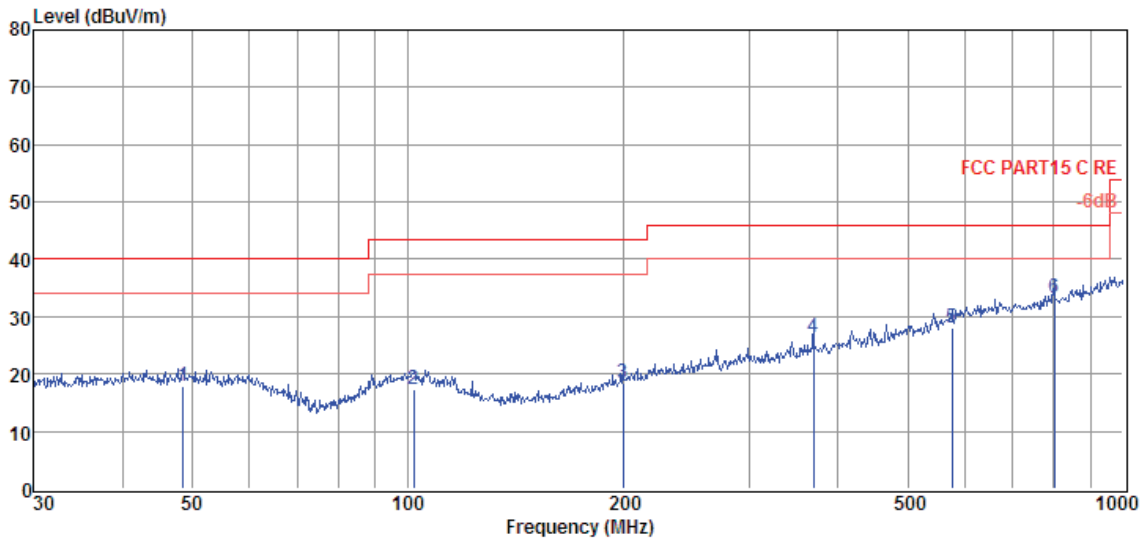

Item (Mark)	Freq. (MHz)	Read Level (dBμV)	Antenna Factor (dB/m)	Cable Loss (dB)	Result Level (dBμV/m)	Limit Line (dBμV/m)	Over Limit (dB)	Detector	Polarization
1	48.50	1.77	12.22	3.87	17.86	40.00	-22.14	QP	HORIZONTAL
2	102.00	1.09	11.84	4.31	17.24	43.50	-26.26	QP	HORIZONTAL
3	199.99	3.33	10.30	4.90	18.53	43.50	-24.97	QP	HORIZONTAL
4	369.41	5.64	15.19	5.67	26.50	46.00	-19.50	QP	HORIZONTAL
5	576.64	2.51	19.00	6.43	27.94	46.00	-18.06	QP	HORIZONTAL
6	801.79	5.06	21.20	7.13	33.39	46.00	-12.61	QP	HORIZONTAL

- Note: 1. Result Level = Read Level + Antenna Factor + Cable loss.  
 2. If Peak Result complies with QP limit, QP Result is deemed to comply with QP limit.  
 3. Test setup: RBW: 120 kHz, VBW: 300 kHz, Sweep time: auto.

# TR-4-E-009 Radiated Emission Test Result

<b>Test Site</b>	: DDT 3m Chamber 1#	D:\2017 RE1# Report Data\Q17090505-1E\Q17090505-1E FCC 30-1G.EM6
<b>Test Date</b>	: 2017-10-15	<b>Tested By</b> : TALENT
<b>EUT</b>	: Wireless Adaptor and 120W Digital Amplifier	<b>Model Number</b> : ADAPT+AMP
<b>Power Supply</b>	: AC 120V/60Hz	<b>Test Mode</b> : TX mode
<b>Condition</b>	: Temp:24.5°C,Humi:55%, Press:100.1kPa	<b>Antenna/Distance</b> : 2016 VULB9163 1#/3m/VERTICAL
<b>Memo</b>	:	

Data: 8

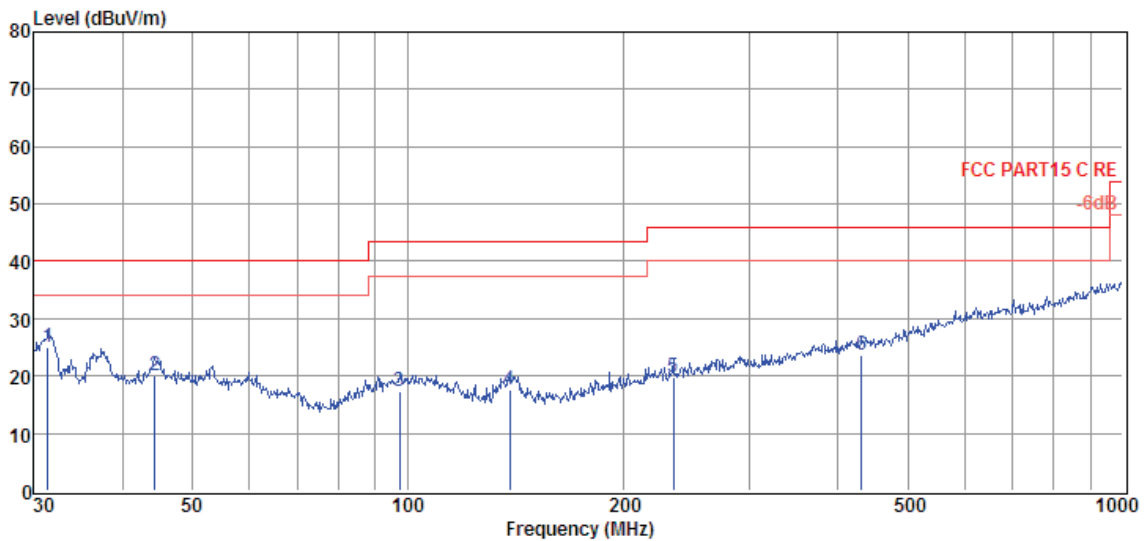

Item (Mark)	Freq. (MHz)	Read Level (dBμV)	Antenna Factor (dB/m)	Cable Loss (dB)	Result Level (dBμV/m)	Limit Line (dBμV/m)	Over Limit (dB)	Detector	Polarization
1	31.40	9.90	11.31	3.68	24.89	40.00	-15.11	QP	VERTICAL
2	44.28	3.80	12.37	3.83	20.00	40.00	-20.00	QP	VERTICAL
3	97.46	1.19	11.80	4.28	17.27	43.50	-26.23	QP	VERTICAL
4	138.87	5.64	7.47	4.53	17.64	43.50	-25.86	QP	VERTICAL
5	234.99	2.95	11.70	5.07	19.72	46.00	-26.28	QP	VERTICAL
6	431.03	1.59	16.23	5.91	23.73	46.00	-22.27	QP	VERTICAL

- Note: 1. Result Level = Read Level + Antenna Factor + Cable loss.  
 2. If Peak Result complies with QP limit, QP Result is deemed to comply with QP limit.  
 3. Test setup: RBW: 120 kHz, VBW: 300 kHz, Sweep time: auto.

**Radiated Emission test (above 1GHz)**

Freq (MHz)	Read level (dB $\mu$ V)	Antenna Factor (dB/m)	PRM Factor (dB)	Cable Loss (dB)	Result Level (dB $\mu$ V/m)	Limit (dB $\mu$ V/m)	Margin (dB)	Detector type	Polarization
<b>11a CH36</b>									
6321.00	34.32	35.52	29.51	9.85	50.18	74.00	-23.82	Peak	VERTICAL
7936.00	35.83	36.69	31.11	11.10	52.51	74.00	-21.49	Peak	VERTICAL
9109.00	34.29	37.26	32.36	11.95	51.14	74.00	-22.86	Peak	VERTICAL
10350.00	25.62	36.55	33.15	12.62	41.64	54.00	-12.36	Average	VERTICAL
10350.00	40.81	36.55	33.15	12.62	56.83	74.00	-17.17	Peak	VERTICAL
12050.00	33.21	37.67	34.82	14.26	50.32	74.00	-23.68	Peak	VERTICAL
6644.00	34.90	35.92	30.08	10.08	50.82	74.00	-23.18	Peak	HORIZONTAL
7630.00	34.66	36.63	30.92	10.92	51.29	74.00	-22.71	Peak	HORIZONTAL
9041.00	33.98	37.41	32.34	11.87	50.92	74.00	-23.08	Peak	HORIZONTAL
10486.00	34.35	36.41	33.25	12.70	50.21	74.00	-23.79	Peak	HORIZONTAL
11064.00	33.22	37.66	34.08	13.49	50.29	74.00	-23.71	Peak	HORIZONTAL
13376.00	34.90	39.18	35.38	14.76	53.46	74.00	-20.54	Peak	HORIZONTAL
<b>11a CH40</b>									
6440.00	34.01	35.71	29.74	9.91	49.89	74.00	-24.11	Peak	VERTICAL
7171.00	36.38	36.34	30.48	10.57	52.81	74.00	-21.19	Peak	VERTICAL
7715.00	34.67	36.64	30.99	10.98	51.30	74.00	-22.70	Peak	VERTICAL
8939.00	33.89	37.24	32.26	11.79	50.66	74.00	-23.34	Peak	VERTICAL
10401.00	37.89	36.50	33.20	12.65	53.84	74.00	-20.16	Peak	VERTICAL
12696.00	32.46	38.50	35.48	14.65	50.13	74.00	-23.87	Peak	VERTICAL
6695.00	33.60	35.96	30.14	10.14	49.56	74.00	-24.44	Peak	HORIZONTAL
7409.00	33.75	36.53	30.67	10.78	50.39	74.00	-23.61	Peak	HORIZONTAL
8140.00	33.29	36.30	31.24	11.29	49.64	74.00	-24.36	Peak	HORIZONTAL
9755.00	33.54	36.66	32.82	12.40	49.78	74.00	-24.22	Peak	HORIZONTAL
11200.00	33.18	37.35	34.25	13.52	49.80	74.00	-24.20	Peak	HORIZONTAL
12781.00	33.07	38.58	35.58	14.66	50.73	74.00	-23.27	Peak	HORIZONTAL
<b>11a CH48</b>									
6355.00	33.20	35.57	29.54	9.87	49.10	74.00	-24.90	Peak	VERTICAL
7715.00	34.48	36.64	30.99	10.98	51.11	74.00	-22.89	Peak	VERTICAL
9041.00	34.21	37.41	32.34	11.87	51.15	74.00	-22.85	Peak	VERTICAL
9585.00	33.04	36.49	32.71	12.37	49.19	74.00	-24.81	Peak	VERTICAL
10486.00	36.56	36.41	33.25	12.70	52.42	74.00	-21.58	Peak	VERTICAL
12645.00	32.82	38.45	35.45	14.65	50.47	74.00	-23.53	Peak	VERTICAL
6355.00	34.42	35.57	29.54	9.87	50.32	74.00	-23.68	Peak	HORIZONTAL
7970.00	35.08	36.69	31.12	11.12	51.77	74.00	-22.23	Peak	HORIZONTAL
9466.00	33.96	36.47	32.59	12.32	50.16	74.00	-23.84	Peak	HORIZONTAL
11591.00	32.91	36.87	34.56	13.70	48.92	74.00	-25.08	Peak	HORIZONTAL
12611.00	32.62	38.41	35.36	14.65	50.32	74.00	-23.68	Peak	HORIZONTAL
13155.00	34.94	38.96	35.57	14.71	53.04	74.00	-20.96	Peak	HORIZONTAL
Conclusion: Pass									
Note: -27 dBm/MHz Limit=95.2+EIRP[dBm]=95.2-27=68.2 dB $\mu$ V/m For transmitters operating in the 5150MHz-5250MHz, 5250MHz-5350MHz, 5470MHz-5725MHz, 5725MHz-5850MHz band: all emissions outside of the 5.15-5.35 GHz band shall not exceed an EIRP of -27 dBm/MHz.									

Note: 1. 30MHz~40GHz: (Scan with 11a, 11n HT20, 11n HT40, 11ac20, 11ac40 and 11ac80 the worst case is 11a ANT1+ANT 2 Mode)

2. Result Level = Read Level + Antenna Factor + Cable loss - PRM Factor.

3. Test setup: RBW: 1 MHz, VBW: 3 MHz, Sweep time: auto.

Freq (MHz)	Read level (dBμV)	Antenna Factor (dB/m)	PRM Factor (dB)	Cable Loss (dB)	Result Level (dBμV/m)	Limit (dBμ V/m)	Margin (dB)	Detector type	Polarization
<b>11a CH52</b>									
6270.00	32.56	35.44	29.44	9.82	48.38	74.00	-25.62	Peak	VERTICAL
8276.00	33.50	35.92	31.42	11.42	49.42	74.00	-24.58	Peak	VERTICAL
10180.00	33.04	36.72	33.03	12.53	49.26	74.00	-24.74	Peak	VERTICAL
10758.00	33.18	37.13	33.55	13.14	49.90	74.00	-24.10	Peak	VERTICAL
12611.00	32.77	38.41	35.36	14.65	50.47	74.00	-23.53	Peak	VERTICAL
13206.00	34.00	39.01	35.54	14.73	52.20	74.00	-21.80	Peak	VERTICAL
6355.00	33.74	35.57	29.54	9.87	49.64	74.00	-24.36	Peak	HORIZONTAL
7766.00	35.12	36.65	31.02	11.01	51.76	74.00	-22.24	Peak	HORIZONTAL
8820.00	35.29	36.72	32.18	11.75	51.58	74.00	-22.42	Peak	HORIZONTAL
10469.00	33.68	36.43	33.25	12.69	49.55	74.00	-24.45	Peak	HORIZONTAL
11149.00	32.78	37.47	34.17	13.51	49.59	74.00	-24.41	Peak	HORIZONTAL
13206.00	34.09	39.01	35.54	14.73	52.29	74.00	-21.71	Peak	HORIZONTAL
<b>11a CH56</b>									
6559.00	33.57	35.85	29.94	9.99	49.47	74.00	-24.53	Peak	VERTICAL
8004.00	33.86	36.69	31.13	11.13	50.55	74.00	-23.45	Peak	VERTICAL
9024.00	32.91	37.45	32.33	11.83	49.86	74.00	-24.14	Peak	VERTICAL
10571.00	36.72	36.60	33.33	12.80	52.79	74.00	-21.21	Peak	VERTICAL
12050.00	33.41	37.67	34.82	14.26	50.52	74.00	-23.48	Peak	VERTICAL
13291.00	33.84	39.09	35.47	14.74	52.20	74.00	-21.80	Peak	VERTICAL
6185.00	33.88	35.30	29.34	9.77	49.61	74.00	-24.39	Peak	HORIZONTAL
7766.00	34.13	36.65	31.02	11.01	50.77	74.00	-23.23	Peak	HORIZONTAL
8854.00	33.83	36.87	32.22	11.76	50.24	74.00	-23.76	Peak	HORIZONTAL
9755.00	32.75	36.66	32.82	12.40	48.99	74.00	-25.01	Peak	HORIZONTAL
10571.00	34.87	36.60	33.33	12.80	50.94	74.00	-23.06	Peak	HORIZONTAL
12509.00	32.67	38.31	35.26	14.64	50.36	74.00	-23.64	Peak	HORIZONTAL
<b>11a CH64</b>									
6440.00	33.93	35.71	29.74	9.91	49.81	74.00	-24.19	Peak	VERTICAL
7630.00	34.77	36.63	30.92	10.92	51.40	74.00	-22.60	Peak	VERTICAL
9075.00	33.99	37.33	32.35	11.89	50.86	74.00	-23.14	Peak	VERTICAL
11251.00	33.81	37.24	34.28	13.53	50.30	74.00	-23.70	Peak	VERTICAL
12050.00	33.92	37.67	34.82	14.26	51.03	74.00	-22.97	Peak	VERTICAL
13291.00	34.47	39.09	35.47	14.74	52.83	74.00	-21.17	Peak	VERTICAL
6865.00	33.21	36.09	30.28	10.31	49.33	74.00	-24.67	Peak	HORIZONTAL
8055.00	35.19	36.54	31.18	11.18	51.73	74.00	-22.27	Peak	HORIZONTAL
8854.00	33.92	36.87	32.22	11.76	50.33	74.00	-23.67	Peak	HORIZONTAL
9296.00	33.59	36.84	32.48	12.14	50.09	74.00	-23.91	Peak	HORIZONTAL
10639.00	36.20	36.80	33.43	12.94	52.51	74.00	-21.49	Peak	HORIZONTAL
12815.00	33.86	38.62	35.58	14.66	51.56	74.00	-22.44	Peak	HORIZONTAL
Conclusion: Pass									
Note: -27 dBm/MHz Limit=95.2+EIRP[dBm]=95.2-27=68.2 dBμV/m For transmitters operating in the 5150MHz-5250MHz, 5250MHz-5350MHz, 5470MHz-5725MHz, 5725MHz-5850MHz band: all emissions outside of the 5.15-5.35 GHz band shall not exceed an EIRP of -27 dBm/MHz.									

Note: 1. 30MHz-40GHz: (Scan with 11a, 11n HT20, 11n HT40, 11ac20, 11ac40 and 11ac80 the worst case is 11a ANT1+ANT 2 Mode)

2. Result Level = Read Level + Antenna Factor + Cable loss - PRM Factor.

3. Test setup: RBW: 1 MHz, VBW: 3 MHz, Sweep time: auto.



Freq (MHz)	Read level (dBμV)	Antenna Factor (dB/m)	PRM Factor (dB)	Cable Loss (dB)	Result Level (dBμV/m)	Limit (dBμ V/m)	Margin (dB)	Detector type	Polarization
<b>11a CH100</b>									
6406.00	33.87	35.65	29.66	9.88	49.74	74.00	-24.26	Peak	VERTICAL
7970.00	34.23	36.69	31.12	11.12	50.92	74.00	-23.08	Peak	VERTICAL
8939.00	33.21	37.24	32.26	11.79	49.98	74.00	-24.02	Peak	VERTICAL
9636.00	33.64	36.54	32.75	12.38	49.81	74.00	-24.19	Peak	VERTICAL
10996.00	33.17	37.79	33.98	13.48	50.46	74.00	-23.54	Peak	VERTICAL
12050.00	33.20	37.67	34.82	14.26	50.31	74.00	-23.69	Peak	VERTICAL
6916.00	35.86	36.13	30.33	10.37	52.03	74.00	-21.97	Peak	HORIZONTAL
7953.00	34.09	36.69	31.11	11.10	50.77	74.00	-23.23	Peak	HORIZONTAL
9364.00	33.47	36.69	32.52	12.22	49.86	74.00	-24.14	Peak	HORIZONTAL
10571.00	34.04	36.60	33.33	12.80	50.11	74.00	-23.89	Peak	HORIZONTAL
12050.00	32.34	37.67	34.82	14.26	49.45	74.00	-24.55	Peak	HORIZONTAL
13206.00	33.52	39.01	35.54	14.73	51.72	74.00	-22.28	Peak	HORIZONTAL
<b>11a CH116</b>									
6916.00	33.91	36.13	30.33	10.37	50.08	74.00	-23.92	Peak	VERTICAL
8769.00	33.62	36.50	32.15	11.73	49.70	74.00	-24.30	Peak	VERTICAL
10384.00	32.99	36.51	33.17	12.65	48.98	74.00	-25.02	Peak	VERTICAL
11166.00	35.16	37.43	34.21	13.52	51.90	74.00	-22.10	Peak	VERTICAL
11285.00	32.24	37.17	34.35	13.54	48.60	74.00	-25.40	Peak	VERTICAL
13206.00	34.20	39.01	35.54	14.73	52.40	74.00	-21.60	Peak	VERTICAL
7120.00	33.97	36.30	30.44	10.55	50.38	74.00	-23.62	Peak	HORIZONTAL
8055.00	33.92	36.54	31.18	11.18	50.46	74.00	-23.54	Peak	HORIZONTAL
9636.00	33.23	36.54	32.75	12.38	49.40	74.00	-24.60	Peak	HORIZONTAL
11030.00	32.02	37.73	34.03	13.49	49.21	74.00	-24.79	Peak	HORIZONTAL
11931.00	31.85	37.48	34.77	14.16	48.72	74.00	-25.28	Peak	HORIZONTAL
12679.00	34.36	38.48	35.48	14.65	52.01	74.00	-21.99	Peak	HORIZONTAL
<b>11a CH140</b>									
7409.00	34.45	36.53	30.67	10.78	51.09	74.00	-22.91	Peak	VERTICAL
8191.00	34.19	36.16	31.29	11.33	50.39	74.00	-23.61	Peak	VERTICAL
10605.00	33.60	36.70	33.37	12.88	49.81	74.00	-24.19	Peak	VERTICAL
11404.00	36.32	36.91	34.43	13.57	52.37	74.00	-21.63	Peak	VERTICAL
12611.00	32.80	38.41	35.36	14.65	50.50	74.00	-23.50	Peak	VERTICAL
13359.00	34.61	39.16	35.42	14.76	53.11	74.00	-20.89	Peak	VERTICAL
6984.00	34.18	36.19	30.38	10.40	50.39	74.00	-23.61	Peak	HORIZONTAL
8021.00	33.95	36.64	31.17	11.16	50.58	74.00	-23.42	Peak	HORIZONTAL
9075.00	33.34	37.33	32.35	11.89	50.21	74.00	-23.79	Peak	HORIZONTAL
10605.00	32.72	36.70	33.37	12.88	48.93	74.00	-25.07	Peak	HORIZONTAL
11404.00	34.32	36.91	34.43	13.57	50.37	74.00	-23.63	Peak	HORIZONTAL
13291.00	34.53	39.09	35.47	14.74	52.89	74.00	-21.11	Peak	HORIZONTAL
Conclusion: Pass									
Note: -27 dBm/MHz Limit=95.2+EIRP[dBm]=95.2-27=68.2 dBμV/m For transmitters operating in the 5150MHz-5250MHz, 5250MHz-5350MHz, 5470MHz-5725MHz, 5725MHz-5850MHz band: all emissions outside of the 5.15-5.35 GHz band shall not exceed an EIRP of -27 dBm/MHz.									

Note: 1. 30MHz~40GHz: (Scan with 11a, 11n HT20, 11n HT40, 11ac20, 11ac40 and 11ac80 the worst case is 11a ANT1+ANT 2 Mode)

2. Result Level = Read Level + Antenna Factor + Cable loss - PRM Factor.

3. Test setup: RBW: 1 MHz, VBW: 3 MHz, Sweep time: auto.

Freq (MHz)	Read level (dBμV)	Antenna Factor (dB/m)	PRM Factor (dB)	Cable Loss (dB)	Result Level (dBμV/m)	Limit (dBμ V/m)	Margin (dB)	Detector type	Polarization
<b>11a CH149</b>									
6984.00	34.89	36.19	30.38	10.40	51.10	74.00	-22.90	Peak	VERTICAL
8089.00	33.69	36.44	31.20	11.23	50.16	74.00	-23.84	Peak	VERTICAL
9755.00	34.28	36.66	32.82	12.40	50.52	74.00	-23.48	Peak	VERTICAL
10724.00	33.80	37.04	33.51	13.05	50.38	74.00	-23.62	Peak	VERTICAL
11659.00	33.70	36.99	34.62	13.81	49.88	74.00	-24.12	Peak	VERTICAL
12968.00	33.33	38.77	35.70	14.67	51.07	74.00	-22.93	Peak	VERTICAL
6746.00	35.02	36.00	30.18	10.19	51.03	74.00	-22.97	Peak	HORIZONTAL
7715.00	34.54	36.64	30.99	10.98	51.17	74.00	-22.83	Peak	HORIZONTAL
8990.00	34.55	37.46	32.32	11.81	51.50	74.00	-22.50	Peak	HORIZONTAL
10554.00	33.50	36.55	33.31	12.77	49.51	74.00	-24.49	Peak	HORIZONTAL
12084.00	32.47	37.72	34.85	14.30	49.64	74.00	-24.36	Peak	HORIZONTAL
13461.00	33.94	39.26	35.22	14.79	52.77	74.00	-21.23	Peak	HORIZONTAL
<b>11a CH157</b>									
6984.00	34.45	36.19	30.38	10.40	50.66	74.00	-23.34	Peak	VERTICAL
8055.00	33.06	36.54	31.18	11.18	49.60	74.00	-24.40	Peak	VERTICAL
9109.00	33.70	37.26	32.36	11.95	50.55	74.00	-23.45	Peak	VERTICAL
10639.00	33.24	36.80	33.43	12.94	49.55	74.00	-24.45	Peak	VERTICAL
11574.00	36.17	36.84	34.56	13.67	52.12	74.00	-21.88	Peak	VERTICAL
13036.00	34.57	38.84	35.67	14.68	52.42	74.00	-21.58	Peak	VERTICAL
6984.00	34.56	36.19	30.38	10.40	50.77	74.00	-23.23	Peak	HORIZONTAL
7936.00	35.32	36.69	31.11	11.10	52.00	74.00	-22.00	Peak	HORIZONTAL
9075.00	34.25	37.33	32.35	11.89	51.12	74.00	-22.88	Peak	HORIZONTAL
10639.00	33.69	36.80	33.43	12.94	50.00	74.00	-24.00	Peak	HORIZONTAL
11574.00	33.94	36.84	34.56	13.67	49.89	74.00	-24.11	Peak	HORIZONTAL
13036.00	33.65	38.84	35.67	14.68	51.50	74.00	-22.50	Peak	HORIZONTAL
<b>11a CH165</b>									
7001.00	34.02	36.20	30.39	10.44	50.27	74.00	-23.73	Peak	VERTICAL
8854.00	34.06	36.87	32.22	11.76	50.47	74.00	-23.53	Peak	VERTICAL
9755.00	33.72	36.66	32.82	12.40	49.96	74.00	-24.04	Peak	VERTICAL
11285.00	32.53	37.17	34.35	13.54	48.89	74.00	-25.11	Peak	VERTICAL
12679.00	33.13	38.48	35.48	14.65	50.78	74.00	-23.22	Peak	VERTICAL
13206.00	34.65	39.01	35.54	14.73	52.85	74.00	-21.15	Peak	VERTICAL
6746.00	34.45	36.00	30.18	10.19	50.46	74.00	-23.54	Peak	HORIZONTAL
8055.00	35.94	36.54	31.18	11.18	52.48	74.00	-21.52	Peak	HORIZONTAL
8956.00	33.25	37.31	32.28	11.79	50.07	74.00	-23.93	Peak	HORIZONTAL
10605.00	33.11	36.70	33.37	12.88	49.32	74.00	-24.68	Peak	HORIZONTAL
11030.00	32.77	37.73	34.03	13.49	49.96	74.00	-24.04	Peak	HORIZONTAL
12815.00	33.51	38.62	35.58	14.66	51.21	74.00	-22.79	Peak	HORIZONTAL
Conclusion: Pass									
Note: $-27 \text{ dBm/MHz Limit} = 95.2 + \text{EIRP}[\text{dBm}] = 95.2 - 27 = 68.2 \text{ dB}\mu\text{V/m}$ For transmitters operating in the 5150MHz-5250MHz, 5250MHz-5350MHz, 5470MHz-5725MHz, 5725MHz-5850MHz band: all emissions outside of the 5.15-5.35 GHz band shall not exceed an EIRP of $-27 \text{ dBm/MHz}$ .									

Note: 1. 30MHz~40GHz: (Scan with 11a, 11n HT20, 11n HT40, 11ac20, 11ac40 and 11ac80 the worst case is 11a ANT1+ANT 2 Mode)

2. Result Level = Read Level + Antenna Factor + Cable loss - PRM Factor.

3. Test setup: RBW: 1 MHz, VBW: 3 MHz, Sweep time: auto.

## 10. Band Edge Compliance

### 10.1. Block diagram of test setup

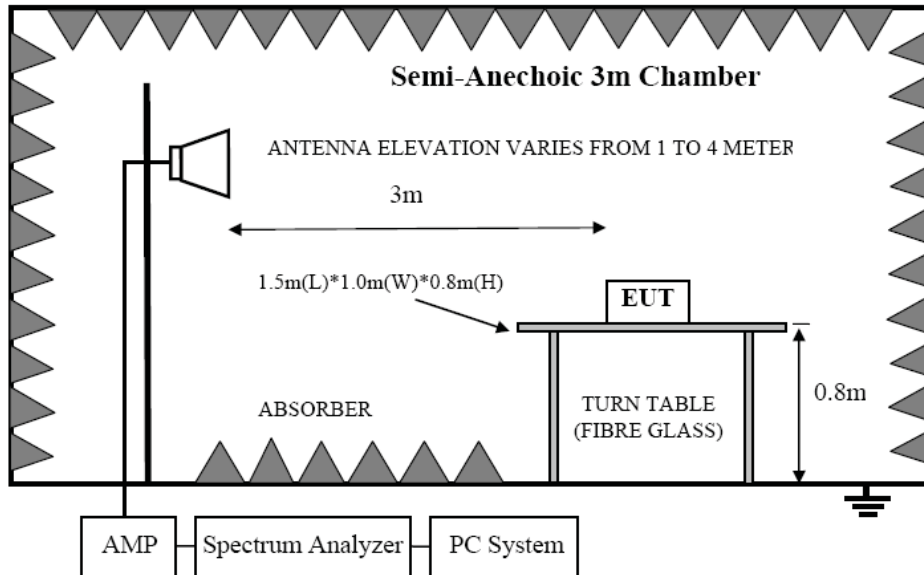

### 10.2. Limit

For transmitters operating in the 5.15-5.25 GHz and 5.725-5.85G band: all emissions outside of the 5.15-5.35 GHz band shall not exceed an EIRP of -27 dBm/MHz.

$$-27 \text{ dBm/MHz Limit} = 95.2 + \text{EIRP}[\text{dBm}] = 95.2 - 27 = 68.2 \text{ dB}\mu\text{V/m}$$

### 10.3. Test Procedure

Same with clause 8.3 except change investigated frequency range from 5.15-5.25 GHz, 5250-5350GHz, 5470-5725GHz, 5.725-5.85G.

Remark: All restriction band have been tested, and only the worse case is shown in report.

### 10.4. Test result

#### **PASS. (See below detailed test result)**

Note1: As specified in 15.407(b), emissions above 1000 MHz that are outside of the restricted bands are subject to a peak emission limit of -27 dBm/MHz (or -17 dBm/MHz as specified in 15.407(b)(4)). However, an out-of-band emission that complies with both the average and peak limits of 15.209 is not required to satisfy the -27 dBm/MHz or -17 dBm/MHz peak emission limit.

Note2: the worst case is ANT1+ANT 2 mode.

## TR-4-E-009 Radiated Emission Test Result

**Test Site** : DDT 3m Chamber 1# D:\2017 RE1# Report Data\Q17090505-1E\RF FCC 1-18G 5GWIFI  
边带.EM6  
**Test Date** : 2017-10-16 **Tested By** : Sunny  
**EUT** : Wireless Adaptor and 120W Digital Amplifier **Model Number** : ADAPT+AMP  
**Power Supply** : AC 120V/60Hz **Test Mode** : TX mode  
**Condition** : Temp:24.5°C,Humi:55%,  
Press:100.1kPa **Antenna/Distance** : 2016 HF907/3m/VERTICAL  
**Memo** : 11a 5180MHz ANT1+ANT2

Data: 89

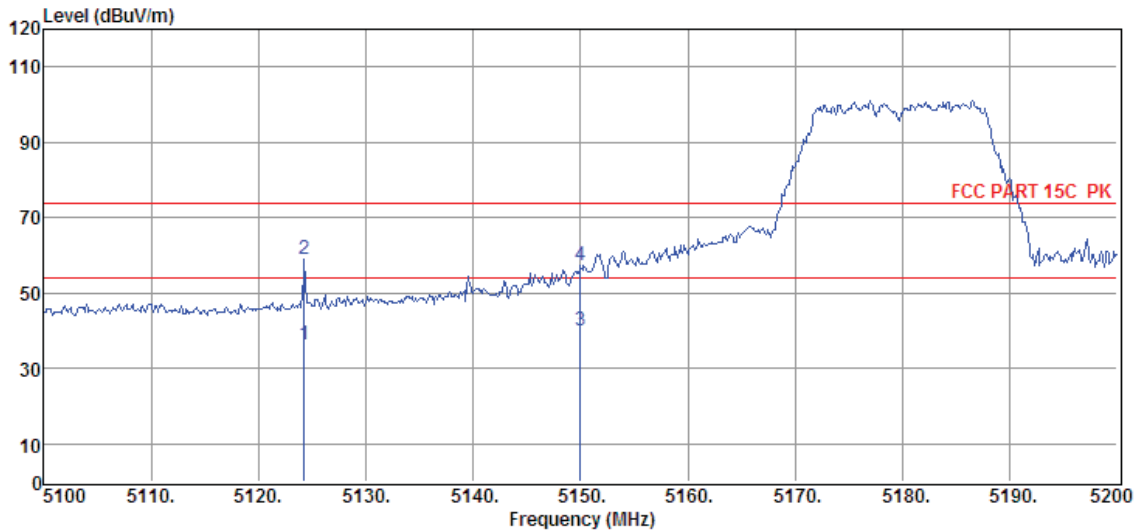

Item (Mark)	Freq. (MHz)	Read Level (dBμV)	Antenna Factor (dB/m)	PRM Factor dB	Cable Loss dB	Result Level (dBμV/m)	Limit Line (dBμV/m)	Over Limit (dB)	Detector	Polarization
1	5124.30	22.73	33.96	29.34	8.80	36.15	54.00	-17.85	Average	VERTICAL
2	5124.30	45.41	33.96	29.34	8.80	58.83	74.00	-15.17	Peak	VERTICAL
3	5150.00	26.38	34.01	29.33	8.84	39.90	54.00	-14.10	Average	VERTICAL
4	5150.00	43.60	34.01	29.33	8.84	57.12	74.00	-16.88	Peak	VERTICAL

Note: 1. Result Level = Read Level + Antenna Factor + Cable loss - PRM Factor.  
 2. If Peak Result complies with AV limit, AV Result is deemed to comply with AV limit.  
 3. Test setup: RBW: 1 MHz, VBW: 3 MHz, Sweep time: auto.

## TR-4-E-009 Radiated Emission Test Result

**Test Site** : DDT 3m Chamber 1# D:\2017 RE1# Report Data\Q17090505-1E\RF FCC 1-18G 5GWIFI 边带.EM6  
**Test Date** : 2017-10-16 **Tested By** : Sunny  
**EUT** : Wireless Adaptor and 120W Digital Amplifier **Model Number** : ADAPT+AMP  
**Power Supply** : AC 120V/60Hz **Test Mode** : TX mode  
**Condition** : Temp:24.5'C,Humi:55%,  
 Press:100.1kPa **Antenna/Distance** : 2016 HF907/3m/HORIZONTAL  
**Memo** : 11a 5180MHz ANT1+ANT2

Data: 90

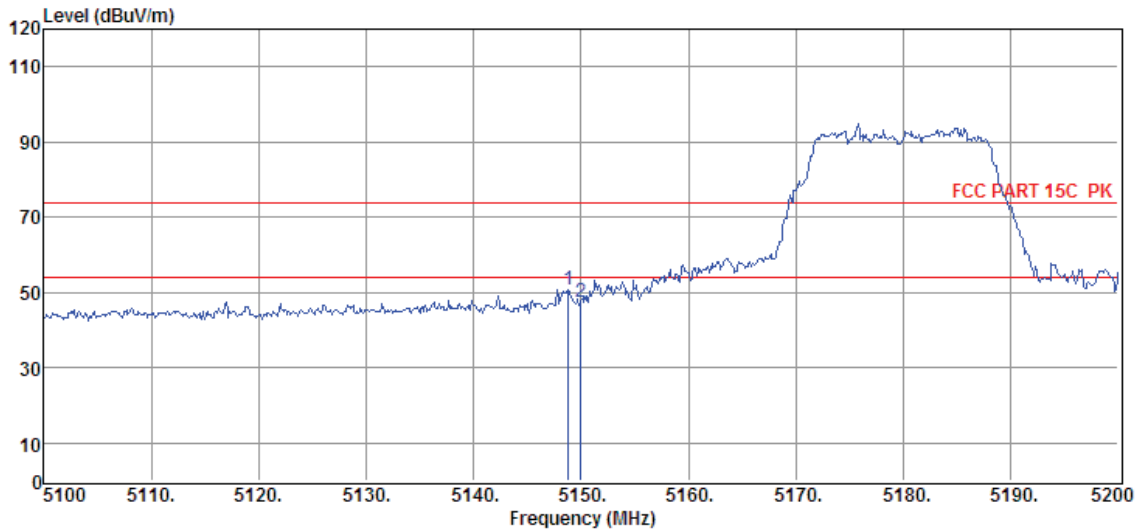

Item (Mark)	Freq. (MHz)	Read Level (dB $\mu$ V)	Antenna Factor (dB/m)	PRM Factor dB	Cable Loss dB	Result Level (dB $\mu$ V/m)	Limit Line (dB $\mu$ V/m)	Over Limit (dB)	Detector	Polarization
1	5148.80	37.22	34.01	29.33	8.84	50.74	74.00	-23.26	Peak	HORIZONTAL
2	5150.00	33.82	34.01	29.33	8.84	47.34	74.00	-26.66	Peak	HORIZONTAL

- Note: 1. Result Level = Read Level + Antenna Factor + Cable loss - PRM Factor.  
 2. If Peak Result complies with AV limit, AV Result is deemed to comply with AV limit.  
 3. Test setup: RBW: 1 MHz, VBW: 3 MHz, Sweep time: auto.

## TR-4-E-009 Radiated Emission Test Result

**Test Site** : DDT 3m Chamber 1# D:\2017 RE1# Report Data\Q17090505-1E\RF FCC 1-18G 5GWIFI 边带.EM6  
**Test Date** : 2017-10-16 **Tested By** : Sunny  
**EUT** : Wireless Adaptor and 120W Digital Amplifier **Model Number** : ADAPT+AMP  
**Power Supply** : AC 120V/60Hz **Test Mode** : TX mode  
**Condition** : Temp:24.5'C,Humi:55%,  
 Press:100.1kPa **Antenna/Distance** : 2016 HF907/3m/HORIZONTAL  
**Memo** : 11a 5240MHz ANT1+ANT2

Data: 91

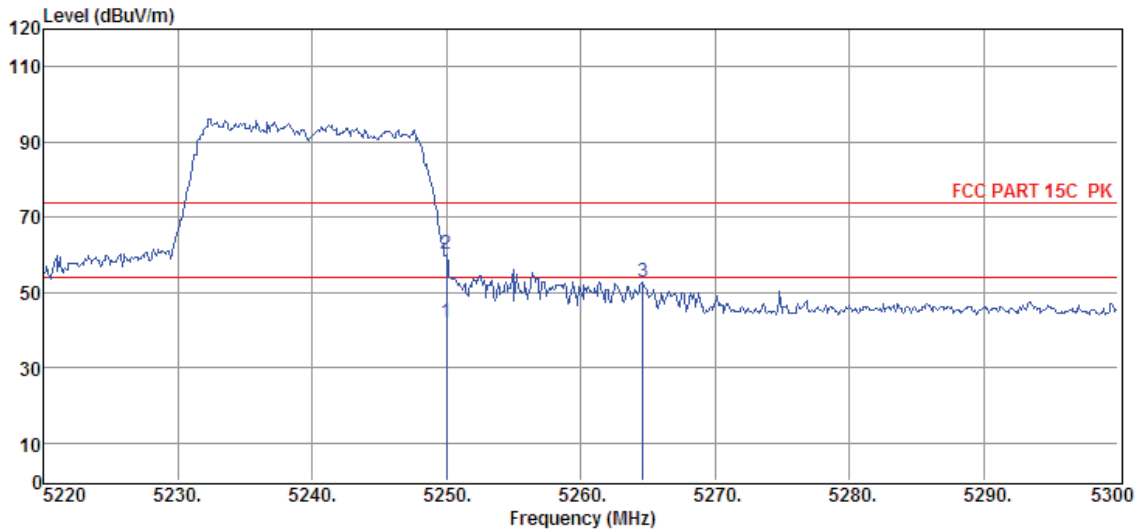

Item (Mark)	Freq. (MHz)	Read Level (dB $\mu$ V)	Antenna Factor (dB/m)	PRM Factor dB	Cable Loss dB	Result Level (dB $\mu$ V/m)	Limit Line (dB $\mu$ V/m)	Over Limit (dB)	Detector	Polarization
1	5250.00	28.25	34.21	29.32	8.93	42.07	54.00	-11.93	Average	HORIZONTAL
2	5250.00	46.24	34.21	29.32	8.93	60.06	74.00	-13.94	Peak	HORIZONTAL
3	5264.64	38.76	34.24	29.32	8.96	52.64	74.00	-21.36	Peak	HORIZONTAL

Note: 1. Result Level = Read Level + Antenna Factor + Cable loss - PRM Factor.

2. If Peak Result complies with AV limit, AV Result is deemed to comply with AV limit.

3. Test setup: RBW: 1 MHz, VBW: 3 MHz, Sweep time: auto.

## TR-4-E-009 Radiated Emission Test Result

**Test Site** : DDT 3m Chamber 1# D:\2017 RE1# Report Data\Q17090505-1E\RF FCC 1-18G 5GWIFI 边带.EM6  
**Test Date** : 2017-10-16 **Tested By** : Sunny  
**EUT** : Wireless Adaptor and 120W Digital Amplifier **Model Number** : ADAPT+AMP  
**Power Supply** : AC 120V/60Hz **Test Mode** : TX mode  
**Condition** : Temp:24.5'C,Humi:55%,  
 Press:100.1kPa **Antenna/Distance** : 2016 HF907/3m/VERTICAL  
**Memo** : 11a 5240MHz ANT1+ANT2

Data: 92

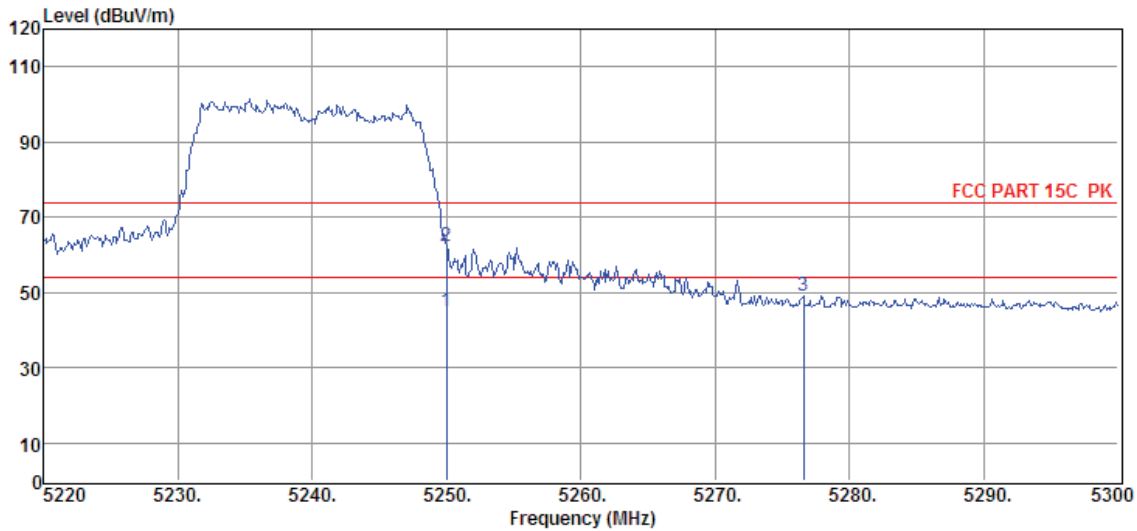

Item (Mark)	Freq. (MHz)	Read Level (dB $\mu$ V)	Antenna Factor (dB/m)	PRM Factor dB	Cable Loss dB	Result Level (dB $\mu$ V/m)	Limit Line (dB $\mu$ V/m)	Over Limit (dB)	Detector	Polarization
1	5250.00	31.14	34.21	29.32	8.93	44.96	54.00	-9.04	Average	VERTICAL
2	5250.00	48.25	34.21	29.32	8.93	62.07	74.00	-11.93	Peak	VERTICAL
3	5276.56	35.37	34.26	29.31	8.96	49.28	74.00	-24.72	Peak	VERTICAL

Note: 1. Result Level = Read Level + Antenna Factor + Cable loss - PRM Factor.

2. If Peak Result complies with AV limit, AV Result is deemed to comply with AV limit.

3. Test setup: RBW: 1 MHz, VBW: 3 MHz, Sweep time: auto.

## TR-4-E-009 Radiated Emission Test Result

**Test Site** : DDT 3m Chamber 1# D:\2017 RE1# Report Data\Q17090505-1E\RF FCC 1-18G 5GWIFI 边带.EM6  
**Test Date** : 2017-10-16 **Tested By** : Sunny  
**EUT** : Wireless Adaptor and 120W Digital Amplifier **Model Number** : ADAPT+AMP  
**Power Supply** : AC 120V/60Hz **Test Mode** : TX mode  
**Condition** : Temp:24.5'C,Humi:55%,  
 Press:100.1kPa **Antenna/Distance** : 2016 HF907/3m/VERTICAL  
**Memo** : 11a 5260MHz ANT1+ANT2

Data: 93

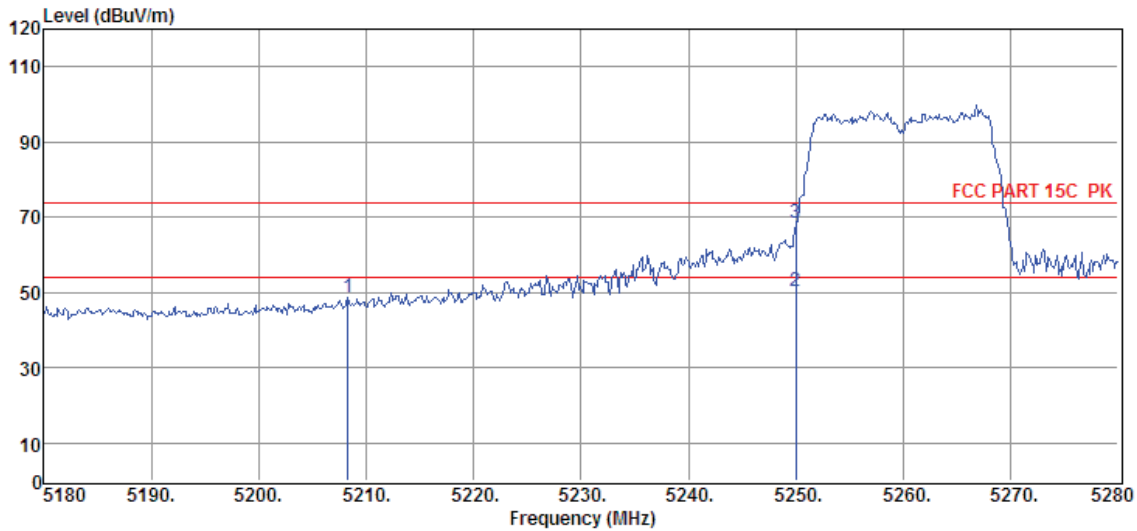

Item (Mark)	Freq. (MHz)	Read Level (dBμV)	Antenna Factor (dB/m)	PRM Factor dB	Cable Loss dB	Result Level (dBμV/m)	Limit Line (dBμV/m)	Over Limit (dB)	Detector	Polarization
1	5208.30	34.80	34.13	29.33	8.89	48.49	74.00	-25.51	Peak	VERTICAL
2	5250.00	36.61	34.21	29.32	8.93	50.43	54.00	-3.57	Average	VERTICAL
3	5250.00	54.74	34.21	29.32	8.93	68.56	74.00	-5.44	Peak	VERTICAL

- Note: 1. Result Level = Read Level + Antenna Factor + Cable loss - PRM Factor.  
 2. If Peak Result complies with AV limit, AV Result is deemed to comply with AV limit.  
 3. Test setup: RBW: 1 MHz, VBW: 3 MHz, Sweep time: auto.



# TR-4-E-009 Radiated Emission Test Result

**Test Site** : DDT 3m Chamber 1# D:\2017 RE1# Report Data\Q17090505-1E\RF FCC 1-18G 5GWIFI 边带.EM6  
**Test Date** : 2017-10-16 **Tested By** : Sunny  
**EUT** : Wireless Adaptor and 120W Digital Amplifier **Model Number** : ADAPT+AMP  
**Power Supply** : AC 120V/60Hz **Test Mode** : TX mode  
**Condition** : Temp:24.5'C,Humi:55%,  
 Press:100.1kPa **Antenna/Distance** : 2016 HF907/3m/HORIZONTAL  
**Memo** : 11a 5260MHz ANT1+ANT2

Data: 94

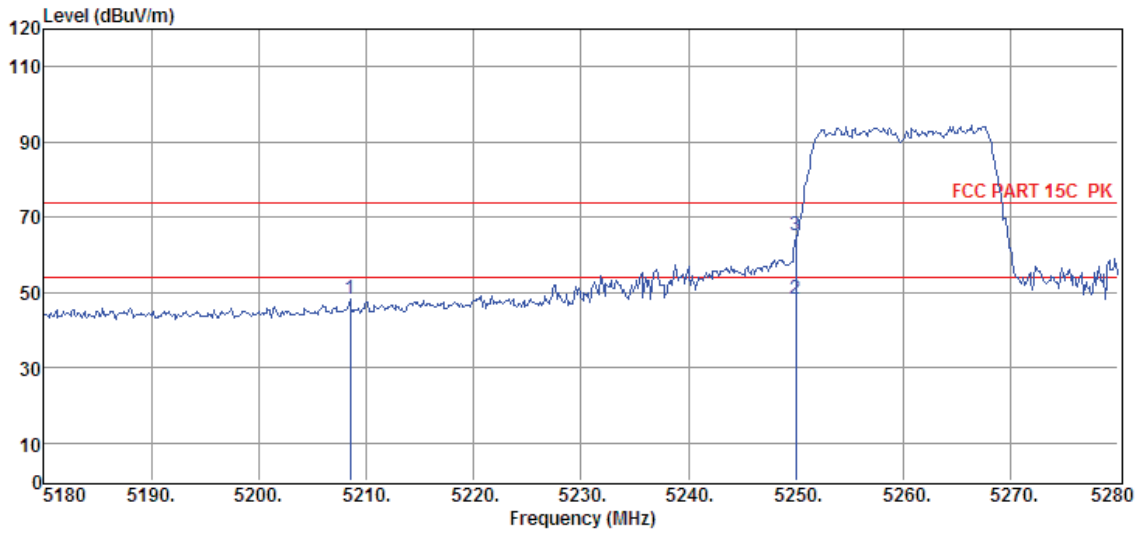

Item (Mark)	Freq. (MHz)	Read Level (dBμV)	Antenna Factor (dB/m)	PRM Factor dB	Cable Loss dB	Result Level (dBμV/m)	Limit Line (dBμV/m)	Over Limit (dB)	Detector	Polarization
1	5208.50	34.72	34.13	29.33	8.89	48.41	74.00	-25.59	Peak	HORIZONTAL
2	5250.00	34.34	34.21	29.32	8.93	48.16	54.00	-5.84	Average	HORIZONTAL
3	5250.00	51.46	34.21	29.32	8.93	65.28	74.00	-8.72	Peak	HORIZONTAL

- Note: 1. Result Level = Read Level + Antenna Factor + Cable loss - PRM Factor.  
 2. If Peak Result complies with AV limit, AV Result is deemed to comply with AV limit.  
 3. Test setup: RBW: 1 MHz, VBW: 3 MHz, Sweep time: auto.

# TR-4-E-009 Radiated Emission Test Result

**Test Site** : DDT 3m Chamber 1# D:\2017 RE1# Report Data\Q17090505-1E\RF FCC 1-18G 5GWIFI 边带.EM6  
**Test Date** : 2017-10-16 **Tested By** : Sunny  
**EUT** : Wireless Adaptor and 120W Digital Amplifier **Model Number** : ADAPT+AMP  
**Power Supply** : AC 120V/60Hz **Test Mode** : TX mode  
**Condition** : Temp:24.5'C,Humi:55%,  
 Press:100.1kPa **Antenna/Distance** : 2016 HF907/3m/HORIZONTAL  
**Memo** : 11a 5320MHz ANT1+ANT2

Data: 95

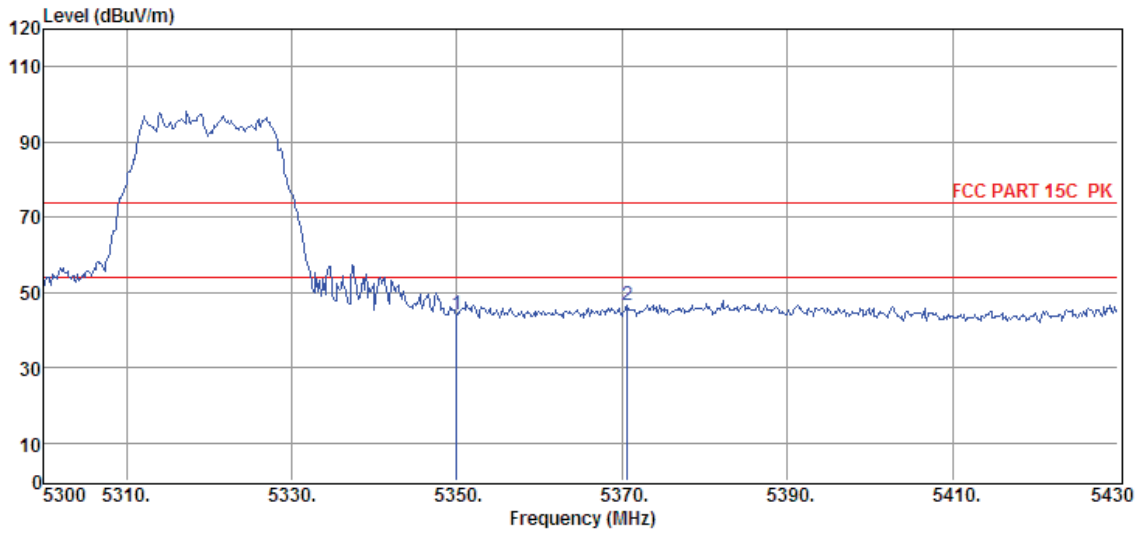

Item (Mark)	Freq. (MHz)	Read Level (dBμV)	Antenna Factor (dB/m)	PRM Factor dB	Cable Loss dB	Result Level (dBμV/m)	Limit Line (dBμV/m)	Over Limit (dB)	Detector	Polarization
1	5350.00	30.02	34.41	29.30	9.03	44.16	74.00	-29.84	Peak	HORIZONTAL
2	5370.59	32.31	34.45	29.30	9.05	46.51	74.00	-27.49	Peak	HORIZONTAL

- Note: 1. Result Level = Read Level + Antenna Factor + Cable loss - PRM Factor.  
 2. If Peak Result complies with AV limit, AV Result is deemed to comply with AV limit.  
 3. Test setup: RBW: 1 MHz, VBW: 3 MHz, Sweep time: auto.

## TR-4-E-009 Radiated Emission Test Result

**Test Site** : DDT 3m Chamber 1#  
**Test Date** : 2017-10-16  
**EUT** : Wireless Adaptor and 120W Digital Amplifier  
**Power Supply** : AC 120V/60Hz  
**Condition** : Temp:24.5°C,Humi:55%,  
 Press:100.1kPa  
**Memo** : 11a 5320MHz ANT1+ANT2

**D:\2017 RE1# Report Data\Q17090505-1E\RF FCC 1-18G 5GWIFI 边带.EM6**  
**Tested By** : Sunny  
**Model Number** : ADAPT+AMP  
**Test Mode** : TX mode  
**Antenna/Distance** : 2016 HF907/3m/VERTICAL

Data: 96

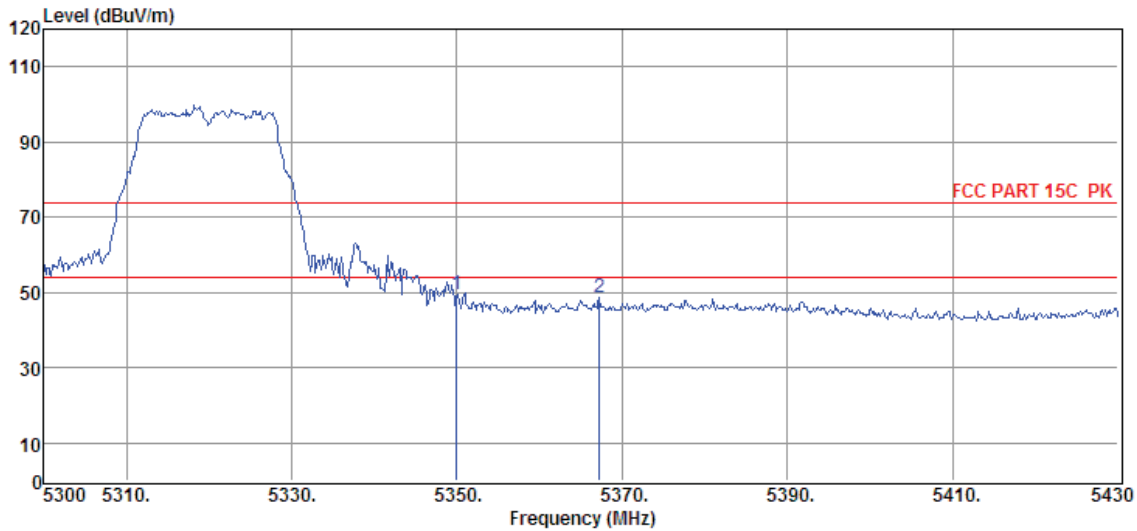

Item (Mark)	Freq. (MHz)	Read Level (dB $\mu$ V)	Antenna Factor (dB/m)	PRM Factor dB	Cable Loss dB	Result Level (dB $\mu$ V/m)	Limit Line (dB $\mu$ V/m)	Over Limit (dB)	Detector	Polarization
1	5350.00	35.53	34.41	29.30	9.03	49.67	74.00	-24.33	Peak	VERTICAL
2	5367.21	34.56	34.44	29.30	9.05	48.75	74.00	-25.25	Peak	VERTICAL

- Note: 1. Result Level = Read Level + Antenna Factor + Cable loss - PRM Factor.  
 2. If Peak Result complies with AV limit, AV Result is deemed to comply with AV limit.  
 3. Test setup: RBW: 1 MHz, VBW: 3 MHz, Sweep time: auto.

# TR-4-E-009 Radiated Emission Test Result

**Test Site** : DDT 3m Chamber 1# D:\2017 RE1# Report Data\Q17090505-1E\RF FCC 1-18G 5GWIFI 边带.EM6  
**Test Date** : 2017-10-16 **Tested By** : Sunny  
**EUT** : Wireless Adaptor and 120W Digital Amplifier **Model Number** : ADAPT+AMP  
**Power Supply** : AC 120V/60Hz **Test Mode** : TX mode  
**Condition** : Temp:24.5'C,Humi:55%,  
 Press:100.1kPa **Antenna/Distance** : 2016 HF907/3m/VERTICAL  
**Memo** : 11a 5500MHz ANT1+ANT2

Data: 97

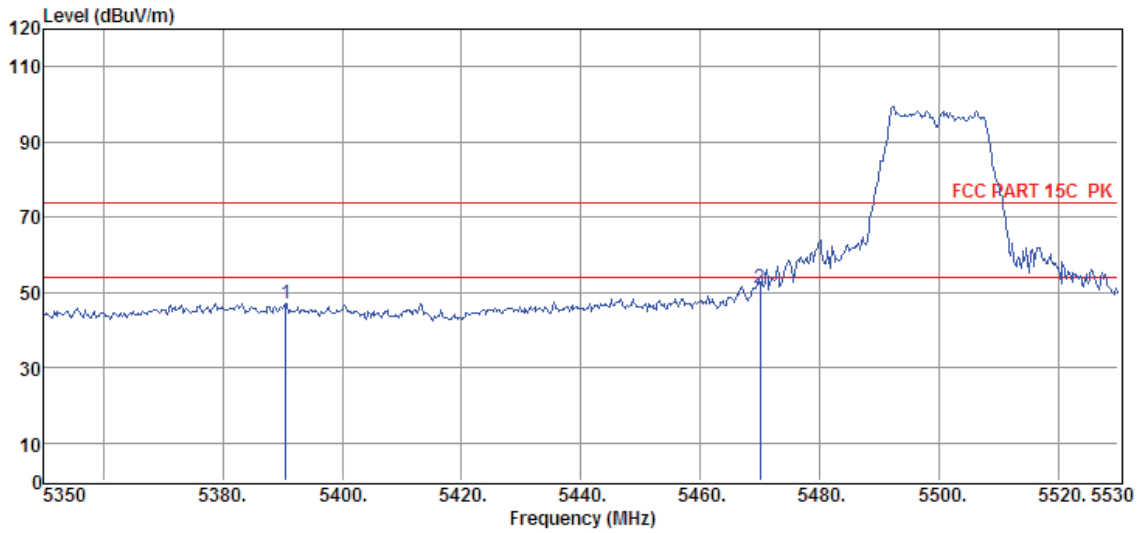

Item (Mark)	Freq. (MHz)	Read Level (dBμV)	Antenna Factor (dB/m)	PRM Factor dB	Cable Loss dB	Result Level (dBμV/m)	Limit Line (dBμV/m)	Over Limit (dB)	Detector	Polarization
1	5390.50	32.75	34.49	29.30	9.09	47.03	74.00	-26.97	Peak	VERTICAL
2	5470.00	36.67	34.64	29.27	9.16	51.20	74.00	-22.80	Peak	VERTICAL

- Note: 1. Result Level = Read Level + Antenna Factor + Cable loss - PRM Factor.  
 2. If Peak Result complies with AV limit, AV Result is deemed to comply with AV limit.  
 3. Test setup: RBW: 1 MHz, VBW: 3 MHz, Sweep time: auto.

# TR-4-E-009 Radiated Emission Test Result

**Test Site** : DDT 3m Chamber 1# D:\2017 RE1# Report Data\Q17090505-1E\RF FCC 1-18G 5GWIFI 边带.EM6  
**Test Date** : 2017-10-16 **Tested By** : Sunny  
**EUT** : Wireless Adaptor and 120W Digital Amplifier **Model Number** : ADAPT+AMP  
**Power Supply** : AC 120V/60Hz **Test Mode** : TX mode  
**Condition** : Temp:24.5'C,Humi:55%,  
 Press:100.1kPa **Antenna/Distance** : 2016 HF907/3m/HORIZONTAL  
**Memo** : 11a 5500MHz ANT1+ANT2

Data: 98

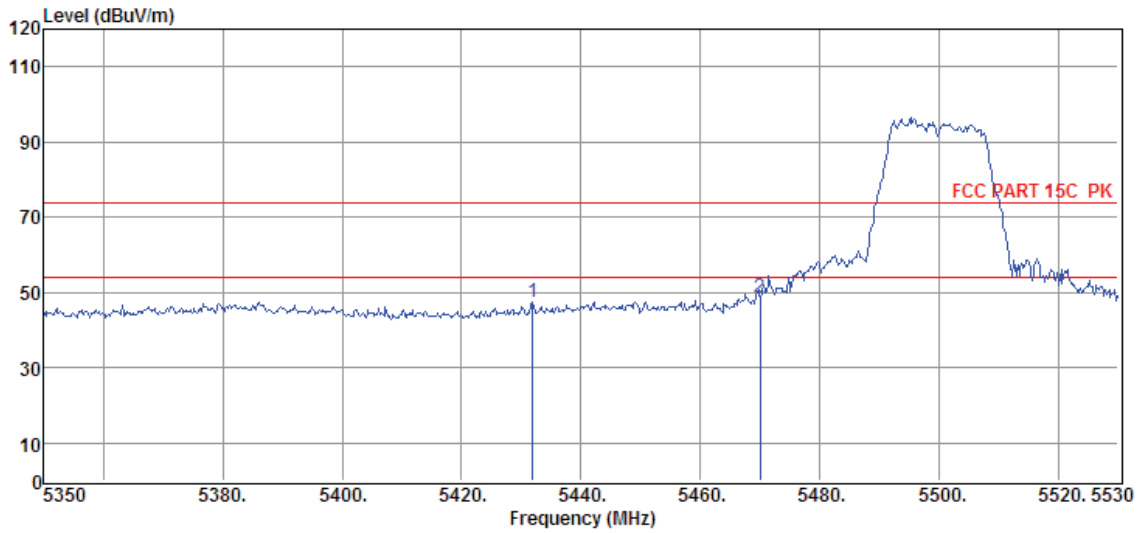

Item (Mark)	Freq. (MHz)	Read Level (dBμV)	Antenna Factor (dB/m)	PRM Factor dB	Cable Loss dB	Result Level (dBμV/m)	Limit Line (dBμV/m)	Over Limit (dB)	Detector	Polarization
1	5431.90	33.09	34.57	29.28	9.11	47.49	74.00	-26.51	Peak	HORIZONTAL
2	5470.00	34.15	34.64	29.27	9.16	48.68	74.00	-25.32	Peak	HORIZONTAL

- Note: 1. Result Level = Read Level + Antenna Factor + Cable loss - PRM Factor.  
 2. If Peak Result complies with AV limit, AV Result is deemed to comply with AV limit.  
 3. Test setup: RBW: 1 MHz, VBW: 3 MHz, Sweep time: auto.

# TR-4-E-009 Radiated Emission Test Result

**Test Site** : DDT 3m Chamber 1# D:\2017 RE1# Report Data\Q17090505-1E\RF FCC 1-18G 5GWIFI 边带.EM6  
**Test Date** : 2017-10-16 **Tested By** : Sunny  
**EUT** : Wireless Adaptor and 120W Digital Amplifier **Model Number** : ADAPT+AMP  
**Power Supply** : AC 120V/60Hz **Test Mode** : TX mode  
**Condition** : Temp:24.5°C,Humi:55%,  
 Press:100.1kPa **Antenna/Distance** : 2016 HF907/3m/HORIZONTAL  
**Memo** : 11a 5700MHz ANT1+ANT2

Data: 99

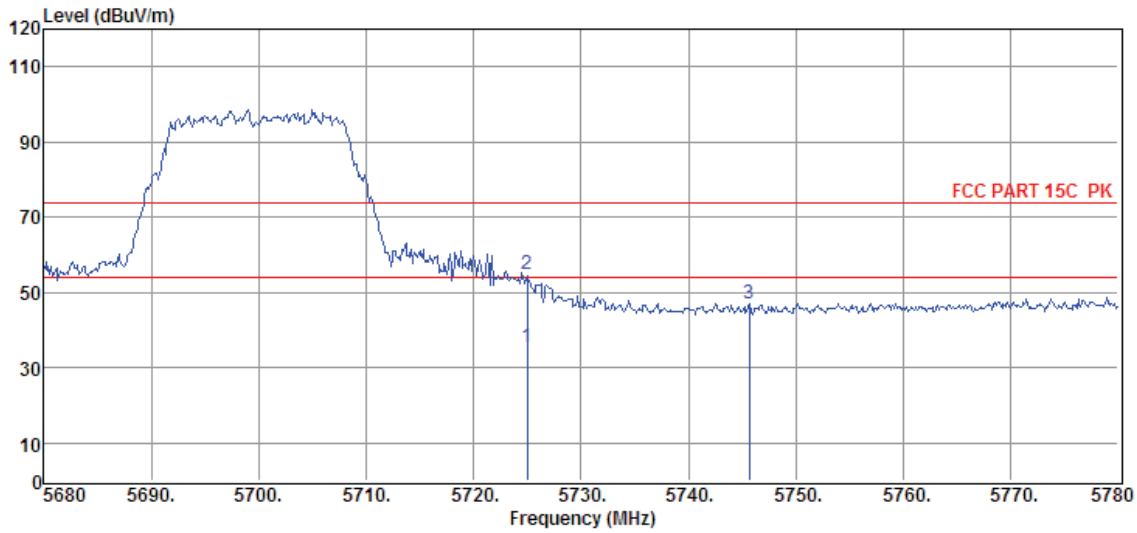

Item (Mark)	Freq. (MHz)	Read Level (dBμV)	Antenna Factor (dB/m)	PRM Factor (dB)	Cable Loss (dB)	Result Level (dBμV/m)	Limit Line (dBμV/m)	Over Limit (dB)	Detector	Polarization
1	5725.00	20.24	34.84	29.22	9.41	35.27	54.00	-18.73	Average	HORIZONTAL
2	5725.00	39.80	34.84	29.22	9.41	54.83	74.00	-19.17	Peak	HORIZONTAL
3	5745.70	31.87	34.85	29.21	9.43	46.94	74.00	-27.06	Peak	HORIZONTAL

- Note: 1. Result Level = Read Level + Antenna Factor + Cable loss - PRM Factor.  
 2. If Peak Result complies with AV limit, AV Result is deemed to comply with AV limit.  
 3. Test setup: RBW: 1 MHz, VBW: 3 MHz, Sweep time: auto.

## TR-4-E-009 Radiated Emission Test Result

**Test Site** : DDT 3m Chamber 1# D:\2017 RE1# Report Data\Q17090505-1E\RF FCC 1-18G 5GWIFI 边带.EM6  
**Test Date** : 2017-10-16 **Tested By** : Sunny  
**EUT** : Wireless Adaptor and 120W Digital Amplifier **Model Number** : ADAPT+AMP  
**Power Supply** : AC 120V/60Hz **Test Mode** : TX mode  
**Condition** : Temp:24.5°C,Humi:55%,  
 Press:100.1kPa **Antenna/Distance** : 2016 HF907/3m/VERTICAL  
**Memo** : 11a 5700MHz ANT1+ANT2

Data: 100

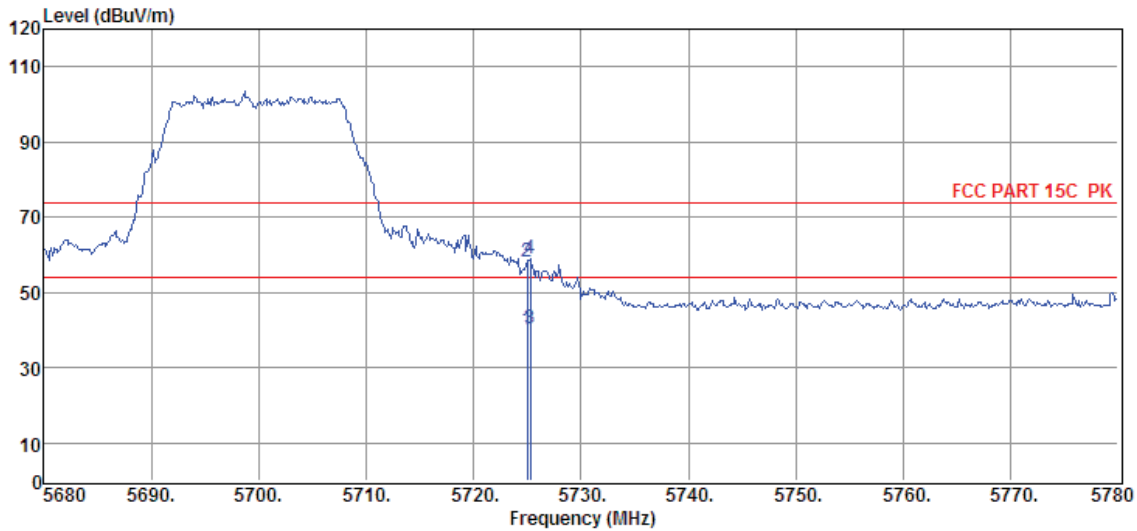

Item (Mark)	Freq. (MHz)	Read Level (dB $\mu$ V)	Antenna Factor (dB/m)	PRM Factor dB	Cable Loss dB	Result Level (dB $\mu$ V/m)	Limit Line (dB $\mu$ V/m)	Over Limit (dB)	Detector	Polarization
1	5725.00	25.14	34.84	29.22	9.41	40.17	54.00	-13.83	Average	VERTICAL
2	5725.00	43.28	34.84	29.22	9.41	58.31	74.00	-15.69	Peak	VERTICAL
3	5725.30	25.37	34.84	29.22	9.41	40.40	54.00	-13.60	Average	VERTICAL
4	5725.30	43.79	34.84	29.22	9.41	58.82	74.00	-15.18	Peak	VERTICAL

- Note: 1. Result Level = Read Level + Antenna Factor + Cable loss - PRM Factor.  
 2. If Peak Result complies with AV limit, AV Result is deemed to comply with AV limit.  
 3. Test setup: RBW: 1 MHz, VBW: 3 MHz, Sweep time: auto.

# TR-4-E-009 Radiated Emission Test Result

**Test Site** : DDT 3m Chamber 1# D:\2017 RE1# Report Data\Q17090505-1E\RF FCC 1-18G 5GWIFI 边带.EM6  
**Test Date** : 2017-10-16 **Tested By** : Sunny  
**EUT** : Wireless Adaptor and 120W Digital Amplifier **Model Number** : ADAPT+AMP  
**Power Supply** : AC 120V/60Hz **Test Mode** : TX mode  
**Condition** : Temp:24.5°C,Humi:55%,  
 Press:100.1kPa **Antenna/Distance** : 2016 HF907/3m/VERTICAL  
**Memo** : 11a 5745MHz ANT1+ANT2

Data: 101

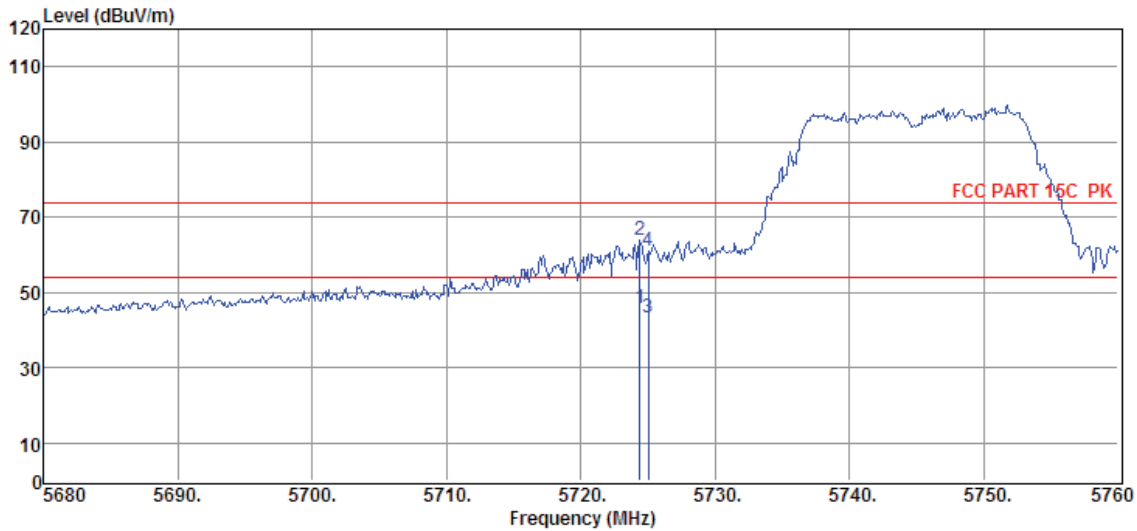

Item (Mark)	Freq. (MHz)	Read Level (dBμV)	Antenna Factor (dB/m)	PRM Factor (dB)	Cable Loss (dB)	Result Level (dBμV/m)	Limit Line (dBμV/m)	Over Limit (dB)	Detector	Polarization
1	5724.40	30.64	34.84	29.22	9.41	45.67	54.00	-8.33	Average	VERTICAL
2	5724.40	48.90	34.84	29.22	9.41	63.93	74.00	-10.07	Peak	VERTICAL
3	5725.00	28.14	34.84	29.22	9.41	43.17	54.00	-10.83	Average	VERTICAL
4	5725.00	46.02	34.84	29.22	9.41	61.05	74.00	-12.95	Peak	VERTICAL

Note: 1. Result Level = Read Level + Antenna Factor + Cable loss - PRM Factor.  
 2. If Peak Result complies with AV limit, AV Result is deemed to comply with AV limit.  
 3. Test setup: RBW: 1 MHz, VBW: 3 MHz, Sweep time: auto.



## TR-4-E-009 Radiated Emission Test Result

**Test Site** : DDT 3m Chamber 1# D:\2017 RE1# Report Data\Q17090505-1E\RF FCC 1-18G 5GWIFI 边带.EM6  
**Test Date** : 2017-10-16 **Tested By** : Sunny  
**EUT** : Wireless Adaptor and 120W Digital Amplifier **Model Number** : ADAPT+AMP  
**Power Supply** : AC 120V/60Hz **Test Mode** : TX mode  
**Condition** : Temp:24.5'C,Humi:55%,  
 Press:100.1kPa **Antenna/Distance** : 2016 HF907/3m/HORIZONTAL  
**Memo** : 11a 5745MHz ANT1+ANT2

Data: 102

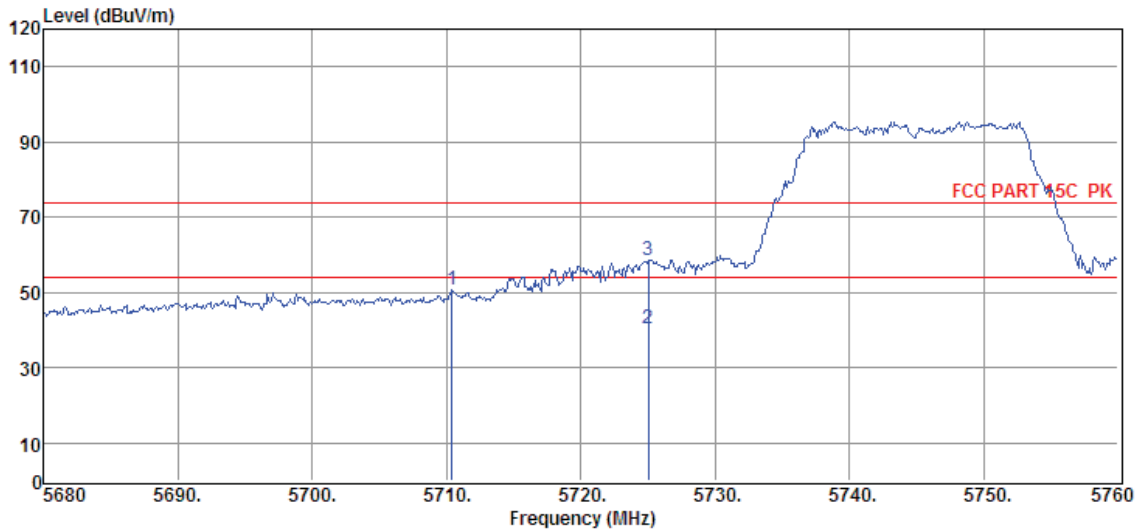

Item (Mark)	Freq. (MHz)	Read Level (dB $\mu$ V)	Antenna Factor (dB/m)	PRM Factor dB	Cable Loss dB	Result Level (dB $\mu$ V/m)	Limit Line (dB $\mu$ V/m)	Over Limit (dB)	Detector	Polarization
1	5710.40	35.70	34.83	29.22	9.38	50.69	74.00	-23.31	Peak	HORIZONTAL
2	5725.00	25.21	34.84	29.22	9.41	40.24	54.00	-13.76	Average	HORIZONTAL
3	5725.00	43.65	34.84	29.22	9.41	58.68	74.00	-15.32	Peak	HORIZONTAL

Note: 1. Result Level = Read Level + Antenna Factor + Cable loss - PRM Factor.

2. If Peak Result complies with AV limit, AV Result is deemed to comply with AV limit.

3. Test setup: RBW: 1 MHz, VBW: 3 MHz, Sweep time: auto.

# TR-4-E-009 Radiated Emission Test Result

**Test Site** : DDT 3m Chamber 1# D:\2017 RE1# Report Data\Q17090505-1E\RF FCC 1-18G 5GWIFI 边带.EM6  
**Test Date** : 2017-10-16 **Tested By** : Sunny  
**EUT** : Wireless Adaptor and 120W Digital Amplifier **Model Number** : ADAPT+AMP  
**Power Supply** : AC 120V/60Hz **Test Mode** : TX mode  
**Condition** : Temp:24.5°C,Humi:55%,  
 Press:100.1kPa **Antenna/Distance** : 2016 HF907/3m/VERTICAL  
**Memo** : 11a 5825MHz ANT1+ANT2

Data: 103

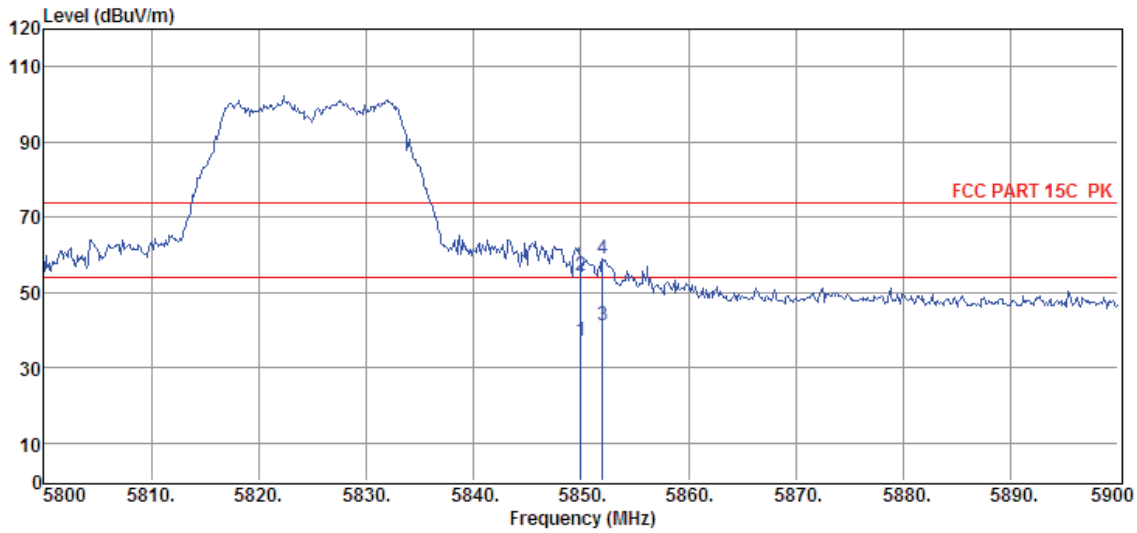

Item (Mark)	Freq. (MHz)	Read Level (dBμV)	Antenna Factor (dB/m)	PRM Factor dB	Cable Loss dB	Result Level (dBμV/m)	Limit Line (dBμV/m)	Over Limit (dB)	Detector	Polarization
1	5850.00	21.74	34.91	29.20	9.54	36.99	54.00	-17.01	Average	VERTICAL
2	5850.00	39.29	34.91	29.20	9.54	54.54	74.00	-19.46	Peak	VERTICAL
3	5852.00	26.16	34.91	29.20	9.54	41.41	54.00	-12.59	Average	VERTICAL
4	5852.00	43.77	34.91	29.20	9.54	59.02	74.00	-14.98	Peak	VERTICAL

Note: 1. Result Level = Read Level + Antenna Factor + Cable loss - PRM Factor.  
 2. If Peak Result complies with AV limit, AV Result is deemed to comply with AV limit.  
 3. Test setup: RBW: 1 MHz, VBW: 3 MHz, Sweep time: auto.

## TR-4-E-009 Radiated Emission Test Result

**Test Site** : DDT 3m Chamber 1# D:\2017 RE1# Report Data\Q17090505-1E\RF FCC 1-18G 5GWIFI 边带.EM6  
**Test Date** : 2017-10-16 **Tested By** : Sunny  
**EUT** : Wireless Adaptor and 120W Digital Amplifier **Model Number** : ADAPT+AMP  
**Power Supply** : AC 120V/60Hz **Test Mode** : TX mode  
**Condition** : Temp:24.5°C,Humi:55%,  
 Press:100.1kPa **Antenna/Distance** : 2016 HF907/3m/HORIZONTAL  
**Memo** : 11a 5825MHz ANT1+ANT2

Data: 104

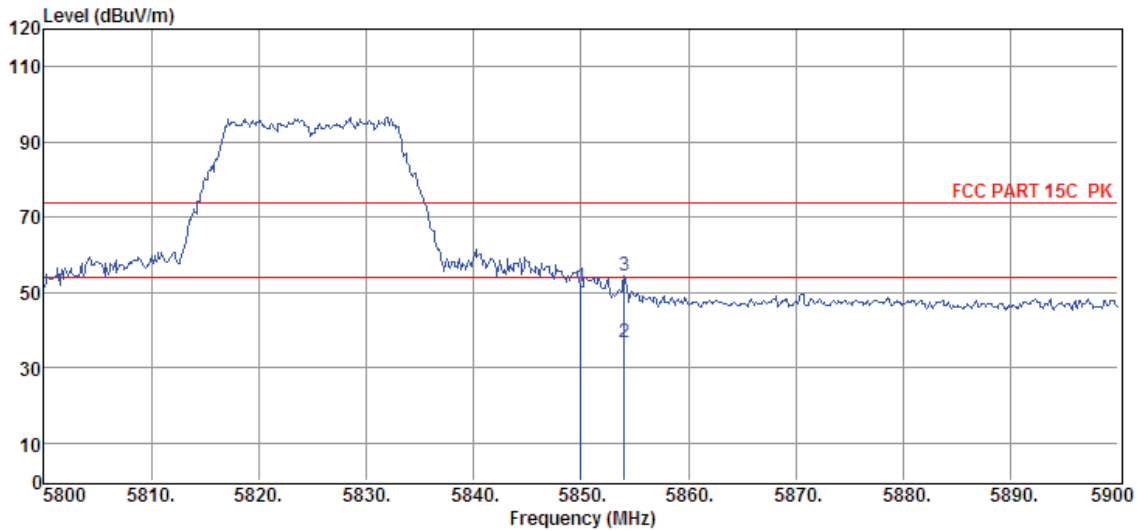

Item (Mark)	Freq. (MHz)	Read Level (dB $\mu$ V)	Antenna Factor (dB/m)	PRM Factor dB	Cable Loss dB	Result Level (dB $\mu$ V/m)	Limit Line (dB $\mu$ V/m)	Over Limit (dB)	Detector	Polarization
1	5850.00	36.25	34.91	29.20	9.54	51.50	74.00	-22.50	Peak	HORIZONTAL
2	5854.00	21.34	34.92	29.20	9.54	36.60	54.00	-17.40	Average	HORIZONTAL
3	5854.00	38.97	34.92	29.20	9.54	54.23	74.00	-19.77	Peak	HORIZONTAL

Note: 1. Result Level = Read Level + Antenna Factor + Cable loss - PRM Factor.

2. If Peak Result complies with AV limit, AV Result is deemed to comply with AV limit.

3. Test setup: RBW: 1 MHz, VBW: 3 MHz, Sweep time: auto.

## TR-4-E-009 Radiated Emission Test Result

**Test Site** : DDT 3m Chamber 1# D:\2017 RE1# Report Data\Q17090505-1E\RF FCC 1-18G 5GWIFI  
边带.EM6  
**Test Date** : 2017-10-16 **Tested By** : Sunny  
**EUT** : Wireless Adaptor and 120W Digital Amplifier **Model Number** : ADAPT+AMP  
**Power Supply** : AC 120V/60Hz **Test Mode** : TX mode  
**Condition** : Temp:24.5'C,Humi:55%,  
Press:100.1kPa **Antenna/Distance** : 2016 HF907/3m/VERTICAL  
**Memo** : 11n 5180MHz ANT1+ANT2

Data: 105

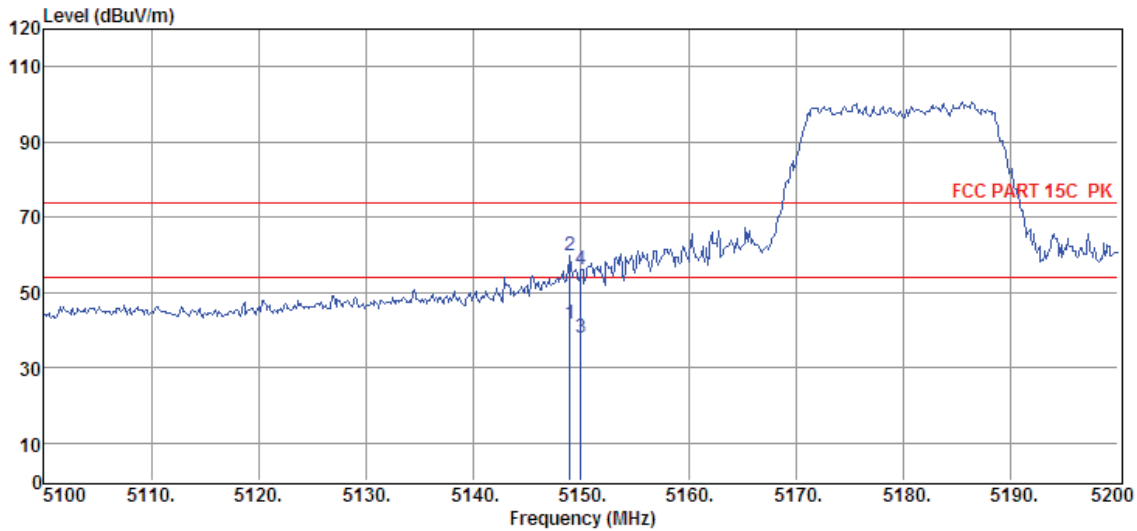

Item (Mark)	Freq. (MHz)	Read Level (dB $\mu$ V)	Antenna Factor (dB/m)	PRM Factor dB	Cable Loss dB	Result Level (dB $\mu$ V/m)	Limit Line (dB $\mu$ V/m)	Over Limit (dB)	Detector	Polarization
1	5149.00	28.22	34.01	29.33	8.84	41.74	54.00	-12.26	Average	VERTICAL
2	5149.00	46.23	34.01	29.33	8.84	59.75	74.00	-14.25	Peak	VERTICAL
3	5150.00	24.30	34.01	29.33	8.84	37.82	54.00	-16.18	Average	VERTICAL
4	5150.00	42.43	34.01	29.33	8.84	55.95	74.00	-18.05	Peak	VERTICAL

Note: 1. Result Level = Read Level + Antenna Factor + Cable loss - PRM Factor.  
 2. If Peak Result complies with AV limit, AV Result is deemed to comply with AV limit.  
 3. Test setup: RBW: 1 MHz, VBW: 3 MHz, Sweep time: auto.

# TR-4-E-009 Radiated Emission Test Result

**Test Site** : DDT 3m Chamber 1# D:\2017 RE1# Report Data\Q17090505-1E\RF FCC 1-18G 5GWIFI 边带.EM6  
**Test Date** : 2017-10-16 **Tested By** : Sunny  
**EUT** : Wireless Adaptor and 120W Digital Amplifier **Model Number** : ADAPT+AMP  
**Power Supply** : AC 120V/60Hz **Test Mode** : TX mode  
**Condition** : Temp:24.5'C,Humi:55%,  
 Press:100.1kPa **Antenna/Distance** : 2016 HF907/3m/HORIZONTAL  
**Memo** : 11n 5180MHz ANT1+ANT2

Data: 106

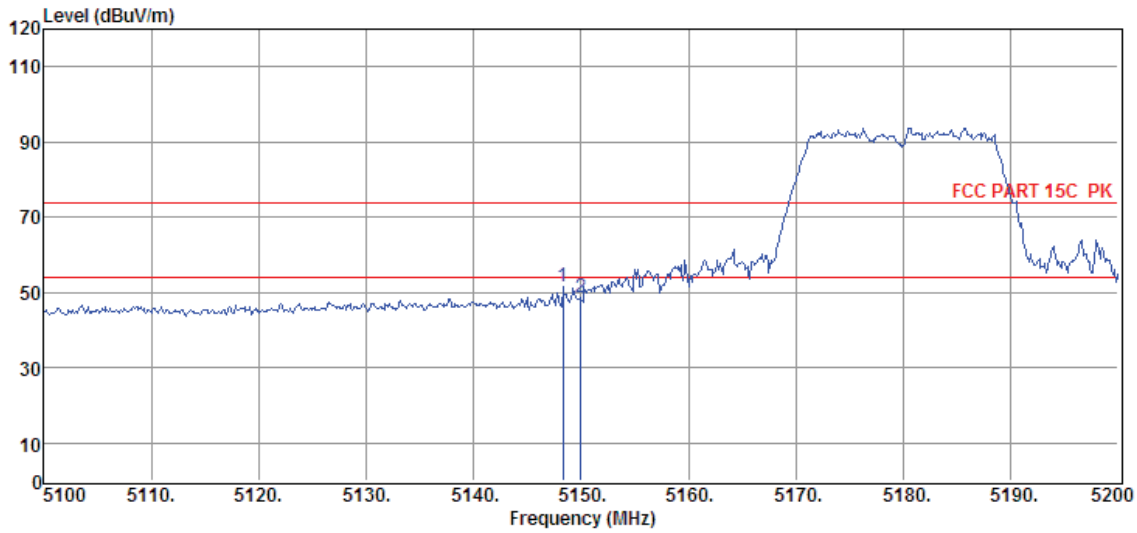

Item (Mark)	Freq. (MHz)	Read Level (dBμV)	Antenna Factor (dB/m)	PRM Factor dB	Cable Loss dB	Result Level (dBμV/m)	Limit Line (dBμV/m)	Over Limit (dB)	Detector	Polarization
1	5148.30	37.90	34.01	29.33	8.84	51.42	74.00	-22.58	Peak	HORIZONTAL
2	5150.00	35.10	34.01	29.33	8.84	48.62	74.00	-25.38	Peak	HORIZONTAL

- Note: 1. Result Level = Read Level + Antenna Factor + Cable loss - PRM Factor.  
 2. If Peak Result complies with AV limit, AV Result is deemed to comply with AV limit.  
 3. Test setup: RBW: 1 MHz, VBW: 3 MHz, Sweep time: auto.

# TR-4-E-009 Radiated Emission Test Result

**Test Site** : DDT 3m Chamber 1# D:\2017 RE1# Report Data\Q17090505-1E\RF FCC 1-18G 5GWIFI 边带.EM6  
**Test Date** : 2017-10-16 **Tested By** : Sunny  
**EUT** : Wireless Adaptor and 120W Digital Amplifier **Model Number** : ADAPT+AMP  
**Power Supply** : AC 120V/60Hz **Test Mode** : TX mode  
**Condition** : Temp:24.5'C,Humi:55%,  
 Press:100.1kPa **Antenna/Distance** : 2016 HF907/3m/HORIZONTAL  
**Memo** : 11n 5240MHz ANT1+ANT2

Data: 107

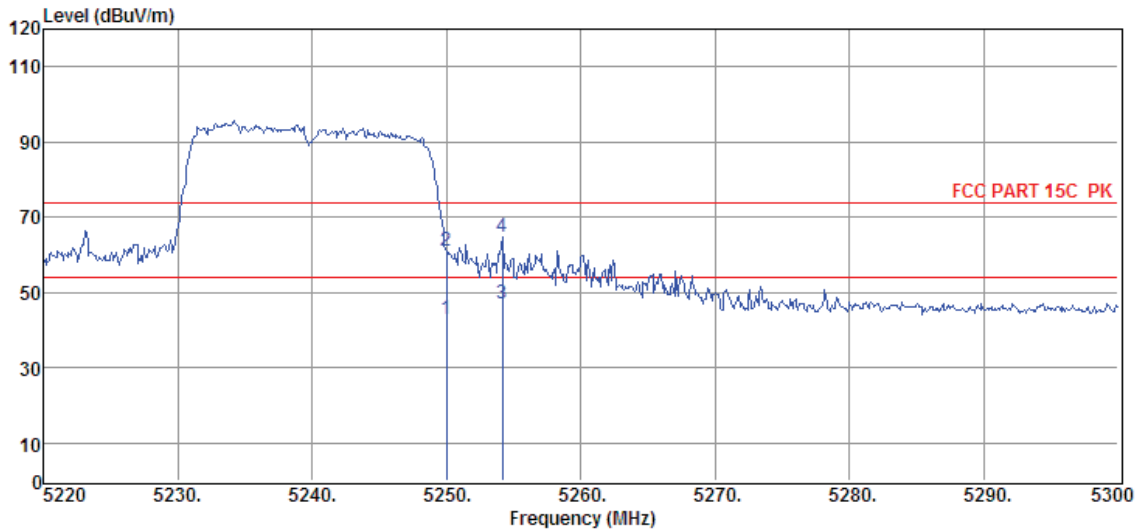

Item (Mark)	Freq. (MHz)	Read Level (dBμV)	Antenna Factor (dB/m)	PRM Factor dB	Cable Loss dB	Result Level (dBμV/m)	Limit Line (dBμV/m)	Over Limit (dB)	Detector	Polarization
1	5250.00	29.24	34.21	29.32	8.93	43.06	54.00	-10.94	Average	HORIZONTAL
2	5250.00	47.20	34.21	29.32	8.93	61.02	74.00	-12.98	Peak	HORIZONTAL
3	5254.16	33.17	34.22	29.32	8.93	47.00	54.00	-7.00	Average	HORIZONTAL
4	5254.16	50.90	34.22	29.32	8.93	64.73	74.00	-9.27	Peak	HORIZONTAL

Note: 1. Result Level = Read Level + Antenna Factor + Cable loss - PRM Factor.  
 2. If Peak Result complies with AV limit, AV Result is deemed to comply with AV limit.  
 3. Test setup: RBW: 1 MHz, VBW: 3 MHz, Sweep time: auto.

## TR-4-E-009 Radiated Emission Test Result

**Test Site** : DDT 3m Chamber 1# D:\2017 RE1# Report Data\Q17090505-1E\RF FCC 1-18G 5GWIFI 边带.EM6  
**Test Date** : 2017-10-16 **Tested By** : Sunny  
**EUT** : Wireless Adaptor and 120W Digital Amplifier **Model Number** : ADAPT+AMP  
**Power Supply** : AC 120V/60Hz **Test Mode** : TX mode  
**Condition** : Temp:24.5'C,Humi:55%,  
 Press:100.1kPa **Antenna/Distance** : 2016 HF907/3m/VERTICAL  
**Memo** : 11n 5240MHz ANT1+ANT2

Data: 108

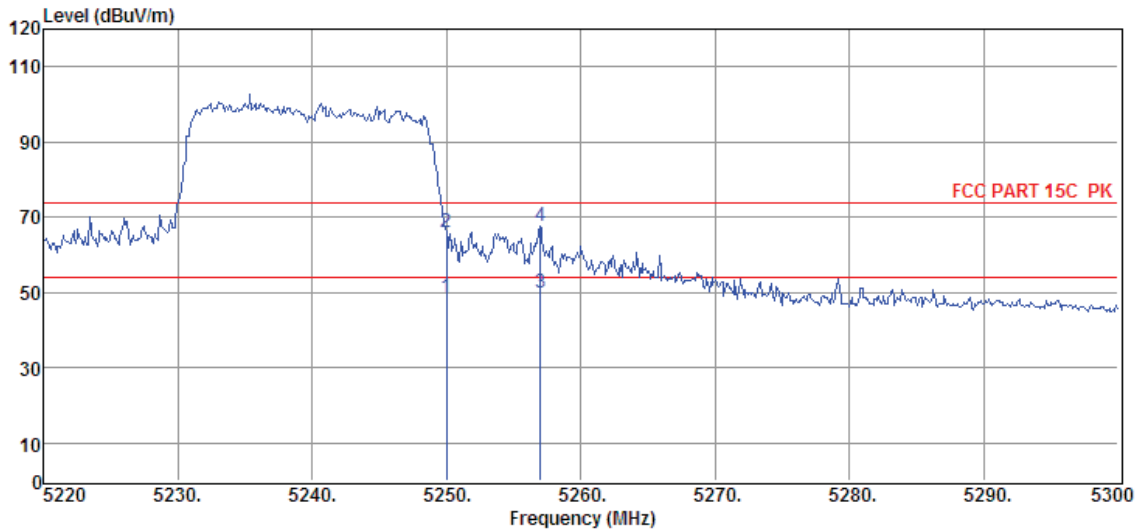

Item (Mark)	Freq. (MHz)	Read Level (dB $\mu$ V)	Antenna Factor (dB/m)	PRM Factor dB	Cable Loss dB	Result Level (dB $\mu$ V/m)	Limit Line (dB $\mu$ V/m)	Over Limit (dB)	Detector	Polarization
1	5250.00	34.91	34.21	29.32	8.93	48.73	54.00	-5.27	Average	VERTICAL
2	5250.00	52.30	34.21	29.32	8.93	66.12	74.00	-7.88	Peak	VERTICAL
3	5256.96	36.10	34.23	29.32	8.93	49.94	54.00	-4.06	Average	VERTICAL
4	5256.96	53.83	34.23	29.32	8.93	67.67	74.00	-6.33	Peak	VERTICAL

- Note: 1. Result Level = Read Level + Antenna Factor + Cable loss - PRM Factor.  
 2. If Peak Result complies with AV limit, AV Result is deemed to comply with AV limit.  
 3. Test setup: RBW: 1 MHz, VBW: 3 MHz, Sweep time: auto.

## TR-4-E-009 Radiated Emission Test Result

**Test Site** : DDT 3m Chamber 1# D:\2017 RE1# Report Data\Q17090505-1E\RF FCC 1-18G 5GWIFI 边带.EM6  
**Test Date** : 2017-10-16 **Tested By** : Sunny  
**EUT** : Wireless Adaptor and 120W Digital Amplifier **Model Number** : ADAPT+AMP  
**Power Supply** : AC 120V/60Hz **Test Mode** : TX mode  
**Condition** : Temp:24.5°C,Humi:55%,  
 Press:100.1kPa **Antenna/Distance** : 2016 HF907/3m/VERTICAL  
**Memo** : 11n 5260MHz ANT1+ANT2

Data: 109

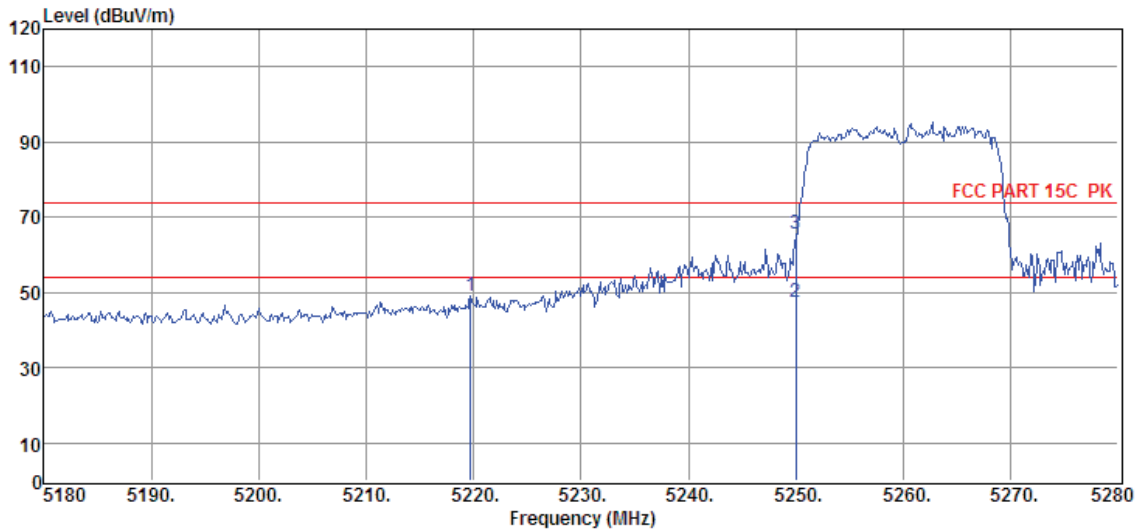

Item (Mark)	Freq. (MHz)	Read Level (dBμV)	Antenna Factor (dB/m)	PRM Factor dB	Cable Loss dB	Result Level (dBμV/m)	Limit Line (dBμV/m)	Over Limit (dB)	Detector	Polarization
1	5219.70	35.29	34.15	29.33	8.91	49.02	74.00	-24.98	Peak	VERTICAL
2	5250.00	33.78	34.21	29.32	8.93	47.60	54.00	-6.40	Average	VERTICAL
3	5250.00	51.73	34.21	29.32	8.93	65.55	74.00	-8.45	Peak	VERTICAL

Note: 1. Result Level = Read Level + Antenna Factor + Cable loss - PRM Factor.

2. If Peak Result complies with AV limit, AV Result is deemed to comply with AV limit.

3. Test setup: RBW: 1 MHz, VBW: 3 MHz, Sweep time: auto.



## TR-4-E-009 Radiated Emission Test Result

**Test Site** : DDT 3m Chamber 1# D:\2017 RE1# Report Data\Q17090505-1E\RF FCC 1-18G 5GWIFI 边带.EM6  
**Test Date** : 2017-10-16 **Tested By** : Sunny  
**EUT** : Wireless Adaptor and 120W Digital Amplifier **Model Number** : ADAPT+AMP  
**Power Supply** : AC 120V/60Hz **Test Mode** : TX mode  
**Condition** : Temp:24.5'C,Humi:55%,  
 Press:100.1kPa **Antenna/Distance** : 2016 HF907/3m/HORIZONTAL  
**Memo** : 11n 5260MHz ANT1+ANT2

Data: 110

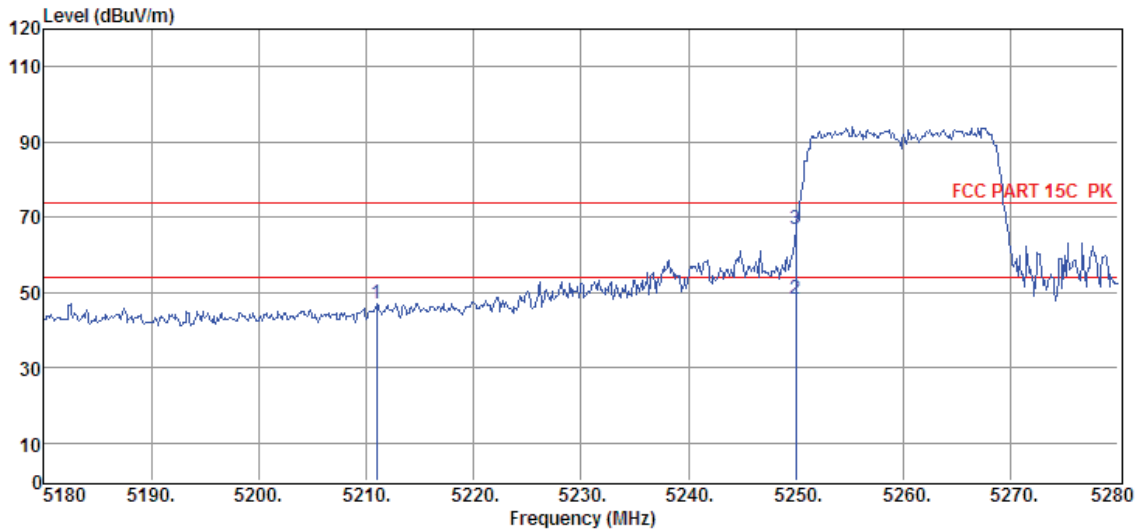

Item (Mark)	Freq. (MHz)	Read Level (dB $\mu$ V)	Antenna Factor (dB/m)	PRM Factor dB	Cable Loss dB	Result Level (dB $\mu$ V/m)	Limit Line (dB $\mu$ V/m)	Over Limit (dB)	Detector	Polarization
1	5211.00	33.50	34.13	29.33	8.89	47.19	74.00	-26.81	Peak	HORIZONTAL
2	5250.00	34.27	34.21	29.32	8.93	48.09	54.00	-5.91	Average	HORIZONTAL
3	5250.00	53.09	34.21	29.32	8.93	66.91	74.00	-7.09	Peak	HORIZONTAL

Note: 1. Result Level = Read Level + Antenna Factor + Cable loss - PRM Factor.

2. If Peak Result complies with AV limit, AV Result is deemed to comply with AV limit.

3. Test setup: RBW: 1 MHz, VBW: 3 MHz, Sweep time: auto.

## TR-4-E-009 Radiated Emission Test Result

**Test Site** : DDT 3m Chamber 1# D:\2017 RE1# Report Data\Q17090505-1E\RF FCC 1-18G 5GWIFI 边带.EM6  
**Test Date** : 2017-10-16 **Tested By** : Sunny  
**EUT** : Wireless Adaptor and 120W Digital Amplifier **Model Number** : ADAPT+AMP  
**Power Supply** : AC 120V/60Hz **Test Mode** : TX mode  
**Condition** : Temp:24.5°C,Humi:55%,  
 Press:100.1kPa **Antenna/Distance** : 2016 HF907/3m/HORIZONTAL  
**Memo** : 11n 5320MHz ANT1+ANT2

Data: 111

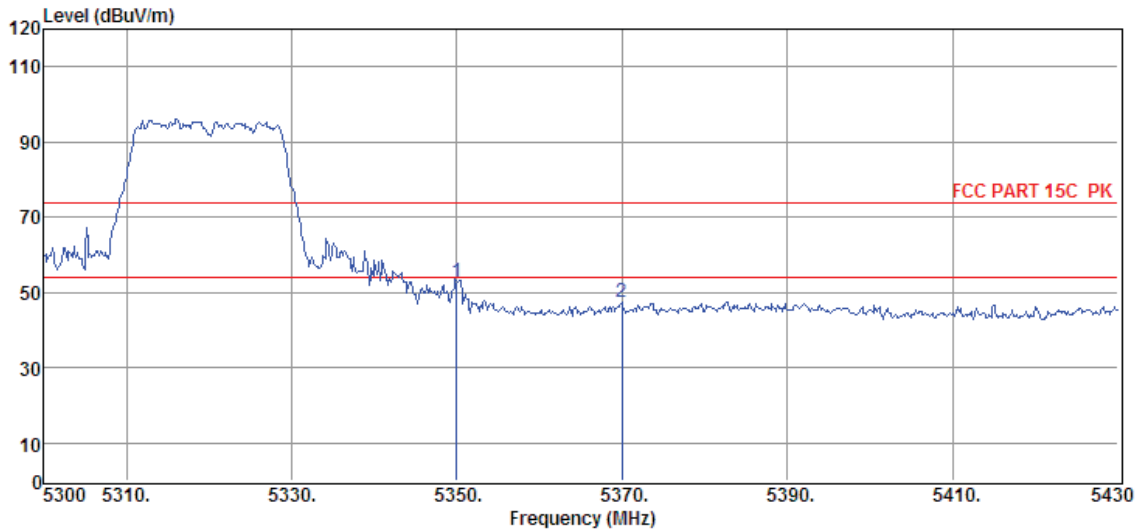

Item (Mark)	Freq. (MHz)	Read Level (dBμV)	Antenna Factor (dB/m)	PRM Factor dB	Cable Loss dB	Result Level (dBμV/m)	Limit Line (dBμV/m)	Over Limit (dB)	Detector	Polarization
1	5350.00	38.62	34.41	29.30	9.03	52.76	74.00	-21.24	Peak	HORIZONTAL
2	5369.94	33.11	34.45	29.30	9.05	47.31	74.00	-26.69	Peak	HORIZONTAL

- Note: 1. Result Level = Read Level + Antenna Factor + Cable loss - PRM Factor.  
 2. If Peak Result complies with AV limit, AV Result is deemed to comply with AV limit.  
 3. Test setup: RBW: 1 MHz, VBW: 3 MHz, Sweep time: auto.

## TR-4-E-009 Radiated Emission Test Result

**Test Site** : DDT 3m Chamber 1# D:\2017 RE1# Report Data\Q17090505-1E\RF FCC 1-18G 5GWIFI 边带.EM6  
**Test Date** : 2017-10-16 **Tested By** : Sunny  
**EUT** : Wireless Adaptor and 120W Digital Amplifier **Model Number** : ADAPT+AMP  
**Power Supply** : AC 120V/60Hz **Test Mode** : TX mode  
**Condition** : Temp:24.5°C,Humi:55%,  
 Press:100.1kPa **Antenna/Distance** : 2016 HF907/3m/VERTICAL  
**Memo** : 11n 5320MHz ANT1+ANT2

Data: 112

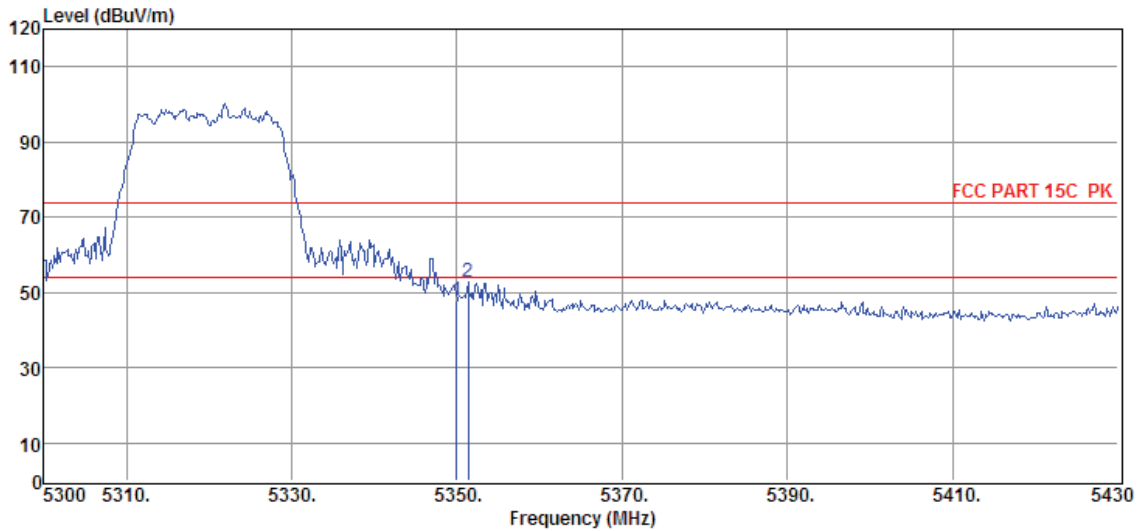

Item (Mark)	Freq. (MHz)	Read Level (dBμV)	Antenna Factor (dB/m)	PRM Factor dB	Cable Loss dB	Result Level (dBμV/m)	Limit Line (dBμV/m)	Over Limit (dB)	Detector	Polarization
1	5350.00	33.75	34.41	29.30	9.03	47.89	74.00	-26.11	Peak	VERTICAL
2	5351.35	38.79	34.41	29.30	9.03	52.93	74.00	-21.07	Peak	VERTICAL

- Note: 1. Result Level = Read Level + Antenna Factor + Cable loss - PRM Factor.  
 2. If Peak Result complies with AV limit, AV Result is deemed to comply with AV limit.  
 3. Test setup: RBW: 1 MHz, VBW: 3 MHz, Sweep time: auto.

# TR-4-E-009 Radiated Emission Test Result

**Test Site** : DDT 3m Chamber 1# D:\2017 RE1# Report Data\Q17090505-1E\RF FCC 1-18G 5GWIFI 边带.EM6  
**Test Date** : 2017-10-16 **Tested By** : Sunny  
**EUT** : Wireless Adaptor and 120W Digital Amplifier **Model Number** : ADAPT+AMP  
**Power Supply** : AC 120V/60Hz **Test Mode** : TX mode  
**Condition** : Temp:24.5'C,Humi:55%,  
 Press:100.1kPa **Antenna/Distance** : 2016 HF907/3m/VERTICAL  
**Memo** : 11n 5500MHz ANT1+ANT2

Data: 113

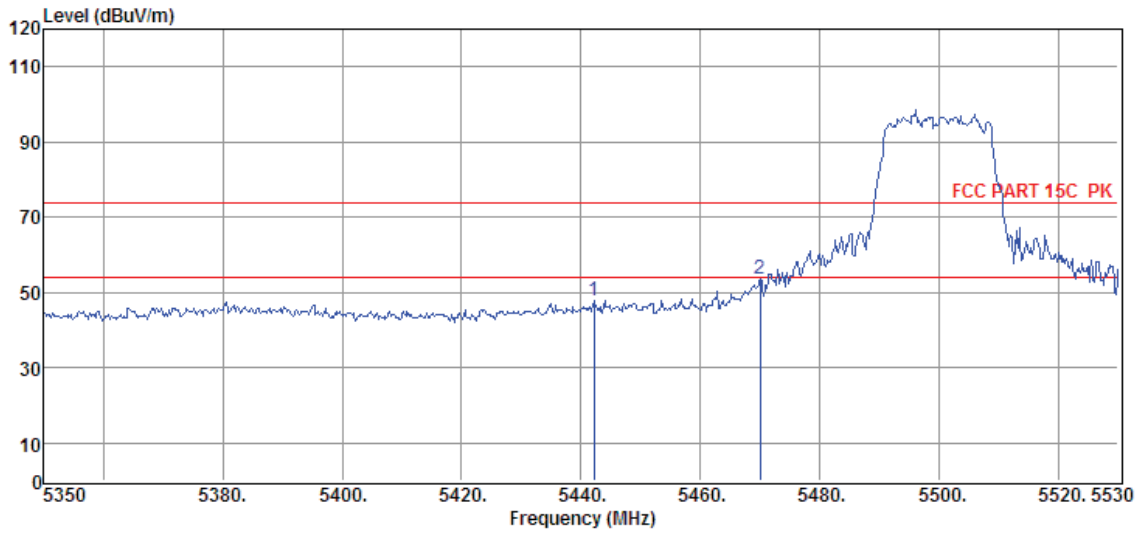

Item (Mark)	Freq. (MHz)	Read Level (dBμV)	Antenna Factor (dB/m)	PRM Factor dB	Cable Loss dB	Result Level (dBμV/m)	Limit Line (dBμV/m)	Over Limit (dB)	Detector	Polarization
1	5442.16	33.54	34.59	29.28	9.14	47.99	74.00	-26.01	Peak	VERTICAL
2	5470.00	39.12	34.64	29.27	9.16	53.65	74.00	-20.35	Peak	VERTICAL

Note: 1. Result Level = Read Level + Antenna Factor + Cable loss - PRM Factor.  
 2. If Peak Result complies with AV limit, AV Result is deemed to comply with AV limit.  
 3. Test setup: RBW: 1 MHz, VBW: 3 MHz, Sweep time: auto.

# TR-4-E-009 Radiated Emission Test Result

**Test Site** : DDT 3m Chamber 1# D:\2017 RE1# Report Data\Q17090505-1E\RF FCC 1-18G 5GWIFI 边带.EM6  
**Test Date** : 2017-10-16 **Tested By** : Sunny  
**EUT** : Wireless Adaptor and 120W Digital Amplifier **Model Number** : ADAPT+AMP  
**Power Supply** : AC 120V/60Hz **Test Mode** : TX mode  
**Condition** : Temp:24.5'C,Humi:55%,  
 Press:100.1kPa **Antenna/Distance** : 2016 HF907/3m/HORIZONTAL  
**Memo** : 11n 5500MHz ANT1+ANT2

Data: 114

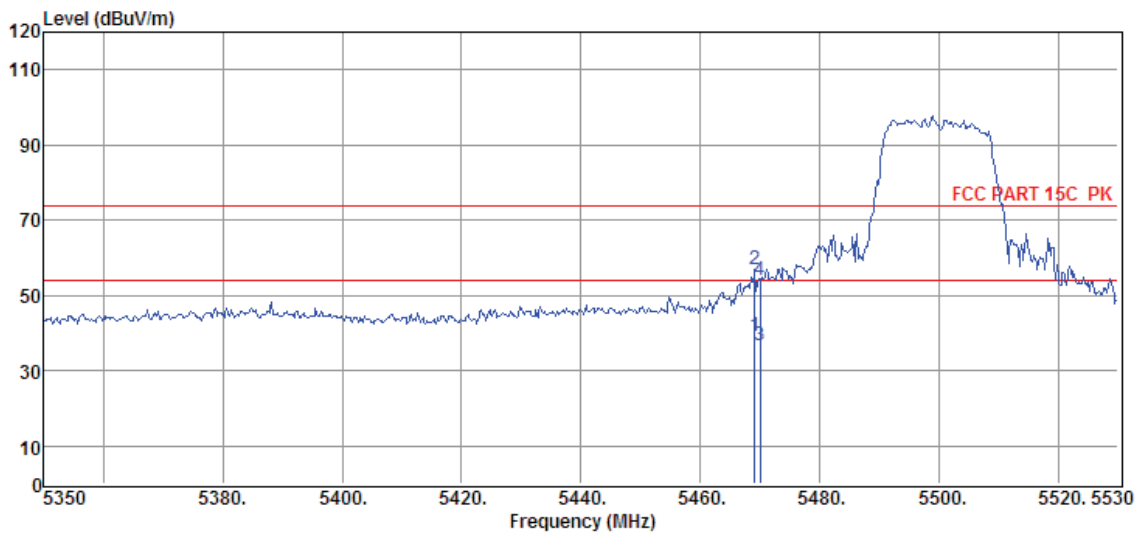

Item (Mark)	Freq. (MHz)	Read Level (dBμV)	Antenna Factor (dB/m)	PRM Factor dB	Cable Loss dB	Result Level (dBμV/m)	Limit Line (dBμV/m)	Over Limit (dB)	Detector	Polarization
1	5469.16	24.47	34.64	29.27	9.16	39.00	54.00	-15.00	Average	HORIZONTAL
2	5469.16	42.19	34.64	29.27	9.16	56.72	74.00	-17.28	Peak	HORIZONTAL
3	5470.00	22.14	34.64	29.27	9.16	36.67	54.00	-17.33	Average	HORIZONTAL
4	5470.00	39.49	34.64	29.27	9.16	54.02	74.00	-19.98	Peak	HORIZONTAL

Note: 1. Result Level = Read Level + Antenna Factor + Cable loss - PRM Factor.  
 2. If Peak Result complies with AV limit, AV Result is deemed to comply with AV limit.  
 3. Test setup: RBW: 1 MHz, VBW: 3 MHz, Sweep time: auto.

# TR-4-E-009 Radiated Emission Test Result

**Test Site** : DDT 3m Chamber 1# D:\2017 RE1# Report Data\Q17090505-1E\RF FCC 1-18G 5GWIFI 边带.EM6  
**Test Date** : 2017-10-16 **Tested By** : Sunny  
**EUT** : Wireless Adaptor and 120W Digital Amplifier **Model Number** : ADAPT+AMP  
**Power Supply** : AC 120V/60Hz **Test Mode** : TX mode  
**Condition** : Temp:24.5'C,Humi:55%,  
 Press:100.1kPa **Antenna/Distance** : 2016 HF907/3m/HORIZONTAL  
**Memo** : 11n 5700MHz ANT1+ANT2

Data: 115

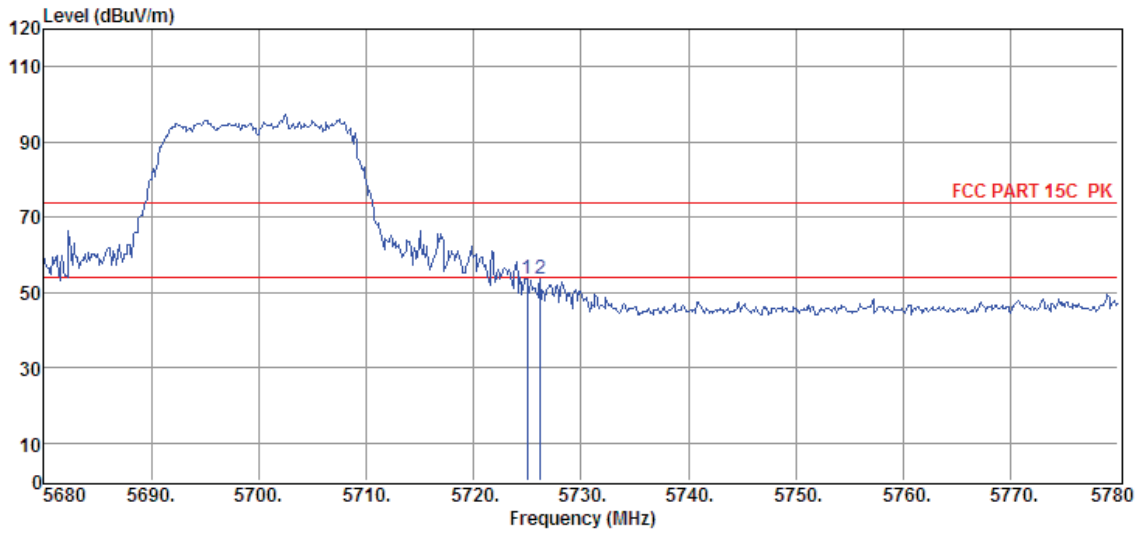

Item (Mark)	Freq. (MHz)	Read Level (dBμV)	Antenna Factor (dB/m)	PRM Factor (dB)	Cable Loss (dB)	Result Level (dBμV/m)	Limit Line (dBμV/m)	Over Limit (dB)	Detector	Polarization
1	5725.00	38.43	34.84	29.22	9.41	53.46	74.00	-20.54	Peak	HORIZONTAL
2	5726.20	38.69	34.84	29.22	9.41	53.72	74.00	-20.28	Peak	HORIZONTAL

Note: 1. Result Level = Read Level + Antenna Factor + Cable loss - PRM Factor.  
 2. If Peak Result complies with AV limit, AV Result is deemed to comply with AV limit.  
 3. Test setup: RBW: 1 MHz, VBW: 3 MHz, Sweep time: auto.

# TR-4-E-009 Radiated Emission Test Result

**Test Site** : DDT 3m Chamber 1# D:\2017 RE1# Report Data\Q17090505-1E\RF FCC 1-18G 5GWIFI 边带.EM6  
**Test Date** : 2017-10-16 **Tested By** : Sunny  
**EUT** : Wireless Adaptor and 120W Digital Amplifier **Model Number** : ADAPT+AMP  
**Power Supply** : AC 120V/60Hz **Test Mode** : TX mode  
**Condition** : Temp:24.5°C,Humi:55%,  
 Press:100.1kPa **Antenna/Distance** : 2016 HF907/3m/VERTICAL  
**Memo** : 11n 5700MHz ANT1+ANT2

Data: 116

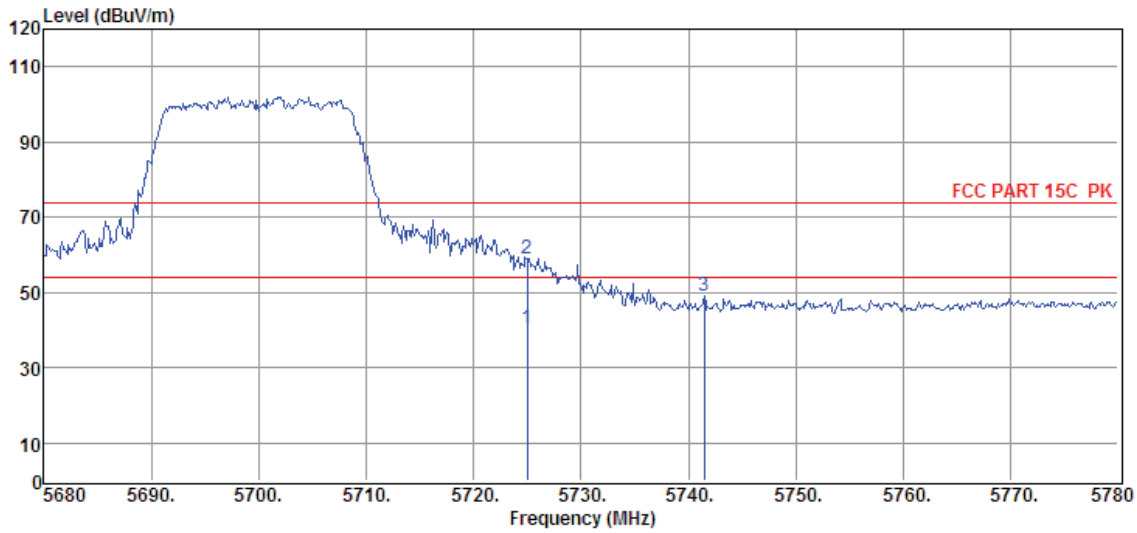

Item (Mark)	Freq. (MHz)	Read Level (dBμV)	Antenna Factor (dB/m)	PRM Factor dB	Cable Loss dB	Result Level (dBμV/m)	Limit Line (dBμV/m)	Over Limit (dB)	Detector	Polarization
1	5725.00	25.35	34.84	29.22	9.41	40.38	54.00	-13.62	Average	VERTICAL
2	5725.00	43.80	34.84	29.22	9.41	58.83	74.00	-15.17	Peak	VERTICAL
3	5741.50	33.93	34.85	29.21	9.43	49.00	74.00	-25.00	Peak	VERTICAL

- Note: 1. Result Level = Read Level + Antenna Factor + Cable loss - PRM Factor.  
 2. If Peak Result complies with AV limit, AV Result is deemed to comply with AV limit.  
 3. Test setup: RBW: 1 MHz, VBW: 3 MHz, Sweep time: auto.