

FCC AND IC CERTIFICATION TEST REPORT

FOR

Applicant	:	Harman International Industries, Incorporated
Address	:	8500 Balboa Boulevard, Northridge, CA 91329, UNITED STATES
Equipment under Test	:	Wireless Adaptor and 120W Digital Amplifier
Model No.	:	ADAPT+AMP
Trade Mark	:	Harman Kardon
FCC ID	:	APIHKADAPTAMP
IC	:	6132A-HKADAPTAMP
Manufacturer	:	Harman International Industries, Incorporated
Address	:	8500 Balboa Boulevard, Northridge, CA 91329, UNITED STATES

Issued By: Dongguan Dongdian Testing Service Co., Ltd.

Add: No. 17, Zongbu Road 2, Songshan Lake Sci&Tech, Industry Park, Dongguan City,
Guangdong Province, China, 523808

Tel: +86-0769-89201699 **E-mail:** ddt@dgddt.com <http://www.dgddt.com>

REPORT

TABLE OF CONTENTS

	Test report declares.....	4
1.	Summary of test results.....	5
2.	General test information	6
2.1.	Description of EUT	6
2.2.	Accessories of EUT	6
2.3.	Assistant equipment used for test	6
2.4.	Block diagram of EUT configuration for test.....	7
2.5.	Deviations of test standard.....	7
2.6.	Test environment conditions.....	7
2.7.	Test laboratory	7
2.8.	Measurement uncertainty.....	8
3.	Equipment used during test	9
4.	6dB Bandwidth and 99% Bandwidth	10
4.1.	Block diagram of test setup	10
4.2.	Limits	10
4.3.	Test Procedure	10
4.4.	Test Result	10
4.5.	original test data.....	13
5.	Conducted peak Output Power	37
5.1.	Block diagram of test setup	37
5.2.	Limits	37
5.3.	Test Procedure	37
5.4.	Test Result	37
6.	Power Spectral Density.....	39
6.1.	Block diagram of test setup	39
6.2.	Limits	39
6.3.	Test Procedure	39
6.4.	Test Result	39
6.5.	original test data.....	41
6.6.	Band Edge and Spurious Emissions (Conducted)	53
6.7.	Block diagram of test setup	53
6.8.	Limits	53
6.9.	Test Procedure	53
6.10.	Test Result	54
6.11.	original test data.....	55
7.	Radiated Spurious Emissions	88

7.1.	Block diagram of test setup	88
7.2.	Limit	89
7.3.	Test Procedure	90
7.4.	Test result	91
8.	Radiated Band Edge Compliance	95
8.1.	Block diagram of test setup	95
8.2.	Limit	95
8.3.	Test Procedure	95
8.4.	Test result	95
9.	Power Line Conducted Emission.....	112
9.1.	Block diagram of test setup	112
9.2.	Power Line Conducted Emission Limits(Class B)	112
9.3.	Test Procedure	112
9.4.	Test Result	113
10.	Antenna Requirements.....	116
10.1.	Limit	116
10.2.	Result.....	116

TEST REPORT DECLARE

Applicant	:	Harman International Industries, Incorporated
Address	:	8500 Balboa Boulevard, Northridge, CA 91329, UNITED STATES
Equipment under Test	:	Wireless Adaptor and 120W Digital Amplifier
Model No	:	ADAPT+AMP
Trade Mark	:	Harman Kardon
Manufacturer	:	Harman International Industries, Incorporated
Address	:	8500 Balboa Boulevard, Northridge, CA 91329, UNITED STATES

Test Standard Used: FCC Rules and Regulations Part 15 Subpart C, RSS-247 Issue 2 February 2017.

Test procedure used: ANSI C63.10:2013, RSS-Gen Issue 4, Nov. 2014, KDB558074 D01 DTS Meas Guidance V03r02

We Declare:

The equipment described above is tested by Dongguan Dongdian Testing Service Co., Ltd and in the configuration tested the equipment complied with the standards specified above. The test results are contained in this test report and Dongguan Dongdian Testing Service Co., Ltd is assumed of full responsibility for the accuracy and completeness of these tests.

After test and evaluation, our opinion is that the equipment provided for test compliance with the requirement of the above FCC&IC standards.

Report No:	DDT-RQ17090505-1E4		
Date of Receipt:	Sep. 05, 2017	Date of Test:	Sep. 05, 2017 ~ Oct. 15, 2017

Prepared By:



Toby Ren/Engineer

Approved By

Kevin Feng/EMC Manager

Note: This report applies to above tested sample only. This report shall not be reproduced in parts without written approval of Dongguan Dongdian Testing Service Co., Ltd.

1. Summary of test results

The EUT have been tested according to the applicable standards as referenced below.		
Description of Test Item	Standard	Results
6dB Bandwidth and 99% Bandwidth	FCC 15.247 (a) (2) RSS-247 Clause 5.2 (a)	PASS
Conducted Output Power	FCC 15.247 (b) (3) RSS-247 Clause 5.4 (e)	PASS
Power Spectral Density	FCC 15.247 (e) RSS-247 Clause 5.2 (b)	PASS
Band-edge and Spurious Emissions (Conducted)	FCC 15.247 (d) RSS-247 Clause 5.5	PASS
Radiated Spurious Emissions	FCC 15.247 (d) FCC 15.209 FCC 15.205 RSS-247 Clause 5.5 RSS-GEN Clause 8.9	PASS
Radiated Band Edge Compliance	FCC 15.247 (d) FCC 15.209 FCC 15.205 RSS-247 Clause 5.5 RSS-GEN Clause 8.9	PASS
Power Line Conducted Emission	FCC 15.207 RSS-GEN Clause 8.8	PASS
Antenna requirement	FCC 15.203 RSS-GEN Clause 8.3	PASS

2. General test information

2.1. Description of EUT

EUT* Name	: Wireless Adaptor and 120W Digital Amplifier
Model Number	: ADAPT+AMP
EUT function description	: Please reference user manual of this device
Power supply	: AC 100-240V,50/60Hz, 120W
Radio Technology	: IEEE802.11b/g/n
FCC Operation frequency	: IEEE 802.11b: 2412MHz—2462MHz IEEE 802.11g: 2412MHz—2462MHz IEEE 802.11n HT20: 2412MHz—2462MHz IEEE 802.11n HT40:2422MHz—2452MHz
Modulation	: IEEE 802.11b: DSSS(CCK,DQPSK,DBPSK) IEEE 802.11g: OFDM(64QAM, 16QAM, QPSK, BPSK) IEEE 802.11n HT20, HT40: OFDM (64QAM, 16QAM, QPSK,BPSK)
Transmitter rate	: IEEE 802.11b: 1, 2, 5.5, 11 Mbps IEEE 802.11g: 6, 9, 12, 18, 24, 36, 48, 54 Mbps IEEE 802.11n HT20: up to 150 Mbps, HT40: up to 300Mbps
Antenna Type	: Integrated antenna 1: 2.4G band maximum PK gain 2.60dBi Integrated antenna 2: 2.4G band maximum PK gain 4.20dBi
Sample Type	: Series production

Note: EUT is the ab.of equipment under test.

Channle information							
CH	Frequency	CH	Frequency	CH	Frequency	CH	Frequency
1	2412	5	2432	9	2452	/	/
2	2417	6	2437	10	2457	/	/
3	2422	7	2442	11	2462	/	/
4	2427	8	2447	/	/	/	/

2.2. Accessories of EUT

Description of Accessories	Manufacturer	Model number	Serial No.	Other
Optical cable	Harman	N/A	N/A	Length: 1.5m
Audio cable	Harman	N/A	N/A	Length: 0.8m
AC cable	Harman	N/A	N/A	Length: 1.5m

2.3. Assistant equipment used for test

Description of Assistant equipment	Manufacturer	Model number or Type	EMC Compliance	SN:
Notebook	DELL	Latitude D610	FCC DOC	00045-534-136-300
Network Cable	N/A	N/A	N/A	Length: 1.5m

2.4. Block diagram of EUT configuration for test

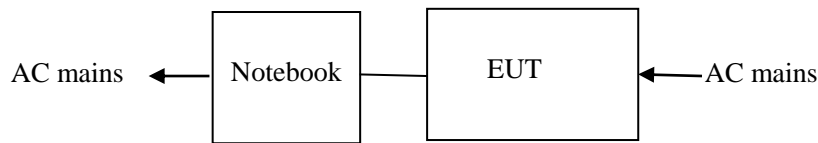

EUT was connected to control to provided by manufacturer which has a standard LAN PORT connector to connect to Notebook, and the Notebook will run a special test software “The super terminal” provided by manufacturer to control EUT work in Continuous TX mode (>98% duty cycle), and select test channel, wireless mode and data rate.

Tested mode, channel, and data rate information				
Mode	Setting Tx Power	data rate (Mbps) (see Note)	Channel	Frequency (MHz)
IEEE 802.11b	56	11	LCH :CH1	2412
	56	11	MCH: CH6	2437
	56	11	HCH: CH11	2462
IEEE 802.11g	56	54	LCH :CH1	2412
	56	54	MCH: CH6	2437
	56	54	HCH: CH11	2462
IEEE 802.11n HT20	56	MCS 7	LCH :CH1	2412
	56	MCS 7	MCH: CH6	2437
	56	MCS 7	HCH: CH11	2462
IEEE 802.11n HT40	56	MCS 7	LCH :CH3	2422
	56	MCS 7	MCH: CH6	2437
	54	MCS 7	HCH: CH9	2452

Note: According exploratory test, EUT will have maximum output power in those data rate, so those data rate were used for all test.

2.5. Deviations of test standard

No Deviation

2.6. Test environment conditions

During the measurement the environmental conditions were within the listed ranges:

Temperature range:	21-25℃
Humidity range:	40-75%
Pressure range:	86-106kPa

2.7. Test laboratory

Dongguan Dongdian Testing Service Co., Ltd

Add: No. 17, Zongbu Road 2, Songshan Lake Sci&Tech, Industry Park, Dongguan City, Guangdong Province, China, 523808 Tel: +86-0769-89201699 <http://www.dgddt.com>

CNAS Accreditation No. L6451; A2LA Accreditation No. 3870.01

Designation Number: CN1182; Test Firm Registration Number: 540522

Industry Canada site registration number: 10288A-1

2.8. Measurement uncertainty

Test Item	Uncertainty
Bandwidth	1.1%
Peak Output Power(Conducted)(Spectrum analyzer)	0.86dB(10 MHz \leq f < 3.6GHz);
	1.38dB(3.6GHz \leq f < 8GHz)
Peak Output Power(Conducted)(Power Sensor)	0.74dB
Power Spectral Density	0.74dB(10 MHz \leq f < 3.6GHz);
	1.38dB(3.6GHz \leq f < 8GHz)
Frequencies Stability	6.7 x 10 ⁻⁸ (Antenna couple method)
	5.5 x 10 ⁻⁸ (Conducted method)
Conducted spurious emissions	0.86dB(10 MHz \leq f < 3.6GHz);
	1.40dB(3.6GHz \leq f < 8GHz)
	1.66dB(8GHz \leq f < 26GHz)
Uncertainty for radio frequency (RBW<20KHz)	3×10 ⁻⁸
Temperature	0.4°C
Humidity	2%
Uncertainty for Radiation Emission test (30MHz-1GHz)	4.70 dB (Antenna Polarize: V)
	4.84 dB (Antenna Polarize: H)
Uncertainty for Radiation Emission test (1GHz-26GHz)	4.10dB(1-6GHz)
	4.40dB (6GHz-18Gz)
	3.54dB (18GHz-26Gz)
Uncertainty for Power line conduction emission test	3.32dB (150KHz-30MHz)
Note: This uncertainty represents an expanded uncertainty expressed at approximately the 95% confidence level using a coverage factor of k=2.	

3. Equipment used during test

Equipment	Manufacturer	Model No.	Serial No.	Last Cal.	Cal. Interval
RF Connected Test (Tonscent RF Measurement System)					
Spectrum analyzer	R&S	FSU26	1166.1660.26	Oct. 23, 2017	1 Year
Wideband Radio Communication tester	R&S	CMW500	155523	Oct. 21, 2017	1 Year
Vector Signal Generator	Agilent	E8267D	MY52098743	Oct. 23, 2017	1 Year
Vector Signal Generator	Agilent	N5182A	MY48180737	Oct. 21, 2017	1 Year
Power Sensor	Agilent	U2021XA	MY55150010	Oct. 21, 2017	1 Year
Power Sensor	Agilent	U2021XA	MY55150011	Oct. 21, 2017	1 Year
DC Power Source	MATRIS	MPS-3005L-3	D813058W	Oct. 21, 2017	1 Year
Attenuator	Mini-Circuits	BW-S10W2	101109	Oct. 21, 2017	1 Year
RF Cable	Micable	C10-01-01-1	100309	Oct. 21, 2017	1 Year
Temp&Humi Programmable	ZHIXIANG	ZXGDJS-150L	ZX170110-A	Oct. 21, 2017	1Year
Test Software	JS Tonscend	JS1120-2	Ver.2.5	N/A	N/A
USB Data acquisition	Agilent	U2531A	TW55043503	N/A	N/A
Auto control Unit	JS Tonscend	JS0806-2	158060010	N/A	N/A
Radiated Emission Test					
EMI Test Receiver	R&S	ESU8	100316	Oct. 21, 2017	1 Year
Spectrum analyzer	R&S	FSU26	1166.1660.26	Oct. 21, 2017	1 Year
Trilog Broadband Antenna	Schwarzbeck	VULB9163	9163-462	Oct. 21, 2017	1 Year
Active Loop antenna	Schwarzbeck	FMZB-1519	1519-038	Oct. 21, 2017	1 Year
Broadband Horn antenna	Schwarzbeck	BBHA 9170	BBHA 9170 #790	Aug. 11, 2017	1 Year
Double Ridged Horn Antenna	R&S	HF907	100276	Oct. 21, 2017	1 Year
Pre-amplifier	A.H.	PAM-0118	360	Oct. 21, 2017	1 Year
RF Cable	HUBSER	CP-X2	W11.03	Oct. 21, 2017	1 Year
RF Cable	HUBSER	CP-X1	W12.02	Oct. 21, 2017	1 Year
MI Cable	HUBSER	C10-01-01-1M	1091629	Oct. 21, 2017	1 Year
Test software	Audix	E3	V 6.11111b	N/A	N/A
Power Line Conducted Emissions Test					
Test Receiver	R&S	ESU8	100316	Oct. 21, 2017	1 Year
LISN 1	R&S	ENV216	101109	Oct. 21, 2017	1 Year
LISN 2	R&S	ESH2-Z5	100309	Oct. 21, 2017	1 Year
Pulse Limiter	R&S	ESH3-Z2	101242	Oct. 21, 2017	1 Year
CE Cable 1	HUBSER	ESU8/RF2	W10.01	Oct. 21, 2017	1 Year
Test software	Audix	E3	V 6.11111b	N/A	N/A

4. 6dB Bandwidth and 99% Bandwidth

4.1. Block diagram of test setup

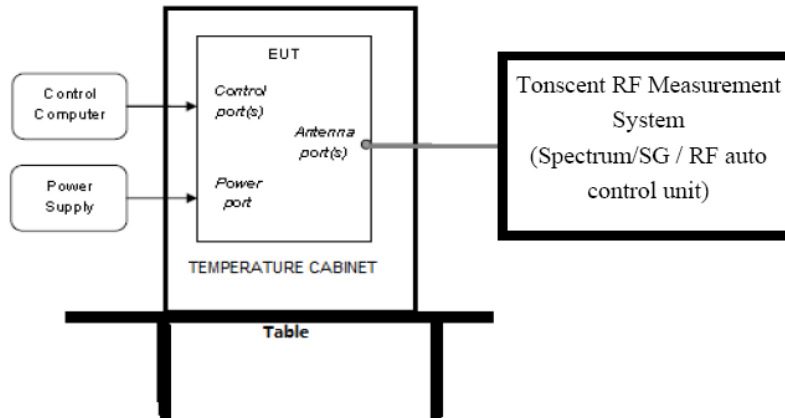

4.2. Limits

For direct sequence systems, the minimum 6dB bandwidth shall be at least 500 KHz

4.3. Test Procedure

- (1) Connect EUT's antenna output to spectrum analyzer by RF cable.
- (2) Set the spectrum analyzer as follows:

RBW:	100KHz
VBW:	300KHz
Detector Mode:	Peak
Sweep time:	auto
Trace mode	Max hold
- (3) Allow the trace to stabilize, measure the maximum width of the emission that is constrained by the frequencies associated with the two outermost amplitude points (upper and lower frequencies) that are attenuated by 6 dB relative to the maximum level measured in the fundamental emission.

4.4. Test Result

6dB Bandwidth:

Test Mode	Test Channel	Ant	EBW[MHz]	Limit	Verdict
11BMIMO	2412	Ant1	8.600	0.5	PASS
11BMIMO	2412	Ant2	8.120	0.5	PASS
11BMIMO	2437	Ant1	8.280	0.5	PASS
11BMIMO	2437	Ant2	9.360	0.5	PASS
11BMIMO	2462	Ant1	9.480	0.5	PASS
11BMIMO	2462	Ant2	7.840	0.5	PASS

11GMIMO	2412	Ant1	16.200	0.5	PASS
11GMIMO	2412	Ant2	16.440	0.5	PASS
11GMIMO	2437	Ant1	16.120	0.5	PASS
11GMIMO	2437	Ant2	16.520	0.5	PASS
11GMIMO	2462	Ant1	16.120	0.5	PASS
11GMIMO	2462	Ant2	16.200	0.5	PASS
11N20MIMO	2412	Ant1	17.680	0.5	PASS
11N20MIMO	2412	Ant2	17.600	0.5	PASS
11N20MIMO	2437	Ant1	17.760	0.5	PASS
11N20MIMO	2437	Ant2	17.760	0.5	PASS
11N20MIMO	2462	Ant1	17.480	0.5	PASS
11N20MIMO	2462	Ant2	17.400	0.5	PASS
11N40MIMO	2422	Ant1	36.560	0.5	PASS
11N40MIMO	2422	Ant2	36.560	0.5	PASS
11N40MIMO	2437	Ant1	36.480	0.5	PASS
11N40MIMO	2437	Ant2	36.560	0.5	PASS
11N40MIMO	2452	Ant1	35.840	0.5	PASS
11N40MIMO	2452	Ant2	35.920	0.5	PASS

99% bandwidth:

Test Mode	Test Channel	Ant	OBW[MHz]	Limit[MHz]	Verdict
11BMIMO	2412	Ant1	11.520	---	PASS
11BMIMO	2412	Ant2	11.440	---	PASS
11BMIMO	2437	Ant1	11.640	---	PASS
11BMIMO	2437	Ant2	11.600	---	PASS
11BMIMO	2462	Ant1	11.640	---	PASS
11BMIMO	2462	Ant2	11.520	---	PASS
11GMIMO	2412	Ant1	16.440	---	PASS
11GMIMO	2412	Ant2	16.440	---	PASS
11GMIMO	2437	Ant1	16.480	---	PASS
11GMIMO	2437	Ant2	16.520	---	PASS
11GMIMO	2462	Ant1	16.520	---	PASS
11GMIMO	2462	Ant2	16.480	---	PASS
11N20MIMO	2412	Ant1	17.680	---	PASS
11N20MIMO	2412	Ant2	17.680	---	PASS
11N20MIMO	2437	Ant1	17.760	---	PASS
11N20MIMO	2437	Ant2	17.720	---	PASS
11N20MIMO	2462	Ant1	17.760	---	PASS
11N20MIMO	2462	Ant2	17.680	---	PASS
11N40MIMO	2422	Ant1	36.320	---	PASS

11N40MIMO	2422	Ant2	36.240	---	PASS
11N40MIMO	2437	Ant1	36.240	---	PASS
11N40MIMO	2437	Ant2	36.240	---	PASS
11N40MIMO	2452	Ant1	36.080	---	PASS
11N40MIMO	2452	Ant2	36.080	---	PASS

4.5. original test data

6dB Bandwidth:

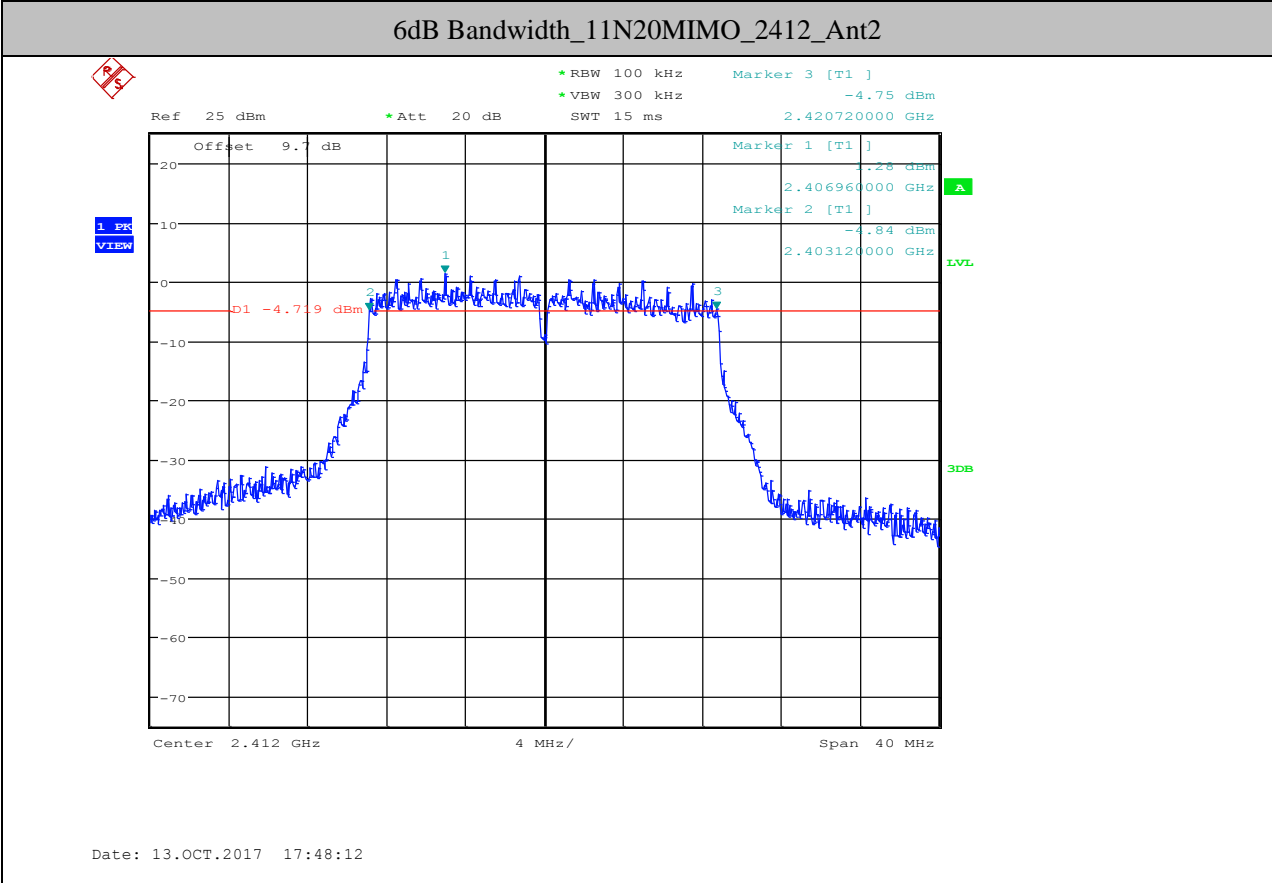
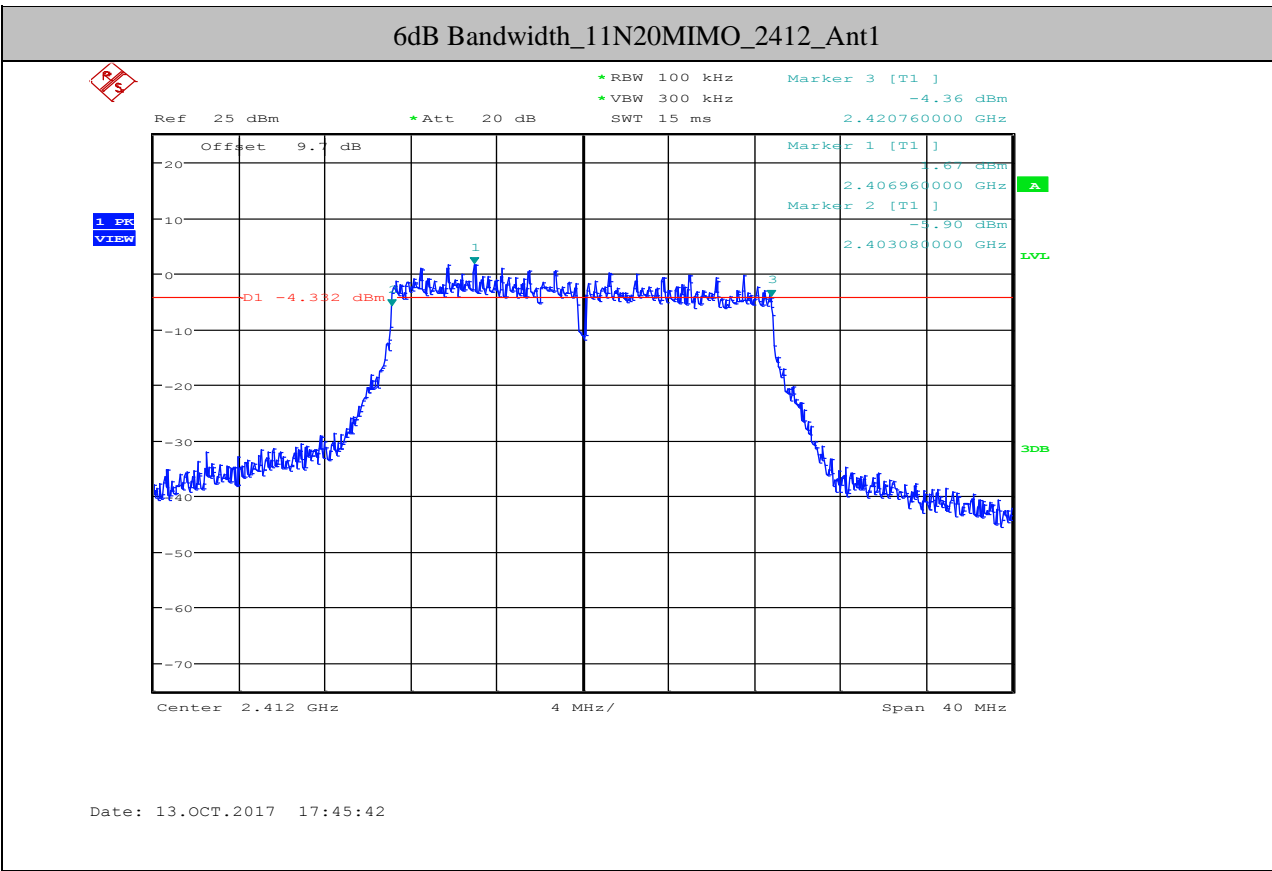

6dB Bandwidth_11N20MIMO_2437_Ant1

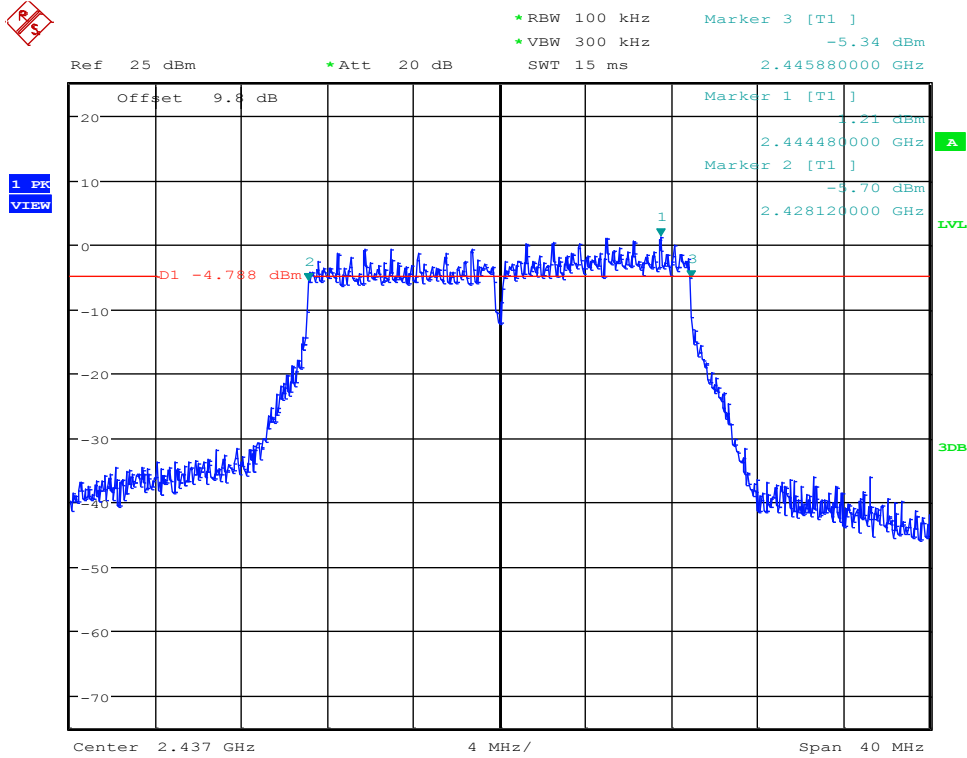

Date: 13.OCT.2017 18:32:35

6dB Bandwidth_11N20MIMO_2437_Ant2

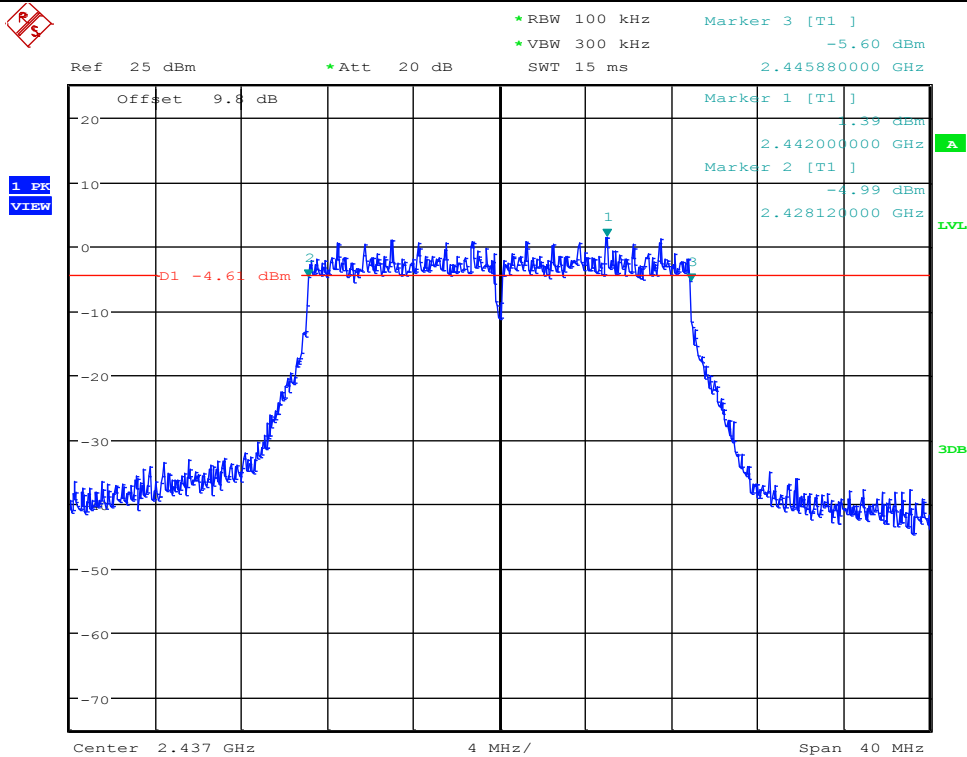

Date: 13.OCT.2017 18:34:07

6dB Bandwidth_11N20MIMO_2462_Ant1



1 PK
VIEW

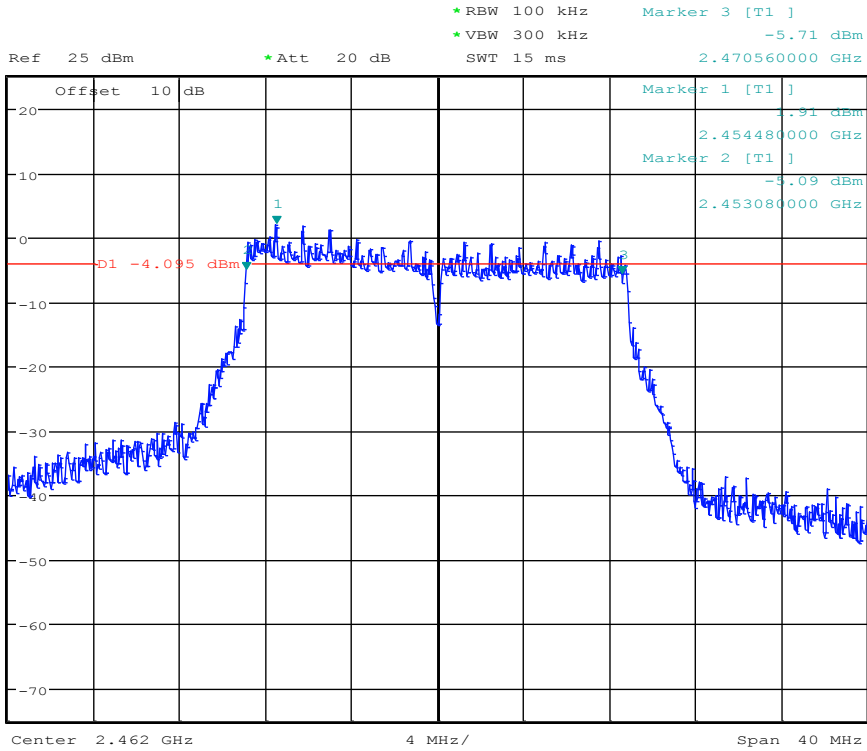

Date: 13.OCT.2017 18:36:26

6dB Bandwidth_11N20MIMO_2462_Ant2



1 PK
VIEW

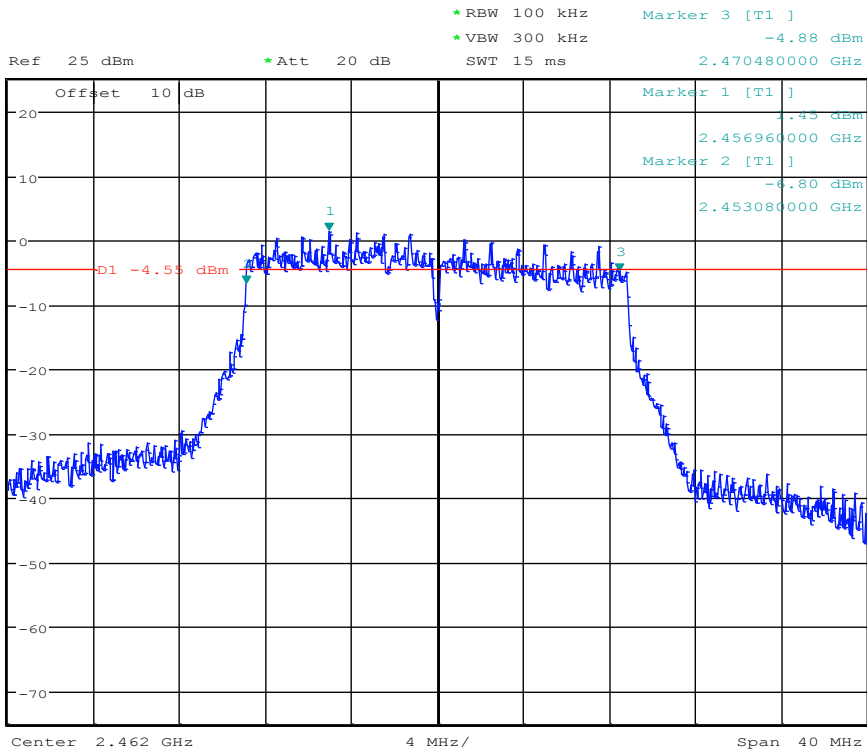

Date: 13.OCT.2017 18:38:56

6dB Bandwidth_11N40MIMO_2422_Ant1

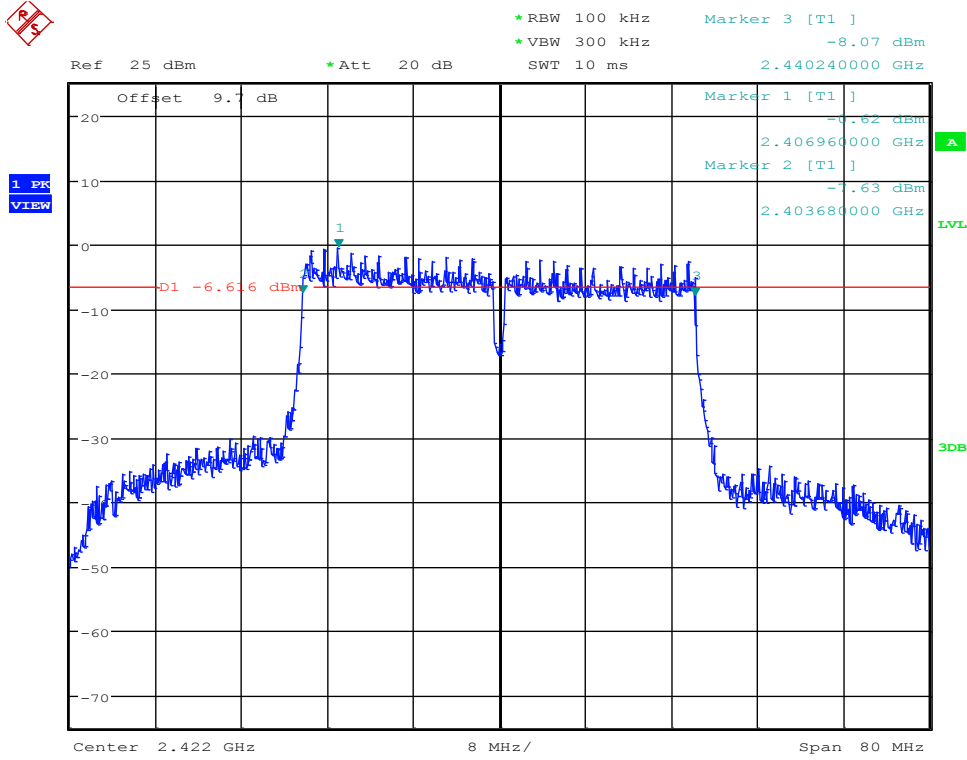

Date: 13.OCT.2017 18:42:30

6dB Bandwidth_11N40MIMO_2422_Ant2

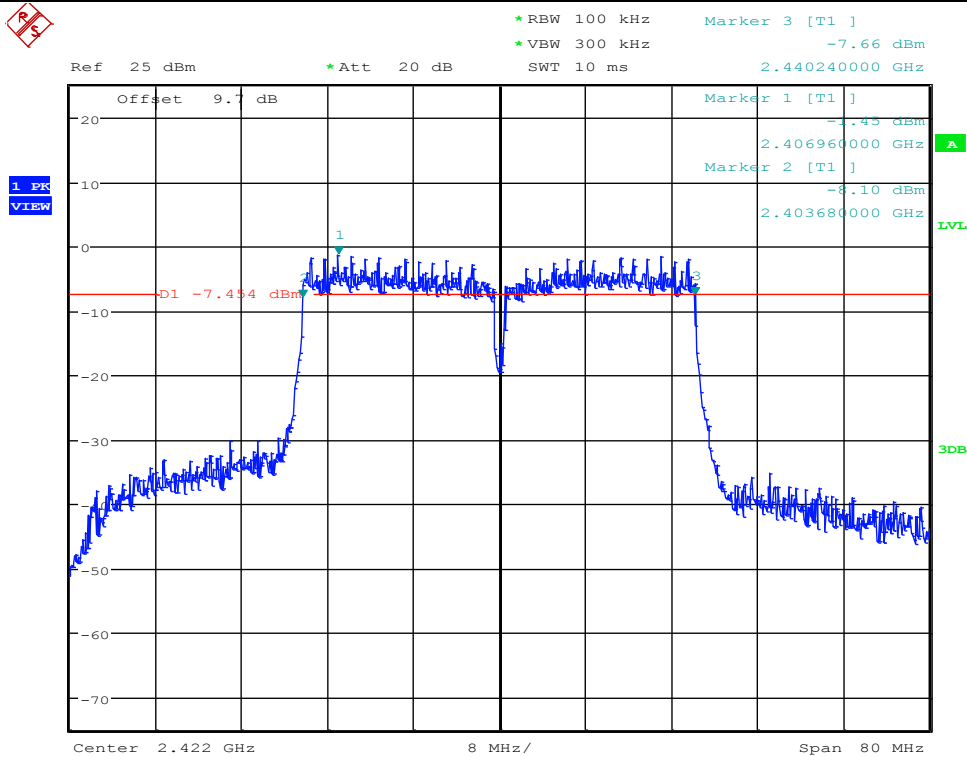

Date: 13.OCT.2017 18:45:00

6dB Bandwidth_11N40MIMO_2437_Ant1

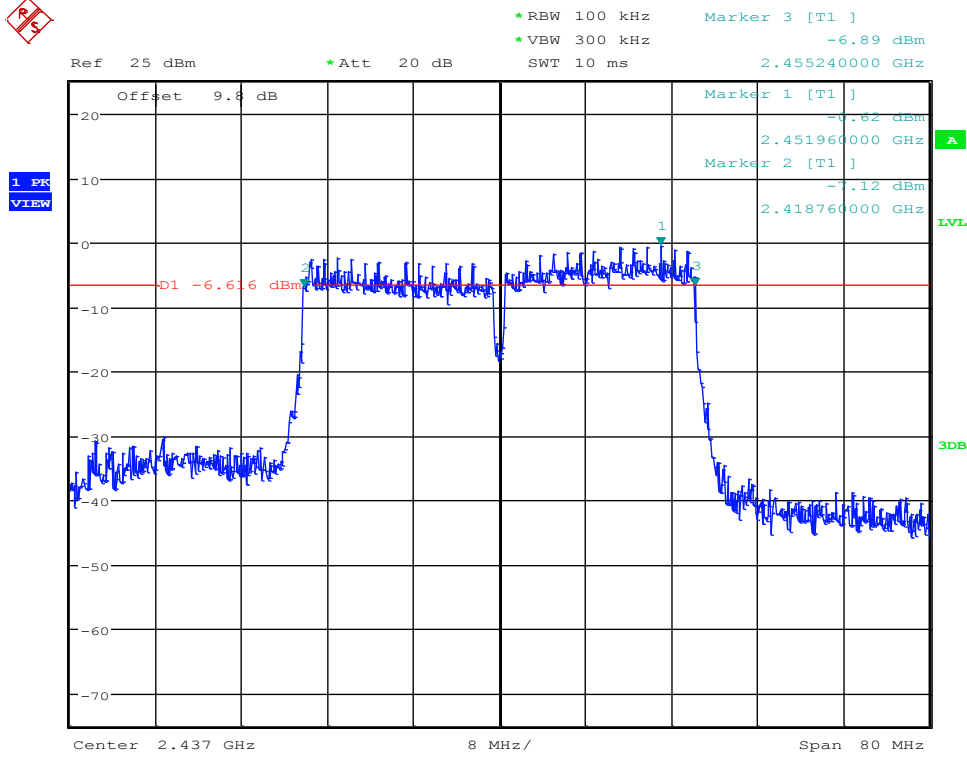

6dB Bandwidth_11N40MIMO_2437_Ant2

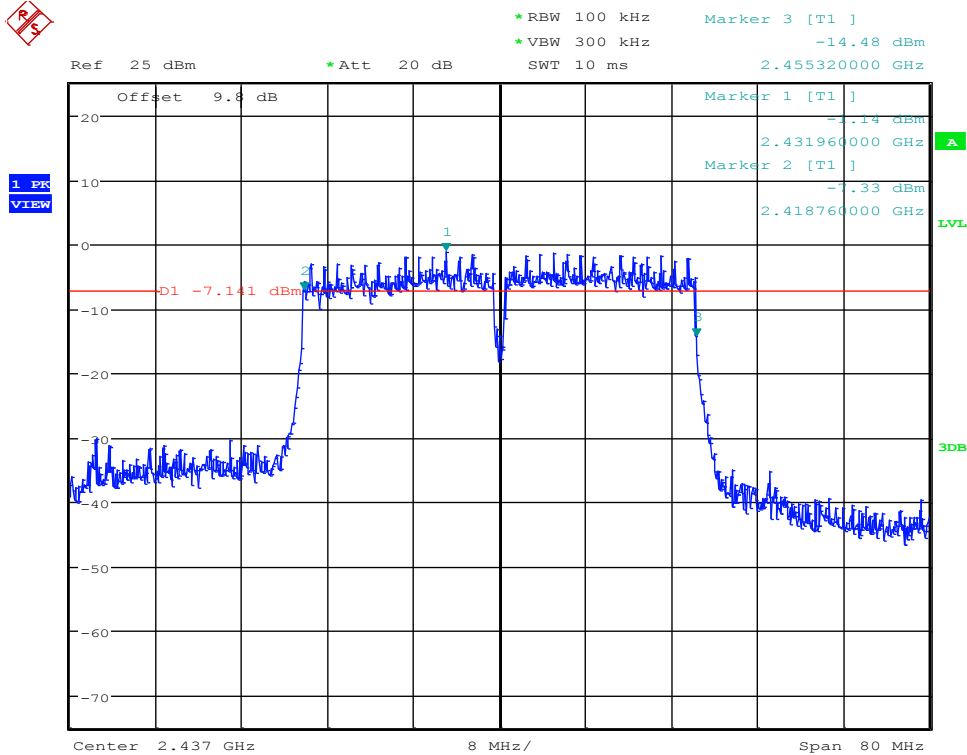

6dB Bandwidth_11N40MIMO_2452_Ant1

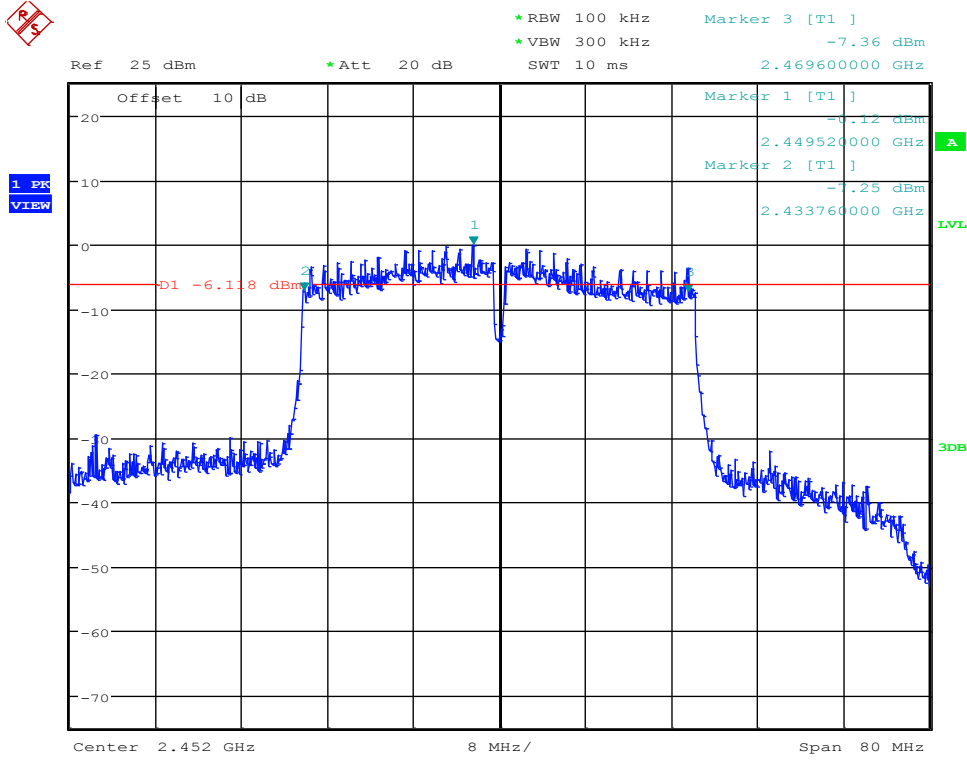

Date: 13.OCT.2017 18:52:25

6dB Bandwidth_11N40MIMO_2452_Ant2

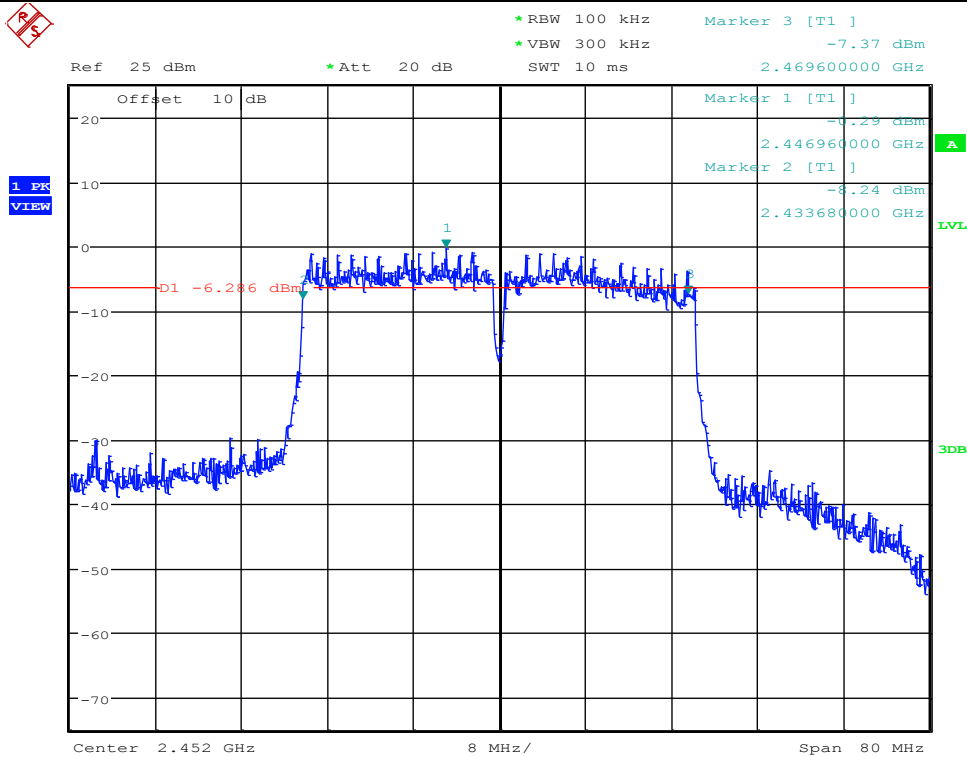

Date: 13.OCT.2017 18:54:55

6dB Bandwidth_11GMIMO_2412_Ant2

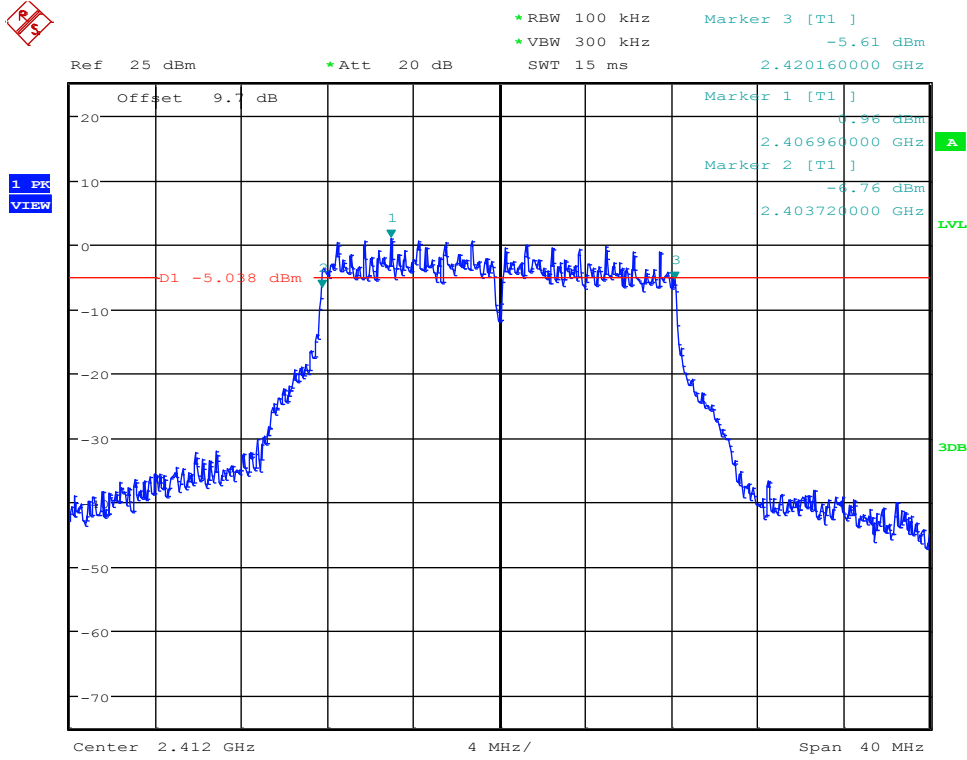

Date: 13.OCT.2017 16:52:08

6dB Bandwidth_11BMIMO_2412_Ant2

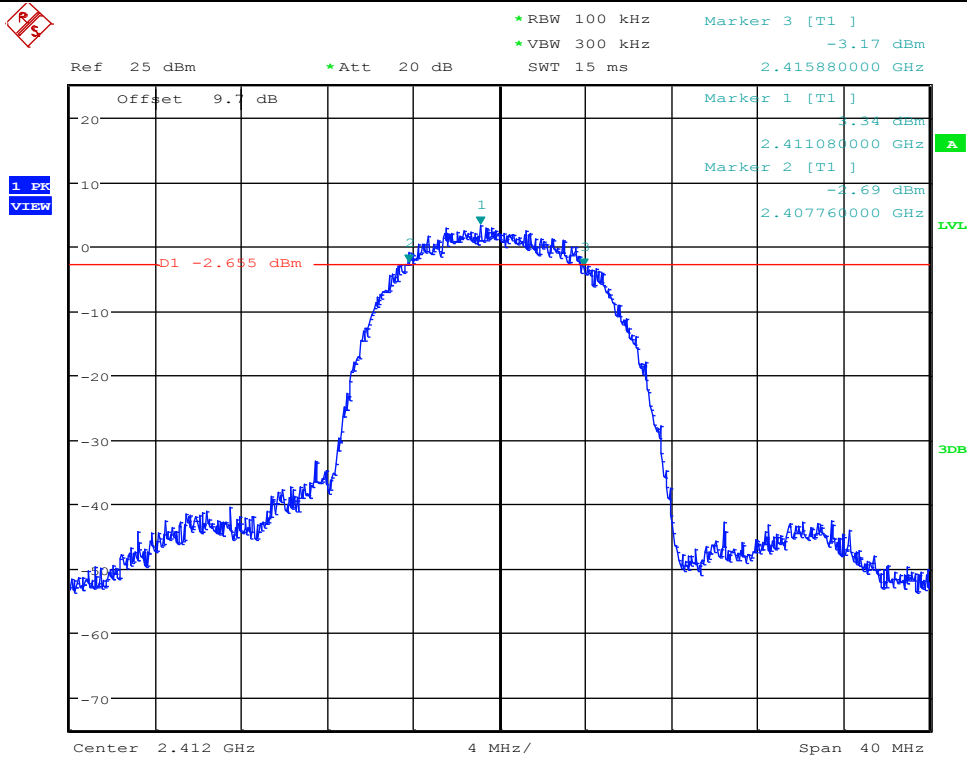

Date: 13.OCT.2017 16:30:32

6dB Bandwidth_11GMIMO_2437_Ant1

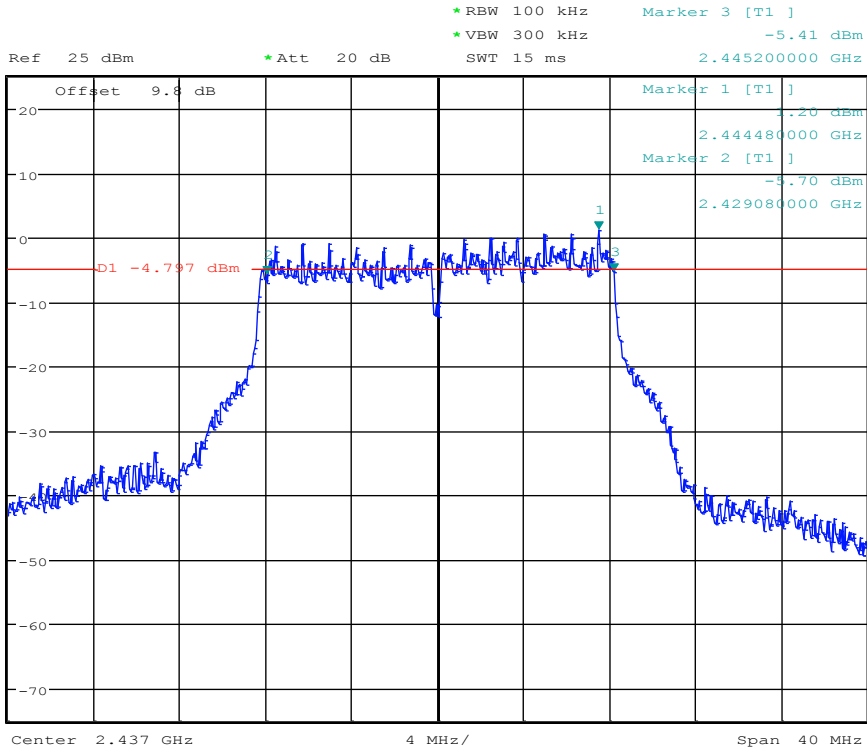

Date: 13.OCT.2017 16:59:15

6dB Bandwidth_11BMIMO_2437_Ant1

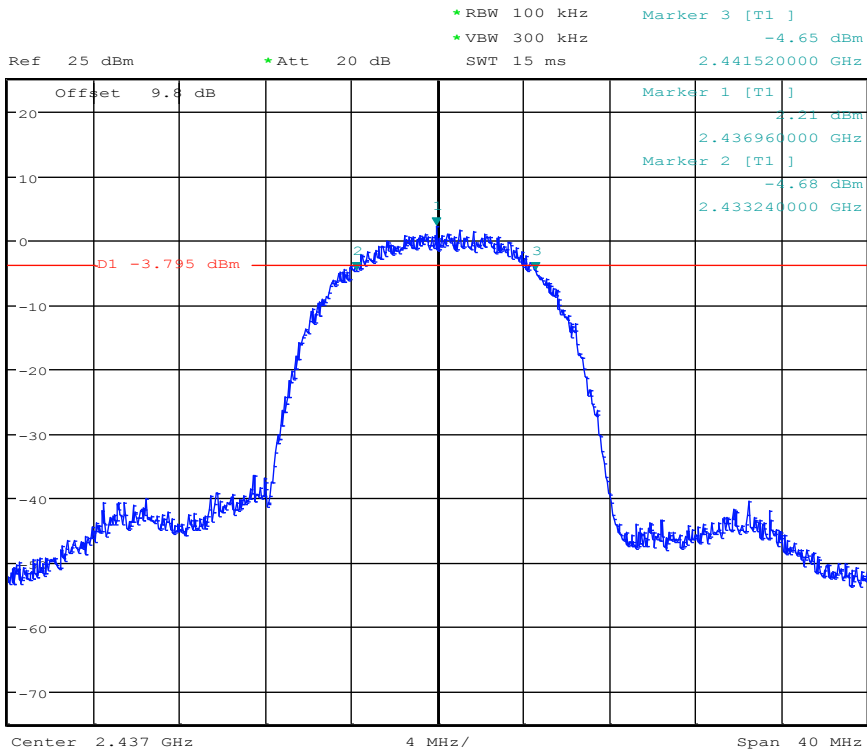

Date: 13.OCT.2017 16:38:40

6dB Bandwidth_11GMIMO_2437_Ant2

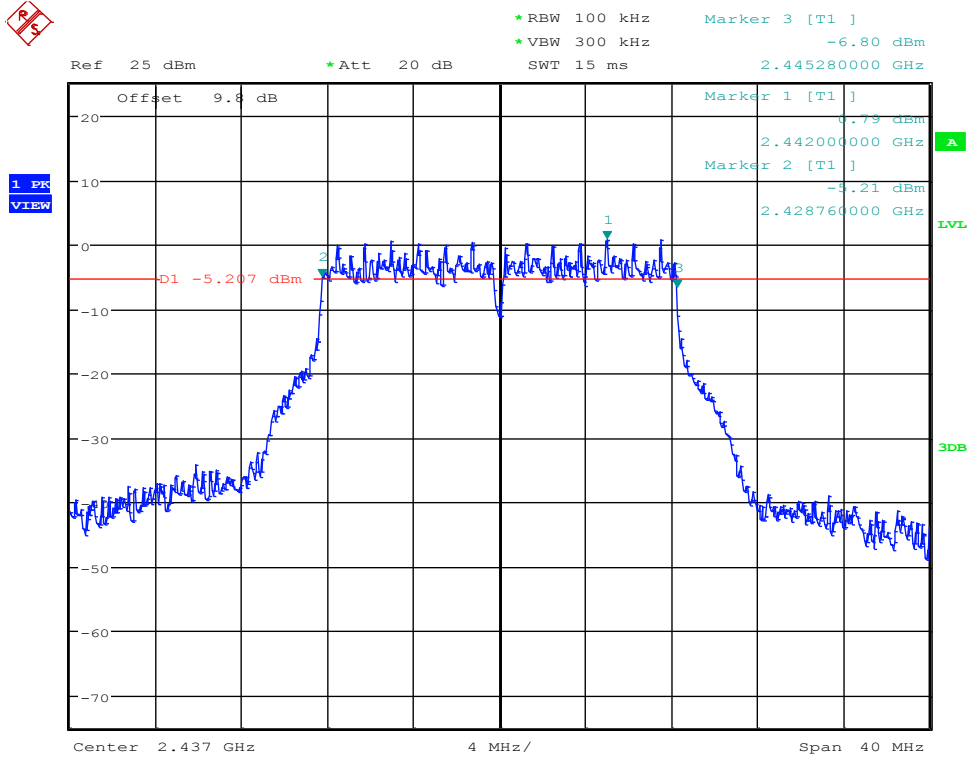

Date: 13.OCT.2017 17:00:47

6dB Bandwidth_11BMIMO_2437_Ant2

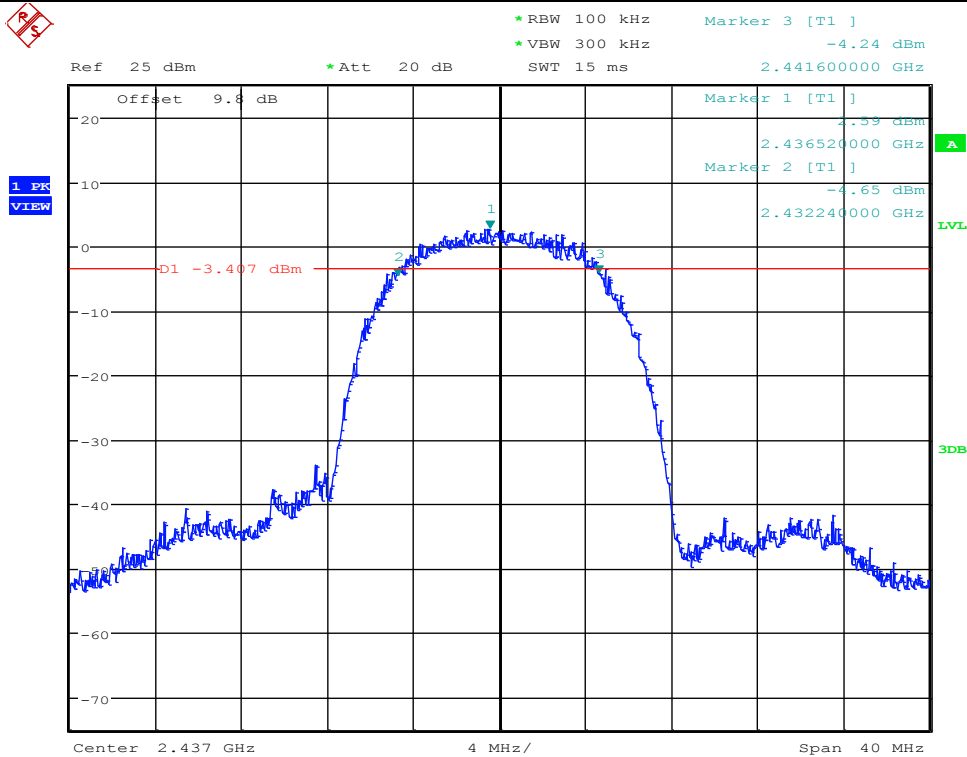

Date: 13.OCT.2017 16:40:13

6dB Bandwidth_11BMIMO_2462_Ant1

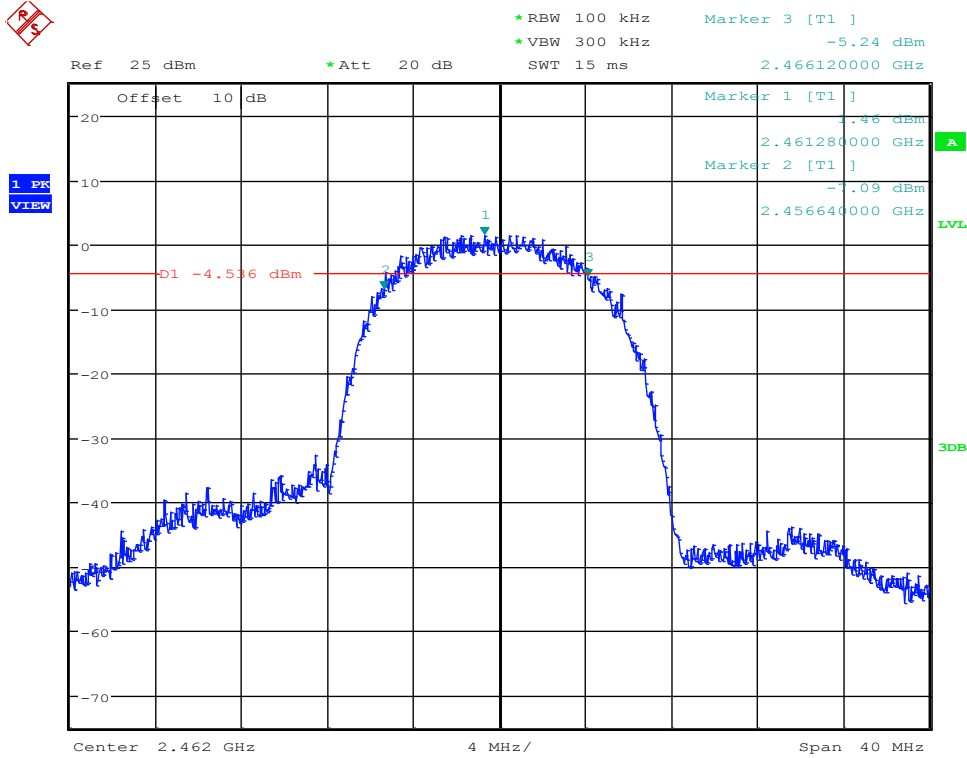

Date: 13.OCT.2017 16:42:46

6dB Bandwidth_11GMIMO_2462_Ant1

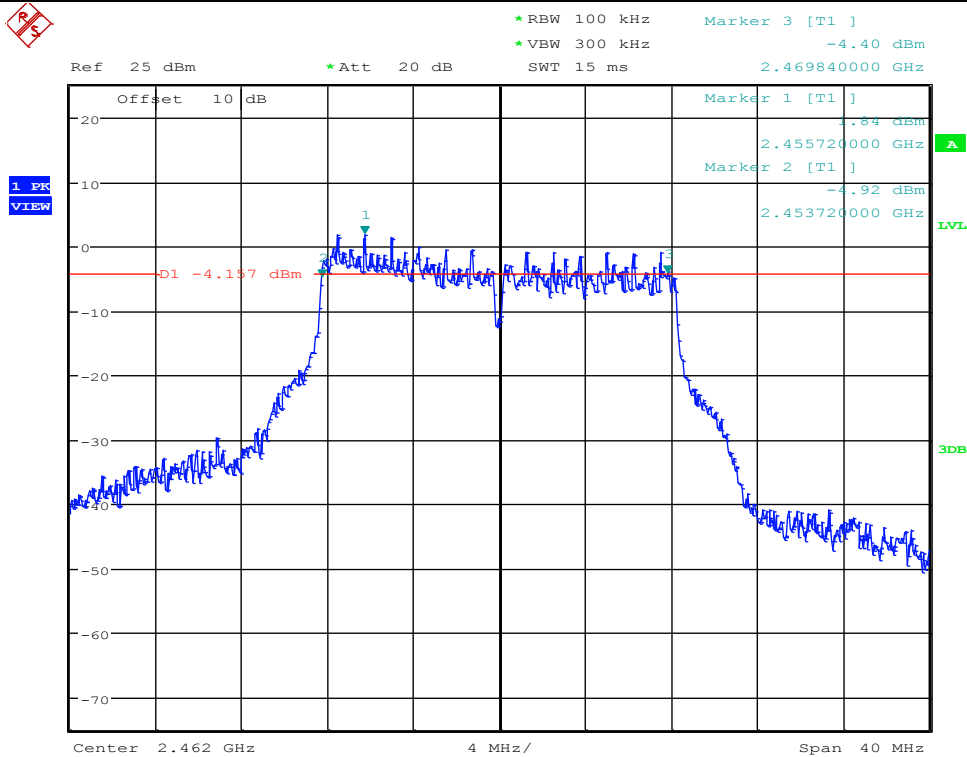

Date: 13.OCT.2017 17:40:02

6dB Bandwidth_11BMIMO_2462_Ant2

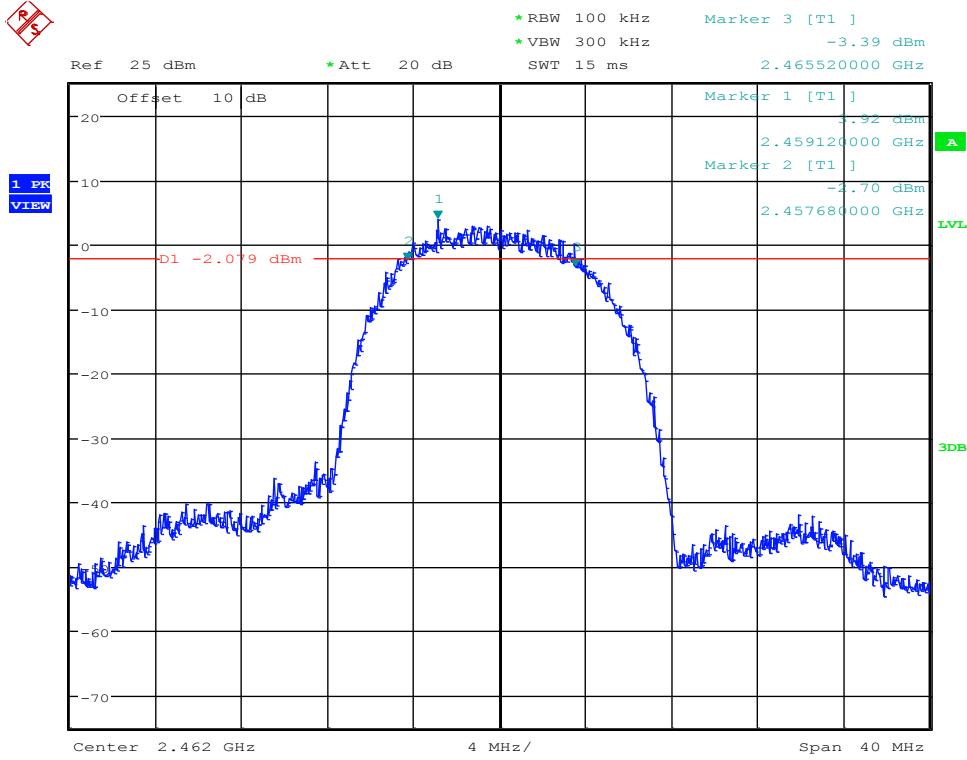

Date: 13.OCT.2017 16:45:15

6dB Bandwidth_11GMIMO_2462_Ant2

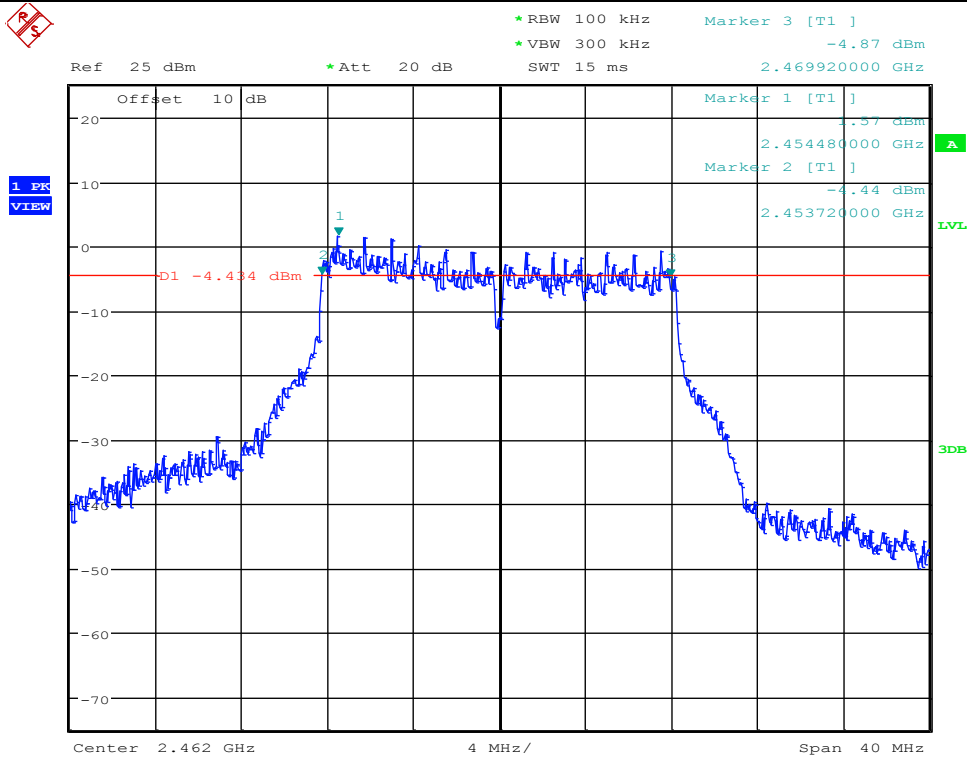

Date: 13.OCT.2017 17:42:32

99% bandwidth:

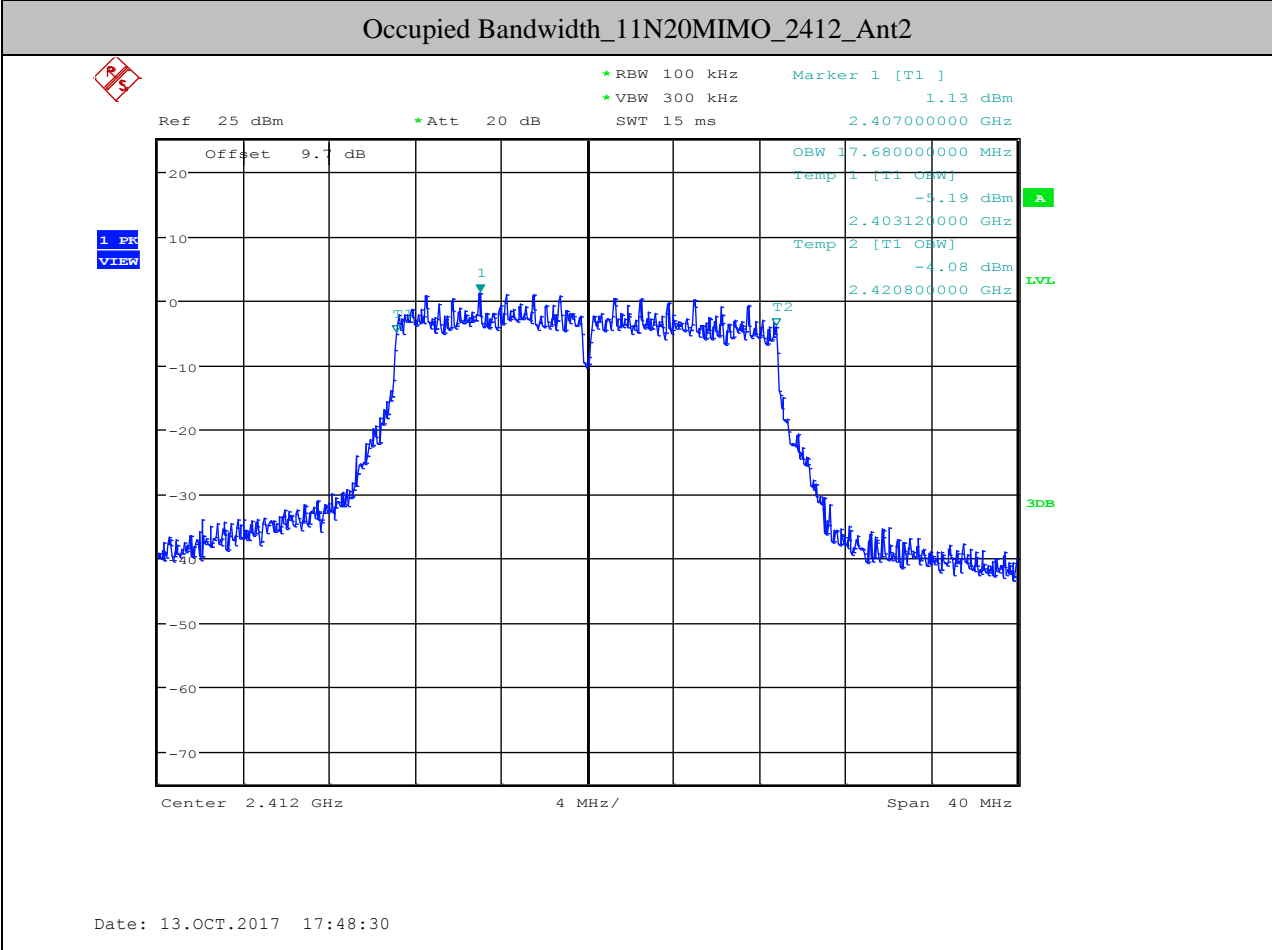
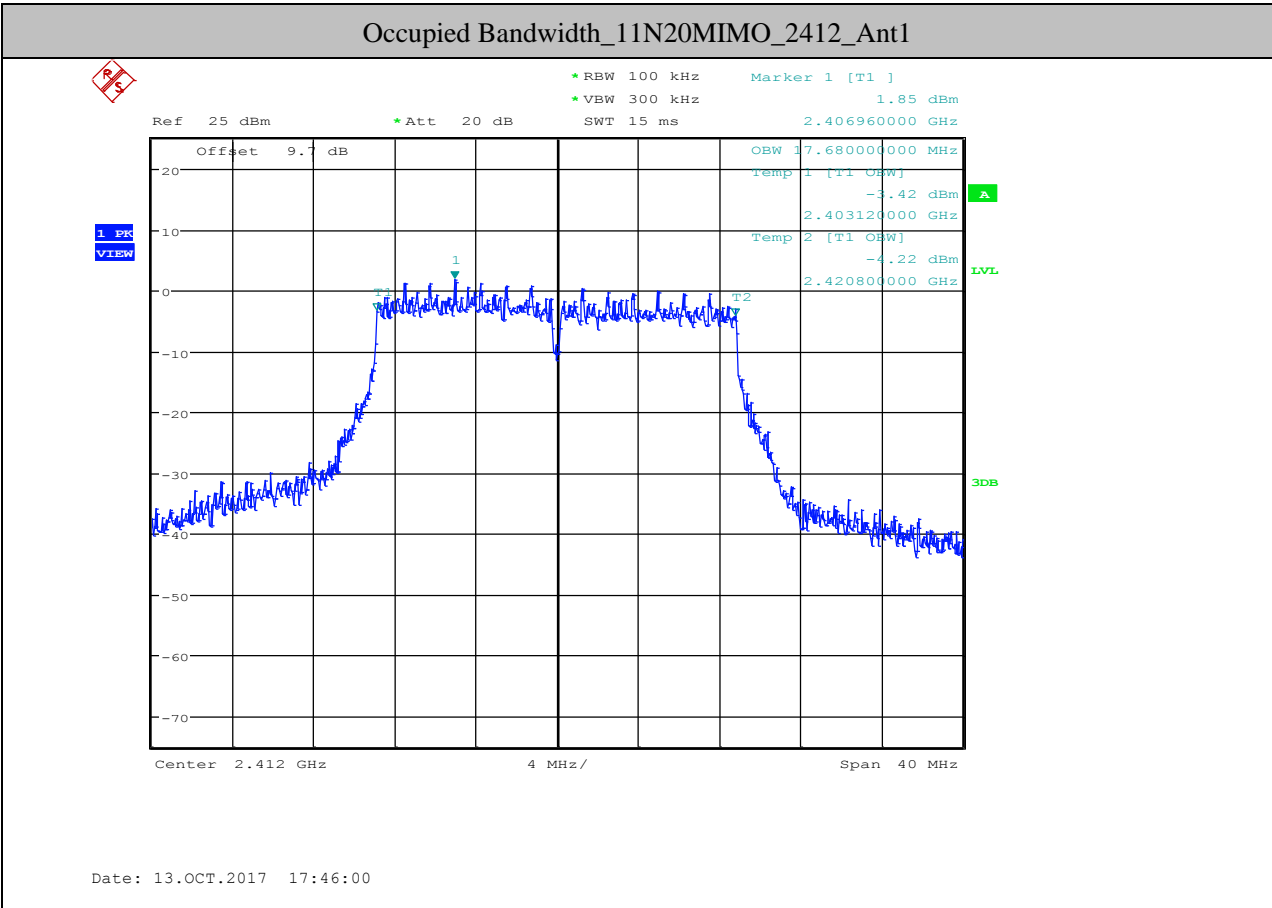

Occupied Bandwidth_11N20MIMO_2437_Ant1

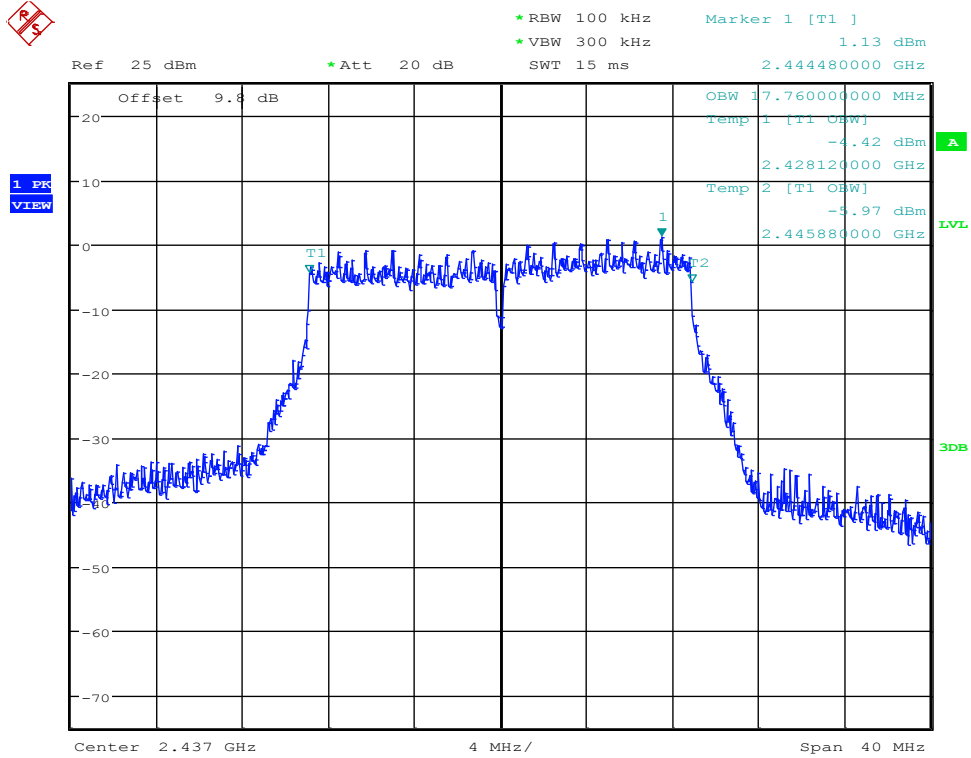

Date: 13.OCT.2017 18:32:53

Occupied Bandwidth_11N20MIMO_2437_Ant2

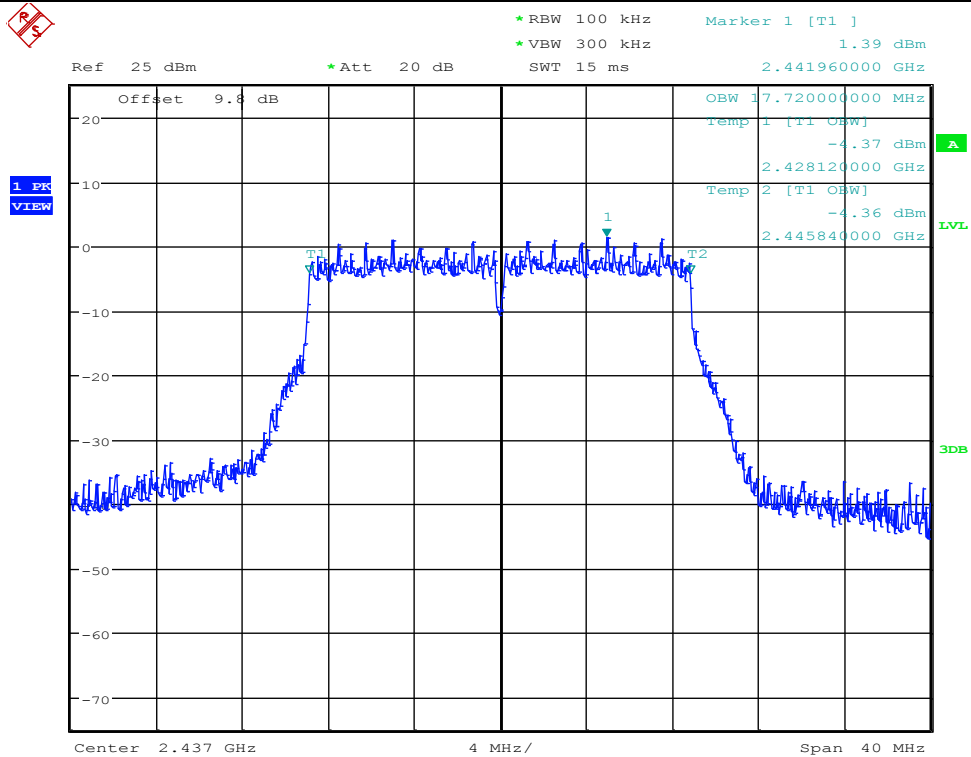

Date: 13.OCT.2017 18:34:26

Occupied Bandwidth_11N20MIMO_2462_Ant1

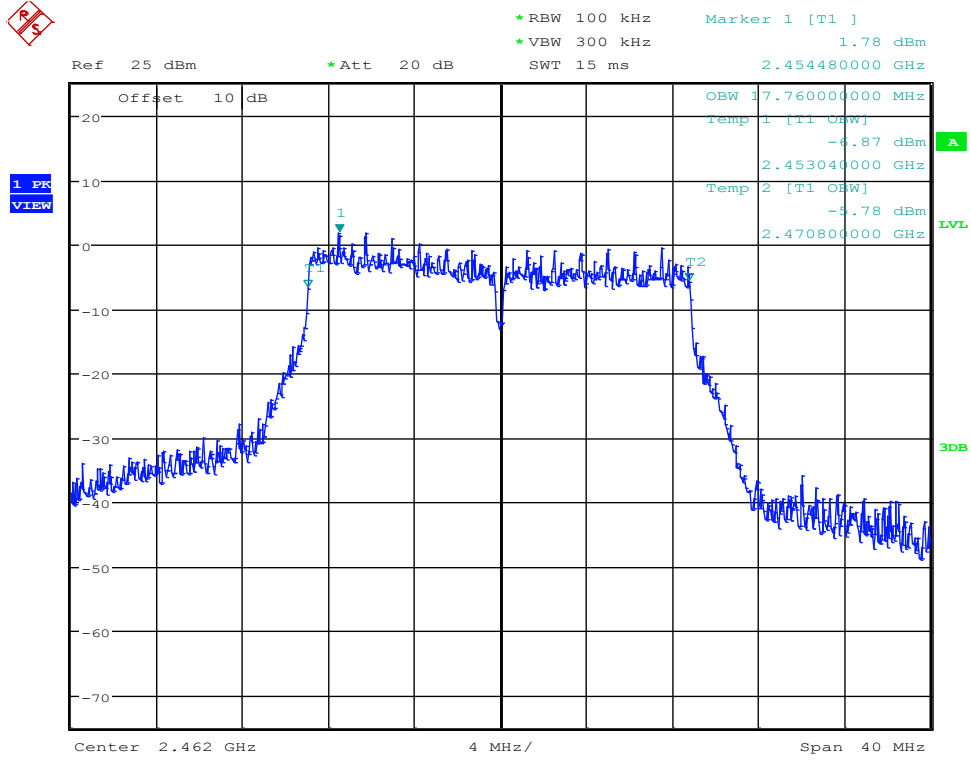

Date: 13.OCT.2017 18:36:44

Occupied Bandwidth_11N20MIMO_2462_Ant2

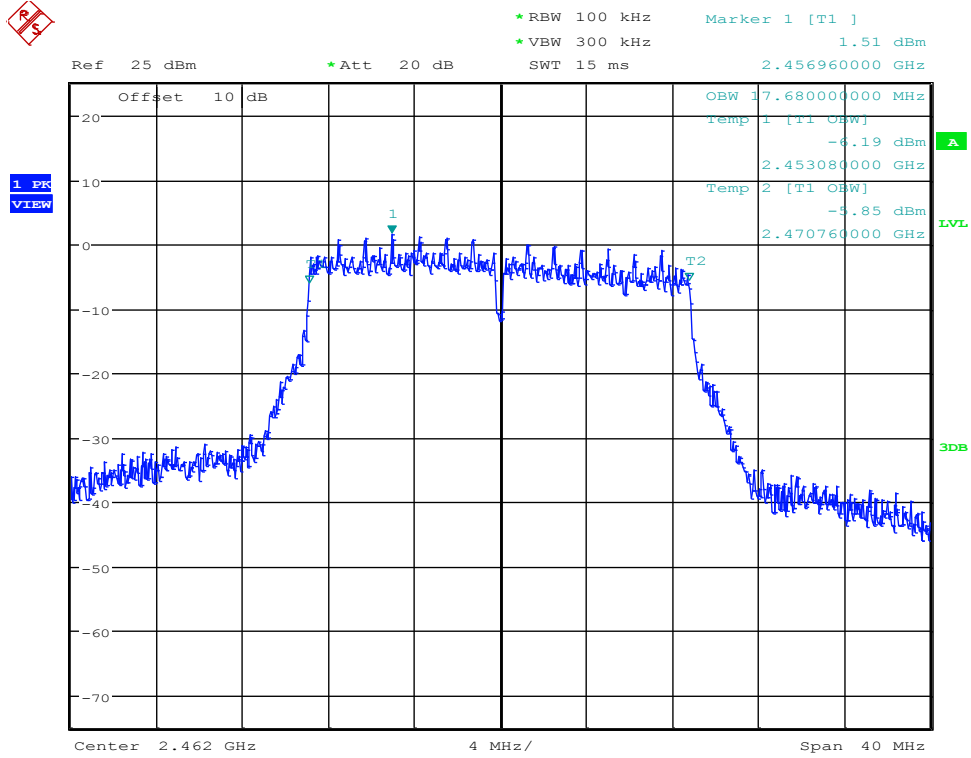

Date: 13.OCT.2017 18:39:14

Occupied Bandwidth_11N40MIMO_2422_Ant1

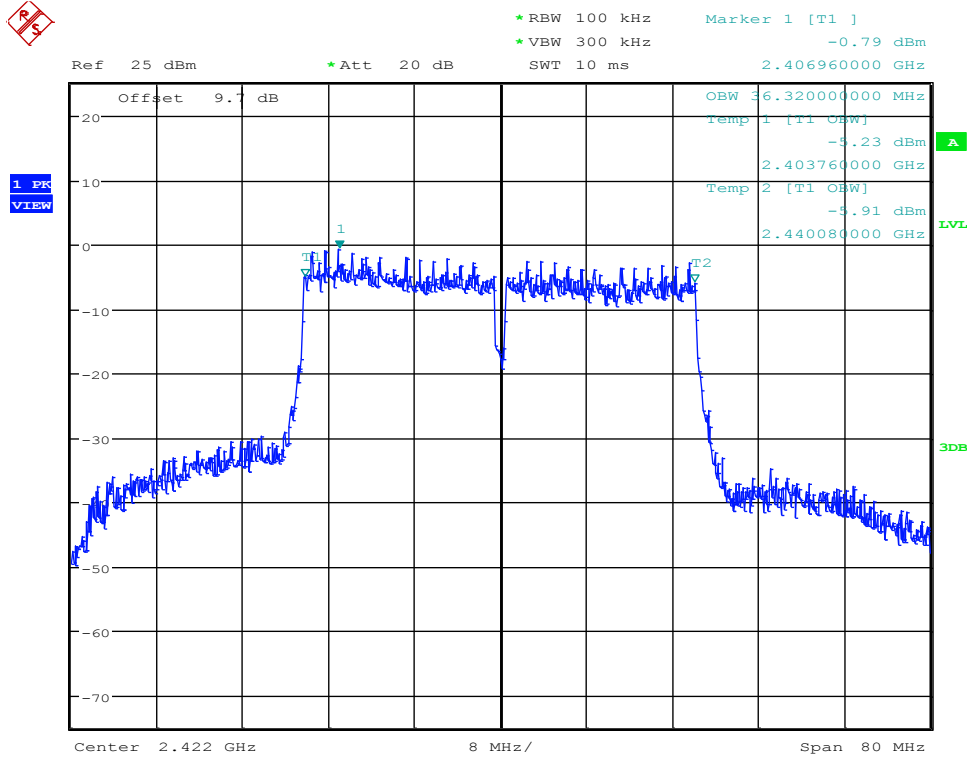

Date: 13.OCT.2017 18:42:48

Occupied Bandwidth_11N40MIMO_2422_Ant2

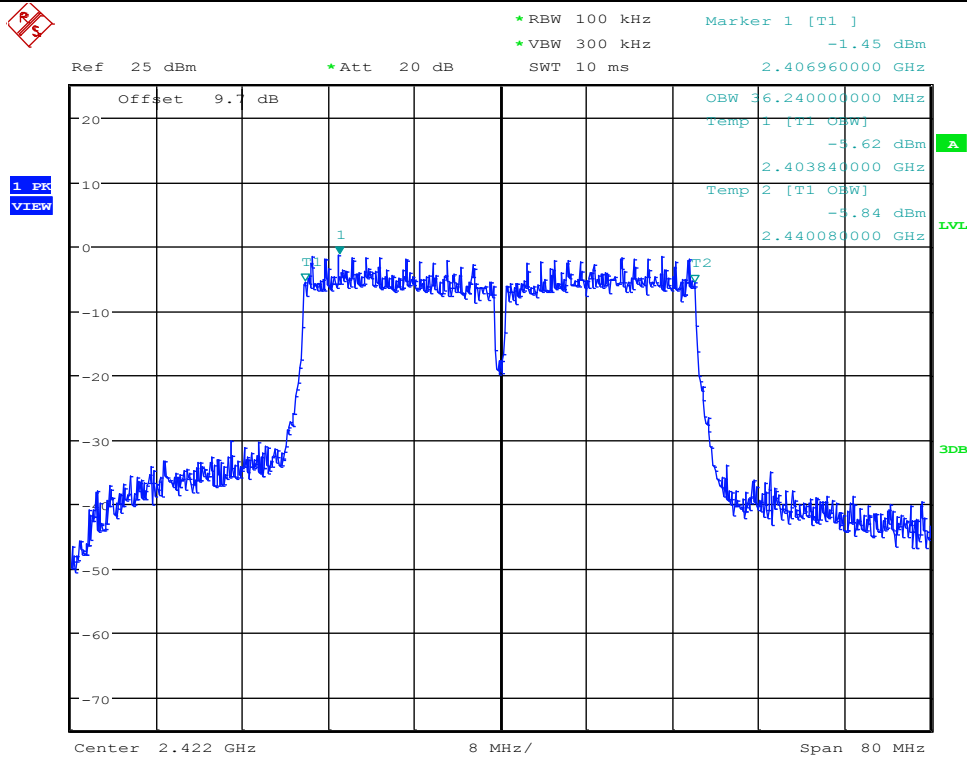

Date: 13.OCT.2017 18:45:18

Occupied Bandwidth_11N40MIMO_2437_Ant1

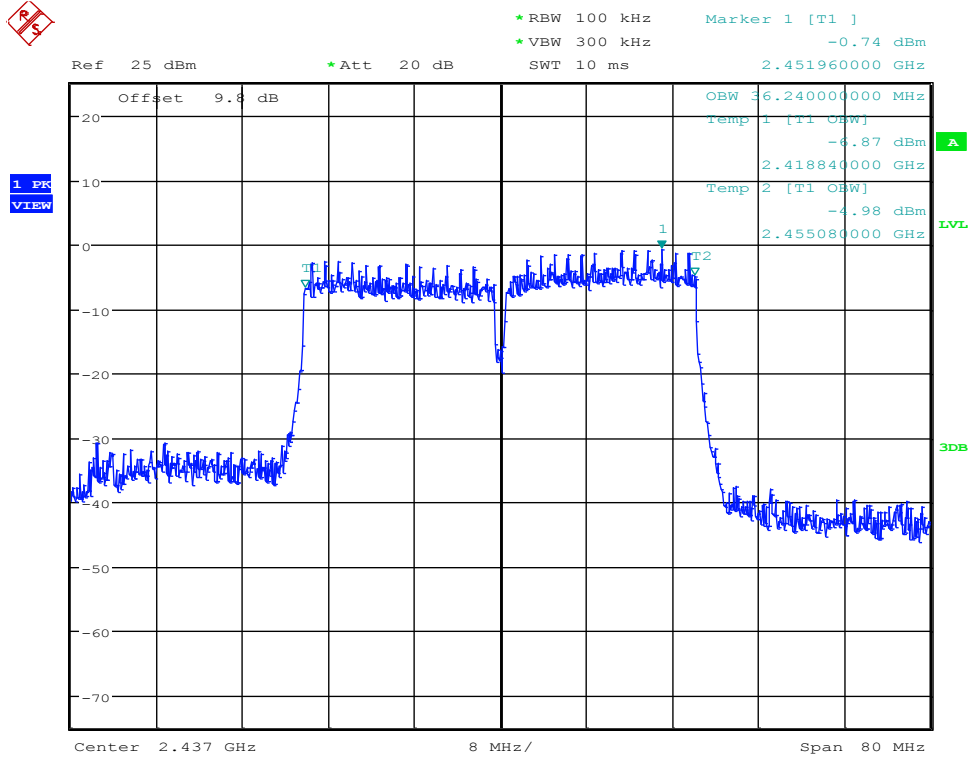

Date: 13.OCT.2017 18:48:27

Occupied Bandwidth_11N40MIMO_2437_Ant2

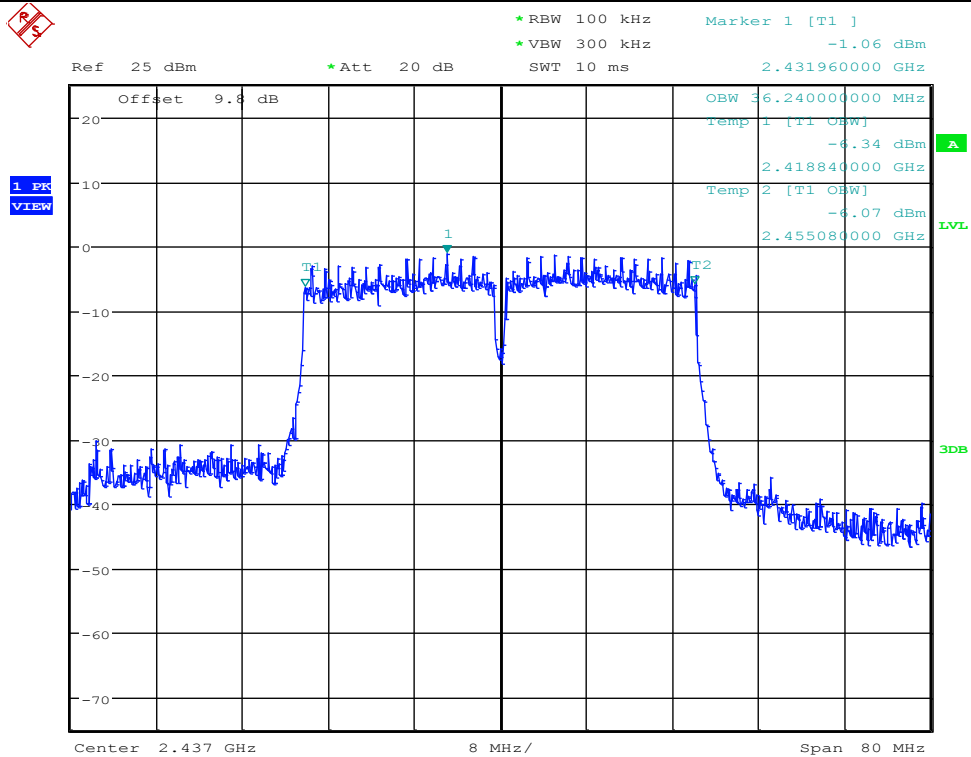

Date: 13.OCT.2017 18:49:59

Occupied Bandwidth_11N40MIMO_2452_Ant1

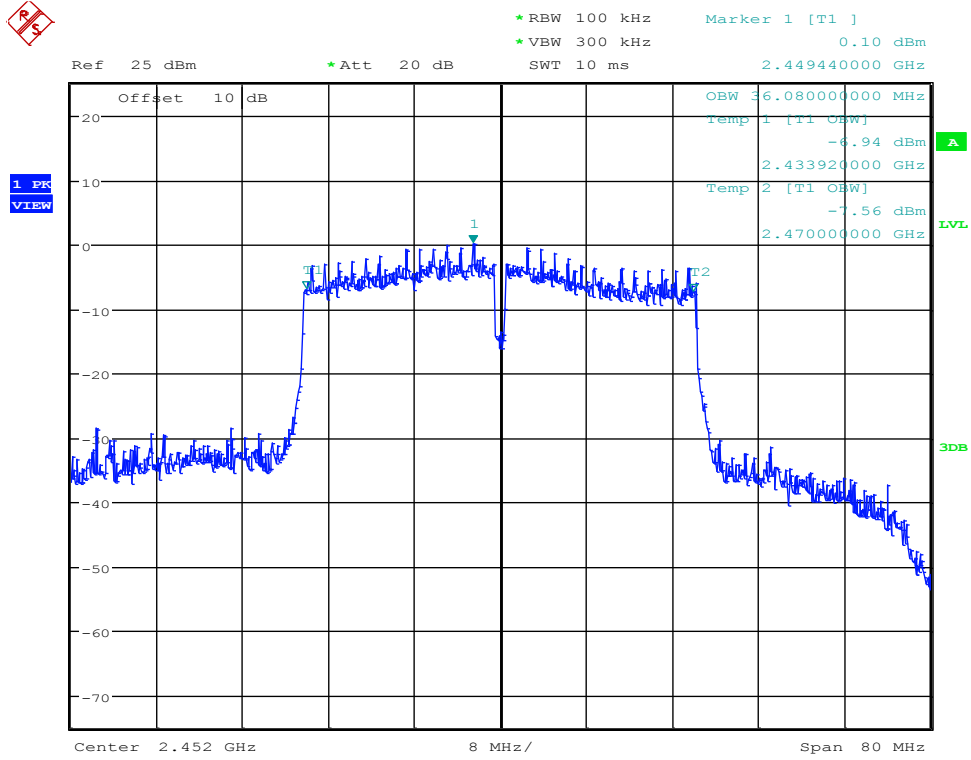

Occupied Bandwidth_11N40MIMO_2452_Ant2

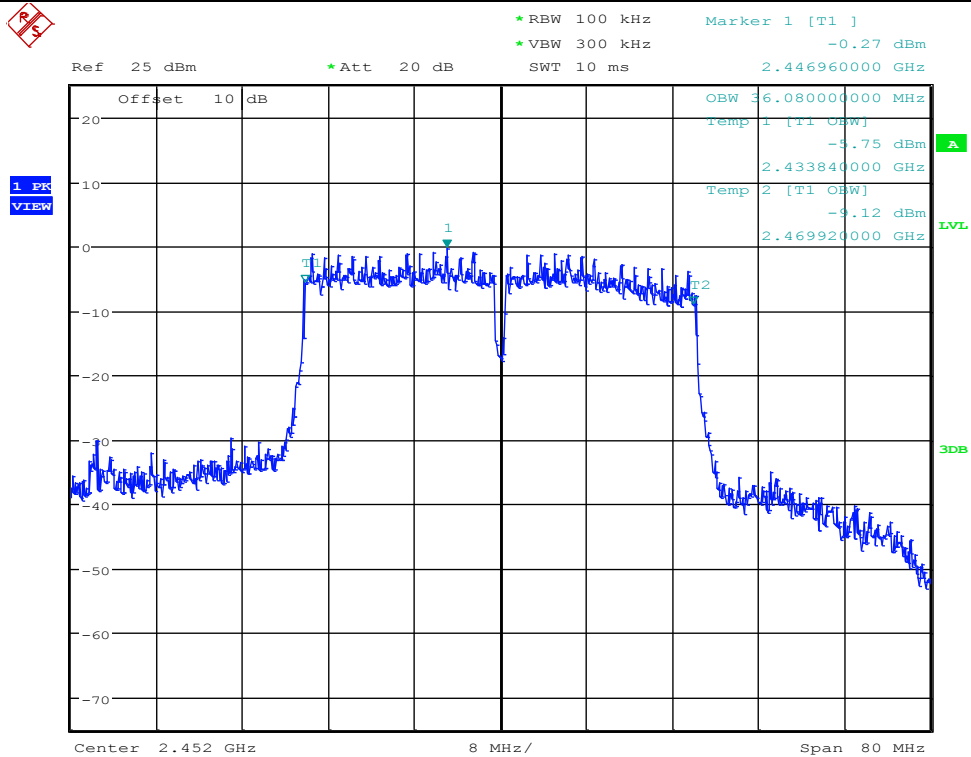

Occupied Bandwidth_11GMIMO_2412_Ant1

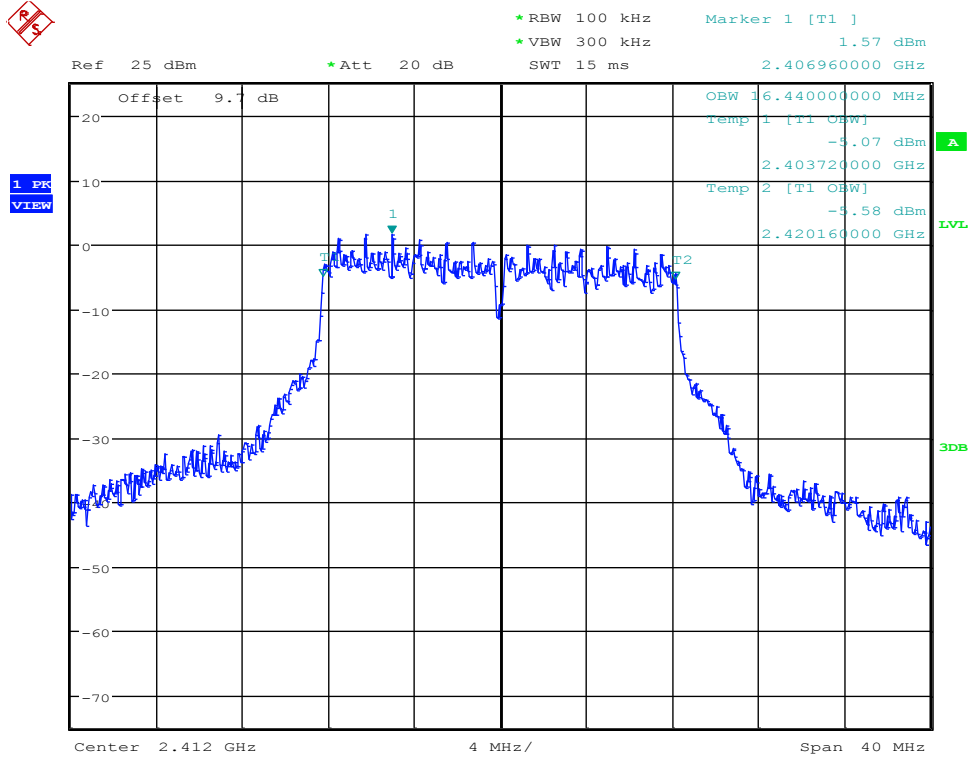

Date: 13.OCT.2017 16:49:58

Occupied Bandwidth_11BMIMO_2412_Ant1

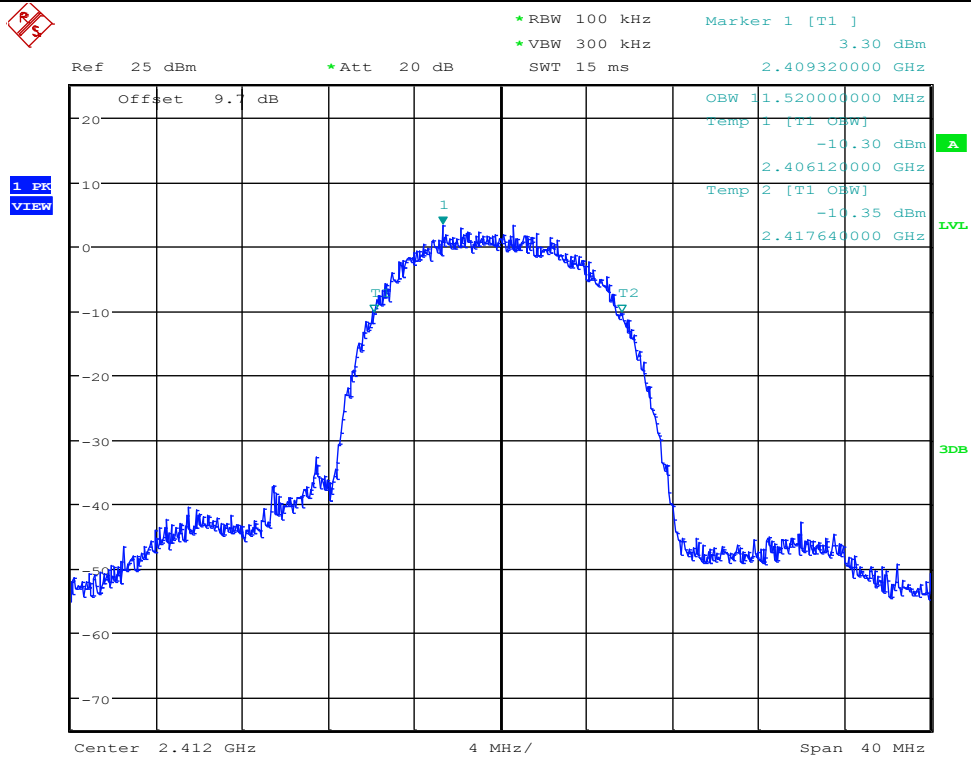

Date: 13.OCT.2017 16:28:22

Occupied Bandwidth_11GMIMO_2437_Ant1

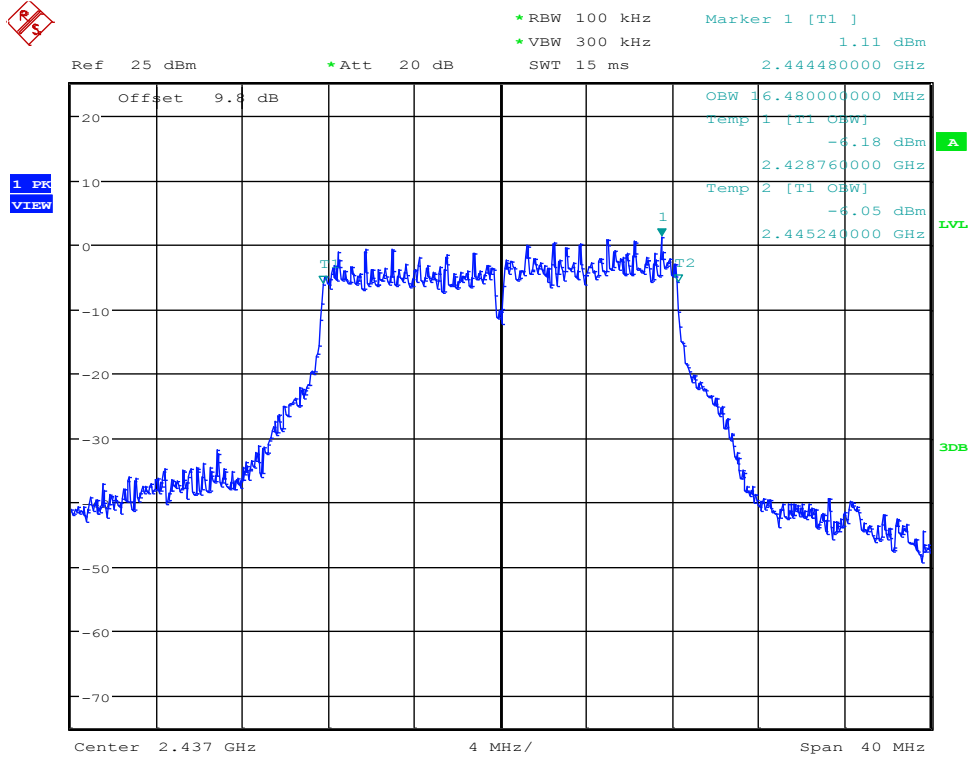

Date: 13.OCT.2017 16:59:33

Occupied Bandwidth_11BMIMO_2437_Ant1

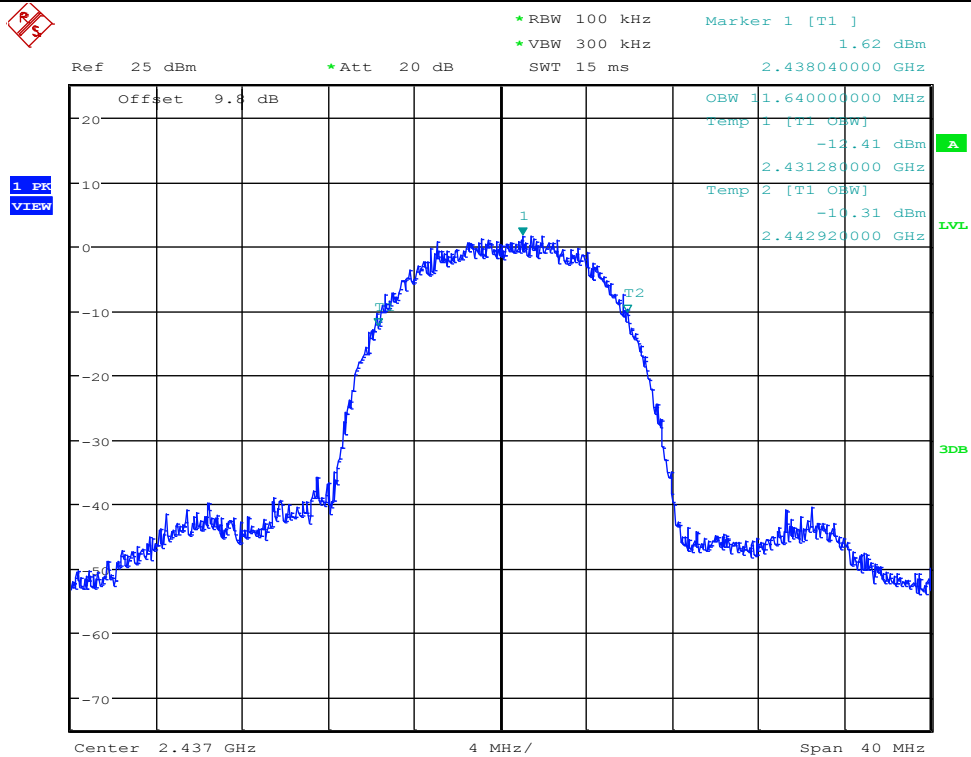

Date: 13.OCT.2017 16:38:59

Occupied Bandwidth_11GMIMO_2437_Ant2

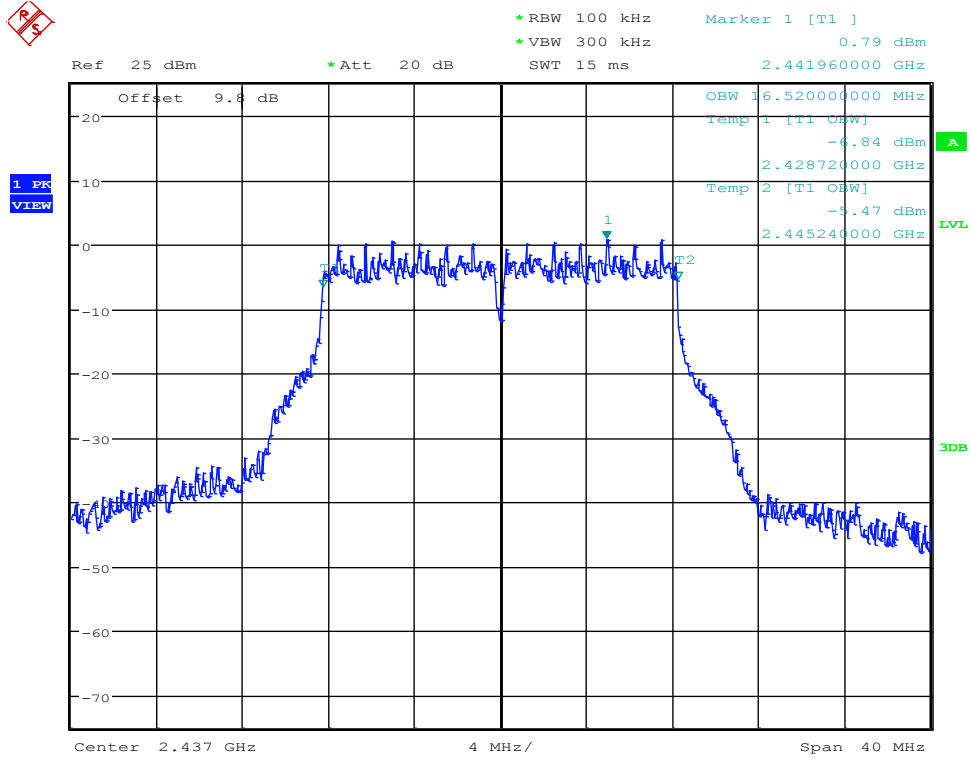

Date: 13.OCT.2017 17:01:05

Occupied Bandwidth_11BMIMO_2437_Ant2

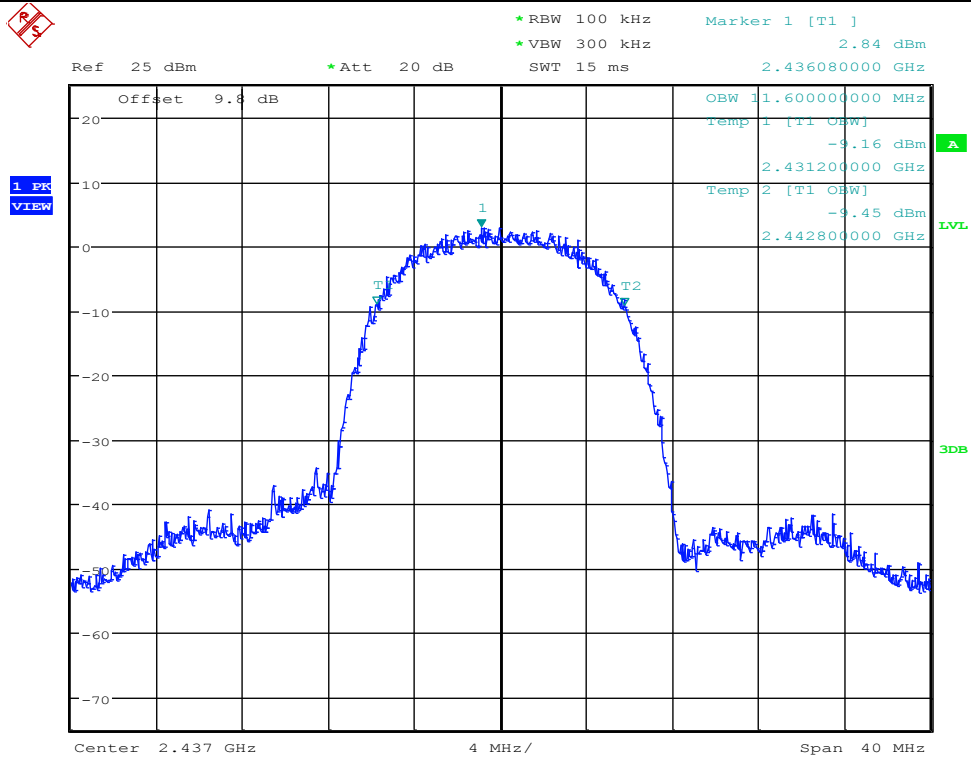

Date: 13.OCT.2017 16:40:31

Occupied Bandwidth_11BMIMO_2462_Ant2

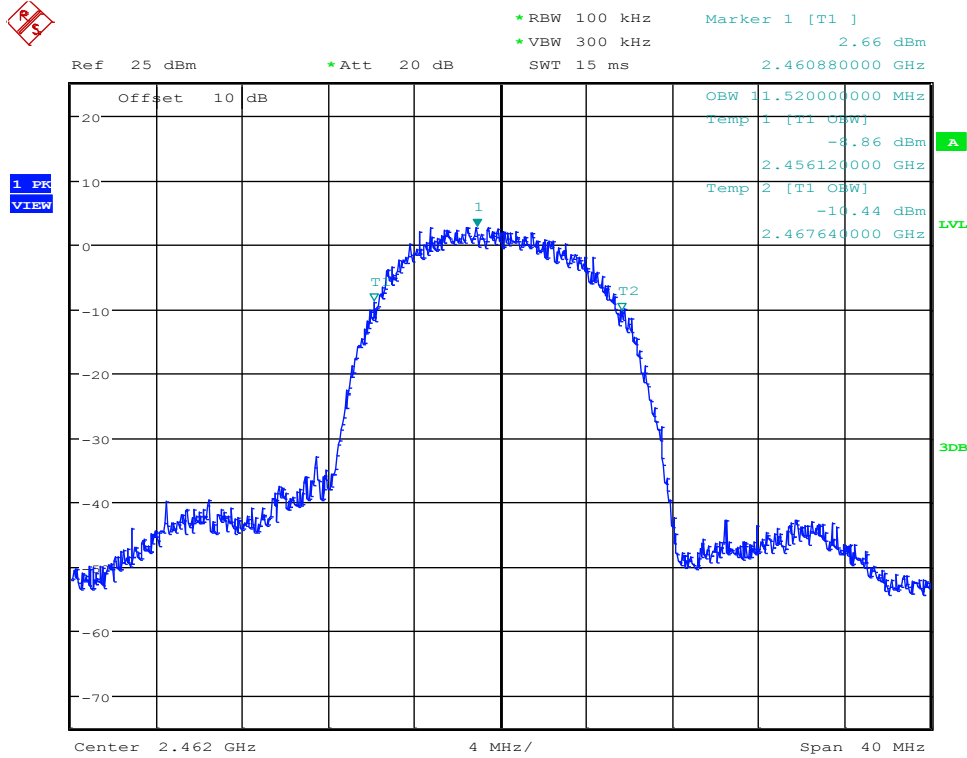

Date: 13.OCT.2017 16:45:33

Occupied Bandwidth_11GMIMO_2462_Ant2

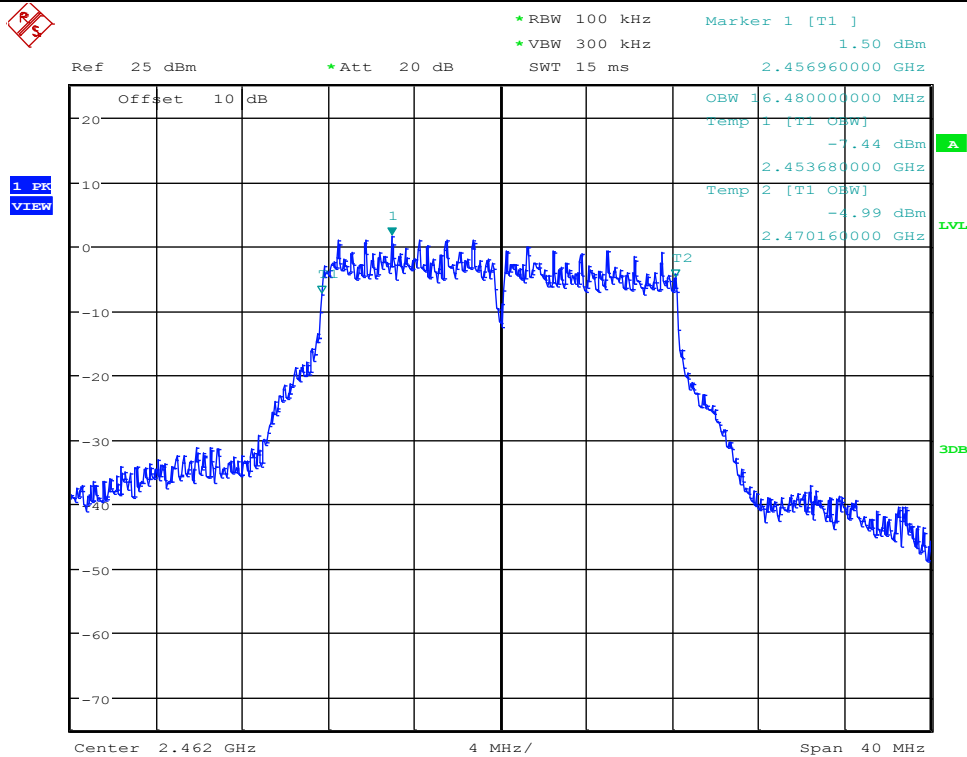

Date: 13.OCT.2017 17:42:50

5. Conducted peak Output Power

5.1. Block diagram of test setup

Same as section 4.1

5.2. Limits

For systems using digital modulation in the 902-928 MHz, 2400-2483.5 MHz, and 5725-5850 MHz bands: 1 Watt.
If transmitting antennas of directional gain greater than 6 dBi are used, the conducted output power from the intentional radiator shall be reduced below the stated values as appropriate, by the amount in dB that the directional gain of the antenna exceeds 6 dBi.

5.3. Test Procedure

Connect each EUT's antenna output to power sensor by RF cable and attenuator

Measure the PK output power of each antenna port by power sensor.

5.4. Test Result

Test Mode	Test Channel	Ant	Power[dBm]	Limit[dBm]	Verdict
11BMIMO	2412	Ant1	19.14	30	PASS
11BMIMO	2412	Ant2	19.45	30	PASS
11BMIMO	2412	Ant1+Ant2	22.31	30	PASS
11BMIMO	2437	Ant1	18.01	30	PASS
11BMIMO	2437	Ant2	19.5	30	PASS
11BMIMO	2437	Ant1+Ant2	21.83	30	PASS
11BMIMO	2462	Ant1	18.22	30	PASS
11BMIMO	2462	Ant2	19.41	30	PASS
11BMIMO	2462	Ant1+Ant2	21.87	30	PASS
11GMIMO	2412	Ant1	19.87	30	PASS
11GMIMO	2412	Ant2	19.61	30	PASS
11GMIMO	2412	Ant1+Ant2	22.75	30	PASS
11GMIMO	2437	Ant1	19.16	30	PASS
11GMIMO	2437	Ant2	19.89	30	PASS
11GMIMO	2437	Ant1+Ant2	22.55	30	PASS
11GMIMO	2462	Ant1	19.27	30	PASS
11GMIMO	2462	Ant2	19.75	30	PASS
11GMIMO	2462	Ant1+Ant2	22.53	30	PASS
11N20MIMO	2412	Ant1	21.16	30	PASS
11N20MIMO	2412	Ant2	20.89	30	PASS
11N20MIMO	2412	Ant1+Ant2	24.04	30	PASS
11N20MIMO	2437	Ant1	20.48	30	PASS

11N20MIMO	2437	Ant2	21.28	30	PASS
11N20MIMO	2437	Ant1+Ant2	23.91	30	PASS
11N20MIMO	2462	Ant1	20.69	30	PASS
11N20MIMO	2462	Ant2	20.75	30	PASS
11N20MIMO	2462	Ant1+Ant2	23.73	30	PASS
11N40MIMO	2422	Ant1	21.03	30	PASS
11N40MIMO	2422	Ant2	21.39	30	PASS
11N40MIMO	2422	Ant1+Ant2	24.22	30	PASS
11N40MIMO	2437	Ant1	21.3	30	PASS
11N40MIMO	2437	Ant2	21.51	30	PASS
11N40MIMO	2437	Ant1+Ant2	24.42	30	PASS
11N40MIMO	2452	Ant1	21.73	30	PASS
11N40MIMO	2452	Ant2	21.81	30	PASS
11N40MIMO	2452	Ant1+Ant2	24.78	30	PASS

6. Power Spectral Density

6.1. Block diagram of test setup

Same as section 4.1

6.2. Limits

For digitally modulated systems, the power spectral density conducted from the intentional radiator to the antenna shall not be greater than 8dBm in any 3 kHz band during any time interval of continuous transmission.

6.3. Test Procedure

- (1) Connect EUT's antenna output to spectrum analyzer by RF cable.
- (2) Set the spectrum analyzer as follows:

Center frequency	DTS Channel center frequency
RBW:	$3 \text{ kHz} \leq \text{RBW} \leq 100 \text{ kHz}$
VBW:	$\geq 3\text{RBW}$
Span	1.5times the DTS bandwidth
Detector Mode:	RMS
Sweep time:	auto
Trace mode	Max hold
- (3) Allow the trace to stabilize, use the peak marker function to determine the maximum amplitude level within the RBW.
- (4) If measured value exceeds limit, reduce RBW (no less than 3 kHz) and repeat.

6.4. Test Result

Test Mode	Test Channel	Ant	PSD[dBm/30kHz]	Limit[dBm/3kHz]	Verdict
11BMIMO	2412	Ant1	-0.64	8.00	PASS
11BMIMO	2412	Ant2	-0.35	8.00	PASS
11BMIMO	2412	Ant1+Ant2	2.517	8.00	PASS
11BMIMO	2437	Ant1	-2.21	8.00	PASS
11BMIMO	2437	Ant2	-0.66	8.00	PASS
11BMIMO	2437	Ant1+Ant2	1.644	8.00	PASS
11BMIMO	2462	Ant1	-1.62	8.00	PASS
11BMIMO	2462	Ant2	-0.61	8.00	PASS
11BMIMO	2462	Ant1+Ant2	1.924	8.00	PASS
11GMIMO	2412	Ant1	-3.96	8.00	PASS
11GMIMO	2412	Ant2	-4.56	8.00	PASS
11GMIMO	2412	Ant1+Ant2	-1.239	8.00	PASS
11GMIMO	2437	Ant1	-4.19	8.00	PASS
11GMIMO	2437	Ant2	-3.91	8.00	PASS

11GMIMO	2437	Ant1+Ant2	-1.037	8.00	PASS
11GMIMO	2462	Ant1	-3.77	8.00	PASS
11GMIMO	2462	Ant2	-3.97	8.00	PASS
11GMIMO	2462	Ant1+Ant2	-0.858	8.00	PASS
11N20MIMO	2412	Ant1	-3.81	8.00	PASS
11N20MIMO	2412	Ant2	-3.18	8.00	PASS
11N20MIMO	2412	Ant1+Ant2	-0.473	8.00	PASS
11N20MIMO	2437	Ant1	-3.1	8.00	PASS
11N20MIMO	2437	Ant2	-3.15	8.00	PASS
11N20MIMO	2437	Ant1+Ant2	-0.114	8.00	PASS
11N20MIMO	2462	Ant1	-1.94	8.00	PASS
11N20MIMO	2462	Ant2	-3.21	8.00	PASS
11N20MIMO	2462	Ant1+Ant2	0.481	8.00	PASS
11N40MIMO	2422	Ant1	-6.04	8.00	PASS
11N40MIMO	2422	Ant2	-5.98	8.00	PASS
11N40MIMO	2422	Ant1+Ant2	-2.999	8.00	PASS
11N40MIMO	2437	Ant1	-4.96	8.00	PASS
11N40MIMO	2437	Ant2	-5.41	8.00	PASS
11N40MIMO	2437	Ant1+Ant2	-2.168	8.00	PASS
11N40MIMO	2452	Ant1	-4.21	8.00	PASS
11N40MIMO	2452	Ant2	-4.68	8.00	PASS
11N40MIMO	2452	Ant1+Ant2	-1.428	8.00	PASS

6.5. original test data

Maximum Peak power spectral density_11N20MIMO_2412_Ant1

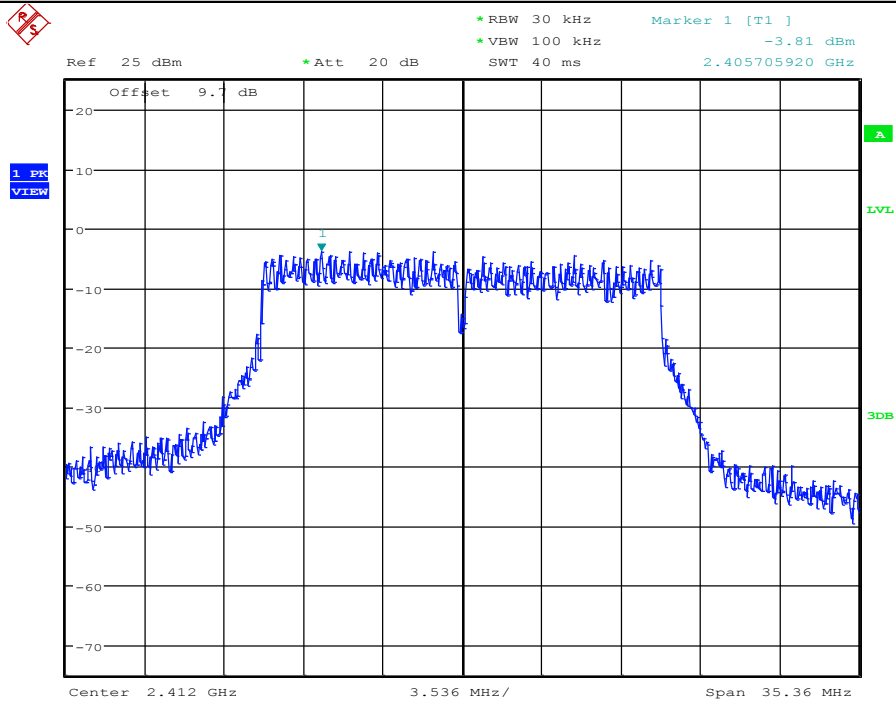

Date: 13.OCT.2017 17:46:53

Maximum Peak power spectral density_11N20MIMO_2412_Ant2

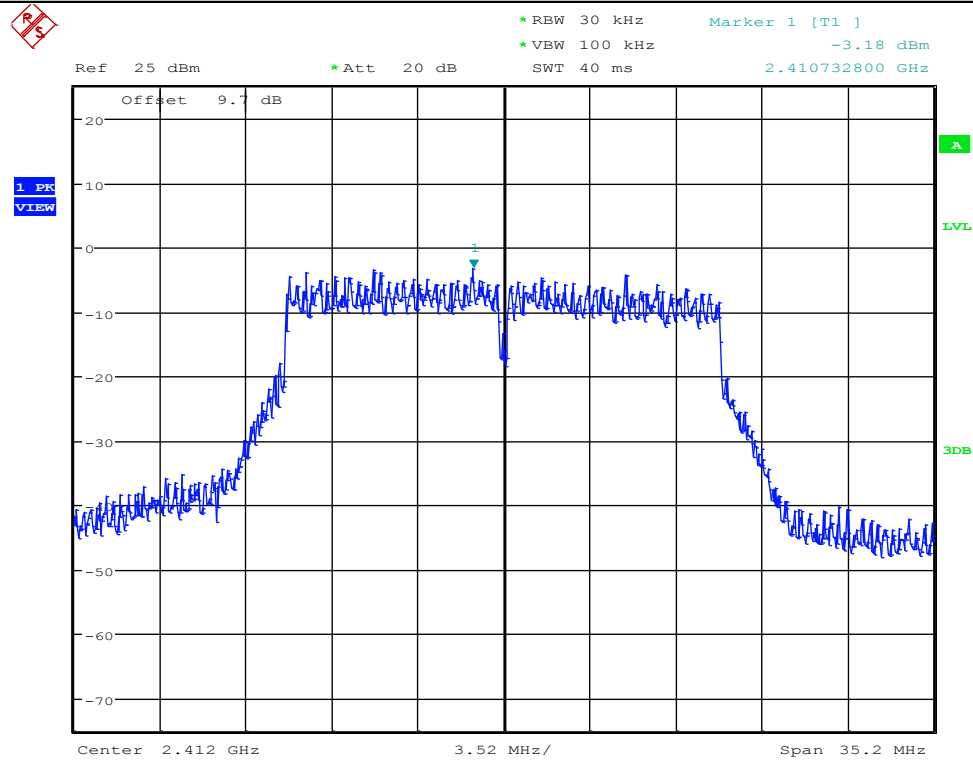

Date: 13.OCT.2017 17:49:24

Maximum Peak power spectral density_11N20MIMO_2437_Ant1

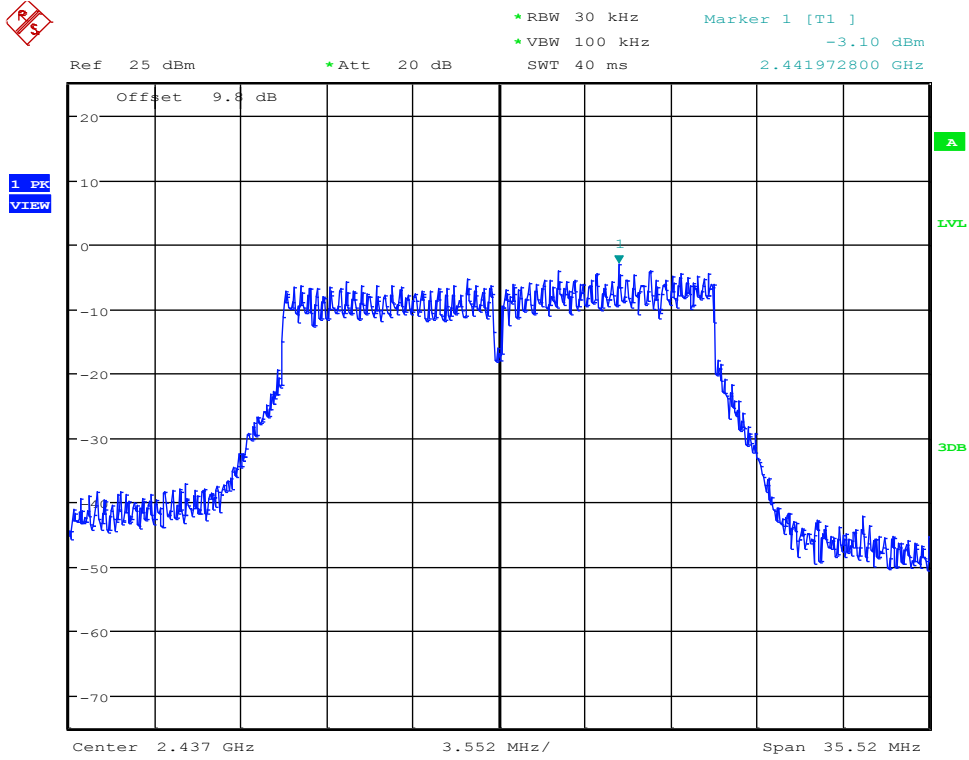

Date: 13.OCT.2017 18:33:46

Maximum Peak power spectral density_11N20MIMO_2437_Ant2

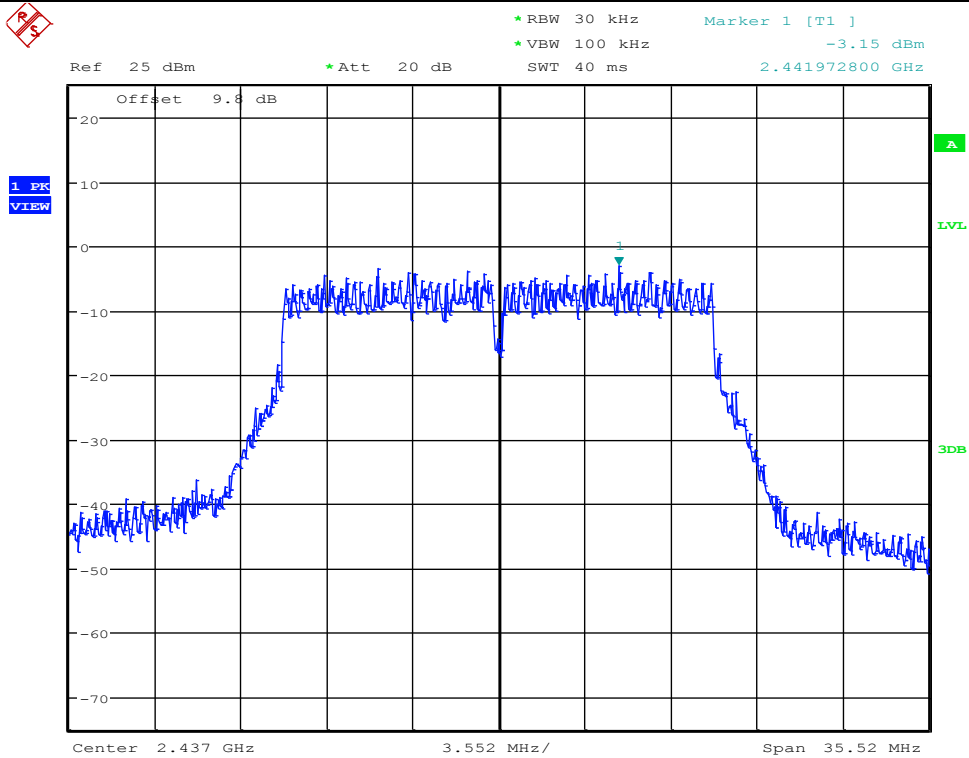

Date: 13.OCT.2017 18:35:19

Maximum Peak power spectral density_11N20MIMO_2462_Ant1



Ref 25 dBm *Att 20 dB *RBW 30 kHz Marker 1 [T1]
*VBW 100 kHz -1.94 dBm
SWT 40 ms 2.453819360 GHz

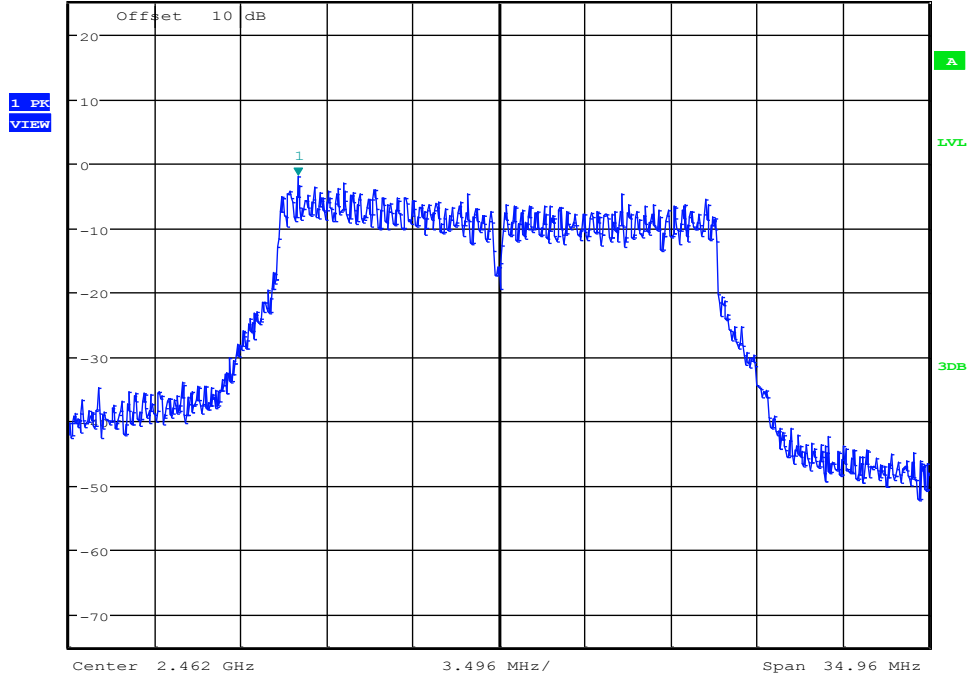

Date: 13.OCT.2017 18:37:37

Maximum Peak power spectral density_11N20MIMO_2462_Ant2



Ref 25 dBm *Att 20 dB *RBW 30 kHz Marker 1 [T1]
*VBW 100 kHz -3.21 dBm
SWT 40 ms 2.460712400 GHz

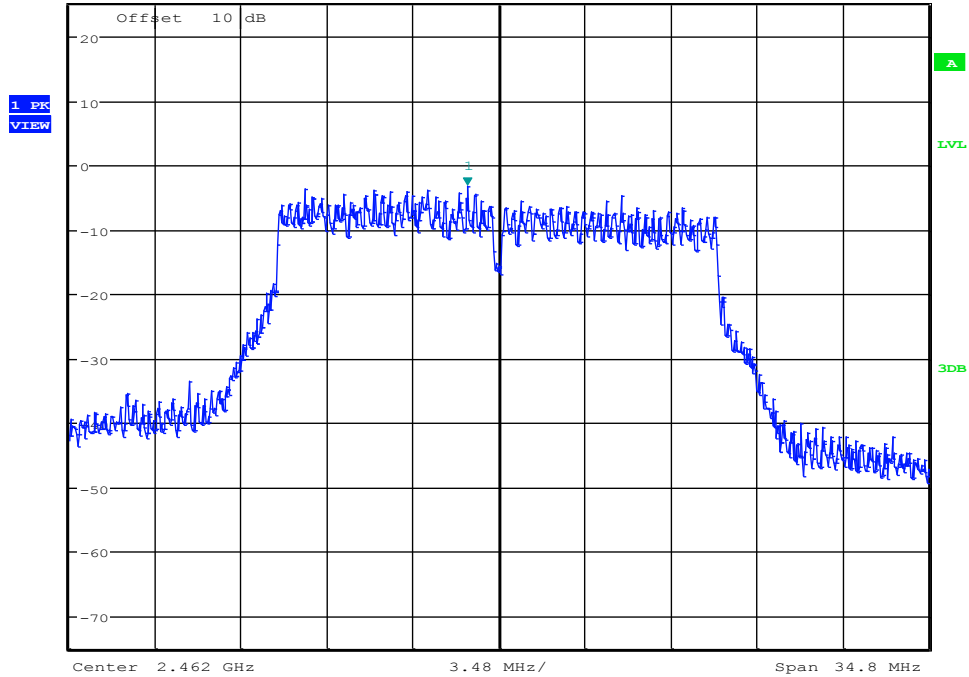

Date: 13.OCT.2017 18:40:08

Maximum Peak power spectral density_11N40MIMO_2422_Ant1

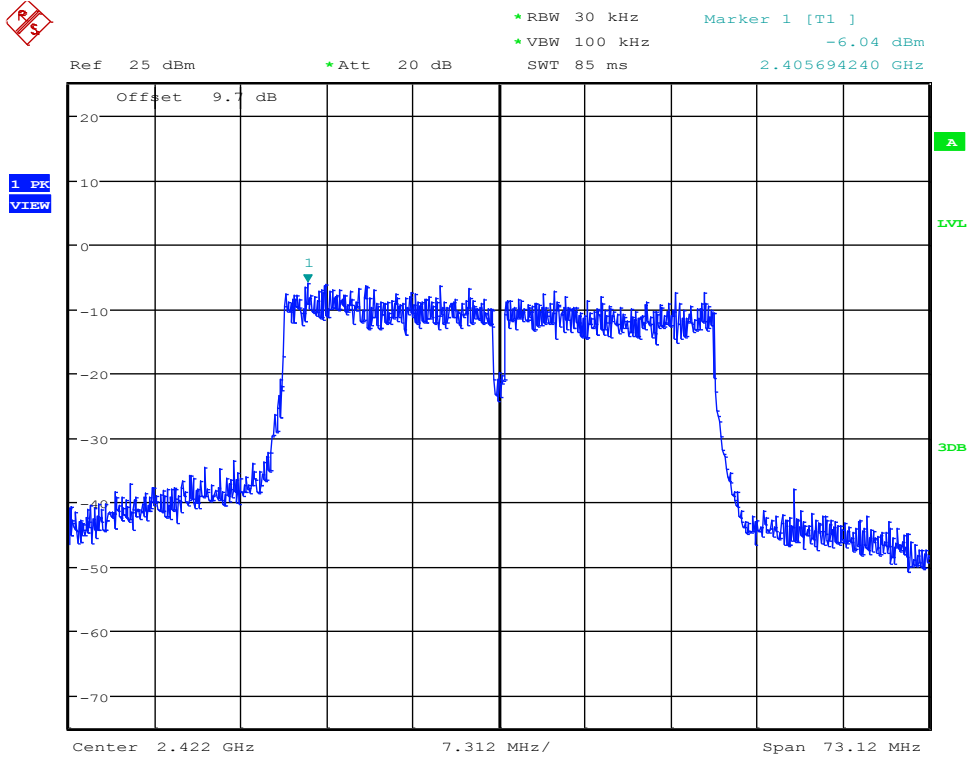

Date: 13.OCT.2017 18:43:41

Maximum Peak power spectral density_11N40MIMO_2422_Ant2

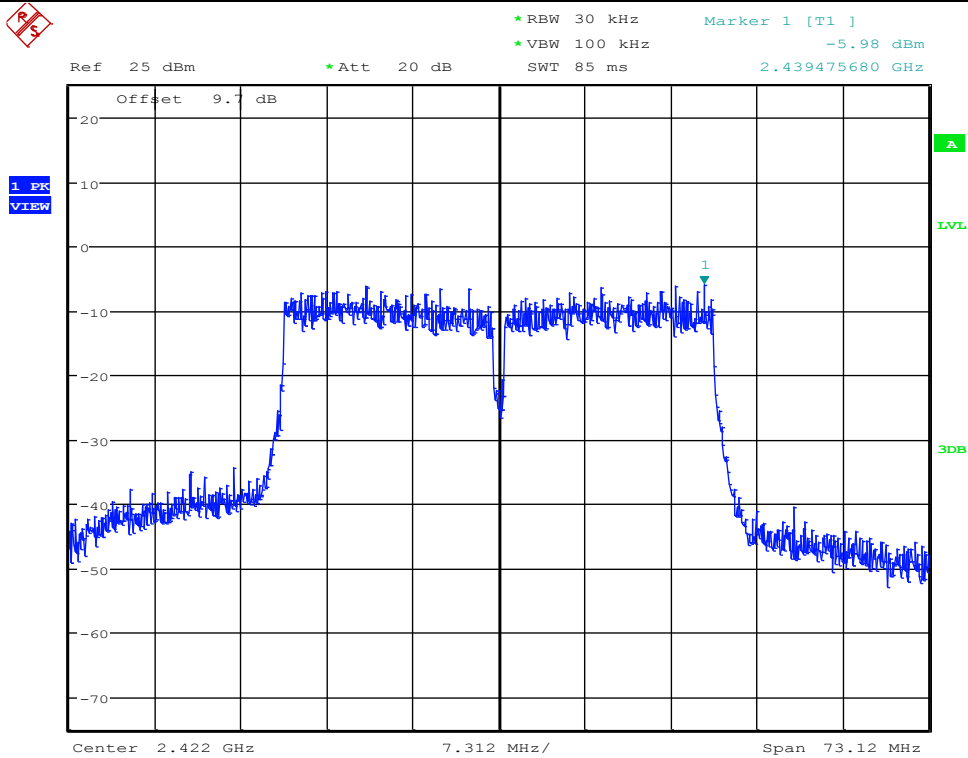

Date: 13.OCT.2017 18:46:12

Maximum Peak power spectral density_11N40MIMO_2437_Ant1

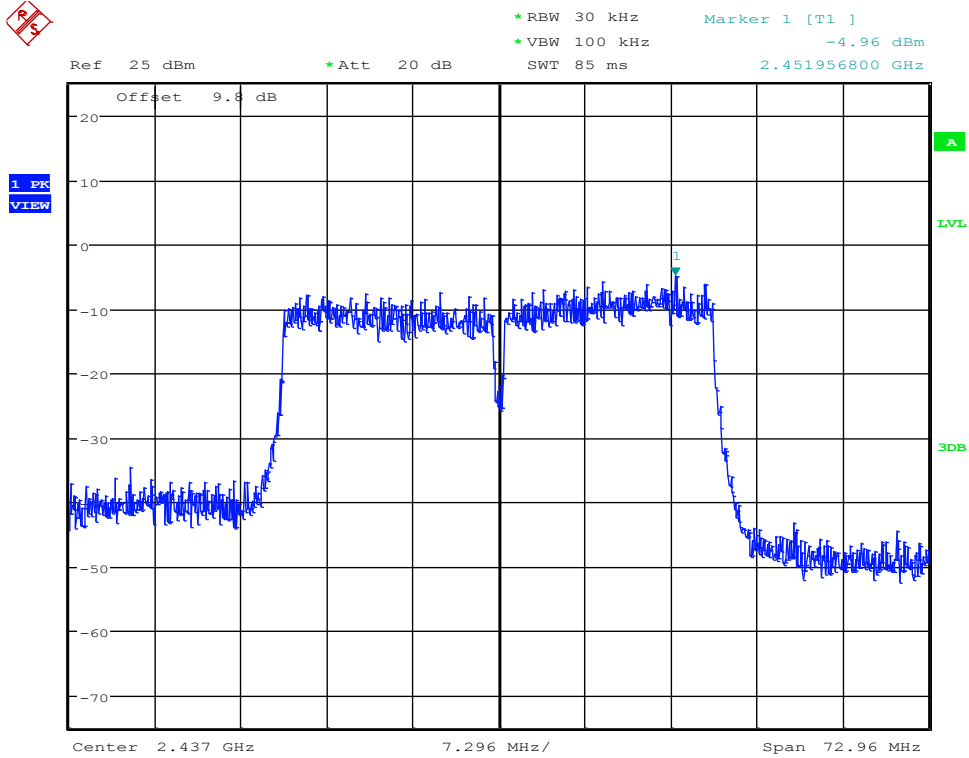

Date: 13.OCT.2017 18:49:20

Maximum Peak power spectral density_11N40MIMO_2437_Ant2

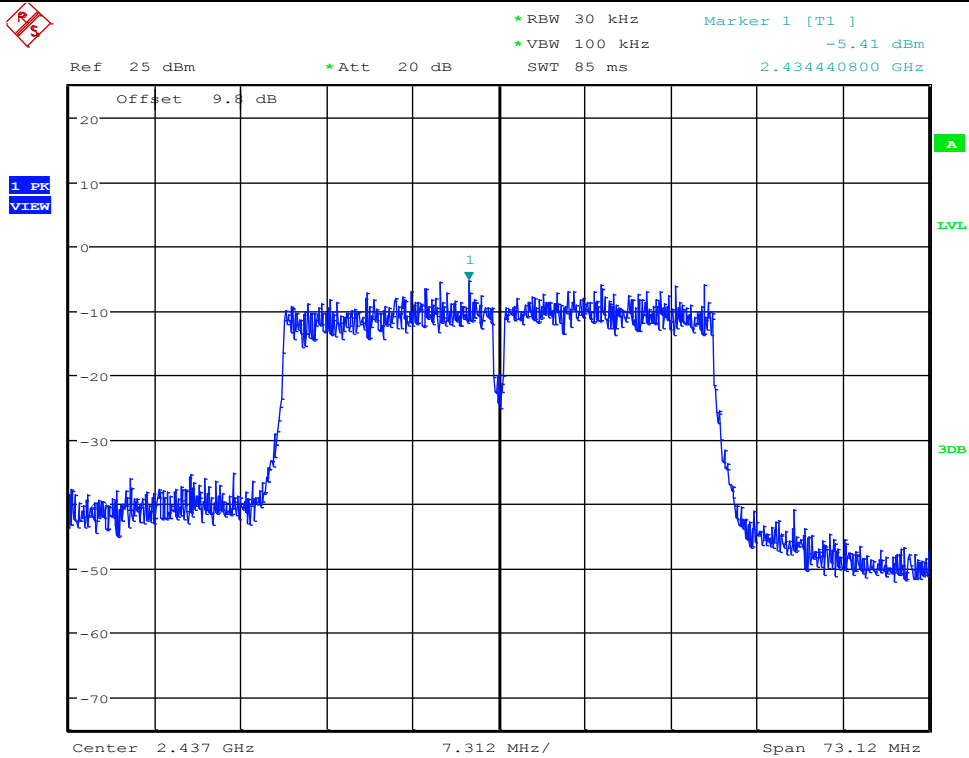

Date: 13.OCT.2017 18:50:53

Maximum Peak power spectral density_11N40MIMO_2452_Ant1

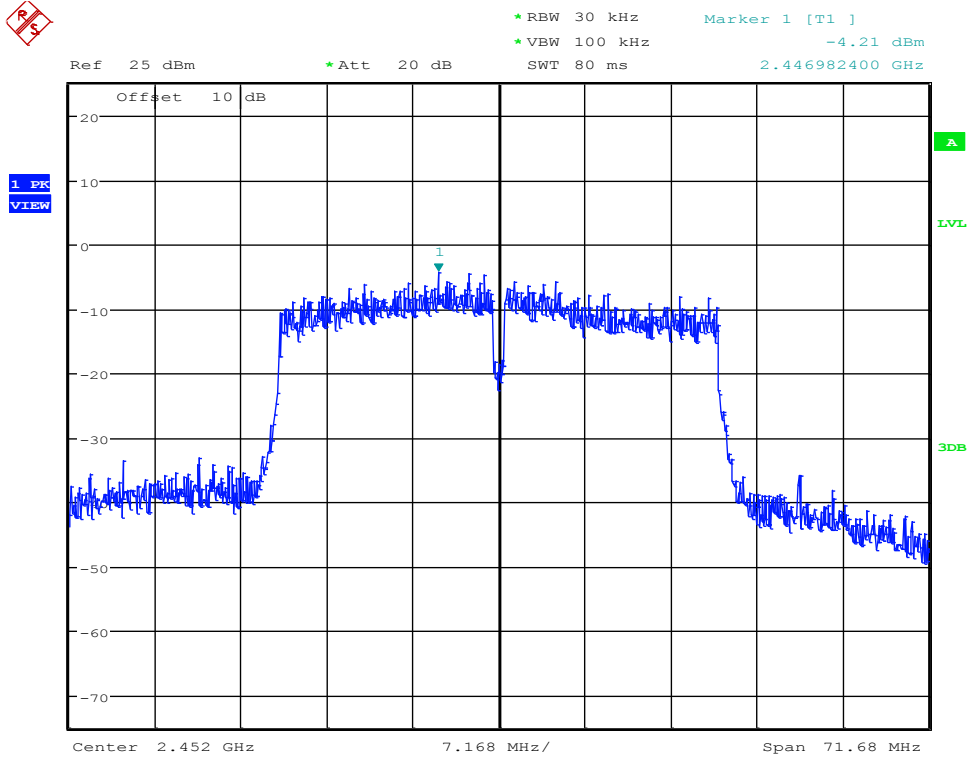

Date: 13.OCT.2017 18:53:36

Maximum Peak power spectral density_11N40MIMO_2452_Ant2

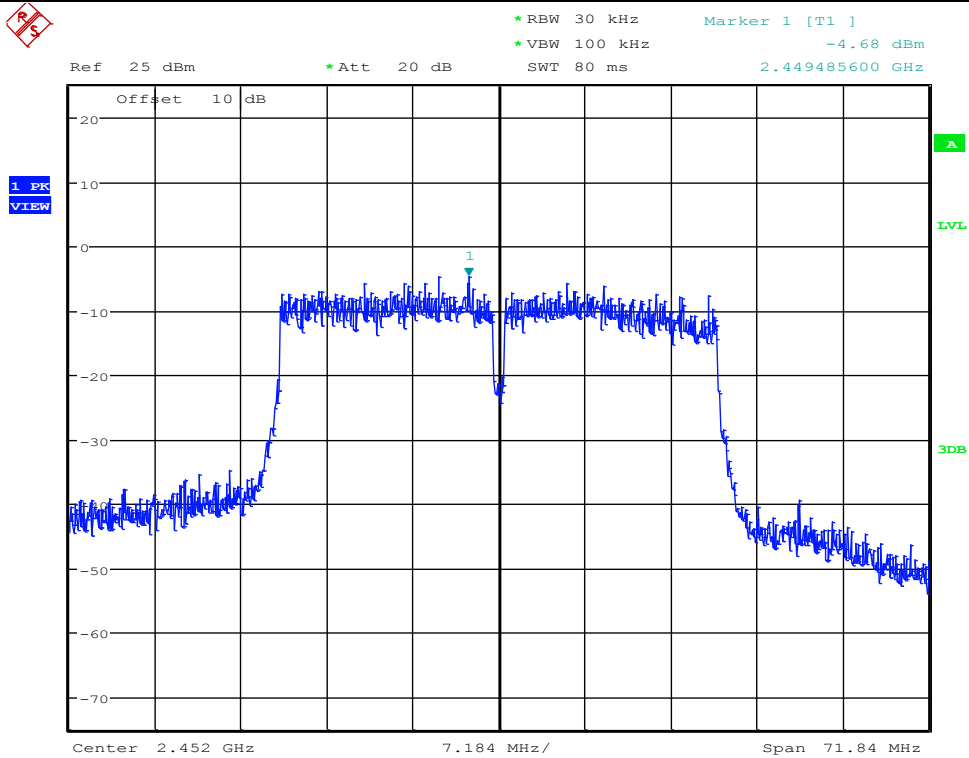

Date: 13.OCT.2017 18:56:07

Maximum Peak power spectral density_11GMIMO_2412_Ant1



Ref 25 dBm *Att 20 dB *RBW 30 kHz *VBW 100 kHz Marker 1 [T1] -3.96 dBm
SWT 40 ms 2.407042800 GHz

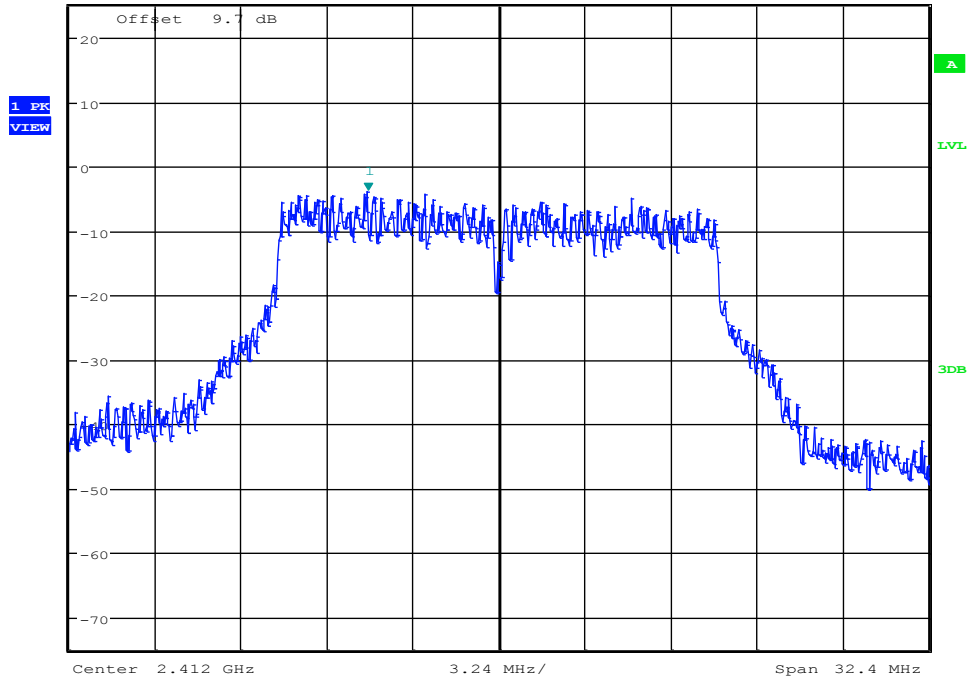

Date: 13.OCT.2017 16:50:50

Maximum Peak power spectral density_11BMIMO_2412_Ant1



Ref 25 dBm *Att 20 dB *RBW 30 kHz *VBW 100 kHz Marker 1 [T1] -0.64 dBm
SWT 30 ms 2.411415200 GHz

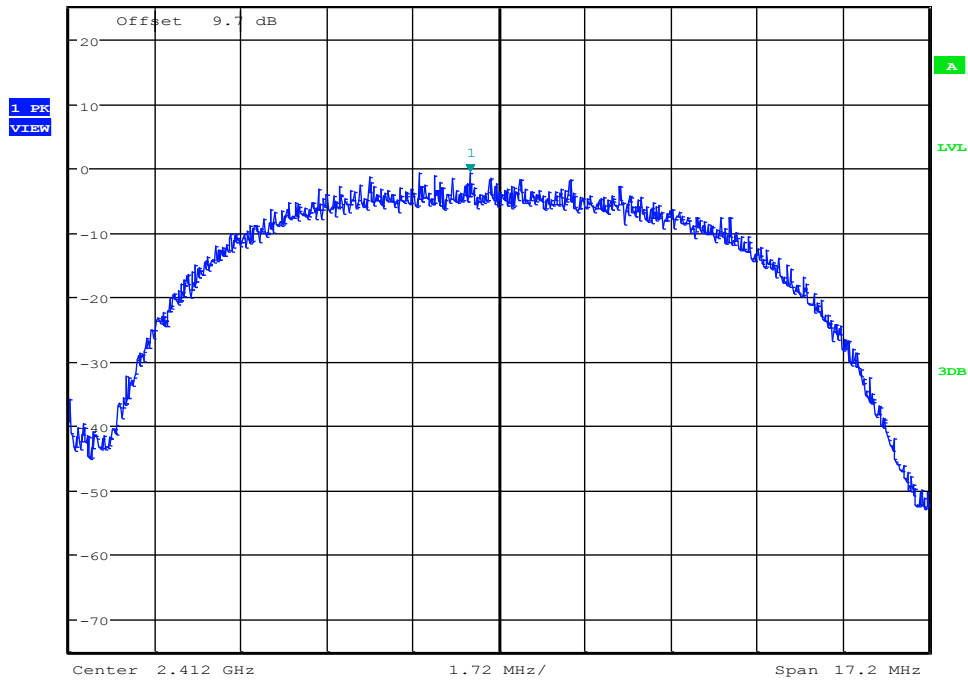

Date: 13.OCT.2017 16:29:15

Maximum Peak power spectral density_11GMIMO_2412_Ant2



Ref 25 dBm *Att 20 dB *RBW 30 kHz *VBW 100 kHz Marker 1 [T1] -4.56 dBm
SWT 40 ms 2.409501120 GHz

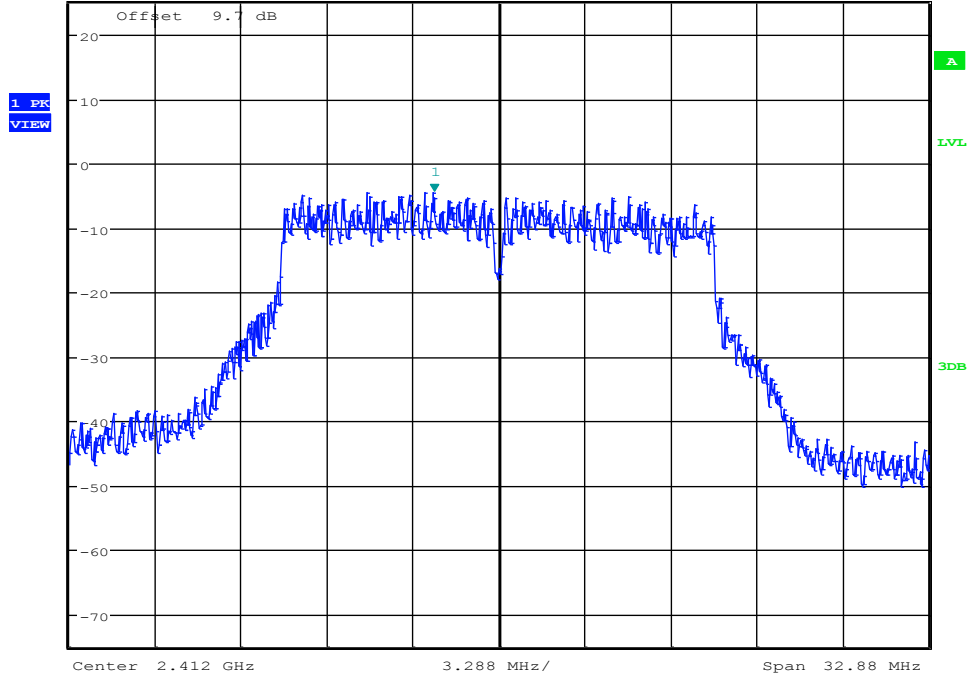

Date: 13.OCT.2017 16:53:20

Maximum Peak power spectral density_11BMIMO_2412_Ant2



Ref 25 dBm *Att 20 dB *RBW 30 kHz *VBW 100 kHz Marker 1 [T1] -0.35 dBm
SWT 30 ms 2.411415360 GHz

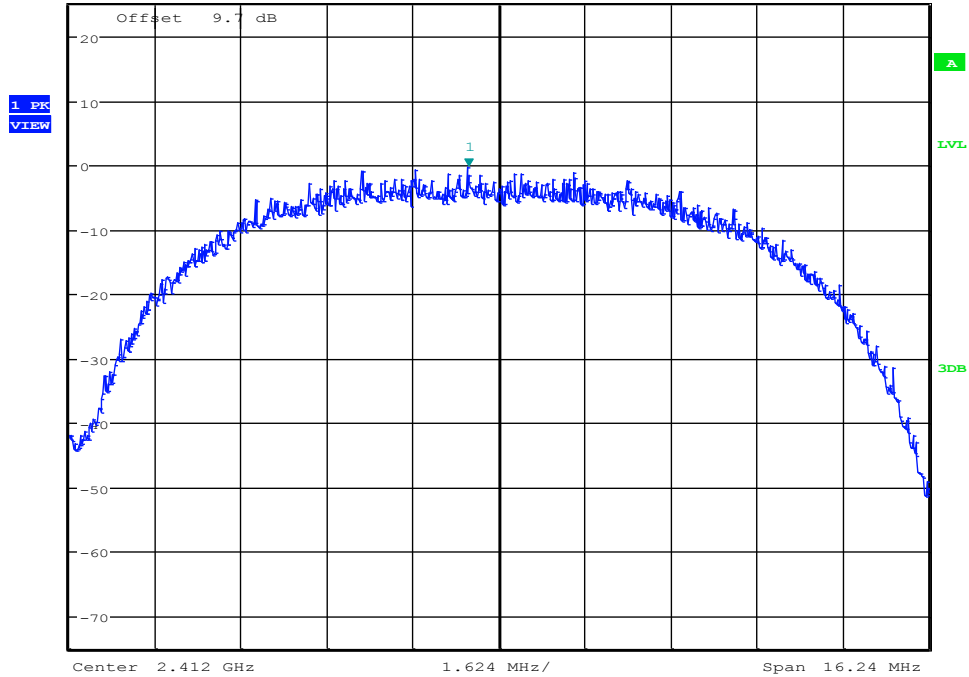

Date: 13.OCT.2017 16:31:44

Maximum Peak power spectral density_11GMIMO_2437_Ant1



Ref 25 dBm *Att 20 dB *RBW 30 kHz Marker 1 [T1] -4.19 dBm
*VBW 100 kHz SWT 40 ms 2.441964960 GHz

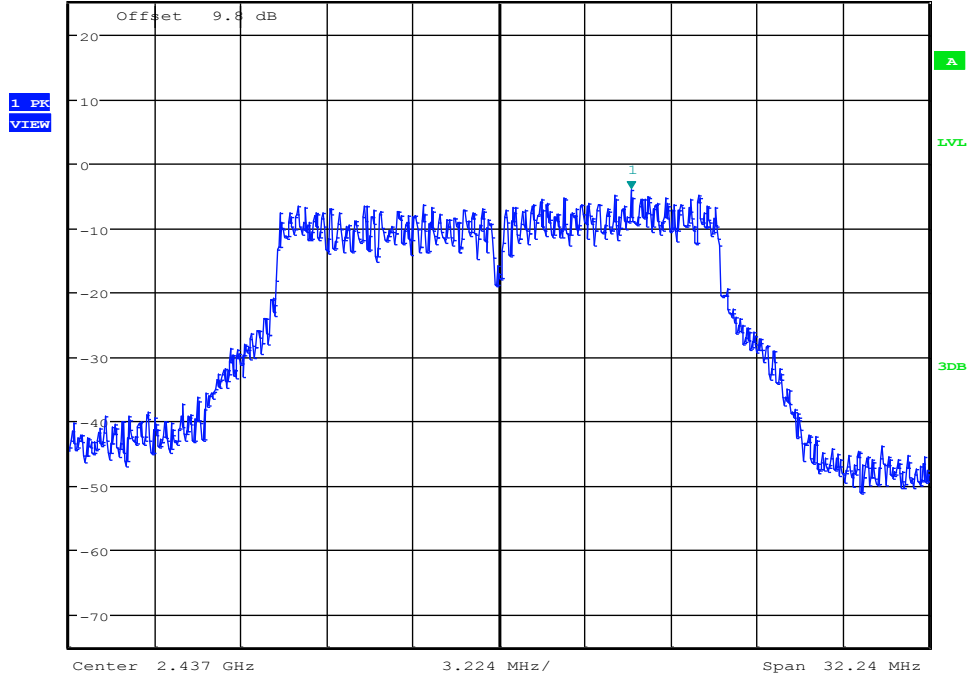

Date: 13.OCT.2017 17:00:26

Maximum Peak power spectral density_11BMIMO_2437_Ant1



Ref 25 dBm *Att 20 dB *RBW 30 kHz Marker 1 [T1] -2.21 dBm
*VBW 100 kHz SWT 30 ms 2.436403840 GHz

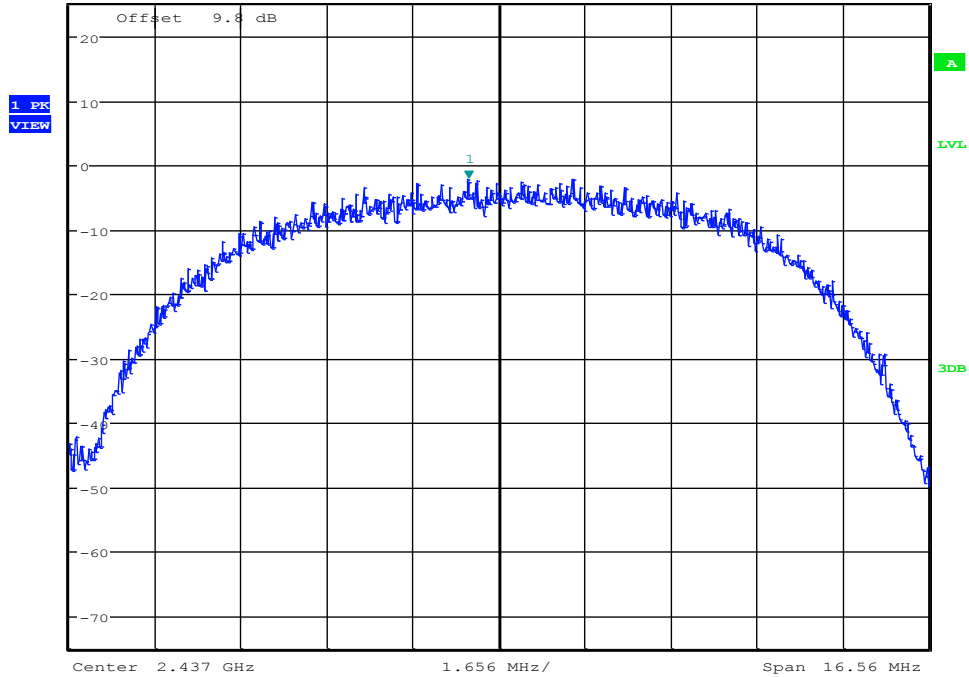

Date: 13.OCT.2017 16:39:52

Maximum Peak power spectral density_11GMIMO_2437_Ant2



*RBW 30 kHz Marker 1 [T1]
*VBW 100 kHz -3.91 dBm
*Att 20 dB 2.441989040 GHz
SWT 40 ms

Ref 25 dBm Offset 9.8 dB

1 PK
VIEW

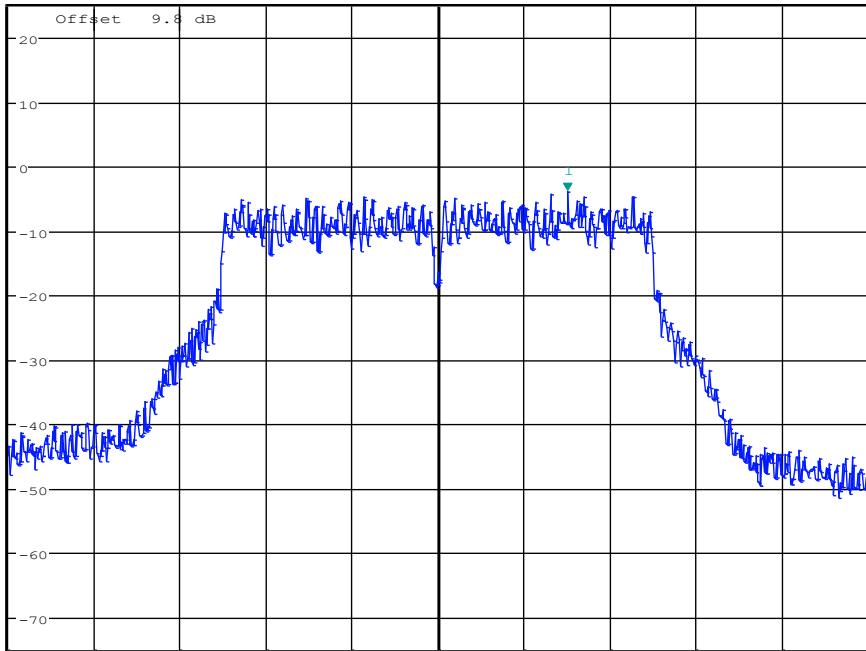

Center 2.437 GHz 3.304 MHz/ Span 33.04 MHz

Date: 13.OCT.2017 17:01:59

Maximum Peak power spectral density_11BMIMO_2437_Ant2



*RBW 30 kHz Marker 1 [T1]
*VBW 100 kHz -0.66 dBm
*Att 20 dB 2.436419680 GHz
SWT 30 ms

Ref 25 dBm Offset 9.8 dB

1 PK
VIEW

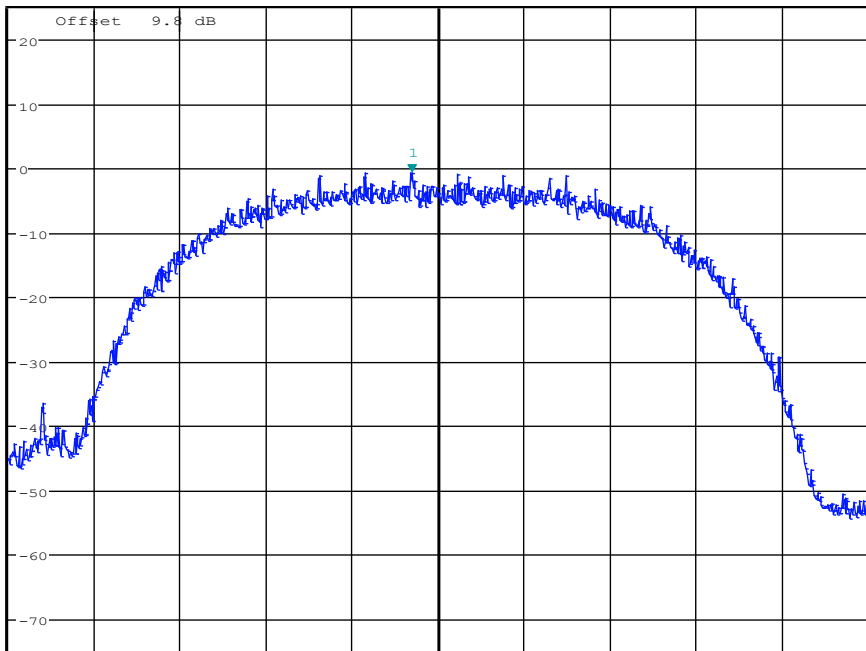

Center 2.437 GHz 1.872 MHz/ Span 18.72 MHz

Date: 13.OCT.2017 16:41:24

Maximum Peak power spectral density_11GMIMO_2462_Ant1



Ref 25 dBm *Att 20 dB *RBW 30 kHz Marker 1 [T1] -3.77 dBm
*VBW 100 kHz SWT 40 ms 2.454455840 GHz

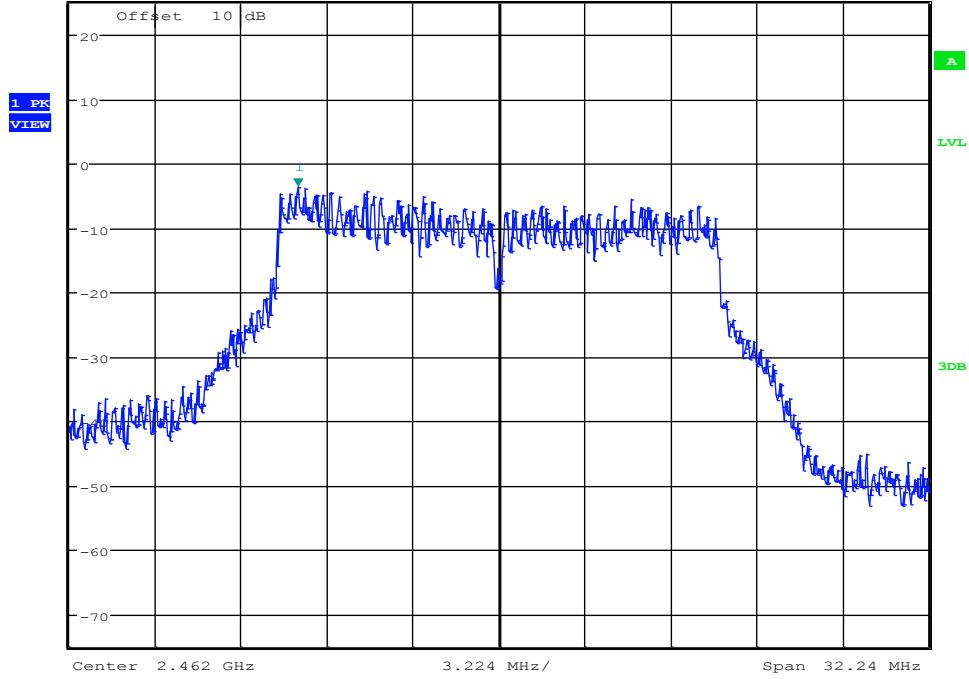

Date: 13.OCT.2017 17:41:13

Maximum Peak power spectral density_11BMIMO_2462_Ant1



Ref 25 dBm *Att 20 dB *RBW 30 kHz Marker 1 [T1] -1.62 dBm
*VBW 100 kHz SWT 30 ms 2.461412240 GHz

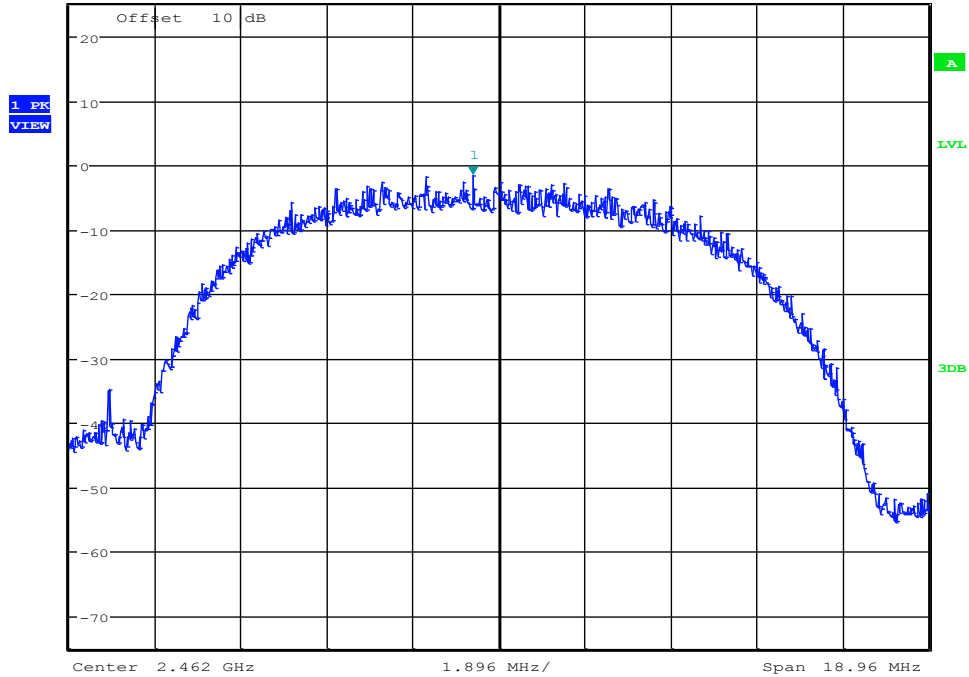

Date: 13.OCT.2017 16:43:57

Maximum Peak power spectral density_11BMIMO_2462_Ant2



Ref 25 dBm *Att 20 dB *RBW 30 kHz Marker 1 [T1]
*VBW 100 kHz -0.61 dBm
SWT 30 ms 2.459412800 GHz

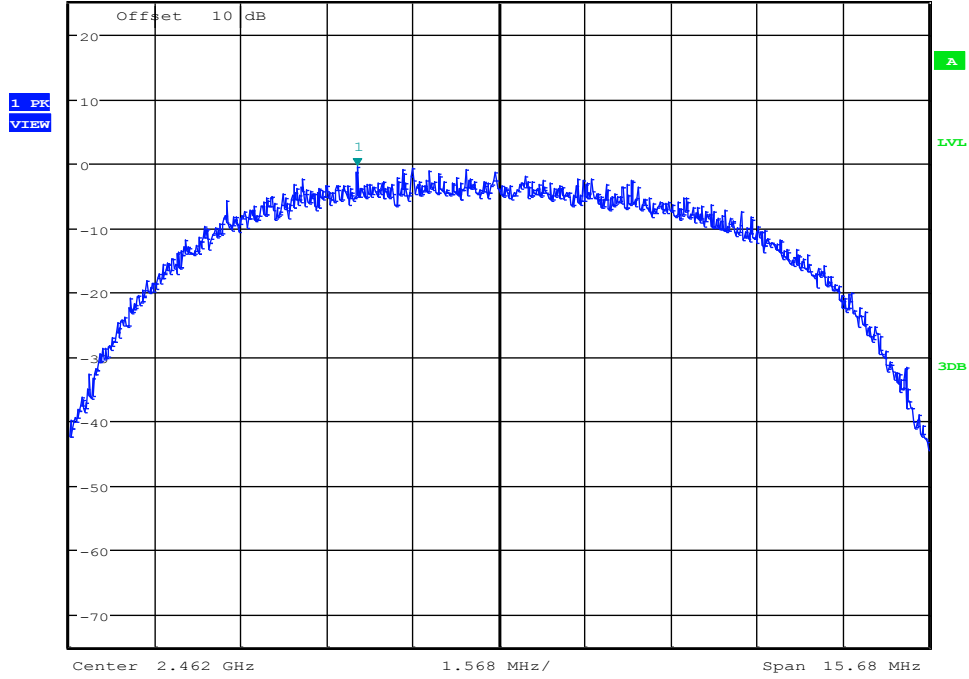

Date: 13.OCT.2017 16:46:26

Maximum Peak power spectral density_11GMIMO_2462_Ant2



Ref 25 dBm *Att 20 dB *RBW 30 kHz Marker 1 [T1]
*VBW 100 kHz -3.97 dBm
SWT 40 ms 2.459181200 GHz

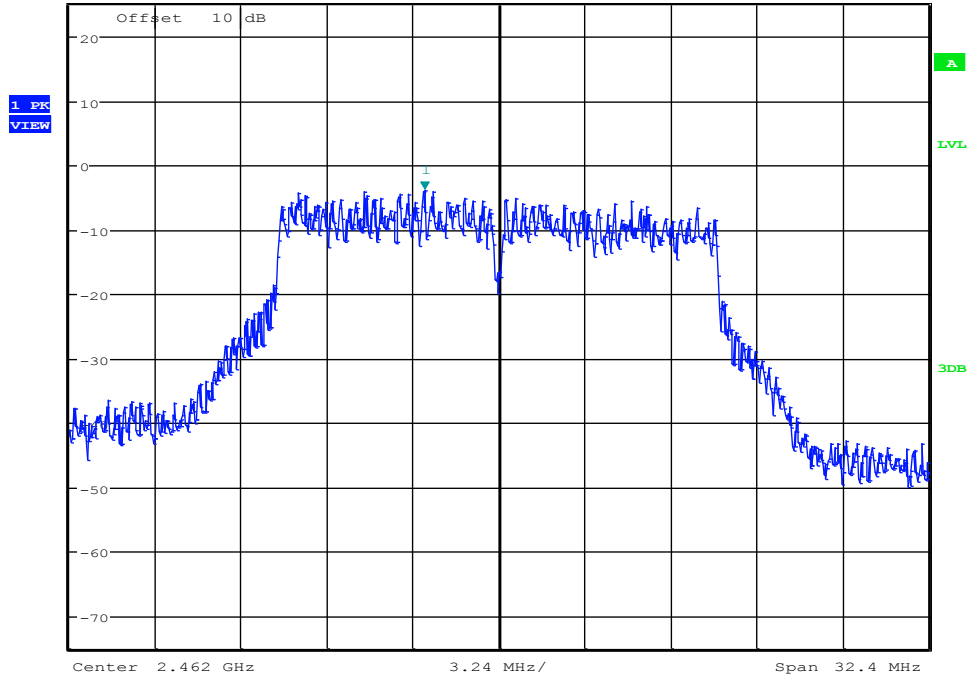

Date: 13.OCT.2017 17:43:44

6.6. Band Edge and Spurious Emissions (Conducted)

6.7. Block diagram of test setup

Same as section 4.1

6.8. Limits

In any 100kHz bandwidth outside the frequency bands in which the spread spectrum intentional radiator is operating, the radio frequency power that is produced by the intentional radiator shall be at least 30dB below that in the 100kHz bandwidth within the band that contains the highest level of the desired power.

6.9. Test Procedure

- (1) Connect EUT's antenna output to spectrum analyzer by RF cable.
- (2) Establish a reference level by using the following procedure:

Center frequency	DTS Channel center frequency
RBW:	100KHz
VBW:	300KHz
Span	1.5times the DTS bandwidth
Detector Mode:	Peak
Sweep time:	auto
Trace mode	Max hold
- (3) Allow the trace to stabilize, use the peak marker function to determine the maximum peak power level to establish the reference level.
- (4) Set the spectrum analyzer as follows:

RBW:	100KHz
VBW:	300KHz
Span	Encompass frequency range to be measured
Number of measurement points	$\geq \text{span/RBW}$
Detector Mode:	Peak
Sweep time:	auto
Trace mode	Max hold
- (5) Allow the trace to stabilize, use the peak marker function to determine the maximum amplitude of all unwanted emissions outside of the authorized frequency band

6.10. Test Result

EUT Set Mode	CH or Frequency	Ant1 Result (dBm)	EUT Set Mode	CH or Frequency	Ant1 Result (dBm)
11BMIMO	CH1	PASS	11N20 MIMO	CH1	PASS
	CH6	PASS		CH6	PASS
	CH11	PASS		CH11	PASS
11GMIMO	CH1	PASS	11N40MIMO	CH3	PASS
	CH6	PASS		CH6	PASS
	CH11	PASS		CH9	PASS

EUT Set Mode	CH or Frequency	Ant2 Result (dBm)	EUT Set Mode	CH or Frequency	Ant2 Result (dBm)
11BMIMO	CH1	PASS	11N20 MIMO	CH1	PASS
	CH6	PASS		CH6	PASS
	CH11	PASS		CH11	PASS
11GMIMO	CH1	PASS	11N40MIMO	CH3	PASS
	CH6	PASS		CH6	PASS
	CH11	PASS		CH9	PASS

6.11. original test data

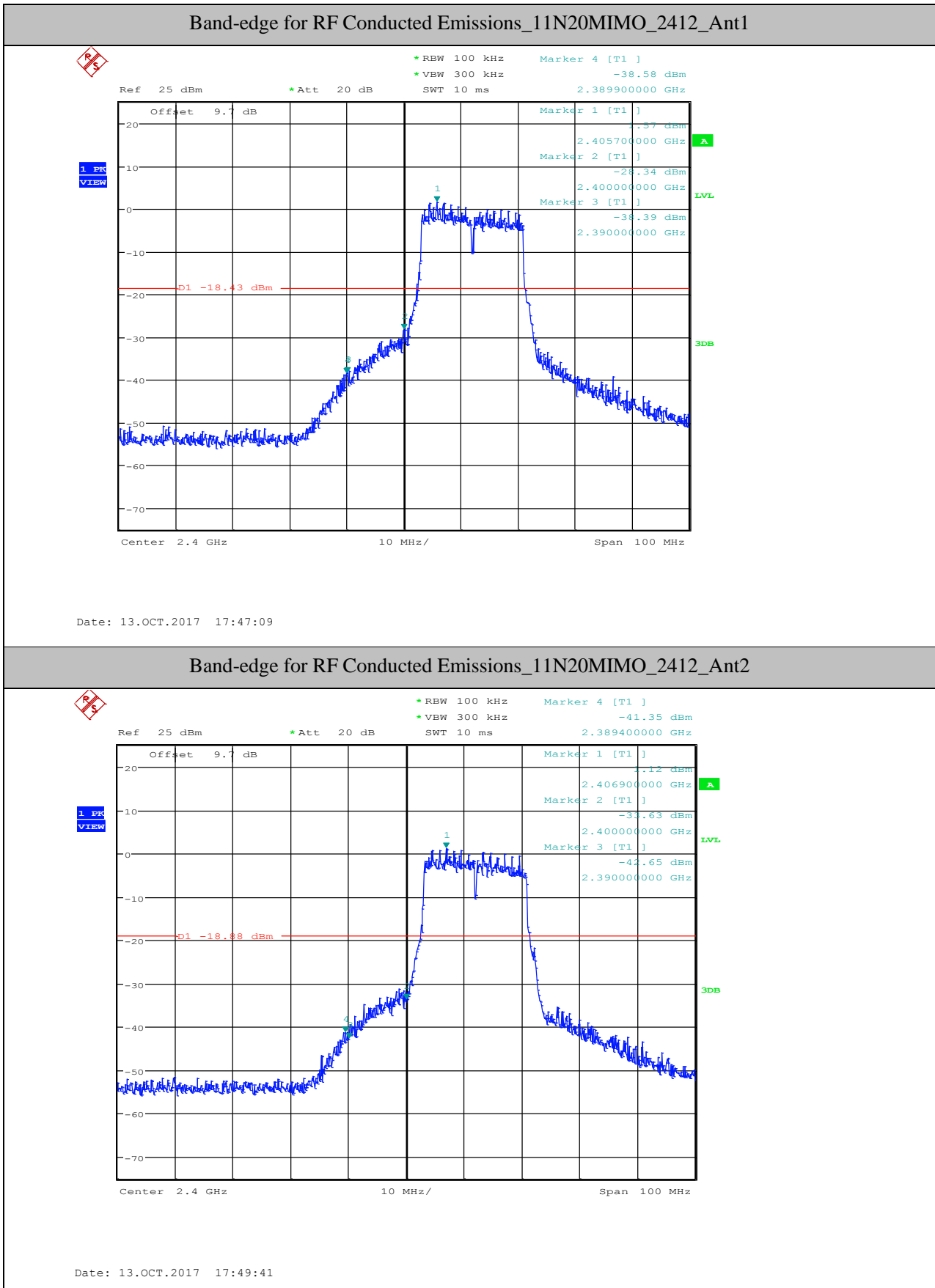

Band-edge for RF Conducted Emissions_11N20MIMO_2462_Ant1



Ref 25 dBm *Att 20 dB *RBW 100 kHz *VBW 300 kHz SWT 10 ms Marker 4 [T1] -43.24 dBm 2.484800000 GHz

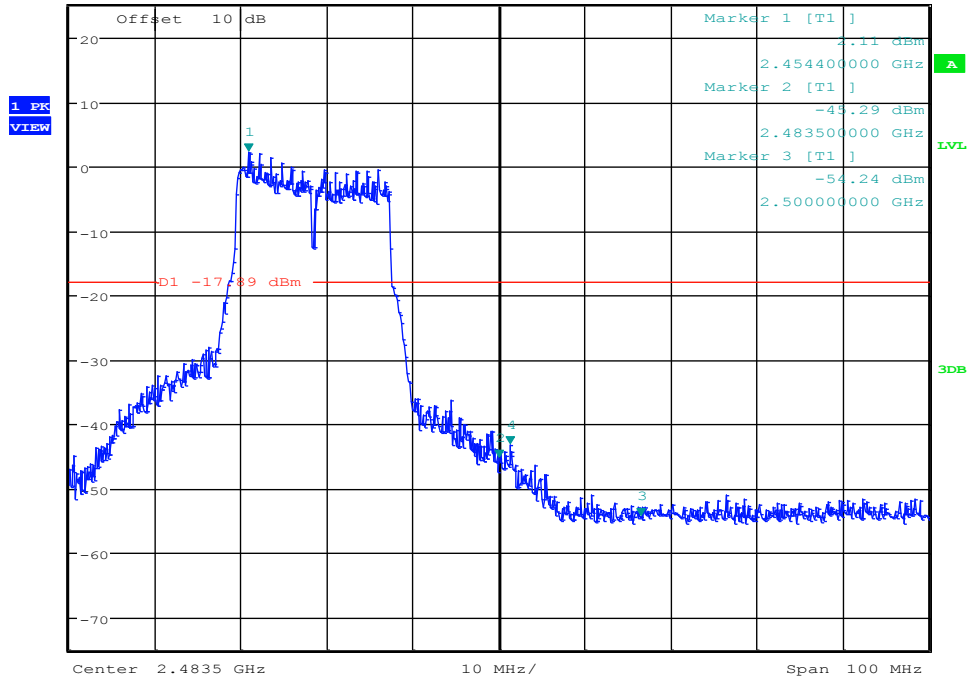

Date: 13.OCT.2017 18:37:53

Band-edge for RF Conducted Emissions_11N20MIMO_2462_Ant2



Ref 25 dBm *Att 20 dB *RBW 100 kHz *VBW 300 kHz SWT 10 ms Marker 4 [T1] -40.92 dBm 2.484200000 GHz

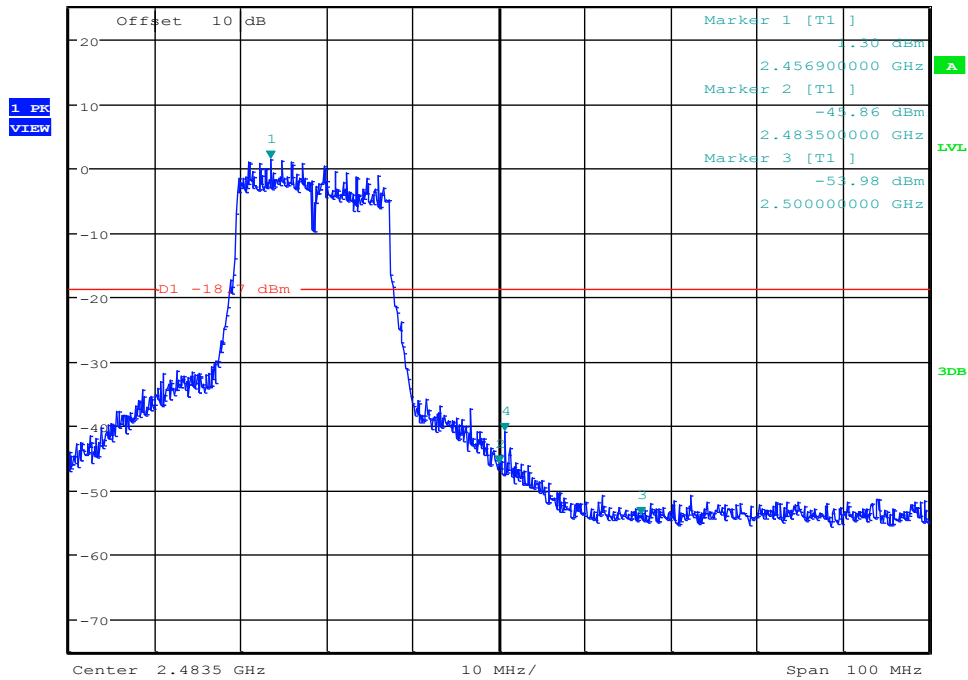

Date: 13.OCT.2017 18:40:25

Band-edge for RF Conducted Emissions_11N40MIMO_2422_Ant1

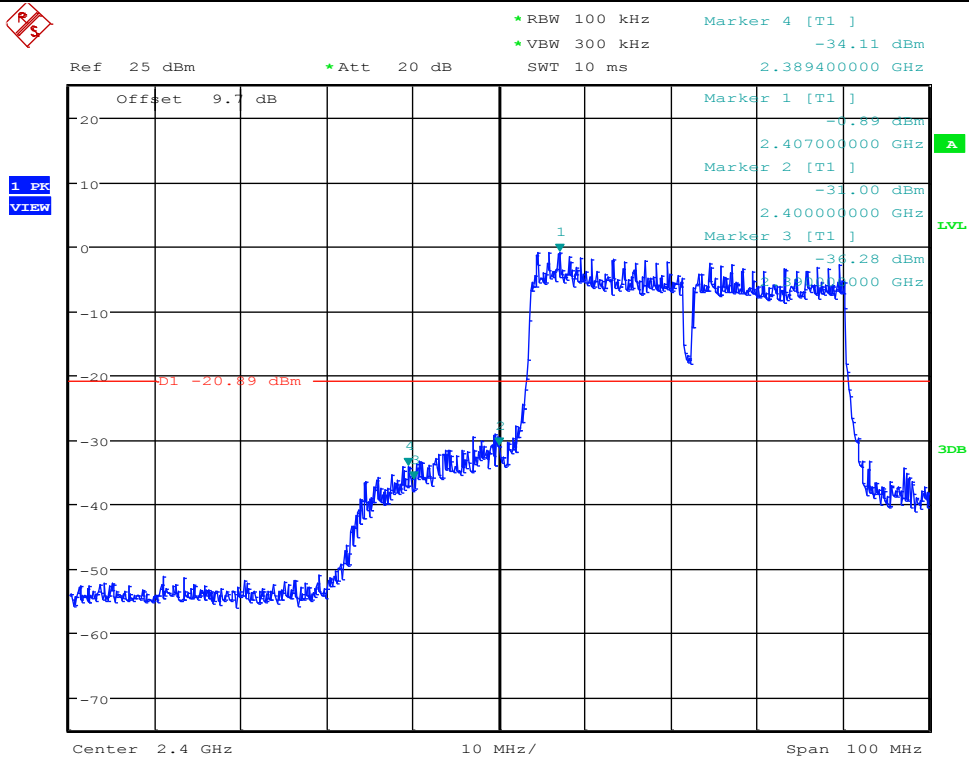

Date: 13.OCT.2017 18:43:57

Band-edge for RF Conducted Emissions_11N40MIMO_2422_Ant2

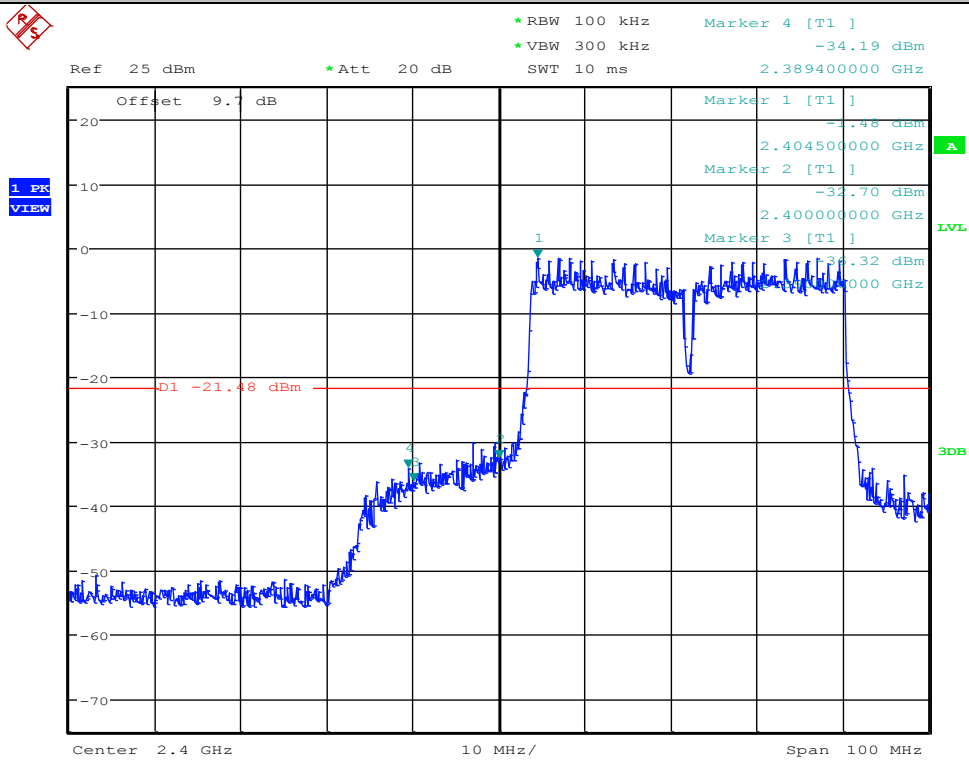

Date: 13.OCT.2017 18:46:29

Band-edge for RF Conducted Emissions_11N40MIMO_2452_Ant1

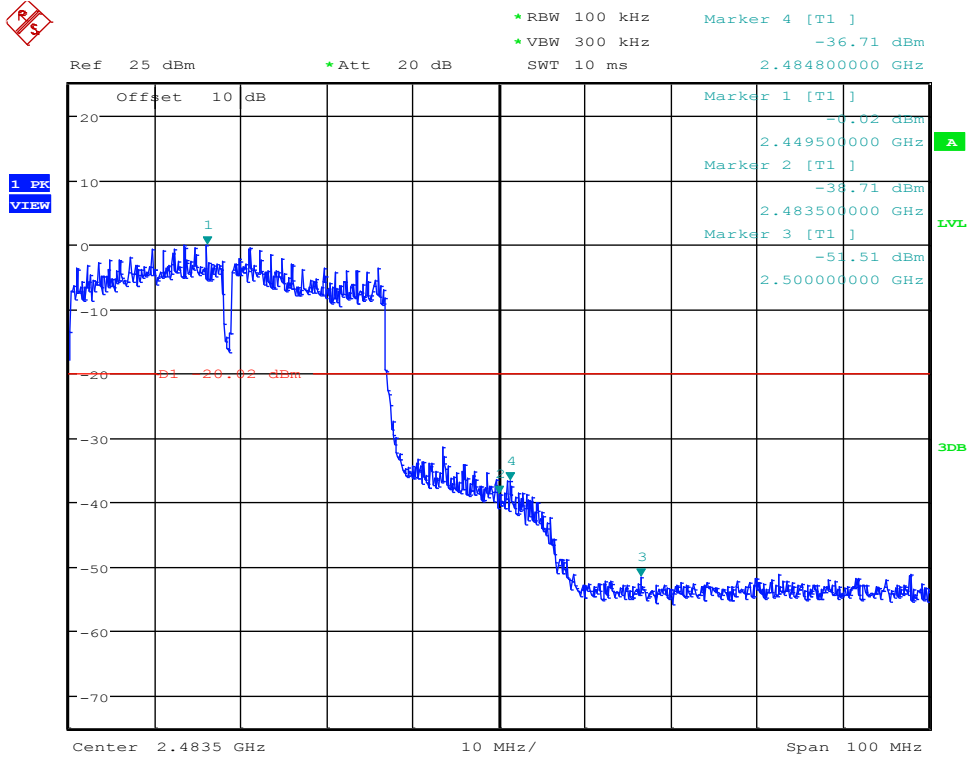

Date: 13.OCT.2017 18:53:52

Band-edge for RF Conducted Emissions_11N40MIMO_2452_Ant2

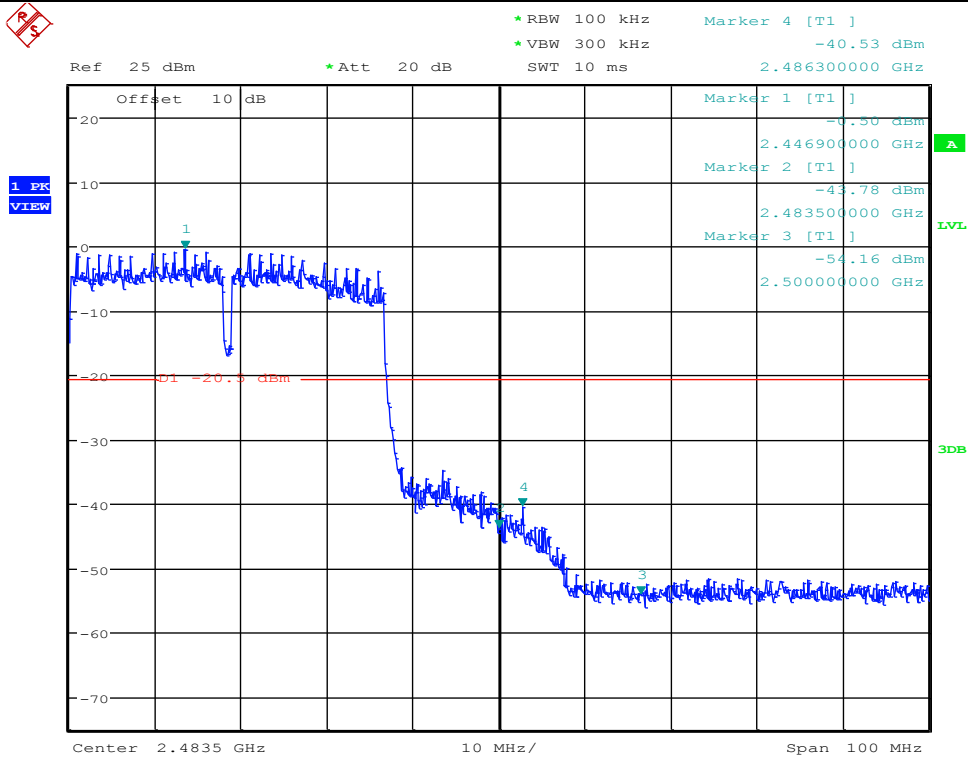

Date: 13.OCT.2017 18:56:24

Band-edge for RF Conducted Emissions_11BMIMO_2412_Ant1

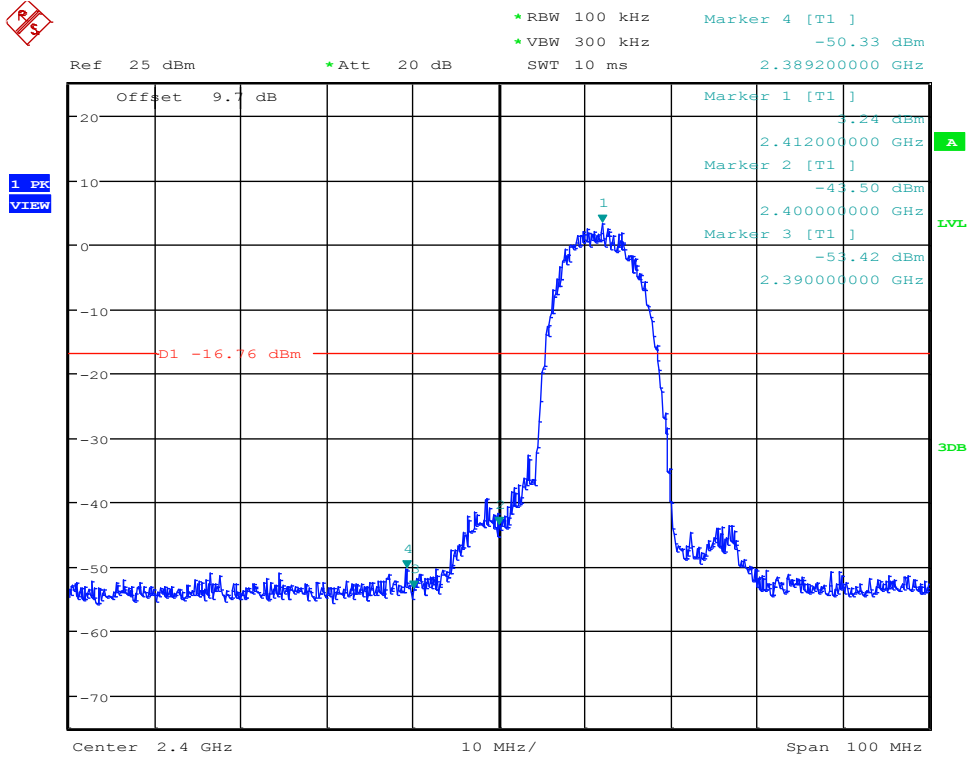

Date: 13.OCT.2017 16:29:30

Band-edge for RF Conducted Emissions_11GMIMO_2412_Ant1

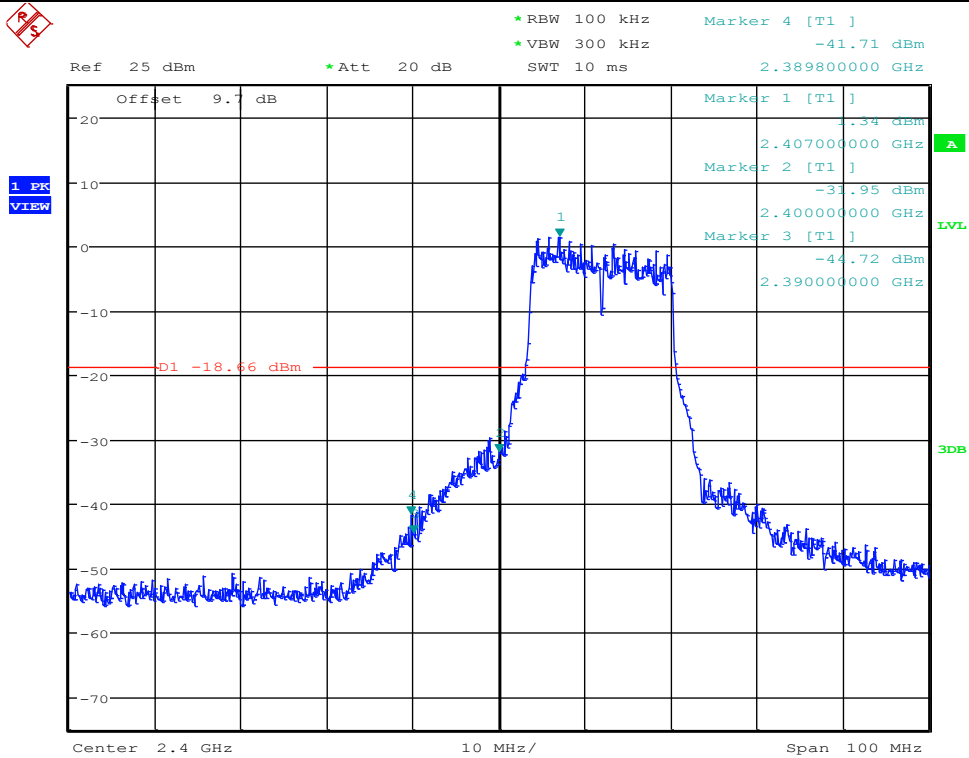

Date: 13.OCT.2017 16:51:06

Band-edge for RF Conducted Emissions_11BMIMO_2412_Ant2



Ref 25 dBm *Att 20 dB *RBW 100 kHz *VBW 300 kHz Marker 4 [T1] -50.58 dBm
 SWT 10 ms 2.387600000 GHz

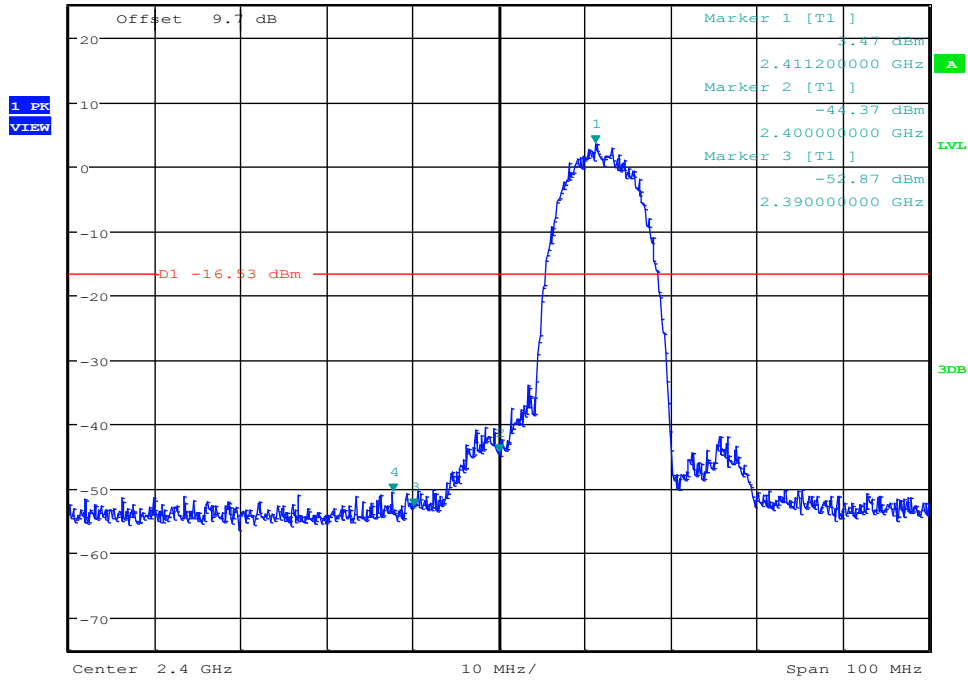

Date: 13.OCT.2017 16:32:01

Band-edge for RF Conducted Emissions_11GMIMO_2412_Ant2



Ref 25 dBm *Att 20 dB *RBW 100 kHz *VBW 300 kHz Marker 4 [T1] -43.72 dBm
 SWT 10 ms 2.389800000 GHz

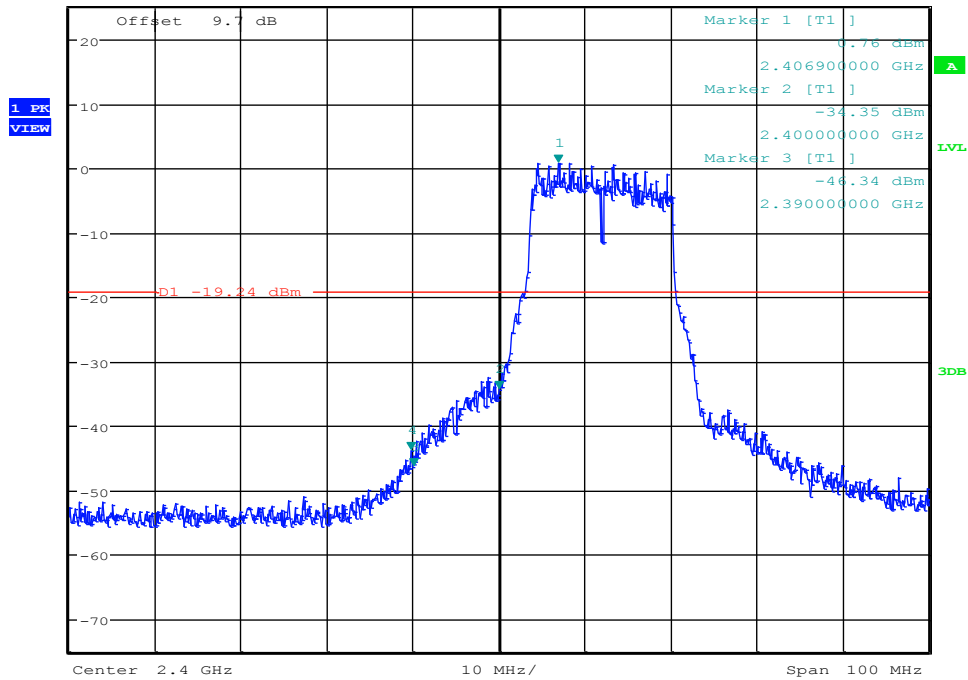

Date: 13.OCT.2017 16:53:36

Band-edge for RF Conducted Emissions_11BMIMO_2462_Ant1



*RBW 100 kHz Marker 4 [T1]
 *VBW 300 kHz -50.82 dBm
 Ref 25 dBm *Att 20 dB SWT 10 ms 2.486500000 GHz

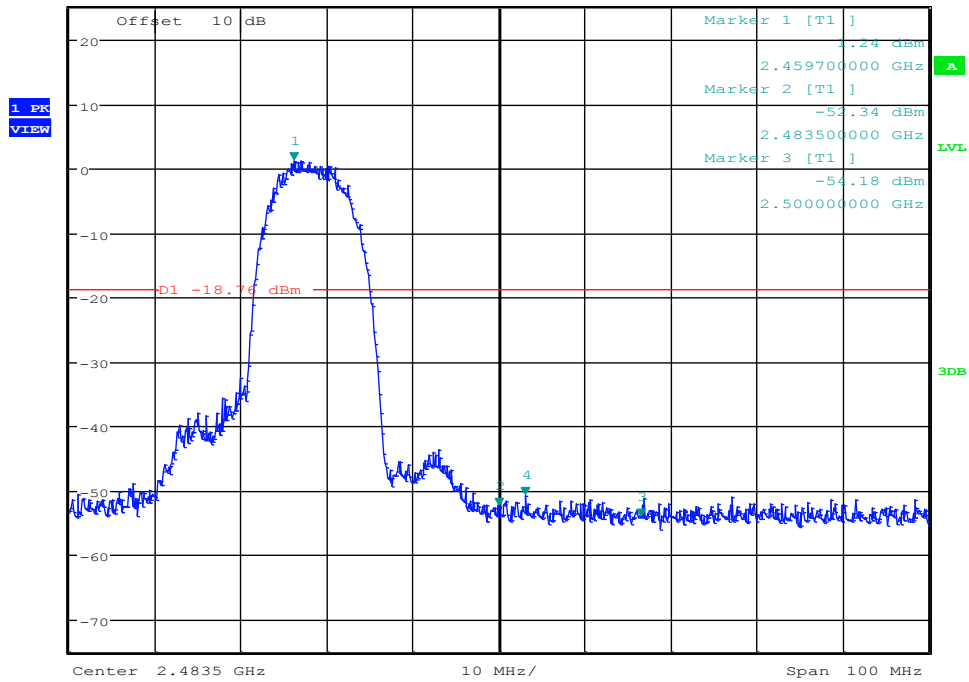

Date: 13.OCT.2017 16:44:12

Band-edge for RF Conducted Emissions_11GMIMO_2462_Ant1



*RBW 100 kHz Marker 4 [T1]
 *VBW 300 kHz -48.49 dBm
 Ref 25 dBm *Att 20 dB SWT 10 ms 2.484400000 GHz

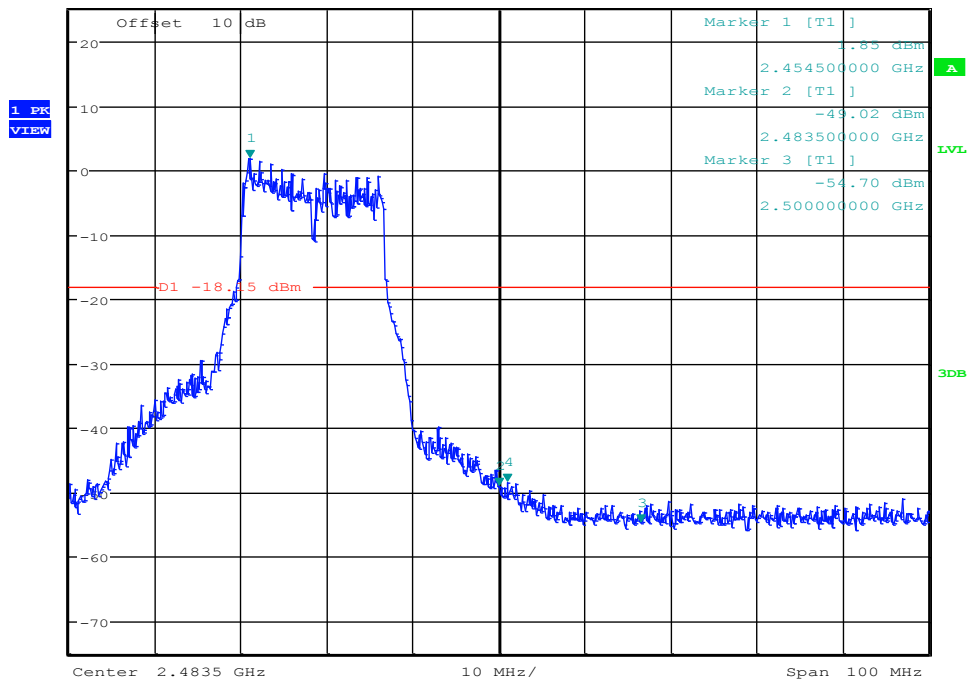

Date: 13.OCT.2017 17:41:29

Band-edge for RF Conducted Emissions_11BMIMO_2462_Ant2



*RBW 100 kHz Marker 4 [T1]
 *VBW 300 kHz -50.58 dBm
 Ref 25 dBm *Att 20 dB SWT 10 ms 2.483700000 GHz

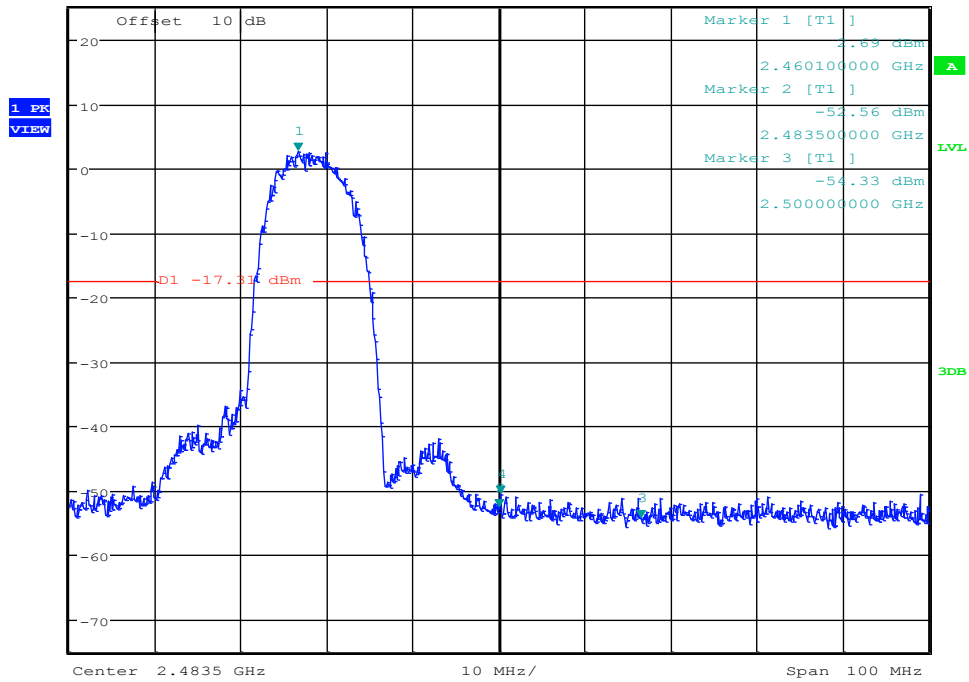

Date: 13.OCT.2017 16:46:43

Band-edge for RF Conducted Emissions_11GMIMO_2462_Ant2



*RBW 100 kHz Marker 4 [T1]
 *VBW 300 kHz -44.96 dBm
 Ref 25 dBm *Att 20 dB SWT 10 ms 2.483600000 GHz

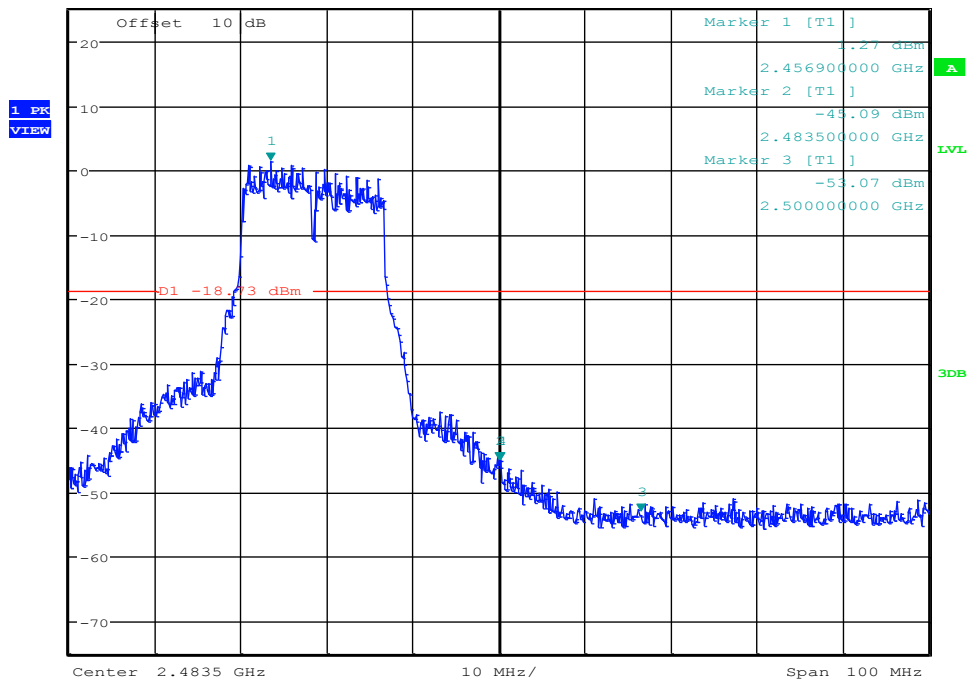

Date: 13.OCT.2017 17:44:00

RF Conducted Spurious Emissions_11N20MIMO_2412_Ant1

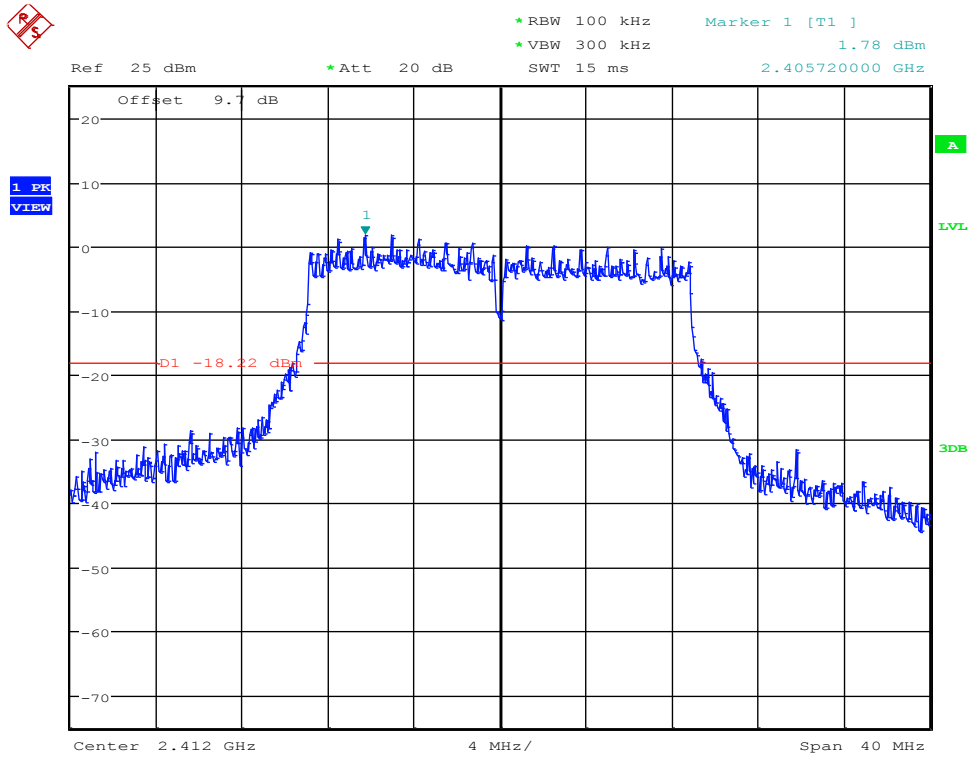

Date: 13.OCT.2017 17:47:25

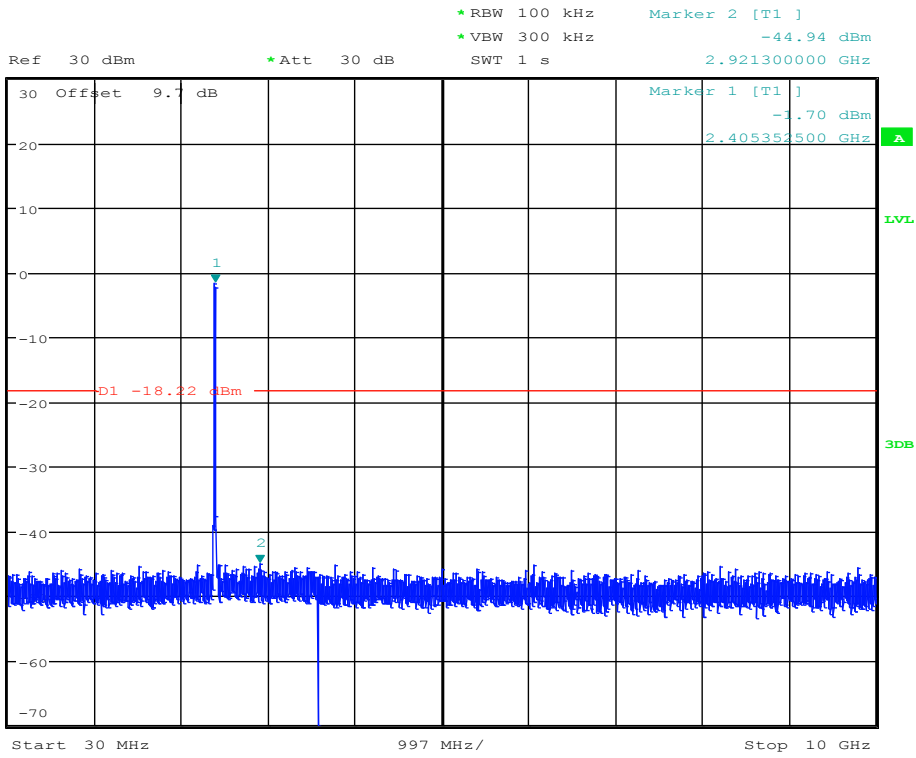

Date: 13.OCT.2017 17:47:37

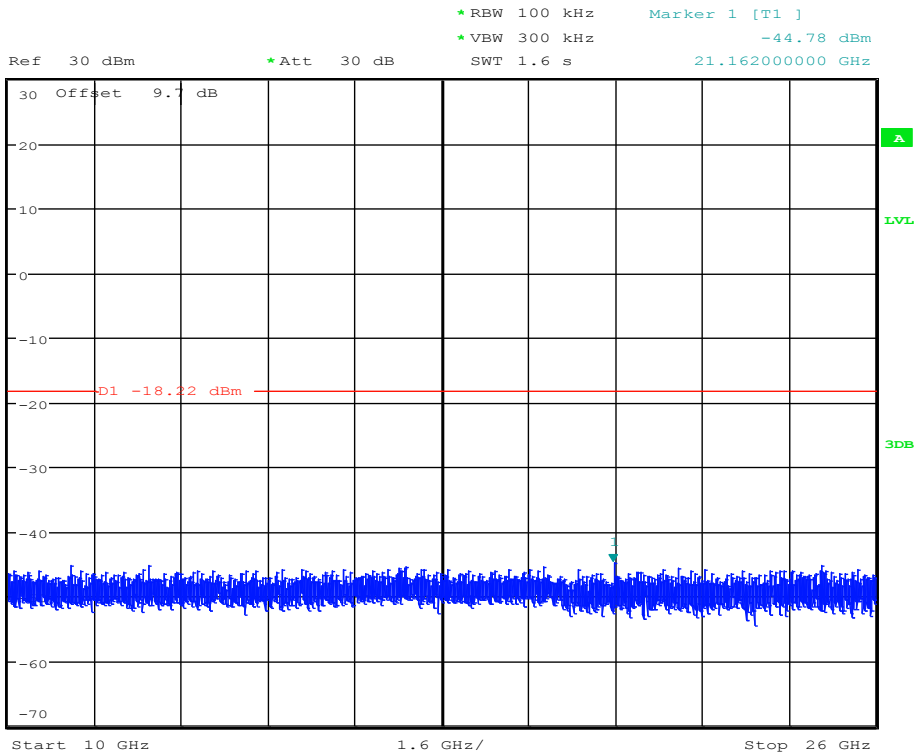

Date: 13.OCT.2017 17:47:47

RF Conducted Spurious Emissions_11N20MIMO_2412_Ant2

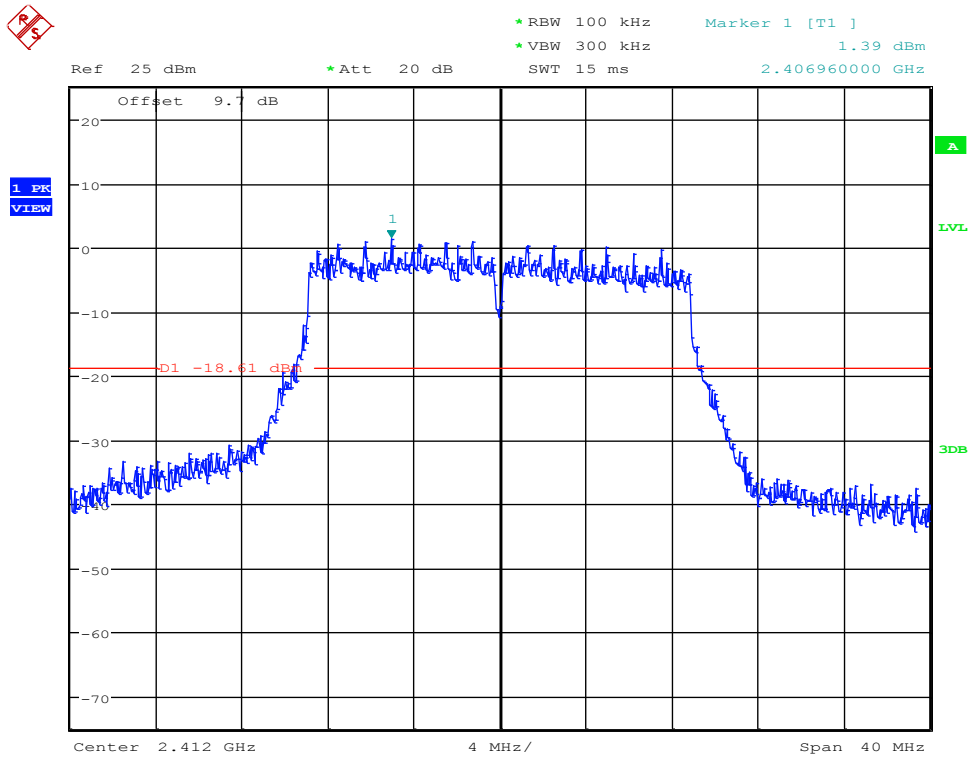

Date: 13.OCT.2017 17:49:56

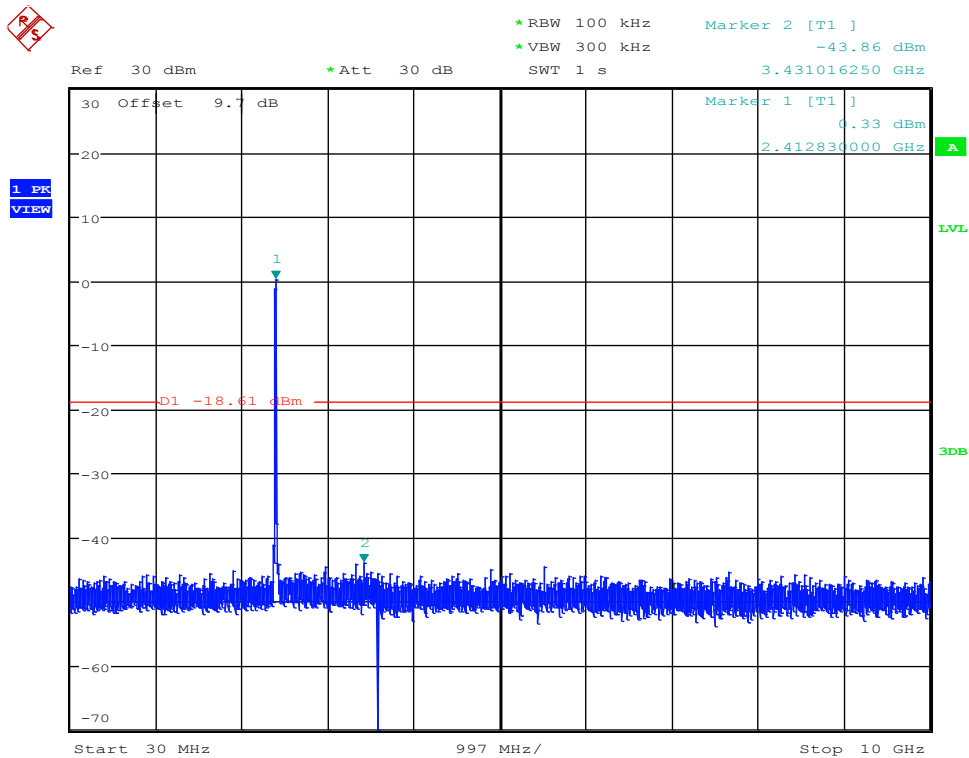

Date: 13.OCT.2017 17:50:08

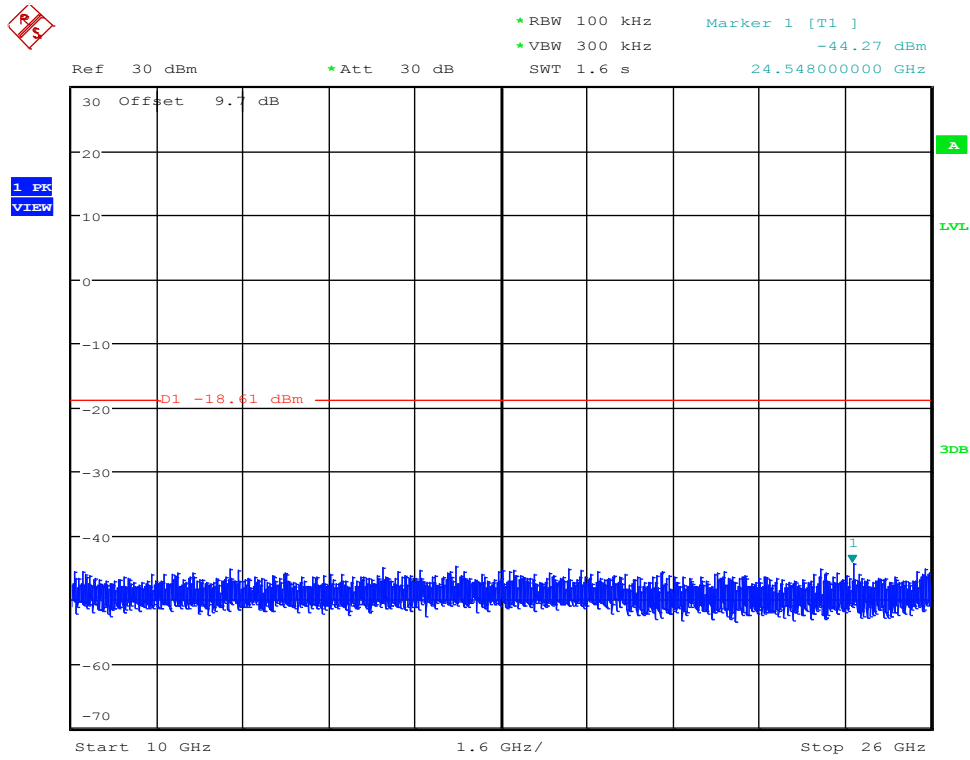

Date: 13.OCT.2017 17:50:18

RF Conducted Spurious Emissions_11N20MIMO_2462_Ant1

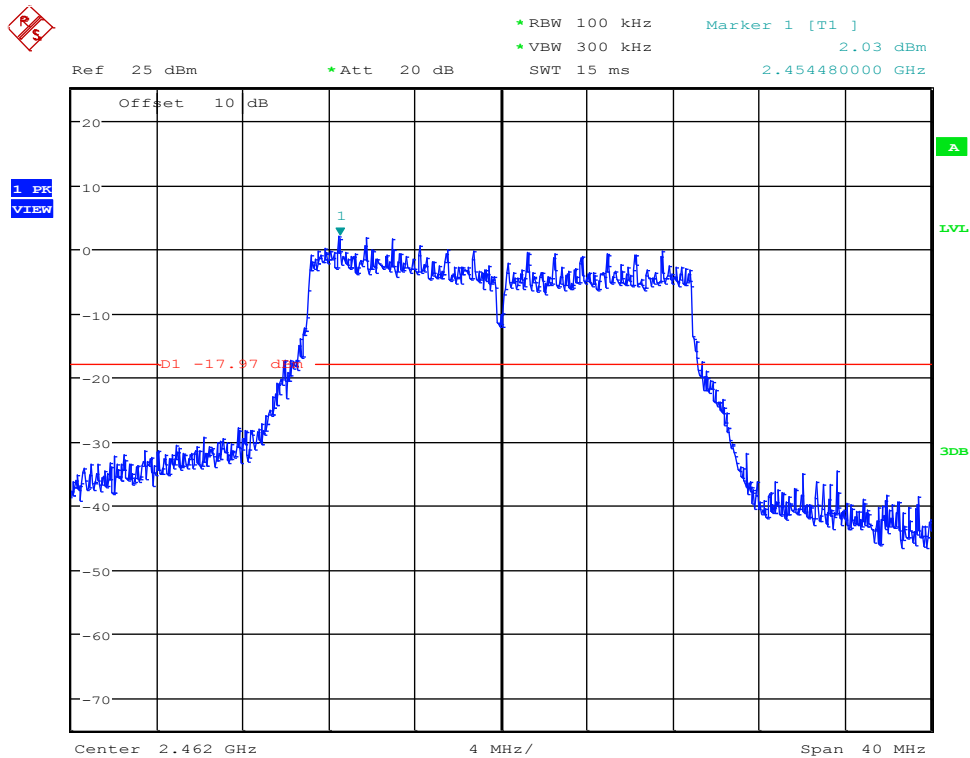

Date: 13.OCT.2017 18:38:09

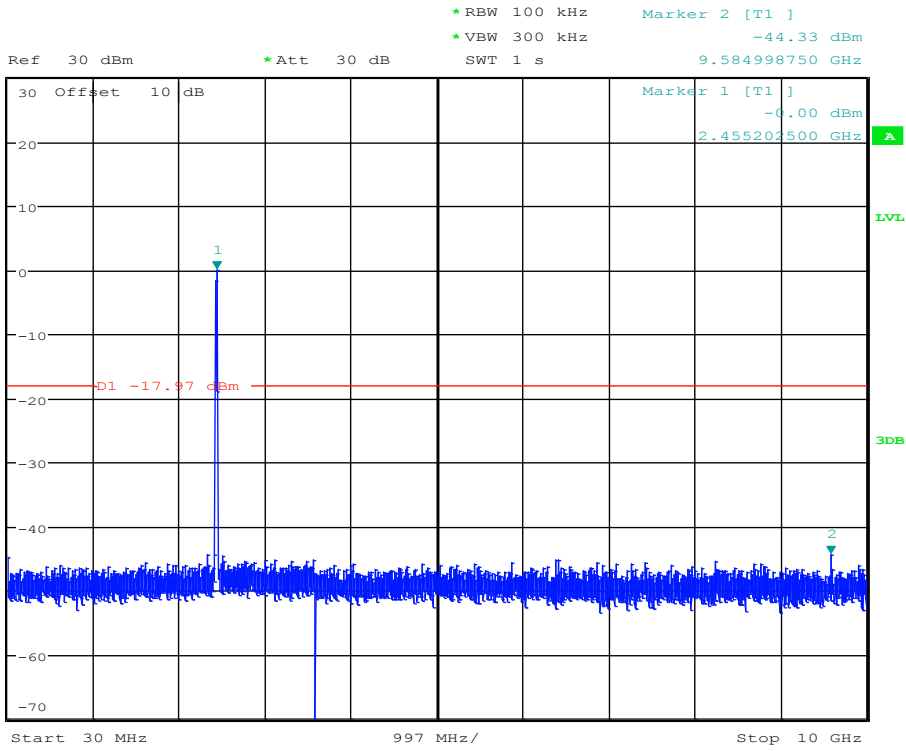

Date: 13.OCT.2017 18:38:21

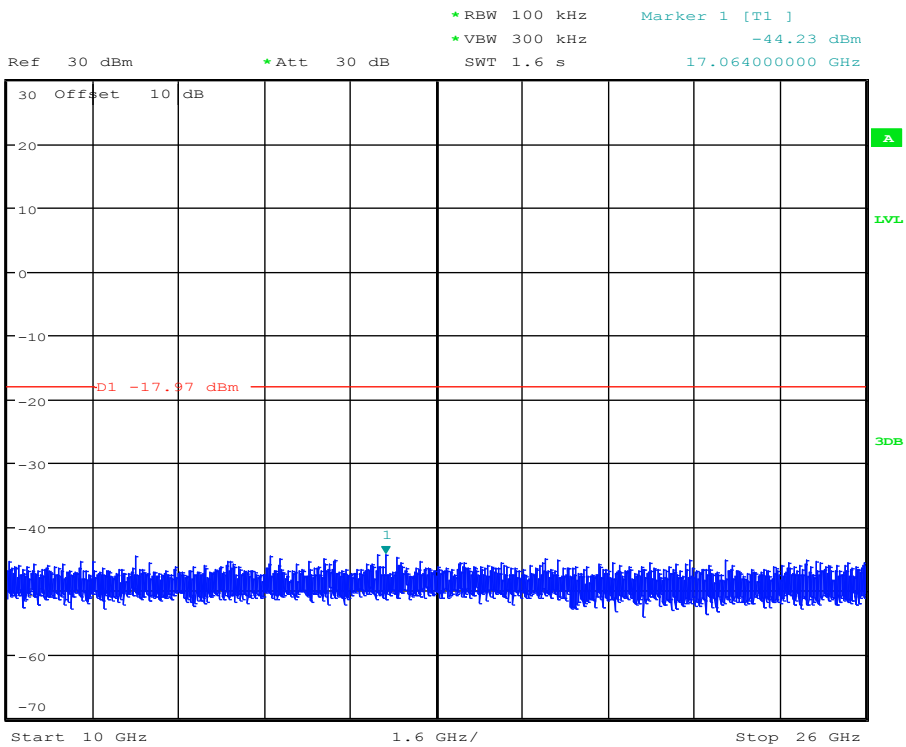

Date: 13.OCT.2017 18:38:31

RF Conducted Spurious Emissions_11N20MIMO_2462_Ant2



Ref 25 dBm *Att 20 dB SWT 15 ms 2.456960000 GHz
*RBW 100 kHz Marker 1 [T1] 1.46 dBm
*VBW 300 kHz

1 PK
VIEW

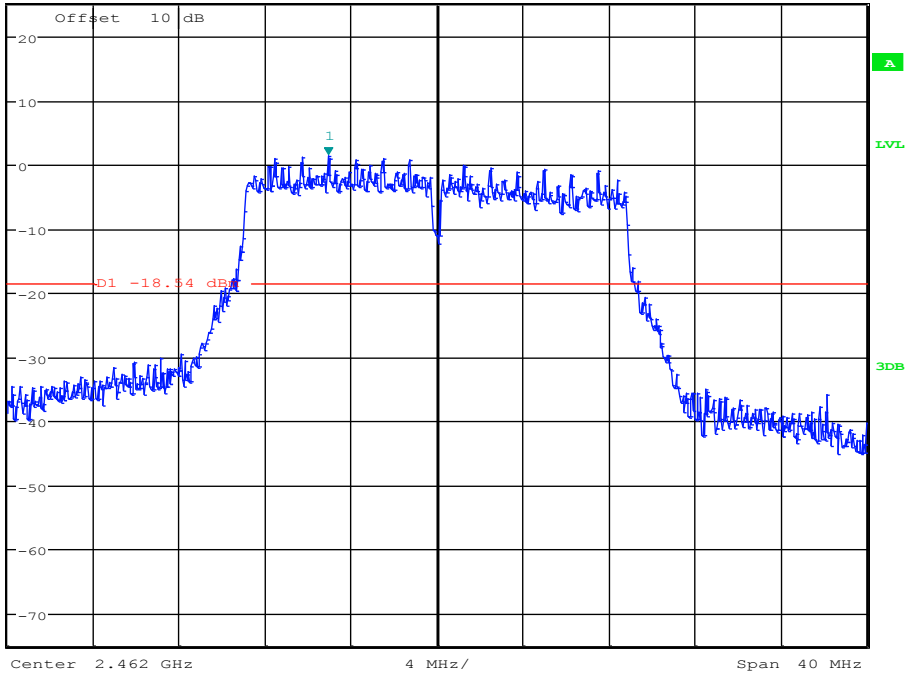

Date: 13.OCT.2017 18:40:41



Ref 30 dBm *Att 30 dB SWT 1 s 2.932516250 GHz
*RBW 100 kHz Marker 2 [T1] -44.82 dBm
*VBW 300 kHz

1 PK
VIEW

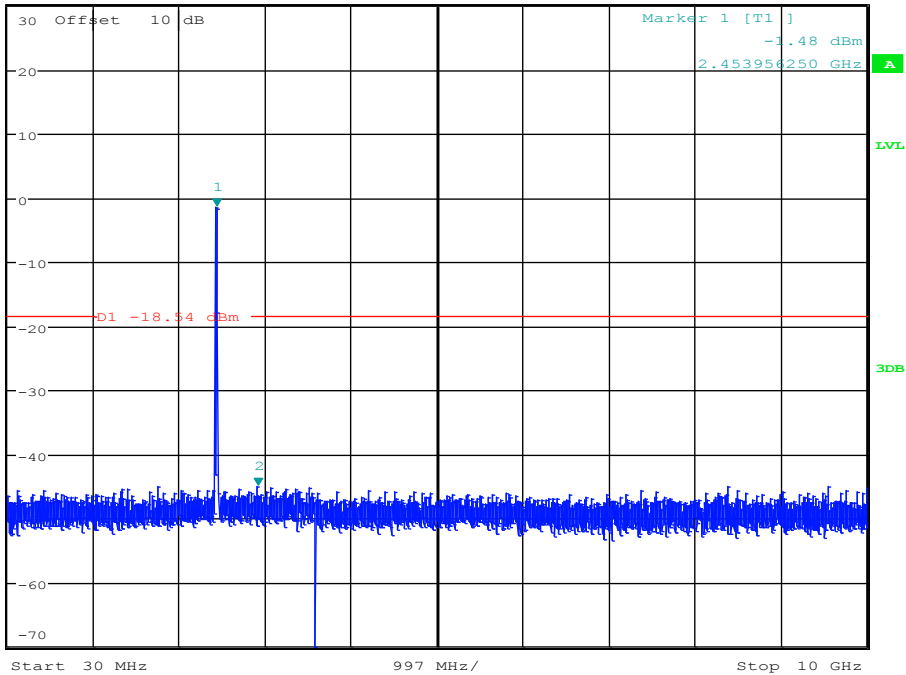

Date: 13.OCT.2017 18:40:52

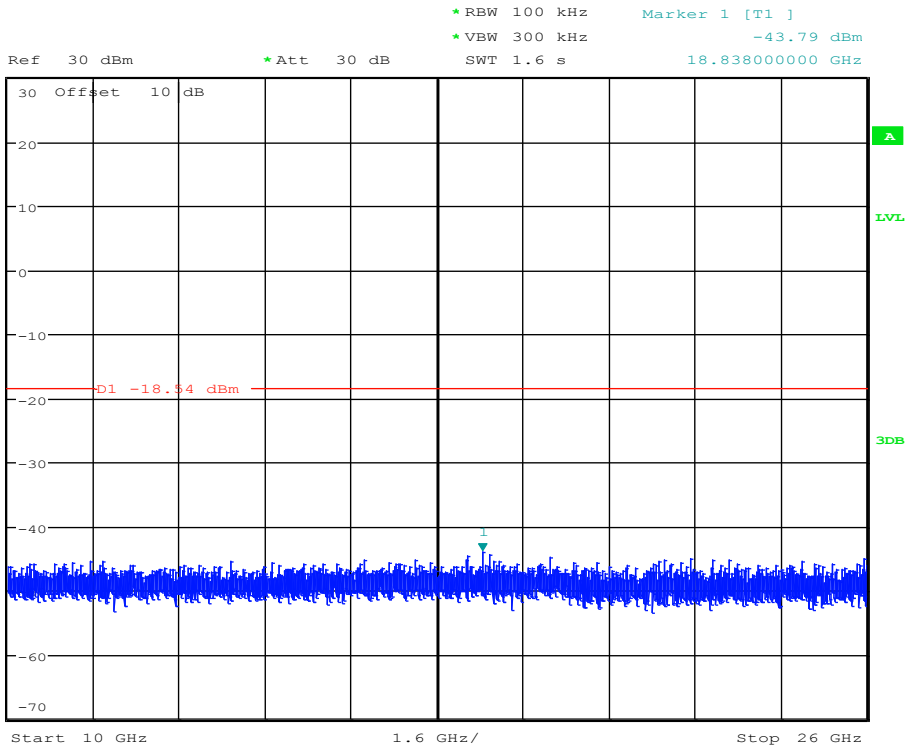

Date: 13.OCT.2017 18:41:02

RF Conducted Spurious Emissions_11N40MIMO_2422_Ant1

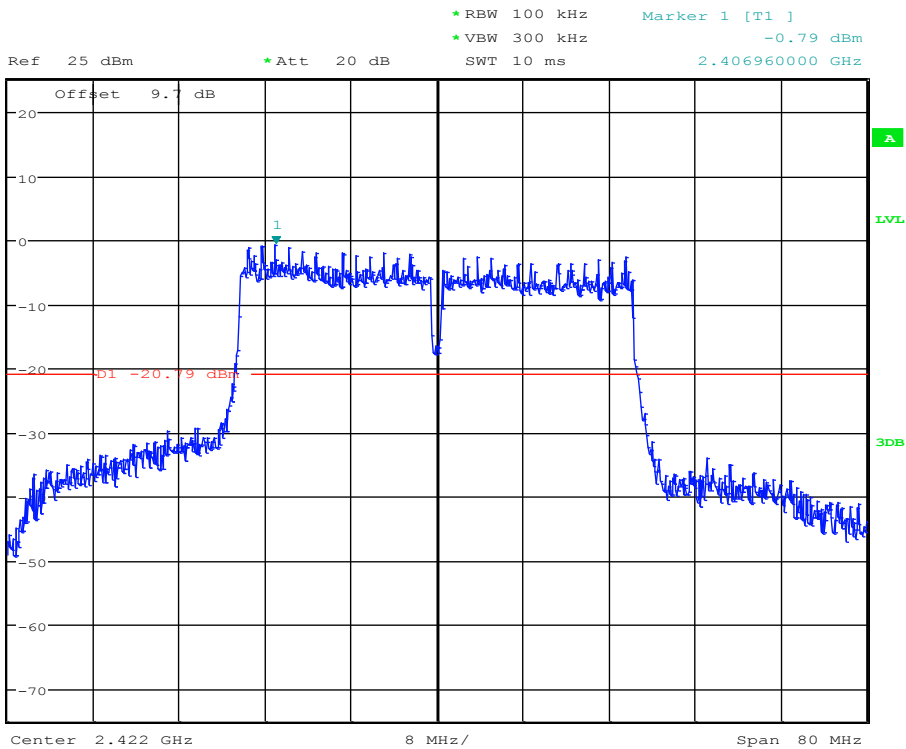

Date: 13.OCT.2017 18:44:13

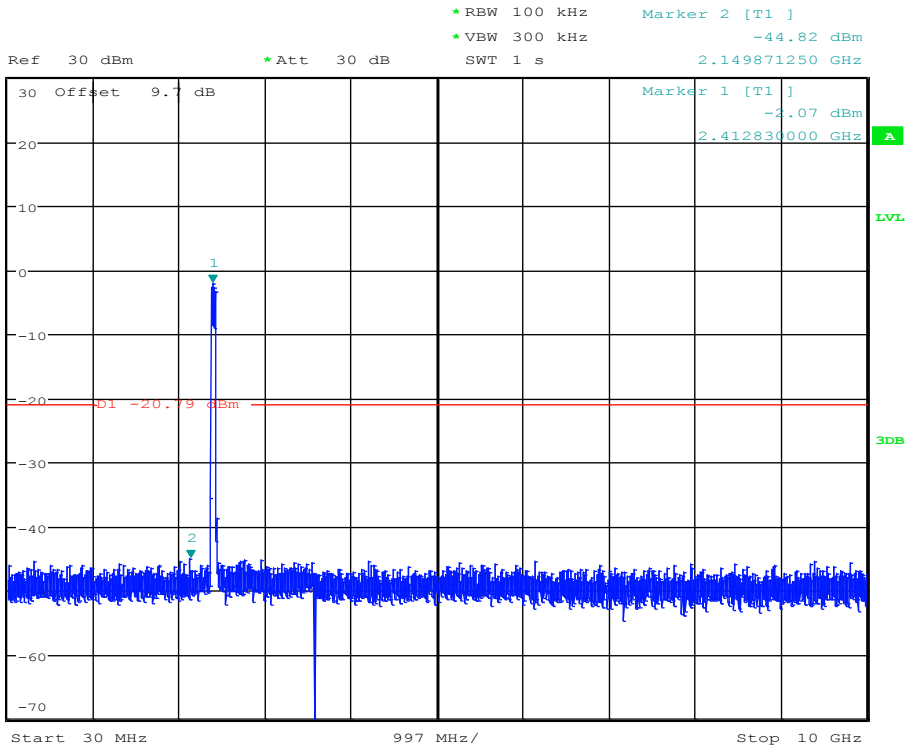

Date: 13.OCT.2017 18:44:24

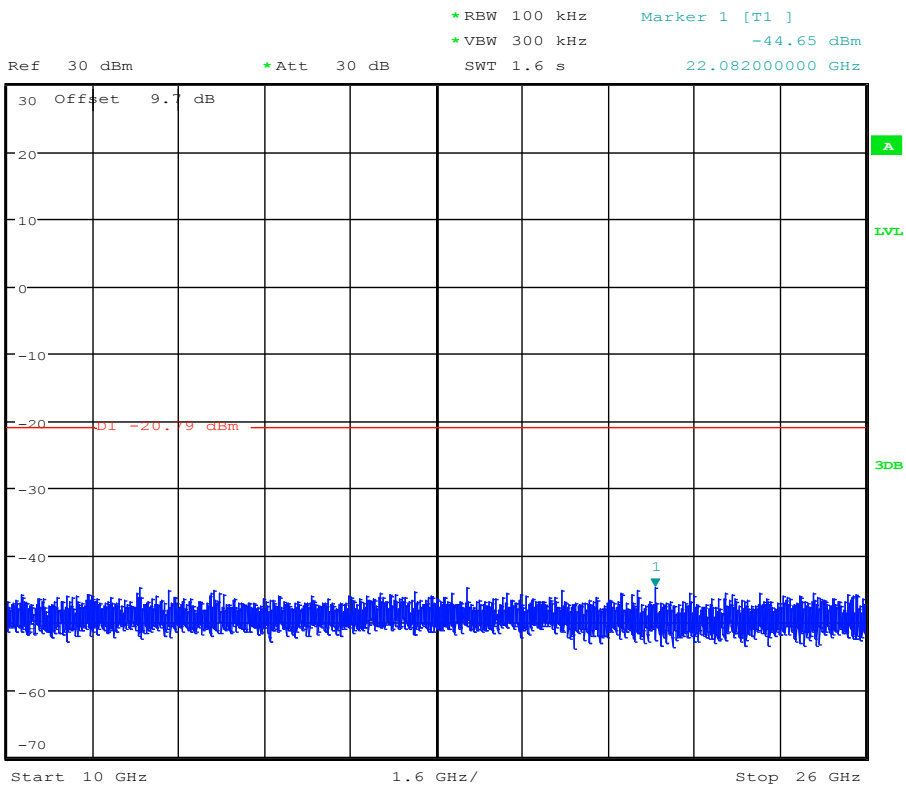

Date: 13.OCT.2017 18:44:35

RF Conducted Spurious Emissions_11N40MIMO_2422_Ant2



Ref 25 dBm *Att 20 dB SWT 10 ms
*RBW 100 kHz Marker 1 [T1] -1.44 dBm
*VBW 300 kHz 2.406960000 GHz

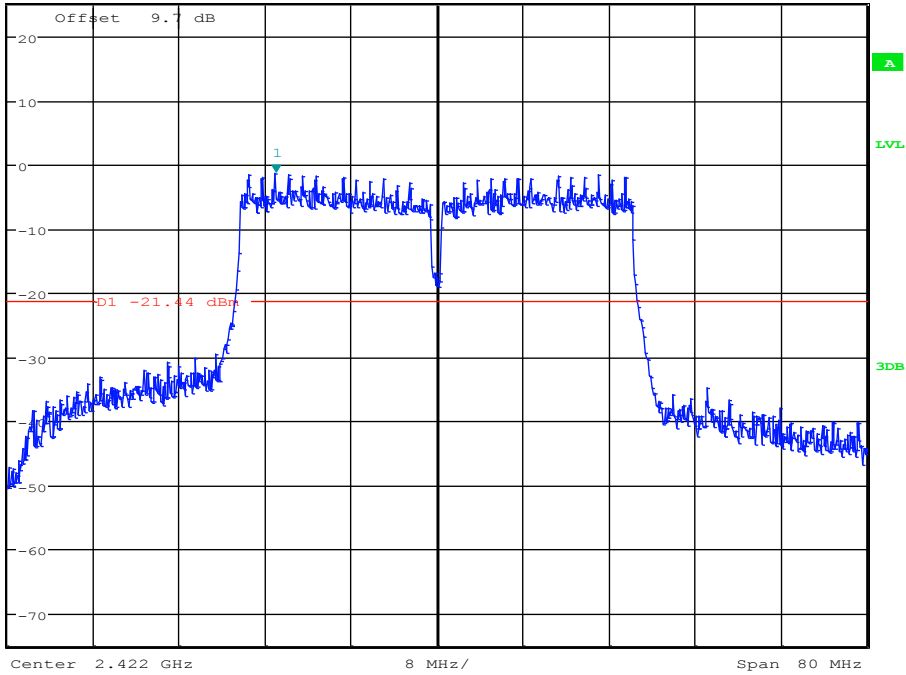

Date: 13.OCT.2017 18:46:44



Ref 30 dBm *Att 30 dB SWT 1 s
*RBW 100 kHz Marker 2 [T1] -44.57 dBm
*VBW 300 kHz 2.228385000 GHz

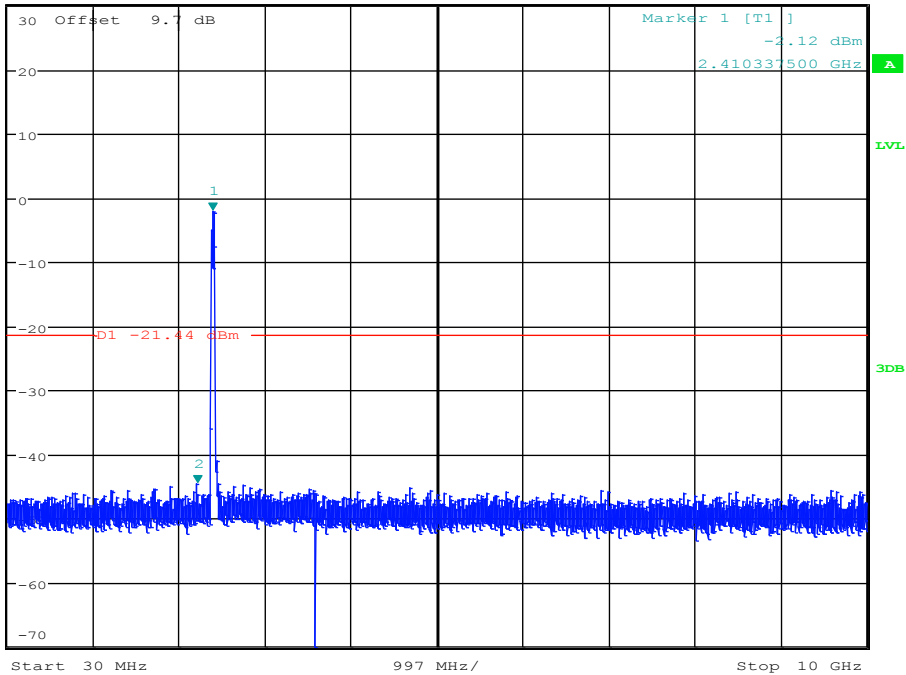

Date: 13.OCT.2017 18:46:56

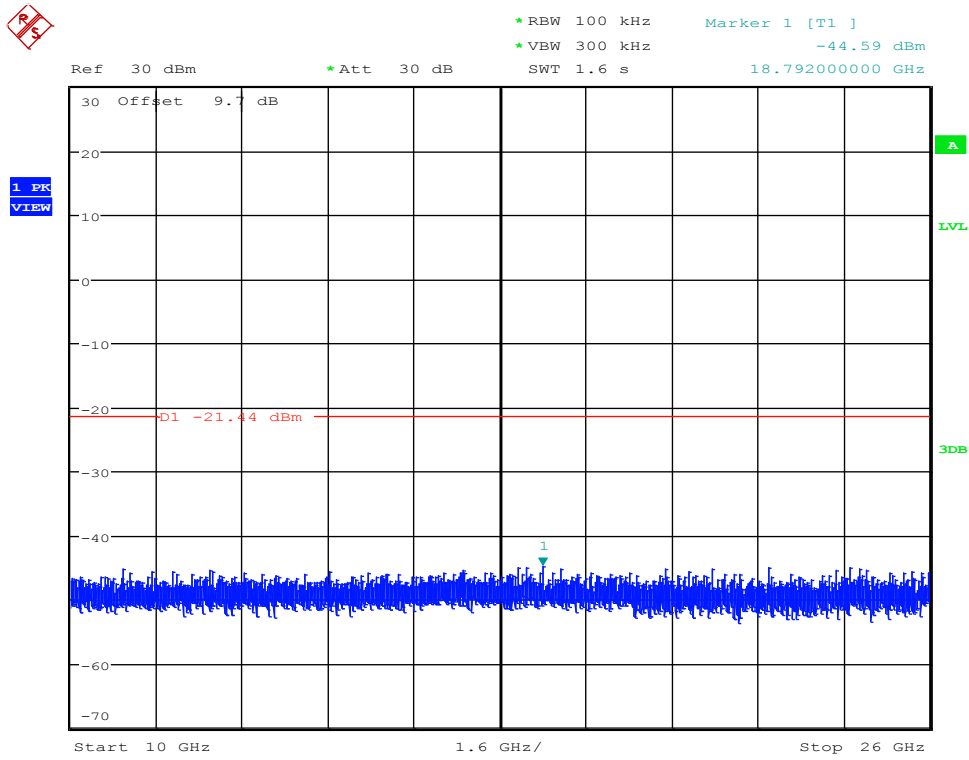

Date: 13.OCT.2017 18:47:06

RF Conducted Spurious Emissions_11N40MIMO_2452_Ant1

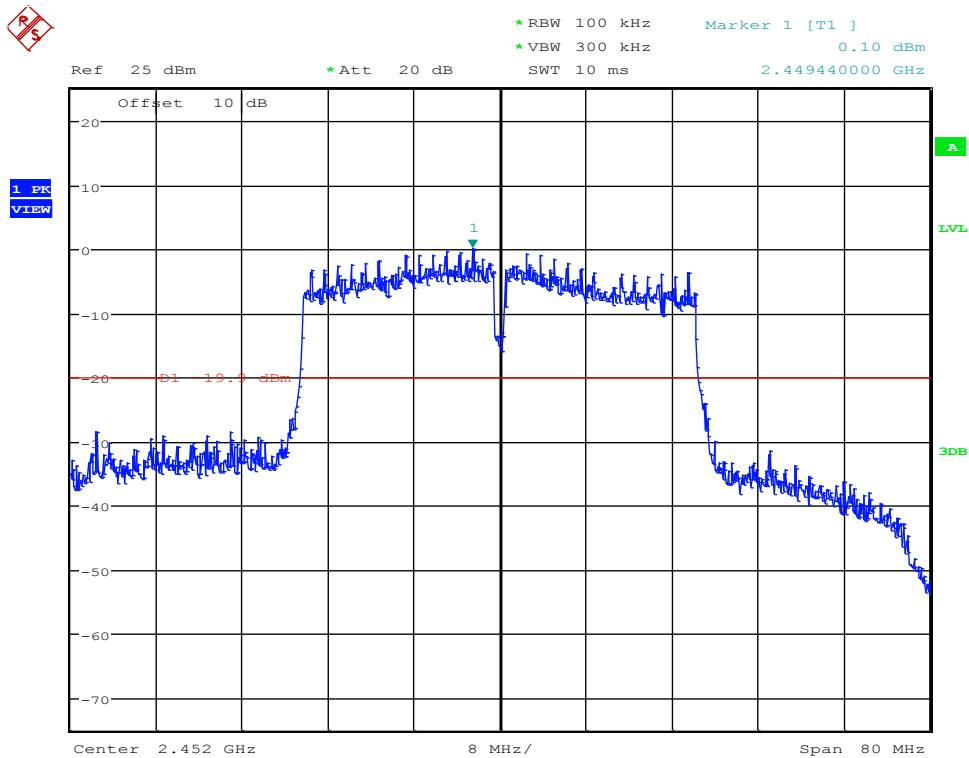

Date: 13.OCT.2017 18:54:08

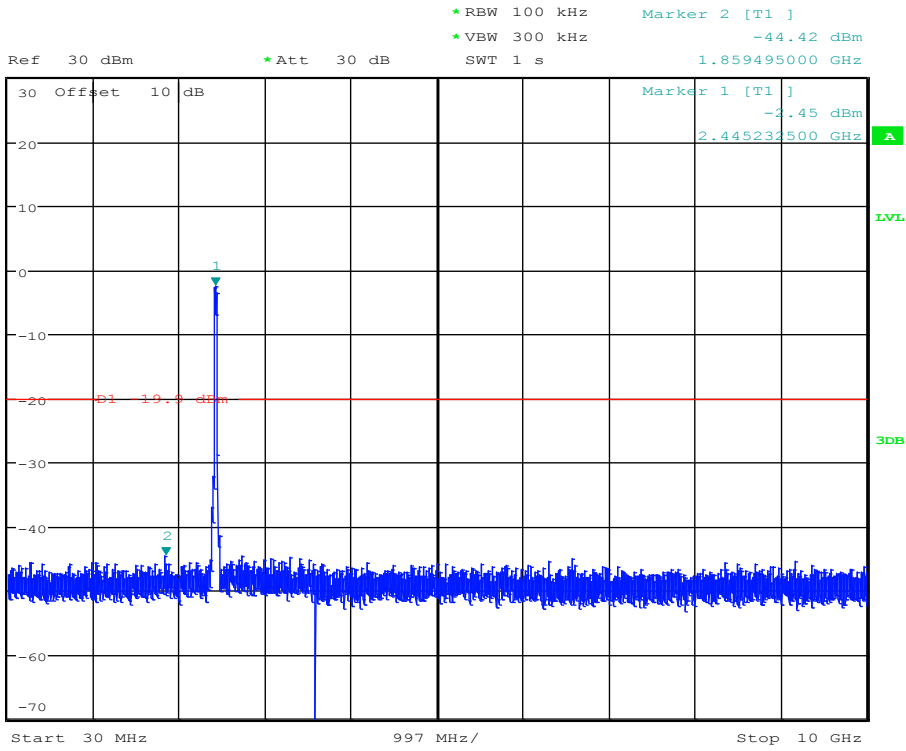

Date: 13.OCT.2017 18:54:20

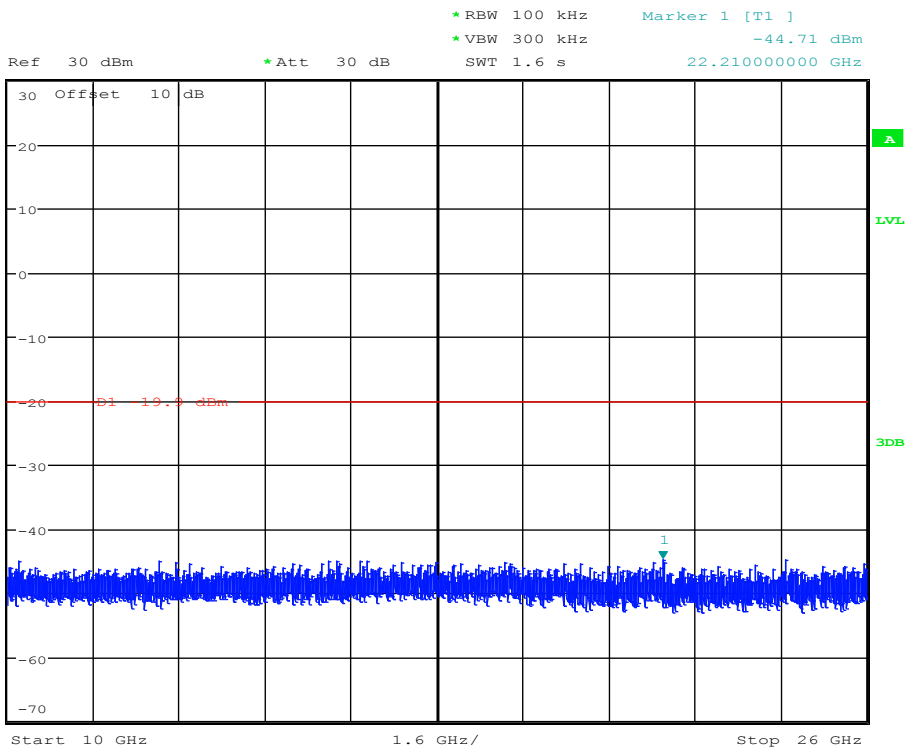

Date: 13.OCT.2017 18:54:30

RF Conducted Spurious Emissions_11N40MIMO_2452_Ant2



Ref 25 dBm *Att 20 dB SWT 10 ms *RBW 100 kHz Marker 1 [T1] -0.26 dBm
*VBW 300 kHz 2.446960000 GHz

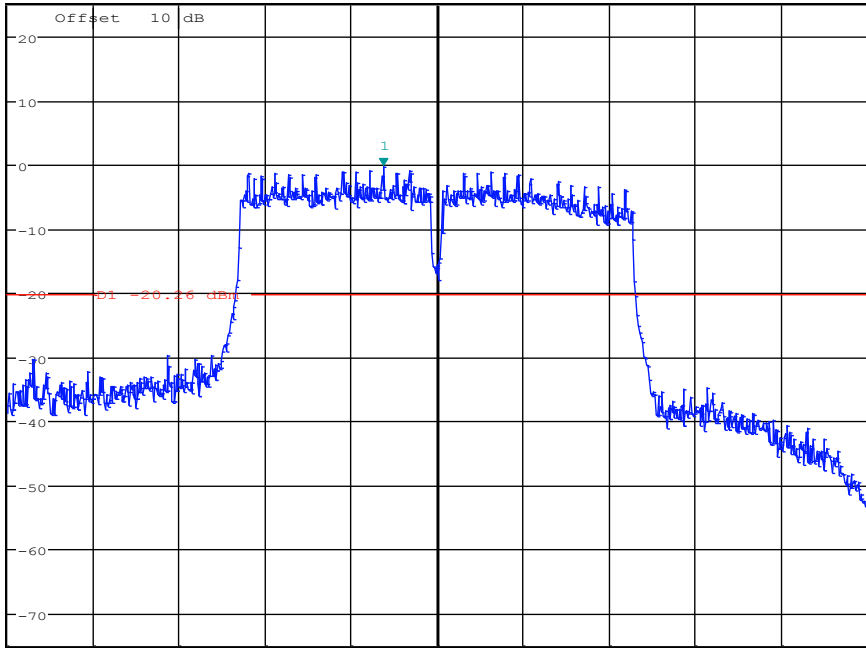

Center 2.452 GHz 8 MHz/ Span 80 MHz

Date: 13.OCT.2017 18:56:40



Ref 30 dBm *Att 30 dB SWT 1 s *RBW 100 kHz Marker 2 [T1] -43.28 dBm
*VBW 300 kHz 2.690743750 GHz

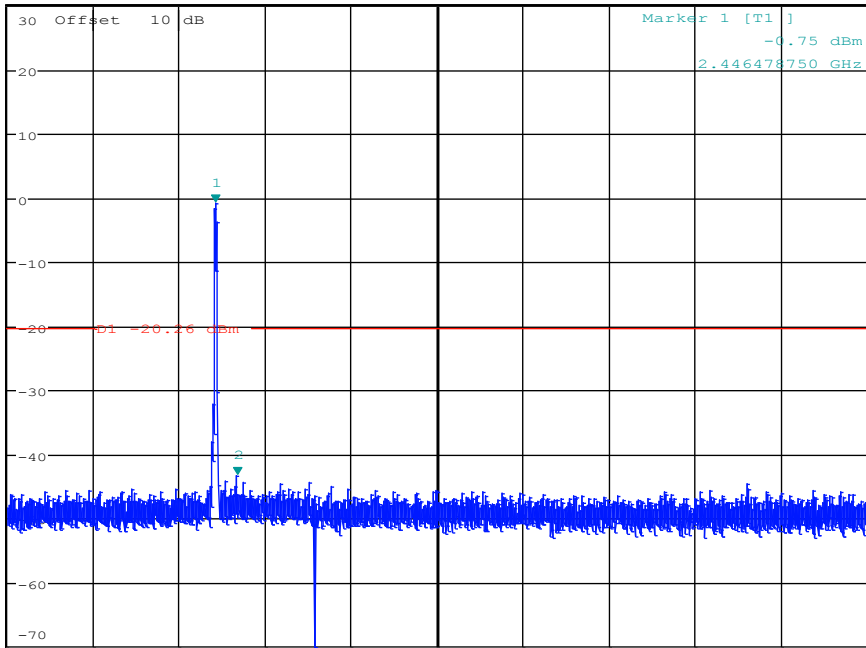

Start 30 MHz 997 MHz/ Stop 10 GHz

Date: 13.OCT.2017 18:56:51

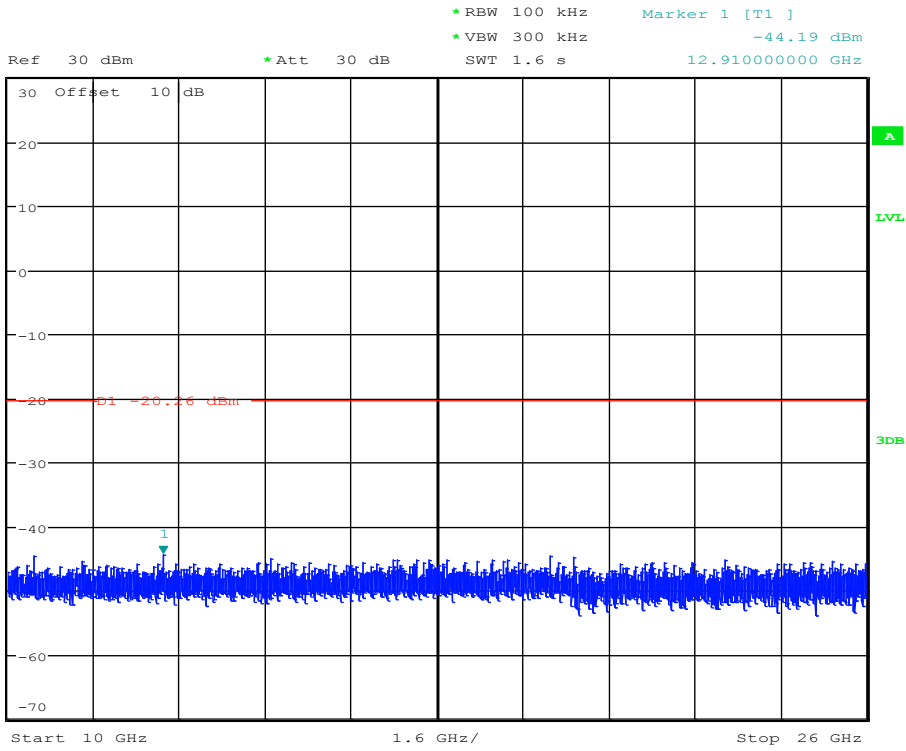

Date: 13.OCT.2017 18:57:02

RF Conducted Spurious Emissions_11GMIMO_2412_Ant1

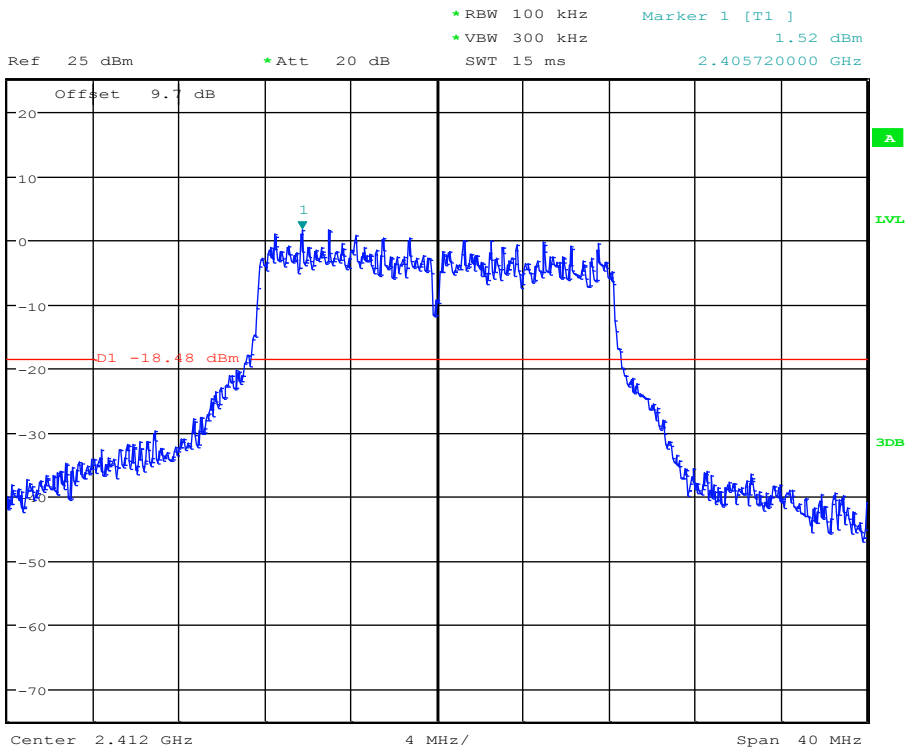

Date: 13.OCT.2017 16:51:22

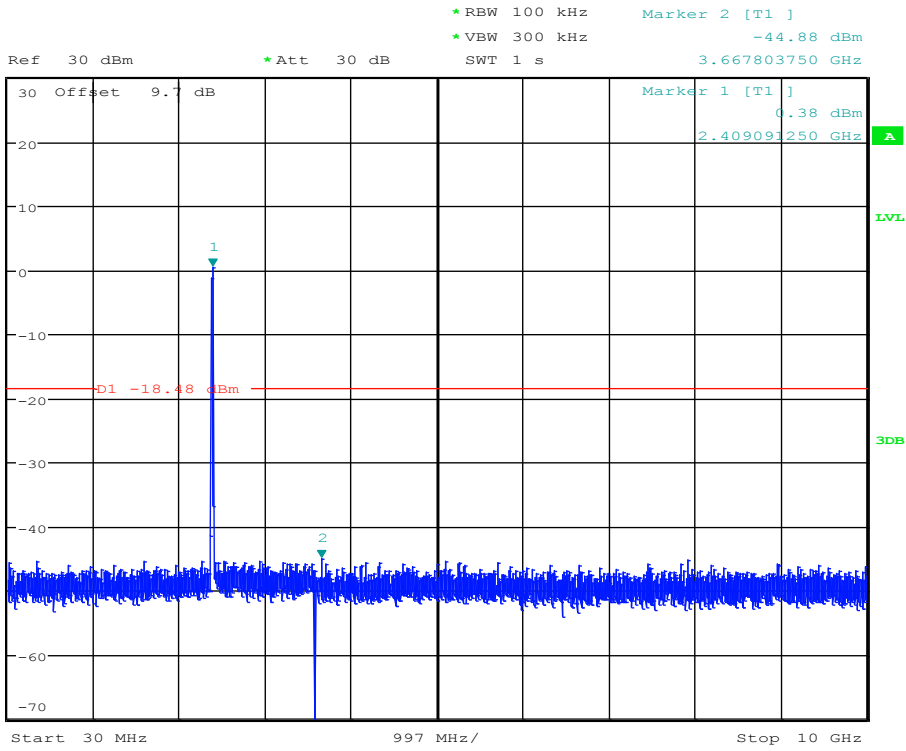

Date: 13.OCT.2017 16:51:33

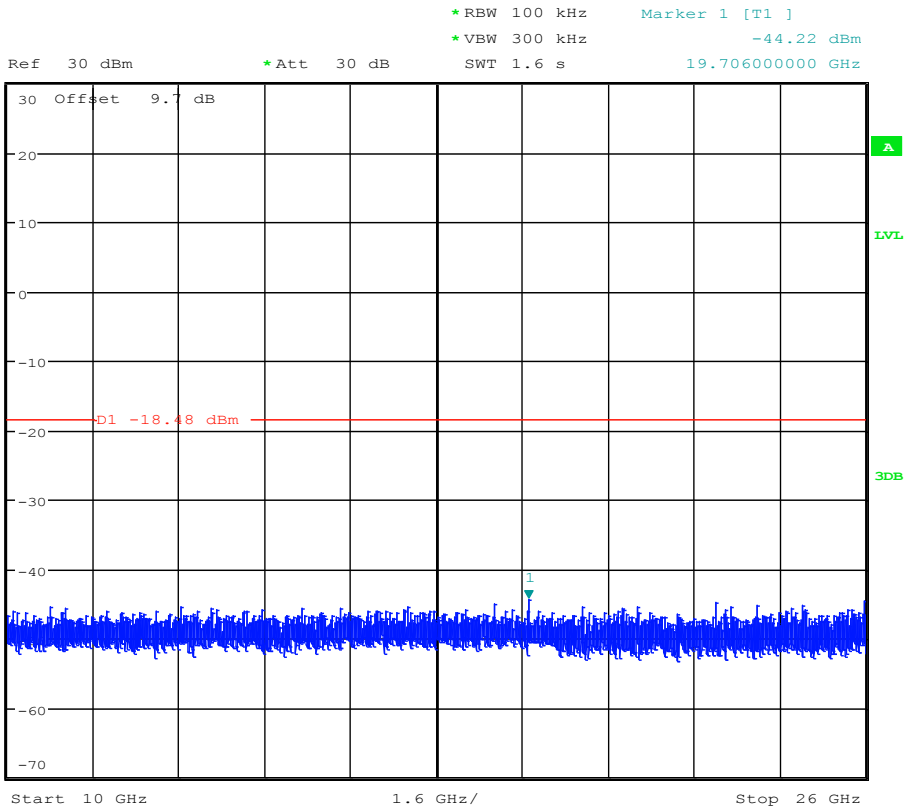

Date: 13.OCT.2017 16:51:43

RF Conducted Spurious Emissions_11BMIMO_2412_Ant1

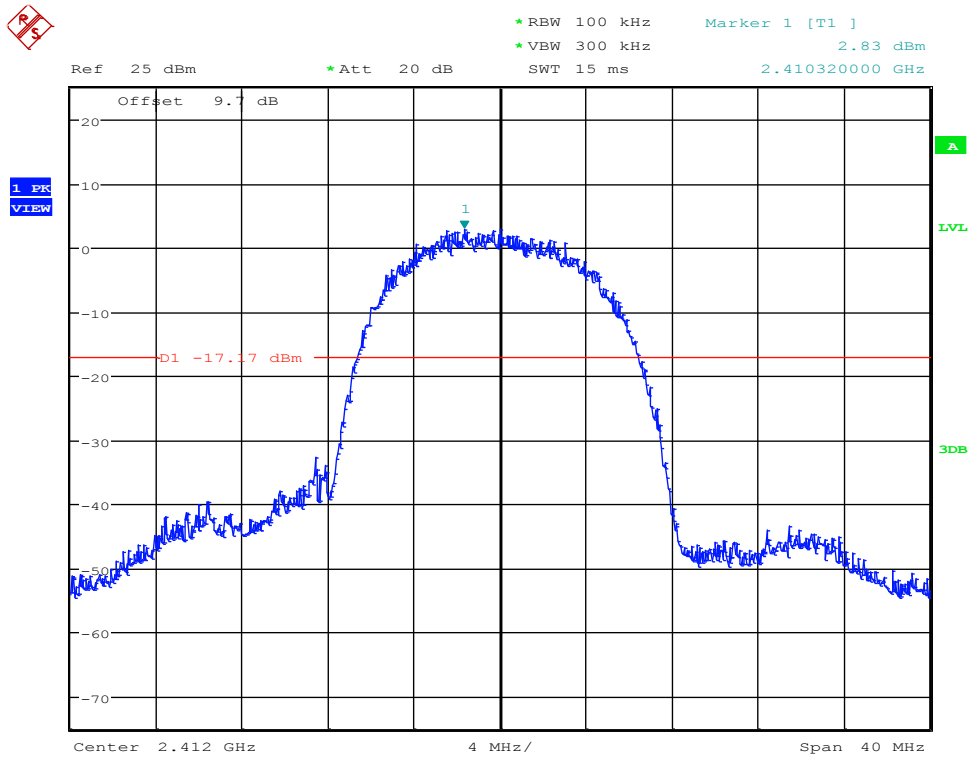

Date: 13.OCT.2017 16:29:46

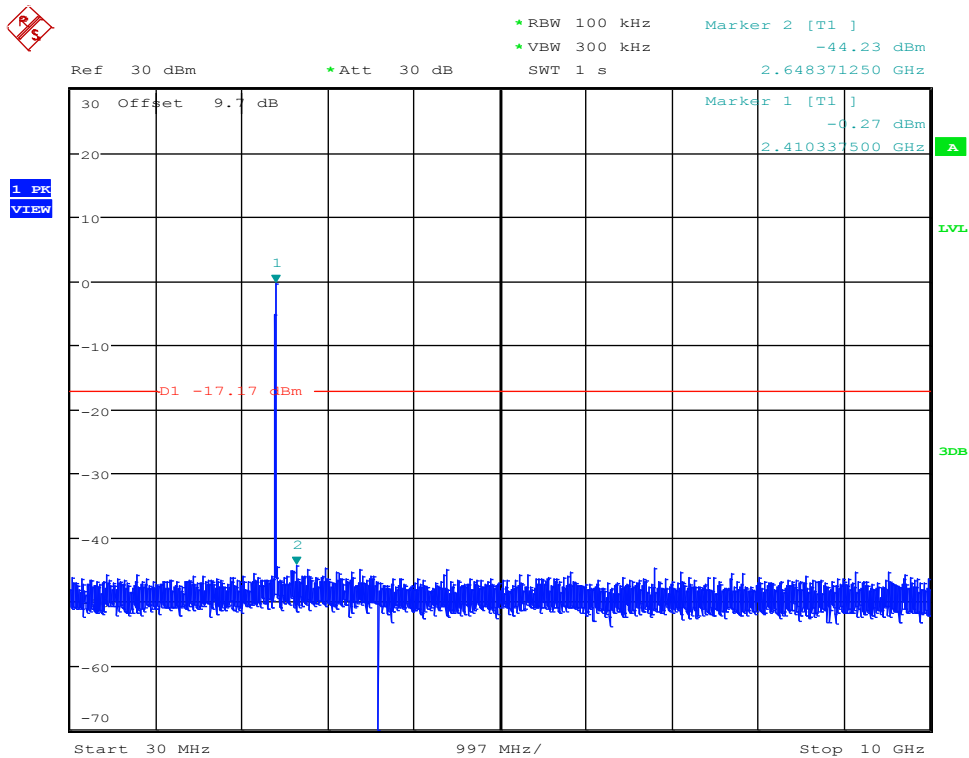

Date: 13.OCT.2017 16:29:57

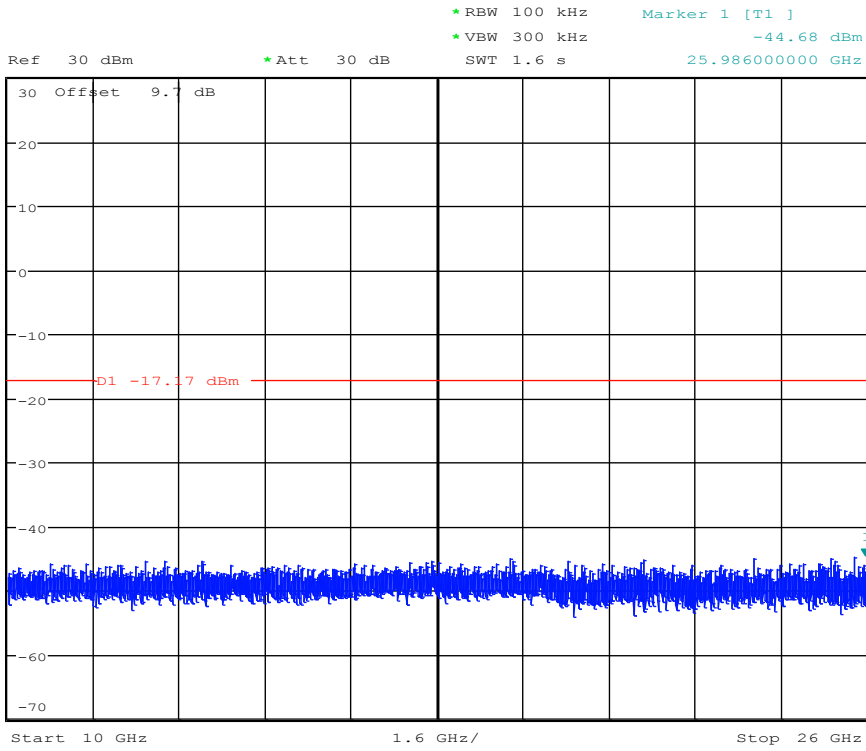

Date: 13.OCT.2017 16:30:07

RF Conducted Spurious Emissions_11GMIMO_2412_Ant2

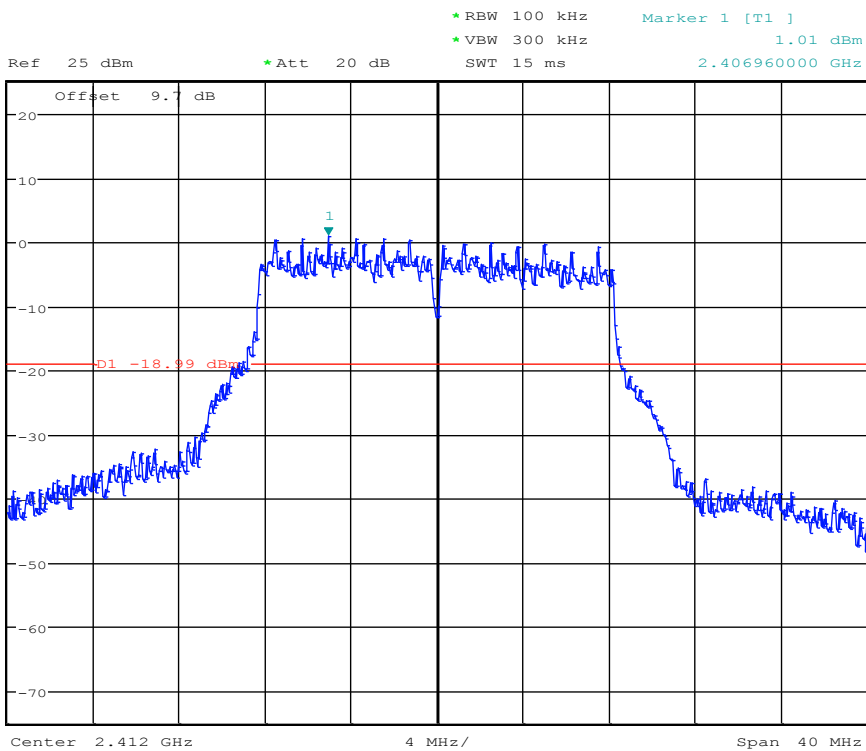

Date: 13.OCT.2017 16:53:52

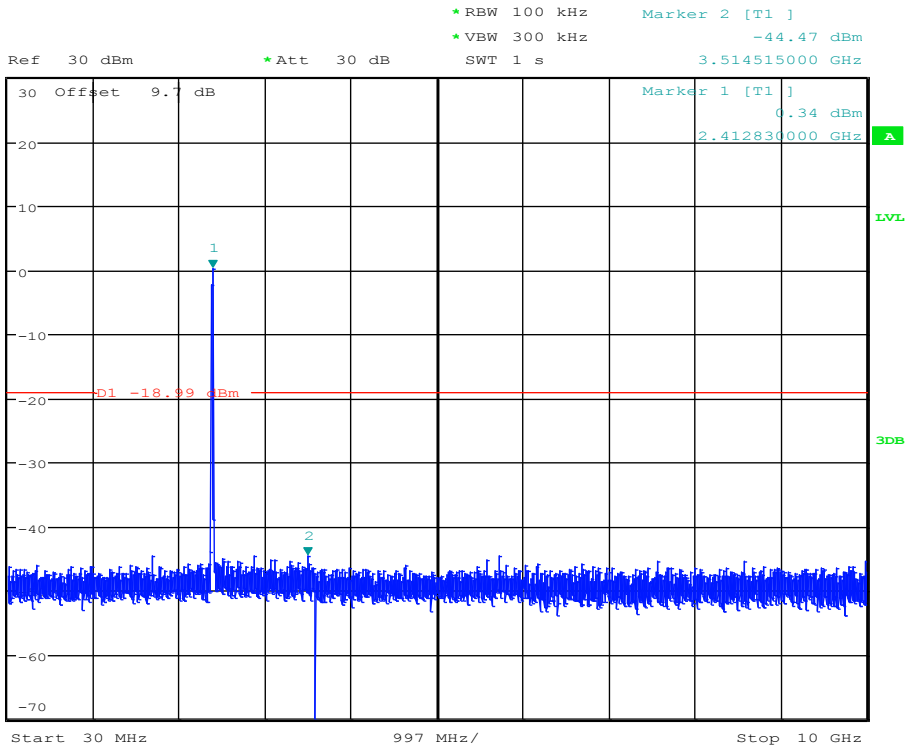

Date: 13.OCT.2017 16:54:04

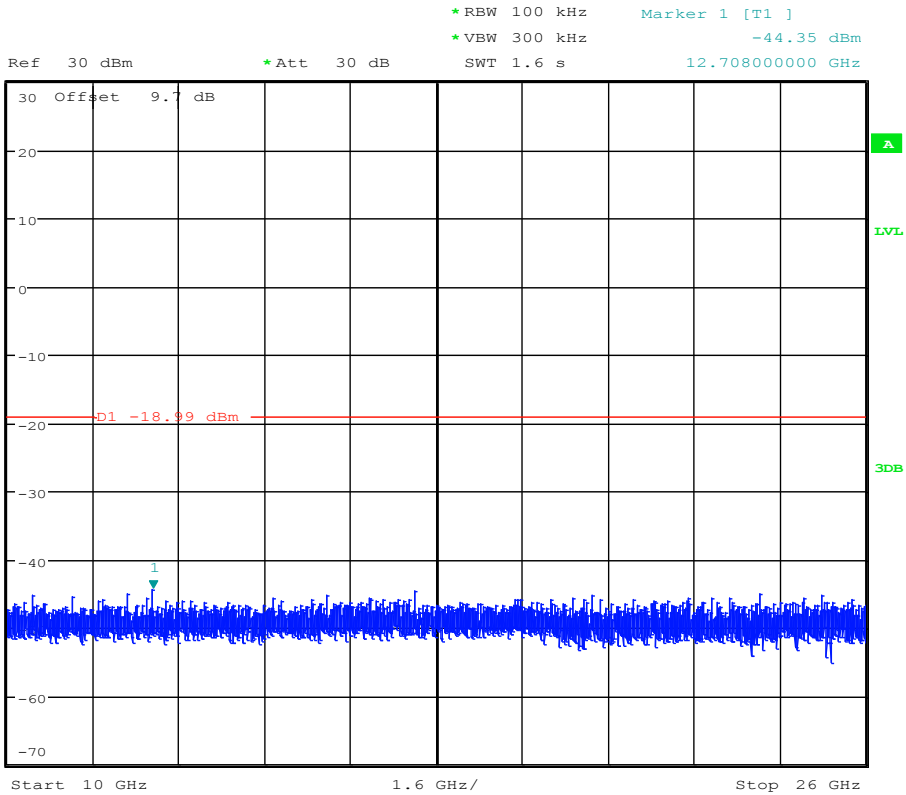

Date: 13.OCT.2017 16:54:13

RF Conducted Spurious Emissions_11BMIMO_2412_Ant2



Ref 25 dBm *Att 20 dB SWT 15 ms
*RBW 100 kHz *VBW 300 kHz
Marker 1 [T1] 2.98 dBm 2.411400000 GHz

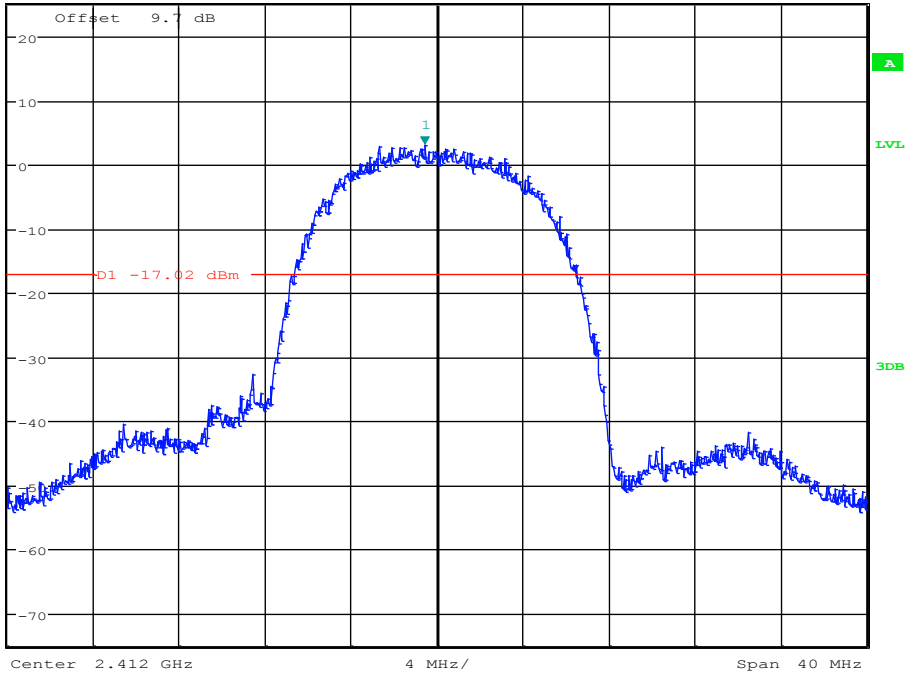

Date: 13.OCT.2017 16:32:16



Ref 30 dBm *Att 30 dB SWT 1 s
*RBW 100 kHz *VBW 300 kHz
Marker 2 [T1] -44.72 dBm 2.835308750 GHz

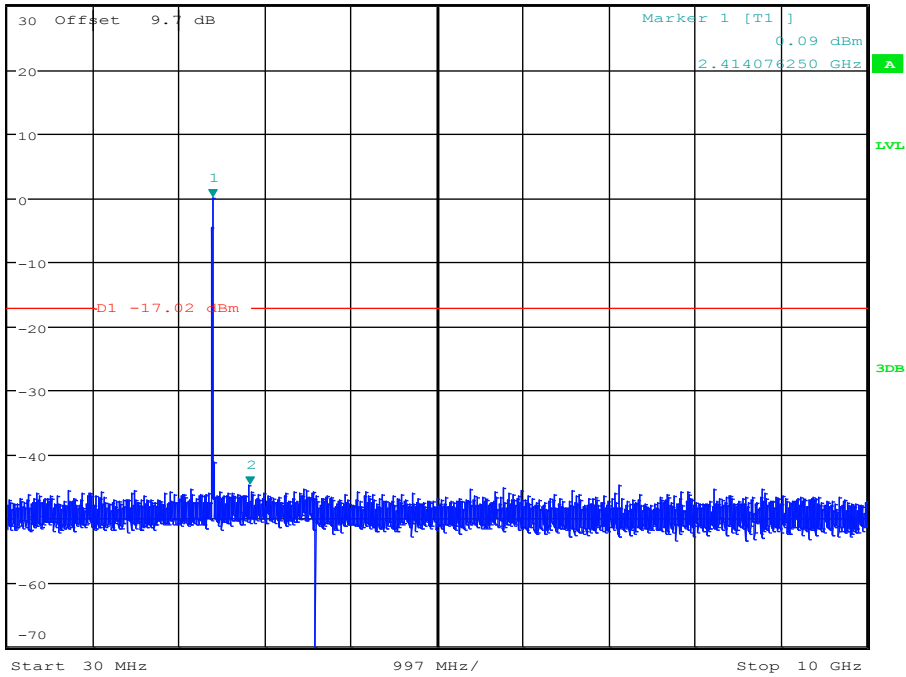

Date: 13.OCT.2017 16:32:28

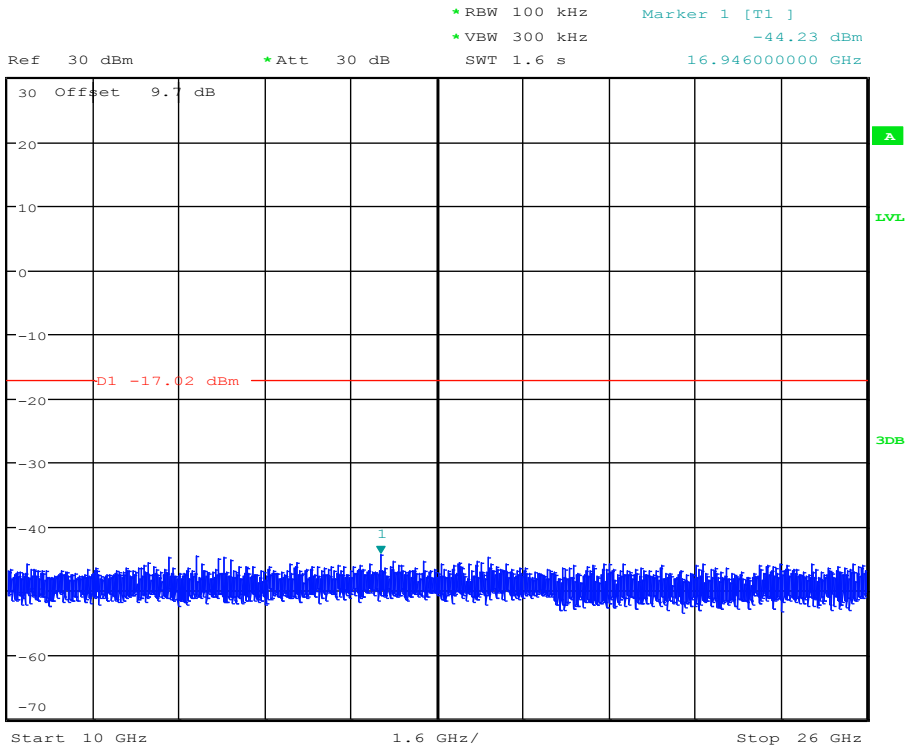

Date: 13.OCT.2017 16:32:38

RF Conducted Spurious Emissions_11GMIMO_2462_Ant1

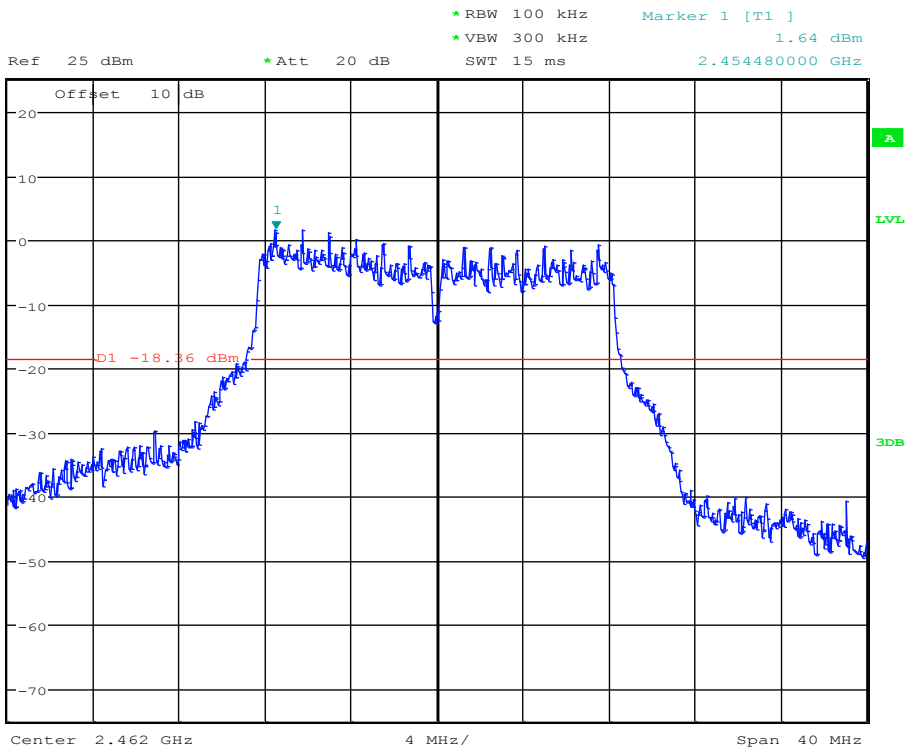

Date: 13.OCT.2017 17:41:45

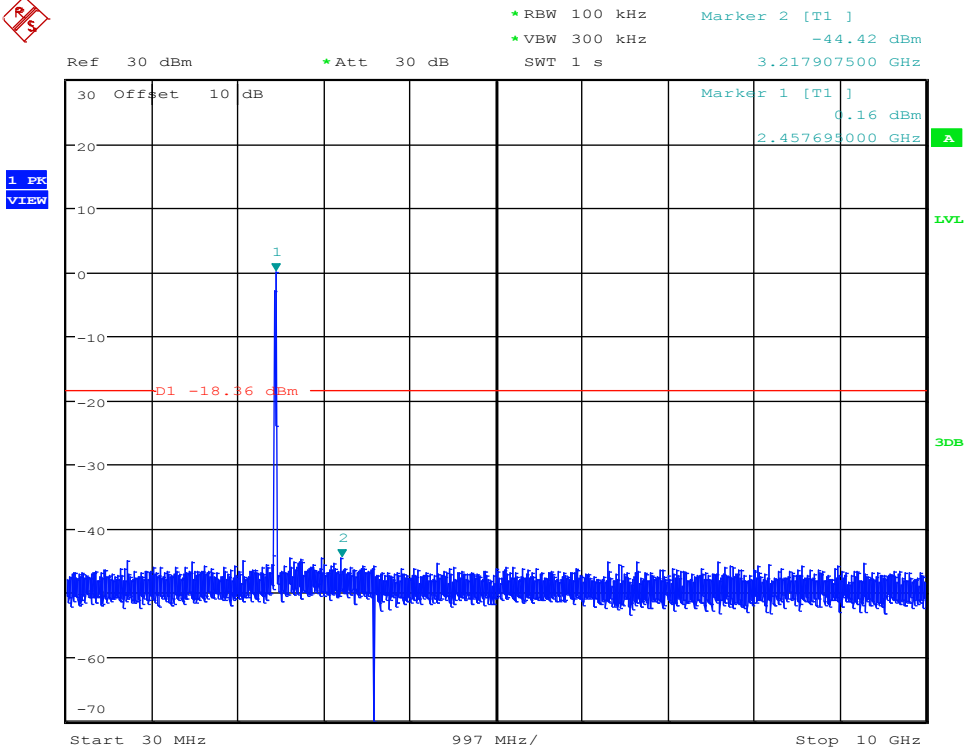

Date: 13.OCT.2017 17:41:57

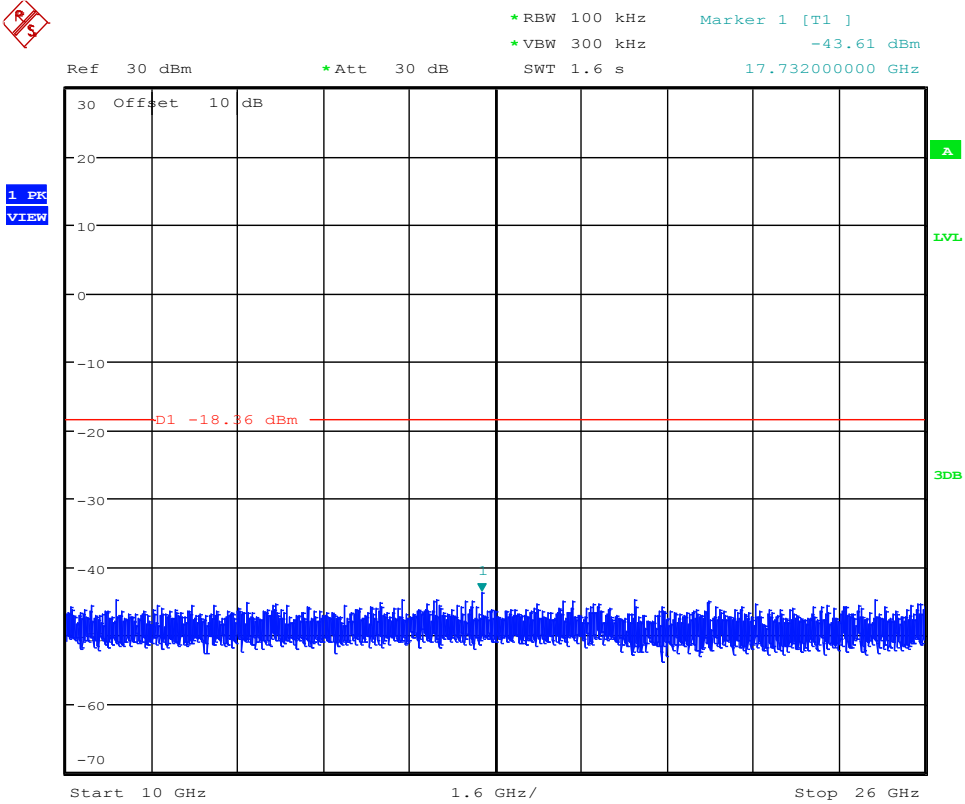

Date: 13.OCT.2017 17:42:07

RF Conducted Spurious Emissions_11BMIMO_2462_Ant1

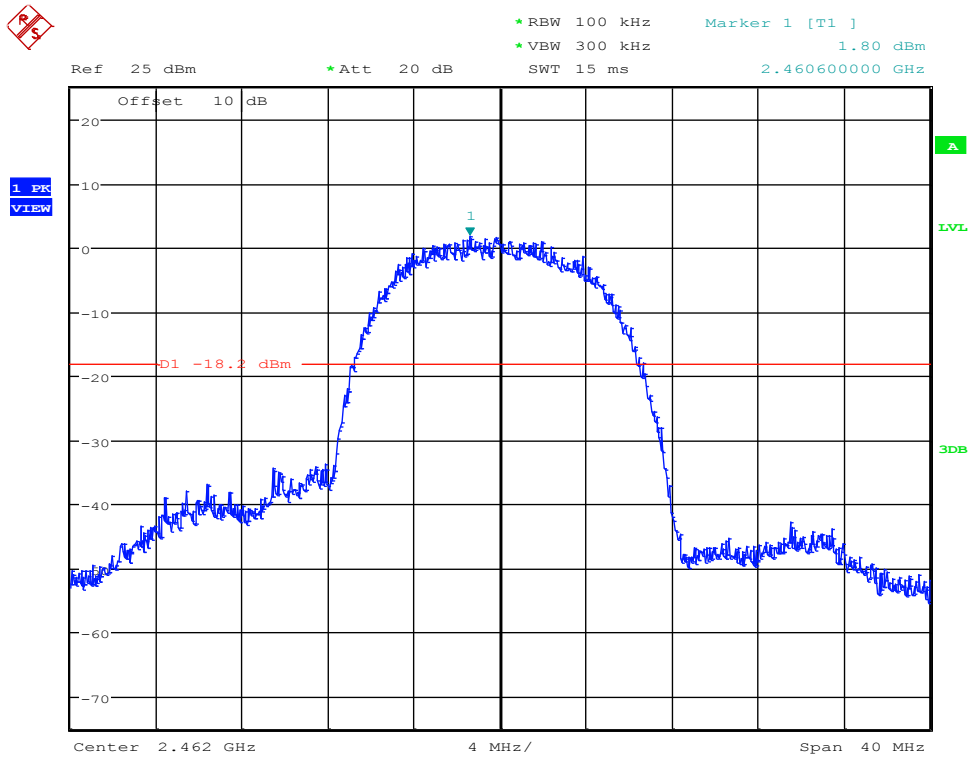

Date: 13.OCT.2017 16:44:28

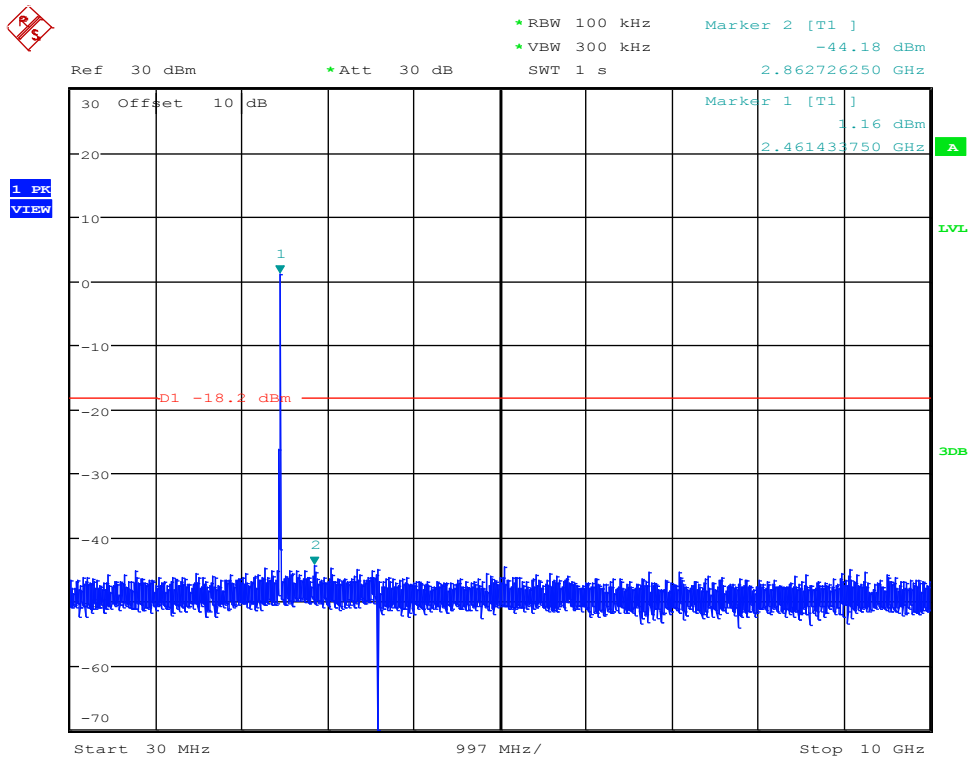

Date: 13.OCT.2017 16:44:40

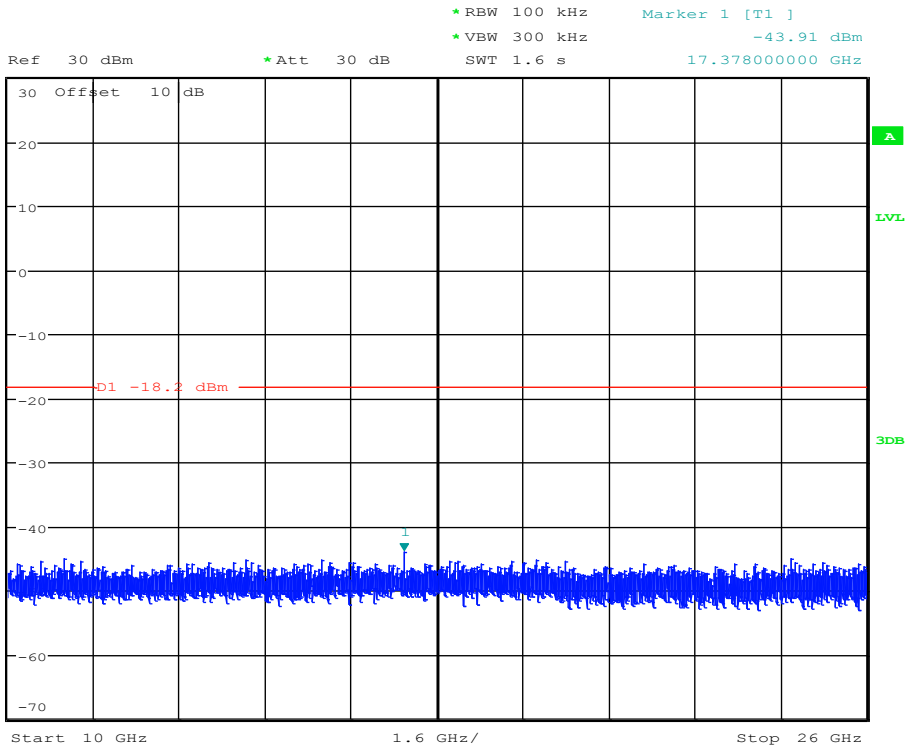

Date: 13.OCT.2017 16:44:50

RF Conducted Spurious Emissions_11BMIMO_2462_Ant2

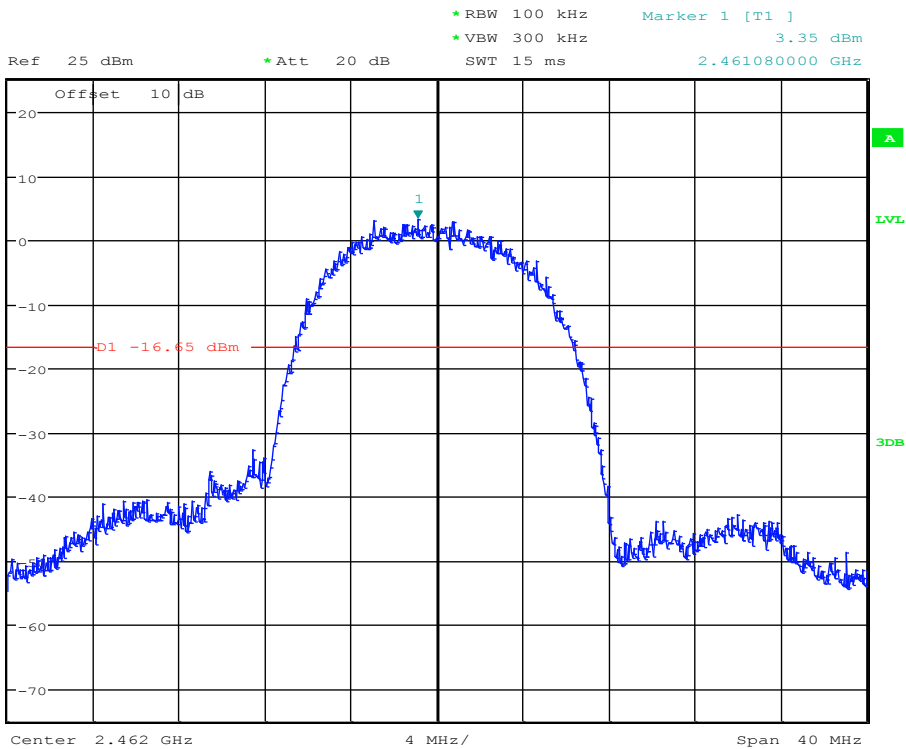

Date: 13.OCT.2017 16:46:59

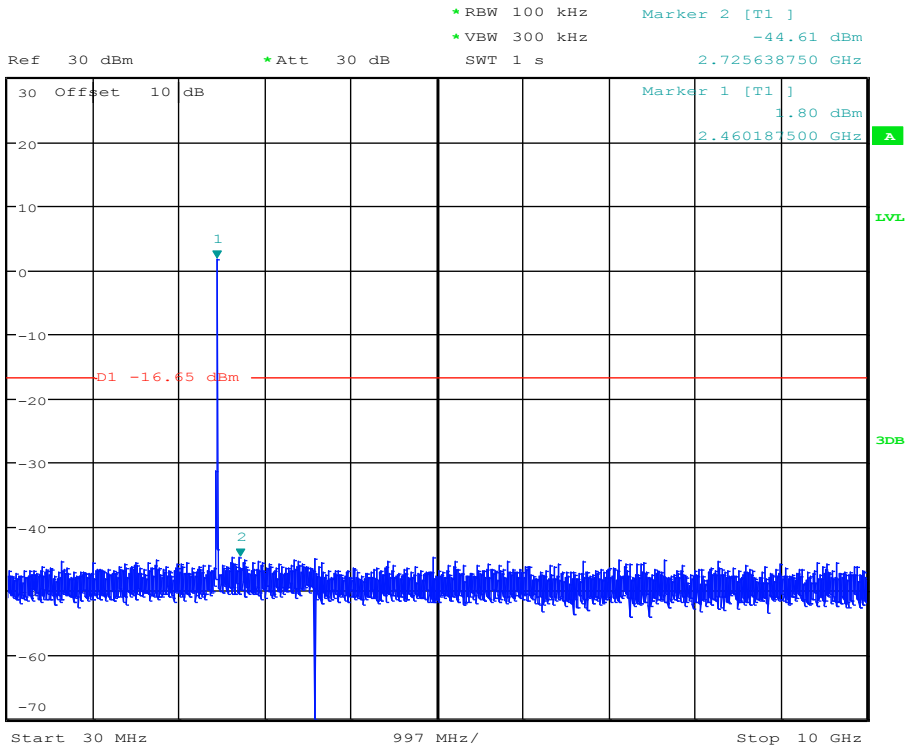

Date: 13.OCT.2017 16:47:10

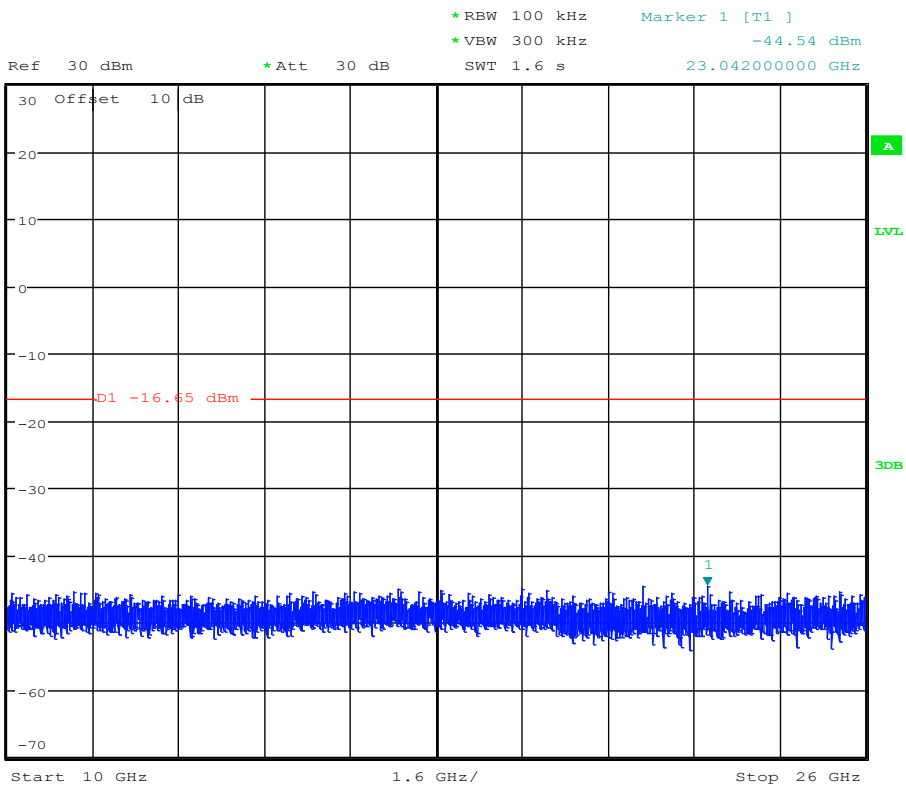

Date: 13.OCT.2017 16:47:20

RF Conducted Spurious Emissions_11GMIMO_2462_Ant2

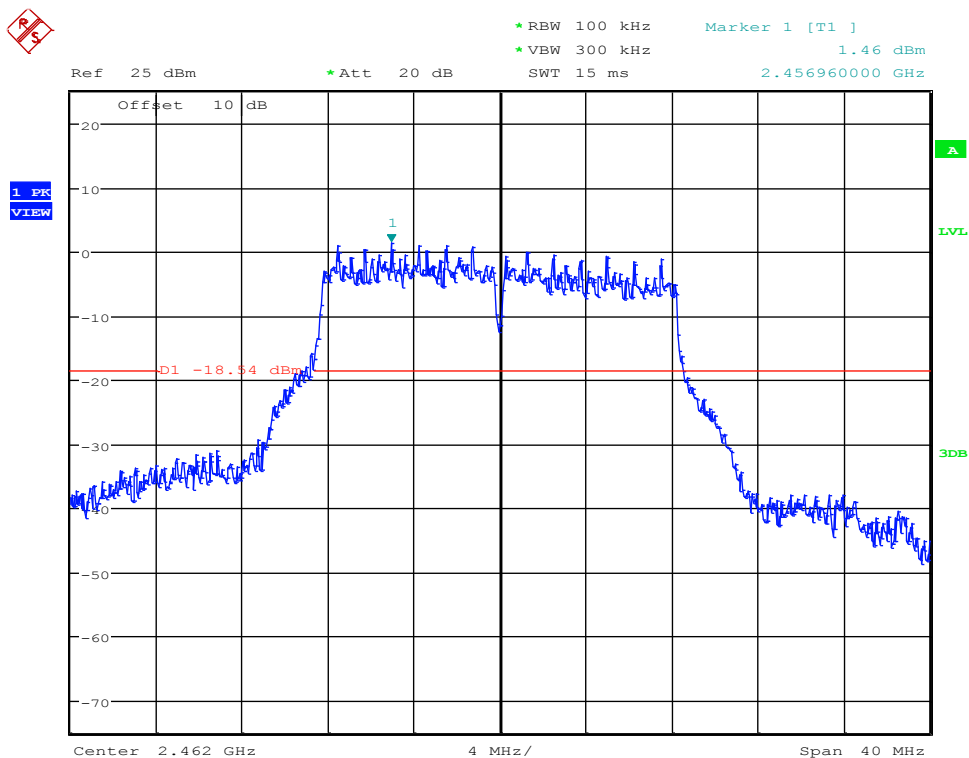

Date: 13.OCT.2017 17:44:16

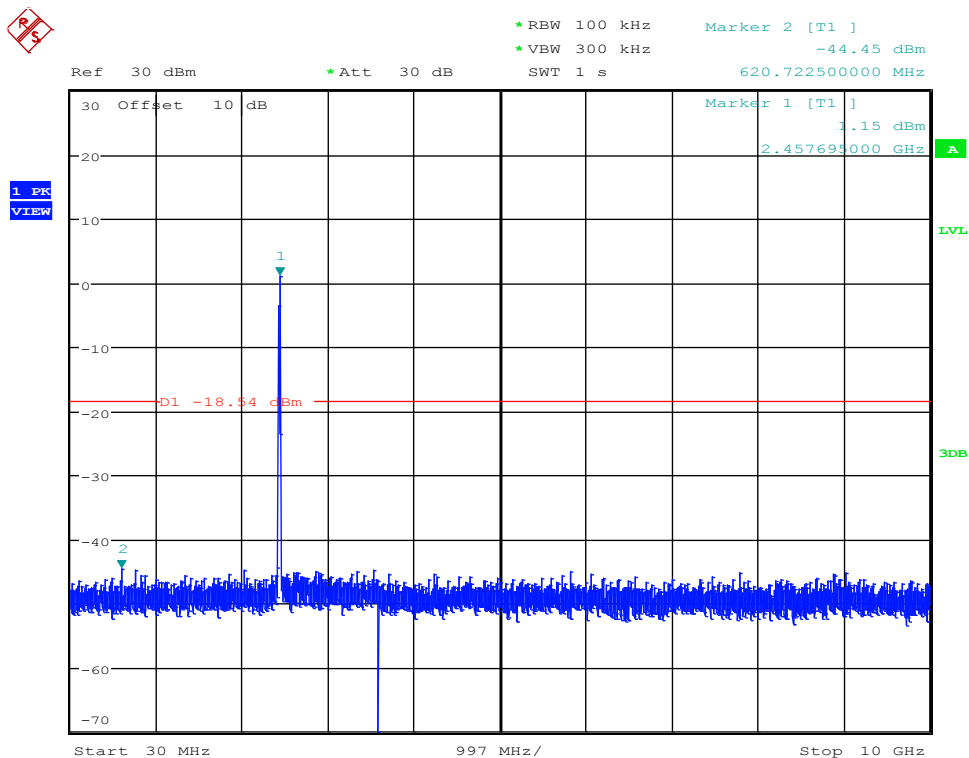

Date: 13.OCT.2017 17:44:28

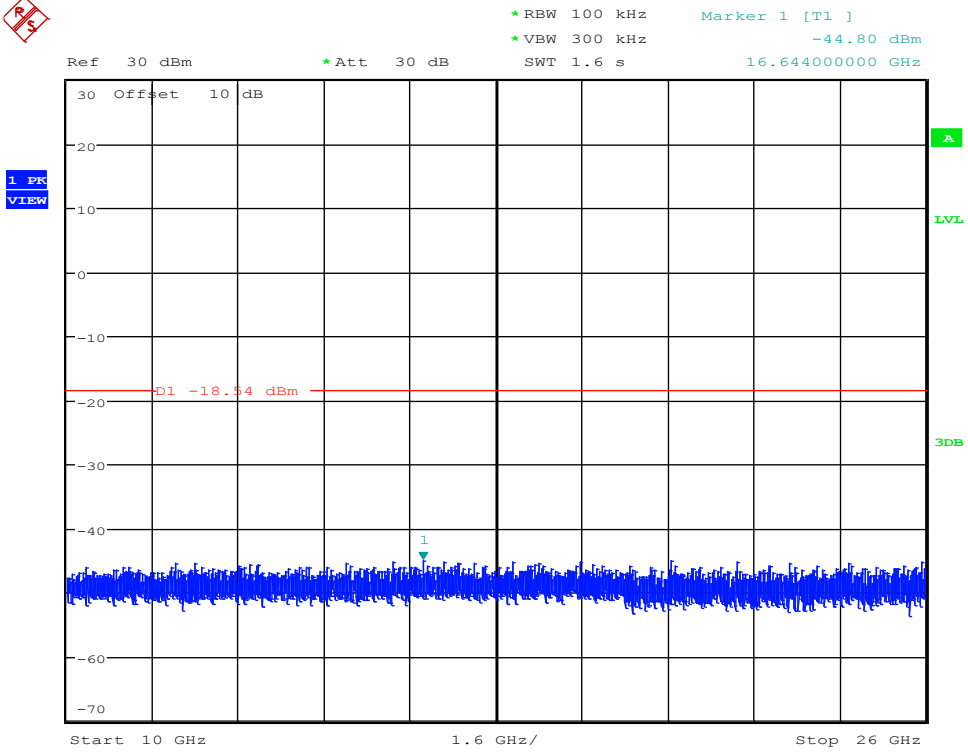

Date: 13.OCT.2017 17:44:38

7. Radiated Spurious Emissions

7.1. Block diagram of test setup

In 3m Anechoic Chamber Test Setup Diagram for 9KHz-30MHz

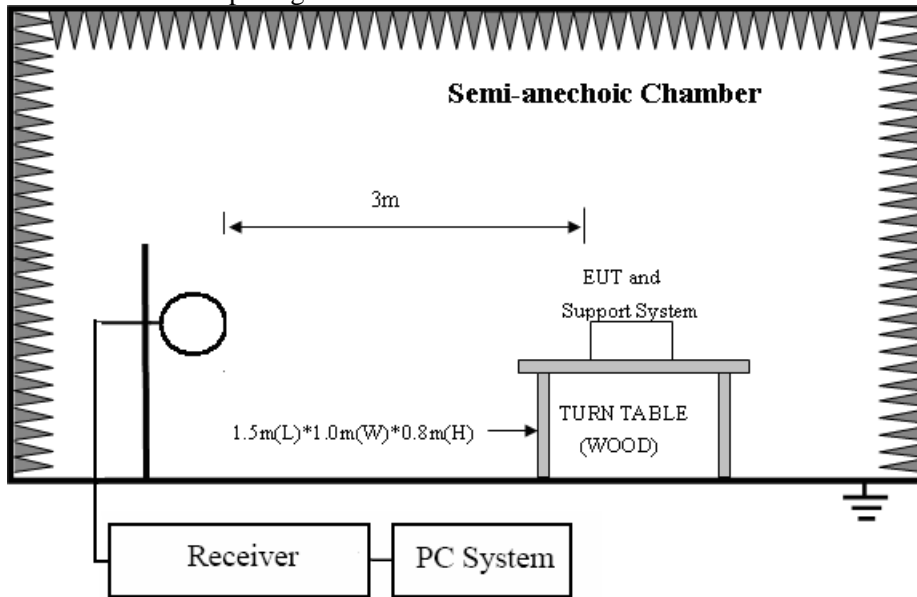

In 3m Anechoic Chamber Test Setup Diagram for 30MHz-1GHz

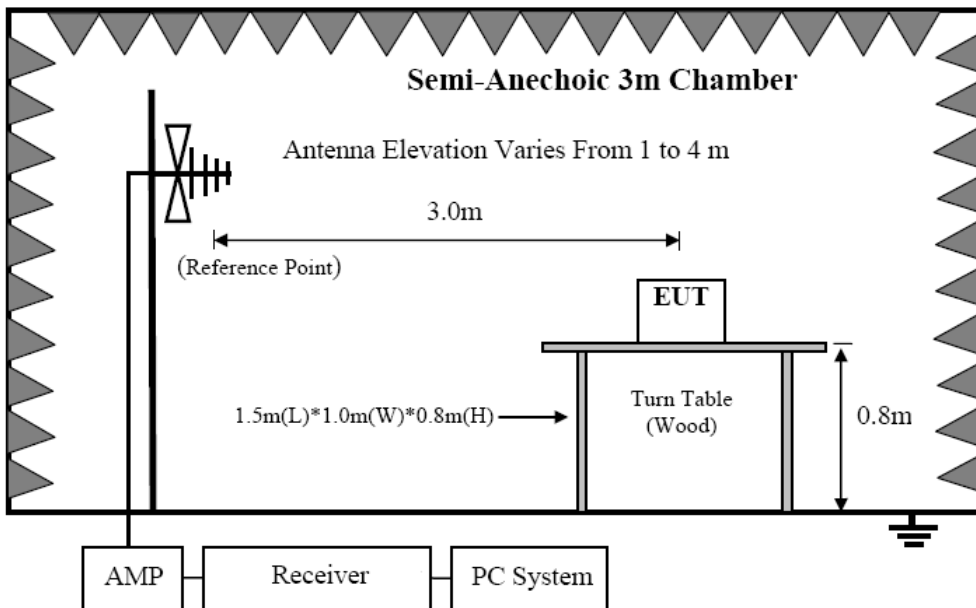

In 3m Anechoic Chamber Test Setup Diagram for frequency above 1GHz

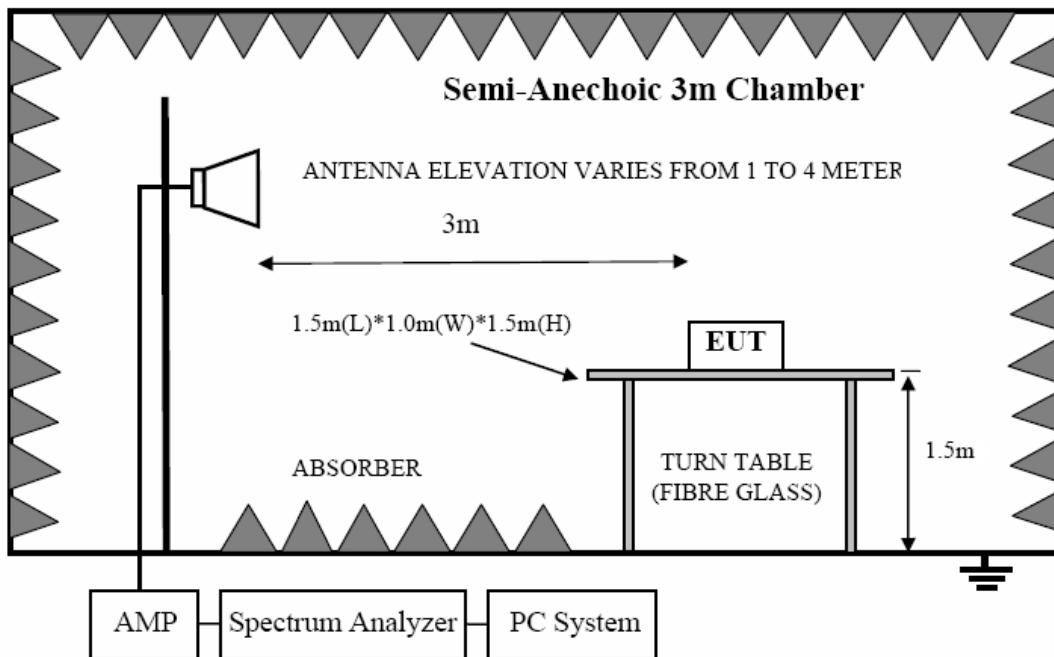

Note: For harmonic emissions test a appropriate high pass filter was inserted in the input port of AMP.

7.2. Limit

8.2.1 FCC 15.205 Restricted frequency band

MHz	MHz	MHz	GHz
0.090 - 0.110	16.42 - 16.423	399.9 - 410	4.5 - 5.15
¹ 0.495 - 0.505	16.69475 - 16.69525	608 - 614	5.35 - 5.46
2.1735 - 2.1905	16.80425 - 16.80475	960 - 1240	7.25 - 7.75
4.125 - 4.128	25.5 - 25.67	1300 - 1427	8.025 - 8.5
4.17725 - 4.17775	37.5 - 38.25	1435 - 1626.5	9.0 - 9.2
4.20725 - 4.20775	73 - 74.6	1645.5 - 1646.5	9.3 - 9.5
6.215 - 6.218	74.8 - 75.2	1660 - 1710	10.6 - 12.7
6.26775 - 6.26825	108 - 121.94	1718.8 - 1722.2	13.25 - 13.4
6.31175 - 6.31225	123 - 138	2200 - 2300	14.47 - 14.5
8.291 - 8.294	149.9 - 150.05	2310 - 2390	15.35 - 16.2
8.362 - 8.366	156.52475 - 156.52525	2483.5 - 2500	17.7 - 21.4
8.37625 - 8.38675	156.7 - 156.9	2690 - 2900	22.01 - 23.12
8.41425 - 8.41475	162.0125 - 167.17	3260 - 3267	23.6 - 24.0
12.29 - 12.293	167.72 - 173.2	3332 - 3339	31.2 - 31.8
12.51975 - 12.52025	240 - 285	3345.8 - 3358	36.43 - 36.5
12.57675 - 12.57725	322 - 335.4	3600 - 4400	(²)

8.2.2 FCC 15.209 Limit.

FREQUENCY MHz	DISTANCE Meters	FIELD STRENGTHS LIMIT	
		μV/m	dB(μV)/m
0.009 ~ 0.490	300	2400/F(KHz)	67.6-20log(F)
0.490 ~ 1.705	30	24000/F(KHz)	87.6-20log(F)
1.705 ~ 30.0	30	30	29.54
30 ~ 88	3	100	40.0
88 ~ 216	3	150	43.5
216 ~ 960	3	200	46.0
960 ~ 1000	3	500	54.0

Above 1000	3	74.0 dB(μ V)/m (Peak) 54.0 dB(μ V)/m (Average)
------------	---	---

Note: (1) The emission limits shown in the above table are based on measurements employing a CISPR QP detector except for the frequency bands 9-90KHz, 110-490KHz and above 1000MHz. Radiated emissions limits in these three bands are based on measurements employing an average detector.

(2) At frequencies below 30MHz, measurement may be performed at a distance closer than that specified, and the limit at closer measurement distance can be extrapolated by below formula:

$$\text{Limit}_{3m}(\text{dBuV/m}) = \text{Limit}_{30m}(\text{dBuV/m}) + 40\text{Log}(30m/3m)$$

8.2.3 Limit for this EUT

All the emissions appearing within 15.205 restricted frequency bands shall not exceed the limits shown in 15.209, all the other emissions shall be at least 20dB below the fundamental emissions, or comply with 15.209 limits.

7.3. Test Procedure

(1) EUT height should be 0.8m for below 1GHz at a semi-anechoic chamber while EUT height should be 1.5m for above 1GHz at full chamber or semi-anechoic chamber ground with absorbers.

(2) The antenna used as below table.

Test frequency range	Test antenna used	Measuring distance
9KHz-30MHz	Active Loop antenna	3 m
30MHz-1GHz	Trilog Broadband Antenna	3 m
1GHz-18GHz	Double Ridged Horn Antenna(1GHz-18GHz)	3 m
18GHz-40GHz	Horn Antenna(18GHz-40GHz)	1 m

According ANSI C63.10:2013 clause 6.4.4.2 and 6.5.3, for measurements below 30 MHz, the loop antenna was positioned with its plane vertical from the EUT and rotated about its vertical axis for maximum response at each azimuth position around the EUT. And the loop antenna also be positioned with its plane horizontal at the specified distance from the EUT. The center of the loop is 1 m above the ground. for measurement above 30MHz, the Trilog Broadband Antenna or Horn Antenna was located 3m from EUT, Measurements were made with the antenna positioned in both the horizontal and vertical planes of

Polarization, and the measurement antenna was varied from 1 m to 4 m. in height above the reference ground plane to obtain the maximum signal strength.

(3) Below pre-scan procedure was first performed in order to find prominent frequency spectrum radiated emissions from 9KHz to 25GHz:

(a) Scanning the peak frequency spectrum with the antenna specified in step (3), and the EUT was rotated 360 degree, the antenna height was varied from 1m to 4m(Except loop antenna, it's fixed 1m above ground.)

(b) Change work frequency or channel of device if practicable.

(c) Change modulation type of device if practicable.

(d) Change power supply range from 85% to 115% of the rated supply voltage

(e) Rotated EUT though three orthogonal axes to determine the attitude of EUT arrangement produces highest

emissions.

Spectrum frequency from 9KHz to 25GHz (tenth harmonic of fundamental frequency) was investigated, and no any obvious emission were detected from 18GHz to 25GHz, so below final test was performed with frequency range from 9KHz to 18GHz.

- (4) For final emissions measurements at each frequency of interest, the EUT was rotated and the antenna height was varied between 1m and 4m in order to maximize the emission. Measurements in both horizontal and vertical polarities were made and the data was recorded. In order to find the maximum emission, the relative positions of equipments and all of the interface cables were changed according to ANSI C63.10 2013 on Radiated Emission test.
- (5) The emissions from 9KHz to 1GHz were measured based on CISPR QP detector except for the frequency bands 9-90KHz, 110-490KHz, for emissions from 9KHz-90KHz,110KHz-490KHz and above 1GHz were measured based on average detector, for emissions above 1GHz, peak emissions also be measured and need comply with Peak limit.
- (6) The emissions from 9KHz to 1GHz, QP or average values were measured with EMI receiver with below RBW

Frequency band	RBW
9KHz-150KHz	200Hz
150KHz-30MHz	9KHz
30MHz-1GHz	120KHz

- (7) For emissions above 1GHz, both Peak and Average level were measured with Spectrum Analyzer, and the RBW is set at 1MHz, VBW is set at 3MHz for Peak measure; RMS detector RBW 1MHz VBW 3MHz for Average measure(according ANSI C63.10:2013 clause 4.2.3.2.3 procedure for average measure).

7.4. Test result

PASS. (See below detailed test result)

All the emissions except fundamental emission from 9KHz to 25GHz were comply with 15.209 limit.

Note1: According exploratory test no any obvious emission were detected from 9kHz to 30MHz and 18GHz to 25GHz, so the final test was performed with frequency range from 30MHz to 18GHz and recorded in below.

Note2: For emissions below 1GHz, according exploratory explorer test, when change Tx mode and channel, have no distinct influence on emissions level, so for emissions below 1GHz, the final test was only performed with EUT working in ANT2+ANT1, 11b, Tx CH6 mode.

Radiated Emission test (below 1GHz)

TR-4-E-009 Radiated Emission Test Result

Test Site	: DDT 3m Chamber 1#	D:\2017 RE1# Report Data\Q17090505-1E\Q17090505-1E FCC 30-1G.EM6
Test Date	: 2017-10-15	Tested By : TALENT
EUT	: Wireless Adaptor and 120W Digital Amplif	Model Number : ADAPT+AMP
Power Supply	: 110V/50Hz	Test Mode : TX mode
Condition	: Temp:24.5°C,Humi:55%, Press:100.1kPa	Antenna/Distance : 2016 VULB9163 1#/3m/VERTICAL
Memo	:	

Data: 5

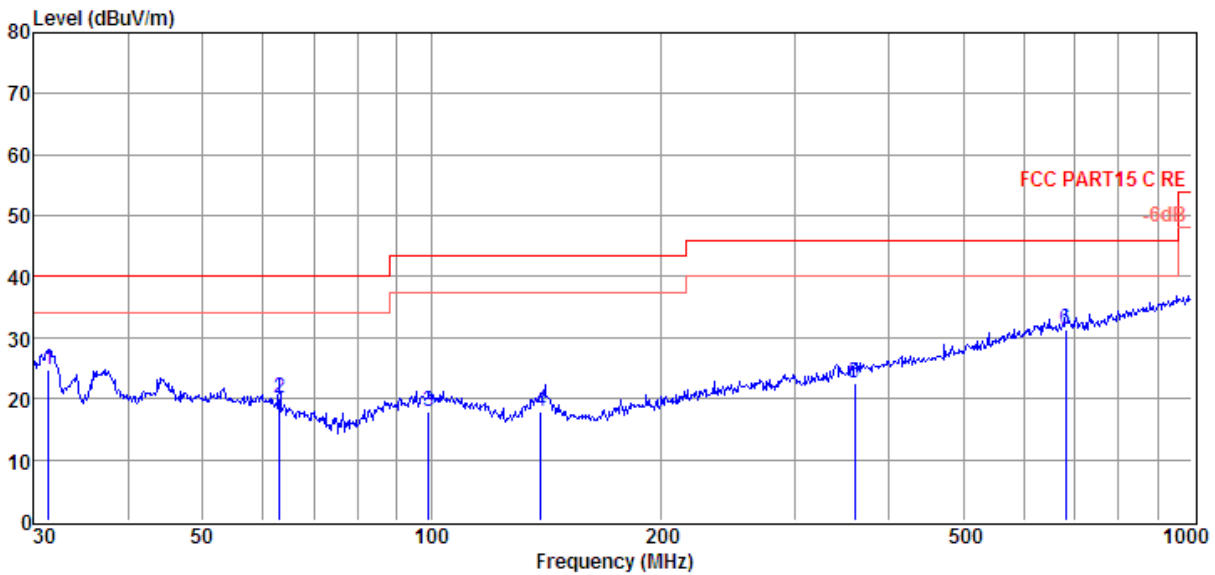

Item (Mark)	Freq. (MHz)	Read Level (dBμV)	Antenna Factor (dB/m)	Cable Loss (dB)	Result Level (dBμV/m)	Limit Line (dBμV/m)	Over Limit (dB)	Detector	Polarization
1	31.40	9.71	11.31	3.68	24.70	40.00	-15.30	QP	VERTICAL
2	63.09	5.83	10.32	4.00	20.15	40.00	-19.85	QP	VERTICAL
3	99.18	1.62	11.94	4.29	17.85	43.50	-25.65	QP	VERTICAL
4	139.36	6.02	7.44	4.53	17.99	43.50	-25.51	QP	VERTICAL
5	360.45	2.04	15.01	5.63	22.68	46.00	-23.32	QP	VERTICAL
6	682.35	4.80	19.88	6.77	31.45	46.00	-14.55	QP	VERTICAL

- Note: 1. Result Level = Read Level + Antenna Factor + Cable loss.
 2. If Peak Result complies with QP limit, QP Result is deemed to comply with QP limit.
 3. Test setup: RBW: 120 kHz, VBW: 300 kHz, Sweep time: auto.

TR-4-E-009 Radiated Emission Test Result

Test Site	: DDT 3m Chamber 1#	D:\2017 RE1# Report Data\Q17090505-1E\Q17090505-1E FCC 30-1G.EM6
Test Date	: 2017-10-15	Tested By : TALENT
EUT	: Wireless Adaptor and 120W Digital Amplif	Model Number : ADAPT+AMP
Power Supply	: 110V/50Hz	Test Mode : TX mode
Condition	: Temp:24.5'C,Humi:55%, Press:100.1kPa	Antenna/Distance : 2016 VULB9163 1#/3m/HORIZONTAL
Memo	:	

Data: 6

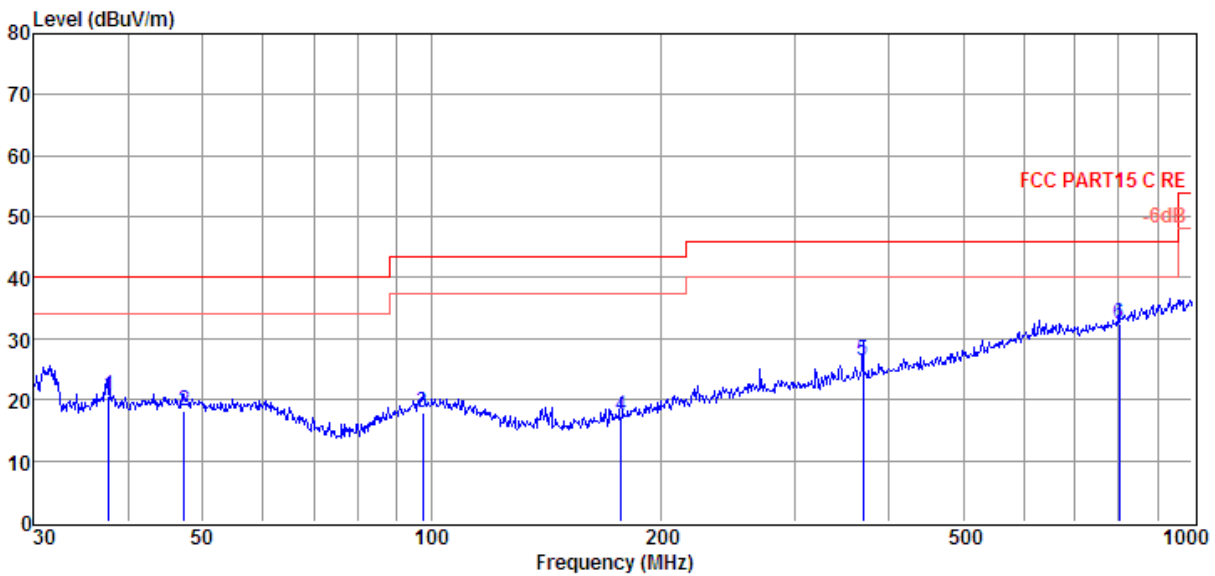

Item (Mark)	Freq. (MHz)	Read Level (dBμV)	Antenna Factor (dB/m)	Cable Loss (dB)	Result Level (dBμV/m)	Limit Line (dBμV/m)	Over Limit (dB)	Detector	Polarization
1	37.68	4.82	12.08	3.77	20.67	40.00	-19.33	QP	HORIZONTAL
2	47.33	1.89	12.27	3.86	18.02	40.00	-21.98	QP	HORIZONTAL
3	97.46	1.68	11.80	4.28	17.76	43.50	-25.74	QP	HORIZONTAL
4	177.51	3.44	9.05	4.77	17.26	43.50	-26.24	QP	HORIZONTAL
5	369.41	5.44	15.19	5.67	26.30	46.00	-19.70	QP	HORIZONTAL
6	801.79	4.15	21.20	7.13	32.48	46.00	-13.52	QP	HORIZONTAL

- Note: 1. Result Level = Read Level + Antenna Factor + Cable loss.
 2. If Peak Result complies with QP limit, QP Result is deemed to comply with QP limit.
 3. Test setup: RBW: 120 kHz, VBW: 300 kHz, Sweep time: auto.

Radiated Emission test (above 1GHz)

Freq (MHz)	Read level (dB μ V)	Antenna Factor (dB/m)	PRM Factor (dB)	Cable Loss (dB)	Result Level (dB μ V/m)	Limit (dB μ V/m)	Margin (dB)	Detector type	Polarization
11b CH1									
4196.00	35.66	33.56	29.08	7.83	47.97	74.00	-26.03	Peak	HORIZONTAL
6950.00	34.88	36.16	30.34	10.39	51.09	74.00	-22.91	Peak	HORIZONTAL
8735.00	34.67	36.35	32.07	11.73	50.68	74.00	-23.32	Peak	HORIZONTAL
9670.00	34.34	36.57	32.77	12.39	50.53	74.00	-23.47	Peak	HORIZONTAL
12050.00	32.54	37.67	34.82	14.26	49.65	74.00	-24.35	Peak	HORIZONTAL
13274.00	34.90	39.08	35.50	14.74	53.22	74.00	-20.78	Peak	HORIZONTAL
4179.00	34.32	33.55	29.07	7.81	46.61	74.00	-27.39	Peak	VERTICAL
4944.00	34.58	33.71	29.34	8.63	47.58	74.00	-26.42	Peak	VERTICAL
6916.00	35.81	36.13	30.33	10.37	51.98	74.00	-22.02	Peak	VERTICAL
8990.00	33.85	37.46	32.32	11.81	50.80	74.00	-23.20	Peak	VERTICAL
11285.00	33.67	37.17	34.35	13.54	50.03	74.00	-23.97	Peak	VERTICAL
13206.00	34.79	39.01	35.54	14.73	52.99	74.00	-21.01	Peak	VERTICAL
11b CH6									
4179.00	34.98	33.55	29.07	7.81	47.27	74.00	-26.73	Peak	HORIZONTAL
5709.00	32.50	34.83	29.22	9.38	47.49	74.00	-26.51	Peak	HORIZONTAL
7851.00	34.55	36.67	31.07	11.05	51.20	74.00	-22.80	Peak	HORIZONTAL
9636.00	33.96	36.54	32.75	12.38	50.13	74.00	-23.87	Peak	HORIZONTAL
10996.00	32.73	37.79	33.98	13.48	50.02	74.00	-23.98	Peak	HORIZONTAL
13240.00	33.68	39.04	35.50	14.73	51.95	74.00	-22.05	Peak	HORIZONTAL
3805.00	35.75	32.84	29.16	7.49	46.92	74.00	-27.08	Peak	VERTICAL
4944.00	34.25	33.71	29.34	8.63	47.25	74.00	-26.75	Peak	VERTICAL
6525.00	33.78	35.82	29.90	9.96	49.66	74.00	-24.34	Peak	VERTICAL
8735.00	34.38	36.35	32.07	11.73	50.39	74.00	-23.61	Peak	VERTICAL
10996.00	32.56	37.79	33.98	13.48	49.85	74.00	-24.15	Peak	VERTICAL
12101.00	32.84	37.74	34.87	14.30	50.01	74.00	-23.99	Peak	VERTICAL
11b CH11									
3805.00	35.57	32.84	29.16	7.49	46.74	74.00	-27.26	Peak	HORIZONTAL
4145.00	35.20	33.52	29.07	7.77	47.42	74.00	-26.58	Peak	HORIZONTAL
6984.00	34.64	36.19	30.38	10.40	50.85	74.00	-23.15	Peak	HORIZONTAL
7868.00	33.40	36.67	31.08	11.06	50.05	74.00	-23.95	Peak	HORIZONTAL
9755.00	32.87	36.66	32.82	12.40	49.11	74.00	-24.89	Peak	HORIZONTAL
12594.00	33.36	38.40	35.36	14.65	51.05	74.00	-22.95	Peak	HORIZONTAL
3499.00	35.99	31.90	29.54	7.30	45.65	74.00	-28.35	Peak	VERTICAL
5284.00	32.75	34.28	29.31	8.96	46.68	74.00	-27.32	Peak	VERTICAL
6984.00	34.89	36.19	30.38	10.40	51.10	74.00	-22.90	Peak	VERTICAL
8225.00	33.91	36.06	31.33	11.36	50.00	74.00	-24.00	Peak	VERTICAL
9041.00	33.84	37.41	32.34	11.87	50.78	74.00	-23.22	Peak	VERTICAL
12084.00	32.31	37.72	34.85	14.30	49.48	74.00	-24.52	Peak	VERTICAL

Note: 1.30MHz~25GHz: (Scan with 11b mode ANT 1+ ANT 2, 11g mode ANT 1+ANT 2, 11n HT20 mode ANT 1+ ANT 2, 11n HT40 mode ANT 1+ ANT 2, the worst case is 11b ANTI+ANT 2 mode)

2. Result Level = Read Level + Antenna Factor + Cable loss - PRM Factor.

3. Test setup: RBW: 1 MHz, VBW: 3 MHz, Sweep time: auto.

4. For emissions above 1GHz. If peak results comply with AV limit, AV Result is deemed to comply with AV limit.

8. Radiated Band Edge Compliance

8.1. Block diagram of test setup

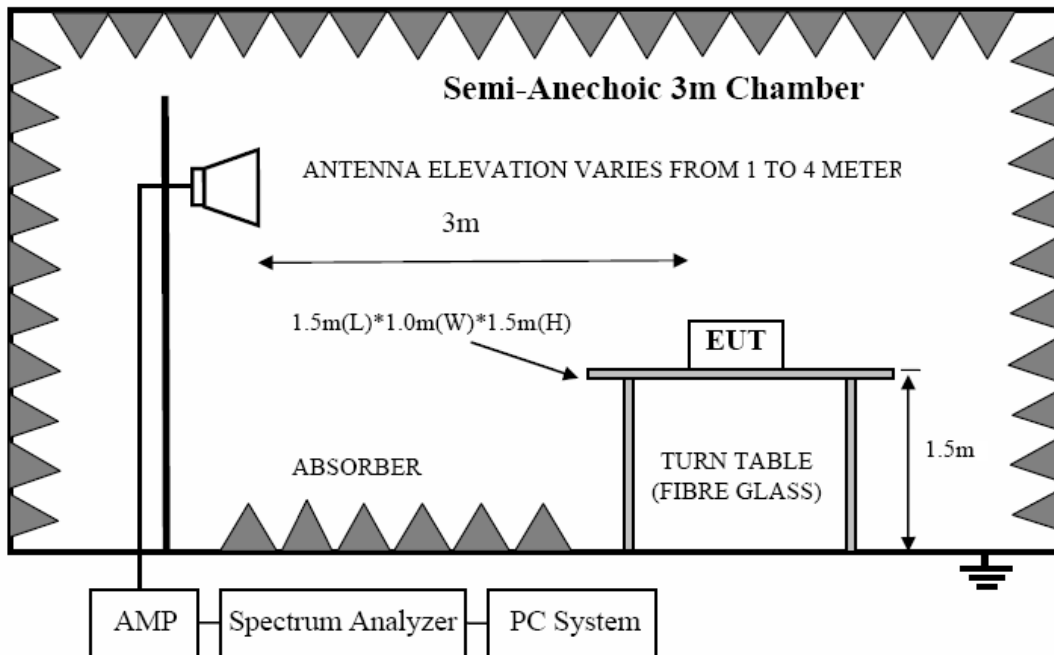

8.2. Limit

All restricted frequency bands shall not exceed the limits shown in 15.209, all the other emissions outside operation frequency band 2400MHz to 2483.5MHz shall be at least 20dB below the fundamental emissions, or comply with RSS-Gen Issue 3 clause 7.2.5 (Same as FCC 15.209) limits.

8.3. Test Procedure

Same with clause 8.3 except change investigated frequency range from 2100MHz to 2450MHz and 2450MHz to 2500MHz.

Remark: All restriction band have been tested, and only the worse case is shown in report.

8.4. Test result

PASS. (See below detailed test result)

TR-4-E-009 Radiated Emission Test Result

Test Site : DDT 3m Chamber 1# D:\2017 RE1# Report Data\Q17090505-1E\RF FCC 1-18G 2.4GWIFI.EM6
Test Date : 2017-10-15 **Tested By** : TALENT
EUT : Wireless Adaptor and 120W Digital Amplifier **Model Number** : ADAPT+AMP
Power Supply : AC 120V/60Hz **Test Mode** : TX mode 2412MHz
Condition : Temp:24.5°C,Humi:55%,
 Press:100.1kPa **Antenna/Distance** : 2016 HF907/3m/VERTICAL
Memo : 11b ANT1+ANT2

Data: 13

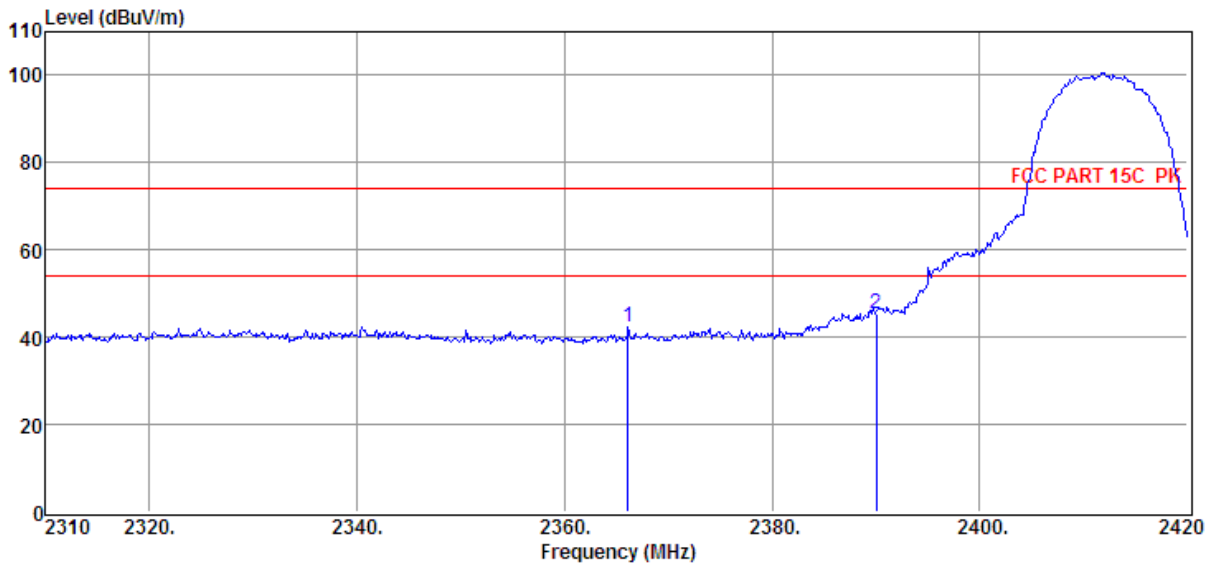

Item (Mark)	Freq. (MHz)	Read Level (dBμV)	Antenna Factor (dB/m)	PRM Factor (dB)	Cable Loss (dB)	Result Level (dBμV/m)	Limit Line (dBμV/m)	Over Limit (dB)	Detector	Polarization
1	2366.10	35.96	29.68	29.37	6.01	42.28	74.00	-31.72	Peak	VERTICAL
2	2390.00	38.91	29.78	29.42	6.03	45.30	74.00	-28.70	Peak	VERTICAL

Note: 1. Result Level = Read Level + Antenna Factor + Cable loss - PRM Factor.
 2. If Peak Result complies with AV limit, AV Result is deemed to comply with AV limit.
 3. Test setup: RBW: 1 MHz, VBW: 3 MHz, Sweep time: auto.

TR-4-E-009 Radiated Emission Test Result

Test Site : DDT 3m Chamber 1# D:\2017 RE1# Report Data\Q17090505-1E\RF FCC 1-18G 2.4GWIFI.EM6
Test Date : 2017-10-15 **Tested By** : TALENT
EUT : Wireless Adaptor and 120W Digital Amplifier **Model Number** : ADAPT+AMP
Power Supply : AC 120V/60Hz **Test Mode** : TX mode 2412MHz
Condition : Temp:24.5°C,Humi:55%, Press:100.1kPa **Antenna/Distance** : 2016 HF907/3m/HORIZONTAL
Memo : 11b ANT1+ANT2

Data: 14

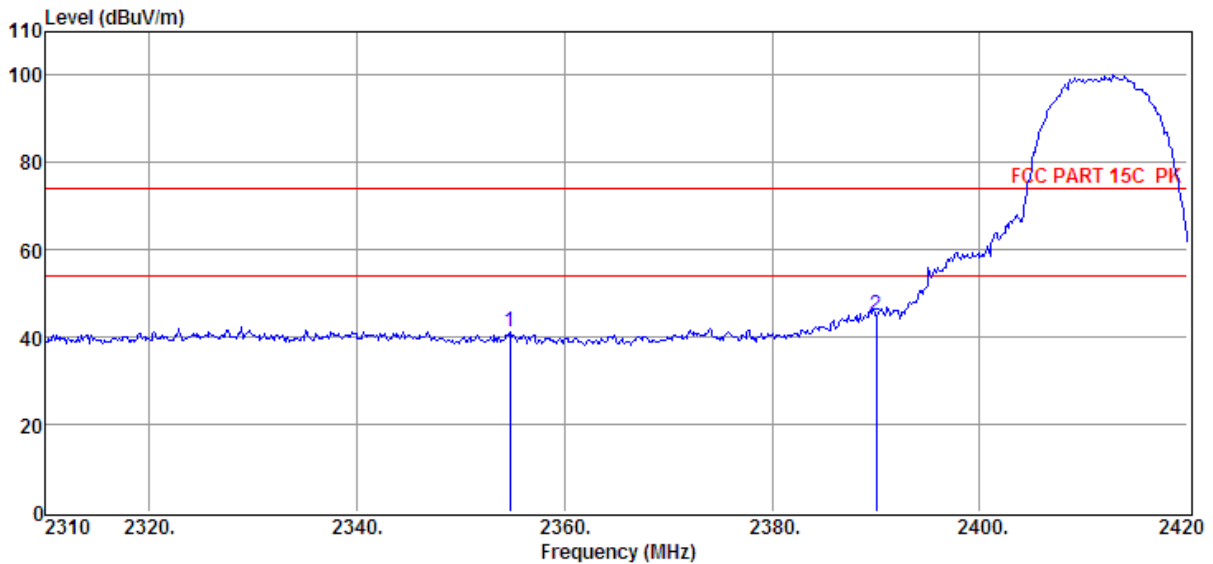

Item (Mark)	Freq. (MHz)	Read Level (dBμV)	Antenna Factor (dB/m)	PRM Factor (dB)	Cable Loss (dB)	Result Level (dBμV/m)	Limit Line (dBμV/m)	Over Limit (dB)	Detector	Polarization
1	2354.77	34.84	29.64	29.34	5.96	41.10	74.00	-32.90	Peak	HORIZONTAL
2	2390.00	38.48	29.78	29.42	6.03	44.87	74.00	-29.13	Peak	HORIZONTAL

Note: 1. Result Level = Read Level + Antenna Factor + Cable loss - PRM Factor.
 2. If Peak Result complies with AV limit, AV Result is deemed to comply with AV limit.
 3. Test setup: RBW: 1 MHz, VBW: 3 MHz, Sweep time: auto.

TR-4-E-009 Radiated Emission Test Result

Test Site : DDT 3m Chamber 1# D:\2017 RE1# Report Data\Q17090505-1E\RF FCC 1-18G 2.4GWIFI.EM6
Test Date : 2017-10-15 **Tested By** : TALENT
EUT : Wireless Adaptor and 120W Digital Amplifier **Model Number** : ADAPT+AMP
Power Supply : AC 120V/60Hz **Test Mode** : TX mode 2462MHz
Condition : Temp:24.5°C,Humi:55%,
 Press:100.1kPa **Antenna/Distance** : 2016 HF907/3m/HORIZONTAL
Memo : 11b ANT1+ANT2

Data: 15

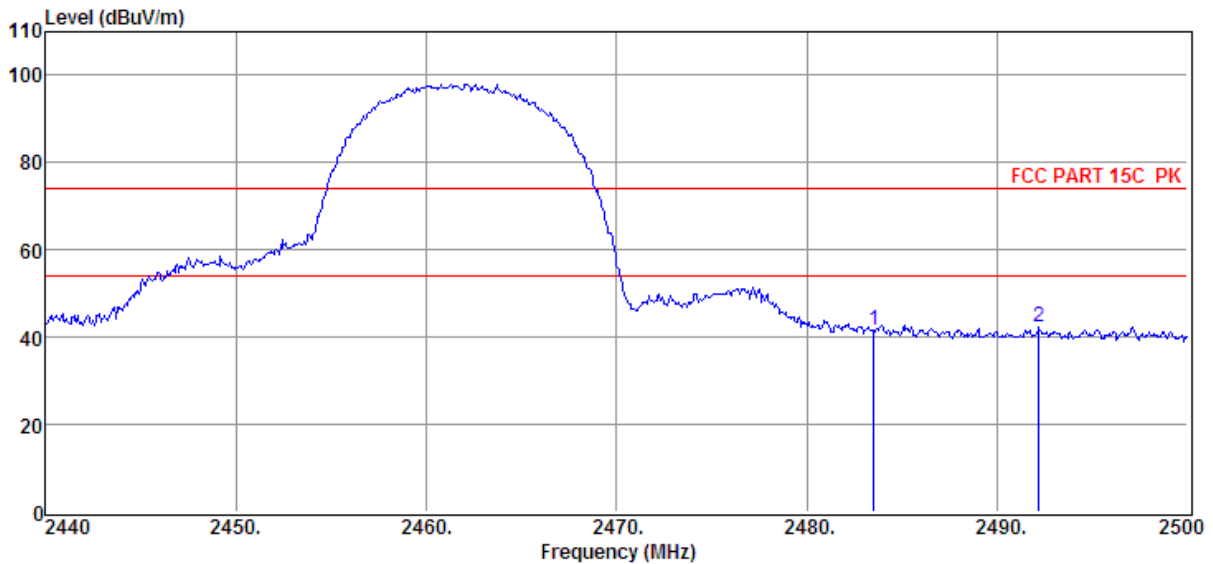

Item (Mark)	Freq. (MHz)	Read Level (dBμV)	Antenna Factor (dB/m)	PRM Factor (dB)	Cable Loss (dB)	Result Level (dBμV/m)	Limit Line (dBμV/m)	Over Limit (dB)	Detector	Polarization
1	2483.50	34.90	30.14	29.71	6.13	41.46	74.00	-32.54	Peak	HORIZONTAL
2	2492.20	35.65	30.17	29.73	6.17	42.26	74.00	-31.74	Peak	HORIZONTAL

- Note: 1. Result Level = Read Level + Antenna Factor + Cable loss - PRM Factor.
 2. If Peak Result complies with AV limit, AV Result is deemed to comply with AV limit.
 3. Test setup: RBW: 1 MHz, VBW: 3 MHz, Sweep time: auto.

TR-4-E-009 Radiated Emission Test Result

Test Site : DDT 3m Chamber 1# D:\2017 RE1# Report Data\Q17090505-1E\RF FCC 1-18G 2.4GWIFI.EM6
Test Date : 2017-10-15 **Tested By** : TALENT
EUT : Wireless Adaptor and 120W Digital Amplifier **Model Number** : ADAPT+AMP
Power Supply : AC 120V/60Hz **Test Mode** : TX mode 2462MHz
Condition : Temp:24.5°C,Humi:55%,
 Press:100.1kPa **Antenna/Distance** : 2016 HF907/3m/VERTICAL
Memo : 11b ANT1+ANT2

Data: 16

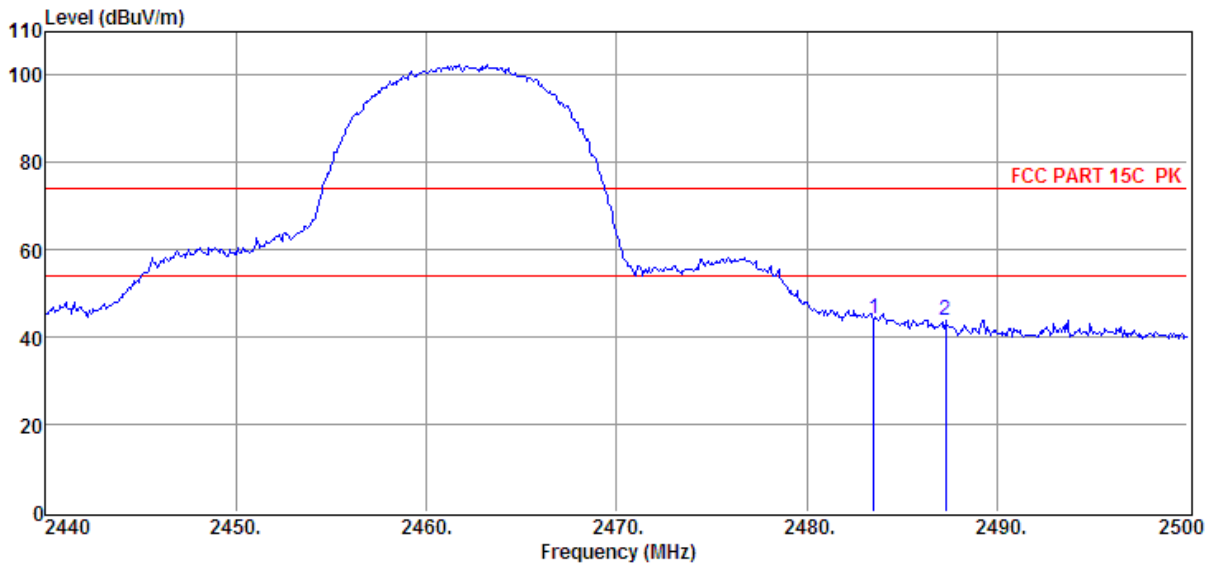

Item (Mark)	Freq. (MHz)	Read Level (dBμV)	Antenna Factor (dB/m)	PRM Factor (dB)	Cable Loss (dB)	Result Level (dBμV/m)	Limit Line (dBμV/m)	Over Limit (dB)	Detector	Polarization
1	2483.50	37.62	30.14	29.71	6.13	44.18	74.00	-29.82	Peak	VERTICAL
2	2487.28	37.31	30.15	29.71	6.13	43.88	74.00	-30.12	Peak	VERTICAL

Note: 1. Result Level = Read Level + Antenna Factor + Cable loss - PRM Factor.
 2. If Peak Result complies with AV limit, AV Result is deemed to comply with AV limit.
 3. Test setup: RBW: 1 MHz, VBW: 3 MHz, Sweep time: auto.

TR-4-E-009 Radiated Emission Test Result

Test Site : DDT 3m Chamber 1# D:\2017 RE1# Report Data\Q17090505-1E\RF FCC 1-18G 2.4GWIFI.EM6
Test Date : 2017-10-15 **Tested By** : TALENT
EUT : Wireless Adaptor and 120W Digital Amplifier **Model Number** : ADAPT+AMP
Power Supply : AC 120V/60Hz **Test Mode** : TX mode 2412MHz
Condition : Temp:24.5°C,Humi:55%,
 Press:100.1kPa **Antenna/Distance** : 2016 HF907/3m/VERTICAL
Memo : 11g ANT1+ANT2

Data: 17

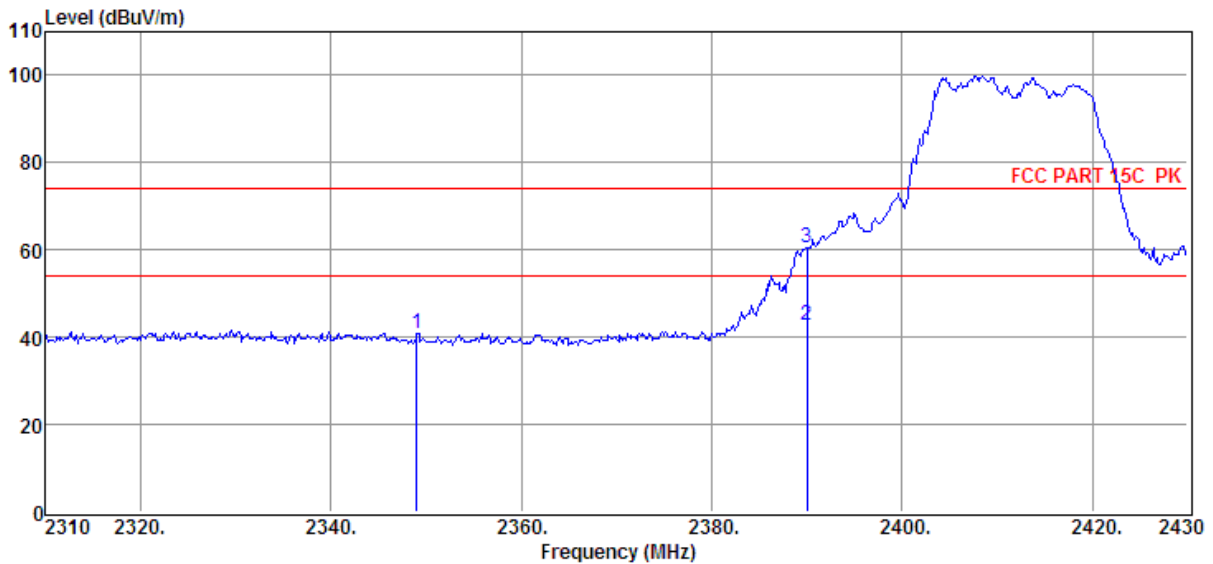

Item (Mark)	Freq. (MHz)	Read Level (dBμV)	Antenna Factor (dB/m)	PRM Factor (dB)	Cable Loss (dB)	Result Level (dBμV/m)	Limit Line (dBμV/m)	Over Limit (dB)	Detector	Polarization
1	2349.00	34.74	29.61	29.33	5.96	40.98	74.00	-33.02	Peak	VERTICAL
2	2390.00	36.31	29.78	29.42	6.03	42.70	54.00	-11.30	Average	VERTICAL
3	2390.00	53.93	29.78	29.42	6.03	60.32	74.00	-13.68	Peak	VERTICAL

Note: 1. Result Level = Read Level + Antenna Factor + Cable loss - PRM Factor.
 2. If Peak Result complies with AV limit, AV Result is deemed to comply with AV limit.
 3. Test setup: RBW: 1 MHz, VBW: 3 MHz, Sweep time: auto.

TR-4-E-009 Radiated Emission Test Result

Test Site : DDT 3m Chamber 1# D:\2017 RE1# Report Data\Q17090505-1E\RF FCC 1-18G 2.4GWIFI.EM6
Test Date : 2017-10-15 **Tested By** : TALENT
EUT : Wireless Adaptor and 120W Digital Amplifier **Model Number** : ADAPT+AMP
Power Supply : AC 120V/60Hz **Test Mode** : TX mode 2462MHz
Condition : Temp:24.5°C,Humi:55%,
 Press:100.1kPa **Antenna/Distance** : 2016 HF907/3m/HORIZONTAL
Memo : 11g ANT1+ANT2

Data: 18

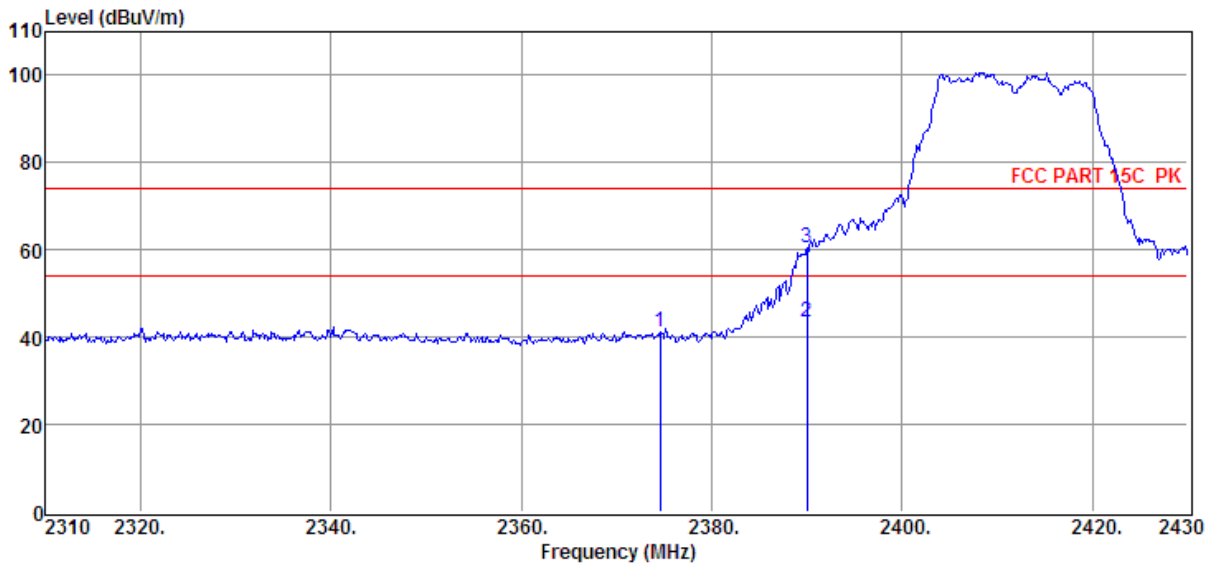

Item (Mark)	Freq. (MHz)	Read Level (dBμV)	Antenna Factor (dB/m)	PRM Factor (dB)	Cable Loss (dB)	Result Level (dBμV/m)	Limit Line (dBμV/m)	Over Limit (dB)	Detector	Polarization
1	2374.56	34.98	29.72	29.39	6.01	41.32	74.00	-32.68	Peak	HORIZONTAL
2	2390.00	37.18	29.78	29.42	6.03	43.57	54.00	-10.43	Average	HORIZONTAL
3	2390.00	54.12	29.78	29.42	6.03	60.51	74.00	-13.49	Peak	HORIZONTAL

Note: 1. Result Level = Read Level + Antenna Factor + Cable loss - PRM Factor.
 2. If Peak Result complies with AV limit, AV Result is deemed to comply with AV limit.
 3. Test setup: RBW: 1 MHz, VBW: 3 MHz, Sweep time: auto.

TR-4-E-009 Radiated Emission Test Result

Test Site : DDT 3m Chamber 1# D:\2017 RE1# Report Data\Q17090505-1E\RF FCC 1-18G 2.4GWIFI.EM6
Test Date : 2017-10-15 **Tested By** : TALENT
EUT : Wireless Adaptor and 120W Digital Amplifier **Model Number** : ADAPT+AMP
Power Supply : AC 120V/60Hz **Test Mode** : TX mode 2462MHz
Condition : Temp:24.5°C,Humi:55%,
 Press:100.1kPa **Antenna/Distance** : 2016 HF907/3m/HORIZONTAL
Memo : 11g ANT1+ANT2

Data: 19

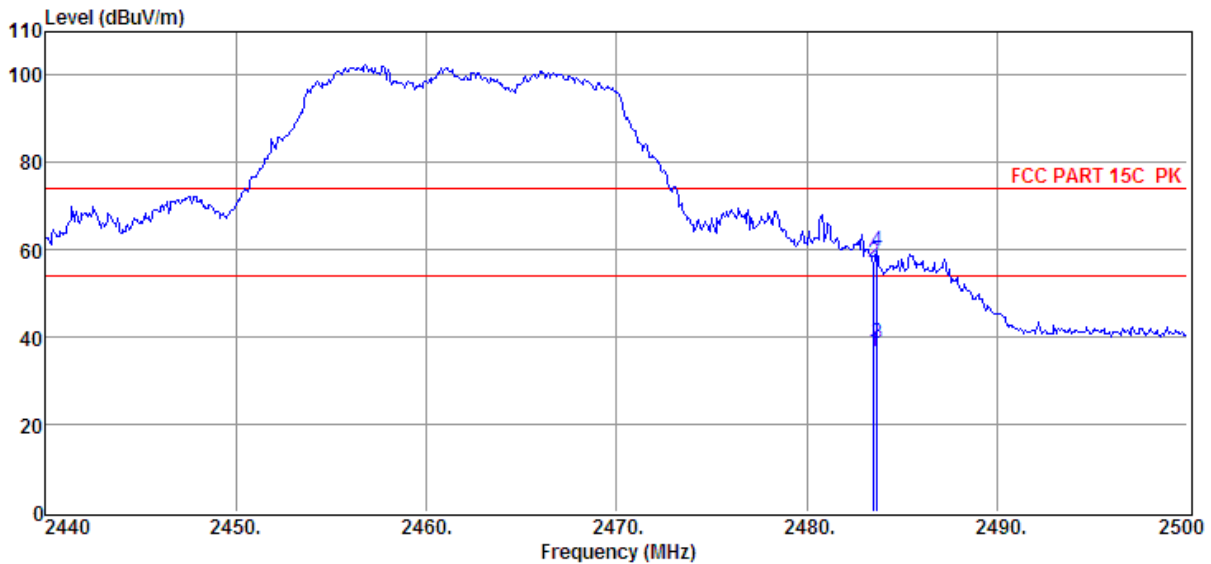

Item (Mark)	Freq. (MHz)	Read Level (dBμV)	Antenna Factor (dB/m)	PRM Factor (dB)	Cable Loss (dB)	Result Level (dBμV/m)	Limit Line (dBμV/m)	Over Limit (dB)	Detector	Polarization
1	2483.50	30.20	30.14	29.71	6.13	36.76	54.00	-17.24	Average	HORIZONTAL
2	2483.50	50.55	30.14	29.71	6.13	57.11	74.00	-16.89	Peak	HORIZONTAL
3	2483.68	32.12	30.14	29.71	6.13	38.68	54.00	-15.32	Average	HORIZONTAL
4	2483.68	53.21	30.14	29.71	6.13	59.77	74.00	-14.23	Peak	HORIZONTAL

- Note: 1. Result Level = Read Level + Antenna Factor + Cable loss - PRM Factor.
 2. If Peak Result complies with AV limit, AV Result is deemed to comply with AV limit.
 3. Test setup: RBW: 1 MHz, VBW: 3 MHz, Sweep time: auto.

TR-4-E-009 Radiated Emission Test Result

Test Site : DDT 3m Chamber 1# D:\2017 RE1# Report Data\Q17090505-1E\RF FCC 1-18G 2.4GWIFI.EM6
Test Date : 2017-10-15 **Tested By** : TALENT
EUT : Wireless Adaptor and 120W Digital Amplifier **Model Number** : ADAPT+AMP
Power Supply : AC 120V/60Hz **Test Mode** : TX mode 2462MHz
Condition : Temp:24.5°C,Humi:55%,
 Press:100.1kPa **Antenna/Distance** : 2016 HF907/3m/VERTICAL
Memo : 11g ANT1+ANT2

Data: 20

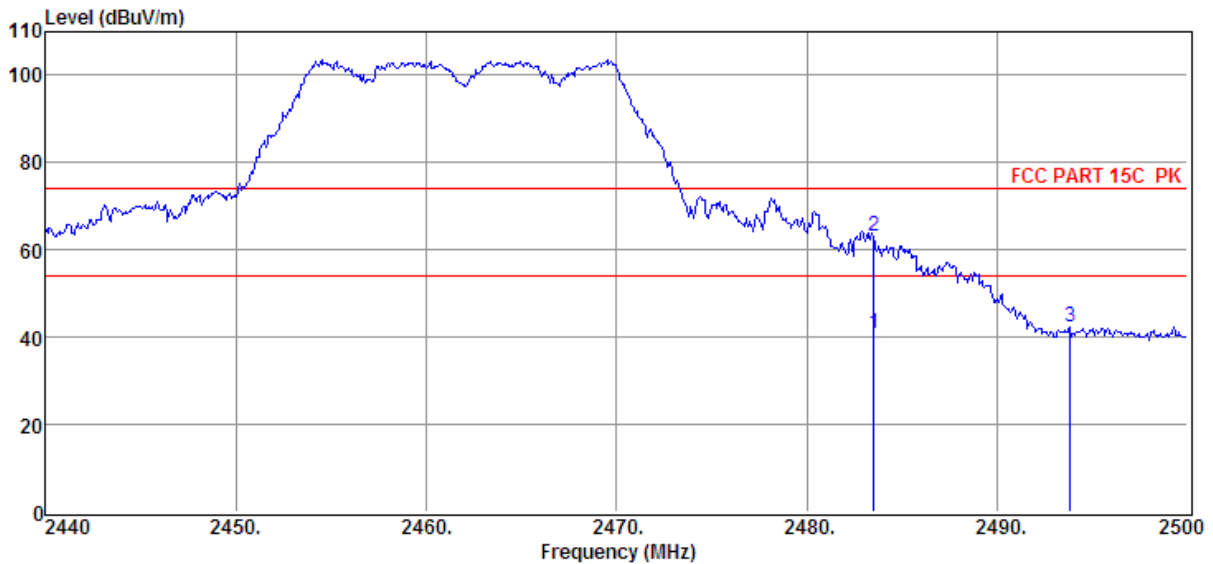

Item (Mark)	Freq. (MHz)	Read Level (dBμV)	Antenna Factor (dB/m)	PRM Factor (dB)	Cable Loss (dB)	Result Level (dBμV/m)	Limit Line (dBμV/m)	Over Limit (dB)	Detector	Polarization
1	2483.50	34.24	30.14	29.71	6.13	40.80	54.00	-13.20	Average	VERTICAL
2	2483.50	56.57	30.14	29.71	6.13	63.13	74.00	-10.87	Peak	VERTICAL
3	2493.82	35.73	30.18	29.73	6.17	42.35	74.00	-31.65	Peak	VERTICAL

Note: 1. Result Level = Read Level + Antenna Factor + Cable loss - PRM Factor.
 2. If Peak Result complies with AV limit, AV Result is deemed to comply with AV limit.
 3. Test setup: RBW: 1 MHz, VBW: 3 MHz, Sweep time: auto.

TR-4-E-009 Radiated Emission Test Result

Test Site : DDT 3m Chamber 1# D:\2017 RE1# Report Data\Q17090505-1E\RF FCC 1-18G 2.4GWIFI.EM6
Test Date : 2017-10-15 **Tested By** : TALENT
EUT : Wireless Adaptor and 120W Digital Amplifier **Model Number** : ADAPT+AMP
Power Supply : AC 120V/60Hz **Test Mode** : TX mode 2412MHz
Condition : Temp:24.5°C,Humi:55%,
 Press:100.1kPa **Antenna/Distance** : 2016 HF907/3m/VERTICAL
Memo : 11n20 ANT1+ANT2

Data: 21

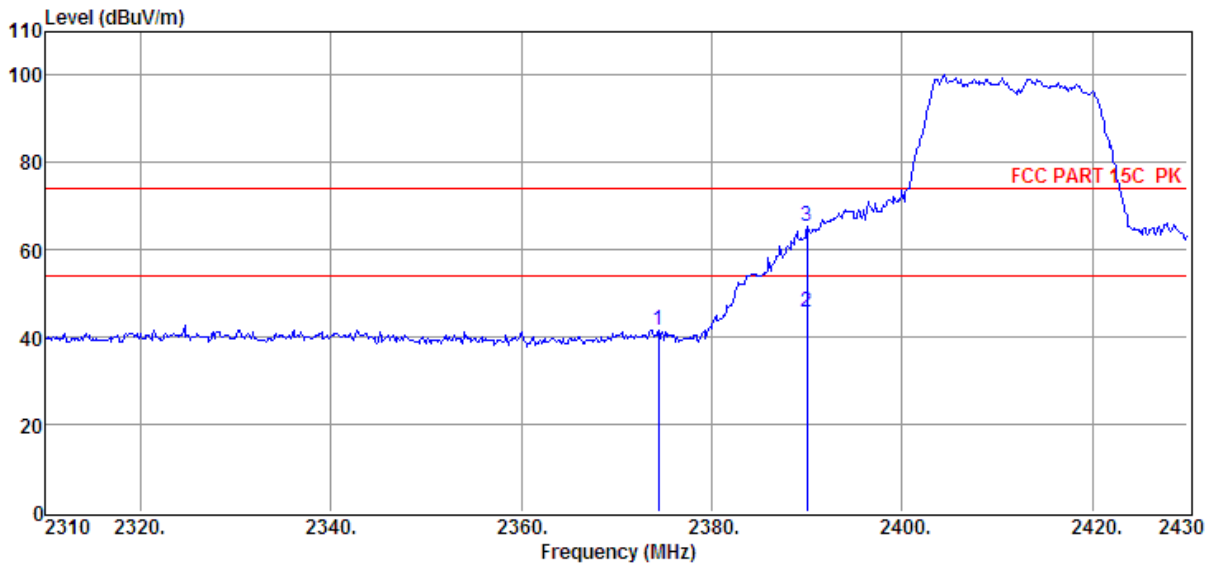

Item (Mark)	Freq. (MHz)	Read Level (dBμV)	Antenna Factor (dB/m)	PRM Factor (dB)	Cable Loss (dB)	Result Level (dBμV/m)	Limit Line (dBμV/m)	Over Limit (dB)	Detector	Polarization
1	2374.44	35.42	29.72	29.39	6.01	41.76	74.00	-32.24	Peak	VERTICAL
2	2390.00	39.44	29.78	29.42	6.03	45.83	54.00	-8.17	Average	VERTICAL
3	2390.00	58.84	29.78	29.42	6.03	65.23	74.00	-8.77	Peak	VERTICAL

- Note: 1. Result Level = Read Level + Antenna Factor + Cable loss - PRM Factor.
 2. If Peak Result complies with AV limit, AV Result is deemed to comply with AV limit.
 3. Test setup: RBW: 1 MHz, VBW: 3 MHz, Sweep time: auto.

TR-4-E-009 Radiated Emission Test Result

Test Site : DDT 3m Chamber 1# D:\2017 RE1# Report Data\Q17090505-1E\RF FCC 1-18G 2.4GWIFI.EM6
Test Date : 2017-10-15 **Tested By** : TALENT
EUT : Wireless Adaptor and 120W Digital Amplifier **Model Number** : ADAPT+AMP
Power Supply : AC 120V/60Hz **Test Mode** : TX mode 2412MHz
Condition : Temp:24.5°C,Humi:55%,
 Press:100.1kPa **Antenna/Distance** : 2016 HF907/3m/HORIZONTAL
Memo : 11n20 ANT1+ANT2

Data: 22

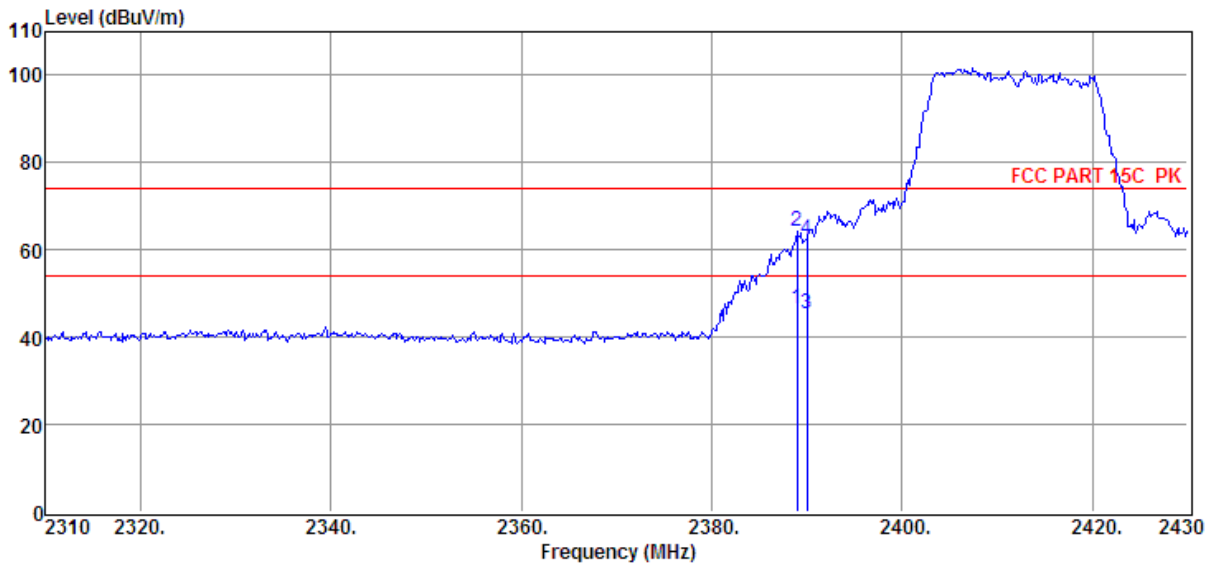

Item (Mark)	Freq. (MHz)	Read Level (dBμV)	Antenna Factor (dB/m)	PRM Factor (dB)	Cable Loss (dB)	Result Level (dBμV/m)	Limit Line (dBμV/m)	Over Limit (dB)	Detector	Polarization
1	2388.96	40.14	29.77	29.42	6.01	46.50	54.00	-7.50	Average	HORIZONTAL
2	2388.96	58.07	29.77	29.42	6.01	64.43	74.00	-9.57	Peak	HORIZONTAL
3	2390.00	38.80	29.78	29.42	6.03	45.19	54.00	-8.81	Average	HORIZONTAL
4	2390.00	55.80	29.78	29.42	6.03	62.19	74.00	-11.81	Peak	HORIZONTAL

- Note: 1. Result Level = Read Level + Antenna Factor + Cable loss - PRM Factor.
 2. If Peak Result complies with AV limit, AV Result is deemed to comply with AV limit.
 3. Test setup: RBW: 1 MHz, VBW: 3 MHz, Sweep time: auto.

TR-4-E-009 Radiated Emission Test Result

Test Site : DDT 3m Chamber 1# D:\2017 RE1# Report Data\Q17090505-1E\RF FCC 1-18G 2.4GWIFI.EM6
Test Date : 2017-10-15 **Tested By** : TALENT
EUT : Wireless Adaptor and 120W Digital Amplifier **Model Number** : ADAPT+AMP
Power Supply : AC 120V/60Hz **Test Mode** : TX mode 2462MHz
Condition : Temp:24.5°C,Humi:55%,
 Press:100.1kPa **Antenna/Distance** : 2016 HF907/3m/HORIZONTAL
Memo : 11n20 ANT1+ANT2

Data: 23

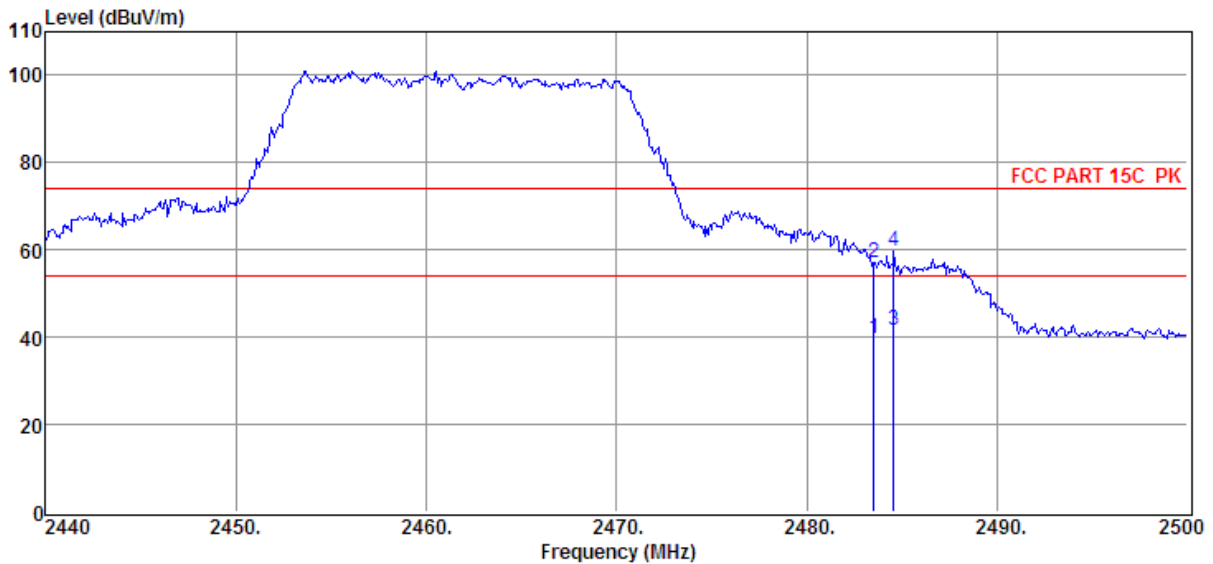

Item (Mark)	Freq. (MHz)	Read Level (dBμV)	Antenna Factor (dB/m)	PRM Factor (dB)	Cable Loss (dB)	Result Level (dBμV/m)	Limit Line (dBμV/m)	Over Limit (dB)	Detector	Polarization
1	2483.50	33.31	30.14	29.71	6.13	39.87	54.00	-14.13	Average	HORIZONTAL
2	2483.50	50.54	30.14	29.71	6.13	57.10	74.00	-16.90	Peak	HORIZONTAL
3	2484.58	35.14	30.14	29.71	6.13	41.70	54.00	-12.30	Average	HORIZONTAL
4	2484.58	53.16	30.14	29.71	6.13	59.72	74.00	-14.28	Peak	HORIZONTAL

- Note: 1. Result Level = Read Level + Antenna Factor + Cable loss - PRM Factor.
 2. If Peak Result complies with AV limit, AV Result is deemed to comply with AV limit.
 3. Test setup: RBW: 1 MHz, VBW: 3 MHz, Sweep time: auto.

TR-4-E-009 Radiated Emission Test Result

Test Site : DDT 3m Chamber 1# D:\2017 RE1# Report Data\Q17090505-1E\RF FCC 1-18G 2.4GWIFI.EM6
Test Date : 2017-10-15 **Tested By** : TALENT
EUT : Wireless Adaptor and 120W Digital Amplifier **Model Number** : ADAPT+AMP
Power Supply : AC 120V/60Hz **Test Mode** : TX mode 2462MHz
Condition : Temp:24.5°C,Humi:55%,
 Press:100.1kPa **Antenna/Distance** : 2016 HF907/3m/VERTICAL
Memo : 11n20 ANT1+ANT2

Data: 24

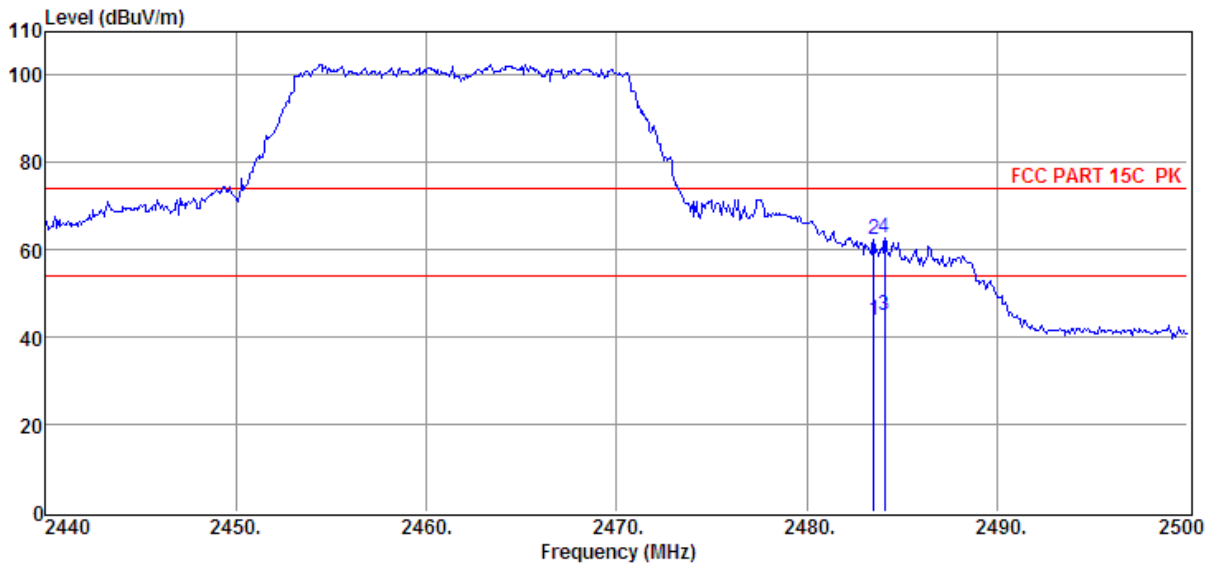

Item (Mark)	Freq. (MHz)	Read Level (dBμV)	Antenna Factor (dB/m)	PRM Factor (dB)	Cable Loss (dB)	Result Level (dBμV/m)	Limit Line (dBμV/m)	Over Limit (dB)	Detector	Polarization
1	2483.50	37.12	30.14	29.71	6.13	43.68	54.00	-10.32	Average	VERTICAL
2	2483.50	55.99	30.14	29.71	6.13	62.55	74.00	-11.45	Peak	VERTICAL
3	2484.10	38.24	30.14	29.71	6.13	44.80	54.00	-9.20	Average	VERTICAL
4	2484.10	56.31	30.14	29.71	6.13	62.87	74.00	-11.13	Peak	VERTICAL

- Note: 1. Result Level = Read Level + Antenna Factor + Cable loss - PRM Factor.
 2. If Peak Result complies with AV limit, AV Result is deemed to comply with AV limit.
 3. Test setup: RBW: 1 MHz, VBW: 3 MHz, Sweep time: auto.

TR-4-E-009 Radiated Emission Test Result

Test Site : DDT 3m Chamber 1# D:\2017 RE1# Report Data\Q17090505-1E\RF FCC 1-18G 2.4GWIFI.EM6
Test Date : 2017-10-15 **Tested By** : TALENT
EUT : Wireless Adaptor and 120W Digital Amplifier **Model Number** : ADAPT+AMP
Power Supply : AC 120V/60Hz **Test Mode** : TX mode 2422MHz
Condition : Temp:24.5°C,Humi:55%,
 Press:100.1kPa **Antenna/Distance** : 2016 HF907/3m/VERTICAL
Memo : 11n40 ANT1+ANT2

Data: 25

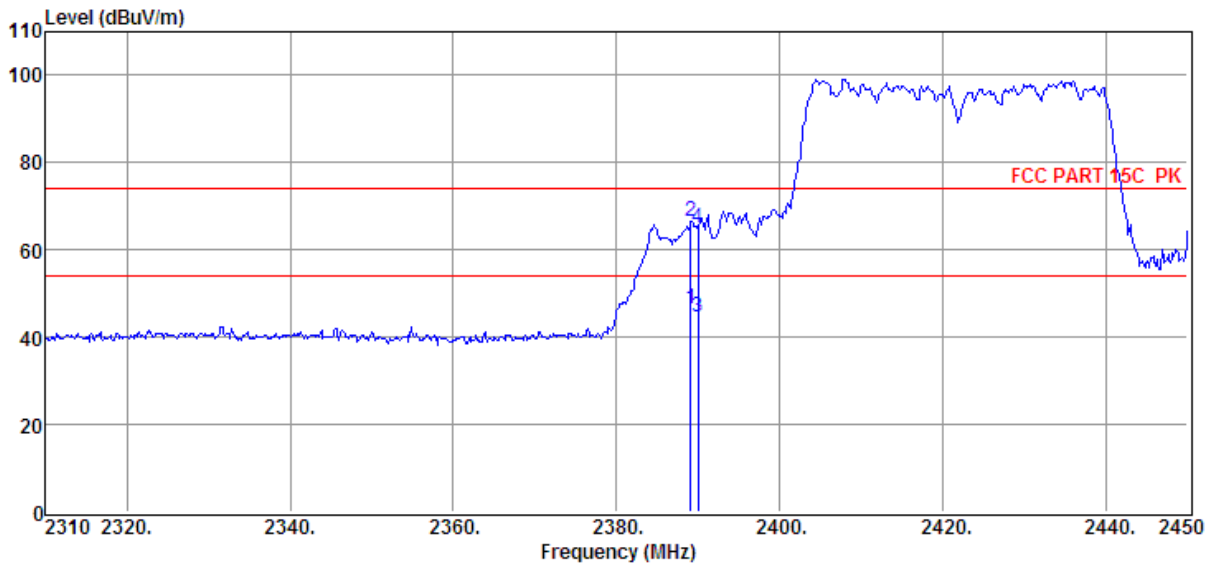

Item (Mark)	Freq. (MHz)	Read Level (dBμV)	Antenna Factor (dB/m)	PRM Factor (dB)	Cable Loss (dB)	Result Level (dBμV/m)	Limit Line (dBμV/m)	Over Limit (dB)	Detector	Polarization
1	2389.10	40.25	29.77	29.42	6.01	46.61	54.00	-7.39	Average	VERTICAL
2	2389.10	60.30	29.77	29.42	6.01	66.66	74.00	-7.34	Peak	VERTICAL
3	2390.00	38.11	29.78	29.42	6.03	44.50	54.00	-9.50	Average	VERTICAL
4	2390.00	58.62	29.78	29.42	6.03	65.01	74.00	-8.99	Peak	VERTICAL

- Note: 1. Result Level = Read Level + Antenna Factor + Cable loss - PRM Factor.
 2. If Peak Result complies with AV limit, AV Result is deemed to comply with AV limit.
 3. Test setup: RBW: 1 MHz, VBW: 3 MHz, Sweep time: auto.

TR-4-E-009 Radiated Emission Test Result

Test Site : DDT 3m Chamber 1# D:\2017 RE1# Report Data\Q17090505-1E\RF FCC 1-18G 2.4GWIFI.EM6
Test Date : 2017-10-15 **Tested By** : TALENT
EUT : Wireless Adaptor and 120W Digital Amplifier **Model Number** : ADAPT+AMP
Power Supply : AC 120V/60Hz **Test Mode** : TX mode 2422MHz
Condition : Temp:24.5°C,Humi:55%,
 Press:100.1kPa **Antenna/Distance** : 2016 HF907/3m/HORIZONTAL
Memo : 11n40 ANT1+ANT2

Data: 26

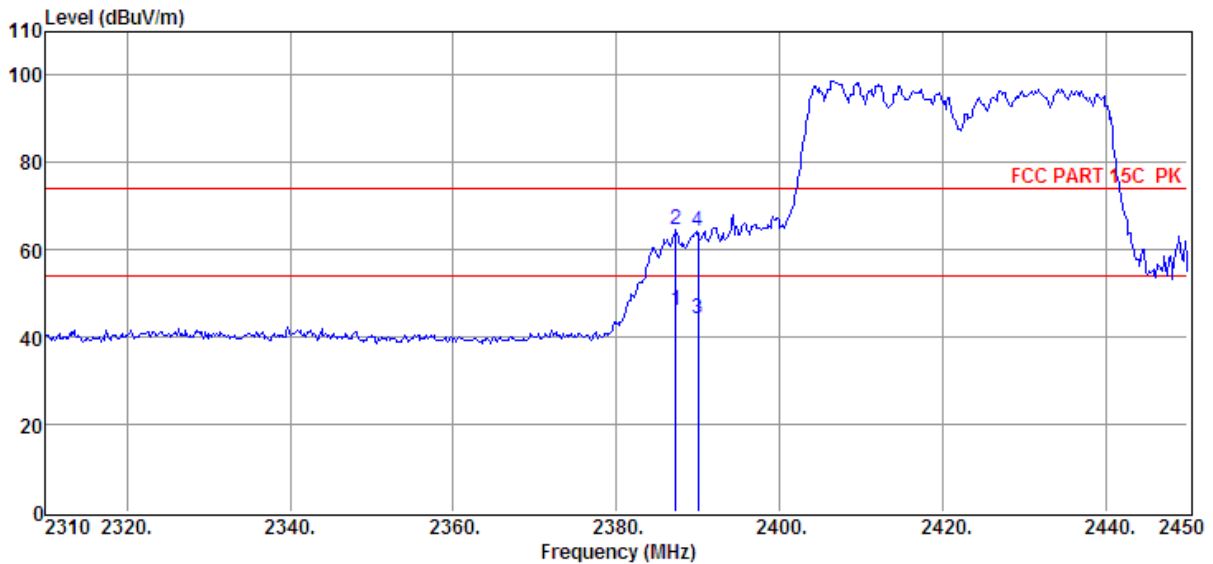

Item (Mark)	Freq. (MHz)	Read Level (dBμV)	Antenna Factor (dB/m)	PRM Factor (dB)	Cable Loss (dB)	Result Level (dBμV/m)	Limit Line (dBμV/m)	Over Limit (dB)	Detector	Polarization
1	2387.28	39.68	29.77	29.41	6.01	46.05	54.00	-7.95	Average	HORIZONTAL
2	2387.28	58.15	29.77	29.41	6.01	64.52	74.00	-9.48	Peak	HORIZONTAL
3	2390.00	37.79	29.78	29.42	6.03	44.18	54.00	-9.82	Average	HORIZONTAL
4	2390.00	58.04	29.78	29.42	6.03	64.43	74.00	-9.57	Peak	HORIZONTAL

- Note: 1. Result Level = Read Level + Antenna Factor + Cable loss - PRM Factor.
 2. If Peak Result complies with AV limit, AV Result is deemed to comply with AV limit.
 3. Test setup: RBW: 1 MHz, VBW: 3 MHz, Sweep time: auto.

TR-4-E-009 Radiated Emission Test Result

Test Site : DDT 3m Chamber 1# D:\2017 RE1# Report Data\Q17090505-1E\RF FCC 1-18G 2.4GWIFI.EM6
Test Date : 2017-10-15 **Tested By** : TALENT
EUT : Wireless Adaptor and 120W Digital Amplifier **Model Number** : ADAPT+AMP
Power Supply : AC 120V/60Hz **Test Mode** : TX mode 2452MHz
Condition : Temp:24.5°C,Humi:55%,
 Press:100.1kPa **Antenna/Distance** : 2016 HF907/3m/HORIZONTAL
Memo : 11n40 ANT1+ANT2

Data: 27

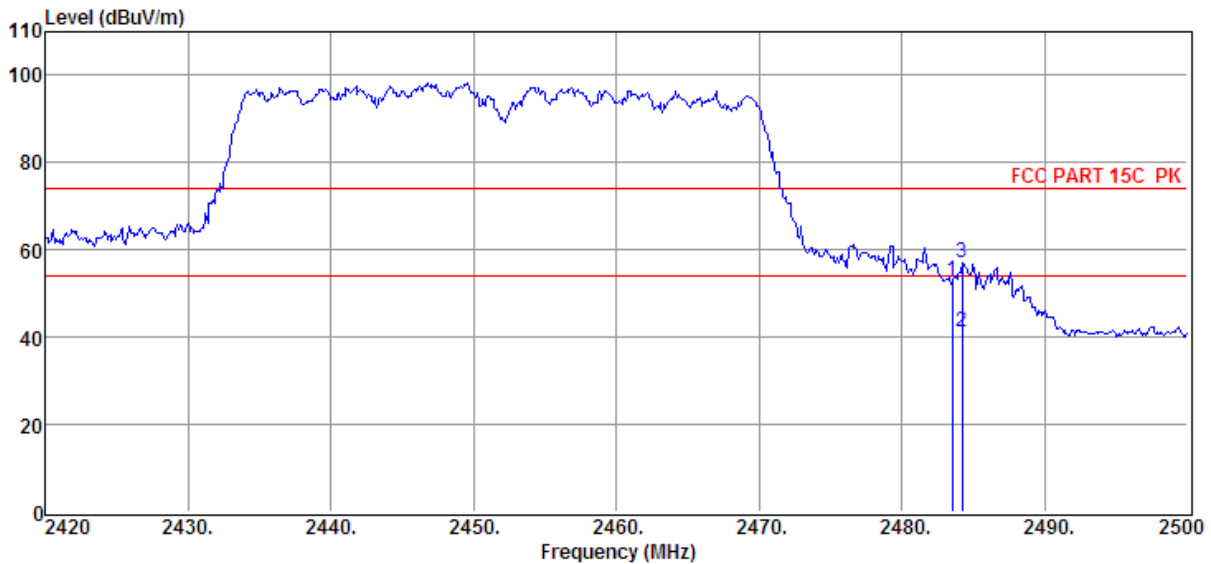

Item (Mark)	Freq. (MHz)	Read Level (dBμV)	Antenna Factor (dB/m)	PRM Factor (dB)	Cable Loss (dB)	Result Level (dBμV/m)	Limit Line (dBμV/m)	Over Limit (dB)	Detector	Polarization
1	2483.50	46.20	30.14	29.71	6.13	52.76	74.00	-21.24	Peak	HORIZONTAL
2	2484.24	34.70	30.14	29.71	6.13	41.26	54.00	-12.74	Average	HORIZONTAL
3	2484.24	50.38	30.14	29.71	6.13	56.94	74.00	-17.06	Peak	HORIZONTAL

- Note: 1. Result Level = Read Level + Antenna Factor + Cable loss - PRM Factor.
 2. If Peak Result complies with AV limit, AV Result is deemed to comply with AV limit.
 3. Test setup: RBW: 1 MHz, VBW: 3 MHz, Sweep time: auto.

TR-4-E-009 Radiated Emission Test Result

Test Site : DDT 3m Chamber 1# D:\2017 RE1# Report Data\Q17090505-1E\RF FCC 1-18G 2.4GWIFI.EM6
Test Date : 2017-10-15 **Tested By** : TALENT
EUT : Wireless Adaptor and 120W Digital Amplifier **Model Number** : ADAPT+AMP
Power Supply : AC 120V/60Hz **Test Mode** : TX mode 2452MHz
Condition : Temp:24.5°C,Humi:55%,
 Press:100.1kPa **Antenna/Distance** : 2016 HF907/3m/VERTICAL
Memo : 11n40 ANT1+ANT2

Data: 28

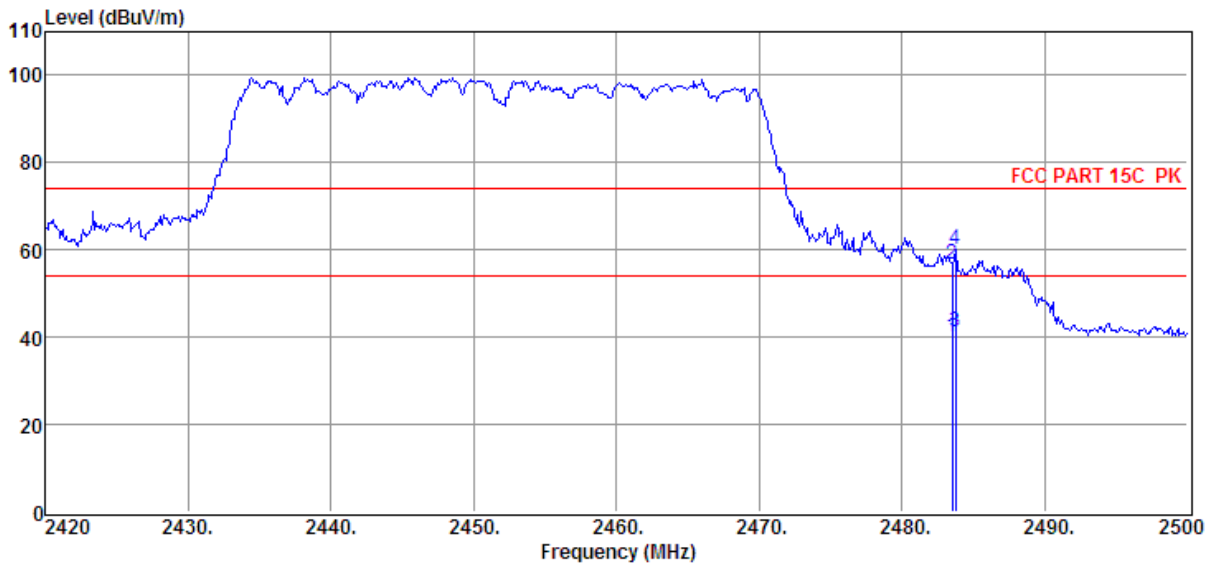

Item (Mark)	Freq. (MHz)	Read Level (dBμV)	Antenna Factor (dB/m)	PRM Factor dB	Cable Loss dB	Result Level (dBμV/m)	Limit Line (dBμV/m)	Over Limit (dB)	Detector	Polarization
1	2483.50	33.52	30.14	29.71	6.13	40.08	54.00	-13.92	Average	VERTICAL
2	2483.50	50.13	30.14	29.71	6.13	56.69	74.00	-17.31	Peak	VERTICAL
3	2483.76	34.74	30.14	29.71	6.13	41.30	54.00	-12.70	Average	VERTICAL
4	2483.76	53.48	30.14	29.71	6.13	60.04	74.00	-13.96	Peak	VERTICAL

- Note: 1. Result Level = Read Level + Antenna Factor + Cable loss - PRM Factor.
 2. If Peak Result complies with AV limit, AV Result is deemed to comply with AV limit.
 3. Test setup: RBW: 1 MHz, VBW: 3 MHz, Sweep time: auto.

9. Power Line Conducted Emission

9.1. Block diagram of test setup

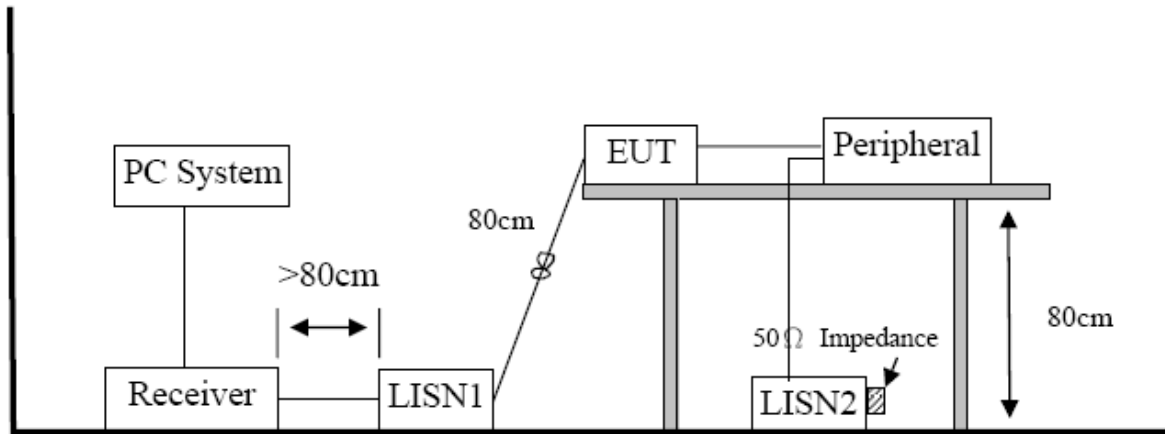

9.2. Power Line Conducted Emission Limits(Class B)

Frequency	Quasi-Peak Level dB(μ V)	Average Level dB(μ V)
150kHz ~ 500kHz	66 ~ 56*	56 ~ 46*
500kHz ~ 5MHz	56	46
5MHz ~ 30MHz	60	50

Note 1: * Decreasing linearly with logarithm of frequency.

Note 2: The lower limit shall apply at the transition frequencies.

9.3. Test Procedure

The EUT and Support equipment, if needed, were put placed on a non-metallic table, 80cm above the ground plane.

All I/O cables were positioned to simulate typical actual usage as per ANSI C63.4.

All support equipment power received from a second LISN.

Emissions were measured on each current carrying line of the EUT using an EMI Test Receiver connected to the LISN powering the EUT.

The Receiver scanned from 150 kHz to 30MHz for emissions in each of the test modes.

During the above scans, the emissions were maximized by cable manipulation.

After the preliminary scan, we found the test mode producing the highest emission level.

The EUT configuration and worse cable configuration of the above highest emission levels were recorded for reference of the final test.

EUT and support equipment were set up on the test bench as per the configuration with highest emission level in the preliminary test.

A scan was taken on both power lines, Neutral and Line, recording at least the six highest emissions.

Emission frequency and amplitude were recorded into a computer in which correction factors were used to calculate the emission level and compare reading to the applicable limit.

The test data of the worst-case condition(s) was recorded.

The bandwidth of test receiver is set at 9 KHz.

9.4. Test Result

PASS. (See below detailed test result)

Note1: All emissions not reported below are too low against the prescribed limits.

Note2: “----” means peak detection; “-----” means average detection

Note3: Pre-test AC conducted emission at both voltage AC 120V/60Hz and AC 240V/50Hz, recorded worst case (AC 120V/60Hz).

TR-4-E-010 Conducted Emission Test Result

Test Site : DDT 1# Shield Room E:\2017 CE report data\Q17090505-1E\CE.EM6
Test Date : 2017-10-09 **Tested By** : Xian
EUT : Wireless Adaptor and 120W Digital Amplifier **Model Number** : ADAPT+AMP
Power Supply : AC 120V/60Hz **Test Mode** : TX mode
Condition : Temp:24.5°C,Humi:55%, Press:100.1kPa **LISN** : 2016 ENV216/NEUTRAL
Memo :

Data: 52

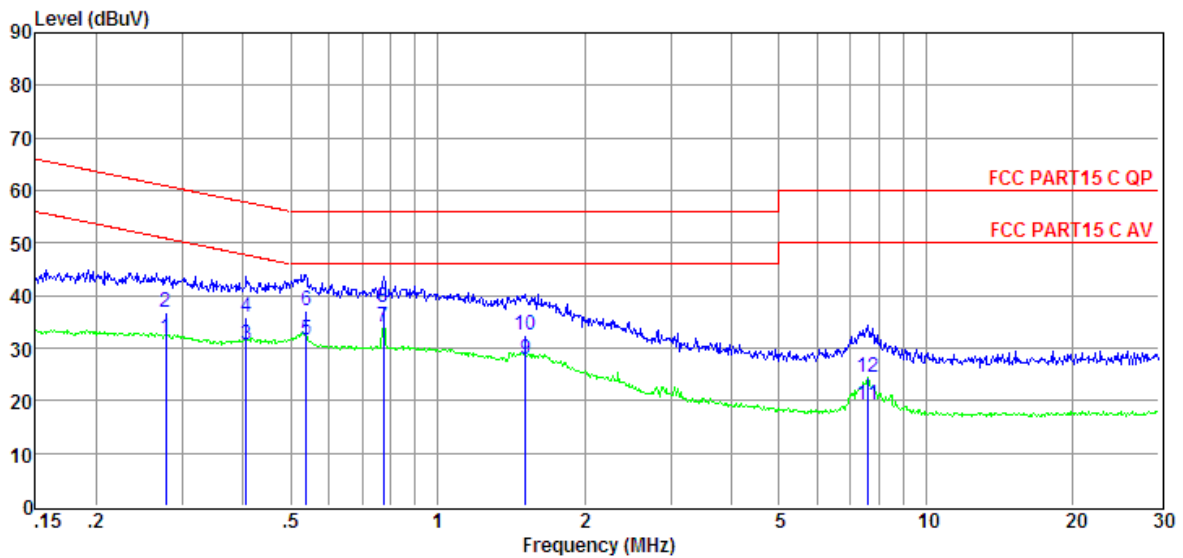

Item (Mark)	Freq. (MHz)	Read Level (dBμV)	LISN Factor (dB)	Cable Loss (dB)	Pulse Limiter Factor (dB)	Result Level (dBμV)	Limit Line (dBμV)	Over Limit (dB)	Detector	Phase
1	0.28	12.30	9.61	0.02	9.86	31.79	50.90	-19.11	Average	NEUTRAL
2	0.28	17.20	9.61	0.02	9.86	36.69	60.90	-24.21	QP	NEUTRAL
3	0.41	11.05	9.61	0.02	9.86	30.54	47.73	-17.19	Average	NEUTRAL
4	0.41	16.39	9.61	0.02	9.86	35.88	57.73	-21.85	QP	NEUTRAL
5	0.54	12.18	9.61	0.03	9.86	31.68	46.00	-14.32	Average	NEUTRAL
6	0.54	17.53	9.61	0.03	9.86	37.03	56.00	-18.97	QP	NEUTRAL
7	0.78	14.37	9.61	0.03	9.86	33.87	46.00	-12.13	Average	NEUTRAL
8	0.78	18.27	9.61	0.03	9.86	37.77	56.00	-18.23	QP	NEUTRAL
9	1.51	8.34	9.62	0.04	9.86	27.86	46.00	-18.14	Average	NEUTRAL
10	1.51	13.07	9.62	0.04	9.86	32.59	56.00	-23.41	QP	NEUTRAL
11	7.61	-0.58	9.70	0.09	9.89	19.10	50.00	-30.90	Average	NEUTRAL
12	7.61	4.86	9.70	0.09	9.89	24.54	60.00	-35.46	QP	NEUTRAL

- Note: 1. Result Level = Read Level +LISN Factor + Pulse Limiter Factor + Cable loss.
 2. If QP Result complies with AV limit, AV Result is deemed to comply with AV limit.
 3. Test setup: RBW: 200 Hz (9 kHz—150 kHz), 9 kHz (150 kHz—30 MHz).
 4. Step size: 80Hz (0.009MHz-0.15MHz), 4 kHz (0.15MHz-30MHz), Scan time: auto.

TR-4-E-010 Conducted Emission Test Result

Test Site : DDT 1# Shield Room E:\2017 CE report data\Q17090505-1E\CE.EM6
Test Date : 2017-10-09 **Tested By** : Xian
EUT : Wireless Adaptor and 120W Digital Amplifier **Model Number** : ADAPT+AMP
Power Supply : AC 120V/60Hz **Test Mode** : TX mode
Condition : Temp:24.5°C,Humi:55%, Press:100.1kPa **LISN** : 2016 ENV216/LINE
Memo :

Data: 54

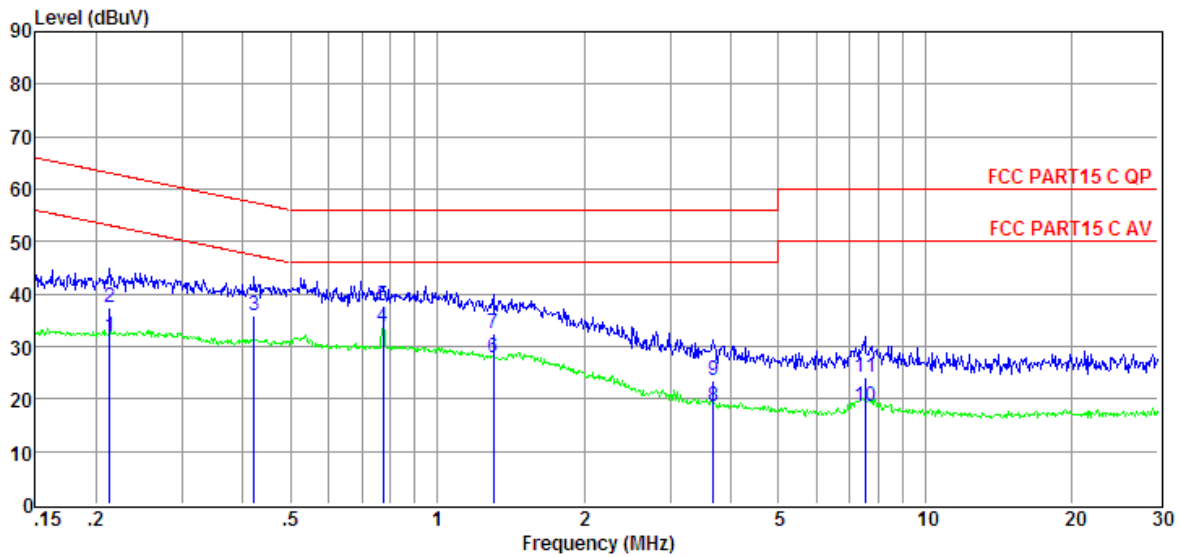

Item (Mark)	Freq. (MHz)	Read Level (dBμV)	LISN Factor (dB)	Cable Loss (dB)	Pulse Limiter Factor (dB)	Result Level (dBμV)	Limit Line (dBμV)	Over Limit (dB)	Detector	Phase
1	0.21	12.44	9.61	0.02	9.86	31.93	53.10	-21.17	Average	LINE
2	0.21	17.87	9.61	0.02	9.86	37.36	63.10	-25.74	QP	LINE
3	0.42	16.34	9.61	0.02	9.86	35.83	57.42	-21.59	QP	LINE
4	0.78	14.27	9.61	0.03	9.86	33.77	46.00	-12.23	Average	LINE
5	0.78	18.32	9.61	0.03	9.86	37.82	56.00	-18.18	QP	LINE
6	1.30	8.32	9.62	0.03	9.86	27.83	46.00	-18.17	Average	LINE
7	1.30	12.85	9.62	0.03	9.86	32.36	56.00	-23.64	QP	LINE
8	3.68	-1.10	9.65	0.06	9.87	18.48	46.00	-27.52	Average	LINE
9	3.68	4.00	9.65	0.06	9.87	23.58	56.00	-32.42	QP	LINE
10	7.53	-1.18	9.70	0.09	9.89	18.50	50.00	-31.50	Average	LINE
11	7.53	4.45	9.70	0.09	9.89	24.13	60.00	-35.87	QP	LINE

- Note: 1. Result Level = Read Level +LISN Factor + Pulse Limiter Factor + Cable loss.
 2. If QP Result complies with AV limit, AV Result is deemed to comply with AV limit.
 3. Test setup: RBW: 200 Hz (9 kHz—150 kHz), 9 kHz (150 kHz—30 MHz).
 4. Step size: 80Hz (0.009MHz-0.15MHz), 4 kHz (0.15MHz-30MHz), Scan time: auto.

10. Antenna Requirements

10.1. Limit

For intentional device, according to FCC 47 CFR Section 15.203, an intentional radiator shall be designed to ensure that no antenna other than that furnished by the responsible party shall be used with the device. And according to FCC 47 CFR Section 15.247 (b), if transmitting antennas of directional gain greater than 6dBi are used, the power shall be reduced by the amount in dB that the directional gain of the antenna exceeds 6dBi.

10.2. Result

The antennas used for this product are integrated antenna and other than that furnished by the responsible party shall be used with the device, the maximum peak gain of the transmit antenna is only 4.20dBi.

END OF REPORT