

EON 600

S E R I E S

User's Guide



EON 612

EON 615

EON 610

CONTENTS

Safety Instructions	4
Declaration Of Conformity	5
Quick Setup Guide	6
Overview - EON Family	8
EON Family - Block Diagram	9
EON615 Specifications	10
Coverage	12
Purposeful Product Design	13
Back Panel	14
Loudspeaker Placement and Suspension	16
Application Examples	17
Trouble Shooting	20
Warranty Information	21
Contact Information	22

SAFETY INSTRUCTIONS

Before You Begin - Important Information

Before using your EON® speaker system please review the following for important information on safety and protection of your investment in quality loudspeakers.

1. Read these instructions.
2. Keep these instructions.
3. Heed all warnings.
4. Follow all instructions.
5. Do not use this apparatus near water.
6. Clean only with dry cloth.
7. Do not block any ventilation openings. Install in accordance with the manufacturer's instructions.
8. Do not install near any heat sources such as radiators, heat registers, stoves, or other apparatus (including amplifiers) that produce heat.
9. Do not defeat the safety purpose of the polarized or grounding-type plug. A polarized plug has two blades with one wider than the other. A grounding-type plug has two blades and a third grounding prong. The wide blade or the third prong is provided for your safety. If the provided plug does not fit into your outlet, consult an electrician for replacement of the obsolete outlet.
10. Protect the power cord from being walked on or pinched, particularly at plugs, convenience receptacles, and the point where they exit from the apparatus.
11. Only use attachments/accessories specified by the manufacturer.
12. Use only with the cart, stand, tripod, bracket, or table specified by the manufacturer, or sold with the apparatus. When a cart is used, use caution when moving the cart/apparatus combination to avoid injury from tip-over.
13. Unplug this apparatus during lightning storms or when unused for long periods of time.
14. Refer all servicing to qualified service personnel. Servicing is required when the apparatus has been damaged in any way, such as power supply cord or plug is damaged, liquid has been spilled or objects have fallen into the apparatus, the apparatus has been exposed to rain or moisture, does not operate normally, or has been dropped.
15. Service Instruction in Owner's Manual: "CAUTION - THESE SERVICING INSTRUCTIONS ARE FOR USE BY QUALIFIED SERVICE PERSONNEL ONLY. TO REDUCE THE RISK OF ELECTRIC SHOCK DO NOT PERFORM ANY SERVICING OTHER THAN THAT CONTAINED IN THE OPERATING INSTRUCTIONS UNLESS YOU ARE QUALIFIED TO DO SO."
16. To completely disconnect this apparatus from the AC mains, disconnect the power supply cord plug from the AC receptacle.
17. "WARNING – TO REDUCE THE RISK OF FIRE OR ELECTRIC – SHOCK, DO NOT EXPOSE THIS APPARATUS TO RAIN OR MOISTURE."
18. Do not expose this equipment to dripping or splashing and ensure that no objects filled with liquids, such as vases, are placed on the equipment.
19. The mains plug of the power supply cord shall remain readily operable.



DECLARATION OF CONFORMITY

Safety And EMC Compliance Specifications

EN 55103-1:1997 Electromagnetic Compatibility - Product Family Standard for Audio, Video, Audio-Visual and Entertainment Lighting Control Apparatus for Professional Use, Part 1: Emissions
EN 55103-1:1997 Magnetic Field Emissions-Annex A@ 10 cm and 20 cm
EN 55022:2003 Limits and Methods of Measurement of Radio Disturbance Characteristics of ITE: Radiated, Class B Limits; Conducted, Class A
EN 55103-2:1997 Electromagnetic Compatibility - Product Family Standard for Audio, Video, Audio-Visual and Entertainment Lighting Control Apparatus for Professional Use, Part 2: Immunity
EN 61000-4-2: A2:2001 Electrostatic Discharge Immunity (Environment E2-criteria B, 4 kV Contact, 8 kV Air discharge)
EN 61000-4-3:2003 Radiated, Radio-frequency, Electromagnetic Immunity (Environment E2, criteria A)
EN61000-4-4:2005 Electrical Fast Transient/Burst Immunity (criteria B)
EN 61000-4-5:2001 Surge Immunity (criteria B)
EN 61000-4-6:1996 Immunity to Conducted Disturbances Induced by Radio-Frequency Fields (criteria A)
EN 61000-4-11:2004 Voltage Dips, Short Interruptions and Voltage Variation
UL 6500 2nd Edition 1999 Audio/Video and Musical Instruments Apparatus for Household, Commercial, and Similar General Use
IEC 60065_2001 / EN 60065_2002 + A1:2006 + A11:2008

UL Compliance Specifications

UL 60065 7th Ed. CAN/CSA 22.2 No.60065_2003

FCC Statement

1. This device complies with Part 15 of the FCC Rules.

Operation is subject to the following two conditions:

- (1) This device may not cause harmful interference.
- (2) This device must accept any interference received, including interference that may cause undesired operation.

2. Changes or modifications not expressly approved by the party responsible for compliance could void the user's authority to operate the equipment.

NOTE: This equipment has been tested and found to comply with the limits for a Class B digital device, pursuant to Part 15 of the FCC Rules. These limits are designed to provide reasonable protection against harmful interference in a residential installation. This equipment generates uses and can radiate radio frequency energy and, if not installed and used in accordance with the instructions, may cause harmful interference to radio communications. However, there is no guarantee that interference will not occur in a particular installation. If this equipment does cause harmful interference to radio or television reception, which can be determined by turning the equipment off and on, the user is encouraged to try to correct the interference by one or more of the following measures:

- Reorient or relocate the receiving antenna.
- Increase the separation between the equipment and receiver.
- Connect the equipment into an outlet on a circuit different from that to which the receiver is connected.
- Consult the dealer or an experienced radio/TV technician for help.

FCC Radiation Exposure Statement

This equipment complies with FCC radiation exposure limits set forth for an uncontrolled environment. This equipment should be installed and operated with minimum distance 20cm between the radiator & your body

IC Warning

1. This device complies with Industry Canada licence-exempt RSS standard(s). Operation is subject to the following two conditions:

- (1) this device may not cause interference, and
- (2) this device must accept any interference, including interference that may cause undesired operation of the device.

2. Changes or modifications not expressly approved by the party responsible for compliance could void the user's authority to operate the equipment.

Le présent appareil est conforme aux CNR d'Industrie Canada applicables aux appareils radio exempts de licence. L'exploitation est autorisée aux deux conditions suivantes :

- (1) l'appareil ne doit pas produire de brouillage, et
- (2) l'utilisateur de l'appareil doit accepter tout brouillage radioélectrique subi, même si le brouillage est susceptible d'en compromettre le fonctionnement."

QUICK SETUP GUIDE

Congratulations on your purchase of JBL Professional EON600 Series loudspeakers! We know you are anxious to get up and running as fast as possible, which is why you are reading this section. The following will help you get set up as soon as possible.

Packaging Contents

Your EON600 system should include the following:

- 1 x EON600 speaker
- 1 x 10'(3m) IEC Power Cable
- 1 x Quick Start Guide

Unbox it

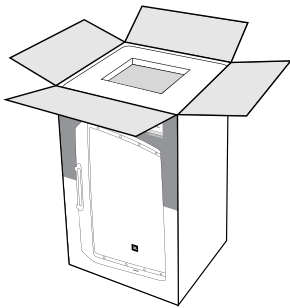

①

Open the top of the box.

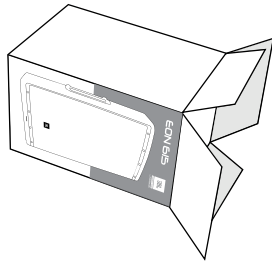

②

Lay box on its side.

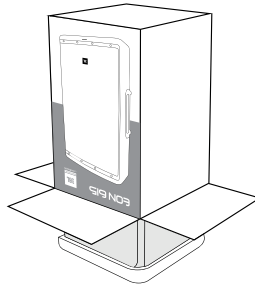

③

Turn box upside down, then lift box up to reveal speaker.

Configuration Options

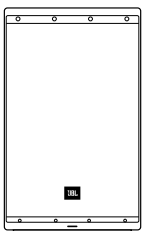

①

Floor Standing



②

Monitor Position

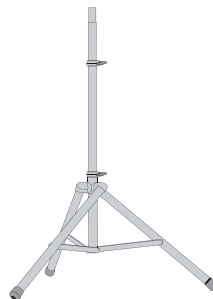

③

Pole Mounted

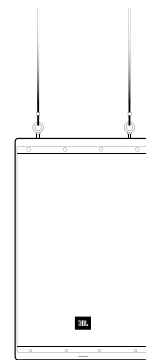

④

Suspended

QUICK SETUP GUIDE

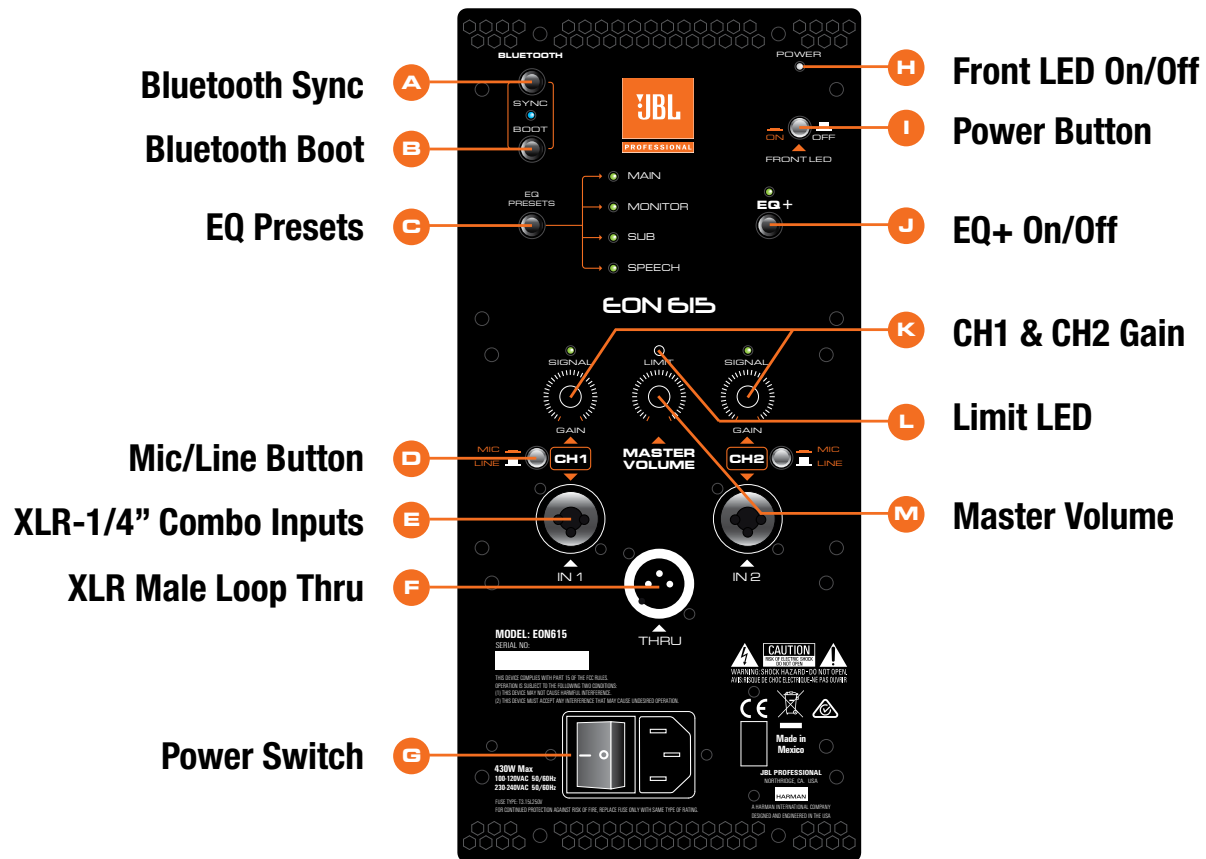

POWER IT ON

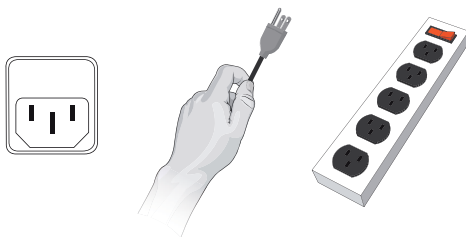

1. Confirm the Power Button (I) is in the OFF position.
2. Connect the supplied power cord to the power receptacle on the rear of the speaker.
3. Connect the power cord to an available power outlet.
4. Flip on the Power Switch (G) and press the Power Button (I) to ON position, the White Power LED (H) on back and front of the speaker will illuminate

PLUG IN THE INPUTS

1. Turn Channel Gain Controls (K) and Master Volume Control (M) all the way to the left before connecting any inputs
2. Connect XLR or TRS cable from audio source to CH1 or CH2 inputs (E)
3. Select Mic or Line via the Mic/Line Button (D)

SET OUTPUT LEVEL

1. Using the EQ Preset (C) button, select the appropriate preset to match your application
2. Set the gain level for the input using the Channel Gain (K) controls. A good starting point is to set the pot at 12 o'clock.
3. Slowly turn Master Volume (M) to the right until the desired volume is reached.

OVERVIEW - EON FAMILY

COMING SOON



EON 610

10" Two-way multipurpose self-powered sound reinforcement

- 1000 Watt
- 26 lbs. / 11.79 kg
- 110° H / 60° V Coverage

COMING SOON



EON 612

12" Two-way multipurpose self-powered sound reinforcement

- 1000 Watt
- 33 lbs. / 14.96 kg
- 100° H / 60° V Coverage



EON 615

15" Two-way multipurpose self-powered sound reinforcement

- 1000 Watt
- 39 lbs. / 17.69 kg
- 90° H / 60° V Coverage

Thank you for purchasing the new JBL EON!

More than just another great JBL sound system, the new EON600 is a true step forward in technology developed specifically to deliver the best sound possible regardless of its application. Completely rethinking how truly good an affordable self-contained, portable PA system can be, JBL engineers purposely designed and built the EON600 from the ground up featuring JBL's advanced waveguide technology, JBL designed and manufactured transducers, and convenient, wireless remote control of its onboard DSP EQ parameters via Bluetooth.

This total redesign of the EON platform leverages the latest technologies in cabinet materials, acoustic science, transducer design and user friendliness that delivers the extraordinary quality of a high-end studio monitor in a fully professional, highly flexible, easy to use, portable system for today's working musicians and sound providers.

With proper care your EON Series speakers should provide you with many years of flawless performance, and are flexible enough to be a part of your sound reinforcement system even as it grows in scope.

EON FAMILY - BLOCK DIAGRAM

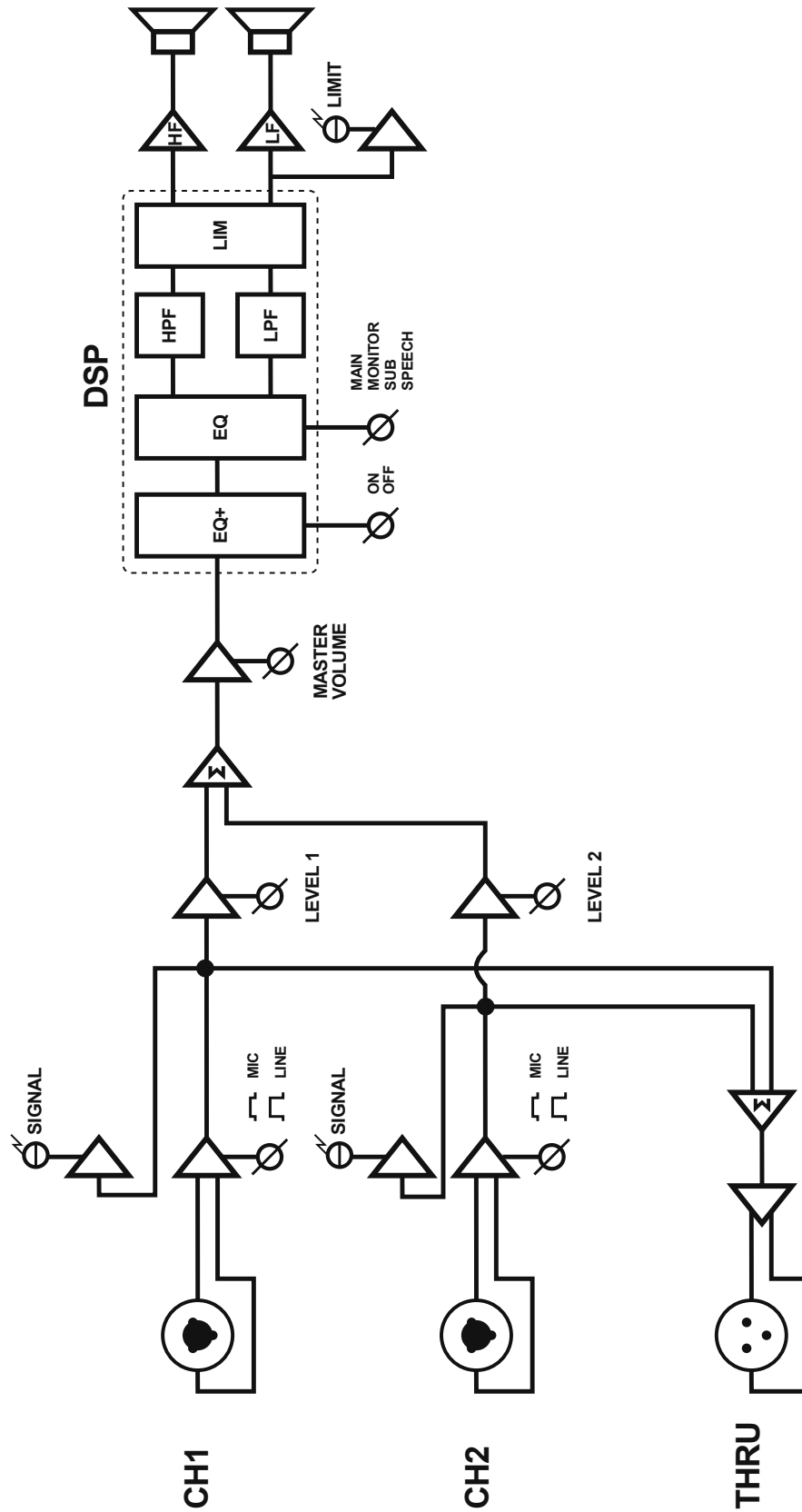

EON615 SPECIFICATIONS

System Specification

System Type:	Self powered 15", two-way, bass-reflex
Maximum SPL Output:	127 dB
Frequency Range (-10 dB):	39 Hz - 20.3 kHz
Frequency Response (± 3 dB):	50 Hz - 19.8 kHz
EQ:	3 Parametric EQ's, High and Low Shelf (Available via Bluetooth app only)

Amplification

Amplifier Design:	High Efficiency Class D
System Power Rating:	1000W Peak (700 LF + 300HF); 500W Continuous (350W LF + 150W HF)
Input Impedance:	20K ohms (Balanced)
Line Input Gain:	Infinity to +26.8dB (+14dBu max input level)
Mic Input Gain:	Infinity to +29dB (in addition to line input gain)
Connectors:	2 x Balanced XLR-1/4" combination inputs; 1 x male XLR loop thru out
LED Indicators:	Power, Bluetooth, EQ Preset, EQ +, Signal CH1, Signal CH2, Limit
Cooling:	Passively Cooled (No Fan)
AC Power Input:	100-120VAC 50/60Hz; 230-240VAC 50/60Hz
AC Power Consumption (120VAC):	1/8th Power – 1.14A (Max), 1/4th Power – 1.71A (Max), 1/3rd Power – 2.03A (Max)

Speaker Specification

LF Driver:	1 x JBL 615H 380mm (15") woofer with 2" voice coil
HF Driver:	1 x JBL 2414H-1 25.4mm (1") annular polymer diaphragm, neodymium compression driver
Coverage Pattern:	90° H x 60° V
Crossover Frequency:	1.8kHz

Enclosure

Material:	Polypropylene, multi-purpose main & monitor
Suspension / Mounting:	36mm pole socket with stabilizing screw, 3 x M10 suspension points
Handles:	One left, one right, one top, one bottom (4 total)
Finish:	Black Granite
Grille:	Powder coated perforated steel with acoustically transparent screen backing
Dimensions (H x W x D):	707mm x 439mm x 365mm (27.8" x 17.3" x 14.4")
Gross Weight:	17.69 kg (39 lbs)

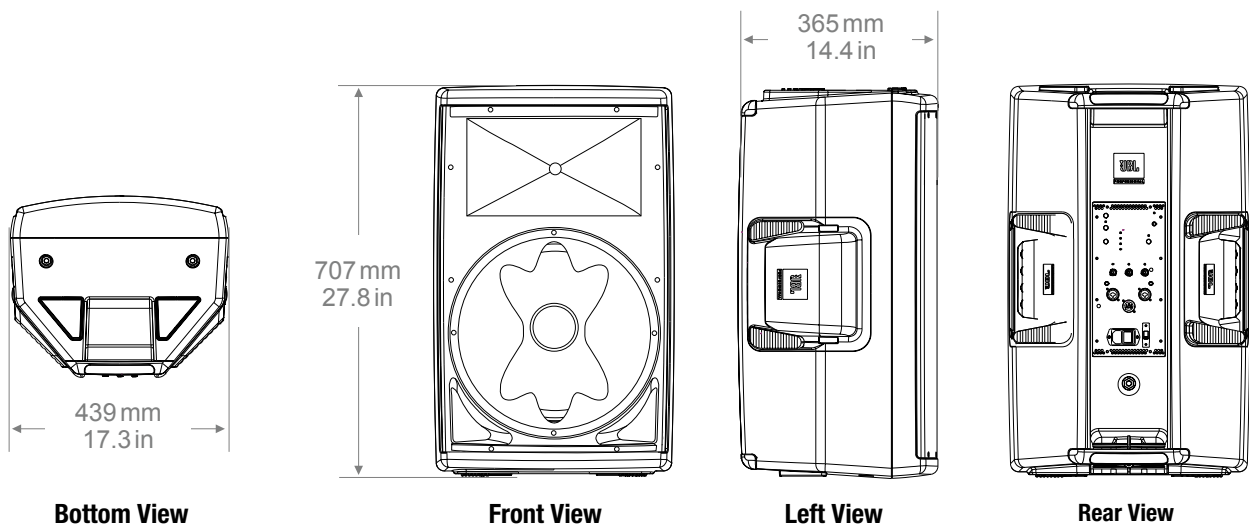

EON615 SPECIFICATIONS

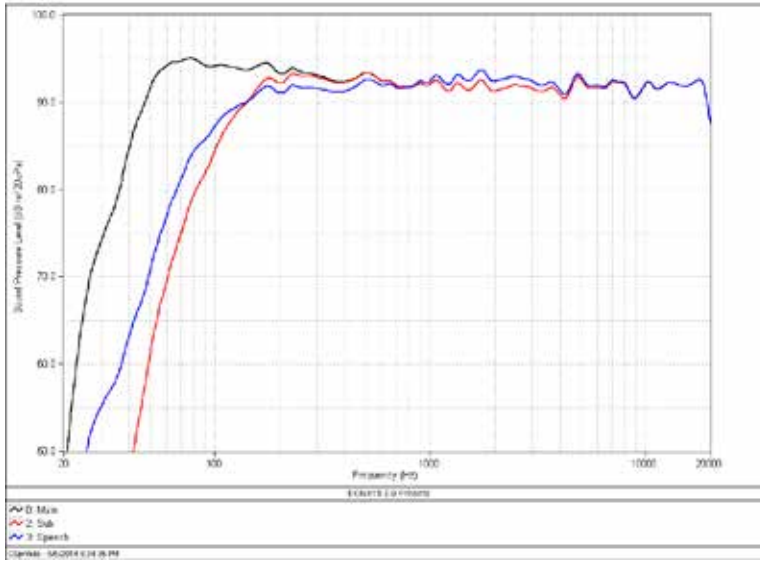

**Main
Sub
Speech**

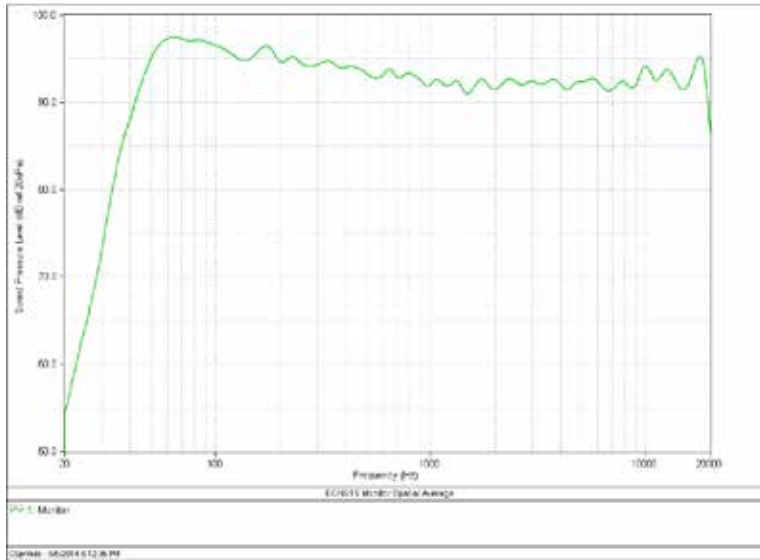

Monitor

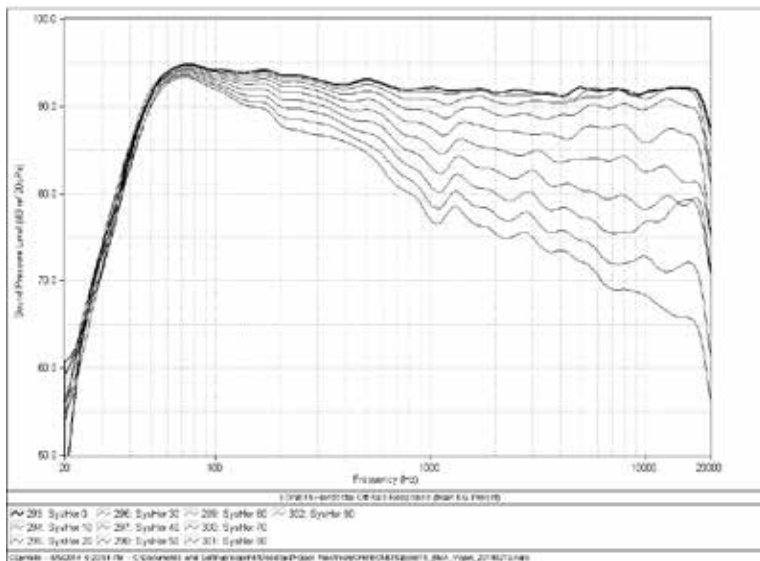

Off-Axis

COVERAGE

EON600 Coverage Pattern Compared to a Typical Speaker

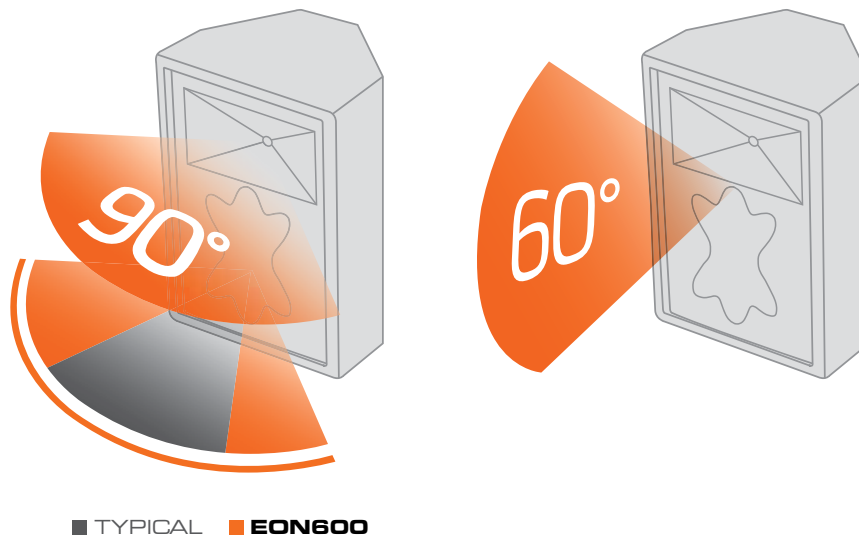

The EON600's extraordinary performance results from a breakthrough approach to waveguide design. JBL engineers examined the radiation characteristics of the EON's high and low frequency drivers at 36 different points employing JBL's exclusive, state of the art measurement techniques, then designed individual waveguides for both components that control the sound radiation at the high frequencies, the crossover point and at the low frequencies. Special fluting is designed into the structure that guides the frequencies through the full range of the system. The result is consistent response throughout its 90 degree coverage pattern. The quality and consistency between on axis and off axis response delivers uniform coverage and high intelligibility throughout the coverage area, which means the EON600's smooth, transparent sound is the same for the entire audience.

90°H / 60°V Coverage through Revolutionary Waveguides

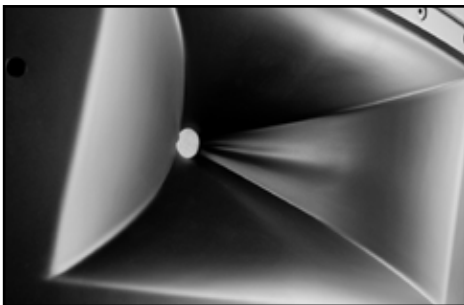

Image Control Waveguide

Increased High Frequency detail. The Image Control Waveguide's patent-pending design precisely controls the sound emanating from the EON600 in the vertical and horizontal planes ensuring the representation of your mix is neutral and accurate at the listening position.



Low Frequency Waveguide

JBL's ground breaking new low frequency waveguide features special fluting that is designed into the structure that guides the frequencies through the full range of the system.

PURPOSEFUL PRODUCT DESIGN

Portability made easy

Enclosure designs have been optimized for ideal acoustic resonance taking advantage of injection molding techniques and mechanical shaping of the enclosures. This results in tremendous increases in cabinet volumes which enable better acoustic performance while maintaining the same footprint. Four intelligently positioned handles make the 600 easy to carry and move around. Integrated hardware mounts, designed into the enclosures, allow each model to be flown when required. And indexed feet molded into the enclosures allow for convenient storage and transport, secure stacking for stage monitor and traditional stand up configurations, and unique acoustic configurations.

Bottom Handle & Locking Feet



Top Handle & Indexed Molding



Top Handle



Side Handle



Secure Stacking



Monitor Position



BACK PANEL

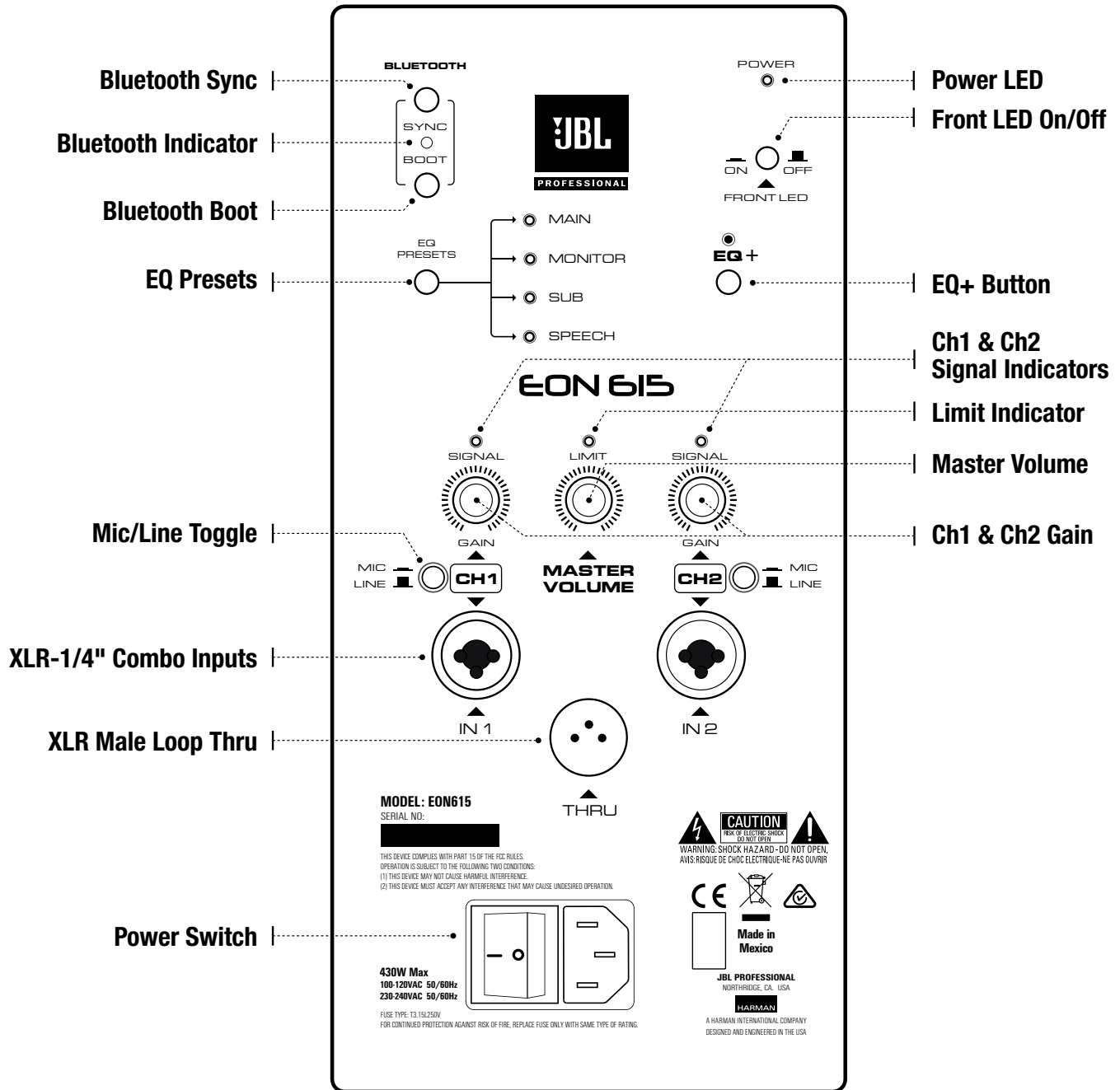

Bluetooth Sync

Depress this button in order to initiate pairing with your Bluetooth enable device.

Bluetooth Indicator

This LED will illuminate blue to indicate that your Bluetooth connection is established.

Bluetooth Boot

Depress this button to reset the pairing with your Bluetooth enabled device without having to turn the speaker off.

EQ Presets

Use this button to toggle through the four different settings.

MAIN:

Setting for use as your main speaker facing towards your audience.

MONITOR:

Use this setting when your speaker is used as a monitor facing towards you.

SUB:

This setting is used when your EON600 is used in conjunction with a separate SubWoofers.

SPEECH:

Best setting for giving speeches and spoken word.

Mic/Line Toggle

The MIC/LINE buttons selects between two sensitivity ranges. The buttons are used to match the input sensitivity with the output level of the devices connected to CH1 or CH2. Depressing the MIC/LINE switch selects MIC (High Sensitivity).

CAUTION: Before adjusting this switch, be certain to rotate the control fully counter-clockwise. After the MIC/LINE switch has been depressed, slowly rotate the control clock-wise until the desired volume has been reached.

- Use the MIC position (depressed) when a microphone is connected.
- Use the LINE position (disengaged) when a line level source such as an audio mixing console, audio playback device or electronic musical instrument is connected.

XLR-1/4" Combo Inputs

These balanced inputs accepts a standard XLR (female) connector and also a 1/4" TRS phone plug. A broad range of signals from microphones, audio mixing consoles and electronic musical instruments may be connected here. The sensitivity of these inputs are controlled by the MIC/LINE SWITCHES.

XLR Male Loop Thru

This XLR (male) output connector provides a method of sending audio out to an external source. If signal is present on both inputs, the inputs will be summed and sent out as a 50/50 mix

Power Switch

Enables the AC power to the unit on and off.

Power LED

This LED (White) lights to indicate that the speaker is plugged in and switched ON.

Front LED On/Off

Toggles the LED (Blue) on front of speaker On or Off.

EQ+ Button

Once enabled via the app, the EQ+ toggles the applied EQ settings on/off.

CH1 & CH2 Signal Indicators

The SIGNAL LEDs (Green) illuminates to indicate a usable signal is present at connected INPUTS.

Limit Indicator

The LIMIT LED (Red) illuminates to indicate that the system is approaching limit. If this LED is on for more than the duration of brief dynamic peaks, the system is being over-driven. Continuously over-driving the system will result in unpleasant and fatiguing distortion and may lead to premature failure of your speaker system.

Master Volume

Controls the master volume of the unit. By turning the knob counter-clockwise you will be lowering the overall volume of the speaker. By turning the control clockwise you will be increasing the overall volume of the speaker.

CH1 & CH2 Gain

Controls the gain of CH1 & CH2 respectively. By turning the signal counter-clockwise you will be lowering the gain of your source material. By turning the control clockwise you will be increasing the gain.

LOUDSPEAKER PLACEMENT AND SUSPENSION

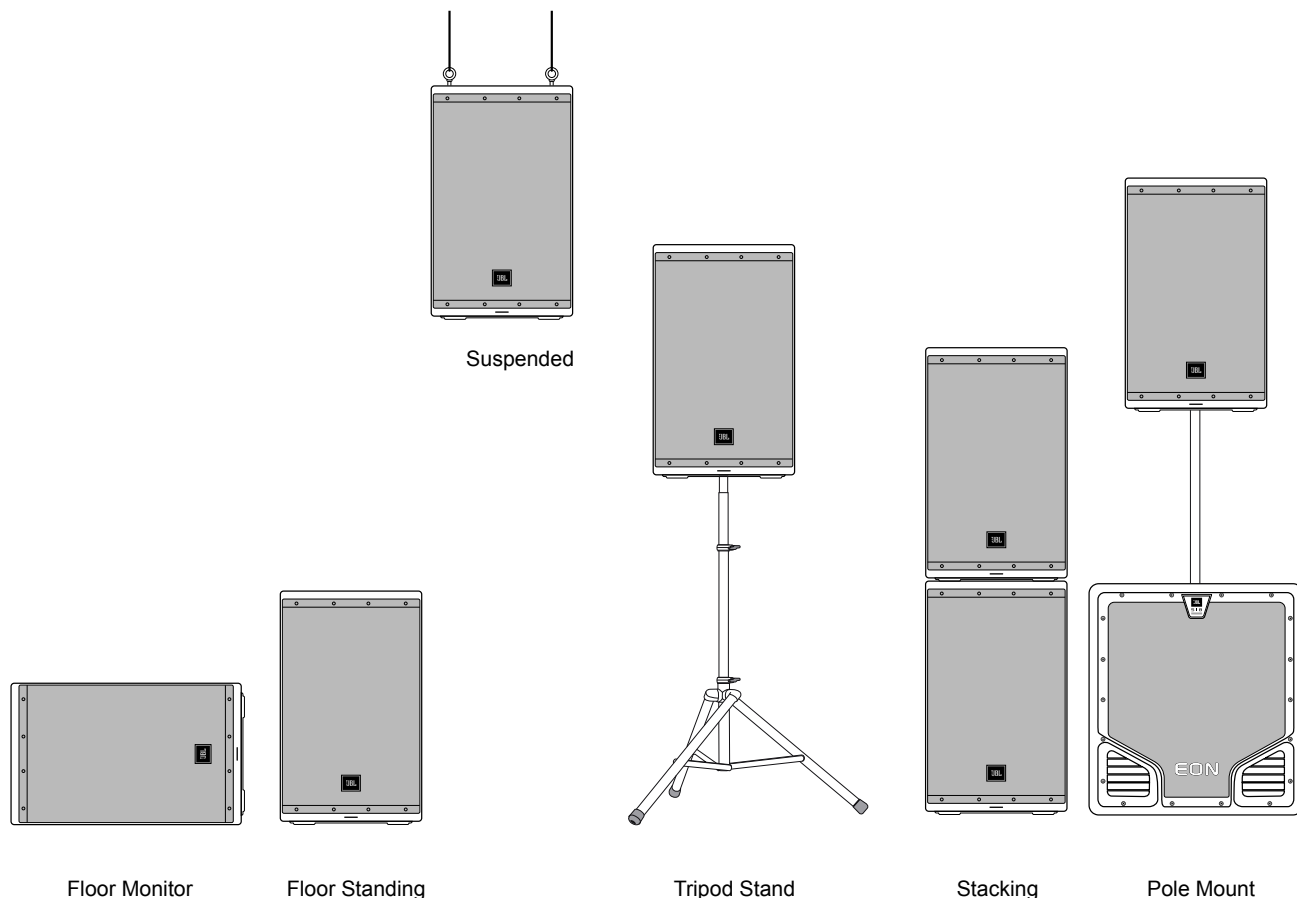

The following guidelines will help you achieve optimum sound wherever you use your EON® loudspeakers:

Raise the speakers as high as possible.

For best results try to get the high frequency horn at least 2 to 4 feet above the heads of the audience. If the speakers are too low, the people in the back of the audience will not receive the best quality sound.

Place the speakers between the microphones and the audience.

Feedback occurs when the microphones pick up sound from the speakers and “feed” the sound back through the sound system. If space is limited, point the speakers away from the microphones to reduce feedback.

Locate the speakers away from turntables.

Low-frequency feedback occurs when the output of the speaker is picked up by the tone arm of the turntable and is re-amplified. A heavy, solid turntable base and shock mounting can also reduce this type of feedback in DJ applications.

Use more speakers in large or highly reverberant spaces.

Spreading speakers throughout these spaces will produce much better sound than trying to compensate with loudness level or equalization. For very long distances, the use of another set of speakers with time delay is recommended.

Stand speakers upright for PA - Tilt the speakers back on the side for stage monitoring. Upright stance provides even coverage over a wide area. EON speakers are also designed with two slanted positions for stage monitoring applications.

APPLICATION EXAMPLES

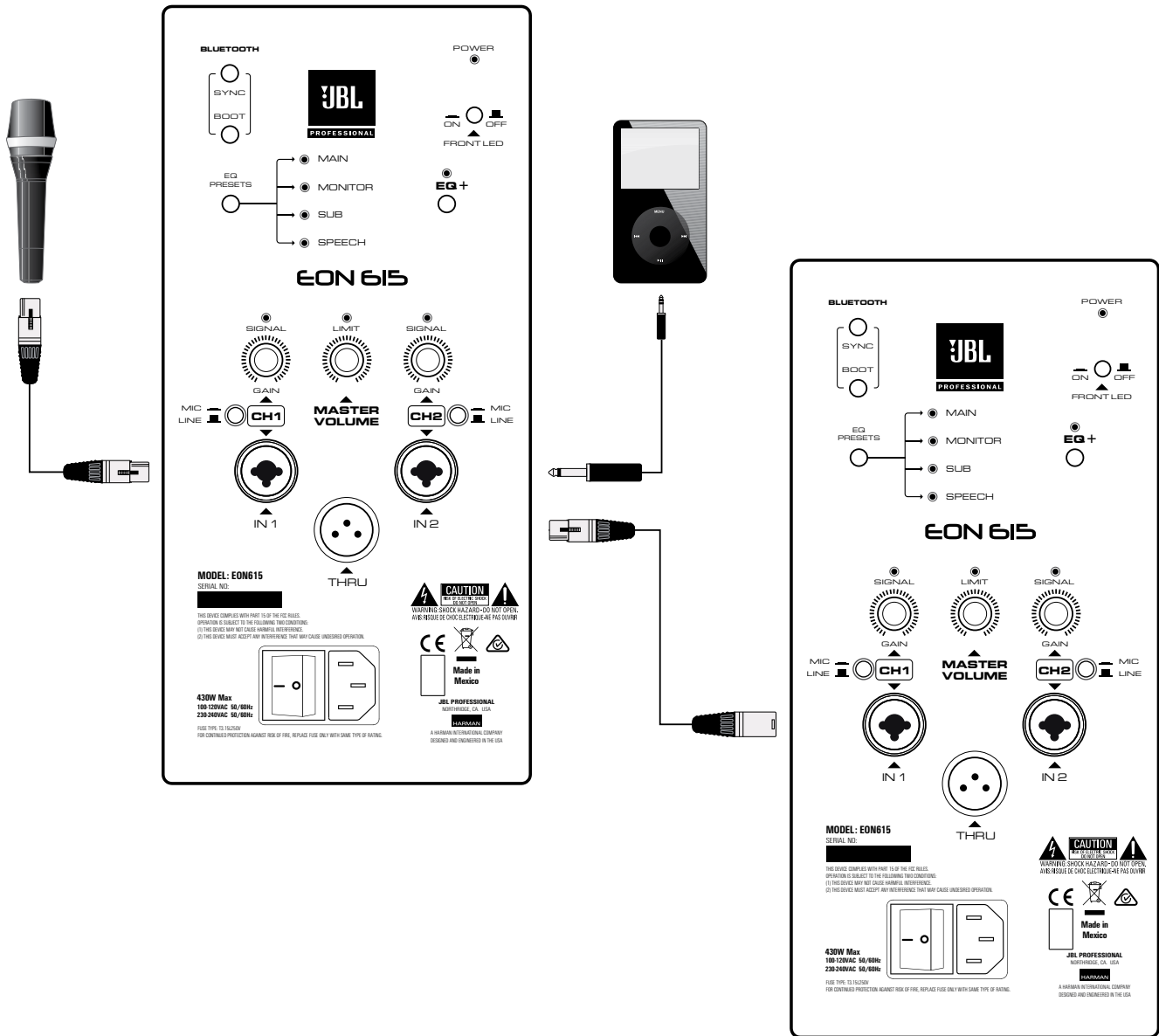

SMALL PA USING BOTH INPUTS AND THRU FUNCTION

CH1 input set to "Mic" CH2 input set to "Line"

EQ Preset: Main

APPLICATION EXAMPLES

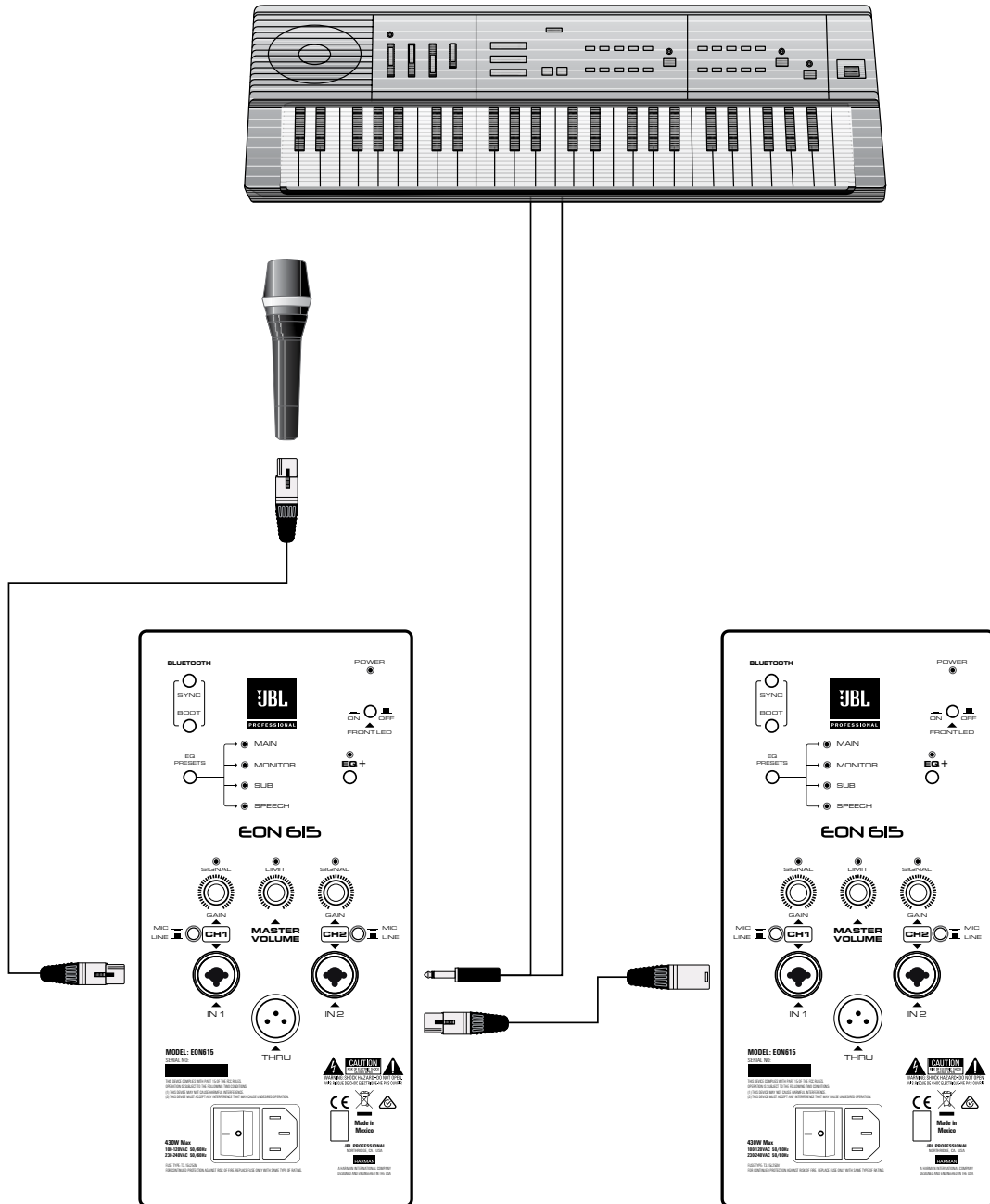

SMALL PA USING TWO SYSTEMS AS MONITORS

CH1 input set to "Mic" CH2 input set to "Line"

EQ Preset: Monitor

APPLICATION EXAMPLES

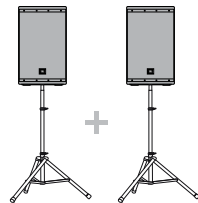
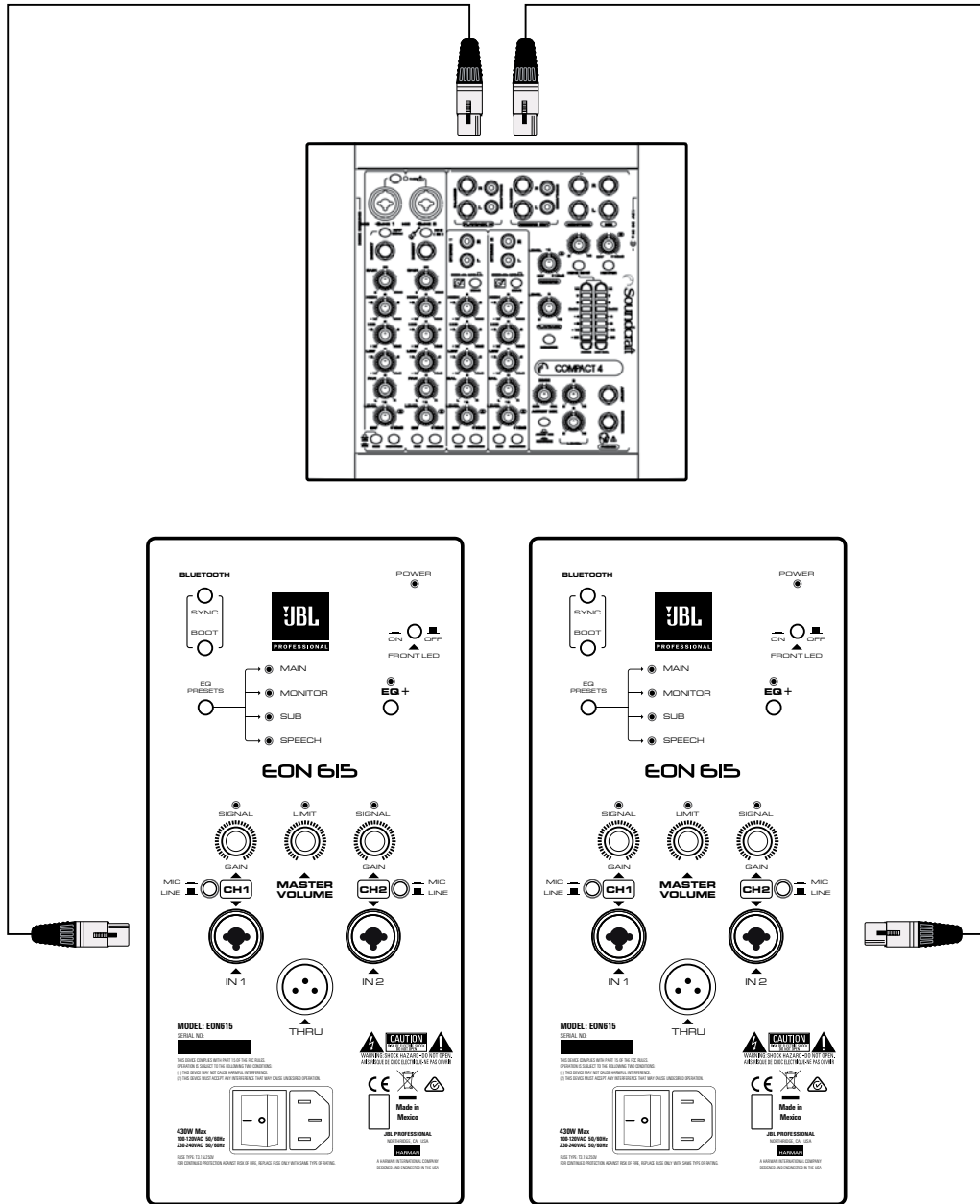

SMALL PA USING EXTERNAL MIXER

CH1 & CH2 Mic / Line inputs set to "Line"

EQ Preset: Main

TROUBLE SHOOTING

Symptom	Likely Cause	What to do
No sound	Speaker not connected to active AC power	Verify that speaker is connected and that the circuit is on
	Power not switched on	Switch on power and verify that power LED is on
No sound, speaker is connected to working AC power but won't come on.	Speaker power cable is faulty or improperly connected.	<ul style="list-style-type: none"> • Re-seat the power cable at both ends. • Substitute a known-good power cable
No sound. Speaker comes on.	Signal source (mixer, instrument, etc.) is not sending.	<ul style="list-style-type: none"> • Check VU meters on the source mixer • Verify that the tape or CD is playing. • Use headphones to verify that the instrument is actually sending an audio signal
	Faulty cables and connections	<ul style="list-style-type: none"> • Disconnect and re-seat signal cables. • Replace suspected cable with a known-good cable
No sound with microphone connected directly to the MIC/ LINE input.	Microphone requires phantom power	The EON does not supply phantom power. Switch to a dynamic microphone, use a battery powered microphone (if possible), use an external phantom power supply for condenser type microphones.
Signal sounds distorted and very loud, PEAK light is lit most of the time.	Excessive input signal, trying to exceed the capabilities of the speakers	<ul style="list-style-type: none"> • Reduce the output level of the source. • Turn down the level controls on the speaker. • Use additional EON speakers.
Signal sounds distorted even at moderate volumes, LIMIT light is not lit.	Mixer or other source is overdriven	<p>Review the Owner's Manual for your mixer and adjust controls as needed.</p> <ul style="list-style-type: none"> • Input sensitivity (gain) • Channel faders • Master faders Once this is done, review the instructions in the Quick Start section of this guide.
Lots of hiss in the sound, the mixer controls are at very low settings.	Improper gain structure	<ul style="list-style-type: none"> • Make sure that the MIC/LINE switch is in the LINE (disengaged) position. • Reduce the level settings at speaker. Review the Owner's Manual for your mixer and adjust controls as needed. • Input sensitivity (gain) • Channel faders • Master faders
Noise or hiss heard at output.	Noisy source device	Disconnect the devices that are connected to your speaker one at a time. If the noise goes away, the problem is with the source or the connecting cable.
Hum or Buzz that increases or decreases when the mixer level controls are moved.	Improper A/C ground or faulty equipment connected to mixer input	Disconnect or mute channels one at a time to isolate the problem. Refer to the owner's manual of the faulty equipment for troubleshooting help.
	Faulty cable between source equipment and mixer	Substitute a known-good cable for the suspected faulty cable.
Hum or Buzz	Improper A/C grounding, ground loops	<ul style="list-style-type: none"> • 'Lift' the audio ground by using an XLR/F to XLR/M adapter on one end. • Re-route audio cables away from AC power and lighting cables.
	Excessively long unbalanced cable run	<ul style="list-style-type: none"> • Use the balanced outputs (if available) of your mixer or source equipment to drive your EON speakers. • Use a "DI" (direct injection) box to convert your unbalanced equipment output to a balanced output.
	Improper system gain structure	Reduce the INPUT level controls and increase the output level of your source devices.

WARRANTY INFORMATION

The JBL Limited Warranty on professional loudspeaker products (except for enclosures) remains in effect for five years from the date of the first consumer purchase. JBL amplifiers are warranted for three years from the date of original purchase. Enclosures and all other JBL products are warranted for two years from the date of original purchase.

Who Is Protected By This Warranty?

Your JBL Warranty protects the original owner and all subsequent owners so long as: A.) Your JBL product has been purchased in the Continental United States, Hawaii or Alaska. (This Warranty does not apply to JBL products purchased elsewhere except for purchases by military outlets. Other purchasers should contact the local JBL distributor for warranty information.); and B.) The original dated bill of sale is presented whenever warranty service is required.

What Does The JBL Warranty Cover?

Except as specified below, your JBL Warranty covers all defects in material and workmanship. The following are not covered: Damage caused by accident, misuse, abuse, product modification or neglect; damage occurring during shipment; damage resulting from failure to follow instructions contained in your Instruction Manual; damage resulting from the performance of repairs by someone not authorized by JBL; claims based upon any misrepresentations by the seller; any JBL product on which the serial number has been defaced, modified or removed.

Who Pays For What?

JBL will pay all labor and material expenses for all repairs covered by this warranty. Please be sure to save the original shipping cartons because a charge will be made if replacement cartons are requested. Payment of shipping charges is discussed in the next section of this warranty.

How To Obtain Warranty Performance

If your JBL product ever needs service, write or telephone us at JBL Incorporated (Attn: Customer Service Department), 8500 Balboa Boulevard, PO. Box 2200, Northridge, California 91329 (818/893-8411). We may direct you to an authorized JBL Service Agency or ask you to send your unit to the factory for repair. Either way, you'll need to present the original bill of sale to establish the date of purchase. Please do not ship your JBL product to the factory without prior authorization. If transportation of your JBL product presents any unusual difficulties, please advise us and we may make special arrangements with you. Otherwise, you are responsible for transporting your product for repair or arranging for its transportation and for payment of any initial shipping charges. However, we will pay the return shipping charges if repairs are covered by the warranty.

Limitation of Implied Warranties

ALL IMPLIED WARRANTIES, INCLUDING WARRANTIES OF MERCHANTABILITY AND FITNESS FOR PARTICULAR PURPOSE, ARE LIMITED IN DURATION TO THE LENGTH OF THIS WARRANTY.

EXCLUSION OF CERTAIN DAMAGES

JBL'S LIABILITY IS LIMITED TO THE REPAIR OR REPLACEMENT, AT OUR OPTION, OF ANY DEFECTIVE PRODUCT AND SHALL NOT INCLUDE INCIDENTAL OR CONSEQUENTIAL DAMAGES OF ANY KIND. SOME STATES DO NOT ALLOW LIMITATIONS ON HOW LONG AN IMPLIED WARRANTY LASTS AND/OR DO NOT ALLOW THE EXCLUSION OF INCIDENTAL OR CONSEQUENTIAL DAMAGES, SO THE ABOVE LIMITATIONS AND EXCLUSIONS MAY NOT APPLY TO YOU. THIS WARRANTY GIVES YOU SPECIFIC LEGAL RIGHTS, AND YOU MAY ALSO HAVE OTHER RIGHTS, WHICH VARY, FROM STATE TO STATE.

JBL Professional

8500 Balboa Blvd. Northridge, CA 91329 USA

CONTACT INFORMATION



Mailing Address:

JBL Professional
8500 Balboa Blvd.
Northridge, CA 91329

Shipping Address:

JBL Professional
8500 Balboa Blvd., Dock 15
Northridge, CA 91329

(Do not return product to this address without first obtaining prior authorization from JBL)

Customer Service:

Monday through Friday
8:00am -5:00pm
Pacific Coast Time in the U.S.A.

(800) 8JBLPRO (800.852.5776)

www.jblproservice.com

On The World Wide Web:

www.jblpro.com

Professional Contacts, Outside the USA:

Contact the JBL Professional Distributor in your area.

A complete list of JBL Professional international distributors is provided at our U.S.A. website: www.jblpro.com

EON 600

S E R I E S