

11AX20MIMO\_Ant1\_2437\_26Tone\_RU0

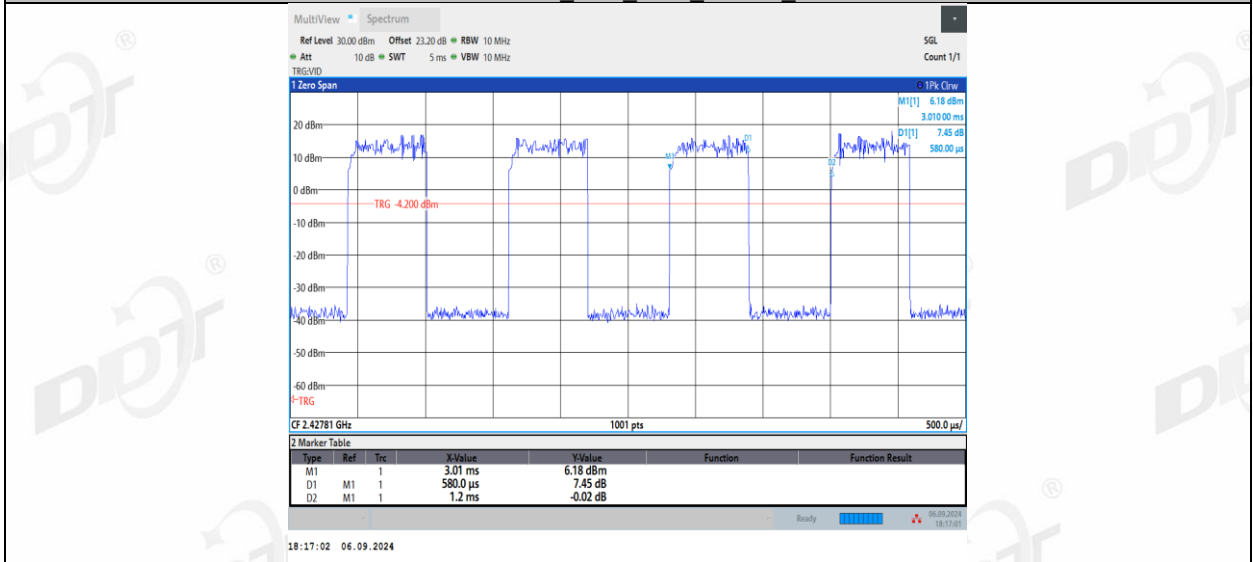

11AX20MIMO\_Ant1\_2437\_26Tone\_RU4

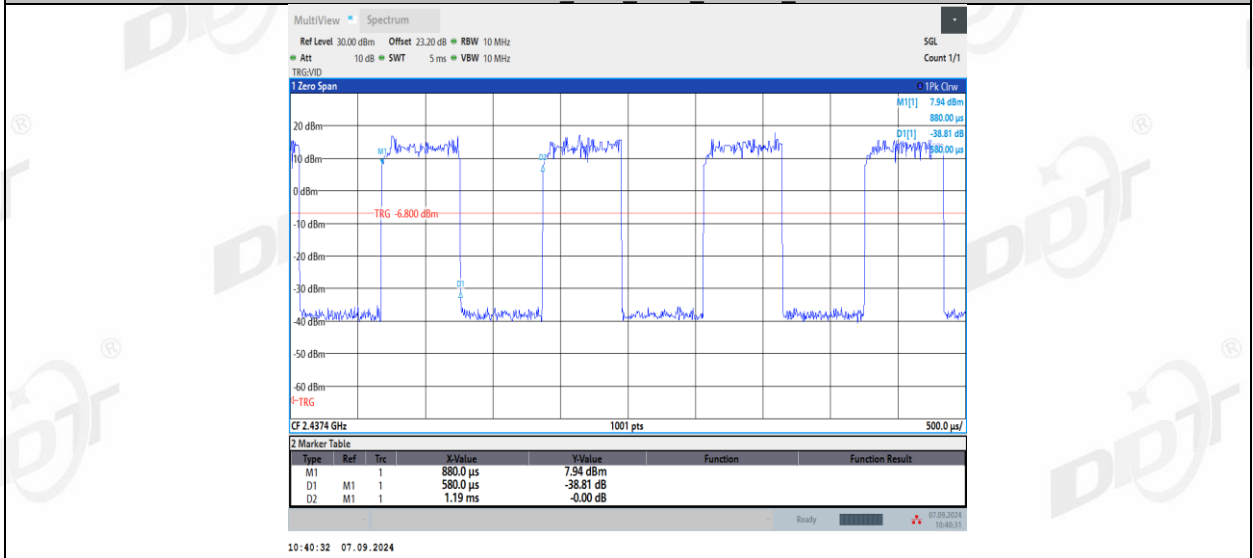

11AX20MIMO\_Ant1\_2437\_26Tone\_RU8

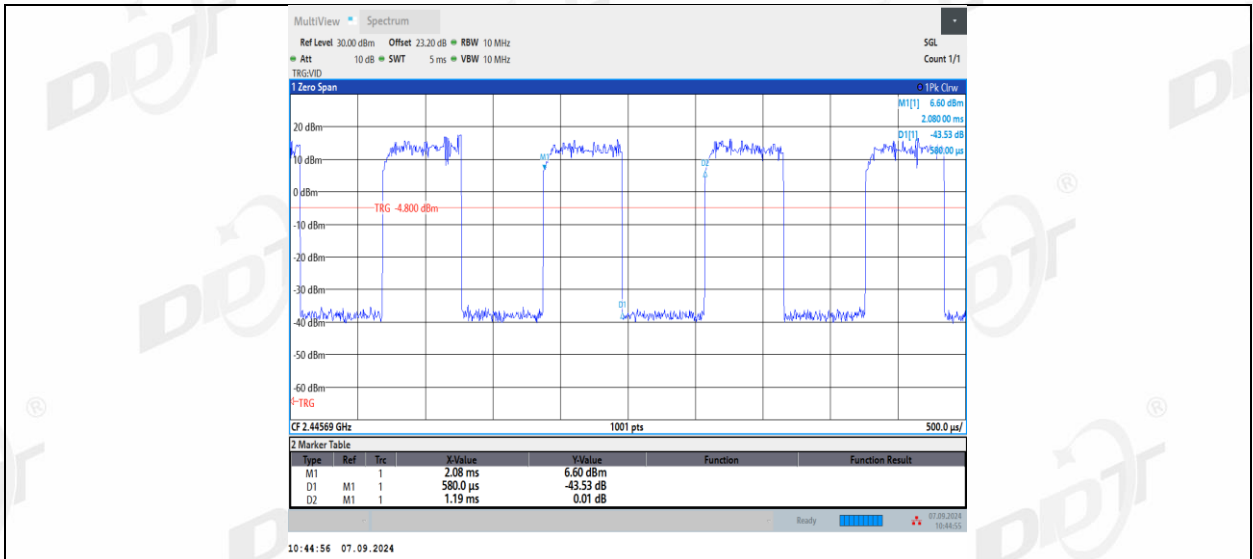

11AX20MIMO Ant1 2437\_52Tone RU37

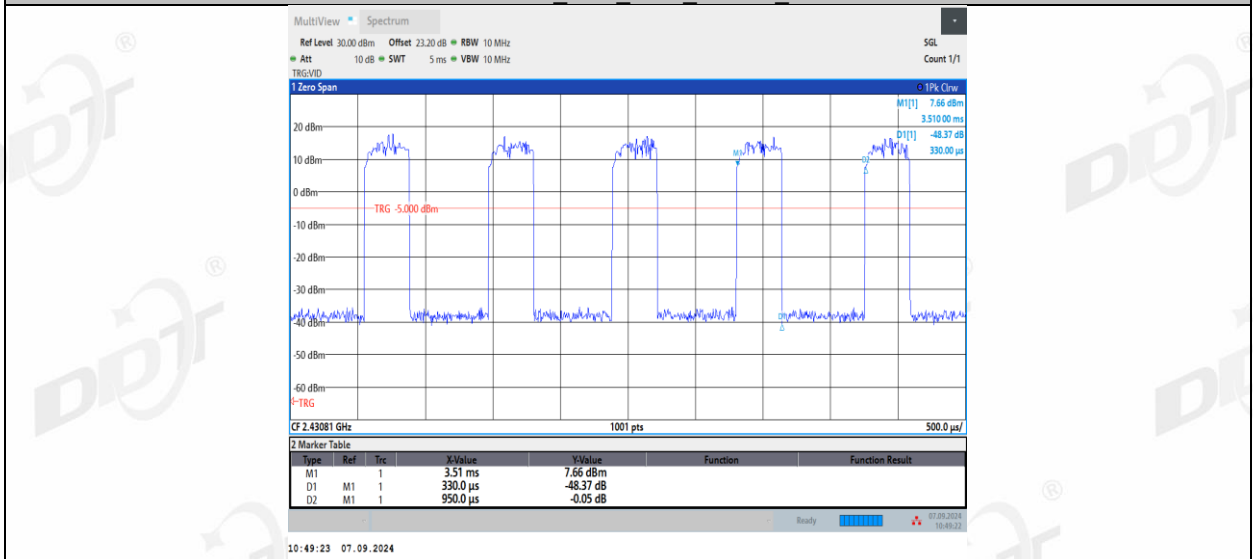

11AX20MIMO Ant1 2437\_52Tone RU39

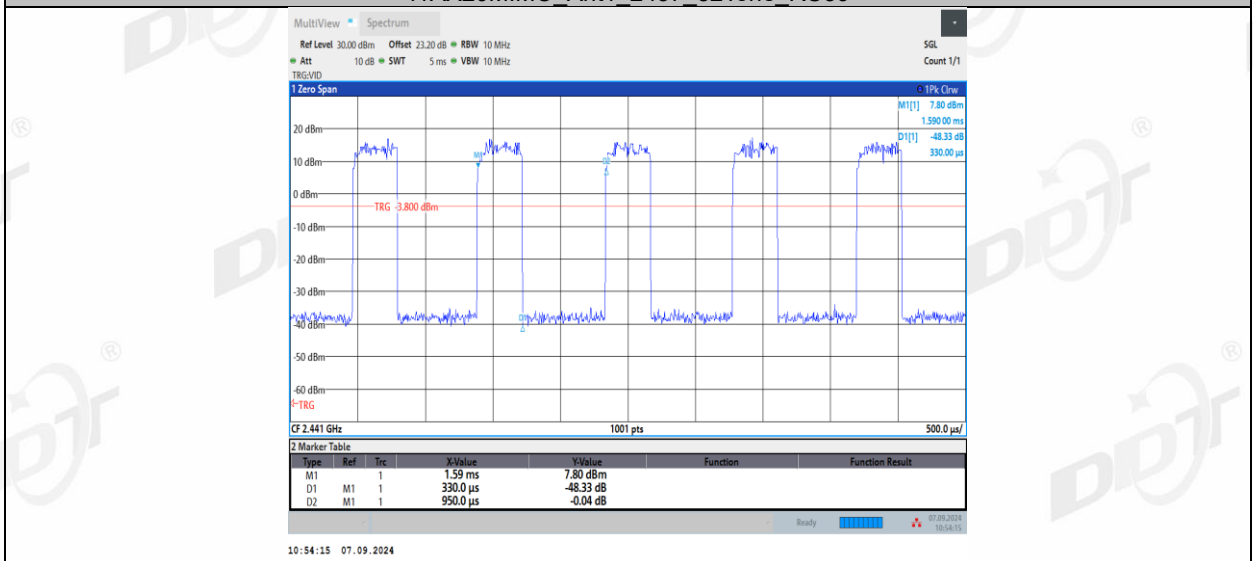

11AX20MIMO Ant1 2437\_52Tone RU40

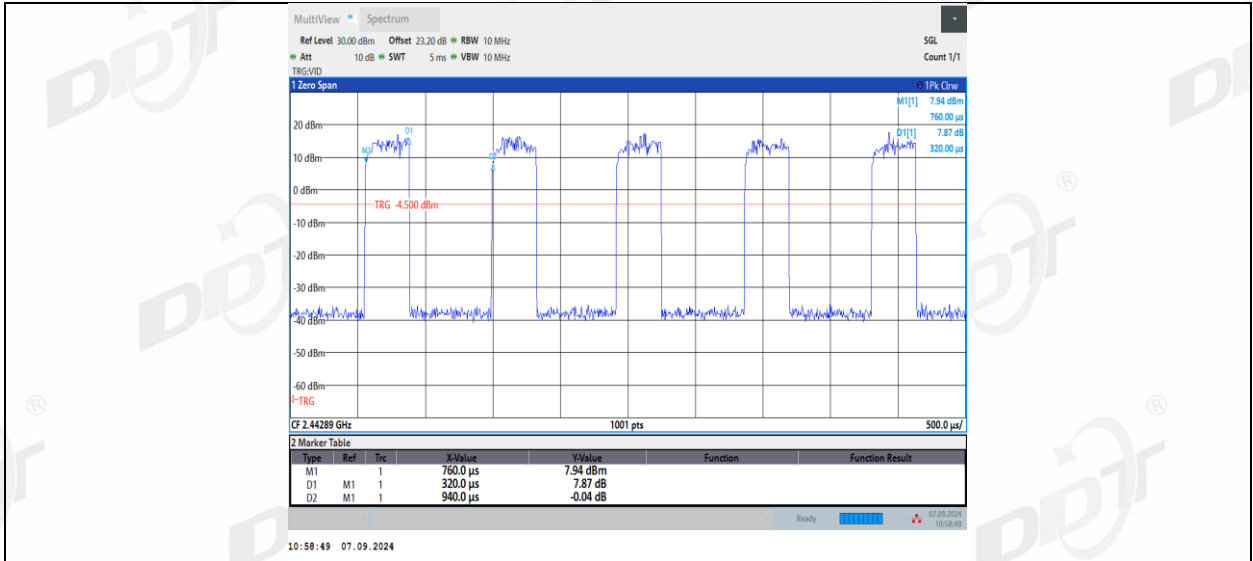

11AX20MIMO\_Ant1\_2437\_106Tone\_RU53

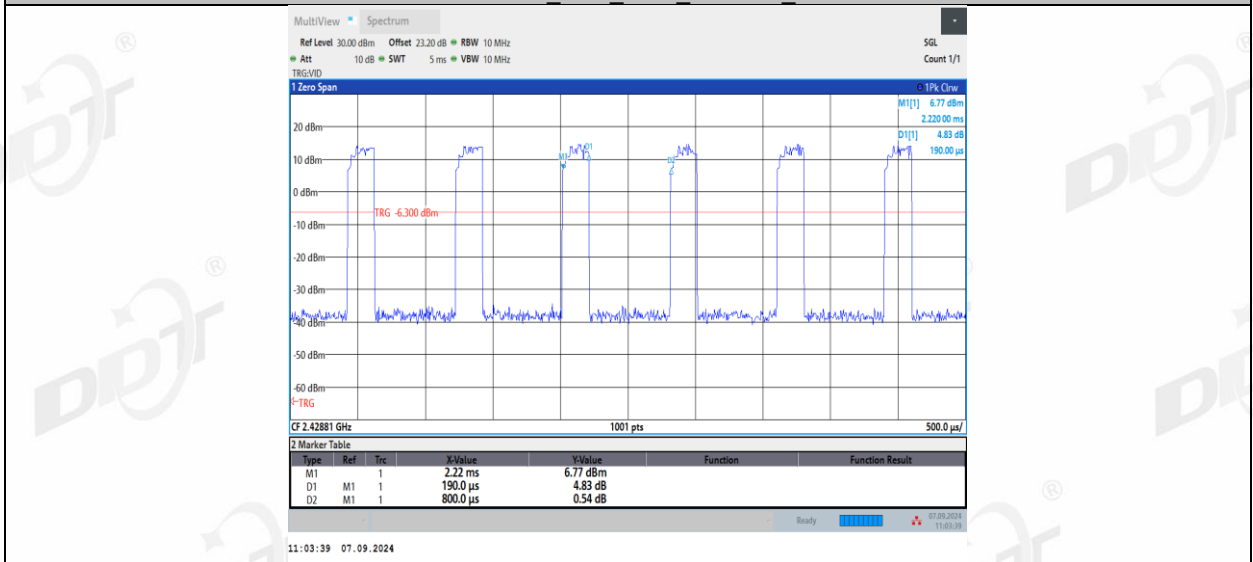

11AX20MIMO\_Ant1\_2437\_106Tone\_RU54

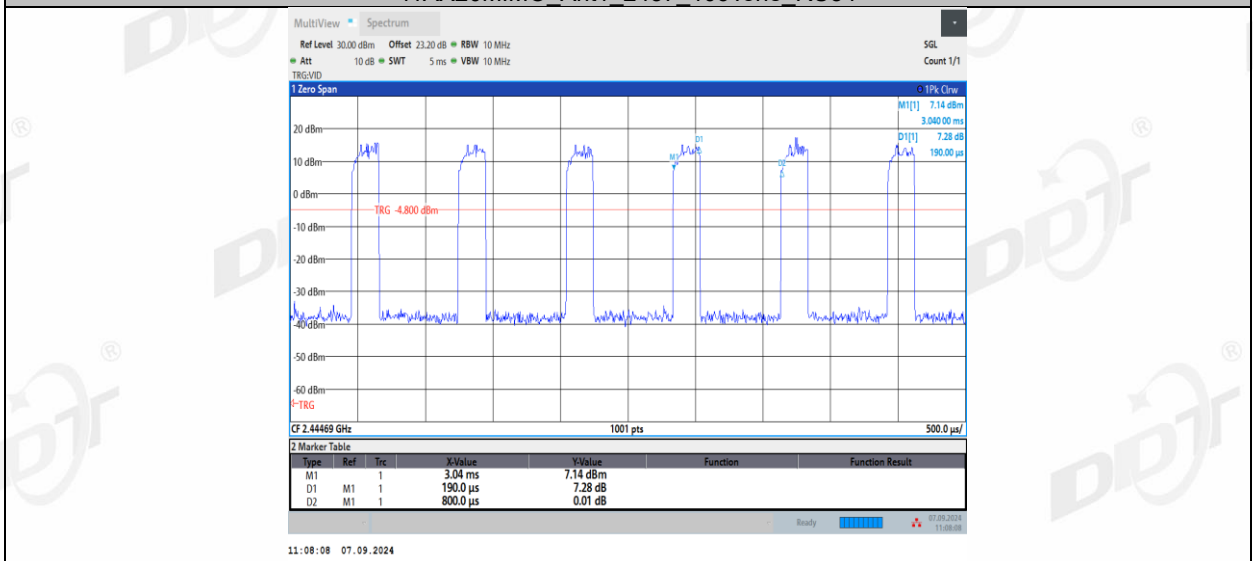

11AX20MIMO\_Ant2\_2437\_26Tone\_RU0



11AX20MIMO\_Ant2\_2437\_26Tone\_RU4

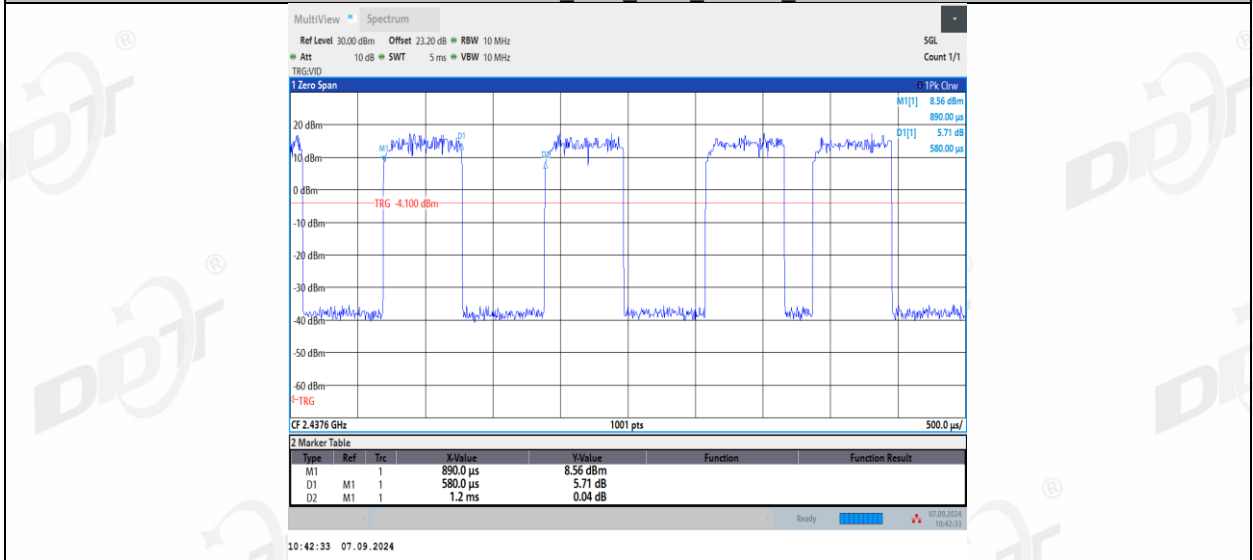

11AX20MIMO\_Ant2\_2437\_26Tone\_RU6

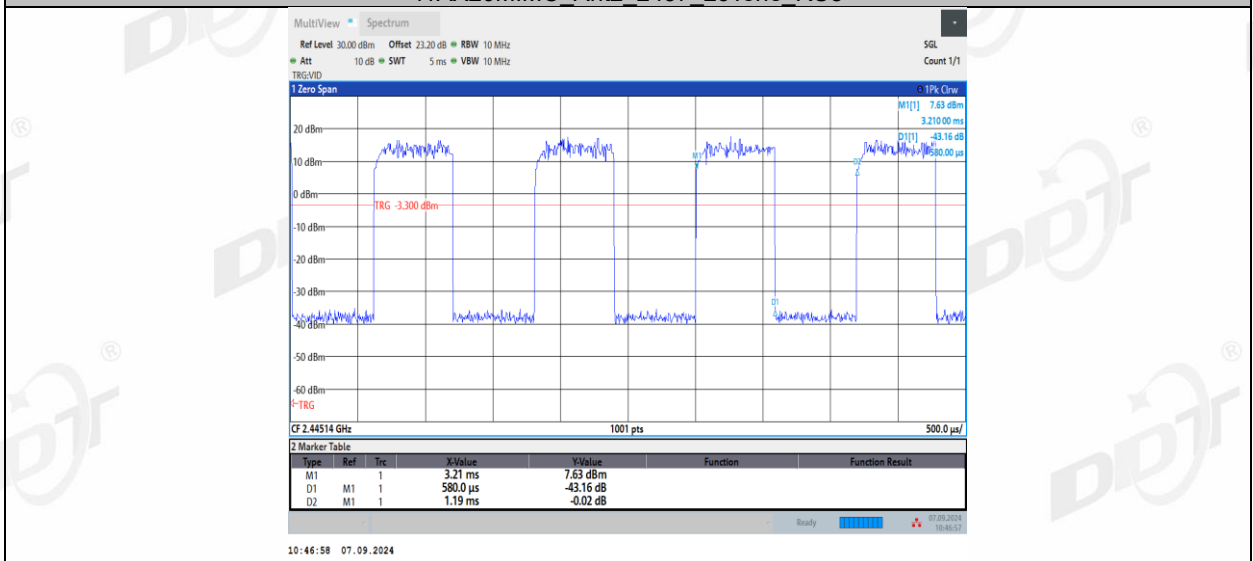

11AX20MIMO\_Ant2\_2437\_52Tone\_RU37

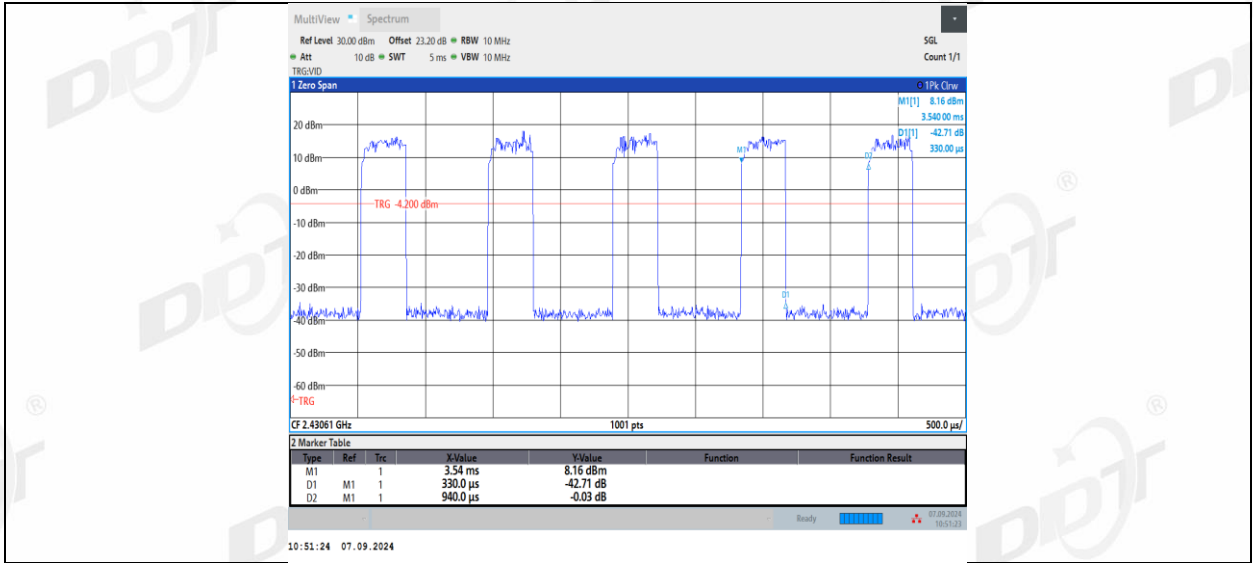

11AX20MIMO Ant2 2437\_52Tone RU39

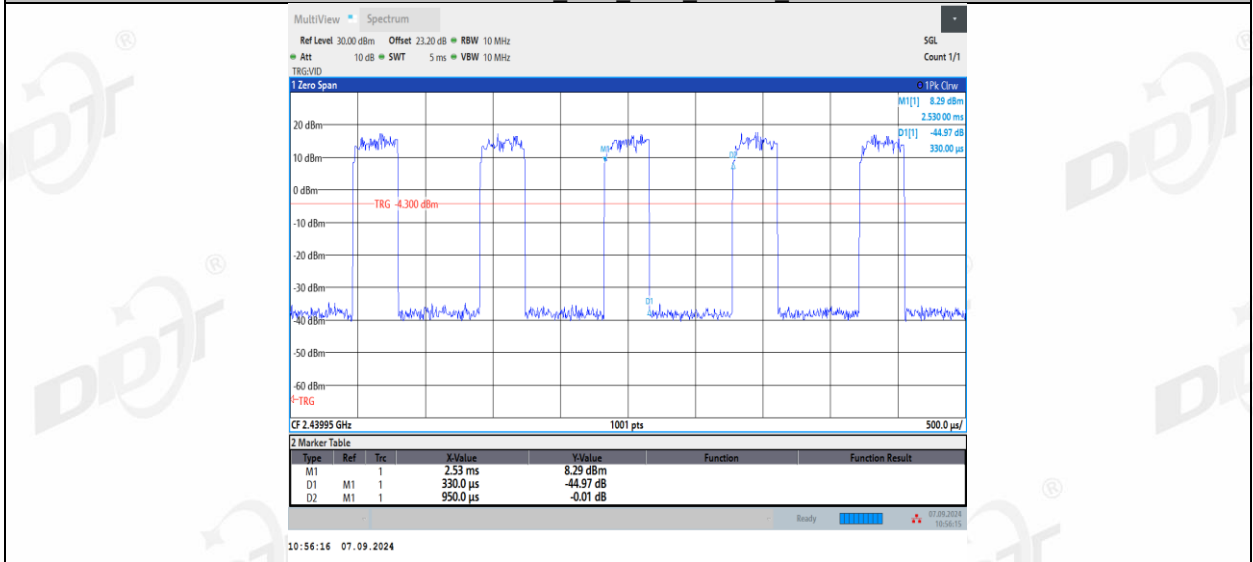

11AX20MIMO Ant2 2437\_52Tone RU40

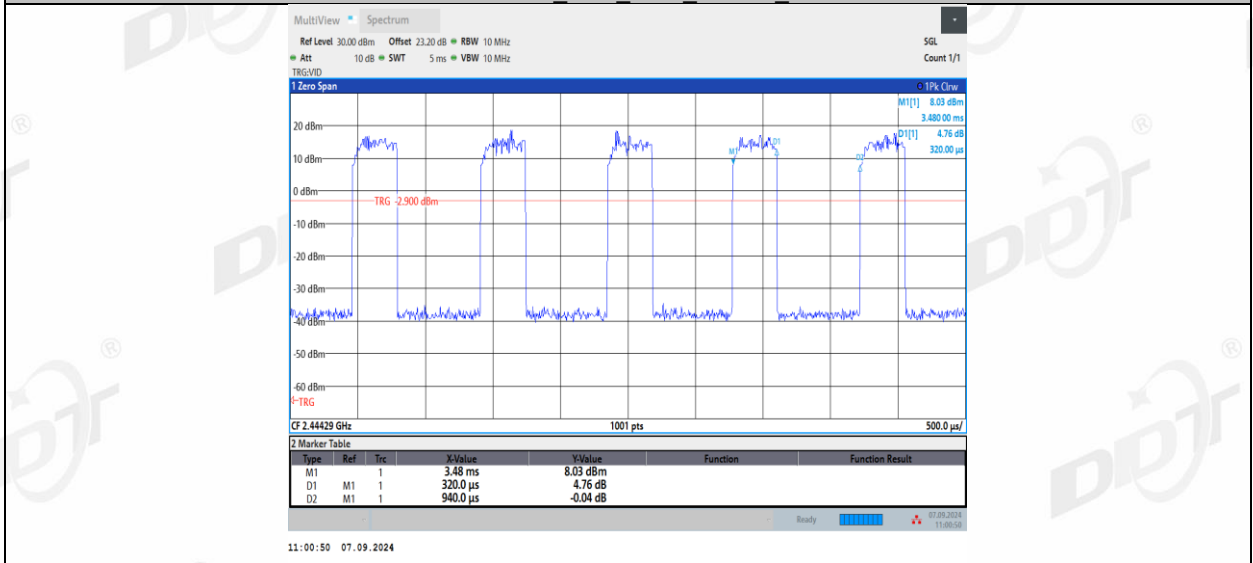

11AX20MIMO Ant2 2437\_106Tone RU53

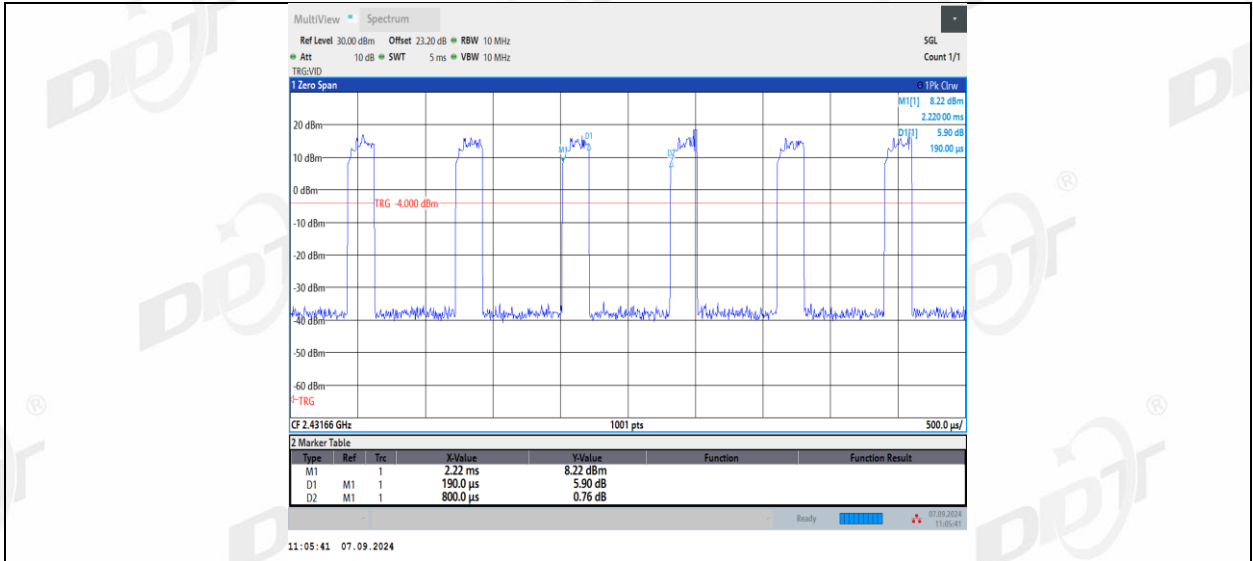

11AX20MIMO\_Ant2\_2437\_106Tone\_RU54

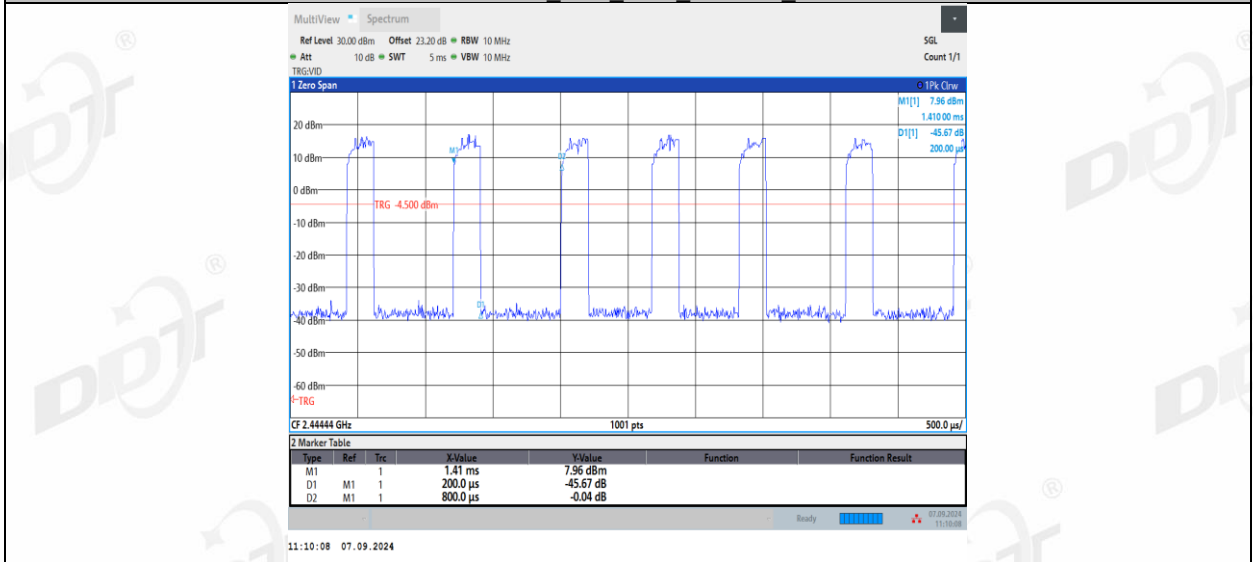

11AX20MIMO\_Ant1\_2462\_26Tone\_RU0

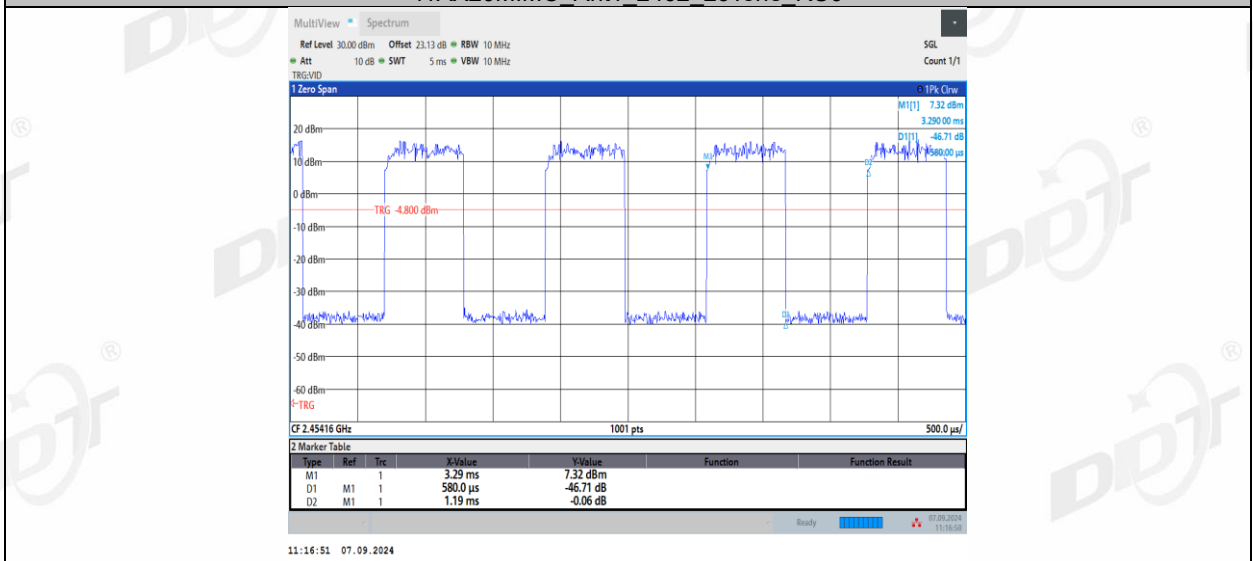

11AX20MIMO\_Ant1\_2462\_26Tone\_RU4

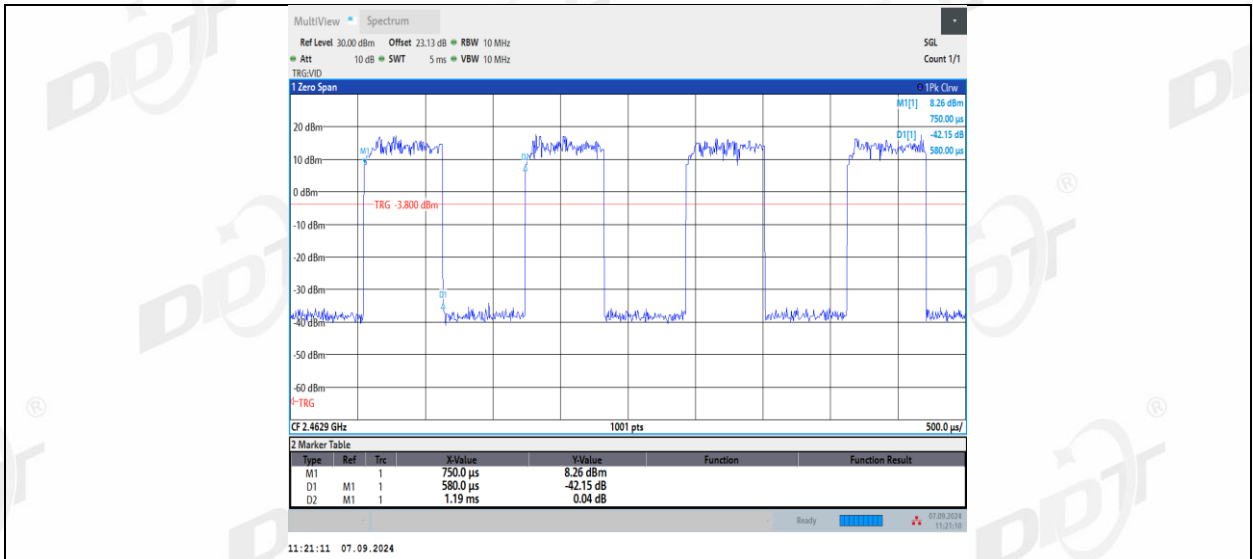

11AX20MIMO\_Ant1\_2462\_26Tone\_RU8

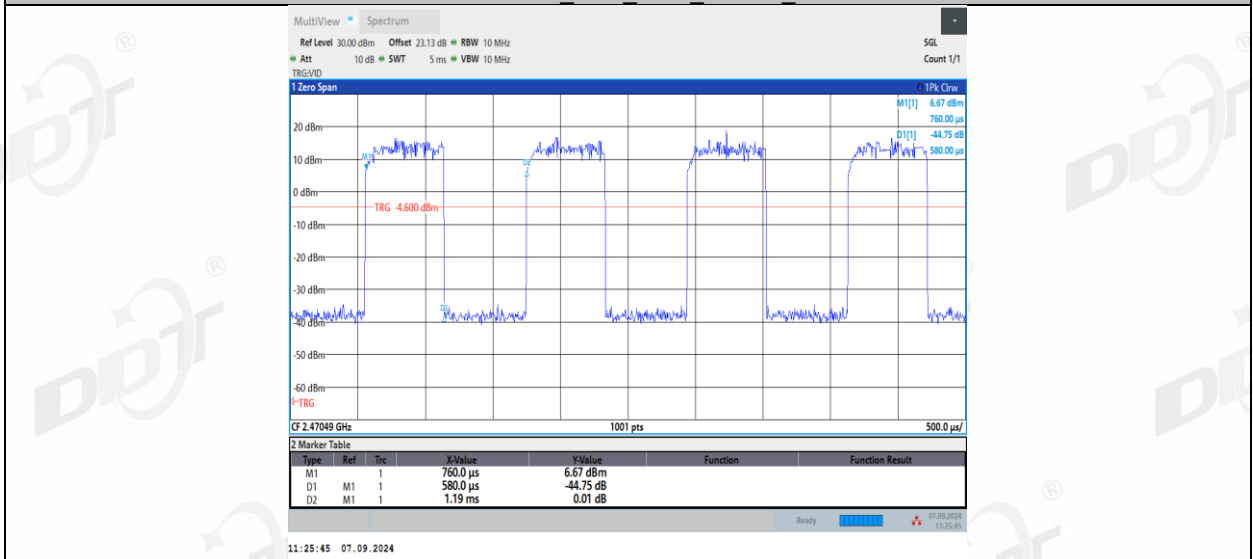

11AX20MIMO\_Ant1\_2462\_52Tone\_RU37

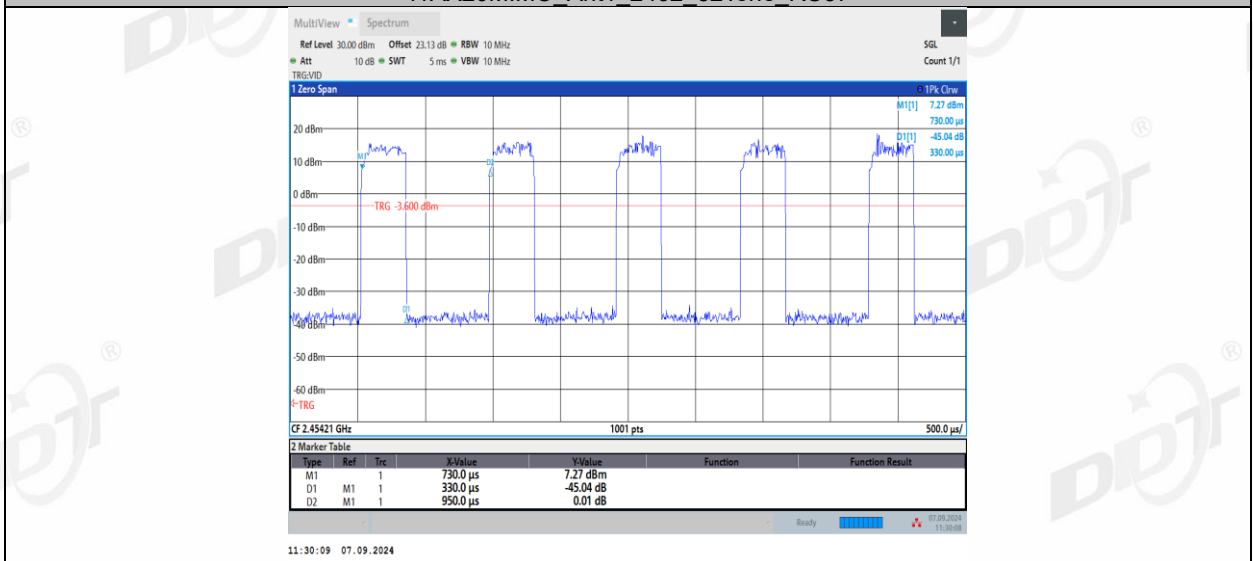

11AX20MIMO\_Ant1\_2462\_52Tone\_RU39



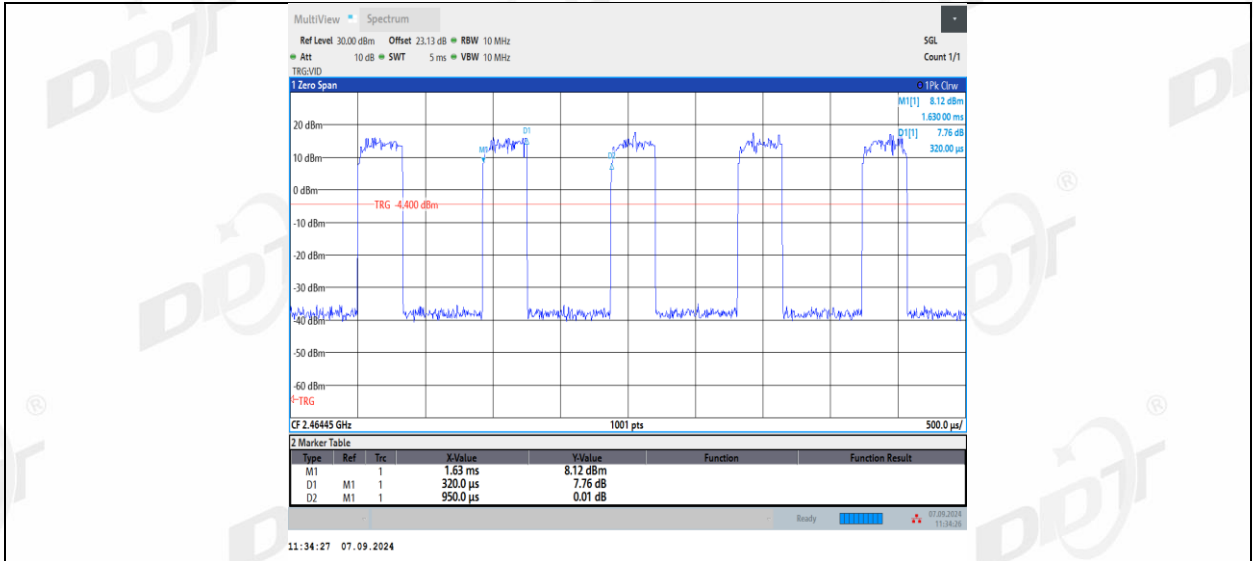

11AX20MIMO\_Ant1\_2462\_52Tone\_RU40

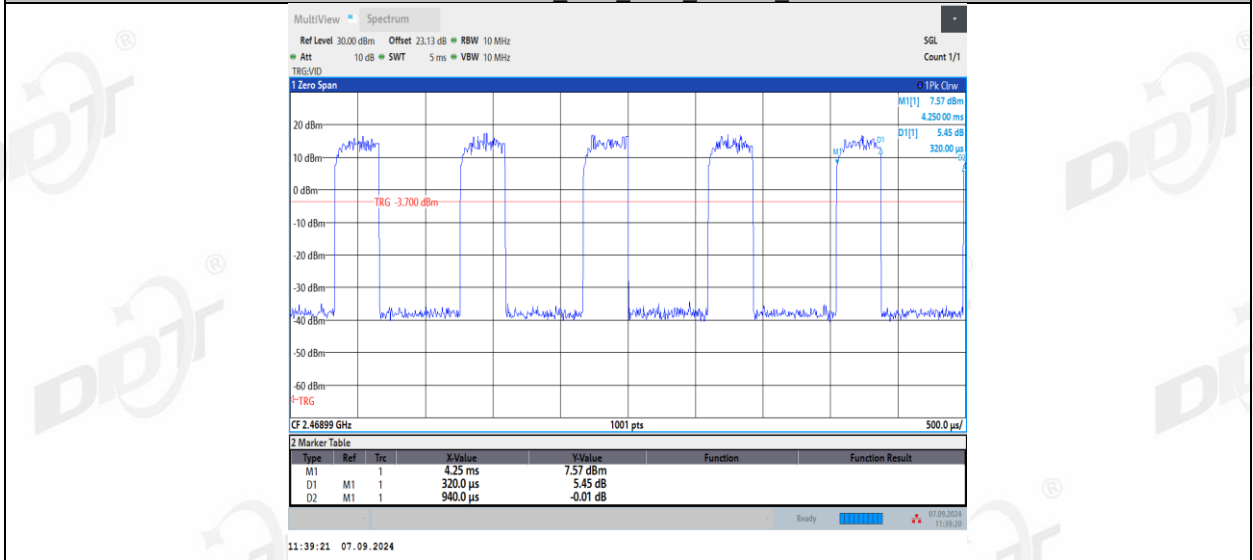

11AX20MIMO\_Ant1\_2462\_106Tone\_RU53

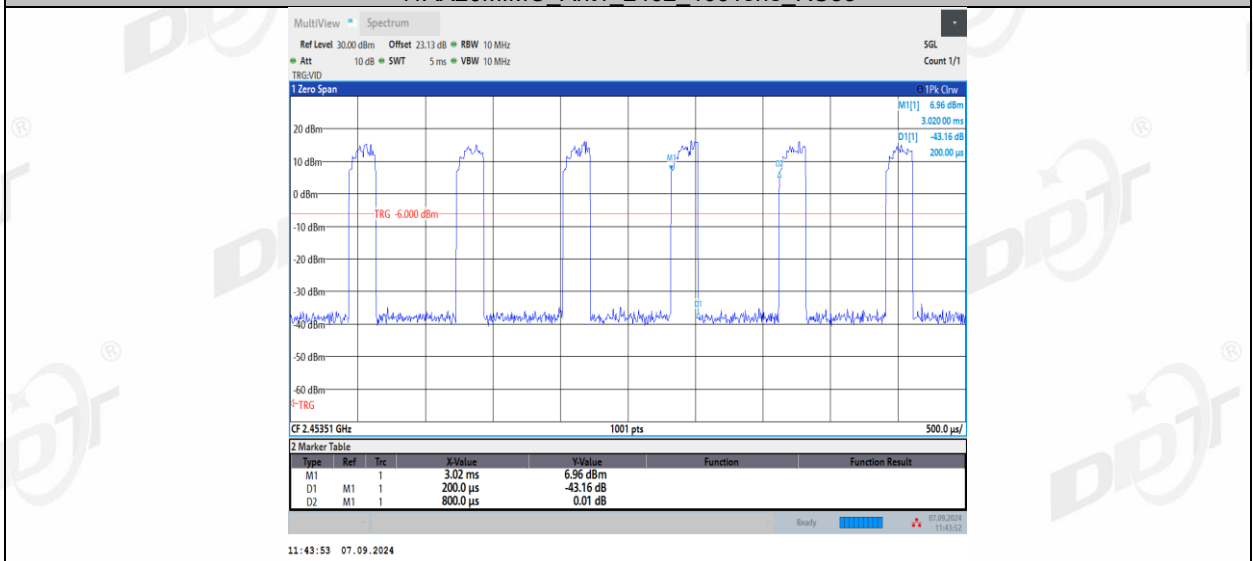

11AX20MIMO\_Ant1\_2462\_106Tone\_RU54



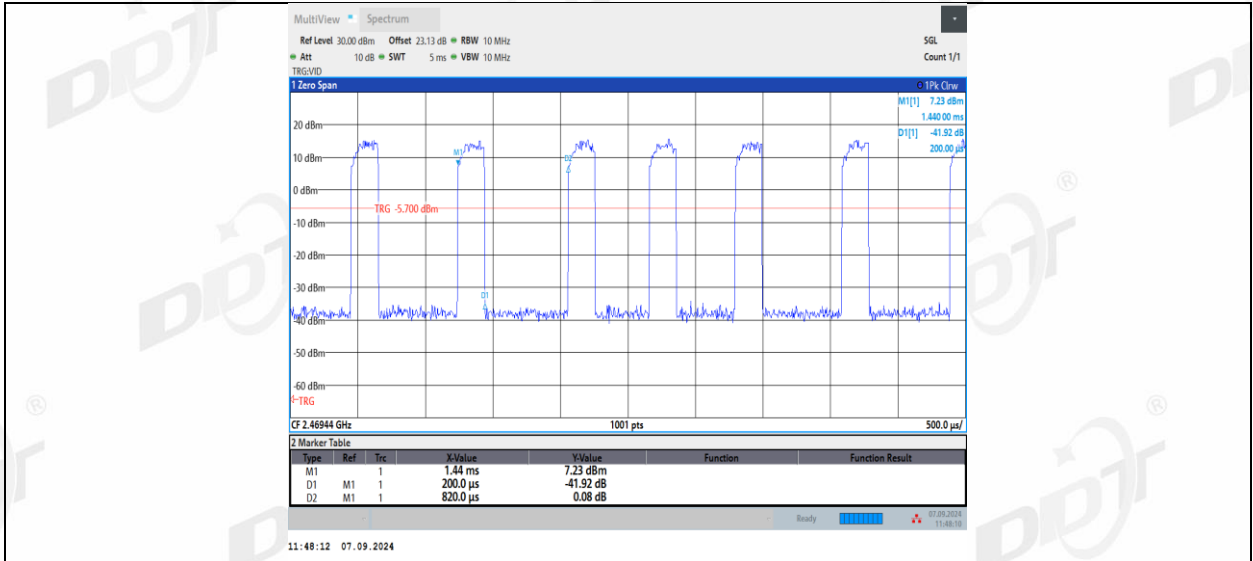

11AX20MIMO\_Ant2\_2462\_26Tone\_RU0

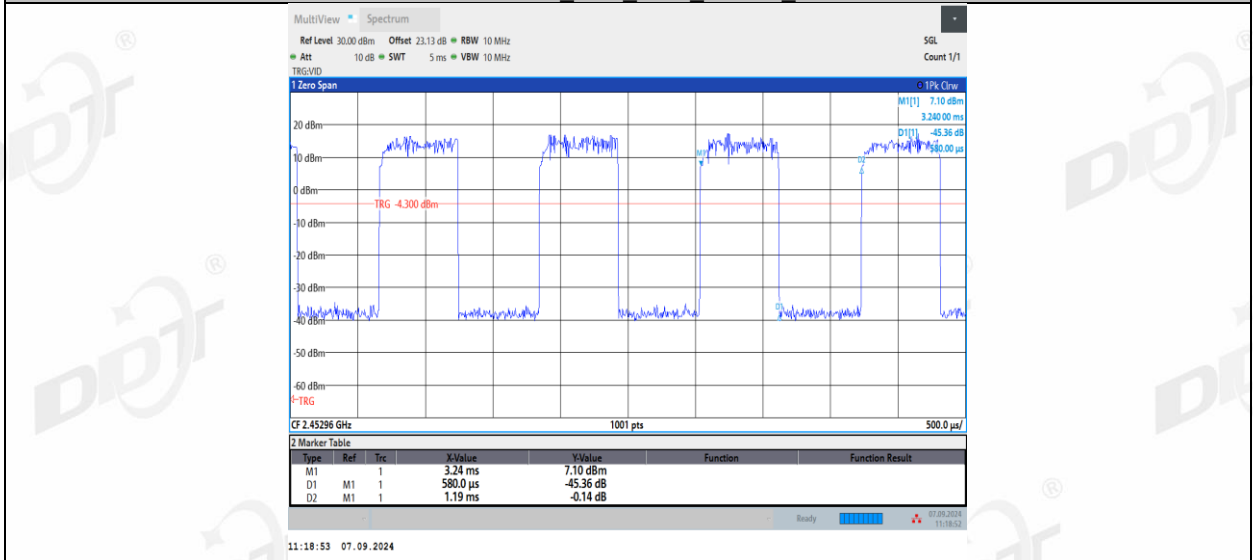

11AX20MIMO\_Ant2\_2462\_26Tone\_RU4

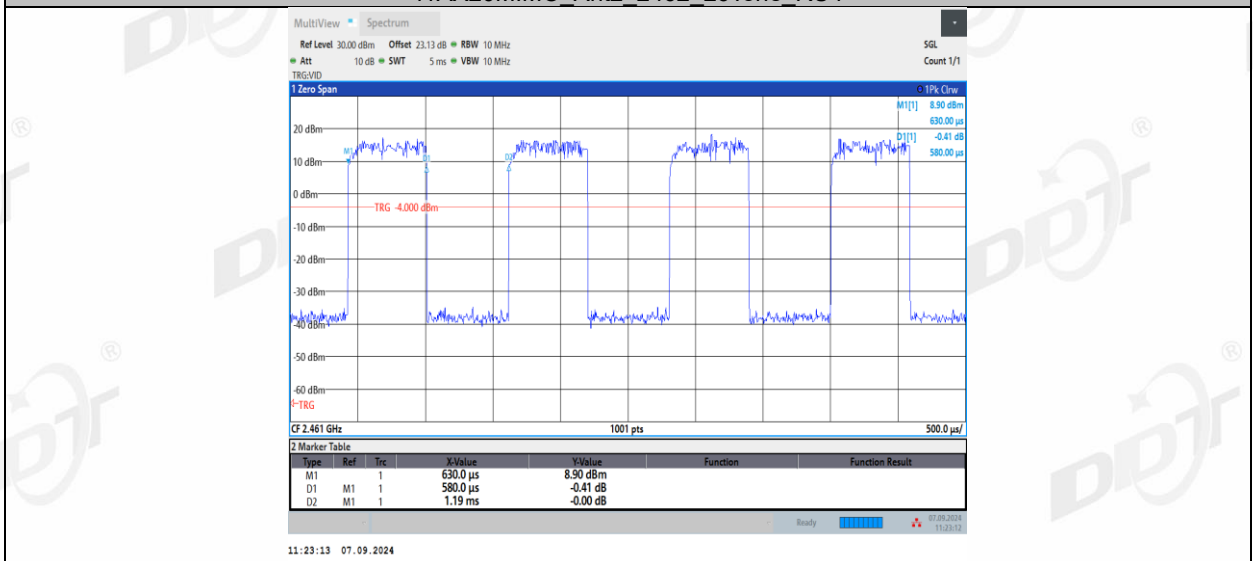

11AX20MIMO\_Ant2\_2462\_26Tone\_RU8

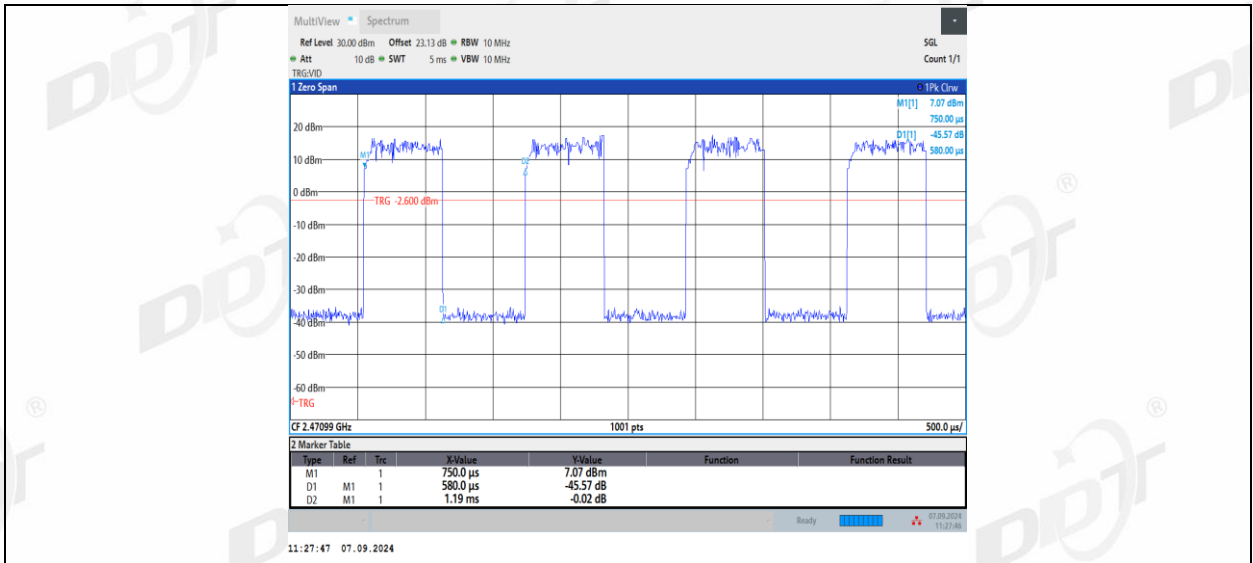

11AX20MIMO Ant2 2462\_52Tone RU37

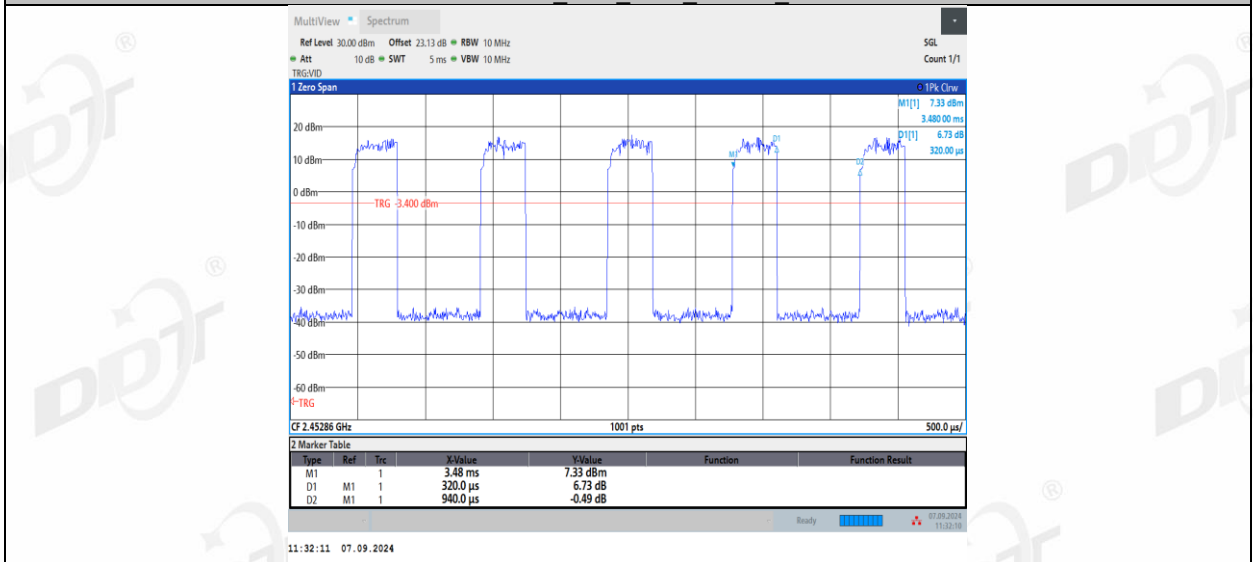

11AX20MIMO Ant2 2462\_52Tone RU39

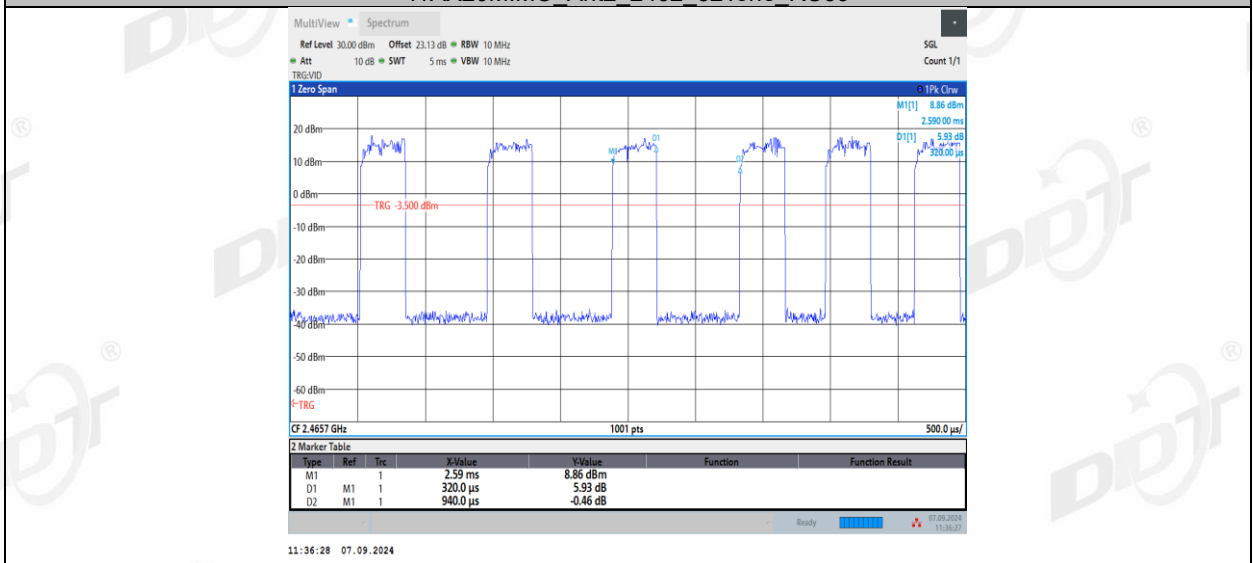

11AX20MIMO Ant2 2462\_52Tone RU40

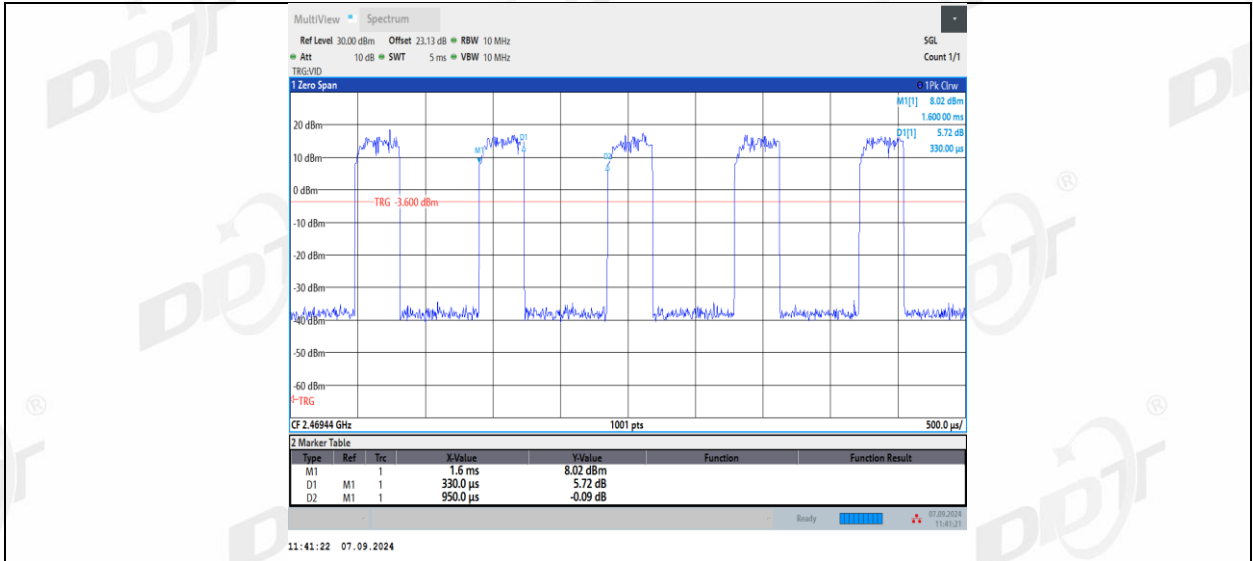

11AX20MIMO\_Ant2\_2462\_106Tone\_RU53

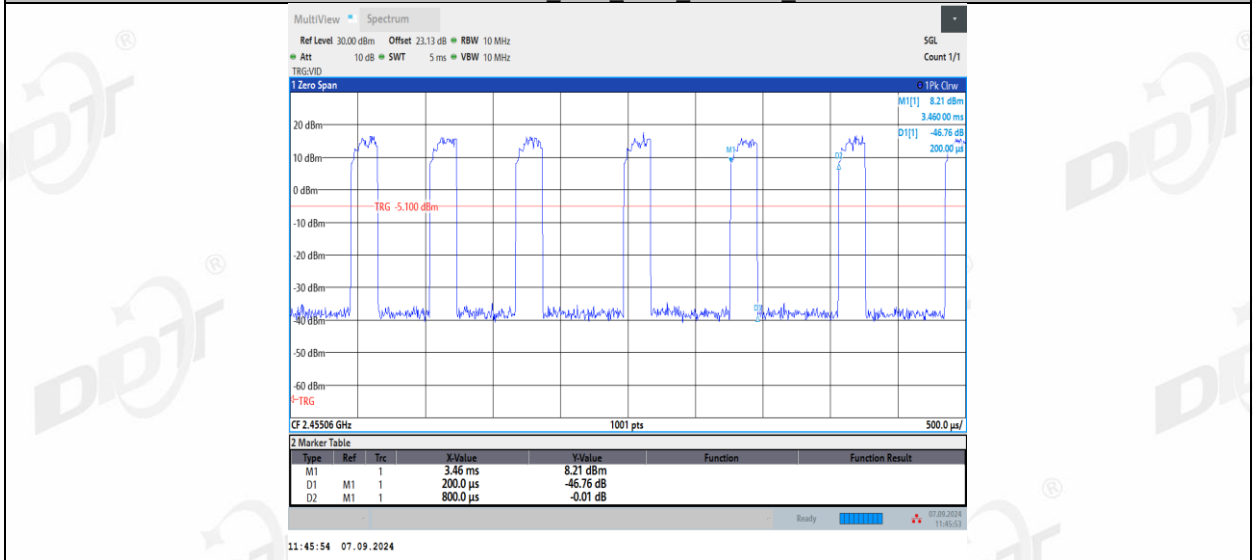

11AX20MIMO\_Ant2\_2462\_106Tone\_RU54

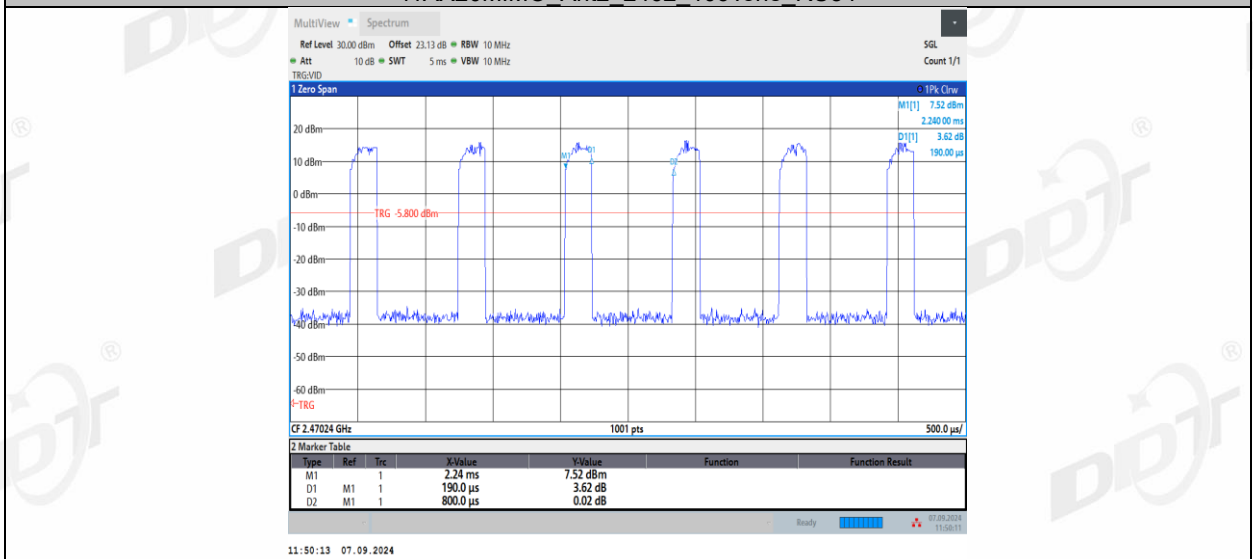

11AX40MIMO\_Ant1\_2422\_242Tone\_RU61

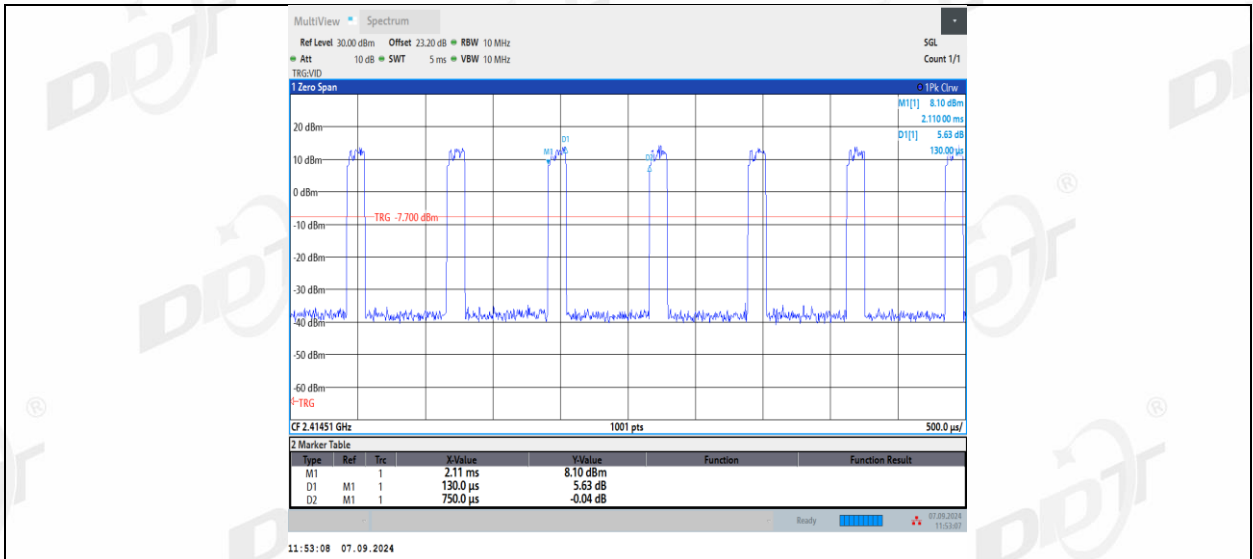

11AX40MIMO\_Ant1\_2422\_242Tone\_RU62

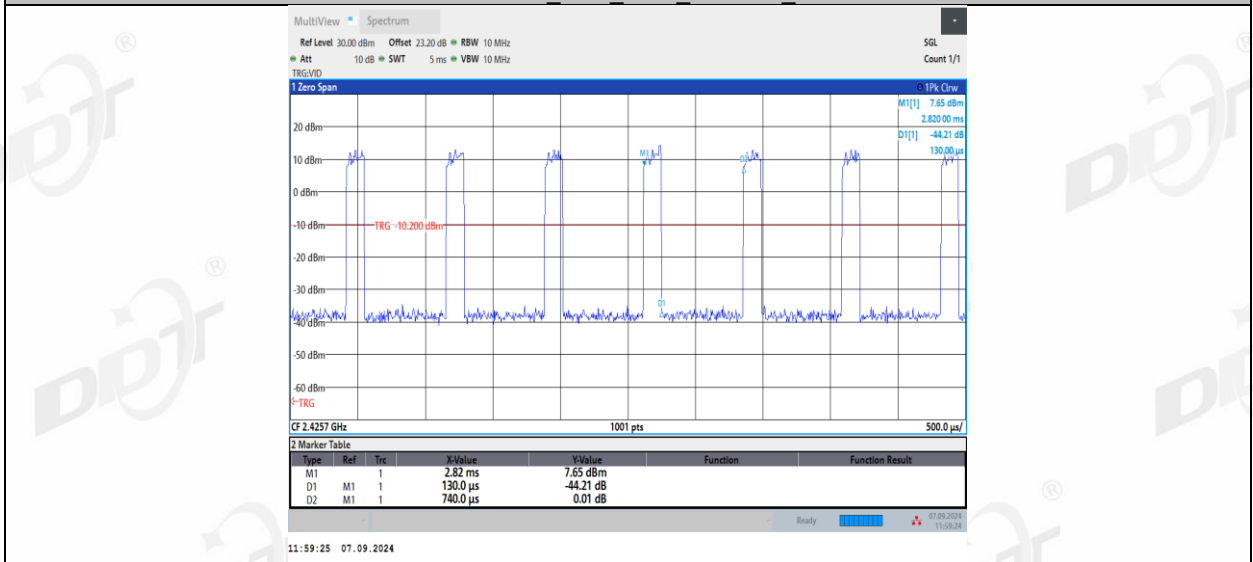

11AX40MIMO\_Ant2\_2422\_242Tone\_RU61

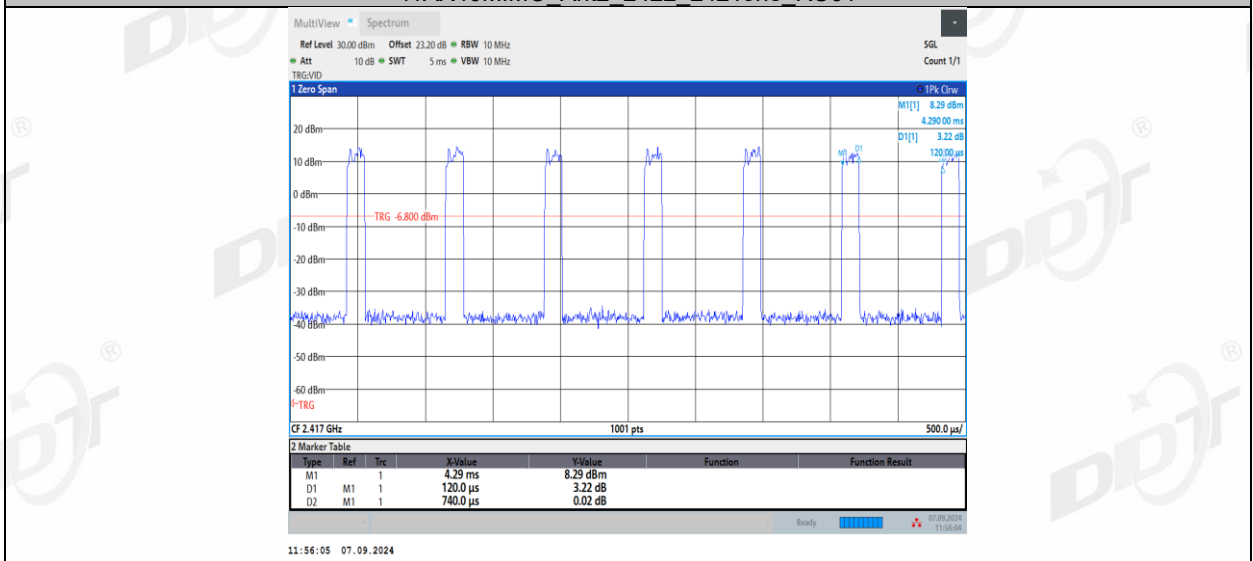

11AX40MIMO\_Ant2\_2422\_242Tone\_RU62

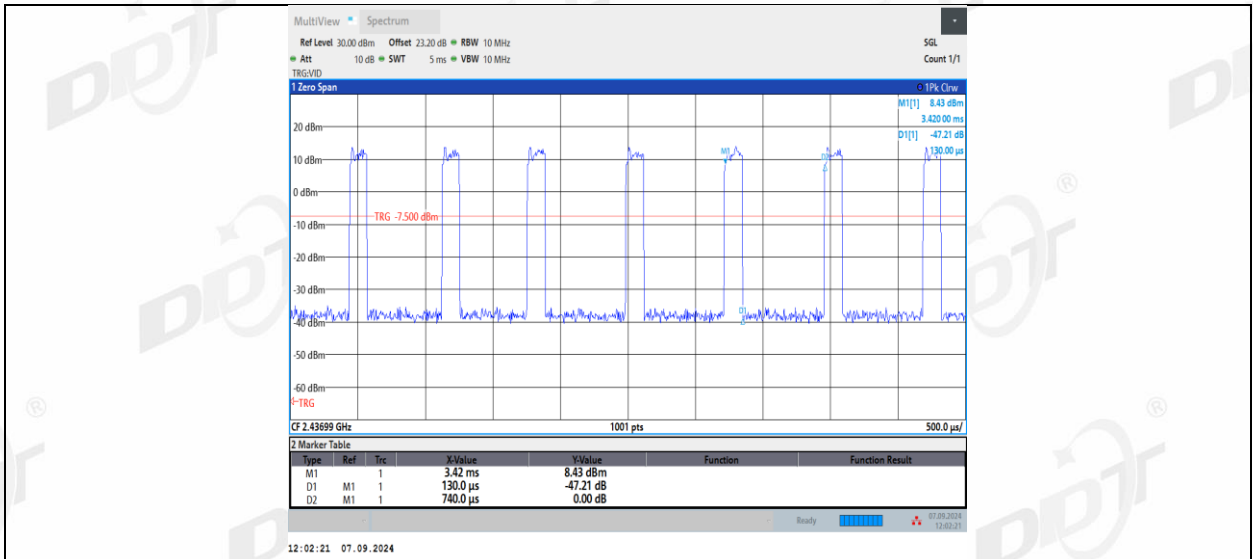

11AX40MIMO\_Ant1\_2437\_242Tone\_RU61

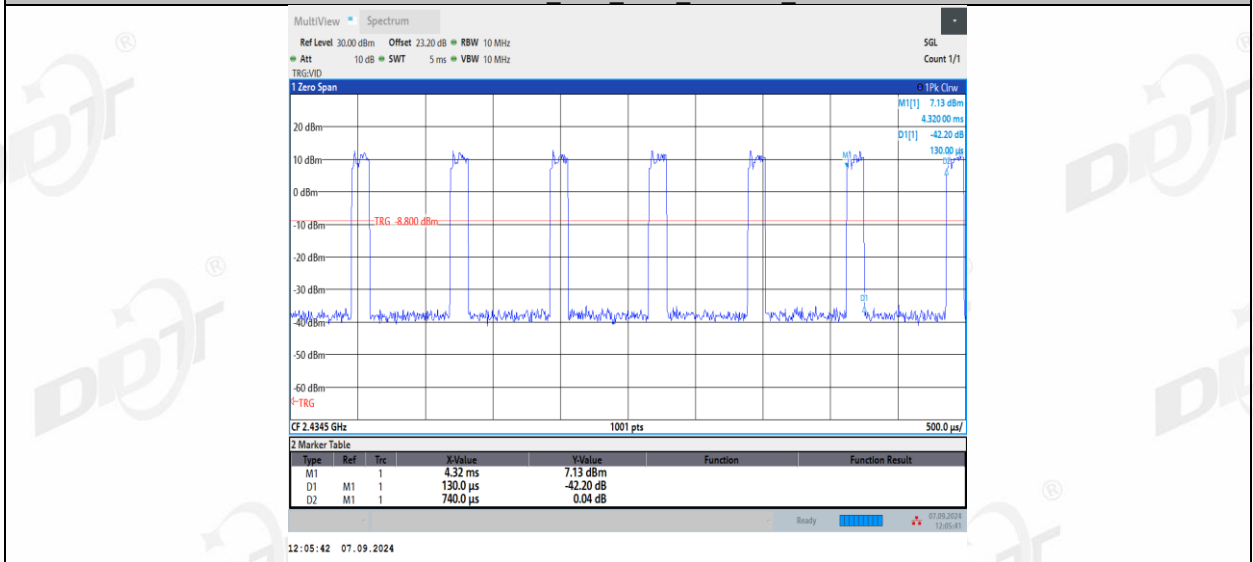

11AX40MIMO\_Ant1\_2437\_242Tone\_RU62

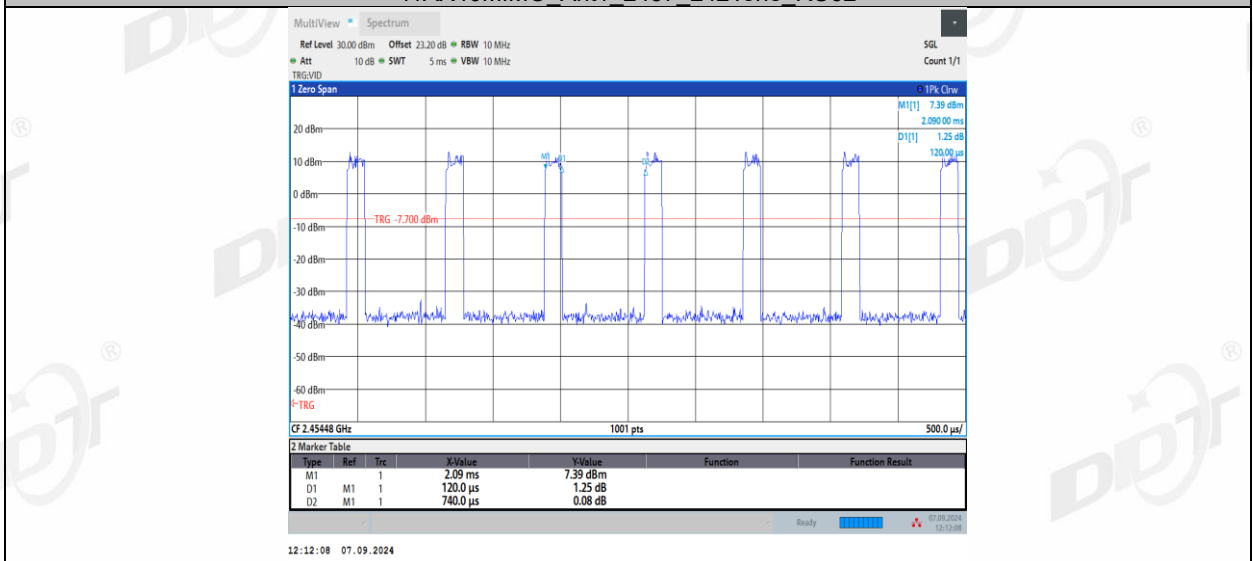

11AX40MIMO\_Ant2\_2437\_242Tone\_RU61

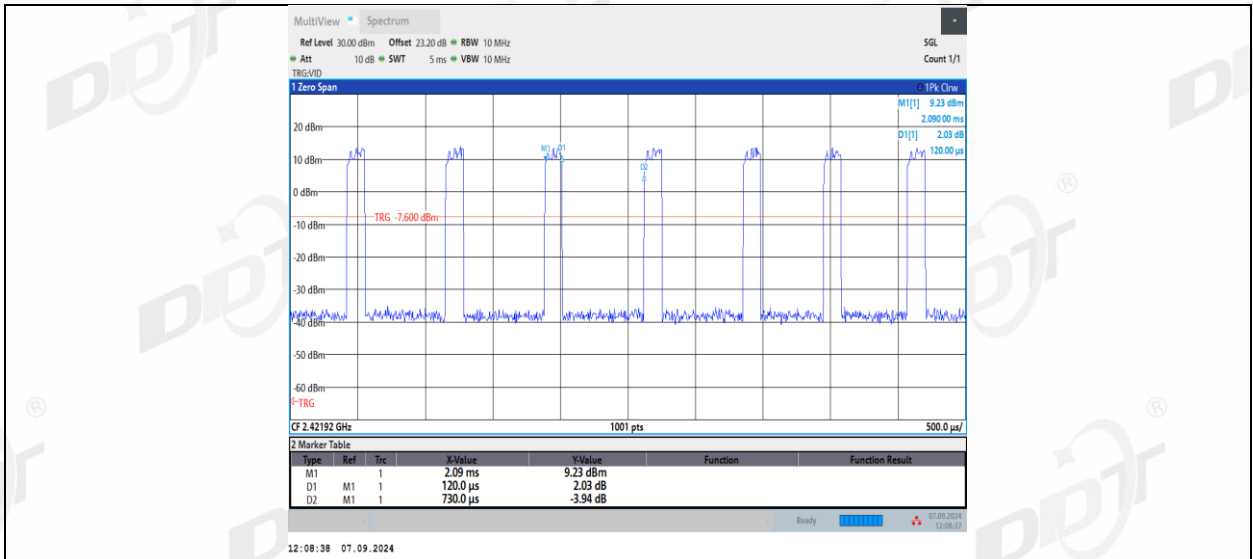

11AX40MIMO\_Ant2\_2437\_242Tone\_RU62

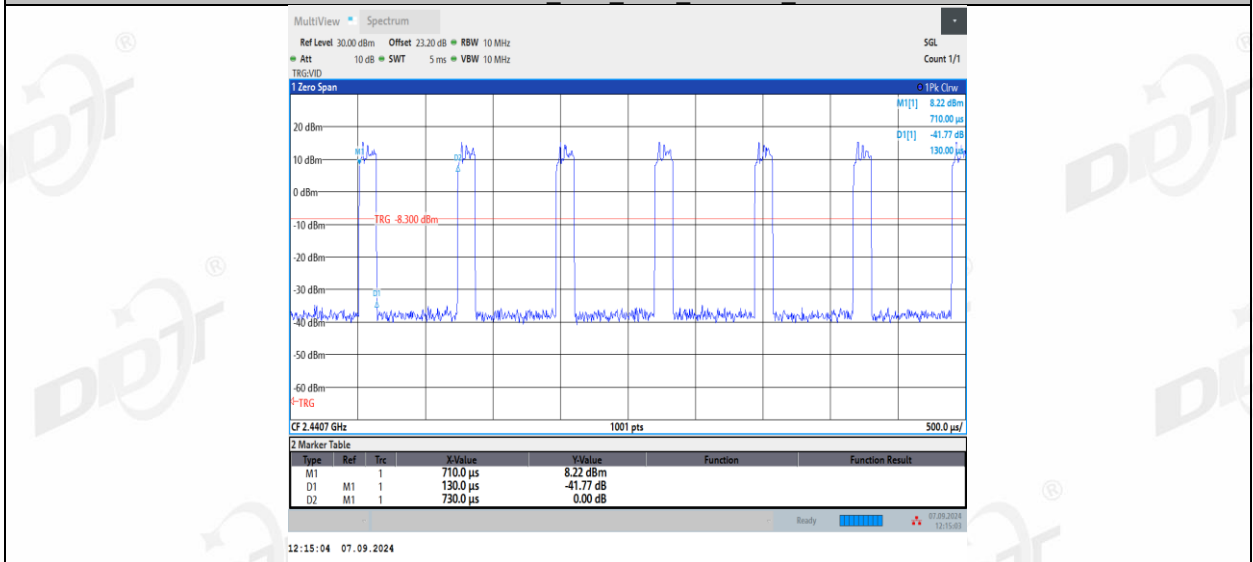

11AX40MIMO\_Ant1\_2452\_242Tone\_RU61

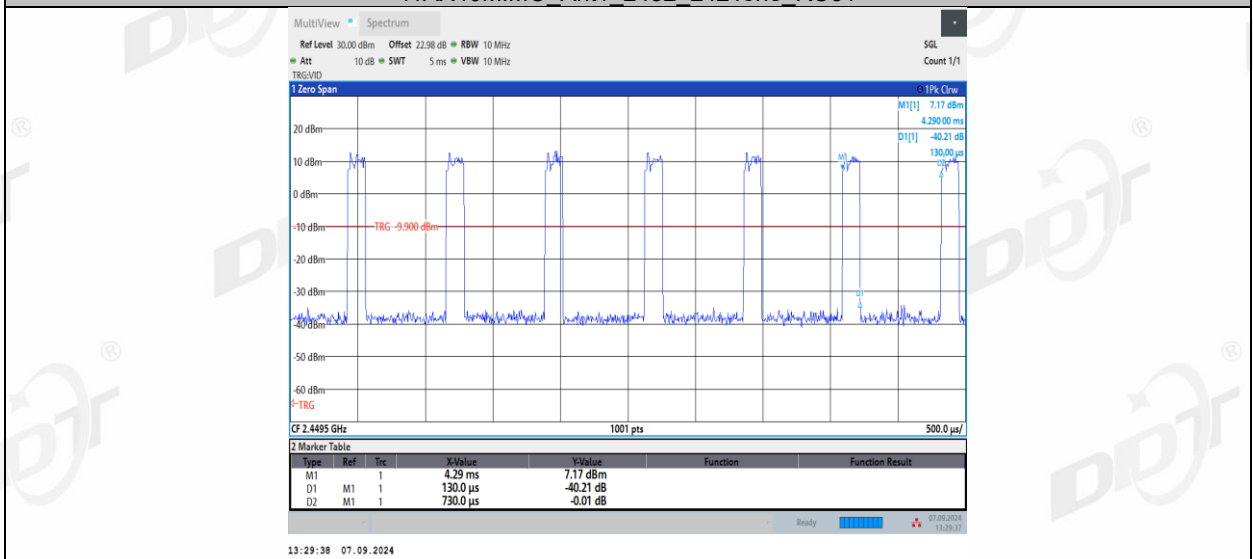

11AX40MIMO\_Ant1\_2452\_242Tone\_RU62

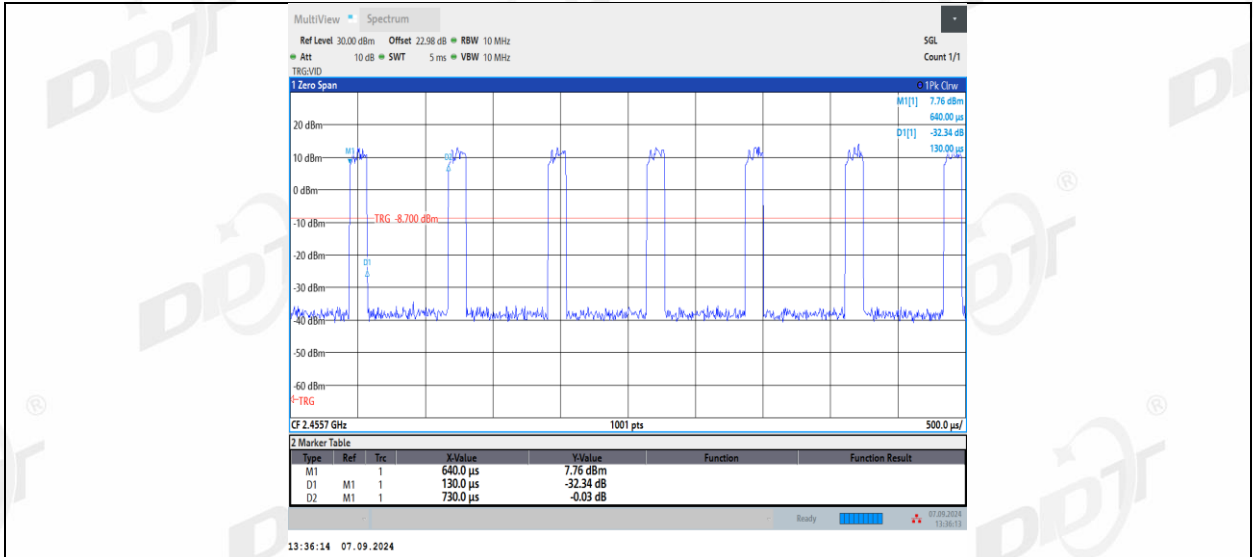

11AX40MIMO\_Ant2\_2452\_242Tone\_RU61

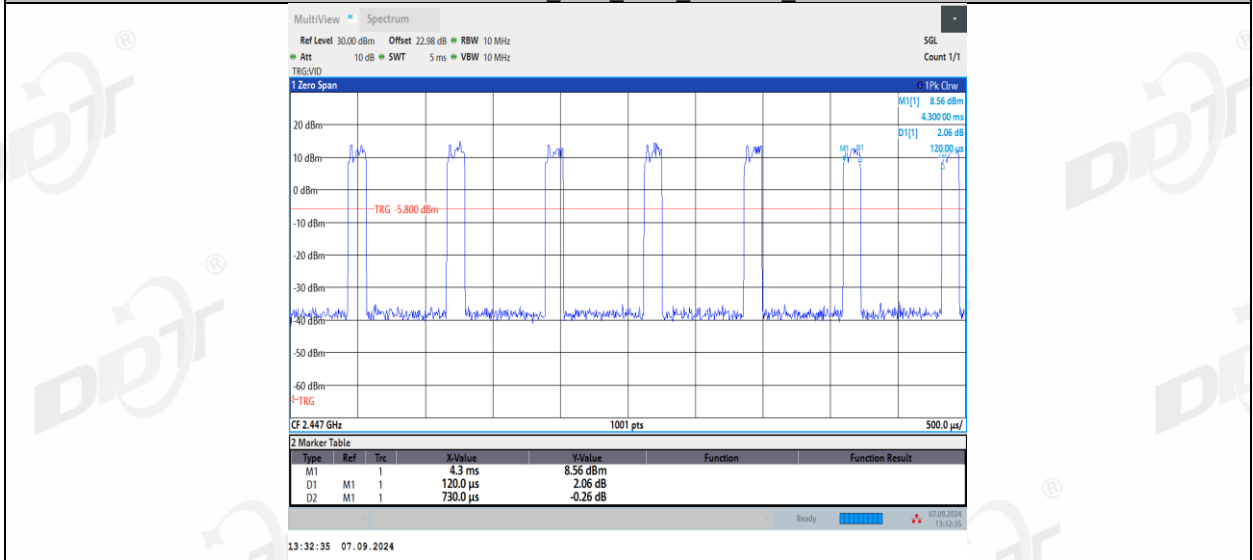

11AX40MIMO\_Ant2\_2452\_242Tone\_RU62

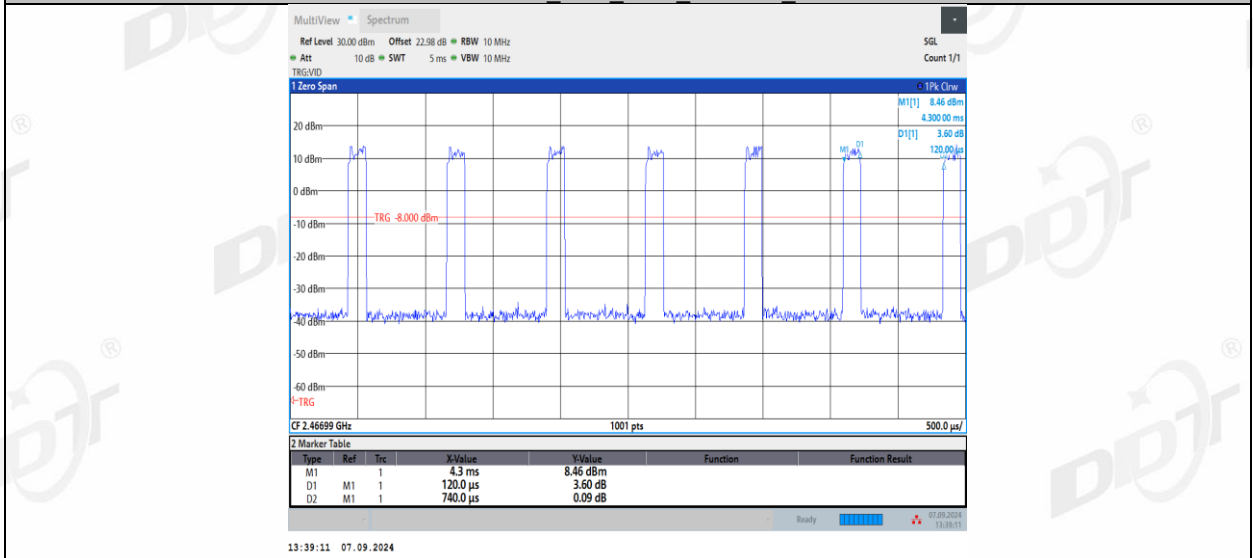



## 11. Antenna Requirements

### 11.1. Limit

For intentional device, according to FCC 47 CFR Section 15.203, an intentional radiator shall be designed to ensure that no antenna other than that furnished by the responsible party shall be used with the device. And according to FCC 47 CFR Section 15.247 (b), if transmitting antennas of directional gain greater than 6 dBi are used, the power shall be reduced by the amount in dB that the directional gain of the antenna exceeds 6 dBi.

For intentional device, according to RSS-Gen issue 5 section 6.8.

The applicant for equipment certification shall provide a list of all antenna types that may be used with the transmitter, where applicable (i.e. for transmitters with detachable antenna), indicating the maximum permissible antenna gain (in dBi) and the required impedance for each antenna. The test report shall demonstrate the compliance of the transmitter with the limit for maximum equivalent isotropically radiated power (e.i.r.p.) specified in the applicable RSS, when the transmitter is equipped with any antenna type, selected from this list.

### 11.2. Result

The antenna used for this product as Antenna information described in section 2.1 of the report, and there is no other antenna than that furnished by the responsible party shall be used with the device.

## 12.Radiated Emission

### 12.1. Test equipment

Equipment	Manufacturer	Model No.	Serial No.	Cal Due To
High pass filter	Micro-Tronics	HPM50102	DDT-ZC00561	2025/04/22
High Pass filter	Xi'an Xingbo	XBLBQ-GTA67	DDT-ZC02179	2025/04/22
RF cable	Zhongke Junchuang	JCT26S-NJ-NJ-1.5M	DDT-ZC02762	2025/03/31
Micro-Tronics filters	REBES	BRM50716	DDT-ZC03240	/
Trilog Broadband Antenna	Schwarzbeck	VULB 9163	DDT-ZC02050	2025/07/11
ELECTRIC AND MAGNETIC FIELD ANALYZER	Narda	EHP-200A	DDT-ZC01401	2025/08/28
Active Loop Antenna	Schwarzbeck	FMZB1519	DDT-ZC00524	2025/09/11
Pre-amplifier	COM-POWER	PAM-118A	DDT-ZC01293	2025/07/08
RF Cable	N/A	W13.02 AP1-X2	DDT-ZC04023	2025/03/31
RF cable	Yuhu Technology	JCTB810-NJ-NJ-9M	DDT-ZC02538	2025/03/31
High pass filter	Micro-Tronics	HPM50108	DDT-ZC00560	2025/04/22
Broad-Band Horn Antenna	Schwarzbeck	BBHA 9170	DDT-ZC00506	2025/04/26
PSA Series Spectrum Analyzer	Agilent	E4447A	DDT-ZC00517	2025/03/31
RF cable	Yuhu Technology	ZT26S-SMAJ-SMAJ-1M	DDT-ZC02037	2025/03/31
Micro-Tronics filters	REBES	BRM50702	DDT-ZC03242	/
EMI TEST RECEIVER	R&S	ESU26	DDT-ZC01909	2025/03/31
Hochgewinn-Hornantenne	SCHWARZBECK	BBHA 9120 D	DDT-ZC02129	2025/09/18
RF Cable	N/A	W24.02 HL-562	DDT-ZC04022	2025/03/31
Pre-amplifier	COM-POWER	PAM-840A	DDT-ZC01693	2025/03/31

### 12.2. Block diagram of test setup

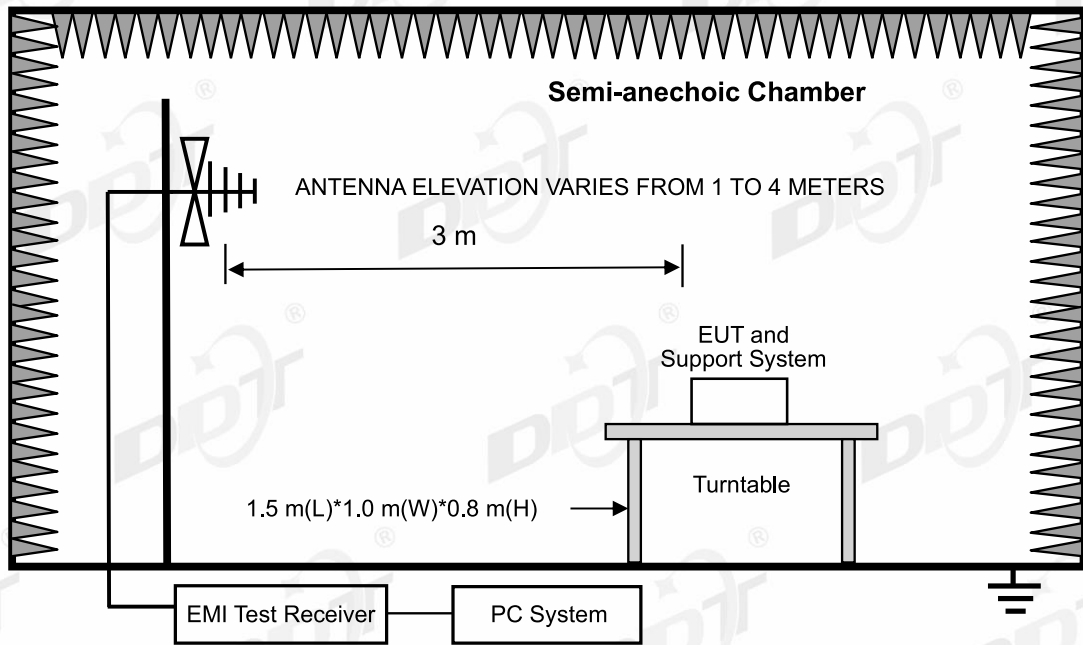
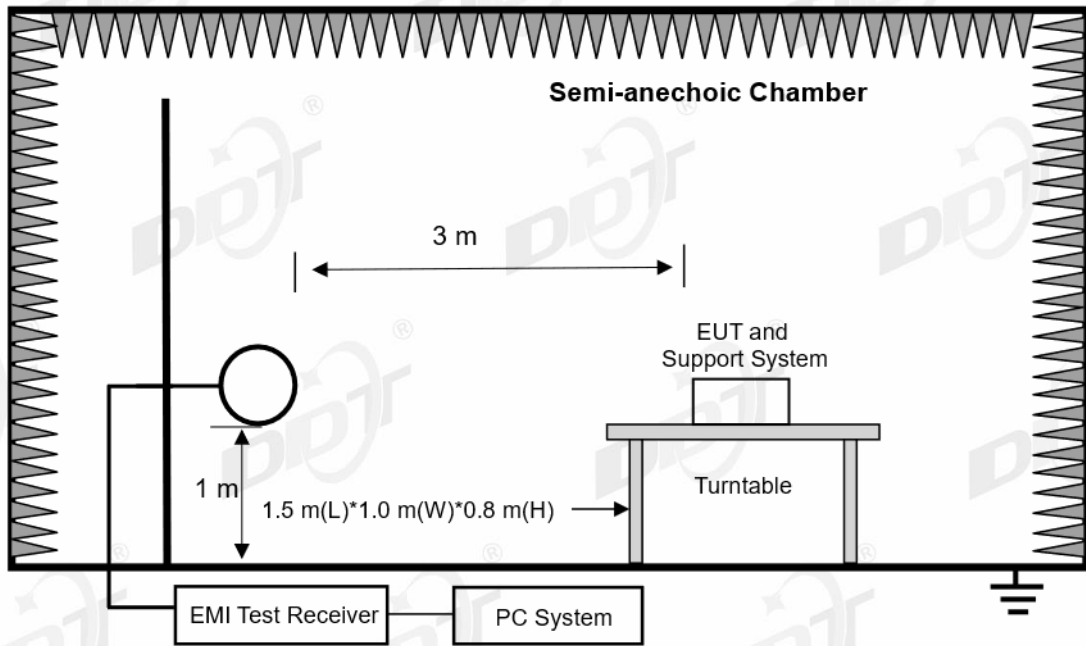

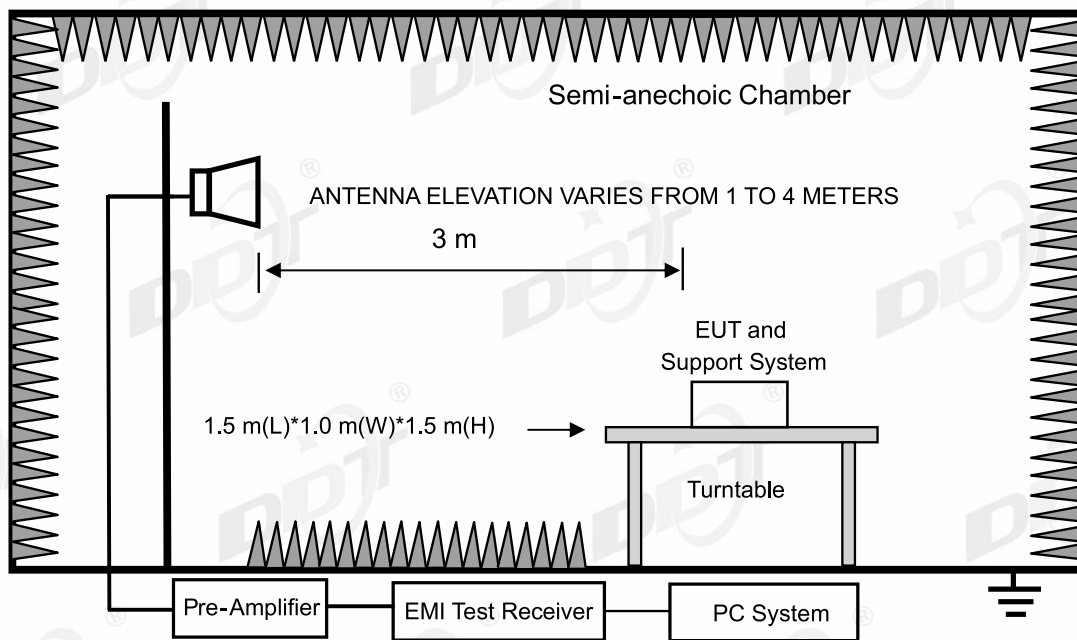

**12.3. Limits**

(1) FCC 15.205 Restricted frequency band

MHz	MHz	MHz	GHz
0.090-0.110	16.42-16.423	399.9-410	4.5-5.15
10.495-0.505	16.69475-16.69525	608-614	5.35-5.46
2.1735-2.1905	16.80425-16.80475	960-1240	7.25-7.75
4.125-4.128	25.5-25.67	1300-1427	8.025-8.5
4.1772&4.17775	37.5-38.25	1435-1626.5	9.0-9.2
4.2072&4.20775	73-74.6	1645.5-1646.5	9.3-9.5
6.215-6.218	74.8-75.2	1660-1710	10.6-12.7
6.26775-6.26825	108-121.94	1718.8-1722.2	13.25-13.4
6.31175-6.31225	123-138	2200-2300	14.47-14.5
8.291-8.294	149.9-150.05	2310-2390	15.35-16.2
8.362-8.366	156.52475-156.52525	2483.5-2500	17.7-21.4
8.37625-8.38675	156.7-156.9	2690-2900	22.01-23.12
8.41425-8.41475	162.0125-167.17	3260-3267	23.6-24.0
12.29-12.293	167.72-173.2	3332-3339	31.2-31.8
12.51975-12.52025	240-285	3345.8-3358	36.43-36.5
12.57675-12.57725	322-335.4	3600-4400	(2)
13.36-13.41			

1Until February 1, 1999, this restricted band shall be 0.490-0.510 MHz

2Above 38.6

RSS-Gen section 8.10 Restricted frequency bands\*

MHz	MHz	MHz	GHz
0.090-0.110	12.51975-12.52025	240-285	3.5-4.4
0.495-0.505	12.57675-12.57725	322-335.4	4.5-5.15
2.1735-2.1905	13.36-13.41	399.9-410	5.35-5.46
3.020-3.026	16.42-16.423	608-614	7.25-7.75
4.125-4.128	16.69475-16.69525	960-1427	8.025-8.5
4.1772&4.17775	16.80425-16.80475	1435-1626.5	9.0-9.2
4.2072&4.20775	25.5-25.67	1645.5-1646.5	9.3-9.5
5.677-5.683	37.5-38.25	1660-1710	10.6-12.7
6.215-6.218	73-74.6	1718.8-1722.2	13.25-13.4
6.26775-6.26825	74.8-75.2	2200-2300	14.47-14.5
6.31175-6.31225	108-138	2310-2390	15.35-16.2
8.291-8.294	149.9-150.05	2483.5-2500	17.7-21.4
8.362-8.366	156.52475-156.52525	2655-2900	22.01-23.12
8.37625-8.38675	156.7-156.9	3260-3267	23.6-24.0
8.41425-8.41475	162.0125-167.17	3332-3339	31.2-31.8
12.29-12.293	167.72-173.2	3345.8-3358	36.43-36.5
			Above 38.6

\* Certain frequency bands listed in table and in bands above 38.6 GHz are designated for licence-exempt applications. These frequency bands and the requirements that apply to related devices are set out in the 200 and 300 series of RSSs.

(2) FCC 15.209 Limit & RSS-Gen section 8.9 Limit

FREQUENCY MHz	DISTANCE Meters	FIELD STRENGTHS LIMIT	
		$\mu\text{V/m}$	$\text{dB}\mu\text{V/m}$
0.009 ~ 0.490	300	2400/F(kHz)	67.6-20log(F)
0.490 ~ 1.705	30	24000/F(kHz)	87.6-20log(F)
1.705 ~ 30.0	30	30	29.54
30 ~ 88	3	100	40.0
88 ~ 216	3	150	43.5
216 ~ 960	3	200	46.0
960 ~ 1000	3	500	54.0
Above 1000	3	74.0 $\text{dB}\mu\text{V/m}$ (Peak) 54.0 $\text{dB}\mu\text{V/m}$ (Average)	

Note:

(1) The emission limits shown in the above table are based on measurements employing a CISPR QP detector except for the frequency bands 9 - 90 kHz, 110 - 490 kHz and above 1000 MHz, radiated emissions limits in these three bands are based on measurements employing an average detector.

(2) At frequencies below 30 MHz, measurement may be performed at a distance closer than that specified, and the limit at closer measurement distance can be extrapolated by below formula:

$$\text{Limit}_{3\text{m}}(\text{dBuV/m}) = \text{Limit}_{30\text{m}}(\text{dBuV/m}) + 40\text{Log}(30\text{m}/3\text{m})$$

(3) Limit for this EUT

The emissions appearing within 15.205 restricted frequency bands shall not exceed the limits shown in 15.209, and the emissions appearing within RSS-Gen section 8.10 Restricted frequency bands shall not exceed the limits shown in RSS-Gen section 8.9, all the other emissions shall be at least 20 dB below the fundamental emissions or comply with 15.209 limits and RSS-Gen section 8.9 limits.

#### 12.4. Assistant equipment used for test

Assistant equipment	Manufacturer	Model number	Description	other
/	/	/	/	/

#### 12.5. Test procedure

- (1) EUT was placed on a non-metallic table, 80 cm above the ground plane inside a semi-anechoic chamber for below 1G and 150 cm above the ground plane inside a fully-anechoic chamber for above 1G.
- (2) Test antenna was located 3 m from the EUT on an adjustable mast, and the antenna used as below table.

Test frequency range	Test antenna used	Test antenna distance
9 kHz - 30 MHz	Active Loop antenna	3 m
30 MHz - 1 GHz	Trilog Broadband Antenna	3 m
1 GHz - 18 GHz	Double Ridged Horn Antenna(1 GHz-18 GHz)	3 m
18 GHz - 40 GHz	Horn Antenna(18 GHz-40 GHz)	1 m

According ANSI C63.10:2013 clause 6.4.6 and 6.5.3, for measurements below 30 MHz, Antenna was located 3 m from EUT, the loop antenna was positioned in three antenna orientations (parallel, perpendicular, and round-parallel), for each measurement antenna alignment, the EUT shall be rotated through 0° to 360° on a turntable, and the lowest height of the magnetic antenna shall be 1 m above the ground. For measurement above 30MHz, the trilog Broadband Antenna or Horn Antenna was located 3m from EUT, Measurements were made with the antenna positioned in both the horizontal and vertical planes of Polarization, and the measurement antenna was varied from 1 m to 4 m. in height above the reference ground plane to obtain the maximum signal strength.

- (3) Below pre-scan procedure was first performed in order to find prominent frequency spectrum radiated emissions from 9 kHz to 25 GHz:

- (a) Scanning the peak frequency spectrum with the antenna specified in step (3), and the EUT was rotated 360 degree, the antenna height was varied from 1 m to 4 m (Except loop antenna, it's fixed 1 m above ground.)

- (b) Change work frequency or channel of device if practicable.

- (c) Change modulation type of device if practicable.

- (d) Change power supply range from 85% to 115% of the rated supply voltage

- (e) Rotated EUT though three orthogonal axes to determine the attitude of EUT arrangement produces highest emissions.

Spectrum frequency from 9 kHz to 25 GHz (tenth harmonic of fundamental frequency) was investigated, and no any obvious emission were detected from 18 GHz to 25 GHz, so below final test was performed with frequency range from 9 kHz to 18 GHz.

(4) For final emissions measurements at each frequency of interest, the EUT was rotated and the antenna height was varied between 1 m and 4 m in order to maximize the emission. Measurements in both horizontal and vertical polarities were made and the data was recorded. In order to find the maximum emission, the relative positions of equipment and all of the interface cables were changed according to ANSI C63.10:2013 on Radiated Emission test.

(5) The emissions from 9 kHz to 1 GHz were measured based on CISPR QP detector except for the frequency bands 9 - 90 kHz, 110 - 490 kHz, for emissions from 9 kHz - 90 kHz, 110 kHz - 490 kHz and above 1 GHz were measured based on average detector, for emissions above 1 GHz, peak emissions also be measured and need comply with Peak limit.

(6) The emissions from 9 kHz to 1 GHz, QP or average values were measured with EMI receiver with below RBW.

Frequency band	RBW
9 kHz - 150 kHz	200 Hz
150 kHz - 30 MHz	9 kHz
30 MHz - 1 GHz	120 kHz

(7) For emissions above 1GHz, both Peak and Average level were measured with Spectrum Analyzer, and the RBW is set at 1 MHz, VBW is set at 3 MHz for Peak measure; According ANSI C63.10:2013 clause 4.1.4.2.2 procedure for average measure.

(8) According exploratory test, the emission levels are 20 dB below the limit detected from 9 kHz to 30 MHz and 18 GHz to 25 GHz, so the final test was performed with frequency range from 30 MHz to 18 GHz and recorded in below.

(9) 30 MHz ~ 25 GHz: (Scan with all mode, the worst case is record and report)

(10) For emissions below 1 GHz, according exploratory explorer test, when change Tx mode and channel, have no distinct influence on emissions level, so for emissions below 1 GHz, the final test was only performed with the worst mode.

(11) The worst simultaneous case and was recorded.

## 12.6. Test result

**PASS. (See below detailed test result)**



## 12.7. Test data

## TR-4-E-009 Radiated Emission Test Result

**Test Date:** 2024-08-27 **Tested By:** Zhong Nan  
**EUT:** Wireless Speaker **Model Number:** ENCHANT SPEAKER  
**Test Mode:** Tx mode **Power Supply:** AC 120V/60Hz  
**Condition:** Temp:23.5°C;Humi:65.2% **Test Site:** DDT 3# Chamber  
**File Path:** d:\ts\2024 report data\Q24081509-1E\FCC BELOW1G\20240827-034813\_H  
**Memo:** Sample Number: S24081509-003

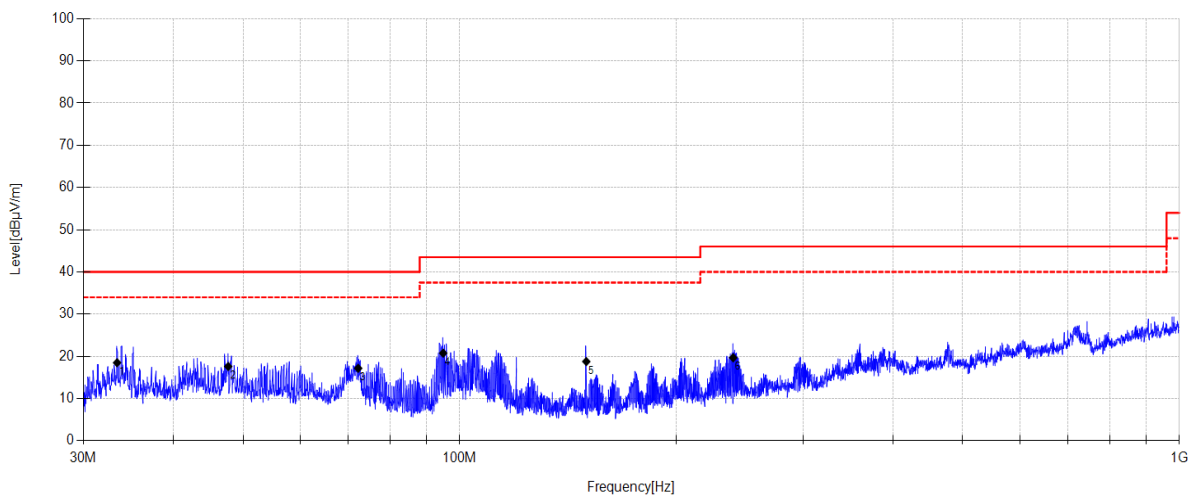

Data List									
NO.	Freq. [MHz]	Reading [dBμV/m]	Antenna Factor [dB]	Cable Loss [dB]	Result [dBμV/m]	Limit [dBμV/m]	Margin [dB]	Detector	Polarity
1	33.421	34.5	11.17	3.78	18.50	40.00	21.50	QP	Horizontal
2	47.688	32.09	12.38	3.87	17.61	40.00	22.39	QP	Horizontal
3	72.274	34.2	9.49	4.04	17.18	40.00	22.82	QP	Horizontal
4	94.871	36.93	10.45	4.18	20.76	43.50	22.74	QP	Horizontal
5	149.963	36.91	8.12	4.49	18.77	43.50	24.73	QP	Horizontal
6	239.888	33.43	11.79	4.94	19.68	46.00	26.32	QP	Horizontal

## Note:

1. Result Level = Reading + Cable loss + Antenna Factor + AMP
2. If Peak Result complies with QP limit, QP Result is deemed to comply with QP limit.
3. Test setup: RBW: 120 kHz, VBW: 300 kHz, Sweep time: auto.

## TR-4-E-009 Radiated Emission Test Result

**Test Date:** 2024-08-27 **Tested By:** Zhong Nan  
**EUT:** Wireless Speaker **Model Number:** ENCHANT SPEAKER  
**Test Mode:** Tx mode **Power Supply:** AC 120V/60Hz  
**Condition:** Temp:23.5°C;Humi:65.2% **Test Site:** DDT 3# Chamber  
**File Path:** d:\ts\2024 report data\Q24081509-1E\FCC BELOW1G\20240827-034829\_V  
**Memo:** Sample Number: S24081509-003

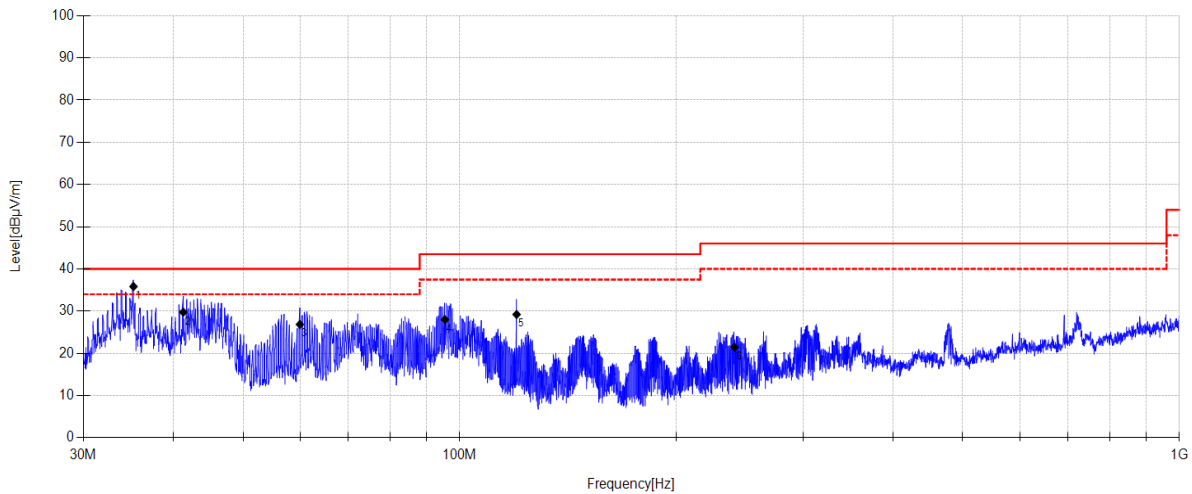

Data List									
NO.	Freq. [MHz]	Reading [dBμV/m]	Antenna Factor [dB]	Cable Loss [dB]	Result [dBμV/m]	Limit [dBμV/m]	Margin [dB]	Detector	Polarity
1	35.225	51.30	11.66	3.79	35.83	40.00	4.17	QP	Vertical
2	41.303	44.15	12.61	3.83	29.76	40.00	10.24	QP	Vertical
3	59.977	40.74	12.79	3.96	26.86	40.00	13.14	QP	Vertical
4	95.405	44	10.62	4.19	28.00	43.50	15.50	QP	Vertical
5	119.991	45.73	10.00	4.33	29.22	43.50	14.28	QP	Vertical
6	240.899	35.25	11.75	4.95	21.47	46.00	24.53	QP	Vertical

**Note:**

1. Result Level = Reading + Cable loss + Antenna Factor + AMP
2. If Peak Result complies with QP limit, QP Result is deemed to comply with QP limit.
3. Test setup: RBW: 120 kHz, VBW: 300 kHz, Sweep time: auto.

## TR-4-E-009 Radiated Emission Test Result

**Test Date:** 2024-08-27 **Tested By:** Zhong Nan  
**EUT:** Wireless Speaker **Model Number:** ENCHANT SPEAKER  
**Test Mode:** N20 TX 2412 MHz Mode **Power Supply:** AC 120V/60Hz  
**Condition:** Temp:23.5°C;Humi:65.2% **Test Site:** DDT 3# Chamber  
**File Path:** d:\ts\2024 report data\Q24081509-1E\FCC ABOVE1G 2.4GWIFI\9  
**Memo:** Sample Number: S24081509-003

### Test Graph

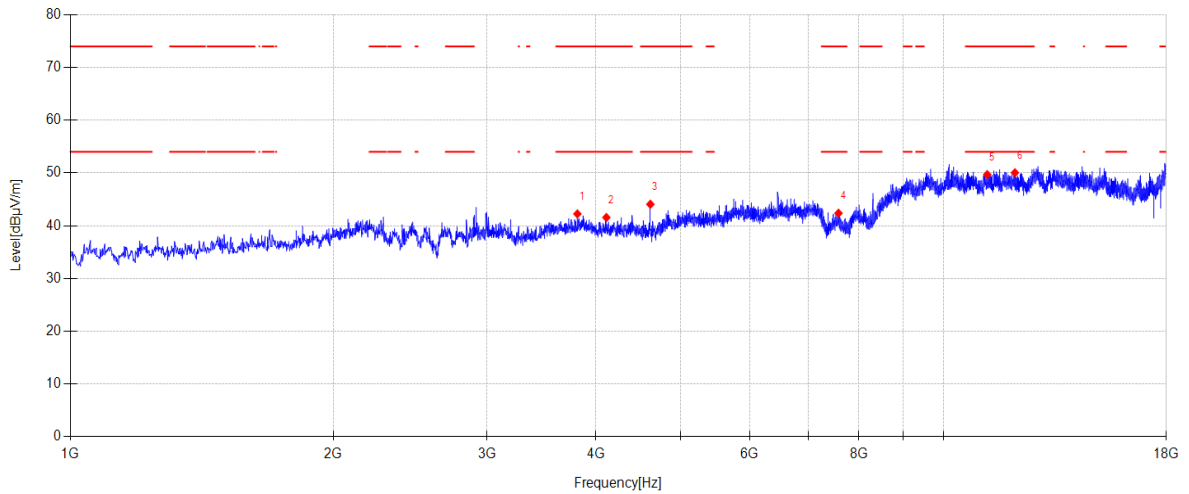

### Data List

NO	Freq. [MHz]	Reading [dBµV/m]	Antenna Factor [dB]	Cable loss [dB]	AMP [dB]	Level [dBµV/m]	Limit [dBµV/m]	Margin [dB]	Detector	Polarity
1	3808.400	46.76	30.73	5.08	-40.33	42.24	74.00	31.76	PK	Horizontal
2	4111.000	45.73	31.12	5.12	-40.41	41.56	74.00	32.44	PK	Horizontal
3	4615.900	46.94	31.93	5.42	-40.22	44.07	74.00	29.93	PK	Horizontal
4	7582.400	41.32	36.46	6.75	-42.16	42.37	74.00	31.63	PK	Horizontal
5	11223.800	41.42	39.20	8.27	-39.20	49.69	74.00	24.31	PK	Horizontal
6	12073.800	41.56	39.27	8.80	-39.59	50.04	74.00	23.96	PK	Horizontal

### Note:

- Level = Reading + Cable loss + Antenna Factor + AMP
- If Peak Result complies with AV limit, AV Result is deemed to comply with AV limit.
- Test setup: RBW: 1 MHz, VBW: 3 MHz, Sweep time: auto.

## TR-4-E-009 Radiated Emission Test Result

**Test Date:** 2024-08-27 **Tested By:** Zhong Nan  
**EUT:** Wireless Speaker **Model Number:** ENCHANT SPEAKER  
**Test Mode:** N20 TX 2412 MHz Mode **Power Supply:** AC 120V/60Hz  
**Condition:** Temp:23.5°C;Humi:65.2% **Test Site:** DDT 3# Chamber  
**File Path:** d:\ts\2024 report data\Q24081509-1E\FCC ABOVE1G 2.4GWIFI\10  
**Memo:** Sample Number: S24081509-003

### Test Graph

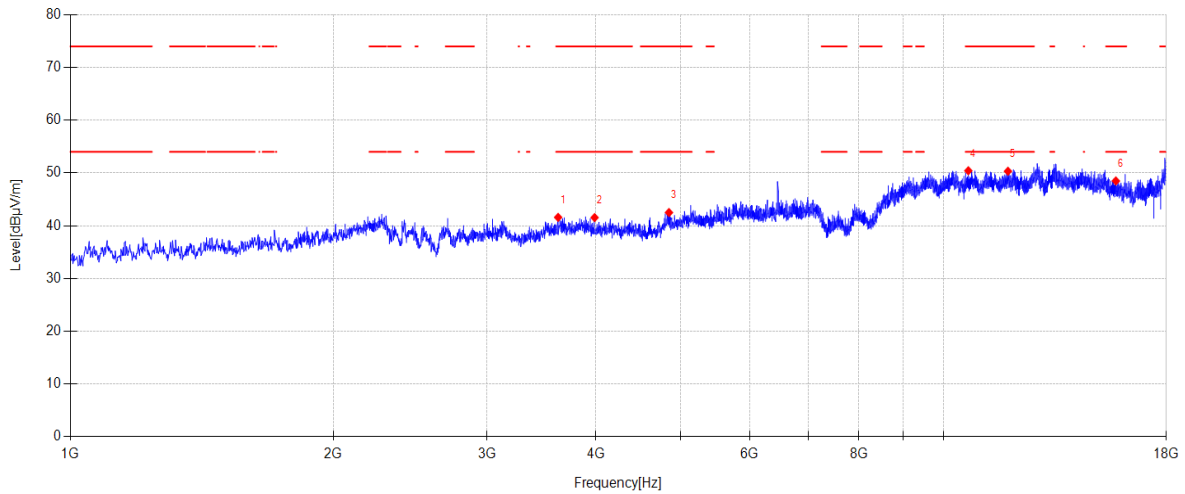

### Data List

NO	Freq. [MHz]	Reading [dBμV/m]	Antenna Factor [dB]	Cable loss [dB]	AMP [dB]	Level [dBμV/m]	Limit [dBμV/m]	Margin [dB]	Detector	Polarity
1	3619.700	46.62	30.08	5.11	-40.22	41.59	74.00	32.41	PK	Vertical
2	3985.200	45.98	30.96	5.05	-40.44	41.55	74.00	32.45	PK	Vertical
3	4848.800	43.31	33.77	5.56	-40.14	42.50	74.00	31.50	PK	Vertical
4	10678.100	42.06	39.36	7.97	-38.97	50.42	74.00	23.58	PK	Vertical
5	11854.500	42.25	38.90	8.67	-39.49	50.33	74.00	23.67	PK	Vertical
6	15757.700	39.33	38.38	9.99	-39.21	48.49	74.00	25.51	PK	Vertical

### Note:

- Level = Reading + Cable loss + Antenna Factor + AMP
- If Peak Result complies with AV limit, AV Result is deemed to comply with AV limit.
- Test setup: RBW: 1 MHz, VBW: 3 MHz, Sweep time: auto.

## TR-4-E-009 Radiated Emission Test Result

**Test Date:** 2024-09-11 **Tested By:** Zhong Nan  
**EUT:** Wireless Speaker **Model Number:** ENCHANT SPEAKER  
**Test Mode:** N20 TX 2437 MHz Mode **Power Supply:** AC 120V/60Hz  
**Condition:** Temp:23.5°C;Humi:65.2% **Test Site:** DDT 3# Chamber  
**File Path:** d:\ts\2024 report data\Q24081509-1E\FCC ABOVE1G bu1  
**Memo:** Sample Number: S24081509-003

### Test Graph

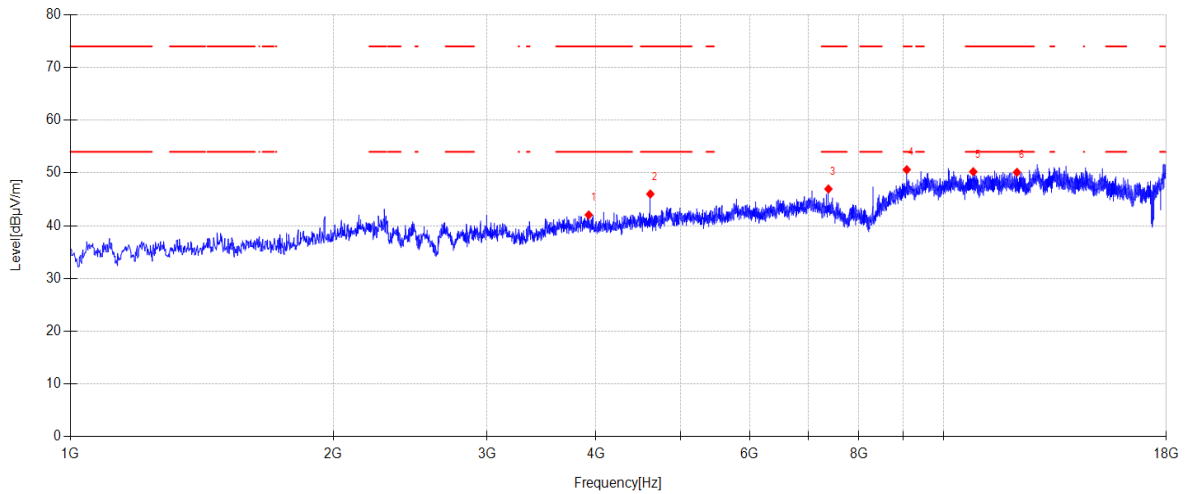

### Data List

NO	Freq. [MHz]	Reading [dBμV/m]	Antenna Factor [dB]	Cable loss [dB]	AMP [dB]	Level [dBμV/m]	Limit [dBμV/m]	Margin [dB]	Detector	Polarity
1	3924.000	46.24	31.15	5.06	-40.40	42.05	74.00	31.95	PK	Horizontal
2	4615.900	48.88	31.93	5.42	-40.22	46.01	74.00	27.99	PK	Horizontal
3	7383.500	45.25	36.73	6.64	-41.66	46.96	74.00	27.04	PK	Horizontal
4	9076.700	43.62	38.45	7.33	-38.78	50.62	74.00	23.38	PK	Horizontal
5	10817.500	41.84	39.38	8.04	-39.02	50.24	74.00	23.76	PK	Horizontal
6	12138.400	41.60	39.30	8.83	-39.61	50.12	74.00	23.88	PK	Horizontal

### Note:

- Level = Reading + Cable loss + Antenna Factor + AMP
- If Peak Result complies with AV limit, AV Result is deemed to comply with AV limit.
- Test setup: RBW: 1 MHz, VBW: 3 MHz, Sweep time: auto.

## TR-4-E-009 Radiated Emission Test Result

**Test Date:** 2024-09-11 **Tested By:** Zhong Nan  
**EUT:** Wireless Speaker **Model Number:** ENCHANT SPEAKER  
**Test Mode:** N20 TX 2437 MHz Mode **Power Supply:** AC 120V/60Hz  
**Condition:** Temp:23.5°C;Humi:65.2% **Test Site:** DDT 3# Chamber  
**File Path:** d:\ts\2024 report data\Q24081509-1E\FCC ABOVE1G bu\2  
**Memo:** Sample Number: S24081509-003

### Test Graph

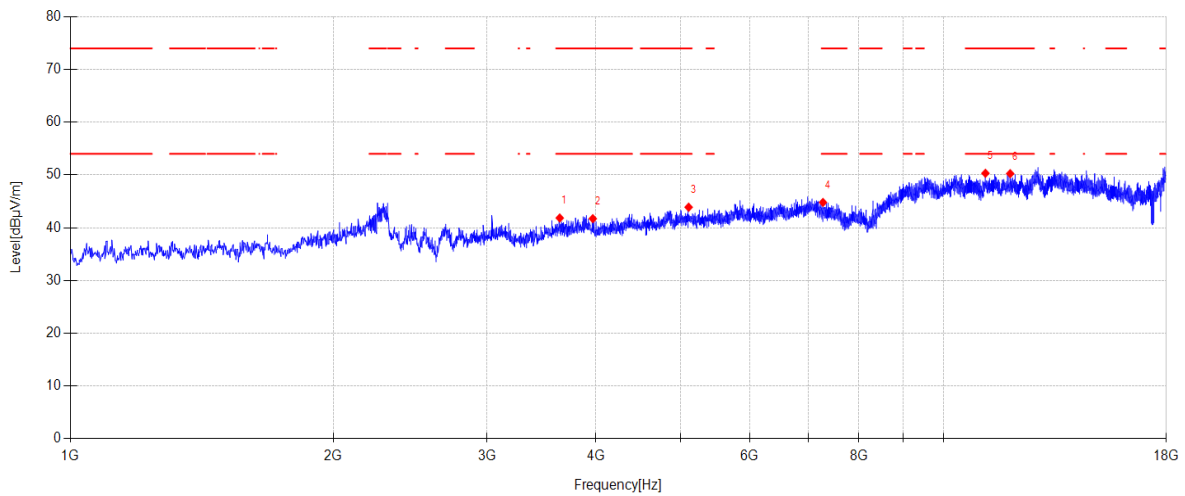

### Data List

NO	Freq. [MHz]	Reading [dBμV/m]	Antenna Factor [dB]	Cable loss [dB]	AMP [dB]	Level [dBμV/m]	Limit [dBμV/m]	Margin [dB]	Detector	Polarity
1	3635.000	46.83	30.14	5.11	-40.23	41.85	74.00	32.15	PK	Vertical
2	3966.500	46.06	31.03	5.06	-40.43	41.72	74.00	32.28	PK	Vertical
3	5107.200	44.85	33.40	5.71	-40.07	43.89	74.00	30.11	PK	Vertical
4	7278.100	42.75	36.86	6.59	-41.40	44.80	74.00	29.20	PK	Vertical
5	11171.100	42.02	39.23	8.24	-39.17	50.32	74.00	23.68	PK	Vertical
6	11924.200	42.09	38.97	8.71	-39.52	50.25	74.00	23.75	PK	Vertical

### Note:

- Level = Reading + Cable loss + Antenna Factor + AMP
- If Peak Result complies with AV limit, AV Result is deemed to comply with AV limit.
- Test setup: RBW: 1 MHz, VBW: 3 MHz, Sweep time: auto.



## TR-4-E-009 Radiated Emission Test Result

**Test Date:** 2024-08-27 **Tested By:** Zhong Nan  
**EUT:** Wireless Speaker **Model Number:** ENCHANT SPEAKER  
**Test Mode:** N20 TX 2462 MHz Mode **Power Supply:** AC 120V/60Hz  
**Condition:** Temp:23.5°C;Humi:65.2% **Test Site:** DDT 3# Chamber  
**File Path:** d:\ts\2024 report data\Q24081509-1\FCC ABOVE1G 2.4GWIFI\11  
**Memo:** Sample Number: S24081509-003

### Test Graph

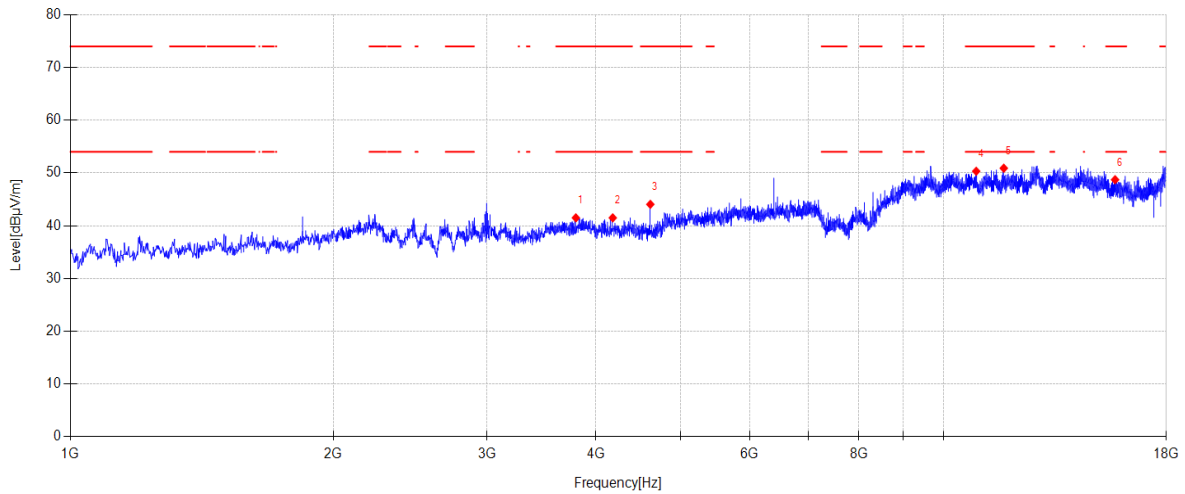

### Data List

NO	Freq. [MHz]	Reading [dBμV/m]	Antenna Factor [dB]	Cable loss [dB]	AMP [dB]	Level [dBμV/m]	Limit [dBμV/m]	Margin [dB]	Detector	Polarity
1	3793.100	46.06	30.67	5.09	-40.32	41.50	74.00	32.50	PK	Horizontal
2	4180.700	45.52	31.20	5.16	-40.38	41.50	74.00	32.50	PK	Horizontal
3	4615.900	46.92	31.93	5.42	-40.22	44.05	74.00	29.95	PK	Horizontal
4	10902.500	42.00	39.30	8.08	-39.05	50.33	74.00	23.67	PK	Horizontal
5	11725.300	42.77	38.97	8.59	-39.43	50.90	74.00	23.10	PK	Horizontal
6	15723.700	39.50	38.45	9.96	-39.19	48.72	74.00	25.28	PK	Horizontal

### Note:

- Level = Reading + Cable loss + Antenna Factor + AMP
- If Peak Result complies with AV limit, AV Result is deemed to comply with AV limit.
- Test setup: RBW: 1 MHz, VBW: 3 MHz, Sweep time: auto.



# TR-4-E-009 Radiated Emission Test Result

**Test Date:** 2024-08-27      **Tested By:** Zhong Nan  
**EUT:** Wireless Speaker      **Model Number:** ENCHANT SPEAKER  
**Test Mode:** N20 TX 2462 MHz Mode      **Power Supply:** AC 120V/60Hz  
**Condition:** Temp:23.5°C;Humi:65.2%      **Test Site:** DDT 3# Chamber  
**File Path:** d:\ts\2024 report data\Q24081509-1\FCC ABOVE1G 2.4GWIFI\12  
**Memo:** Sample Number: S24081509-003

## Test Graph

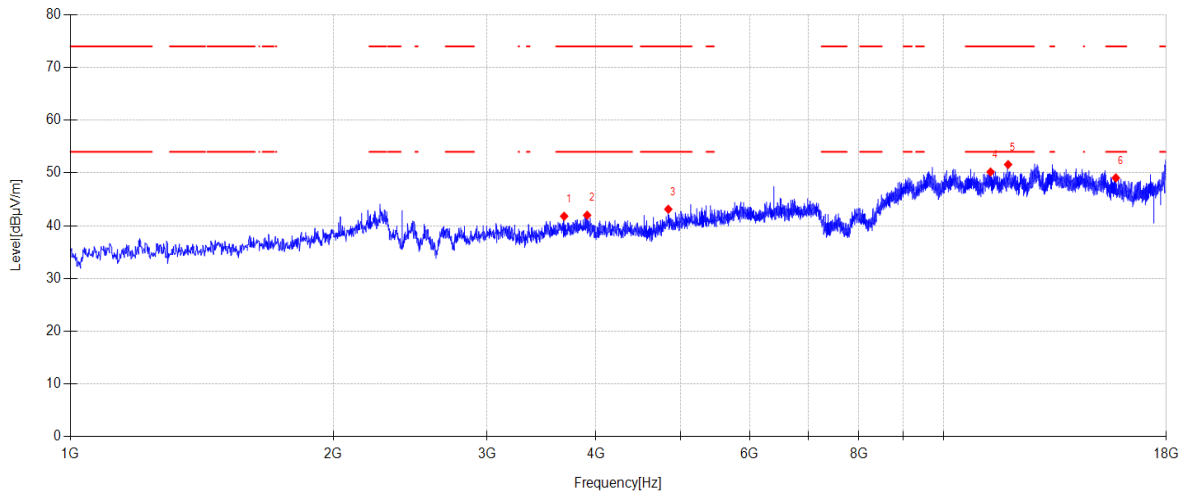

Data List										
NO	Freq. [MHz]	Reading [dBµV/m]	Antenna Factor [dB]	Cable loss [dB]	AMP [dB]	Level [dBµV/m]	Limit [dBµV/m]	Margin [dB]	Detector	Polarity
1	3677.500	46.64	30.31	5.10	-40.25	41.80	74.00	32.20	PK	Vertical
2	3907.000	46.12	31.19	5.07	-40.39	41.99	74.00	32.01	PK	Vertical
3	4840.300	44.16	33.55	5.55	-40.14	43.12	74.00	30.88	PK	Vertical
4	11322.400	41.87	39.22	8.33	-39.24	50.18	74.00	23.82	PK	Vertical
5	11857.900	43.52	38.90	8.67	-39.49	51.60	74.00	22.40	PK	Vertical
6	15754.300	39.89	38.39	9.99	-39.21	49.06	74.00	24.94	PK	Vertical

**Note:**

1. Level = Reading + Cable loss + Antenna Factor + AMP
2. If Peak Result complies with AV limit, AV Result is deemed to comply with AV limit.
3. Test setup: RBW: 1 MHz, VBW: 3 MHz, Sweep time: auto.

## 13. Band Edge Compliance

### 13.1. Test equipment

Equipment	Manufacturer	Model No.	Serial No.	Cal Due To
PSA Series Spectrum Analyzer	Agilent	E4447A	DDT-ZC00517	2025/03/31
Micro-Tronics filters	REBES	BRM50716	DDT-ZC03240	/
Hochgewinn-Hornantenne	SCHWARZBEC K	BBHA 9120 D	DDT-ZC02129	2025/09/18
Micro-Tronics filters	REBES	BRM50702	DDT-ZC03242	/
Broad-Band Horn Antenna	Schwarzbeck	BBHA 9170	DDT-ZC00506	2025/04/26
RF Cable	N/A	W13.02 AP1-X2	DDT-ZC04023	2025/03/31
Pre-amplifier	COM-POWER	PAM-118A	DDT-ZC01293	2025/07/08
High Pass filter	Xi'an Xingbo	XBLBQ-GTA67	DDT-ZC02179	2025/04/22
RF Cable	N/A	W24.02 HL-562	DDT-ZC04022	2025/03/31
RF cable	Yuhu Technology	JCTB810-NJ-NJ-9M	DDT-ZC02538	2025/03/31
ELECTRIC AND MAGNETIC FIELD ANALYZER	Narda	EHP-200A	DDT-ZC01401	2025/08/28
High pass filter	Micro-Tronics	HPM50102	DDT-ZC00561	2025/04/22
High pass filter	Micro-Tronics	HPM50108	DDT-ZC00560	2025/04/22
Pre-amplifier	COM-POWER	PAM-840A	DDT-ZC01693	2025/03/31
EMI TEST RECEIVER	R&S	ESU26	DDT-ZC01909	2025/03/31
RF cable	Yuhu Technology	ZT26S-SMAJ-SMAJ-1M	DDT-ZC02037	2025/03/31
RF cable	Zhongke Junchuang	JCT26S-NJ-NJ-1.5M	DDT-ZC02762	2025/03/31
Trilog Broadband Antenna	Schwarzbeck	VULB 9163	DDT-ZC02050	2025/07/11
Active Loop Antenna	Schwarzbeck	FMZB1519	DDT-ZC00524	2025/09/11

**13.2. Block diagram of test setup**

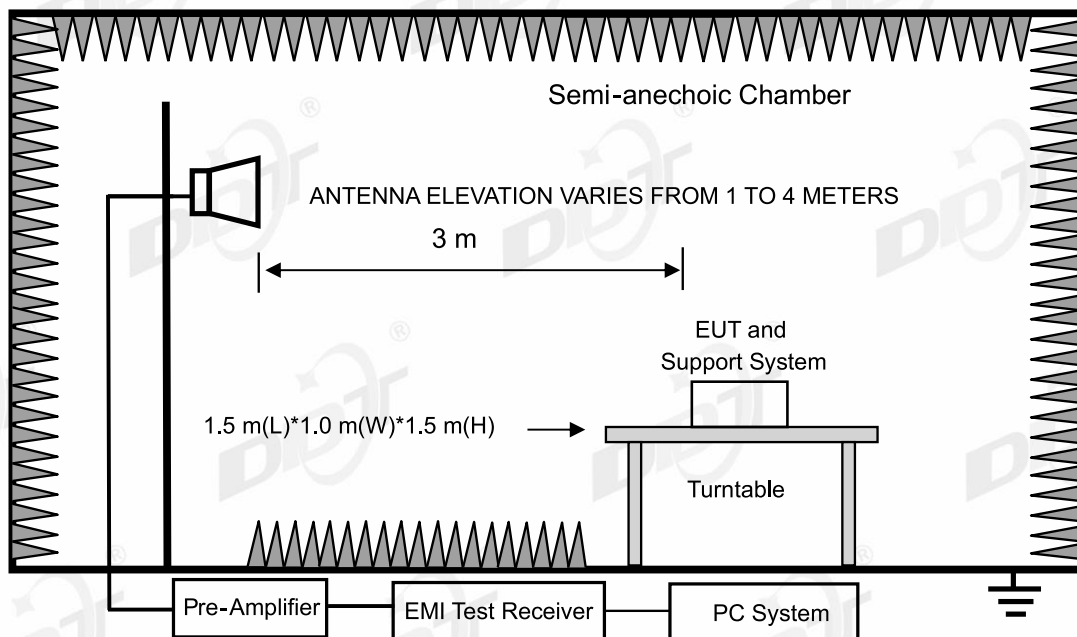

**13.3. Limits**

All restriction band should comply with 15.209 and RSS-Gen section 8.9 limits, other emission should be at least 20 dB below the fundamental.

**13.4. Assistant equipment used for test**

Assistant equipment	Manufacturer	Model number	Description	other
/	/	/	/	/

**13.5. Test procedure**

Same with Radiated Emission except change investigated frequency range.

Remark: All restriction band have been tested, and only the worst case is shown in report.

**13.6. Test result**

**PASS. (See below detailed test result)**

## 13.7. Test data

## TR-4-E-009 Radiated Emission Test Result

**Test Date:** 2024-10-26 **Tested By:** Zhong Nan  
**EUT:** Wireless Speaker **Model Number:** ENCHANT SPEAKER  
**Test Mode:** ANT1 11B TX 2412 MHz Mode **Power Supply:** AC 120V/60Hz  
**Condition:** Temp:23.5°C;Humi:65.2% **Test Site:** DDT 3# Chamber  
**File Path:** d:\ts\2024 report data\Q24081509-1E\1025\85  
**Memo:** Sample Number: S24081509-003

## Test Graph

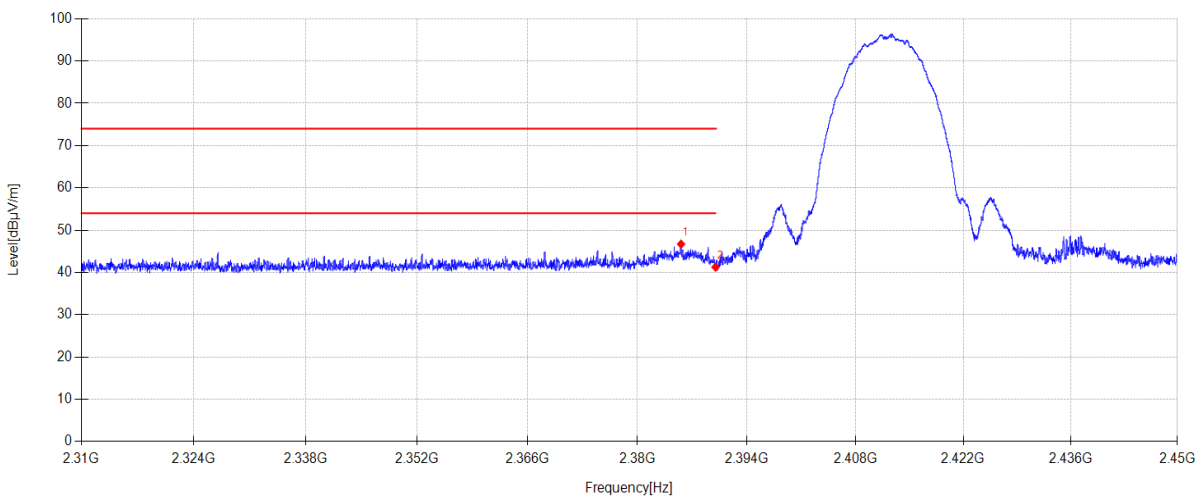

## Data List

N O.	Freq. [MHz]	Reading [dBμV/m]	Antenna Factor [dB]	Cable loss [dB]	AMP [dB]	Level [dBμV/m]	Limit [dBμV/m]	Margin [dB]	Detector	Polarity
1	2385.586	15.89	27.24	3.57	0.00	46.70	74.00	27.30	PK	Horizontal
2	2390.000	10.43	27.26	3.57	0.00	41.26	74.00	32.74	PK	Horizontal

## Note:

1. Level = Reading + Cable loss + Antenna Factor + AMP
2. If Peak Result complies with AV limit, AV Result is deemed to comply with AV limit.
3. Test setup: RBW: 1 MHz, VBW: 3 MHz, Sweep time: auto.

## TR-4-E-009 Radiated Emission Test Result

**Test Date:** 2024-10-26 **Tested By:** Zhong Nan  
**EUT:** Wireless Speaker **Model Number:** ENCHANT SPEAKER  
**Test Mode:** ANT1 11B TX 2412 MHz Mode **Power Supply:** AC 120V/60Hz  
**Condition:** Temp:23.5°C;Humi:65.2% **Test Site:** DDT 3# Chamber  
**File Path:** d:\ts\2024 report data\Q24081509-1E\1025\86  
**Memo:** Sample Number: S24081509-003

### Test Graph

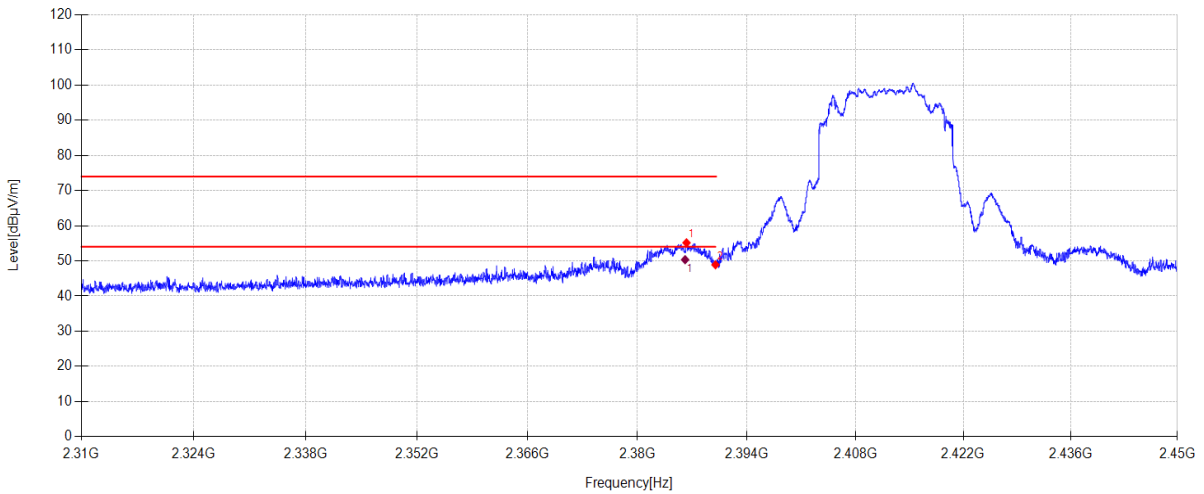

### Data List

N O.	Freq. [MHz]	Reading [dBµV/m]	Antenna Factor [dB]	Cable loss [dB]	AMP [dB]	Level [dBµV/m]	Limit [dBµV/m]	Margin [dB]	Detector	Polarity
1	2386.286	24.33	27.25	3.57	0.00	55.15	74.00	18.85	PK	Vertical
2	2390.000	18.07	27.26	3.57	0.00	48.90	74.00	25.10	PK	Vertical

### Data List

N O.	Freq. [MHz]	Reading [dBµV/m]	Antenna Factor [dB]	Cable loss [dB]	Level [dBµV/m]	Limit [dBµV/m]	Margin [dB]	Detector	Polarity
1	2386.104	19.53	27.25	3.57	50.35	54.00	3.65	AV	Vertical

#### Note:

- Level = Reading + Cable loss + Antenna Factor + AMP
- If Peak Result complies with AV limit, AV Result is deemed to comply with AV limit.
- Test setup: RBW: 1 MHz, VBW: 3 MHz, Sweep time: auto.

## TR-4-E-009 Radiated Emission Test Result

**Test Date:** 2024-10-26 **Tested By:** Zhong Nan  
**EUT:** Wireless Speaker **Model Number:** ENCHANT SPEAKER  
**Test Mode:** ANT2 11B TX 2412 MHz Mode **Power Supply:** AC 120V/60Hz  
**Condition:** Temp:23.5°C;Humi:65.2% **Test Site:** DDT 3# Chamber  
**File Path:** d:\ts\2024 report data\Q24081509-1E\1025\87  
**Memo:** Sample Number: S24081509-003

### Test Graph

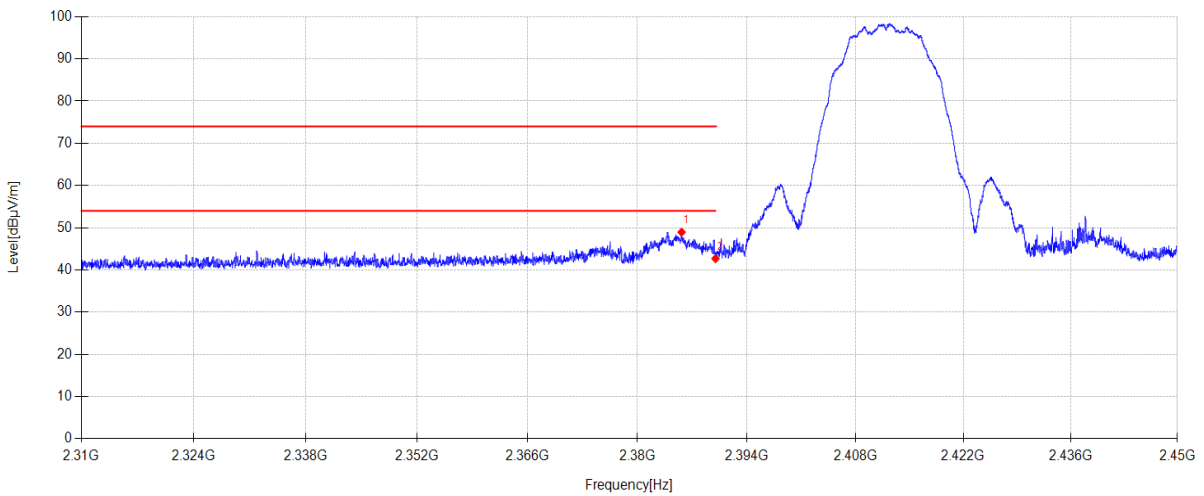

### Data List

N O.	Freq. [MHz]	Reading [dBμV/m]	Antenna Factor [dB]	Cable loss [dB]	AMP [dB]	Level [dBμV/m]	Limit [dBμV/m]	Margin [dB]	Detector	Polarity
1	2385.656	18.14	27.24	3.57	0.00	48.95	74.00	25.05	PK	Horizontal
2	2390.000	11.86	27.26	3.57	0.00	42.69	74.00	31.31	PK	Horizontal

### Note:

- Level = Reading + Cable loss + Antenna Factor + AMP
- If Peak Result complies with AV limit, AV Result is deemed to comply with AV limit.
- Test setup: RBW: 1 MHz, VBW: 3 MHz, Sweep time: auto.

# TR-4-E-009 Radiated Emission Test Result

**Test Date:** 2024-10-26      **Tested By:** Zhong Nan  
**EUT:** Wireless Speaker      **Model Number:** ENCHANT SPEAKER  
**Test Mode:** ANT2 11B TX 2412 MHz Mode      **Power Supply:** AC 120V/60Hz  
**Condition:** Temp:23.5°C;Humi:65.2%      **Test Site:** DDT 3# Chamber  
**File Path:** d:\ts\2024 report data\Q24081509-1E\1025\88  
**Memo:** Sample Number: S24081509-003

## Test Graph

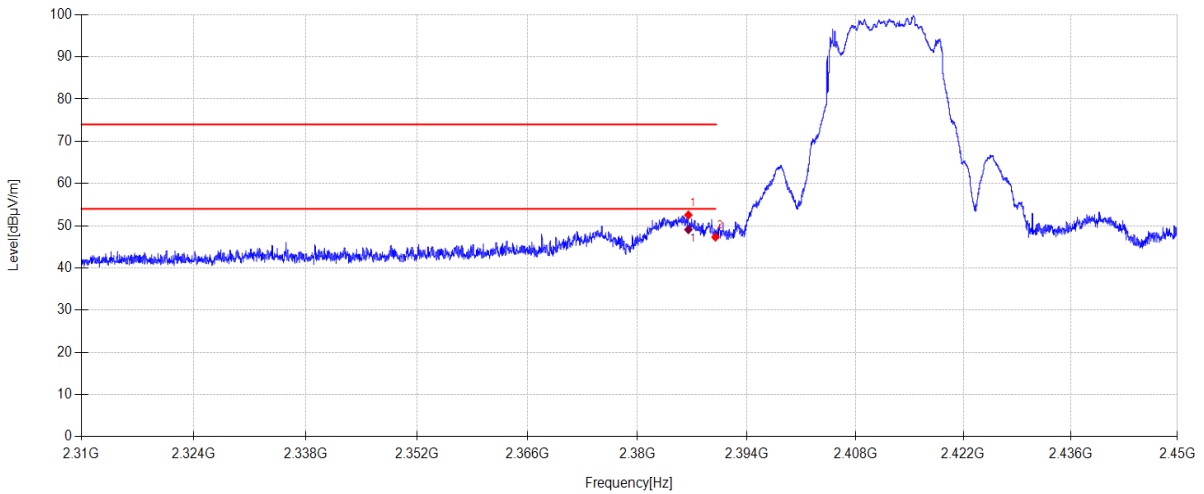

Data List										
N O.	Freq. [MHz]	Reading [dBµV/m]	Antenna Factor [dB]	Cable loss [dB]	AMP [dB]	Level [dBµV/m]	Limit [dBµV/m]	Margin [dB]	Detector	Polarity
1	2386.524	21.72	27.25	3.57	0.00	52.54	74.00	21.46	PK	Vertical
2	2390.000	16.49	27.26	3.57	0.00	47.32	74.00	26.68	PK	Vertical

Data List										
N O.	Freq. [MHz]	Reading [dBµV/m]	Antenna Factor [dB]	Cable loss [dB]	Level [dBµV/m]	Limit [dBµV/m]	Margin [dB]	Detector	Polarity	
1	2386.524	18.26	27.25	3.57	49.08	54.00	4.92	AV	Vertical	

**Note:**

1. Level = Reading + Cable loss + Antenna Factor + AMP
2. If Peak Result complies with AV limit, AV Result is deemed to comply with AV limit.
3. Test setup: RBW: 1 MHz, VBW: 3 MHz, Sweep time: auto.



# TR-4-E-009 Radiated Emission Test Result

**Test Date:** 2024-10-26      **Tested By:** Zhong Nan  
**EUT:** Wireless Speaker      **Model Number:** ENCHANT SPEAKER  
**Test Mode:** ANT1 11B TX 2462 MHz Mode      **Power Supply:** AC 120V/60Hz  
**Condition:** Temp:23.5°C;Humi:65.2%      **Test Site:** DDT 3# Chamber  
**File Path:** d:\ts\2024 report data\Q24081509-1E\1025\89  
**Memo:** Sample Number: S24081509-003

## Test Graph

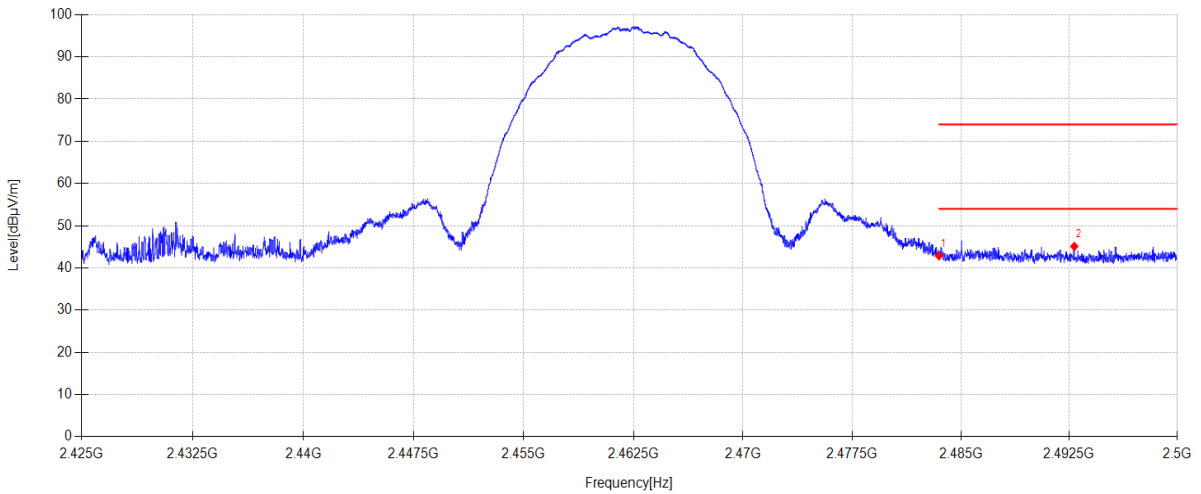

Data List										
N O.	Freq. [MHz]	Reading [dBµV/m]	Antenna Factor [dB]	Cable loss [dB]	AMP [dB]	Level [dBµV/m]	Limit [dBµV/m]	Margin [dB]	Detector	Polarity
1	2483.500	11.73	27.53	3.62	0.00	42.88	74.00	31.12	PK	Horizontal
2	2492.853	13.91	27.57	3.63	0.00	45.11	74.00	28.89	PK	Horizontal

**Note:**

1. Level = Reading + Cable loss + Antenna Factor + AMP
2. If Peak Result complies with AV limit, AV Result is deemed to comply with AV limit.
3. Test setup: RBW: 1 MHz, VBW: 3 MHz, Sweep time: auto.

# TR-4-E-009 Radiated Emission Test Result

**Test Date:** 2024-10-26      **Tested By:** Zhong Nan  
**EUT:** Wireless Speaker      **Model Number:** ENCHANT SPEAKER  
**Test Mode:** ANT1 11B TX 2462 MHz Mode      **Power Supply:** AC 120V/60Hz  
**Condition:** Temp:23.5°C;Humi:65.2%      **Test Site:** DDT 3# Chamber  
**File Path:** d:\ts\2024 report data\Q24081509-1E\1025\90  
**Memo:** Sample Number: S24081509-003

## Test Graph

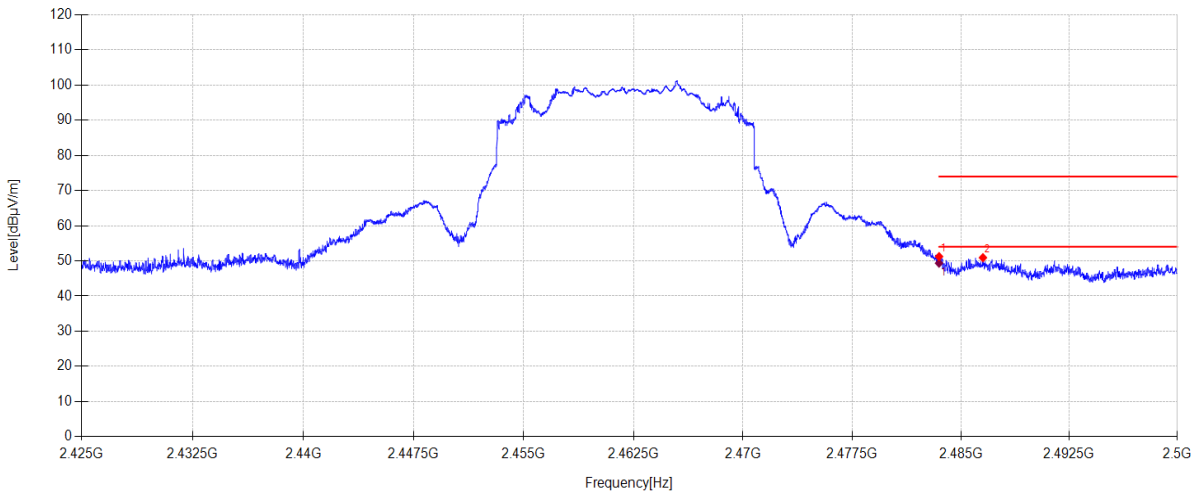

Data List										
N O.	Freq. [MHz]	Reading [dBµV/m]	Antenna Factor [dB]	Cable loss [dB]	AMP [dB]	Level [dBµV/m]	Limit [dBµV/m]	Margin [dB]	Detector	Polarity
1	2483.500	20.08	27.53	3.62	0.00	51.23	74.00	22.77	PK	Vertical
2	2486.530	19.75	27.55	3.62	0.00	50.92	74.00	23.08	PK	Vertical

Data List										
N O.	Freq. [MHz]	Reading [dBµV/m]	Antenna Factor [dB]	Cable loss [dB]	Level [dBµV/m]	Limit [dBµV/m]	Margin [dB]	Detector	Polarity	
1	2483.500	18.21	27.53	3.62	49.36	54.00	4.64	AV	Vertical	

**Note:**

1. Level = Reading + Cable loss + Antenna Factor + AMP
2. If Peak Result complies with AV limit, AV Result is deemed to comply with AV limit.
3. Test setup: RBW: 1 MHz, VBW: 3 MHz, Sweep time: auto.

## TR-4-E-009 Radiated Emission Test Result

**Test Date:** 2024-10-26 **Tested By:** Zhong Nan  
**EUT:** Wireless Speaker **Model Number:** ENCHANT SPEAKER  
**Test Mode:** ANT2 11B TX 2462 MHz Mode **Power Supply:** AC 120V/60Hz  
**Condition:** Temp:23.5°C;Humi:65.2% **Test Site:** DDT 3# Chamber  
**File Path:** d:\ts\2024 report data\Q24081509-1E\1025\91  
**Memo:** Sample Number: S24081509-003

### Test Graph

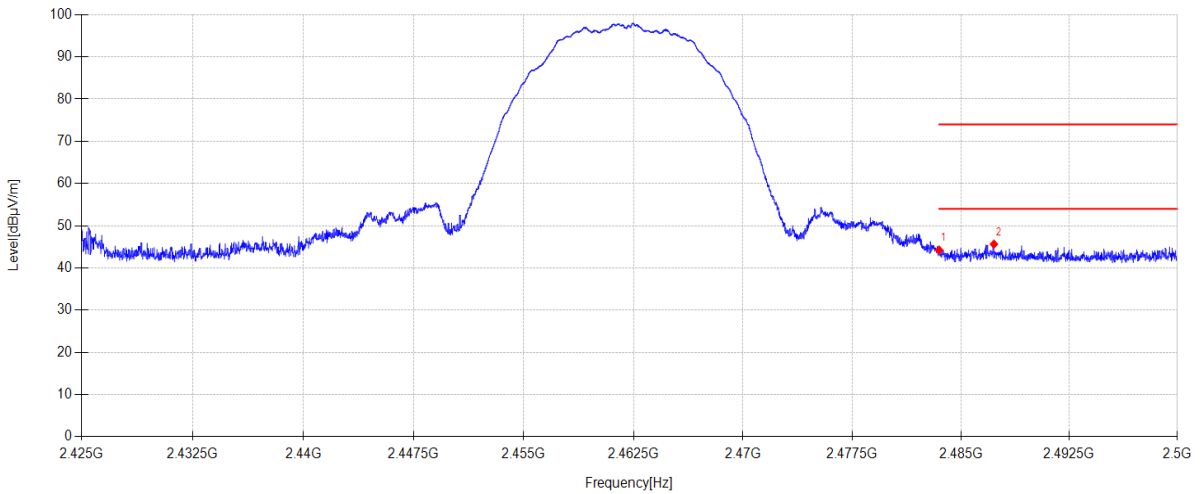

Data List										
N O.	Freq. [MHz]	Reading [dBµV/m]	Antenna Factor [dB]	Cable loss [dB]	AMP [dB]	Level [dBµV/m]	Limit [dBµV/m]	Margin [dB]	Detector	Polarity
1	2483.500	13.09	27.53	3.62	0.00	44.24	74.00	29.76	PK	Horizontal
2	2487.288	14.47	27.55	3.62	0.00	45.64	74.00	28.36	PK	Horizontal

**Note:**

1. Level = Reading + Cable loss + Antenna Factor + AMP
2. If Peak Result complies with AV limit, AV Result is deemed to comply with AV limit.
3. Test setup: RBW: 1 MHz, VBW: 3 MHz, Sweep time: auto.

# TR-4-E-009 Radiated Emission Test Result

**Test Date:** 2024-10-26      **Tested By:** Zhong Nan  
**EUT:** Wireless Speaker      **Model Number:** ENCHANT SPEAKER  
**Test Mode:** ANT2 11B TX 2462 MHz Mode      **Power Supply:** AC 120V/60Hz  
**Condition:** Temp:23.5°C;Humi:65.2%      **Test Site:** DDT 3# Chamber  
**File Path:** d:\ts\2024 report data\Q24081509-1E\1025\92  
**Memo:** Sample Number: S24081509-003

## Test Graph

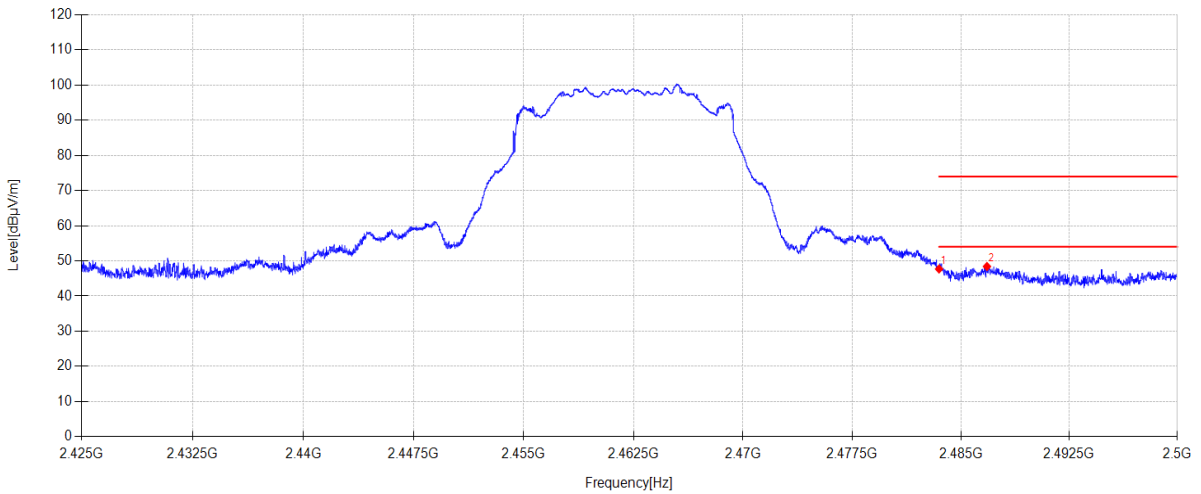

Data List										
N O.	Freq. [MHz]	Reading [dBµV/m]	Antenna Factor [dB]	Cable loss [dB]	AMP [dB]	Level [dBµV/m]	Limit [dBµV/m]	Margin [dB]	Detector	Polarity
1	2483.500	16.56	27.53	3.62	0.00	47.71	74.00	26.29	PK	Vertical
2	2486.808	17.24	27.55	3.62	0.00	48.41	74.00	25.59	PK	Vertical

**Note:**

1. Level = Reading + Cable loss + Antenna Factor + AMP
2. If Peak Result complies with AV limit, AV Result is deemed to comply with AV limit.
3. Test setup: RBW: 1 MHz, VBW: 3 MHz, Sweep time: auto.

## TR-4-E-009 Radiated Emission Test Result

**Test Date:** 2024-10-26 **Tested By:** Zhong Nan  
**EUT:** Wireless Speaker **Model Number:** ENCHANT SPEAKER  
**Test Mode:** ANT1 11G TX 2412 MHz Mode **Power Supply:** AC 120V/60Hz  
**Condition:** Temp:23.5°C;Humi:65.2% **Test Site:** DDT 3# Chamber  
**File Path:** d:\ts\2024 report data\Q24081509-1E\1025\95  
**Memo:** Sample Number: S24081509-003

### Test Graph

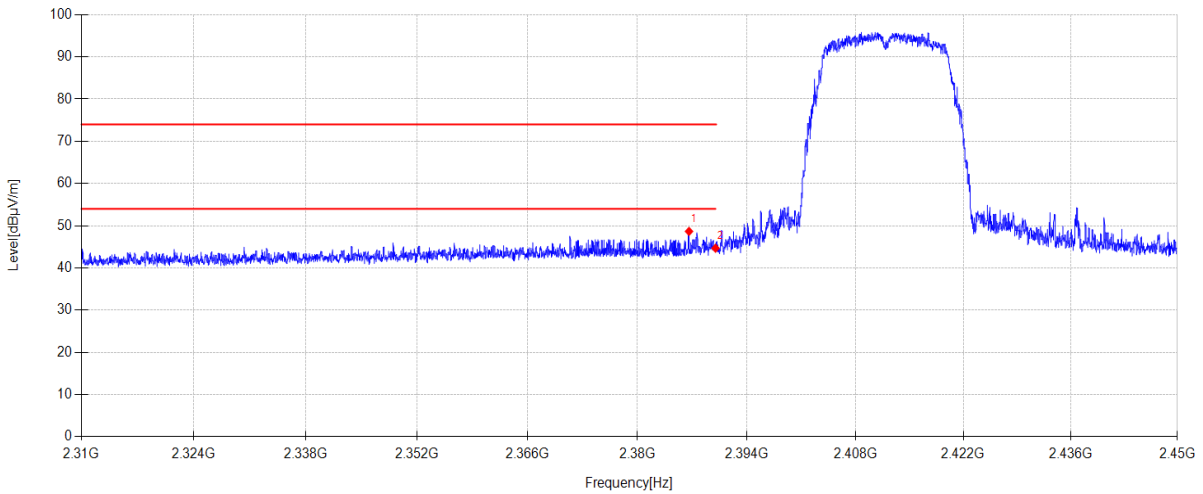

### Data List

N O.	Freq. [MHz]	Reading [dBμV/m]	Antenna Factor [dB]	Cable loss [dB]	AMP [dB]	Level [dBμV/m]	Limit [dBμV/m]	Margin [dB]	Detector	Polarity
1	2386.608	17.84	27.25	3.57	0.00	48.66	74.00	25.34	PK	Horizontal
2	2390.000	13.84	27.26	3.57	0.00	44.67	74.00	29.33	PK	Horizontal

### Note:

- Level = Reading + Cable loss + Antenna Factor + AMP
- If Peak Result complies with AV limit, AV Result is deemed to comply with AV limit.
- Test setup: RBW: 1 MHz, VBW: 3 MHz, Sweep time: auto.

# TR-4-E-009 Radiated Emission Test Result

**Test Date:** 2024-10-26      **Tested By:** Zhong Nan  
**EUT:** Wireless Speaker      **Model Number:** ENCHANT SPEAKER  
**Test Mode:** ANT1 11G TX 2412 MHz Mode      **Power Supply:** AC 120V/60Hz  
**Condition:** Temp:23.5°C;Humi:65.2%      **Test Site:** DDT 3# Chamber  
**File Path:** d:\ts\2024 report data\Q24081509-1E\1025\96  
**Memo:** Sample Number: S24081509-003

## Test Graph

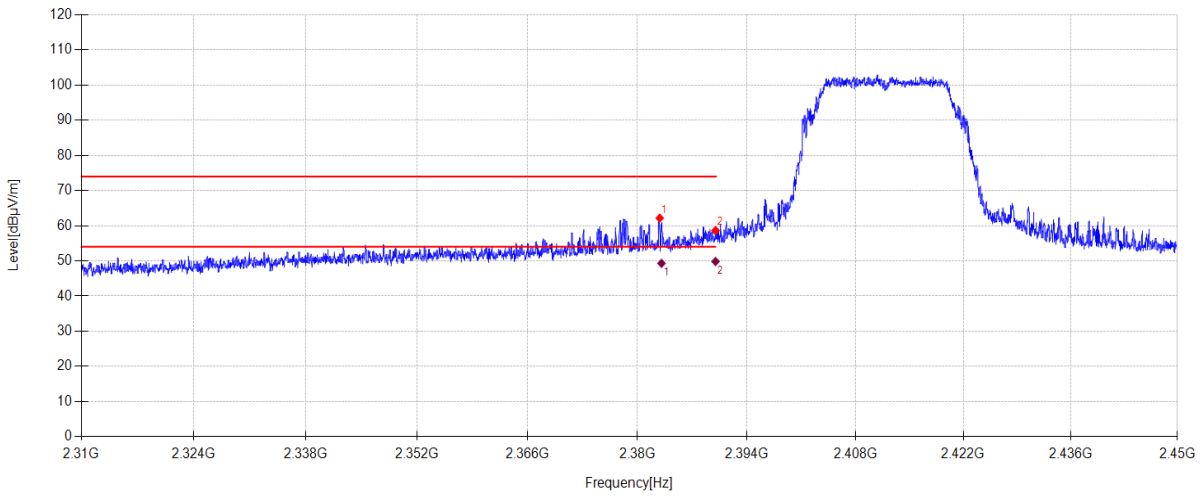

Data List										
N O.	Freq. [MHz]	Reading [dBµV/m]	Antenna Factor [dB]	Cable loss [dB]	AMP [dB]	Level [dBµV/m]	Limit [dBµV/m]	Margin [dB]	Detector	Polarity
1	2382.856	31.38	27.23	3.56	0.00	62.17	74.00	11.83	PK	Vertical
2	2390.000	27.81	27.26	3.57	0.00	58.64	74.00	15.36	PK	Vertical

Data List										
N O.	Freq. [MHz]	Reading [dBµV/m]	Antenna Factor [dB]	Cable loss [dB]	Level [dBµV/m]	Limit [dBµV/m]	Margin [dB]	Detector	Polarity	
1	2383.078	18.51	27.23	3.56	49.30	54.00	4.70	AV	Vertical	
2	2390.000	19.01	27.26	3.57	49.84	54.00	4.16	AV	Vertical	

**Note:**

1. Level = Reading + Cable loss + Antenna Factor + AMP
2. If Peak Result complies with AV limit, AV Result is deemed to comply with AV limit.
3. Test setup: RBW: 1 MHz, VBW: 3 MHz, Sweep time: auto.



## TR-4-E-009 Radiated Emission Test Result

**Test Date:** 2024-10-26 **Tested By:** Zhong Nan  
**EUT:** Wireless Speaker **Model Number:** ENCHANT SPEAKER  
**Test Mode:** ANT2 11G TX 2412 MHz Mode **Power Supply:** AC 120V/60Hz  
**Condition:** Temp:23.5°C;Humi:65.2% **Test Site:** DDT 3# Chamber  
**File Path:** d:\ts\2024 report data\Q24081509-1E\1025\93  
**Memo:** Sample Number: S24081509-003

### Test Graph

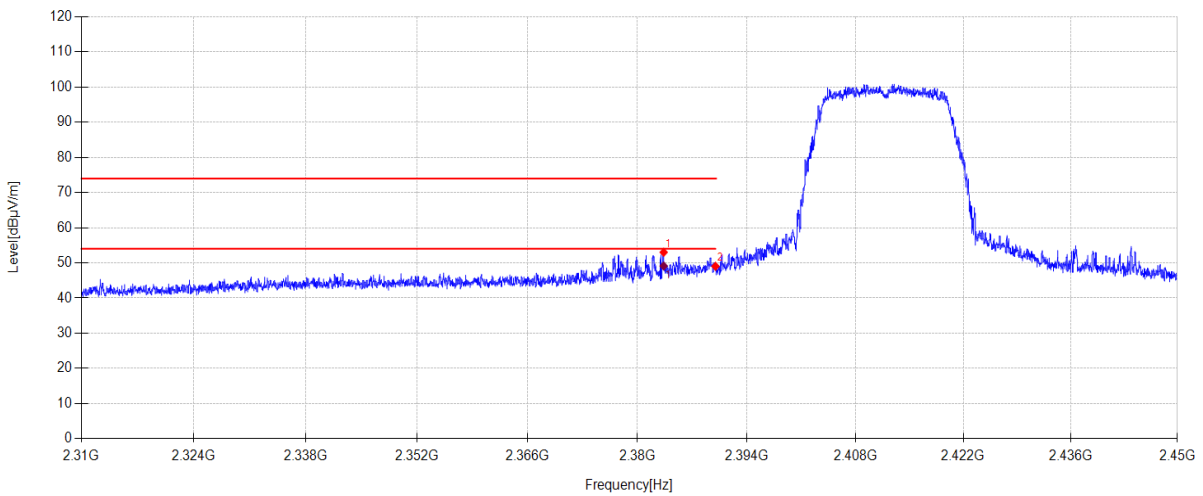

#### Data List

N O.	Freq. [MHz]	Reading [dBµV/m]	Antenna Factor [dB]	Cable loss [dB]	AMP [dB]	Level [dBµV/m]	Limit [dBµV/m]	Margin [dB]	Detector	Polarity
1	2383.360	22.24	27.23	3.56	0.00	53.03	74.00	20.97	PK	Horizontal
2	2390.000	18.20	27.26	3.57	0.00	49.03	74.00	24.97	PK	Horizontal

#### Data List

N O.	Freq. [MHz]	Reading [dBµV/m]	Antenna Factor [dB]	Cable loss [dB]	Level [dBµV/m]	Limit [dBµV/m]	Margin [dB]	Detector	Polarity
1	2383.360	18.33	27.23	3.56	49.12	54.00	4.88	AV	Horizontal

#### Note:

1. Level = Reading + Cable loss + Antenna Factor + AMP
2. If Peak Result complies with AV limit, AV Result is deemed to comply with AV limit.
3. Test setup: RBW: 1 MHz, VBW: 3 MHz, Sweep time: auto.



# TR-4-E-009 Radiated Emission Test Result

**Test Date:** 2024-10-26 **Tested By:** Zhong Nan  
**EUT:** Wireless Speaker **Model Number:** ENCHANT SPEAKER  
**Test Mode:** ANT2 11G TX 2412 MHz Mode **Power Supply:** AC 120V/60Hz  
**Condition:** Temp:23.5°C;Humi:65.2% **Test Site:** DDT 3# Chamber  
**File Path:** d:\ts\2024 report data\Q24081509-1E\1025\94  
**Memo:** Sample Number: S24081509-003

## Test Graph

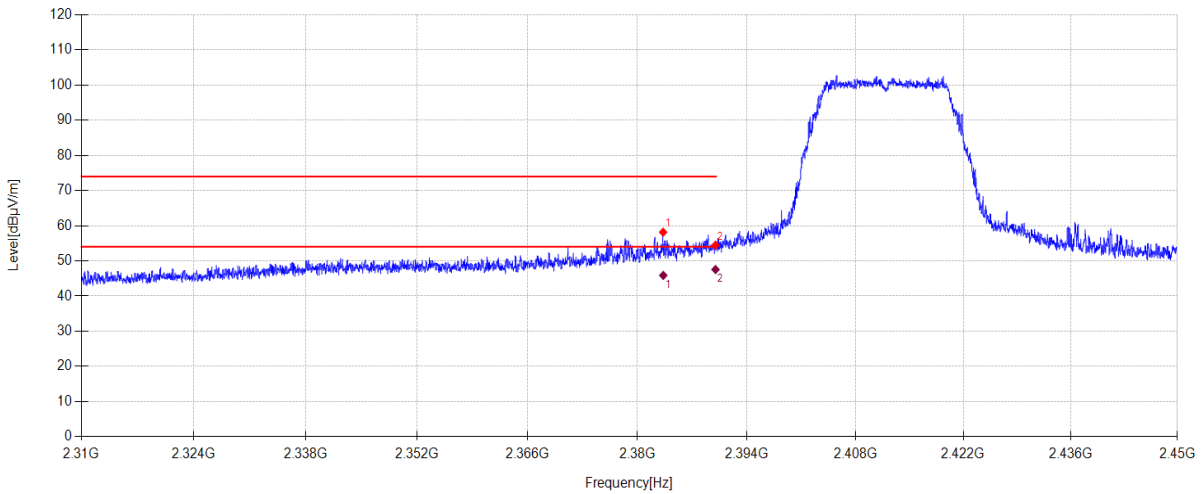

Data List										
N O.	Freq. [MHz]	Reading [dBµV/m]	Antenna Factor [dB]	Cable loss [dB]	AMP [dB]	Level [dBµV/m]	Limit [dBµV/m]	Margin [dB]	Detector	Polarity
1	2383.290	27.37	27.23	3.56	0.00	58.16	74.00	15.84	PK	Vertical
2	2390.000	23.63	27.26	3.57	0.00	54.46	74.00	19.54	PK	Vertical

Data List										
N O.	Freq. [MHz]	Reading [dBµV/m]	Antenna Factor [dB]	Cable loss [dB]	AMP [dB]	Level [dBµV/m]	Limit [dBµV/m]	Margin [dB]	Detector	Polarity
1	2383.302	15.09	27.23	3.56		45.88	54.00	8.12	AV	Vertical
2	2390.000	16.72	27.26	3.57		47.55	54.00	6.45	AV	Vertical

Note:

1. Level = Reading + Cable loss + Antenna Factor + AMP
2. If Peak Result complies with AV limit, AV Result is deemed to comply with AV limit.
3. Test setup: RBW: 1 MHz, VBW: 3 MHz, Sweep time: auto.

# TR-4-E-009 Radiated Emission Test Result

**Test Date:** 2024-10-26      **Tested By:** Zhong Nan  
**EUT:** Wireless Speaker      **Model Number:** ENCHANT SPEAKER  
**Test Mode:** ANT1 11G TX 2462 MHz Mode      **Power Supply:** AC 120V/60Hz  
**Condition:** Temp:23.5°C;Humi:65.2%      **Test Site:** DDT 3# Chamber  
**File Path:** d:\ts\2024 report data\Q24081509-1E\1025\97  
**Memo:** Sample Number: S24081509-003

## Test Graph

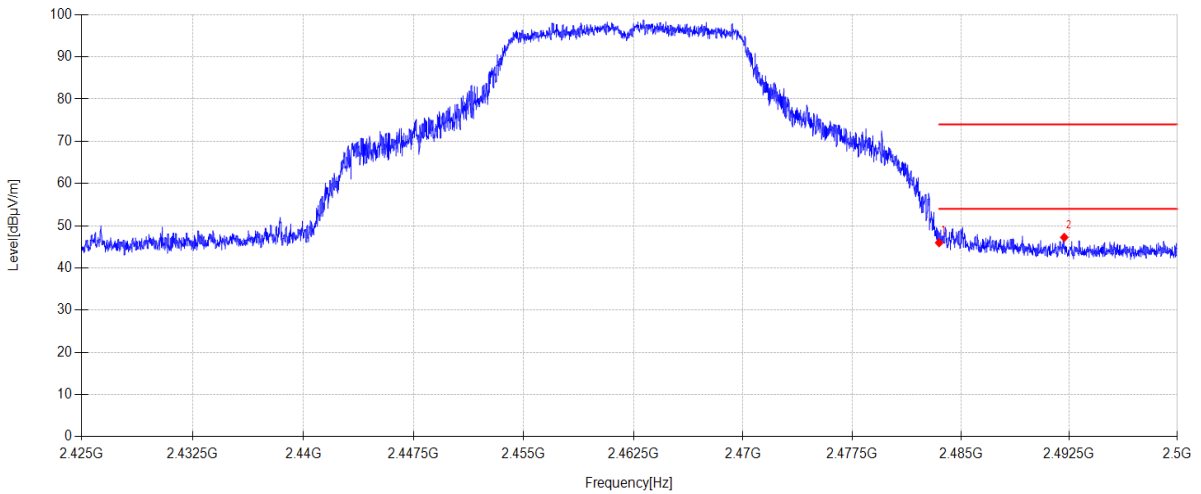

Data List										
N O.	Freq. [MHz]	Reading [dBµV/m]	Antenna Factor [dB]	Cable loss [dB]	AMP [dB]	Level [dBµV/m]	Limit [dBµV/m]	Margin [dB]	Detector	Polarity
1	2483.500	14.82	27.53	3.62	0.00	45.97	74.00	28.03	PK	Horizontal
2	2492.155	16.04	27.57	3.63	0.00	47.24	74.00	26.76	PK	Horizontal

**Note:**

1. Level = Reading + Cable loss + Antenna Factor + AMP
2. If Peak Result complies with AV limit, AV Result is deemed to comply with AV limit.
3. Test setup: RBW: 1 MHz, VBW: 3 MHz, Sweep time: auto.

# TR-4-E-009 Radiated Emission Test Result

**Test Date:** 2024-10-26      **Tested By:** Zhong Nan  
**EUT:** Wireless Speaker      **Model Number:** ENCHANT SPEAKER  
**Test Mode:** ANT1 11G TX 2462 MHz Mode      **Power Supply:** AC 120V/60Hz  
**Condition:** Temp:23.5°C;Humi:65.2%      **Test Site:** DDT 3# Chamber  
**File Path:** d:\ts\2024 report data\Q24081509-1E\1025\98  
**Memo:** Sample Number: S24081509-003

## Test Graph

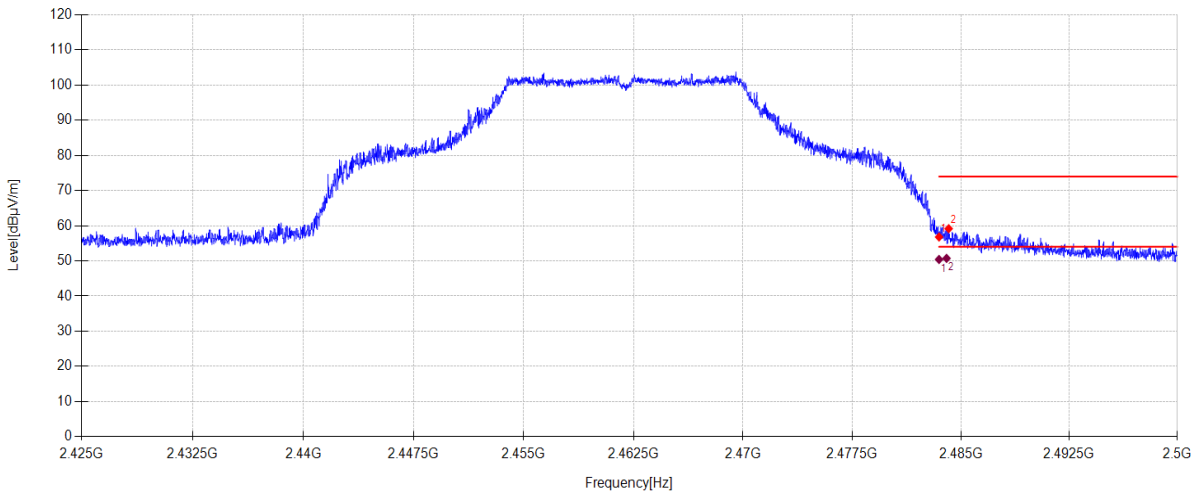

Data List										
N O.	Freq. [MHz]	Reading [dBµV/m]	Antenna Factor [dB]	Cable loss [dB]	AMP [dB]	Level [dBµV/m]	Limit [dBµV/m]	Margin [dB]	Detector	Polarity
1	2483.500	25.65	27.53	3.62	0.00	56.80	74.00	17.20	PK	Vertical
2	2484.168	28.00	27.54	3.62	0.00	59.16	74.00	14.84	PK	Vertical

Data List										
N O.	Freq. [MHz]	Reading [dBµV/m]	Antenna Factor [dB]	Cable loss [dB]	Level [dBµV/m]	Limit [dBµV/m]	Margin [dB]	Detector	Polarity	
1	2483.500	19.26	27.53	3.62	50.41	54.00	3.59	AV	Vertical	
2	2484.017	19.57	27.54	3.62	50.73	54.00	3.27	AV	Vertical	

**Note:**

1. Level = Reading + Cable loss + Antenna Factor + AMP
2. If Peak Result complies with AV limit, AV Result is deemed to comply with AV limit.
3. Test setup: RBW: 1 MHz, VBW: 3 MHz, Sweep time: auto.

## TR-4-E-009 Radiated Emission Test Result

**Test Date:** 2024-10-26 **Tested By:** Zhong Nan  
**EUT:** Wireless Speaker **Model Number:** ENCHANT SPEAKER  
**Test Mode:** ANT2 11G TX 2462 MHz Mode **Power Supply:** AC 120V/60Hz  
**Condition:** Temp:23.5°C;Humi:65.2% **Test Site:** DDT 3# Chamber  
**File Path:** d:\ts\2024 report data\Q24081509-1E\1025\99  
**Memo:** Sample Number: S24081509-003

### Test Graph

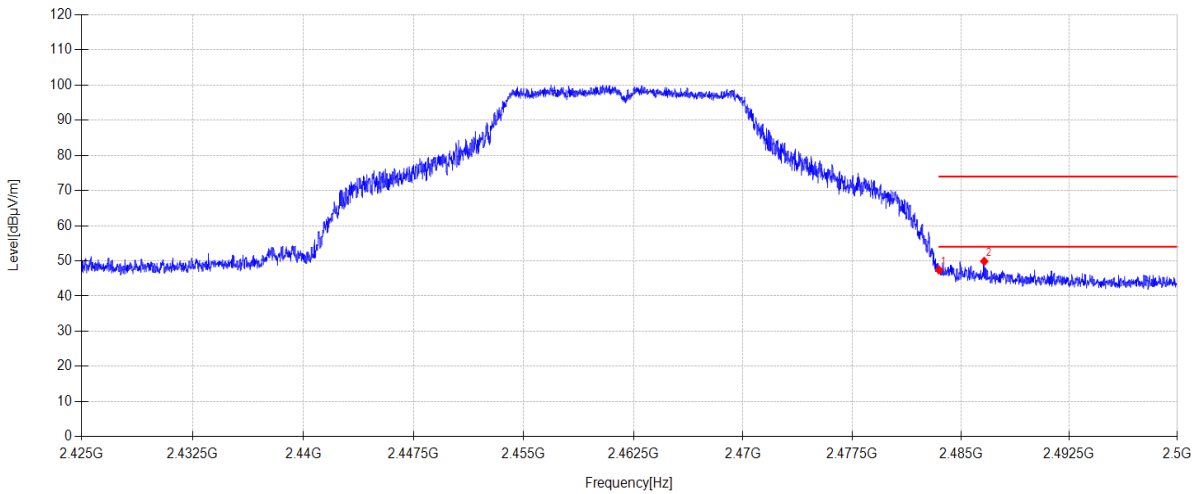

### Data List

N O.	Freq. [MHz]	Reading [dBμV/m]	Antenna Factor [dB]	Cable loss [dB]	AMP [dB]	Level [dBμV/m]	Limit [dBμV/m]	Margin [dB]	Detector	Polarity
1	2483.500	16.25	27.53	3.62	0.00	47.40	74.00	26.60	PK	Horizontal
2	2486.620	18.72	27.55	3.62	0.00	49.89	74.00	24.11	PK	Horizontal

### Note:

1. Level = Reading + Cable loss + Antenna Factor + AMP
2. If Peak Result complies with AV limit, AV Result is deemed to comply with AV limit.
3. Test setup: RBW: 1 MHz, VBW: 3 MHz, Sweep time: auto.

# TR-4-E-009 Radiated Emission Test Result

**Test Date:** 2024-10-26 **Tested By:** Zhong Nan  
**EUT:** Wireless Speaker **Model Number:** ENCHANT SPEAKER  
**Test Mode:** ANT2 11G TX 2462 MHz Mode **Power Supply:** AC 120V/60Hz  
**Condition:** Temp:23.5°C;Humi:65.2% **Test Site:** DDT 3# Chamber  
**File Path:** d:\ts\2024 report data\Q24081509-1E\1025\100  
**Memo:** Sample Number: S24081509-003

## Test Graph

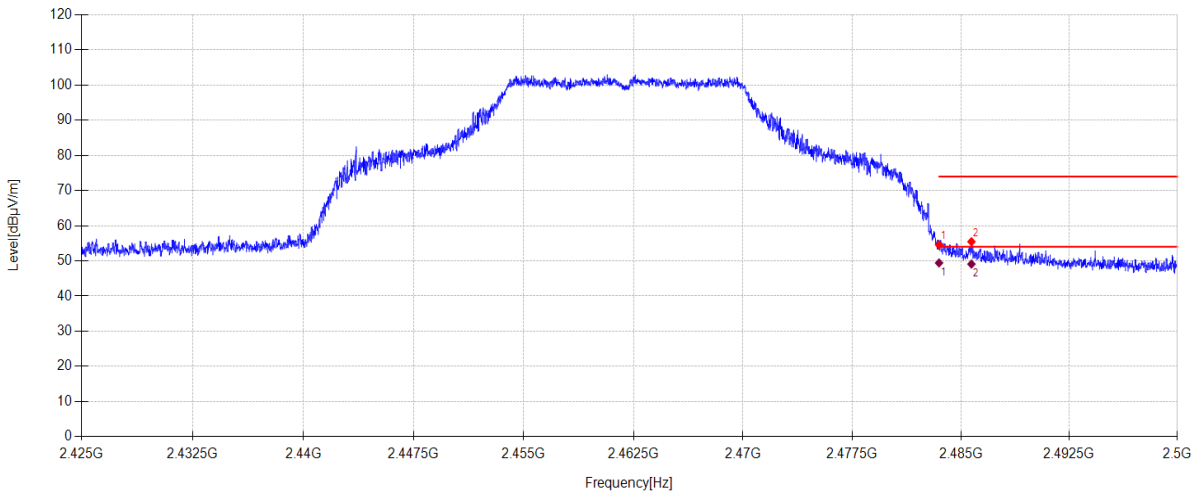

Data List										
N O.	Freq. [MHz]	Reading [dBµV/m]	Antenna Factor [dB]	Cable loss [dB]	AMP [dB]	Level [dBµV/m]	Limit [dBµV/m]	Margin [dB]	Detector	Polarity
1	2483.500	23.42	27.53	3.62	0.00	54.57	74.00	19.43	PK	Vertical
2	2485.735	24.30	27.54	3.62	0.00	55.46	74.00	18.54	PK	Vertical

Data List										
N O.	Freq. [MHz]	Reading [dBµV/m]	Antenna Factor [dB]	Cable loss [dB]	Level [dBµV/m]	Limit [dBµV/m]	Margin [dB]	Detector	Polarity	
1	2483.500	18.27	27.53	3.62	49.42	54.00	4.58	AV	Vertical	
2	2485.735	17.94	27.54	3.62	49.10	54.00	4.90	AV	Vertical	

**Note:**

1. Level = Reading + Cable loss + Antenna Factor + AMP
2. If Peak Result complies with AV limit, AV Result is deemed to comply with AV limit.
3. Test setup: RBW: 1 MHz, VBW: 3 MHz, Sweep time: auto.





## TR-4-E-009 Radiated Emission Test Result

**Test Date:** 2024-09-12 **Tested By:** Guoyuan Lin  
**EUT:** Wireless Speaker **Model Number:** ENCHANT SPEAKER  
**Test Mode:** 11N20 MIMO TX 2412 MHz Mode **Power Supply:** AC 120V/60Hz  
**Condition:** Temp:23.5°C;Humi:65.2% **Test Site:** DDT 3# Chamber  
**File Path:** d:\ts\2024 report data\Q24081509-1E\FCC ABOVE1G 2.4GWIFI\212  
**Memo:** Sample Number: S24081509-003

### Test Graph

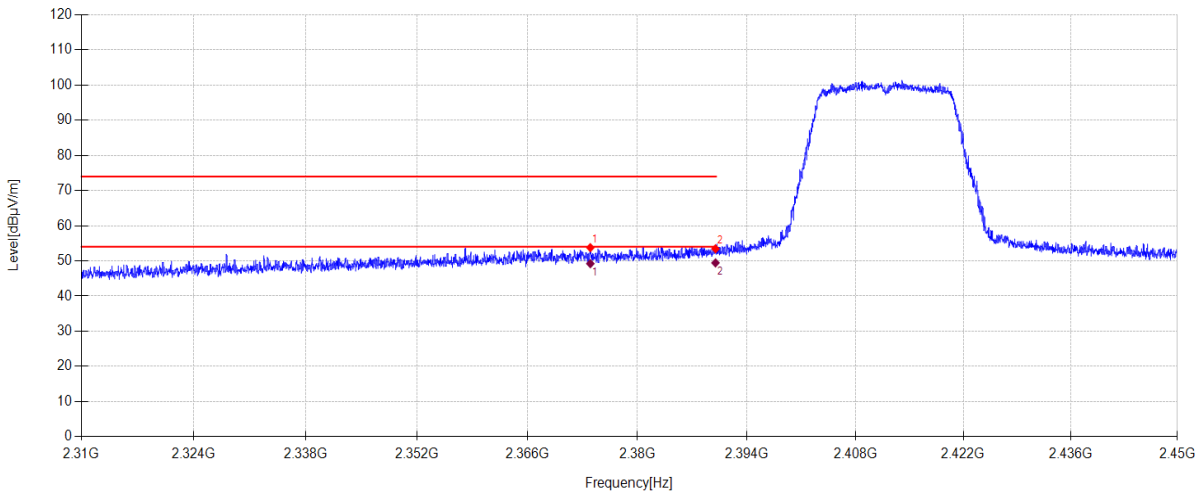

#### Data List

NO	Freq. [MHz]	Reading [dBµV/m]	Antenna Factor [dB]	Cable loss [dB]	AMP [dB]	Level [dBµV/m]	Limit [dBµV/m]	Margin [dB]	Detector	Polarity
1	2373.994	23.01	27.20	3.56	0.00	53.77	74.00	20.23	PK	Vertical
2	2390.000	22.61	27.26	3.57	0.00	53.44	74.00	20.56	PK	Vertical

#### Data List

NO	Freq. [MHz]	Reading [dBµV/m]	Antenna Factor [dB]	Cable loss [dB]	Level [dBµV/m]	Limit [dBµV/m]	Margin [dB]	Detector	Polarity
1	2373.994	18.46	27.20	3.56	49.22	54.00	4.78	AV	Vertical
2	2390.000	18.61	27.26	3.57	49.44	54.00	4.56	AV	Vertical

Note:

1. Level = Reading + Cable loss + Antenna Factor + AMP
2. If Peak Result complies with AV limit, AV Result is deemed to comply with AV limit.
3. Test setup: RBW: 1 MHz, VBW: 3 MHz, Sweep time: auto.



## TR-4-E-009 Radiated Emission Test Result

**Test Date:** 2024-09-11 **Tested By:** Guoyuan Lin  
**EUT:** Wireless Speaker **Model Number:** ENCHANT SPEAKER  
**Test Mode:** 11N20 MIMO TX 2462 MHz Mode **Power Supply:** AC 120V/60Hz  
**Condition:** Temp:23.5°C;Humi:65.2% **Test Site:** DDT 3# Chamber  
**File Path:** d:\ts\2024 report data\Q24081509-1E\FCC ABOVE1G 2.4GWIFI\205  
**Memo:** Sample Number: S24081509-003

### Test Graph

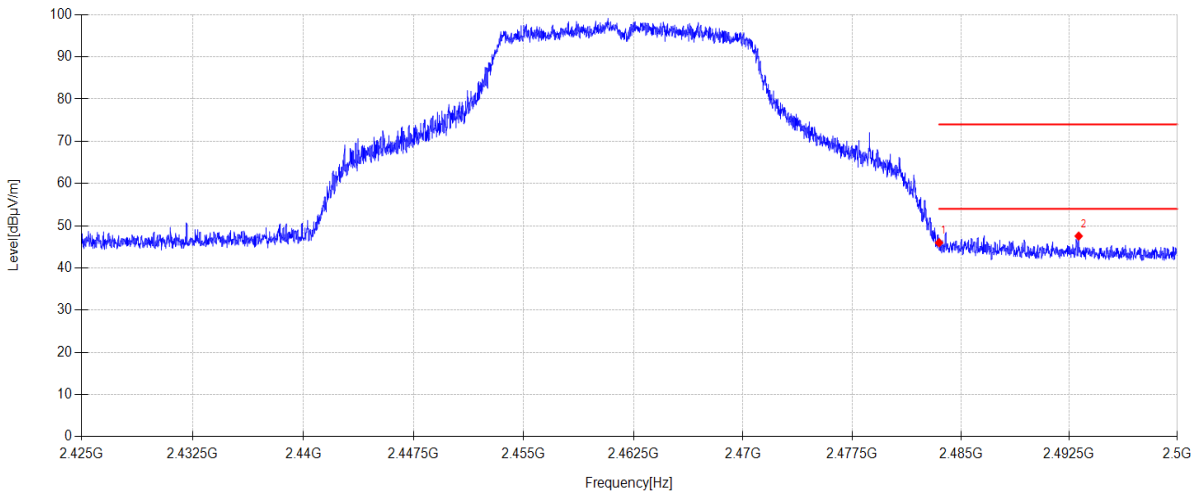

### Data List

NO	Freq. [MHz]	Reading [dBμV/m]	Antenna Factor [dB]	Cable loss [dB]	AMP [dB]	Level [dBμV/m]	Limit [dBμV/m]	Margin [dB]	Detector	Polarity
1	2483.500	14.83	27.53	3.62	0.00	45.98	74.00	28.02	PK	Horizontal
2	2493.153	16.35	27.57	3.63	0.00	47.55	74.00	26.45	PK	Horizontal

### Note:

1. Level = Reading + Cable loss + Antenna Factor + AMP
2. If Peak Result complies with AV limit, AV Result is deemed to comply with AV limit.
3. Test setup: RBW: 1 MHz, VBW: 3 MHz, Sweep time: auto.



## TR-4-E-009 Radiated Emission Test Result

**Test Date:** 2024-09-12 **Tested By:** Guoyuan Lin  
**EUT:** Wireless Speaker **Model Number:** ENCHANT SPEAKER  
**Test Mode:** 11AX20 MIMO TX 2412 MHz Mode **Power Supply:** AC 120V/60Hz  
**Condition:** Temp:23.5°C;Humi:65.2% **Test Site:** DDT 3# Chamber  
**File Path:** d:\ts\2024 report data\Q24081509-1E\FCC ABOVE1G 2.4GWIFI\209  
**Memo:** Sample Number: S24081509-003

### Test Graph

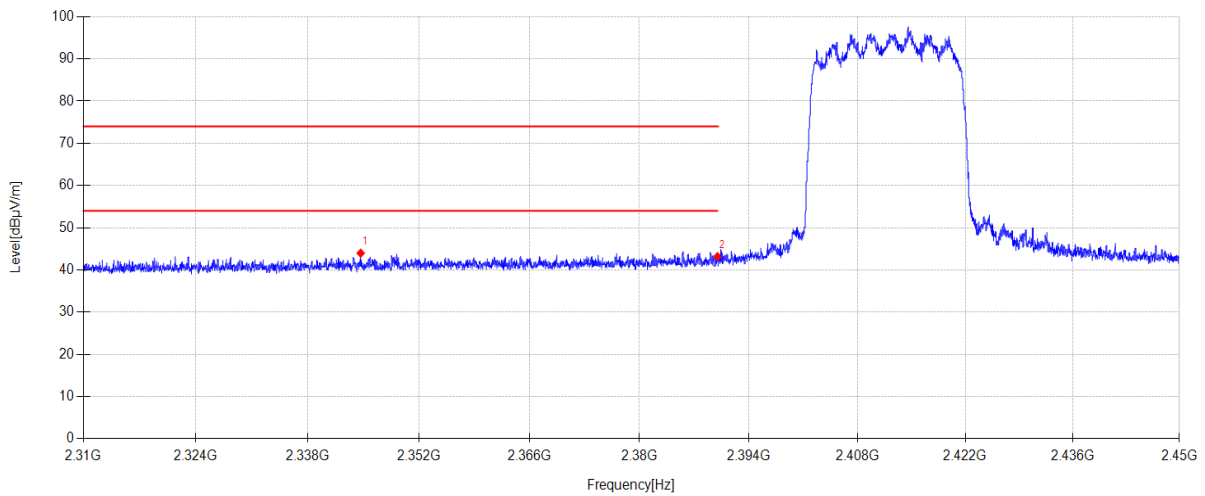

### Data List

NO	Freq. [MHz]	Reading [dBμV/m]	Antenna Factor [dB]	Cable loss [dB]	AMP [dB]	Level [dBμV/m]	Limit [dBμV/m]	Margin [dB]	Detector	Polarity
1	2344.650	13.36	27.07	3.54	0.00	43.97	74.00	30.03	PK	Horizontal
2	2390.000	12.33	27.26	3.57	0.00	43.16	74.00	30.84	PK	Horizontal

### Note:

1. Level = Reading + Cable loss + Antenna Factor + AMP
2. If Peak Result complies with AV limit, AV Result is deemed to comply with AV limit.
3. Test setup: RBW: 1 MHz, VBW: 3 MHz, Sweep time: auto.

## TR-4-E-009 Radiated Emission Test Result

**Test Date:** 2024-09-12 **Tested By:** Guoyuan Lin  
**EUT:** Wireless Speaker **Model Number:** ENCHANT SPEAKER  
**Test Mode:** 11AX20 MIMO TX 2412 MHz Mode **Power Supply:** AC 120V/60Hz  
**Condition:** Temp:23.5°C;Humi:65.2% **Test Site:** DDT 3# Chamber  
**File Path:** d:\ts\2024 report data\Q24081509-1E\FCC ABOVE1G 2.4GWIFI\210  
**Memo:** Sample Number: S24081509-003

### Test Graph

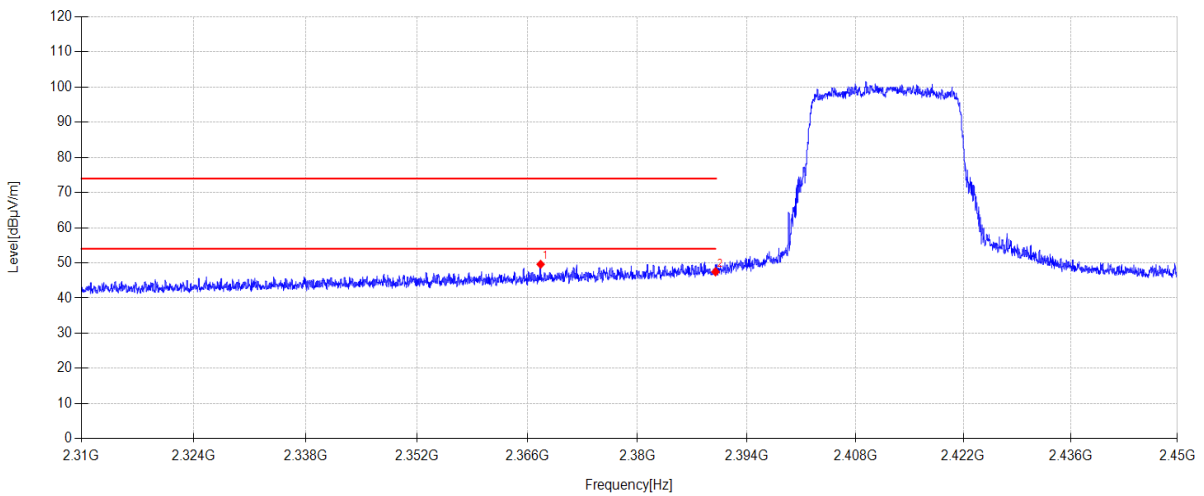

Data List										
NO	Freq. [MHz]	Reading [dBμV/m]	Antenna Factor [dB]	Cable loss [dB]	AMP [dB]	Level [dBμV/m]	Limit [dBμV/m]	Margin [dB]	Detector	Polarity
1	2367.666	18.87	27.17	3.56	0.00	49.60	74.00	24.40	PK	Vertical
2	2390.000	16.64	27.26	3.57	0.00	47.47	74.00	26.53	PK	Vertical

#### Note:

1. Level = Reading + Cable loss + Antenna Factor + AMP
2. If Peak Result complies with AV limit, AV Result is deemed to comply with AV limit.
3. Test setup: RBW: 1 MHz, VBW: 3 MHz, Sweep time: auto.

## TR-4-E-009 Radiated Emission Test Result

**Test Date:** 2024-09-11 **Tested By:** Guoyuan Lin  
**EUT:** Wireless Speaker **Model Number:** ENCHANT SPEAKER  
**Test Mode:** 11AX20 MIMO TX 2462 MHz Mode **Power Supply:** AC 120V/60Hz  
**Condition:** Temp:23.5°C;Humi:65.2% **Test Site:** DDT 3# Chamber  
**File Path:** d:\ts\2024 report data\Q24081509-1E\FCC ABOVE1G 2.4GWIFI\207  
**Memo:** Sample Number: S24081509-003

### Test Graph

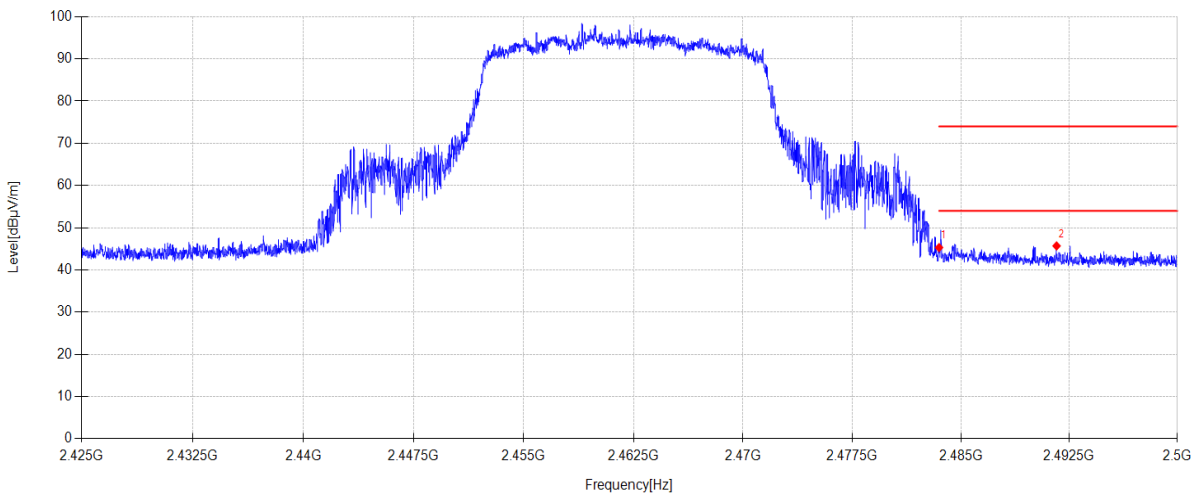

### Data List

NO	Freq. [MHz]	Reading [dBμV/m]	Antenna Factor [dB]	Cable loss [dB]	AMP [dB]	Level [dBμV/m]	Limit [dBμV/m]	Margin [dB]	Detector	Polarity
1	2483.500	14.15	27.53	3.62	0.00	45.30	74.00	28.70	PK	Horizontal
2	2491.623	14.49	27.57	3.63	0.00	45.69	74.00	28.31	PK	Horizontal

### Note:

1. Level = Reading + Cable loss + Antenna Factor + AMP
2. If Peak Result complies with AV limit, AV Result is deemed to comply with AV limit.
3. Test setup: RBW: 1 MHz, VBW: 3 MHz, Sweep time: auto.

# TR-4-E-009 Radiated Emission Test Result

**Test Date:** 2024-09-11      **Tested By:** Guoyuan Lin  
**EUT:** Wireless Speaker      **Model Number:** ENCHANT SPEAKER  
**Test Mode:** 11AX20 MIMO TX 2462 MHz Mode      **Power Supply:** AC 120V/60Hz  
**Condition:** Temp:23.5°C;Humi:65.2%      **Test Site:** DDT 3# Chamber  
**File Path:** d:\ts\2024 report data\Q24081509-1E\FCC ABOVE1G 2.4GWIFI\208  
**Memo:** Sample Number: S24081509-003

## Test Graph

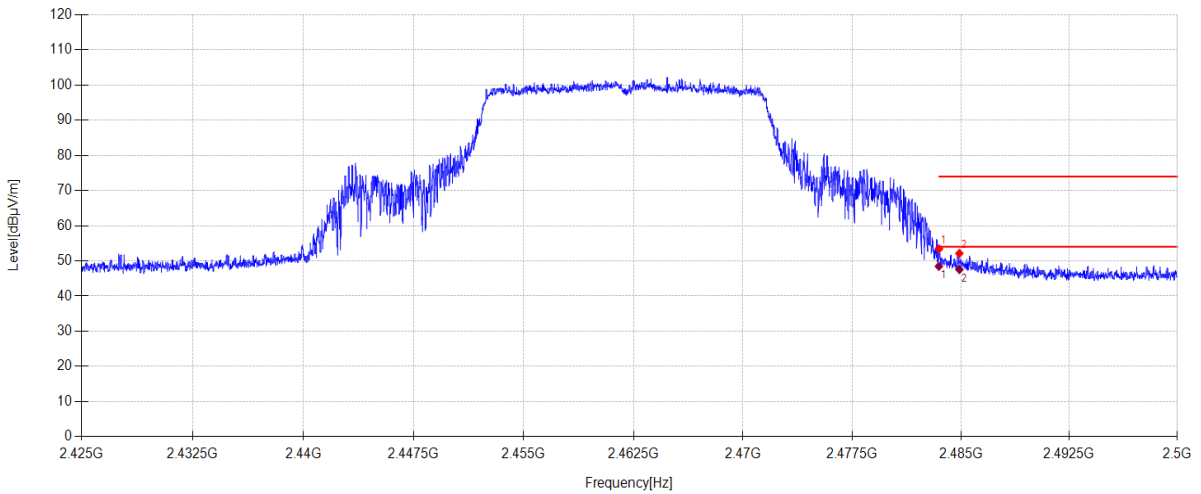

Data List										
NO	Freq. [MHz]	Reading [dBµV/m]	Antenna Factor [dB]	Cable loss [dB]	AMP [dB]	Level [dBµV/m]	Limit [dBµV/m]	Margin [dB]	Detector	Polarity
1	2483.500	22.28	27.53	3.62	0.00	53.43	74.00	20.57	PK	Vertical
2	2484.903	20.98	27.54	3.62	0.00	52.14	74.00	21.86	PK	Vertical

Data List										
NO	Freq. [MHz]	Reading [dBµV/m]	Antenna Factor [dB]	Cable loss [dB]	Level [dBµV/m]	Limit [dBµV/m]	Margin [dB]	Detector	Polarity	
1	2483.489	16.04	27.53	4.89	48.46	54.00	5.54	AV	Vertical	
2	2484.903	16.38	27.54	3.62	47.54	54.00	6.46	AV	Vertical	

**Note:**

1. Level = Reading + Cable loss + Antenna Factor + AMP
2. If Peak Result complies with AV limit, AV Result is deemed to comply with AV limit.
3. Test setup: RBW: 1 MHz, VBW: 3 MHz, Sweep time: auto.



# TR-4-E-009 Radiated Emission Test Result

**Test Date:** 2024-09-12      **Tested By:** Guoyuan Lin  
**EUT:** Wireless Speaker      **Model Number:** ENCHANT SPEAKER  
**Test Mode:** 11N40 MIMO TX 2422 MHz Mode      **Power Supply:** AC 120V/60Hz  
**Condition:** Temp:23.5°C;Humi:65.2%      **Test Site:** DDT 3# Chamber  
**File Path:** d:\ts\2024 report data\Q24081509-1E\FCC ABOVE1G 2.4GWIFI\213  
**Memo:** Sample Number: S24081509-003

## Test Graph

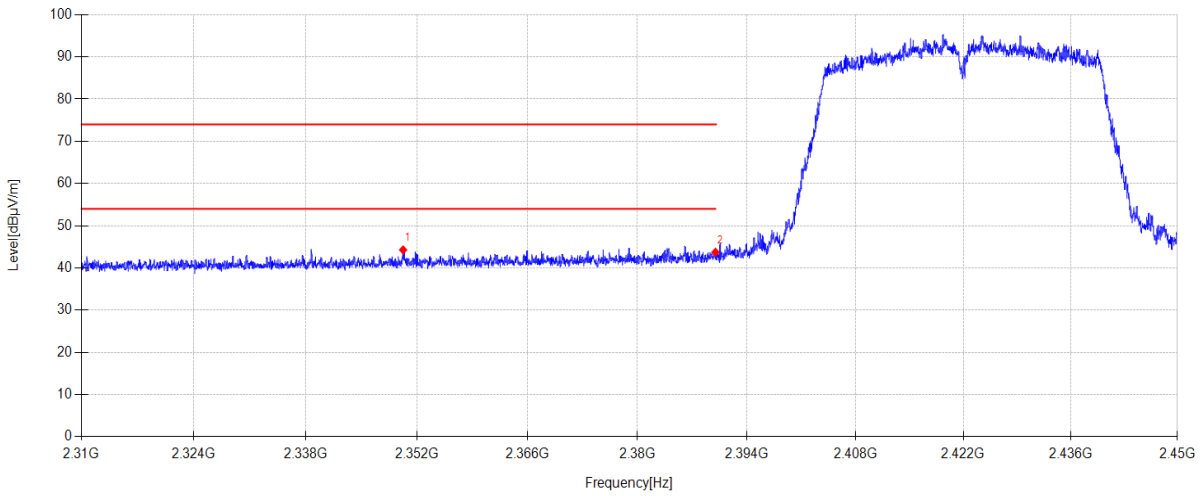

Data List										
NO	Freq. [MHz]	Reading [dBµV/m]	Antenna Factor [dB]	Cable loss [dB]	AMP [dB]	Level [dBµV/m]	Limit [dBµV/m]	Margin [dB]	Detector	Polarity
1	2350.250	13.63	27.10	3.55	0.00	44.28	74.00	29.72	PK	Horizontal
2	2390.000	12.88	27.26	3.57	0.00	43.71	74.00	30.29	PK	Horizontal

**Note:**

1. Level = Reading + Cable loss + Antenna Factor + AMP
2. If Peak Result complies with AV limit, AV Result is deemed to comply with AV limit.
3. Test setup: RBW: 1 MHz, VBW: 3 MHz, Sweep time: auto.





## TR-4-E-009 Radiated Emission Test Result

**Test Date:** 2024-09-12 **Tested By:** Guoyuan Lin  
**EUT:** Wireless Speaker **Model Number:** ENCHANT SPEAKER  
**Test Mode:** 11N40 MIMO TX 2452 MHz Mode **Power Supply:** AC 120V/60Hz  
**Condition:** Temp:23.5°C;Humi:65.2% **Test Site:** DDT 3# Chamber  
**File Path:** d:\ts\2024 report data\Q24081509-1E\FCC ABOVE1G 2.4GWIFI\219  
**Memo:** Sample Number: S24081509-003

### Test Graph

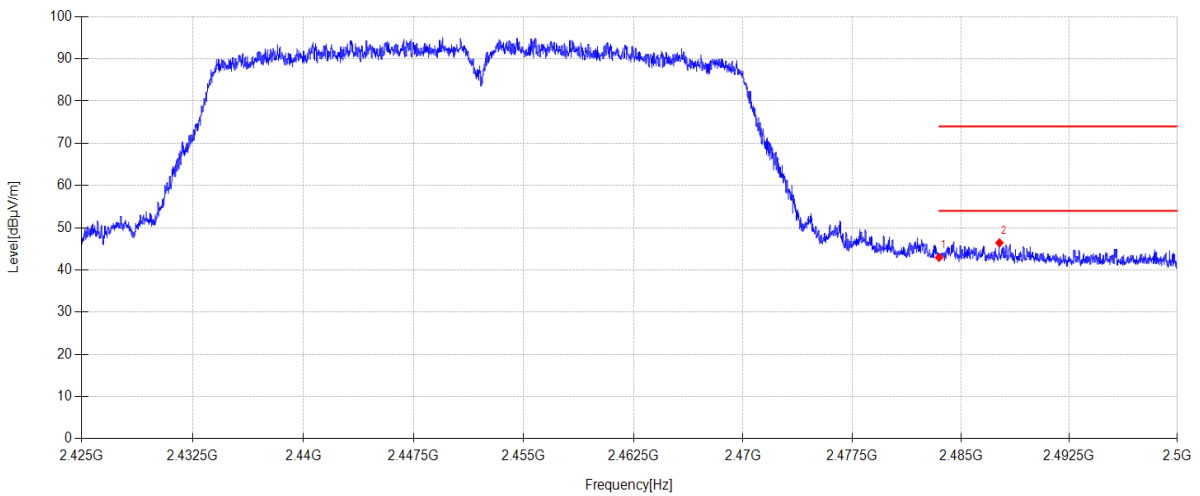

### Data List

NO	Freq. [MHz]	Reading [dBμV/m]	Antenna Factor [dB]	Cable loss [dB]	AMP [dB]	Level [dBμV/m]	Limit [dBμV/m]	Margin [dB]	Detector	Polarity
1	2483.500	11.81	27.53	3.62	0.00	42.96	74.00	31.04	PK	Horizontal
2	2487.670	15.24	27.55	3.62	0.00	46.41	74.00	27.59	PK	Horizontal

### Note:

1. Level = Reading + Cable loss + Antenna Factor + AMP
2. If Peak Result complies with AV limit, AV Result is deemed to comply with AV limit.
3. Test setup: RBW: 1 MHz, VBW: 3 MHz, Sweep time: auto.

## TR-4-E-009 Radiated Emission Test Result

**Test Date:** 2024-09-12 **Tested By:** Guoyuan Lin  
**EUT:** Wireless Speaker **Model Number:** ENCHANT SPEAKER  
**Test Mode:** 11N40 MIMO TX 2452 MHz Mode **Power Supply:** AC 120V/60Hz  
**Condition:** Temp:23.5°C;Humi:65.2% **Test Site:** DDT 3# Chamber  
**File Path:** d:\ts\2024 report data\Q24081509-1E\FCC ABOVE1G 2.4GWIFI\220  
**Memo:** Sample Number: S24081509-003

### Test Graph

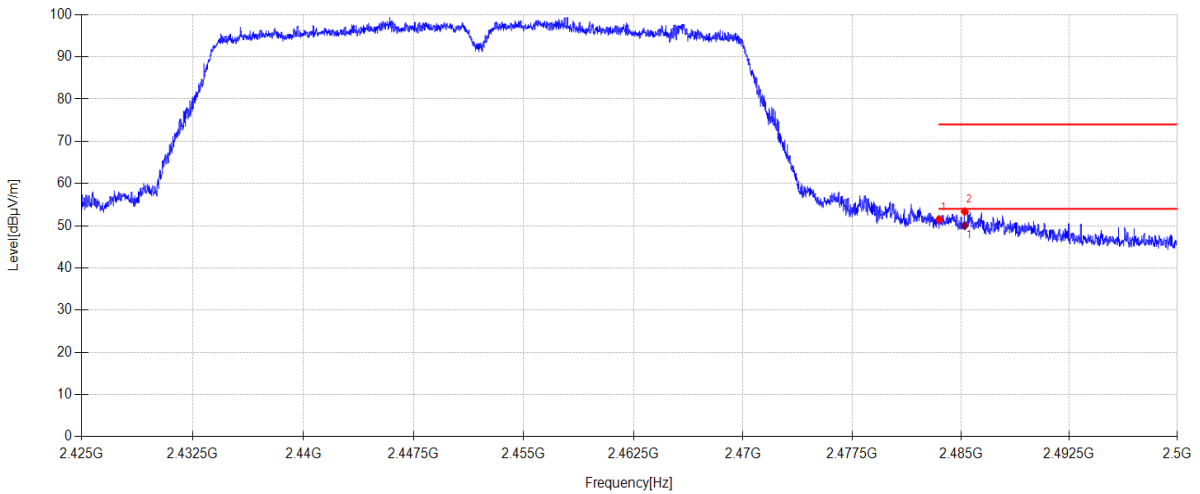

#### Data List

NO	Freq. [MHz]	Reading [dBμV/m]	Antenna Factor [dB]	Cable loss [dB]	AMP [dB]	Level [dBμV/m]	Limit [dBμV/m]	Margin [dB]	Detector	Polarity
1	2483.500	20.32	27.53	3.62	0.00	51.47	74.00	22.53	PK	Vertical
2	2485.270	22.16	27.54	3.62	0.00	53.32	74.00	20.68	PK	Vertical

#### Data List

NO	Freq. [MHz]	Reading [dBμV/m]	Antenna Factor [dB]	Cable loss [dB]	Level [dBμV/m]	Limit [dBμV/m]	Margin [dB]	Detector	Polarity
1	2485.270	18.84	27.54	3.62	50.00	54.00	4.00	AV	Vertical

#### Note:

- Level = Reading + Cable loss + Antenna Factor + AMP
- If Peak Result complies with AV limit, AV Result is deemed to comply with AV limit.
- Test setup: RBW: 1 MHz, VBW: 3 MHz, Sweep time: auto.

## TR-4-E-009 Radiated Emission Test Result

**Test Date:** 2024-09-12 **Tested By:** Guoyuan Lin  
**EUT:** Wireless Speaker **Model Number:** ENCHANT SPEAKER  
**Test Mode:** 11AX40 MIMO TX 2422 MHz Mode **Power Supply:** AC 120V/60Hz  
**Condition:** Temp:23.5°C;Humi:65.2% **Test Site:** DDT 3# Chamber  
**File Path:** d:\ts\2024 report data\Q24081509-1E\FCC ABOVE1G 2.4GWIFI\215  
**Memo:** Sample Number: S24081509-003

### Test Graph

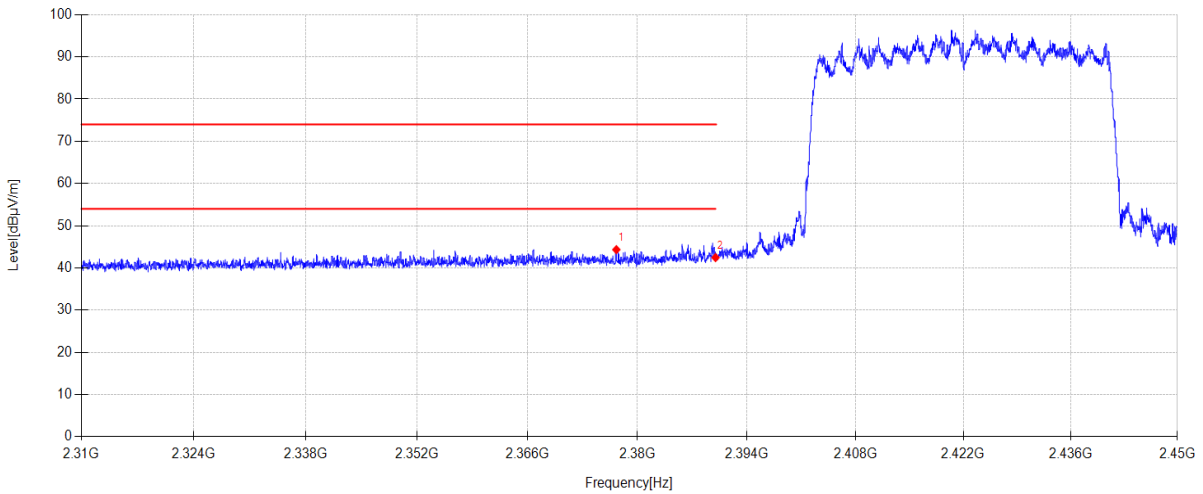

### Data List

NO	Freq. [MHz]	Reading [dBμV/m]	Antenna Factor [dB]	Cable loss [dB]	AMP [dB]	Level [dBμV/m]	Limit [dBμV/m]	Margin [dB]	Detector	Polarity
1	2377.312	13.57	27.21	3.56	0.00	44.34	74.00	29.66	PK	Horizontal
2	2390.000	11.63	27.26	3.57	0.00	42.46	74.00	31.54	PK	Horizontal

### Note:

- Level = Reading + Cable loss + Antenna Factor + AMP
- If Peak Result complies with AV limit, AV Result is deemed to comply with AV limit.
- Test setup: RBW: 1 MHz, VBW: 3 MHz, Sweep time: auto.



# TR-4-E-009 Radiated Emission Test Result

**Test Date:** 2024-09-12 **Tested By:** Guoyuan Lin  
**EUT:** Wireless Speaker **Model Number:** ENCHANT SPEAKER  
**Test Mode:** 11AX40 MIMO TX 2452 MHz Mode **Power Supply:** AC 120V/60Hz  
**Condition:** Temp:23.5°C;Humi:65.2% **Test Site:** DDT 3# Chamber  
**File Path:** d:\ts\2024 report data\Q24081509-1E\FCC ABOVE1G 2.4GWIFI\217  
**Memo:** Sample Number: S24081509-003

## Test Graph

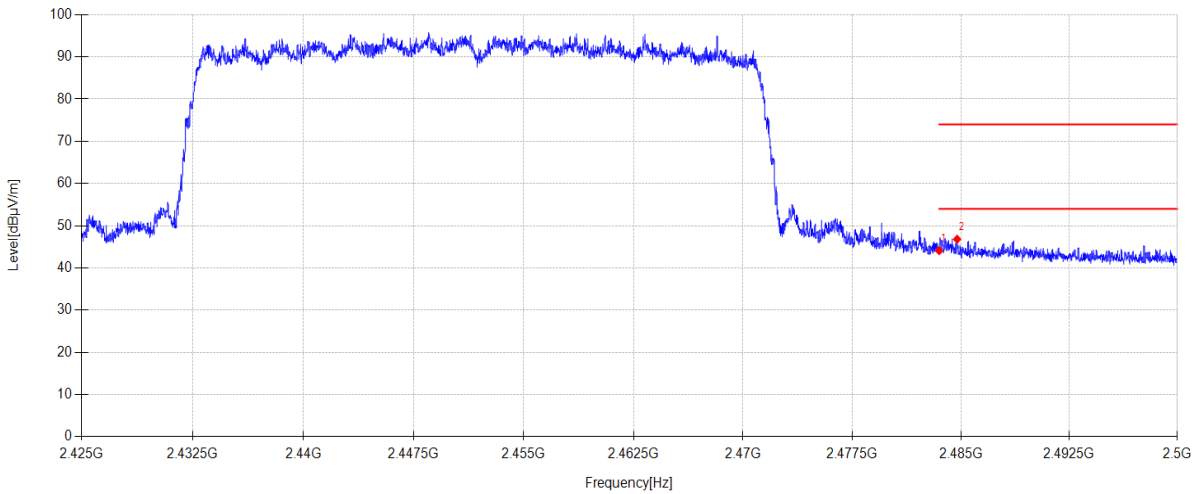

Data List										
NO	Freq. [MHz]	Reading [dBµV/m]	Antenna Factor [dB]	Cable loss [dB]	AMP [dB]	Level [dBµV/m]	Limit [dBµV/m]	Margin [dB]	Detector	Polarity
1	2483.500	12.97	27.53	3.62	0.00	44.12	74.00	29.88	PK	Horizontal
2	2484.745	15.64	27.54	3.62	0.00	46.80	74.00	27.20	PK	Horizontal

**Note:**

1. Level = Reading + Cable loss + Antenna Factor + AMP
2. If Peak Result complies with AV limit, AV Result is deemed to comply with AV limit.
3. Test setup: RBW: 1 MHz, VBW: 3 MHz, Sweep time: auto.







## 14. Power Line Conducted Emissions

### 14.1. Test equipment

Equipment	Manufacturer	Model No.	Serial No.	Cal Due To
EMI Test Software	Audix/TW	e3	DDT-ZC01252	/
Pulse Limiter	SCHWARZBEC K	ESH3-Z2	DDT-ZC00539	2025/07/08
Two Line V-Network	R&S	ENV216	DDT-ZC00535	2025/07/08
CE Cable 1	R&S	ESU8/RF2	DDT-ZC00566	2025/07/08
EMI Test Receiver	R&S	ESCI	DDT-ZC00235	2025/07/08
Artificial mains	R&S	ESH2-Z5	DDT-ZC00538	2025/07/08

### 14.2. Block diagram of test setup

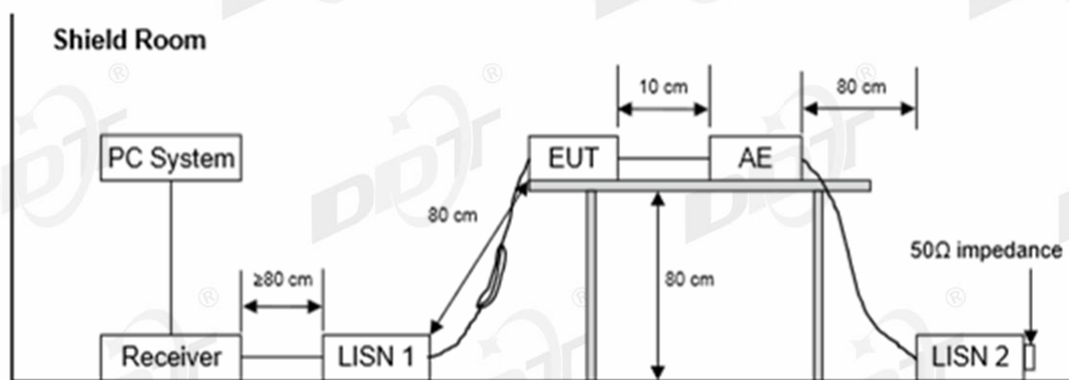

### 14.3. Limits

Frequency	Quasi-Peak Level dB $\mu$ V	Average Level dB $\mu$ V
150 kHz~500 kHz	66 ~ 56*	56 ~ 46*
500 kHz~5 MHz	56	46
5 MHz~30 MHz	60	50

Note 1: \* Decreasing linearly with logarithm of frequency.

Note 2: The lower limit shall apply at the transition frequencies.

### 14.4. Assistant equipment used for test

Assistant equipment	Manufacturer	Model number	Description	other
/	/	/	/	/

### 14.5. Test procedure

The EUT and Support equipment, if needed, were put placed on a non-metallic table, 80cm above the ground plane.

All support equipment power received from a second LISN.

Emissions were measured on each current carrying line of the EUT using an EMI Test Receiver connected to the LISN powering the EUT.

The Receiver scanned from 150 kHz to 30 MHz for emissions in each of the test modes.

During the above scans, the emissions were maximized by cable manipulation.

The test mode(s) described in clause 2.4 were scanned during the preliminary test.

After the preliminary scan, we found the test mode producing the highest emission level.

The EUT configuration and worse cable configuration of the above highest emission levels were recorded for reference of the final test.

EUT and support equipment were set up on the test bench as per the configuration with highest emission level in the preliminary test.

A scan was taken on both power lines, Neutral and Line, recording at least the six highest emissions.

Emission frequency and amplitude were recorded into a computer in which correction factors were used to calculate the emission level and compare reading to the applicable limit.

The test data of the worst-case condition(s) was recorded.

The bandwidth of test receiver is set at 9 kHz.

#### **14.6. Test result**

##### **PASS. (See below detailed test result)**

Note1: All emissions not reported below are too low against the prescribed limits.

Note2: "-----" means Peak detection; "-----" means Average detection.

Note3: Pre-test AC conducted emission at both voltage AC 120V/60Hz and AC 240V/50Hz, recorded the worst case.

## 14.7. Test data

## TR-4-E-010 Conducted Emission Test Result

**Test Site** : DDT 1# Shield Room D:\2024 CE report data\Q24081509-1E\CE-FCC.EM6  
**Test Date** : 2024-09-09 **Tested By** : Gen Liu  
**EUT** : Wireless Speaker **Model Number** : ENCHANT SPEAKER  
**Power Supply** : AC 120V/60Hz **Test Mode** : Tx mode  
**Condition** : TEMP:21.5°C, RH:53.6% **LISN** : 2023 1# ENV216/NEUTRAL  
**Memo** : Sample Number:S24081509-003

Data: 2

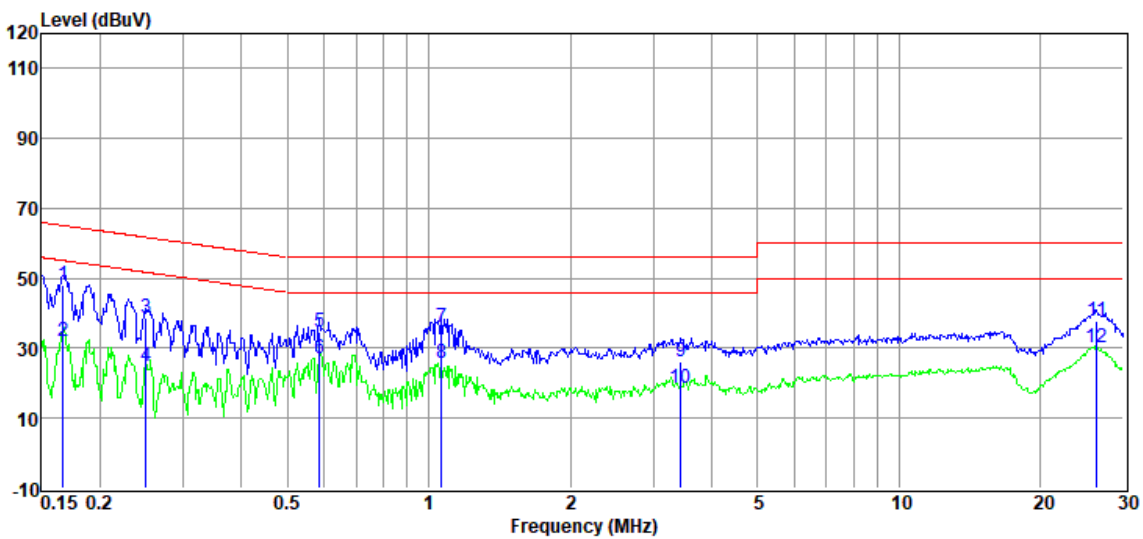

Item (Mark)	Freq. (MHz)	Read Level (dBuV)	LISN Factor (dB)	Cable Loss (dB)	Pulse Limiter Factor (dB)	Result Level (dBuV)	Limit Line (dBuV)	Over Limit (dB)	Detector	Phase
1	0.17	27.64	9.88	0.92	9.68	48.12	65.12	-17.00	QP	NEUTRAL
2	0.17	11.58	9.88	0.92	9.68	32.06	55.12	-23.06	Average	NEUTRAL
3	0.25	18.51	9.75	0.89	9.69	38.84	61.73	-22.89	QP	NEUTRAL
4	0.25	4.43	9.75	0.89	9.69	24.76	51.73	-26.97	Average	NEUTRAL
5	0.59	14.35	9.82	0.83	9.72	34.72	56.00	-21.28	QP	NEUTRAL
6	0.59	6.53	9.82	0.83	9.72	26.90	46.00	-19.10	Average	NEUTRAL
7	1.07	16.01	9.74	0.67	9.73	36.15	56.00	-19.85	QP	NEUTRAL
8	1.07	5.55	9.74	0.67	9.73	25.69	46.00	-20.31	Average	NEUTRAL
9	3.44	6.07	9.73	0.58	9.78	26.16	56.00	-29.84	QP	NEUTRAL
10	3.44	-1.71	9.73	0.58	9.78	18.38	46.00	-27.62	Average	NEUTRAL
11	26.28	17.09	10.04	0.54	9.91	37.58	60.00	-22.42	QP	NEUTRAL
12	26.28	9.76	10.04	0.54	9.91	30.25	50.00	-19.75	Average	NEUTRAL

Note:

1. Result Level = Read Level + LISN Factor + Pulse Limiter Factor + Cable loss.
2. If QP Result complies with AV limit, AV Result is deemed to comply with AV limit.
3. Test setup: RBW: 200 Hz (9 kHz—150 kHz), 9 kHz (150 kHz—30 MHz).
4. Step size: 80Hz (0.009MHz-0.15MHz), 4 kHz (0.15MHz-30MHz), Scan time: auto.

# TR-4-E-010 Conducted Emission Test Result

**Test Site** : DDT 1# Shield Room D:\2024 CE report data\Q24081509-1E\CE-FCC.EM6  
**Test Date** : 2024-09-09 **Tested By** : Gen Liu  
**EUT** : Wireless Speaker **Model Number** : ENCHANT SPEAKER  
**Power Supply** : AC 120V/60Hz **Test Mode** : Tx mode  
**Condition** : TEMP:21.5°C, RH:53.6% **LISN** : 2023 1# ENV216/LINE  
**Memo** : Sample Number:S24081509-003

Data: 4

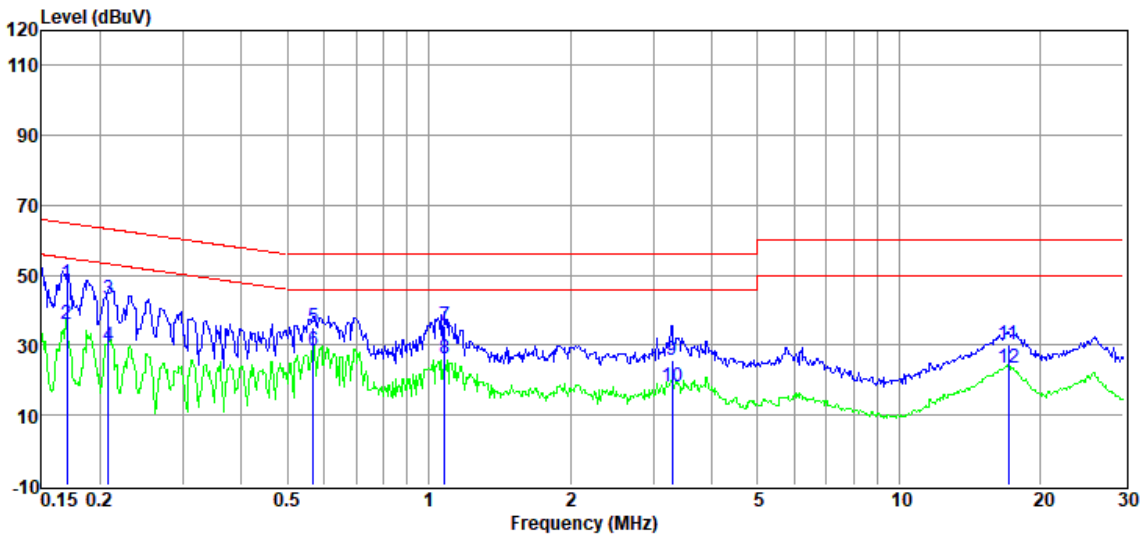

Item (Mark)	Freq. (MHz)	Read Level (dBμV)	LISN Factor (dB)	Cable Loss (dB)	Pulse Limiter Factor (dB)	Result Level (dBμV)	Limit Line (dBμV)	Over Limit (dB)	Detector	Phase
1	0.17	27.20	9.74	0.92	9.68	47.54	64.94	-17.40	QP	LINE
2	0.17	15.64	9.74	0.92	9.68	35.98	54.94	-18.96	Average	LINE
3	0.21	22.96	9.77	0.91	9.69	43.33	63.27	-19.94	QP	LINE
4	0.21	9.43	9.77	0.91	9.69	29.80	53.27	-23.47	Average	LINE
5	0.57	14.60	9.80	0.83	9.72	34.95	56.00	-21.05	QP	LINE
6	0.57	8.23	9.80	0.83	9.72	28.58	46.00	-17.42	Average	LINE
7	1.08	15.73	9.66	0.67	9.73	35.79	56.00	-20.21	QP	LINE
8	1.08	6.16	9.66	0.67	9.73	26.22	46.00	-19.78	Average	LINE
9	3.29	5.81	9.64	0.58	9.78	25.81	56.00	-30.19	QP	LINE
10	3.29	-2.01	9.64	0.58	9.78	17.99	46.00	-28.01	Average	LINE
11	17.11	10.13	9.84	0.34	9.90	30.21	60.00	-29.79	QP	LINE
12	17.11	3.41	9.84	0.34	9.90	23.49	50.00	-26.51	Average	LINE

Note:

1. Result Level = Read Level + LISN Factor + Pulse Limiter Factor + Cable loss.
2. If QP Result complies with AV limit, AV Result is deemed to comply with AV limit.
3. Test setup: RBW: 200 Hz (9 kHz—150 kHz), 9 kHz (150 kHz—30 MHz).
4. Step size: 80Hz (0.009MHz-0.15MHz), 4 kHz (0.15MHz-30MHz), Scan time: auto.

## 16. Photos of the EUT

Please refer to DDT-Q24081509-2E appendix I

-----End Report-----