



■ Report No.:DDT-R22051226-2E02

■ Issued Date: Jun. 06, 2022

FCC AND ISED CERTIFICATION TEST REPORT

FOR

| | | |
|-----------------------------|---|---|
| Applicant | : | Harman International Industries, Inc. |
| Address | : | 8500 Balboa Boulevard, Northridge, CA 91329, UNITED STATES |
| Equipment under Test | : | PORTABLE BLUETOOTH SPEAKER |
| Model No. | : | CHARGE ESSENTIAL 2 |
| Trade Mark | : | JBL |
| FCC ID | : | APICHARGEETL2 |
| IC | : | 6132A-CHARGEETL2 |
| Manufacturer | : | Harman International Industries, Inc. |
| Address | : | 8500 Balboa Boulevard, Northridge, CA 91329, UNITED STATES |

Issued By: Dongguan Dongdian Testing Service Co., Ltd.

Add.: No. 17, Zongbu Road 2, Songshan Lake Sci&Tech, Industry Park,
Dongguan City, Guangdong Province, China, 523808

Tel.: +86-0769-38826678, **E-mail:** ddt@dgddt.com, <http://www.dgddt.com>

REPORT

Table of Contents

| | | |
|------|--|----|
| | Test report declares..... | 3 |
| 1. | Summary of Test Results..... | 5 |
| 2. | General Test Information | 6 |
| 2.1. | Description of EUT | 6 |
| 2.2. | Accessories of EUT..... | 7 |
| 2.3. | Assistant equipment used for test..... | 7 |
| 2.4. | Block diagram of EUT configuration for test..... | 7 |
| 2.5. | Test environment conditions | 7 |
| 2.6. | Deviations of test standard..... | 7 |
| 2.7. | Test laboratory | 8 |
| 2.8. | Measurement uncertainty..... | 8 |
| 3. | Equipment Used During Test..... | 9 |
| 4. | Radiated Emission | 10 |
| 4.1. | Block diagram of test setup..... | 10 |
| 4.2. | Limit | 11 |
| 4.3. | Test Procedure..... | 13 |
| 4.4. | Test result..... | 14 |
| 5. | Power Line Conducted Emission..... | 17 |
| 5.1. | Block diagram of test setup..... | 17 |
| 5.2. | Power line conducted emission limits | 17 |
| 5.3. | Test procedure | 17 |
| 5.4. | Test result..... | 18 |
| 6. | Test Setup Photograph | 21 |
| 7. | Photos of the EUT | 23 |

Test Report Declare

| | | |
|-----------------------------|---|--|
| Applicant | : | Harman International Industries, Inc. |
| Address | : | 8500 Balboa Boulevard, Northridge, CA 91329, UNITED STATES |
| Equipment under Test | : | PORTABLE BLUETOOTH SPEAKER |
| Model No. | : | CHARGE ESSENTIAL 2 |
| Trade Mark | : | JBL |
| Manufacturer | : | Harman International Industries, Inc. |
| Address | : | 8500 Balboa Boulevard, Northridge, CA 91329, UNITED STATES |

Test Standard Used:

FCC Rules and Regulations Part 15 Subpart C, RSS-247 Issue 2 February 2017.

Test Procedure Used:

ANSI C63.10:2013, RSS-Gen Issue 5, Apr. 2018, Amendment 2 (February 2021)

We Declare:

The equipment described above is tested by Dongguan Dongdian Testing Service Co., Ltd. and in the configuration tested the equipment complied with the standards specified above. The test results are contained in this test report and Dongguan Dongdian Testing Service Co., Ltd. is assumed of full responsibility for the accuracy and completeness of these tests.

After test and evaluation, our opinion is that the equipment provided for test compliance with the requirement of the above FCC&ISED standards.

| | | | |
|-------------------------|--------------------|----------------------|------------------------------|
| Report No.: | DDT-R22051226-2E02 | | |
| Date of Receipt: | May 19, 2022 | Date of Test: | May 19, 2022 ~ Jun. 06, 2022 |

Prepared By:

Ella Gong

Ella Gong/Engineer

Approved By:



Damon Hu/EMC Manager

Note: This report applies to above tested sample only. This report shall not be reproduced in parts without written approval of Dongguan Dongdian Testing Service Co., Ltd.

Revision History

| Rev. | Revisions | Issue Date | Revised By |
|------|---------------|---------------|------------|
| --- | Initial issue | Jun. 06, 2022 | |
| | | | |

1. Summary of Test Results

| The EUT have been tested according to the applicable standards as referenced below. | | |
|---|---|---------|
| Description of Test Item | Standard | Verdict |
| Radiation Emission | FCC Part 15: 15.247 ANSI C63.10:2013 RSS-247 Issue 2 RSS-Gen Issue 5 | Pass |
| Power Line Conducted Emission | FCC Part 15: 15.207 ANSI C63.10: 2013 RSS-Gen Issue 5 | Pass |

Note:

a. This report added the CR for IC's 2nd source for alternative use on the basis of the report DDT-R21052516-2E02, this change based on engineering judgment that only Radiated Emission (below 1 GHz) and Power Line Conducted Emissions need to test.

b. Please refer to report DDT-R21052516-2E02 for the other original data.

| Description of specific changes | | | |
|---------------------------------|----------------|---|--|
| Component | First source | Second source | Mark |
| BT Module | JINGXUN: JX268 | JINGXUN: JX268-new assembly house Hua Tian | only change assembly house, no layout and SW changed |
| Logic IC | SLG4V44057 | LS4V44057V | no layout changed but need to change SW |
| OP IC | TI: TLV9062 | DIO:DZ002 | need to change layout but no SW changed |
| DCDC IC | Silergy:SY7069 | DIO: DIO6099 | need to change layout but no SW changed |

2. General Test Information

2.1. Description of EUT

| | |
|--------------------------|---|
| EUT* Name | : PORTABLE BLUETOOTH SPEAKER |
| Model Number | : CHARGE ESSENTIAL 2 |
| EUT Function Description | : Please reference user manual of this device |
| Power Supply | : DC 5V from external AC Adapter DC 3.6V Polymer Li-ion built-in battery |
| Radio Specification | : Bluetooth V5.1 |
| Operation Frequency | : 2402 MHz - 2480 MHz |
| Modulation | : GFSK |
| Data Rate | : 1 Mbps |
| Antenna Type | : FPC antenna, maximum PK gain: 2.65 dBi |
| Sample Number | : S22051226-15 |

Note: EUT is the ab. of equipment under test.

| Channel information | | | | | |
|---------------------|-----------------|---------|-----------------|---------|-----------------|
| Channel | Frequency (MHz) | Channel | Frequency (MHz) | Channel | Frequency (MHz) |
| 0 | 2402 | 14 | 2430 | 28 | 2458 |
| 1 | 2404 | 15 | 2432 | 29 | 2460 |
| 2 | 2406 | 16 | 2434 | 30 | 2462 |
| 3 | 2408 | 17 | 2436 | 31 | 2464 |
| 4 | 2410 | 18 | 2438 | 32 | 2466 |
| 5 | 2412 | 19 | 2440 | 33 | 2468 |
| 6 | 2414 | 20 | 2442 | 34 | 2470 |
| 7 | 2416 | 21 | 2444 | 35 | 2472 |
| 8 | 2418 | 22 | 2446 | 36 | 2474 |
| 9 | 2420 | 23 | 2448 | 37 | 2476 |
| 10 | 2422 | 24 | 2450 | 38 | 2478 |
| 11 | 2424 | 25 | 2452 | 39 | 2480 |
| 12 | 2426 | 26 | 2454 | | |
| 13 | 2428 | 27 | 2456 | | |

2.2. Accessories of EUT

| Description of Accessories | Manufacturer | Model number | Description | Remark |
|----------------------------|--------------|--------------|-------------|--------------------------|
| Type-C Cable | Harman | N/A | N/A | Length: 1.2m, unshielded |

2.3. Assistant equipment used for test

| Assistant equipment | Manufacturer | Model number | EMC Compliance | SN |
|---------------------|--------------|--------------|--|-----|
| Adapter | SAMSUNG | EP-TA200 | Input: 100-240~, 50/60Hz, 0.5A; Output: 9V/1.67A or 5V/2A | N/A |

2.4. Block diagram of EUT configuration for test

EUT

Test software: Zgmicro Bluetooth Authentication Tool V2.3.125.658

The test software was used to control EUT work in Continuous Tx mode, and select test channel, wireless mode as below table:

The pathloss of external cable: 0.5dB (According to the manufacturer's claims)

| Tested mode, channel, information | | | |
|-----------------------------------|------------------|---------|-----------------|
| Mode | Setting Tx Power | Channel | Frequency (MHz) |
| GFSK | / | CH0 | 2402 |
| | / | CH19 | 2440 |
| | / | CH39 | 2480 |

2.5. Test environment conditions

During the measurement the environmental conditions were within the listed ranges:

| | |
|--------------------|------------|
| Temperature range: | 21-25 °C |
| Humidity range: | 40-75% |
| Pressure range: | 86-106 kPa |

2.6. Deviations of test standard

No deviation.

2.7. Test laboratory

Dongguan Dongdian Testing Service Co., Ltd.

Add.: No. 17, Zongbu Road 2, Songshan Lake Sci&Tech, Industry Park, Dongguan City, Guangdong Province, China, 523808.

Tel.: +86-0769-38826678, <http://www.dgddt.com>, Email: ddt@dgddt.com.

CNAS Accreditation No. L6451; A2LA Accreditation Number: 3870.01

FCC Designation Number: CN1182, Test Firm Registration Number: 540522

Innovation, Science and Economic Development Canada Site Registration Number: 10288A

Conformity Assessment Body identifier: CN0048

VCCI facility registration number: C-20087, T-20088, R-20123, G-20118

2.8. Measurement uncertainty

| Test Item | Uncertainty |
|---|--|
| Bandwidth | 1.1% |
| Peak Output Power (Conducted) (Spectrum analyzer) | 0.86 dB (10 MHz ≤ f < 3.6 GHz); |
| | 1.38 dB (3.6 GHz ≤ f < 8 GHz) |
| Peak Output Power (Conducted) (Power Sensor) | 0.74 dB |
| Power Spectral Density | 0.74 dB (10 MHz ≤ f < 3.6 GHz); |
| | 1.38 dB (3.6 GHz ≤ f < 8 GHz) |
| Frequencies Stability | 6.7 × 10 ⁻⁸ (Antenna couple method) |
| | 5.5 × 10 ⁻⁸ (Conducted method) |
| Conducted spurious emissions | 0.86 dB (10 MHz ≤ f < 3.6 GHz); |
| | 1.40 dB (3.6 GHz ≤ f < 8 GHz) |
| | 1.66 dB (8 GHz ≤ f < 22 GHz) |
| Uncertainty for radio frequency (RBW < 20 kHz) | 3×10 ⁻⁸ |
| Temperature | 0.4 °C |
| Humidity | 2 % |
| Uncertainty for Radiation Emission test (30 MHz - 1 GHz) | 4.70 dB (Antenna Polarize: V) |
| | 4.84 dB (Antenna Polarize: H) |
| Uncertainty for Radiation Emission test (1 GHz - 40 GHz) | 4.10 dB (1 - 6 GHz) |
| | 4.40 dB (6 GHz - 18 GHz) |
| | 3.54 dB (18 GHz - 26 GHz) |
| | 4.30 dB (26 GHz - 40 GHz) |
| Uncertainty for Power line conduction emission test | 3.32 dB (150 kHz - 30 MHz) |
| Note: This uncertainty represents an expanded uncertainty expressed at approximately the 95% confidence level using a coverage factor of k=2. | |

3. Equipment Used During Test

| Equipment | Manufacturer | Model No. | Serial No. | Last Cal. | Cal. Interval |
|--|--------------|-----------|------------|---------------|---------------|
| ☑Radiation 3#chamber | | | | | |
| EMI Test Receiver | R&S | ESU | 100472 | May 18, 2022 | 1 Year |
| Spectrum analyzer | Agilent | E4447A | MY50180031 | May 18, 2022 | 1 Year |
| Active Loop antenna | Schwarzbeck | FMZB-1519 | 1519-038 | Sep. 19, 2021 | 1 Year |
| Trilog Broadband Antenna | Schwarzbeck | VULB 9163 | 01429 | Aug. 07, 2021 | 1 Year |
| Double Ridged Horn Antenna | Schwarzbeck | BBHA9120 | 02468 | Nov. 17, 2021 | 1 Year |
| Broad Band Horn Antenna | Schwarzbeck | BBHA 9170 | 790 | May 06, 2022 | 1 Year |
| Pre-amplifier | COM-POWER | PAM-118A | 18040084 | Sep. 02, 2021 | 1 Year |
| Pre-amplifier | COM-POWER | PAM-840A | 461369 | Apr. 11, 2022 | 1 Year |
| Test software | Audix | E3 | V 6.1.1.1 | N/A | N/A |
| ☑Power Line Conducted Emissions Test 1# | | | | | |
| Test Receiver | R&S | ESCI | 100551 | Sep. 02, 2021 | 1 Year |
| LISN 1 | R&S | ENV216 | 101109 | Sep. 02, 2021 | 1 Year |
| LISN 2 | R&S | ESH2-Z5 | 100309 | Sep. 02, 2021 | 1 Year |
| Pulse Limiter | R&S | ESH3-Z2 | 101242 | Sep. 02, 2021 | 1 Year |
| CE Cable 1 | HUBSER | N/A | W10.01 | Sep. 02, 2021 | 1 Year |
| LISN 3 | SCHWARZBECK | NSLK 8163 | 00017 | Sep. 02, 2021 | 1 Year |
| Test software | Audix | E3 | V 6.11111b | N/A | N/A |

4. Radiated Emission

4.1. Block diagram of test setup

In 3 m Anechoic Chamber, test setup diagram for 9 kHz - 30 MHz:

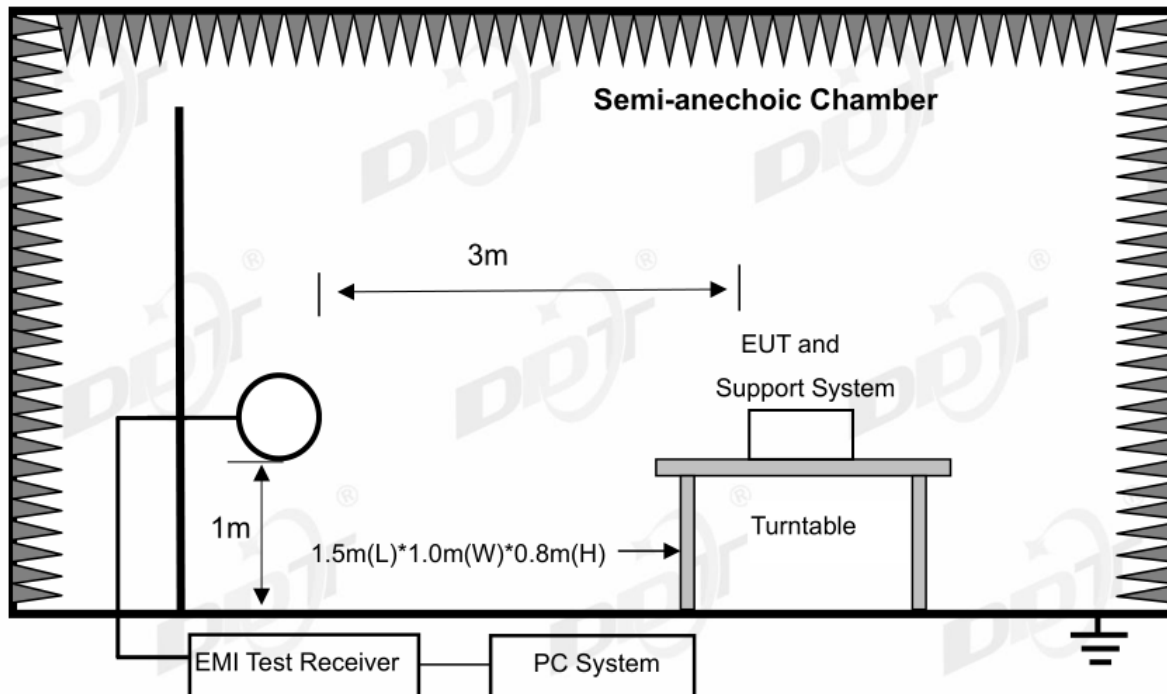

In 3 m Anechoic Chamber, test setup diagram for 30 MHz - 1 GHz:

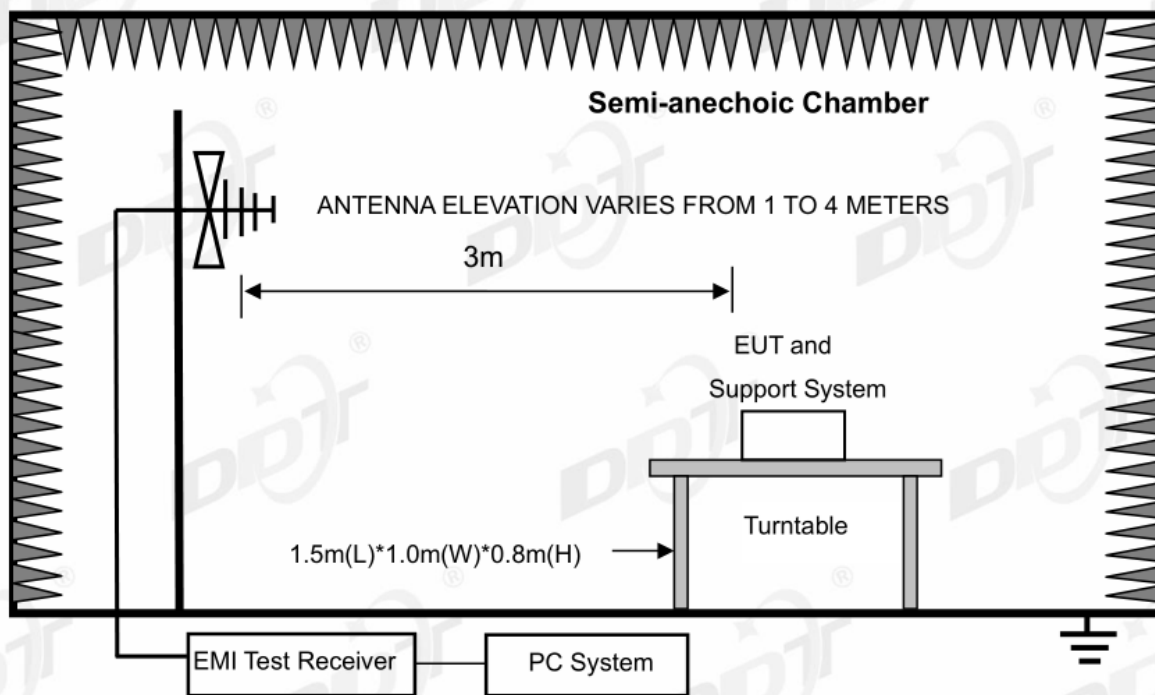

In 3 m Anechoic Chamber, test setup diagram for frequency above 1 GHz:

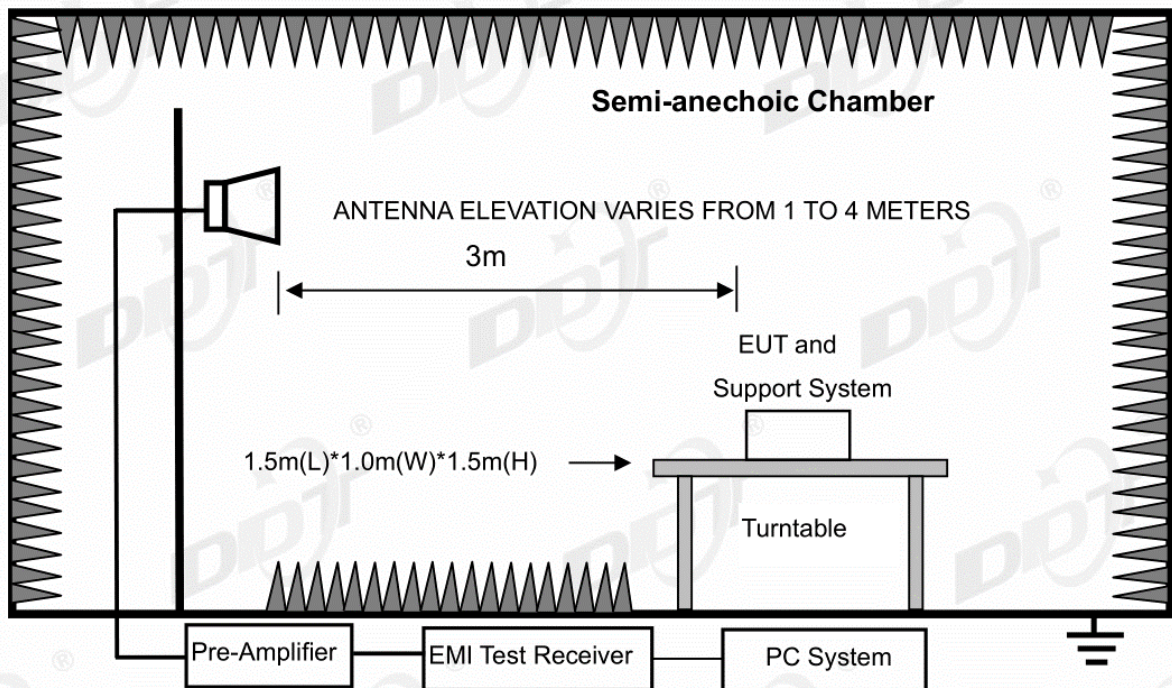

Note: For harmonic emissions test an appropriate high pass filter was inserted in the input port of AMP.

4.2. Limit

(1) FCC 15.205 Restricted frequency band

| MHz | MHz | MHz | GHz |
|--------------------------|---------------------|---------------|------------------|
| 0.090-0.110 | 16.42-16.423 | 399.9-410 | 4.5-5.15 |
| ¹ 0.495-0.505 | 16.69475-16.69525 | 608-614 | 5.35-5.46 |
| 2.1735-2.1905 | 16.80425-16.80475 | 960-1240 | 7.25-7.75 |
| 4.125-4.128 | 25.5-25.67 | 1300-1427 | 8.025-8.5 |
| 4.1772&4.17775 | 37.5-38.25 | 1435-1626.5 | 9.0-9.2 |
| 4.2072&4.20775 | 73-74.6 | 1645.5-1646.5 | 9.3-9.5 |
| 6.215-6.218 | 74.8-75.2 | 1660-1710 | 10.6-12.7 |
| 6.26775-6.26825 | 108-121.94 | 1718.8-1722.2 | 13.25-13.4 |
| 6.31175-6.31225 | 123-138 | 2200-2300 | 14.47-14.5 |
| 8.291-8.294 | 149.9-150.05 | 2310-2390 | 15.35-16.2 |
| 8.362-8.366 | 156.52475-156.52525 | 2483.5-2500 | 17.7-21.4 |
| 8.37625-8.38675 | 156.7-156.9 | 2690-2900 | 22.01-23.12 |
| 8.41425-8.41475 | 162.0125-167.17 | 3260-3267 | 23.6-24.0 |
| 12.29-12.293 | 167.72-173.2 | 3332-3339 | 31.2-31.8 |
| 12.51975-12.52025 | 240-285 | 3345.8-3358 | 36.43-36.5 |
| 12.57675-12.57725 | 322-335.4 | 3600-4400 | (²) |
| 13.36-13.41 | | | |

¹Until February 1, 1999, this restricted band shall be 0.490-0.510 MHz.

²Above 38.6

RSS-Gen section 8.10 Restricted frequency bands*

| MHz | MHz | MHz | GHz |
|-----------------|---------------------|---------------|-------------|
| 0.090-0.110 | 12.51975-12.52025 | 240-285 | 3.5-4.4 |
| 0.495-0.505 | 12.57675-12.57725 | 322-335.4 | 4.5-5.15 |
| 2.1735-2.1905 | 13.36-13.41 | 399.9-410 | 5.35-5.46 |
| 3.020-3.026 | 16.42-16.423 | 608-614 | 7.25-7.75 |
| 4.125-4.128 | 16.69475-16.69525 | 960-1427 | 8.025-8.5 |
| 4.1772&4.17775 | 16.80425-16.80475 | 1435-1626.5 | 9.0-9.2 |
| 4.2072&4.20775 | 25.5-25.67 | 1645.5-1646.5 | 9.3-9.5 |
| 5.677-5.683 | 37.5-38.25 | 1660-1710 | 10.6-12.7 |
| 6.215-6.218 | 73-74.6 | 1718.8-1722.2 | 13.25-13.4 |
| 6.26775-6.26825 | 74.8-75.2 | 2200-2300 | 14.47-14.5 |
| 6.31175-6.31225 | 108-138 | 2310-2390 | 15.35-16.2 |
| 8.291-8.294 | 149.9-150.05 | 2483.5-2500 | 17.7-21.4 |
| 8.362-8.366 | 156.52475-156.52525 | 2655-2900 | 22.01-23.12 |
| 8.37625-8.38675 | 156.7-156.9 | 3260-3267 | 23.6-24.0 |
| 8.41425-8.41475 | 162.0125-167.17 | 3332-3339 | 31.2-31.8 |
| 12.29-12.293 | 167.72-173.2 | 3345.8-3358 | 36.43-36.5 |
| | | | Above 38.6 |

* Certain frequency bands listed in table 7 and in bands above 38.6 GHz are designated for licence-exempt applications. These frequency bands and the requirements that apply to related devices are set out in the 200 and 300 series of RSSs.

(2) FCC 15.209 Limit & RSS-Gen section 8.9 Limit

| FREQUENCY MHz | DISTANCE Meters | FIELD STRENGTHS LIMIT | |
|------------------|--------------------|---|-----------------------------------|
| | | $\mu\text{V}/\text{m}$ | $\text{dB}(\mu\text{V})/\text{m}$ |
| 0.009 ~ 0.490 | 300 | 2400/F(kHz) | 67.6-20log(F) |
| 0.490 ~ 1.705 | 30 | 24000/F(kHz) | 87.6-20log(F) |
| 1.705 ~ 30.0 | 30 | 30 | 29.54 |
| 30 ~ 88 | 3 | 100 | 40.0 |
| 88 ~ 216 | 3 | 150 | 43.5 |
| 216 ~ 960 | 3 | 200 | 46.0 |
| 960 ~ 1000 | 3 | 500 | 54.0 |
| Above 1000 | 3 | 74.0 dB(μV)/m (Peak) 54.0 dB(μV)/m (Average) | |

Note: (1) The emission limits shown in the above table are based on measurements employing a CISPR QP detector except for the frequency bands 9 - 90 kHz, 110 - 490 kHz and above 1000 MHz. Radiated emissions limits in these three bands are based on measurements employing an average detector.

(2) At frequencies below 30 MHz, measurement may be performed at a distance closer than that specified, and the limit at closer measurement distance can be extrapolated by below formula:

$$\text{Limit}_{3\text{m}}(\text{dB}\mu\text{V}/\text{m}) = \text{Limit}_{30\text{m}}(\text{dB}\mu\text{V}/\text{m}) + 40\text{Log}(30\text{m}/3\text{m})$$

(3) Limit for this EUT

The emissions appearing within 15.205 restricted frequency bands shall not exceed the limits shown in 15.209, and the emissions appearing within RSS-Gen section 8.10 Restricted frequency bands shall not exceed the limits shown in RSS-Gen section 8.9, all the other emissions shall be at least 20 dB below the fundamental emissions or comply with 15.209 limits and RSS-Gen section 8.9 limits.

4.3. Test Procedure

- (1) EUT was placed on a non-metallic table, 80 cm above the ground plane inside a semi-anechoic chamber for below 1 G and 150 cm above the ground plane inside a semi-anechoic chamber for above 1 G.
- (2) Test antenna was located 3 m from the EUT on an adjustable mast, and the antenna used as below table.

| Test frequency range | Test antenna used | Test antenna distance |
|----------------------|--|-----------------------|
| 9 kHz - 30 MHz | Active Loop antenna | 3 m |
| 30 MHz - 1 GHz | Trilog Broadband Antenna | 3 m |
| 1 GHz - 18 GHz | Double Ridged Horn Antenna (1 GHz - 18 GHz) | 3 m |
| 18 GHz - 40 GHz | Horn Antenna (18 GHz - 40 GHz) | 1 m |

According to ANSI C63.10:2013 clause 6.4.4.2 and 6.5.3, for measurements below 30 MHz, the loop antenna was positioned with its plane vertical from the EUT and rotated about its vertical axis for maximum response at each azimuth position around the EUT. And the loop antenna also is positioned with its plane horizontal at the specified distance from the EUT. The center of the loop is 1 m above the ground. For measurement above 30 MHz, the Trilog Broadband Antenna or Horn Antenna was located 3 m from EUT, Measurements were made with the antenna positioned in both the horizontal and vertical planes of Polarization, and the measurement antenna was varied from 1 m to 4 m. in height above the reference ground plane to obtain the maximum signal strength.

- (3) Below pre-scan procedure was first performed in order to find prominent frequency spectrum radiated emissions from 9 kHz to 25 GHz:

- (a) Scanning the peak frequency spectrum with the antenna specified in step (3), and the EUT was rotated 360 degree, the antenna height was varied from 1 m to 4 m (Except loop antenna, it's fixed 1 m above ground.)

- (b) Change work frequency or channel of device if practicable.

- (c) Change modulation type of device if practicable.

- (d) Change power supply range from 85% to 115% of the rated supply voltage

- (e) Rotated EUT through three orthogonal axes to determine the attitude of EUT arrangement produces highest emissions.

Spectrum frequency from 9 kHz to 25 GHz (tenth harmonic of fundamental frequency) was investigated, and no any obvious emission were detected from 9 kHz to 30 MHz and 18 GHz

to 25 GHz, so below final test was performed with frequency range from 30 MHz to 18 GHz.

- (4) For final emissions measurements at each frequency of interest, the EUT was rotated and the antenna height was varied between 1 m and 4 m in order to maximize the emission. Measurements in both horizontal and vertical polarities were made and the data was recorded. In order to find the maximum emission, the relative positions of equipments and all of the interface cables were changed according to ANSI C63.10:2013 on Radiated Emission test.
- (5) The emissions from 9 kHz to 1 GHz were measured based on CISPR QP detector except for the frequency bands 9 - 90 kHz, 110 - 490 kHz, for emissions from 9 kHz - 90 kHz, 110 kHz - 490 kHz and above 1 GHz were measured based on average detector, for emissions above 1 GHz, peak emissions also be measured and need comply with Peak limit.
- (6) The emissions from 9 kHz to 1 GHz, QP or average values were measured with EMI receiver with below RBW

| Frequency band | RBW |
|------------------|---------|
| 9 kHz - 150 kHz | 200 Hz |
| 150 kHz - 30 MHz | 9 kHz |
| 30 MHz - 1 GHz | 120 kHz |

- (7) For emissions above 1 GHz, both Peak and Average level were measured with Spectrum Analyzer, and the RBW is set at 1 MHz, VBW is set at 3 MHz for Peak measure; According ANSI C63.10:2013 clause 4.1.4.2.2 procedure for average measure.
- (8) X axis, Y axis, Z axis are tested, and worse setup X axis is reported.

4.4. Test result

Pass. (See below detailed test result)

All the emissions except fundamental emission from 9 kHz to 25 GHz were comply with 15.209 limit.

Note1: According exploratory test, the emission levels are 20 dB below the limit detected from 9 kHz to 30 MHz and 18 GHz to 25 GHz, so the final test was performed with frequency range from 30 MHz to 18 GHz and recorded in below.

Note2: For emissions below 1 GHz, according exploratory explorer test, when change Tx mode and channel, have no distinct influence on emissions level, so for emissions below 1 GHz, the final test was only performed with EUT working in Tx 2402 MHz mode.

Note3: For emissions above 1 GHz. If peak results comply with AV limit, AV Result is deemed to comply with AV limit.

Radiated Emission test (below 1 GHz)

TR-4-E-009 Radiated Emission Test Result

Test Site : DDT 3m Chamber 3#

D:\E3 6.111\2022 Report Data\Q22051226-2E CHARGE
ESSENTIAL 2\FCC BELOW 1G.EM6

Test Date : 2022-06-02

Tested By : James Gan

EUT : PORTABLE BLUETOOTH SPEAKER

Model Number : CHARGE ESSENTIAL 2

Power Supply : Battery

Test Mode : Tx Mode

Condition : Temp:23.4°C,Humi:57.7%,Press:100.3kPa

Antenna/Distance : 2021 VLUB 9163 #3/3m/HORIZONTAL

Memo : BLE

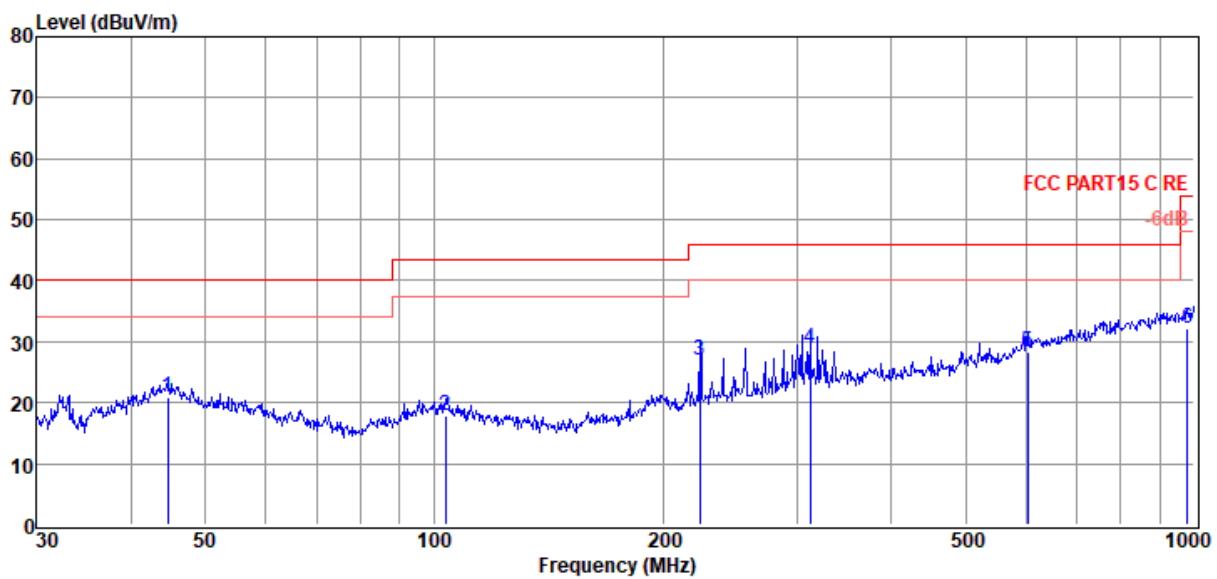

| Item (Mark) | Freq. (MHz) | Read Level (dB μ V) | Antenna Factor (dB/m) | Cable Loss (dB) | Result Level (dB μ V/m) | Limit Line (dB μ V/m) | Over Limit (dB) | Detector | Polarization |
|-------------|-------------|-------------------------|-----------------------|-----------------|-----------------------------|---------------------------|-----------------|----------|--------------|
| 1 | 44.59 | 2.21 | 15.06 | 3.64 | 20.91 | 40.00 | -19.09 | QP | HORIZONTAL |
| 2 | 103.44 | 2.33 | 11.41 | 4.00 | 17.74 | 43.50 | -25.76 | QP | HORIZONTAL |
| 3 | 223.73 | 10.74 | 11.70 | 4.55 | 26.99 | 46.00 | -19.01 | QP | HORIZONTAL |
| 4 | 312.18 | 10.62 | 13.49 | 4.87 | 28.98 | 46.00 | -17.02 | QP | HORIZONTAL |
| 5 | 603.54 | 3.47 | 19.17 | 5.75 | 28.39 | 46.00 | -17.61 | QP | HORIZONTAL |
| 6 | 979.18 | 3.18 | 22.30 | 6.73 | 32.21 | 54.00 | -21.79 | QP | HORIZONTAL |

Note: 1. Result Level = Read Level + Antenna Factor + Cable loss.

2. If Peak Result complies with QP limit, QP Result is deemed to comply with QP limit.

3. Test setup: RBW: 120 kHz, VBW: 300 kHz, Sweep time: auto.

TR-4-E-009 Radiated Emission Test Result

Test Site : DDT 3m Chamber 3# D:\E3 6.111\2022 Report Data\Q22051226-2E CHARGE ESSENTIAL 2\FCC BELOW 1G.EM6
Test Date : 2022-06-02 **Tested By** : James Gan
EUT : PORTABLE BLUETOOTH SPEAKER **Model Number** : CHARGE ESSENTIAL 2
Power Supply : Battery **Test Mode** : Tx Mode
Condition : Temp:23.4°C,Humi:57.7%,Press:100.3kPa **Antenna/Distance** : 2021 VLUB 9163 #3/3m/VERTICAL
Memo : BLE

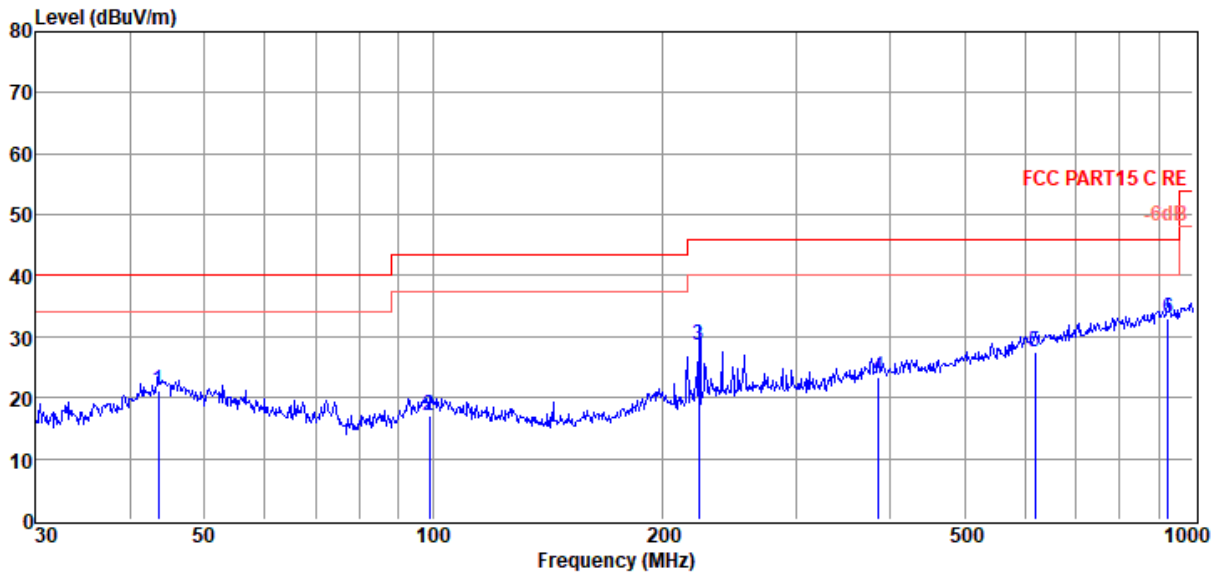

| Item (Mark) | Freq. (MHz) | Read Level (dBuV) | Antenna Factor (dB/m) | Cable Loss (dB) | Result Level (dBuV/m) | Limit Line (dBuV/m) | Over Limit (dB) | Detector | Polarization |
|-------------|-------------|-------------------|-----------------------|-----------------|-----------------------|---------------------|-----------------|----------|--------------|
| 1 | 43.51 | 2.88 | 14.71 | 3.64 | 21.23 | 40.00 | -18.77 | QP | VERTICAL |
| 2 | 98.83 | 1.54 | 11.50 | 3.97 | 17.01 | 43.50 | -26.49 | QP | VERTICAL |
| 3 | 223.73 | 12.45 | 11.70 | 4.55 | 28.70 | 46.00 | -17.30 | QP | VERTICAL |
| 4 | 385.28 | 3.12 | 15.11 | 5.11 | 23.34 | 46.00 | -22.66 | QP | VERTICAL |
| 5 | 618.54 | 2.56 | 19.03 | 5.79 | 27.38 | 46.00 | -18.62 | QP | VERTICAL |
| 6 | 925.76 | 4.02 | 22.40 | 6.53 | 32.95 | 46.00 | -13.05 | QP | VERTICAL |

Note: 1. Result Level = Read Level + Antenna Factor + Cable loss.
 2. If Peak Result complies with QP limit, QP Result is deemed to comply with QP limit.
 3. Test setup: RBW: 120 kHz, VBW: 300 kHz, Sweep time: auto.

5. Power Line Conducted Emission

5.1. Block diagram of test setup

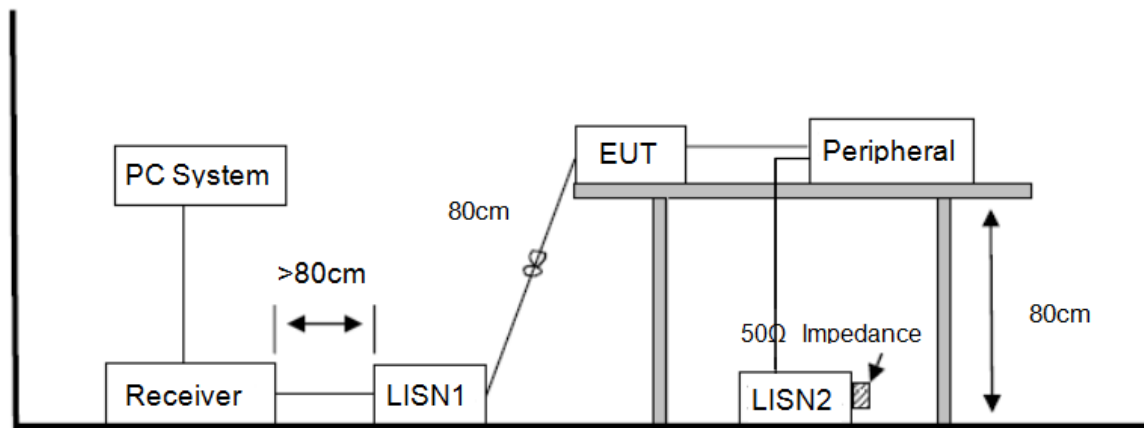

5.2. Power line conducted emission limits

| Frequency | Quasi-Peak Level dB(μ V) | Average Level dB(μ V) |
|-------------------|----------------------------------|-------------------------------|
| 150 kHz ~ 500 kHz | 66 ~ 56* | 56 ~ 46* |
| 500 kHz ~ 5 MHz | 56 | 46 |
| 5 MHz ~ 30 MHz | 60 | 50 |

Note 1: * Decreasing linearly with logarithm of frequency.

Note 2: The lower limit shall apply at the transition frequencies.

5.3. Test procedure

The EUT and Support equipment, if needed, were put placed on a non-metallic table, 80 cm above the ground plane.

Configuration EUT to simulate typical usage as described in clause 2.4 and test equipment as described in clause 10.2 of this report.

All I/O cables were positioned to simulate typical actual usage as per ANSI C63.10.

All support equipment power received from a second LISN.

Emissions were measured on each current carrying line of the EUT using an EMI Test Receiver connected to the LISN powering the EUT.

The Receiver scanned from 150 kHz to 30 MHz for emissions in each of the test modes.

During the above scans, the emissions were maximized by cable manipulation.

The test mode(s) described in clause 2.4 were scanned during the preliminary test.

After the preliminary scan, we found the test mode producing the highest emission level.

The EUT configuration and worse cable configuration of the above highest emission levels were recorded for reference of the final test.

EUT and support equipment were set up on the test bench as per the configuration with highest

emission level in the preliminary test.

A scan was taken on both power lines, Neutral and Line, recording at least the six highest emissions.

Emission frequency and amplitude were recorded into a computer in which correction factors were used to calculate the emission level and compare reading to the applicable limit.

The test data of the worst-case condition(s) was recorded.

The bandwidth of test receiver is set at 9 kHz.

5.4. Test result

Pass. (See below detailed test result)

Note1: All emissions not reported below are too low against the prescribed limits.

Note2: "----" means Peak detection; "----" means Average detection.

Note3: Pre-test AC conducted emission at both voltage AC 120V/60Hz and AC 240V/50Hz, recorded the worst case.

TR-4-E-010 Conducted Emission Test Result

Test Site : DDT 1# Shield Room D:\2022 CE report date\Q22051226-2E\FCC.EM6
Test Date : 2022-06-02 **Tested By** : James Gan
EUT : PORTABLE BLUETOOTH SPEAKER **Model Number** : CHARGE ESSENTIAL 2
Power Supply : AC 120V/60Hz **Test Mode** : TX
Condition : TEMP:24.3°C, RH:53.0%, BP:101.0kPa **LISN** : 2021 1# ENV216/LINE
Memo : BLE

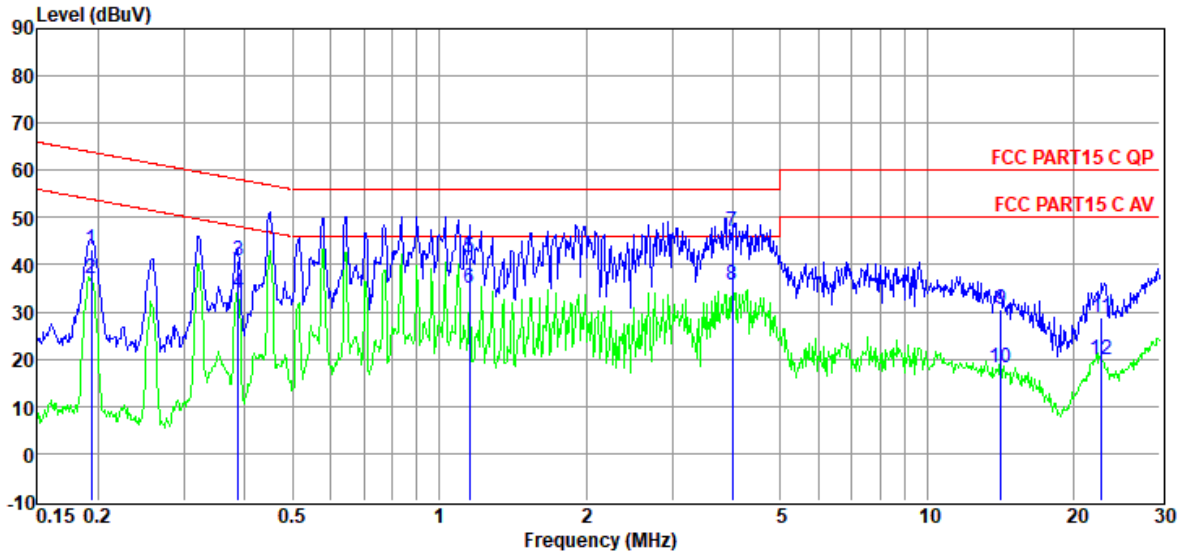

| Item (Mark) | Freq. (MHz) | Read Level (dBuV) | LISN Factor (dB) | Cable Loss (dB) | Pulse Limiter Factor (dB) | Result Level (dBuV) | Limit Line (dBuV) | Over Limit (dB) | Detector | Phase |
|-------------|-------------|-------------------|------------------|-----------------|---------------------------|---------------------|-------------------|-----------------|----------|-------|
| 1 | 0.19 | 23.61 | 9.78 | 0.01 | 9.92 | 43.32 | 63.89 | -20.57 | QP | LINE |
| 2 | 0.19 | 17.20 | 9.78 | 0.01 | 9.92 | 36.91 | 53.89 | -16.98 | Average | LINE |
| 3 | 0.39 | 21.18 | 9.66 | 0.02 | 9.91 | 40.77 | 58.12 | -17.35 | QP | LINE |
| 4 | 0.39 | 14.40 | 9.66 | 0.02 | 9.91 | 33.99 | 48.12 | -14.13 | Average | LINE |
| 5 | 1.15 | 22.07 | 9.58 | 0.03 | 9.89 | 41.57 | 56.00 | -14.43 | QP | LINE |
| 6 | 1.15 | 15.59 | 9.58 | 0.03 | 9.89 | 35.09 | 46.00 | -10.91 | Average | LINE |
| 7 | 3.99 | 27.57 | 9.60 | 0.06 | 9.92 | 47.15 | 56.00 | -8.85 | QP | LINE |
| 8 | 3.99 | 16.22 | 9.60 | 0.06 | 9.92 | 35.80 | 46.00 | -10.20 | Average | LINE |
| 9 | 14.14 | 10.67 | 9.76 | 0.14 | 9.93 | 30.50 | 60.00 | -29.50 | QP | LINE |
| 10 | 14.14 | -1.56 | 9.76 | 0.14 | 9.93 | 18.27 | 50.00 | -31.73 | Average | LINE |
| 11 | 22.78 | 8.88 | 9.63 | 0.18 | 9.97 | 28.66 | 60.00 | -31.34 | QP | LINE |
| 12 | 22.78 | 0.25 | 9.63 | 0.18 | 9.97 | 20.03 | 50.00 | -29.97 | Average | LINE |

Note:

1. Result Level = Read Level + LISN Factor + Pulse Limiter Factor + Cable loss.
2. If QP Result complies with AV limit, AV Result is deemed to comply with AV limit.
3. Test setup: RBW: 200 Hz (9 kHz—150 kHz), 9 kHz (150 kHz—30 MHz).
4. Step size: 80Hz (0.009MHz-0.15MHz), 4 kHz (0.15MHz-30MHz), Scan time: auto.

TR-4-E-010 Conducted Emission Test Result

Test Site : DDT 1# Shield Room D:\2022 CE report date\Q22051226-2E\FCC.EM6
Test Date : 2022-06-02 **Tested By** : James Gan
EUT : PORTABLE BLUETOOTH SPEAKER **Model Number** : CHARGE ESSENTIAL 2
Power Supply : AC 120V/60Hz **Test Mode** : TX
Condition : TEMP:24.3°C, RH:53.0%, BP:101.0kPa **LISN** : 2021 1# ENV216/NEUTRAL
Memo : BLE

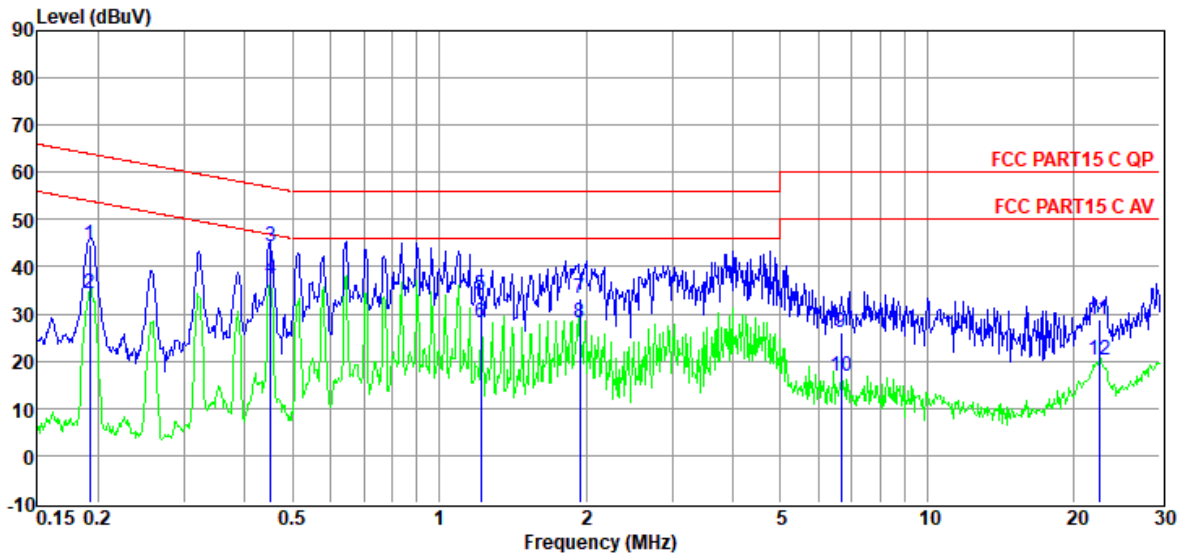

| Item (Mark) | Freq. (MHz) | Read Level (dBμV) | LISN Factor (dB) | Cable Loss (dB) | Pulse Limiter Factor (dB) | Result Level (dBμV) | Limit Line (dBμV) | Over Limit (dB) | Detector | Phase |
|-------------|-------------|-------------------|------------------|-----------------|---------------------------|---------------------|-------------------|-----------------|----------|---------|
| 1 | 0.19 | 25.02 | 9.80 | 0.01 | 9.92 | 44.75 | 63.93 | -19.18 | QP | NEUTRAL |
| 2 | 0.19 | 14.60 | 9.80 | 0.01 | 9.92 | 34.33 | 53.93 | -19.60 | Average | NEUTRAL |
| 3 | 0.45 | 24.77 | 9.53 | 0.02 | 9.91 | 44.23 | 56.85 | -12.62 | QP | NEUTRAL |
| 4 | 0.45 | 17.85 | 9.53 | 0.02 | 9.91 | 37.31 | 46.85 | -9.54 | Average | NEUTRAL |
| 5 | 1.22 | 14.29 | 9.67 | 0.03 | 9.89 | 33.88 | 56.00 | -22.12 | QP | NEUTRAL |
| 6 | 1.22 | 8.44 | 9.67 | 0.03 | 9.89 | 28.03 | 46.00 | -17.97 | Average | NEUTRAL |
| 7 | 1.94 | 13.66 | 9.60 | 0.04 | 9.89 | 33.19 | 56.00 | -22.81 | QP | NEUTRAL |
| 8 | 1.94 | 8.67 | 9.60 | 0.04 | 9.89 | 28.20 | 46.00 | -17.80 | Average | NEUTRAL |
| 9 | 6.66 | 6.44 | 9.62 | 0.08 | 9.94 | 26.08 | 60.00 | -33.92 | QP | NEUTRAL |
| 10 | 6.66 | -2.84 | 9.62 | 0.08 | 9.94 | 16.80 | 50.00 | -33.20 | Average | NEUTRAL |
| 11 | 22.54 | 8.71 | 9.83 | 0.18 | 9.97 | 28.69 | 60.00 | -31.31 | QP | NEUTRAL |
| 12 | 22.54 | 0.26 | 9.83 | 0.18 | 9.97 | 20.24 | 50.00 | -29.76 | Average | NEUTRAL |

Note:

1. Result Level = Read Level + LISN Factor + Pulse Limiter Factor + Cable loss.
2. If QP Result complies with AV limit, AV Result is deemed to comply with AV limit.
3. Test setup: RBW: 200 Hz (9 kHz—150 kHz), 9 kHz (150 kHz—30 MHz).
4. Step size: 80Hz (0.009MHz-0.15MHz), 4 kHz (0.15MHz-30MHz), Scan time: auto.