

FCC AND IC CERTIFICATION TEST REPORT

FOR

Applicant	:	Harman International Industries, Inc.
Address	:	8500 Balboa Boulevard, Northridge, CA 91329, UNITED STATES
Equipment under Test	:	SOUNDBAR
Model No.	:	BAR 9.1 CNTR
Trade Mark	:	JBL
FCC ID	:	APIBAR91CNTR
IC	:	6132A-BAR91CNTR
Manufacturer	:	Harman International Industries, Inc.
Address	:	8500 Balboa Boulevard, Northridge, CA 91329, UNITED STATES

Issued By: Dongguan Dongdian Testing Service Co., Ltd.

Add: No. 17, Zongbu Road 2, Songshan Lake Sci&Tech, Industry Park,
Dongguan City, Guangdong Province, China, 523808

Tel: +86-0769-38826678, **E-mail:** ddt@dgddt.com, <http://www.dgddt.com>

TABLE OF CONTENTS

	Test report declares.....	4
1.	Summary of test results	6
2.	General test information.....	7
2.1.	Description of EUT	7
2.2.	Accessories of EUT.....	7
2.3.	Assistant equipment used for test.....	8
2.4.	Block diagram of EUT configuration for test	8
2.5.	Deviations of test standard.....	8
2.6.	Test environment conditions	8
2.7.	Test laboratory	9
2.8.	Measurement uncertainty.....	9
3.	Equipment used during test	10
4.	6dB Bandwidth and 99% Bandwidth.....	11
4.1.	Block diagram of test setup.....	11
4.2.	Limits	11
4.3.	Test Procedure.....	11
4.4.	Test Result	11
4.5.	original test data	13
5.	Conducted peak Output Power.....	30
5.1.	Block diagram of test setup.....	30
5.2.	Limits	30
5.3.	Test Procedure.....	30
5.4.	Test Result	30
6.	Power Spectral Density.....	32
6.1.	Block diagram of test setup.....	32
6.2.	Limits	32
6.3.	Test Procedure.....	32
6.4.	Test Result	32
6.5.	original test data	33
7.	Band Edge and Spurious Emissions (Conducted)	42
7.1.	Block diagram of test setup.....	42
7.2.	Limits	42
7.3.	Test Procedure.....	42
7.4.	Test Result	43
7.5.	original test data	43
8.	Radiated Spurious Emissions.....	75
8.1.	Block diagram of test setup.....	75

8.2.	Limit	76
8.3.	Test Procedure	77
8.4.	Test result	79
9.	Radiated Band Edge Compliance	83
9.1.	Block diagram of test setup	83
9.2.	Limit	83
9.3.	Test Procedure	83
9.4.	Test result	83
10.	Power Line Conducted Emission	108
10.1.	Block diagram of test setup	108
10.2.	Power Line Conducted Emission Limits (Class B)	108
10.3.	Test Procedure	108
10.4.	Test Result	109
11.	Antenna Requirements	112
11.1.	Limit	112
11.2.	Result	112

TEST REPORT DECLARE

Applicant	:	Harman International Industries, Inc.
Address	:	8500 Balboa Boulevard, Northridge, CA 91329, UNITED STATES
Equipment under Test	:	SOUNDBAR
Model No	:	BAR 9.1 CNTR
Trade Mark	:	JBL
Manufacturer	:	Harman International Industries, Inc.
Address	:	8500 Balboa Boulevard, Northridge, CA 91329, UNITED STATES

Test Standard Used: FCC Rules and Regulations Part 15 Subpart C, RSS-247 Issue 2 February 2017.

Test procedure used: ANSI C63.10:2013, RSS-Gen Issue 5, Apr. 2018, 558074 D01 15.247 Meas Guidance v05r02, 662911 D01 Multiple Transmitter Output v02r01

We Declare:

The equipment described above is tested by Dongguan Dongdian Testing Service Co., Ltd and in the configuration tested the equipment complied with the standards specified above. The test results are contained in this test report and Dongguan Dongdian Testing Service Co., Ltd is assumed of full responsibility for the accuracy and completeness of these tests.

After test and evaluation, our opinion is that the equipment provided for test compliance with the requirement of the above FCC&IC standards.

Report No:	DDT-R19080513-1E6		
Date of Receipt:	Sep. 04, 2019	Date of Test:	Sep. 04, 2019 ~ Nov. 25, 2019

Prepared By:

Sam Li

Sam Li/Engineer

Approved By:



Damon Hu/EMC Manager

Note: This report applies to above tested sample only. This report shall not be reproduced in parts without written approval of Dongguan Dongdian Testing Service Co., Ltd.

Revision history

Rev.	Revisions	Issue Date	Revised By
---	Initial issue	Nov. 25, 2019	

1. Summary of test results

The EUT have been tested according to the applicable standards as referenced below.		
Description of Test Item	Standard	Results
6dB Bandwidth and 99% Bandwidth	FCC 15.247 (a) (2) RSS-247 Clause 5.2 (a)	PASS
Conducted Output Power	FCC 15.247 (b) (3) RSS-247 Clause 5.4 (e)	PASS
Power Spectral Density	FCC 15.247 (e) RSS-247 Clause 5.2 (b)	PASS
Band-edge and Spurious Emissions (Conducted)	FCC 15.247 (d) RSS-247 Clause 5.5	PASS
Radiated Spurious Emissions	FCC 15.247 (d) FCC 15.209 FCC 15.205 RSS-247 Clause 5.5 RSS-GEN Clause 8.9	PASS
Radiated Band Edge Compliance	FCC 15.247 (d) FCC 15.209 FCC 15.205 RSS-247 Clause 5.5 RSS-GEN Clause 8.9	PASS
Power Line Conducted Emission	FCC 15.207 RSS-GEN Clause 8.8	PASS
Antenna requirement	FCC 15.203 RSS-GEN Clause 8.3	PASS

2. General test information

2.1. Description of EUT

EUT* Name	: SOUNDBAR
Model Number	: BAR 9.1 CNTR
EUT function description	: Please reference user manual of this device
Power supply	: 100-240V~, 50/60Hz
Radio Technology	: IEEE 802.11b/g/n
FCC Operation frequency	: IEEE 802.11b: 2412MHz-2462MHz IEEE 802.11g: 2412MHz-2462MHz IEEE 802.11n HT20: 2412MHz-2462MHz IEEE 802.11n HT40: 2422MHz-2452MHz
Modulation	: IEEE 802.11b: DSSS (CCK, DQPSK, DBPSK) IEEE 802.11g: OFDM (64QAM, 16QAM, QPSK, BPSK) IEEE 802.11n HT20, HT40: OFDM (64QAM, 16QAM, QPSK, BPSK)
Transmitter rate	: IEEE 802.11b: 1, 2, 5.5, 11 Mbps IEEE 802.11g: 6, 9, 12, 18, 24, 36, 48, 54 Mbps IEEE 802.11n HT20: 6.5, 13, 19.5, 26, 39, 52, 58.5, 65 Mbps IEEE 802.11n HT40: 13.5, 27, 40.5, 54, 81, 108, 121.5, 135 Mbps
Antenna Type	: Antenna 1: External FPC antenna, maximum PK gain: 2.34 dBi Antenna 2: External FPC antenna, maximum PK gain: 2.97 dBi
Sample Type	: Series production

Note: EUT is the ab. of equipment under test.

Antenna information			
	Ant1 gain	Ant2 gain	MIMO
IEEE 802.11b	2.34	2.97	/
IEEE 802.11g	2.34	2.97	/
IEEE 802.11n HT20	2.34	2.97	5.68
IEEE 802.11n HT40	2.34	2.97	5.68

Channel information					
CH	Frequency (MHz)	CH	Frequency (MHz)	CH	Frequency (MHz)
1	2412	5	2432	9	2452
2	2417	6	2437	10	2457
3	2422	7	2442	11	2462
4	2427	8	2447	/	/

2.2. Accessories of EUT

Description of Accessories	Manufacturer	Model number	Description	Remark
AC Cable	Harman	N/A	1.5 m long, unshielded, non-magnetic ring	2 pcs
HDMI Cable	Harman	N/A	1.2 m long, unshielded, With two magnetic rings	N/A

Remote control	Harman	N/A	N/A	N/A
----------------	--------	-----	-----	-----

2.3. Assistant equipment used for test

Assistant equipment	Manufacturer	Model number	EMC Compliance	SN
Notebook	Lenovo Beijing Co. Ltd.	ThinkPad	FCC/CE	TP00015A

2.4. Block diagram of EUT configuration for test



EUT was connected to control to provide by manufacturer which has a standard LAN PORT connector to connect to Notebook, and the Notebook will run a special test software “MtkTool.exe” provided by manufacturer to control EUT work in Continuous Tx mode (>98% duty cycle), and select test channel, wireless mode and data rate.

Tested mode, channel, and data rate information				
Mode	Setting Tx Power	data rate (Mbps) (see Note)	Channel	Frequency (MHz)
IEEE 802.11b	16	1	LCH: CH1	2412
	16	1	MCH: CH6	2437
	16	1	HCH: CH11	2462
IEEE 802.11g	16	6	LCH: CH1	2412
	16	6	MCH: CH6	2437
	16	6	HCH: CH11	2462
IEEE 802.11n HT20	15	MCS 8	LCH: CH1	2412
	15	MCS 8	MCH: CH6	2437
	15	MCS 8	HCH: CH11	2462
IEEE 802.11n HT40	14	MCS 8	LCH: CH3	2422
	14	MCS 8	MCH: CH6	2437
	14	MCS 8	HCH: CH9	2452

Note: According exploratory test, EUT will have maximum output power in those data rate, so those data rate were used for all test.

2.5. Deviations of test standard

No Deviation

2.6. Test environment conditions

During the measurement the environmental conditions were within the listed ranges:

Temperature range:	21-25°C
Humidity range:	40-75%
Pressure range:	86-106kPa

2.7. Test laboratory

Dongguan Dongdian Testing Service Co., Ltd

Add: No. 17, Zongbu Road 2, Songshan Lake Sci&Tech, Industry Park, Dongguan City, Guangdong Province, China, 523808

Tel: +86-0769-38826678, <http://www.dgddt.com>, Email: ddt@dgddt.com

CNAS Accreditation No. L6451; A2LA Accreditation No. 3870.01

Designation Number: CN1182; Test Firm Registration Number: 540522

Industry Canada site registration number: 10288A-1

2.8. Measurement uncertainty

Test Item	Uncertainty
Bandwidth	1.1%
Peak Output Power (Conducted) (Spectrum analyzer)	0.86 dB (10 MHz ≤ f < 3.6 GHz); 1.38 dB (3.6 GHz ≤ f < 8 GHz)
Peak Output Power (Conducted) (Power Sensor)	0.74 dB
Power Spectral Density	0.74 dB (10 MHz ≤ f < 3.6 GHz); 1.38 dB (3.6 GHz ≤ f < 8 GHz)
Frequencies Stability	6.7 × 10 ⁻⁸ (Antenna couple method) 5.5 × 10 ⁻⁸ (Conducted method)
Conducted spurious emissions	0.86 dB (10 MHz ≤ f < 3.6 GHz); 1.40 dB (3.6 GHz ≤ f < 8 GHz) 1.66 dB (8 GHz ≤ f < 22 GHz)
Uncertainty for radio frequency (RBW < 20 kHz)	3 × 10 ⁻⁸
Temperature	0.4°C
Humidity	2%
Uncertainty for Radiation Emission test (30 MHz-1 GHz)	4.70 dB (Antenna Polarize: V) 4.84 dB (Antenna Polarize: H)
Uncertainty for Radiation Emission test (1 GHz-40 GHz)	4.10 dB (1-6 GHz) 4.40 dB (6 GHz-18 GHz) 3.54 dB (18 GHz-26 GHz) 4.30 dB (26 GHz-40 GHz)
Uncertainty for Power line conduction emission test	3.32 dB (150 kHz-30 MHz)

Note: This uncertainty represents an expanded uncertainty expressed at approximately the 95% confidence level using a coverage factor of k=2.

3. Equipment used during test

Equipment	Manufacturer	Model No.	Serial No.	Last Cal.	Cal. Interval
RF Connected Test (Tonscend RF Measurement System)					
Spectrum analyzer	R&S	FSU26	200071	Sep. 29, 2019	1 Year
Wideband Radio Communication tester	R&S	CMW500	117491	Jun. 25, 2019	1 Year
Vector Signal Generator	Agilent	E8267D	US49060192	Sep. 29, 2019	1 Year
Vector Signal Generator	Agilent	N5182A	MY48180737	Jun. 25, 2019	1 Year
Power Sensor	Agilent	U2021XA	MY55150010	Jun. 28, 2019	1 Year
Power Sensor	Agilent	U2021XA	MY55150011	Jun. 28, 2019	1 Year
DC Power Source	MATRIS	MPS-3005L-3	D813058W	Jun. 25, 2019	1 Year
RF Cable	Micable	C10-01-01-1	100309	Sep. 29, 2019	1 Year
Temp&Humi Programmable	ZHIXIANG	ZXGDJS-150L	ZX170110-A	Oct. 21, 2019	1 Year
Test Software	JS Tonscend	JS1120-3	Ver.2.7	N/A	N/A
Radiation 1#chamber					
EMI Test Receiver	R&S	ESU8	100316	Sep. 29, 2019	1 Year
Spectrum analyzer	Agilent	E4447A	MY50180031	Jun. 25, 2019	1 Year
Trilog Broadband Antenna	Schwarzbeck	VULB9163	9163-462	Nov. 15, 2019	1 Year
Active Loop antenna	Schwarzbeck	FMZB-1519	1519-038	Sep. 29, 2019	1 Year
Double Ridged Horn Antenna	R&S	HF907	100276	Nov. 15, 2019	1 Year
Broad Band Horn Antenna	Schwarzbeck	BBHA 9170	790	Sep. 29, 2019	1 Year
Pre-amplifier	A.H.	PAM-0118	360	Sep. 29, 2019	1 Year
Pre-amplifier	TERA-MW	TRLA-0040 G35	101303	Sep. 29, 2019	1 Year
RF Cable	HUBSER	CP-X2+ CP-X1	W11.03+ W12.02	Sep. 29, 2019	1 Year
RF Cable	N/A	5m+6m+1m	06270619	Sep. 29, 2019	1 Year
MI Cable	HUBSER	C10-01-01-1 M	1091629	Sep. 29, 2019	1 Year
Test software	Audix	E3	V 6.11111b	N/A	N/A
Power Line Conducted Emissions Test					
EMI Test Receiver	R&S	ESU8	100316	Sep. 29, 2019	1 Year
LISN 1	R&S	ENV216	101109	Sep. 29, 2019	1 Year
LISN 2	R&S	ESH2-Z5	100309	Sep. 29, 2019	1 Year
Pulse Limiter	R&S	ESH3-Z2	101242	Sep. 29, 2019	1 Year
CE Cable 1	HUBSER	N/A	W10.01	Sep. 29, 2019	1 Year
Test software	Audix	E3	V 6.11111b	N/A	N/A

4. 6dB Bandwidth and 99% Bandwidth

4.1. Block diagram of test setup

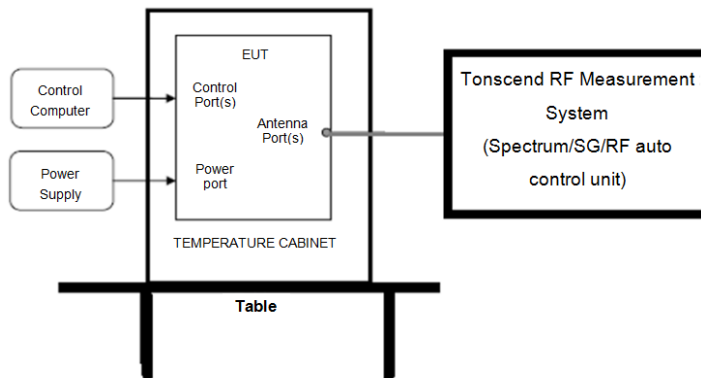

4.2. Limits

For direct sequence systems, the minimum 6 dB bandwidth shall be at least 500 kHz

4.3. Test Procedure

- (1) Connect EUT's antenna output to spectrum analyzer by RF cable.
- (2) 99% Bandwidth set the spectrum analyzer as follows:

RBW:	300 kHz
VBW:	1 MHz
Detector Mode:	Peak
Sweep time:	auto
Trace mode	Max hold

- (3) 6dB Bandwidth set the spectrum analyzer as follows:

RBW:	100 kHz
VBW:	300 kHz
Detector Mode:	Peak
Sweep time:	auto
Trace mode	Max hold

- (4) Allow the trace to stabilize, measure the maximum width of the emission that is constrained by the frequencies associated with the two outermost amplitude points (upper and lower frequencies) that are attenuated by 6 dB relative to the maximum level measured in the fundamental emission.

4.4. Test Result

Test Mode	Test	Ant	6dB Bandwidth [MHz]	Limit [MHz]	Verdict
11B	2412	Ant1	9.160	0.5	PASS
11B	2412	Ant2	9.160	0.5	PASS

11B	2437	Ant1	9.120	0.5	PASS
11B	2437	Ant2	9.120	0.5	PASS
11B	2462	Ant1	9.120	0.5	PASS
11B	2462	Ant2	9.160	0.5	PASS
11G	2412	Ant1	15.160	0.5	PASS
11G	2412	Ant2	15.120	0.5	PASS
11G	2437	Ant1	15.160	0.5	PASS
11G	2437	Ant2	15.160	0.5	PASS
11G	2462	Ant1	15.200	0.5	PASS
11G	2462	Ant2	15.320	0.5	PASS
11N20MIMO	2412	Ant1	15.200	0.5	PASS
11N20MIMO	2412	Ant2	15.200	0.5	PASS
11N20MIMO	2437	Ant1	15.200	0.5	PASS
11N20MIMO	2437	Ant2	15.200	0.5	PASS
11N20MIMO	2462	Ant1	15.200	0.5	PASS
11N20MIMO	2462	Ant2	15.800	0.5	PASS
11N40MIMO	2422	Ant1	35.360	0.5	PASS
11N40MIMO	2422	Ant2	35.280	0.5	PASS
11N40MIMO	2437	Ant1	35.360	0.5	PASS
11N40MIMO	2437	Ant2	35.200	0.5	PASS
11N40MIMO	2452	Ant1	35.360	0.5	PASS
11N40MIMO	2452	Ant2	35.280	0.5	PASS

Test Mode	Test	Ant	99% OBW [MHz]	Limit [MHz]	Verdict
11B	2412	Ant1	13.24	---	PASS
11B	2412	Ant2	13.28	---	PASS
11B	2437	Ant1	13.28	---	PASS
11B	2437	Ant2	13.32	---	PASS
11B	2462	Ant1	13.28	---	PASS
11B	2462	Ant2	13.28	---	PASS
11G	2412	Ant1	16.84	---	PASS
11G	2412	Ant2	16.76	---	PASS
11G	2437	Ant1	16.88	---	PASS
11G	2437	Ant2	16.76	---	PASS
11G	2462	Ant1	16.88	---	PASS
11G	2462	Ant2	16.76	---	PASS
11N20MIMO	2412	Ant1	17.68	---	PASS
11N20MIMO	2412	Ant2	17.64	---	PASS
11N20MIMO	2437	Ant1	17.72	---	PASS

11N20MIMO	2437	Ant2	17.64	---	PASS
11N20MIMO	2462	Ant1	17.68	---	PASS
11N20MIMO	2462	Ant2	17.64	---	PASS
11N40MIMO	2422	Ant1	36.48	---	PASS
11N40MIMO	2422	Ant2	36.40	---	PASS
11N40MIMO	2437	Ant1	36.56	---	PASS
11N40MIMO	2437	Ant2	36.40	---	PASS
11N40MIMO	2452	Ant1	36.56	---	PASS
11N40MIMO	2452	Ant2	36.48	---	PASS

4.5. original test data

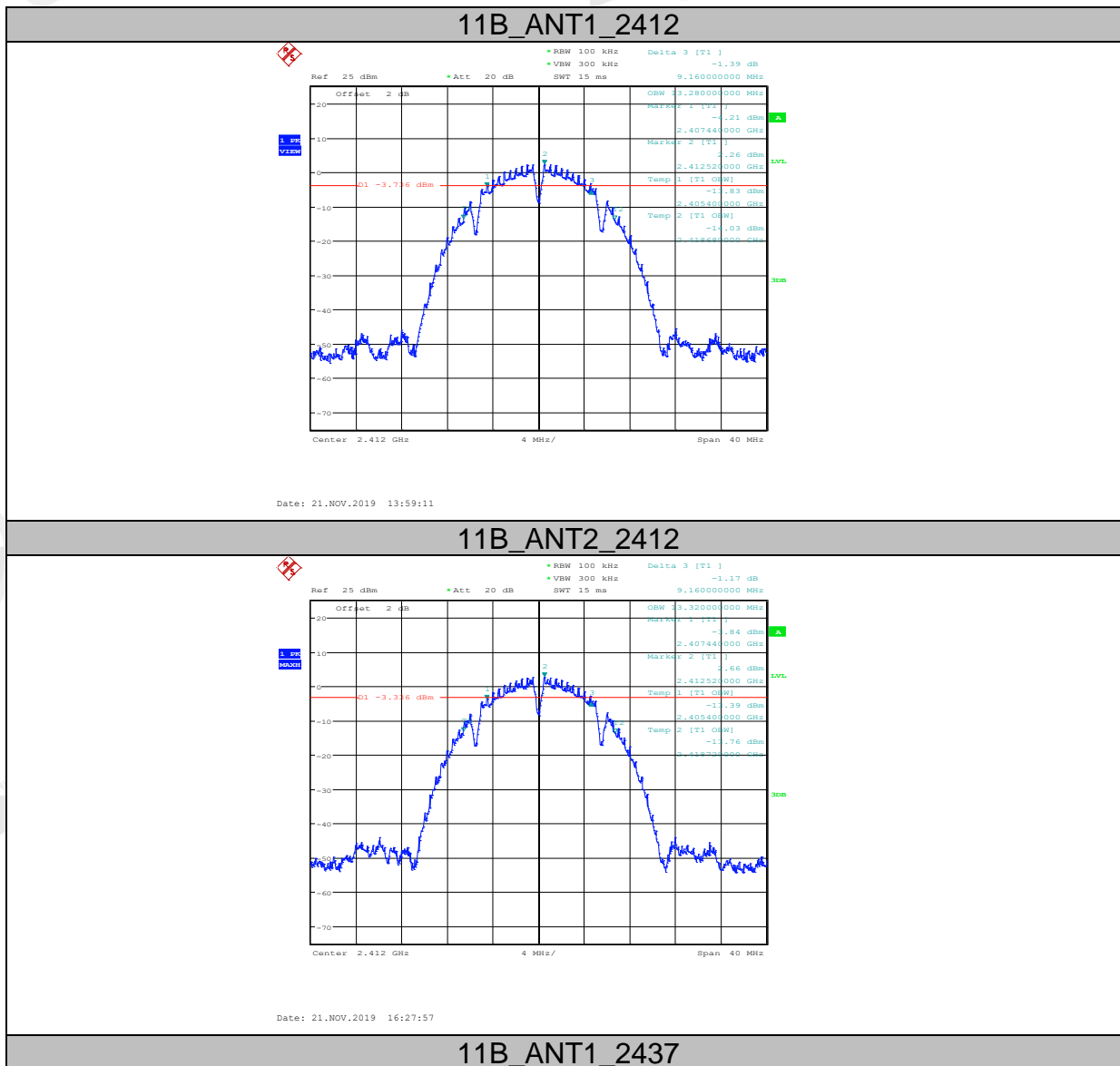

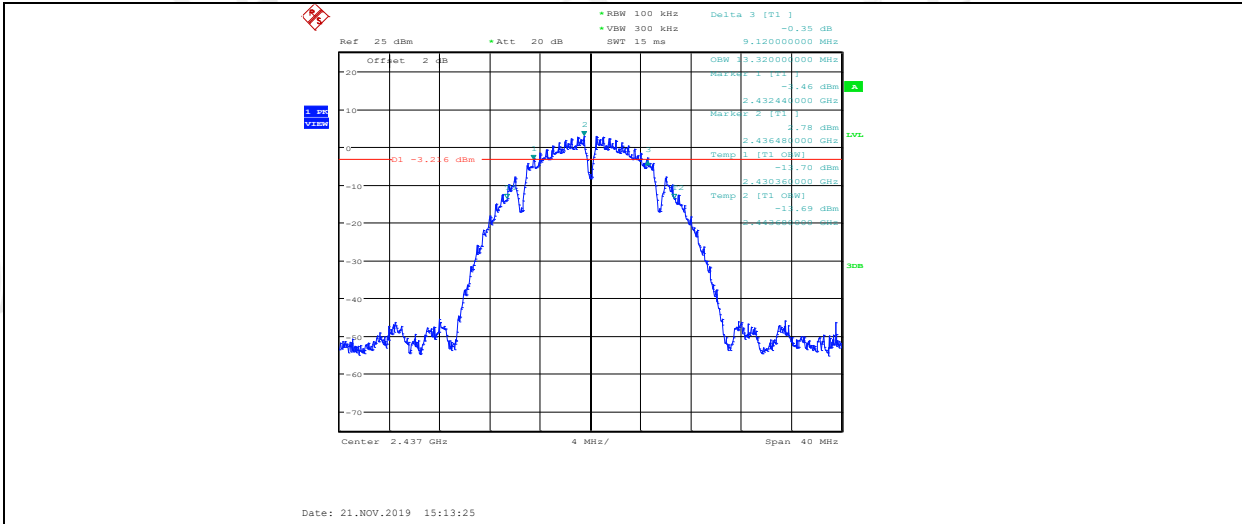

11B_ANT2_2437

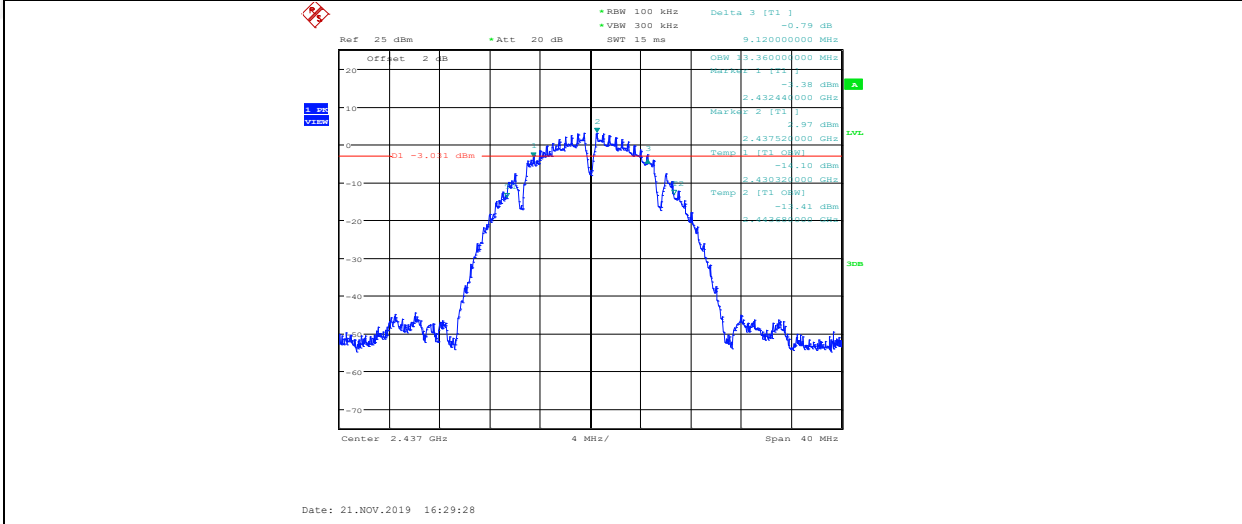

11B_ANT1_2462

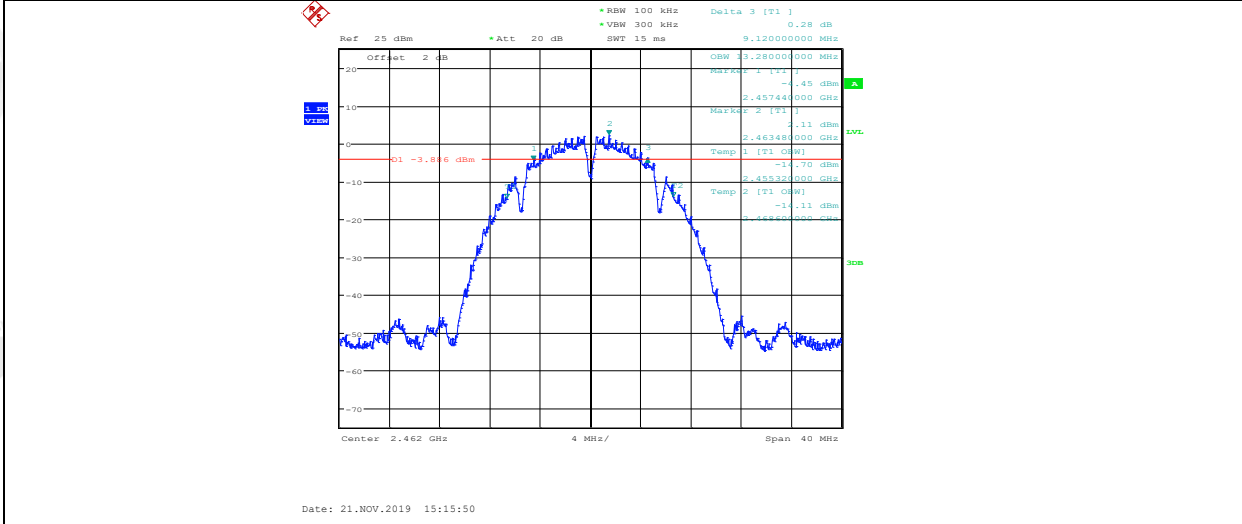

11B_ANT2_2462

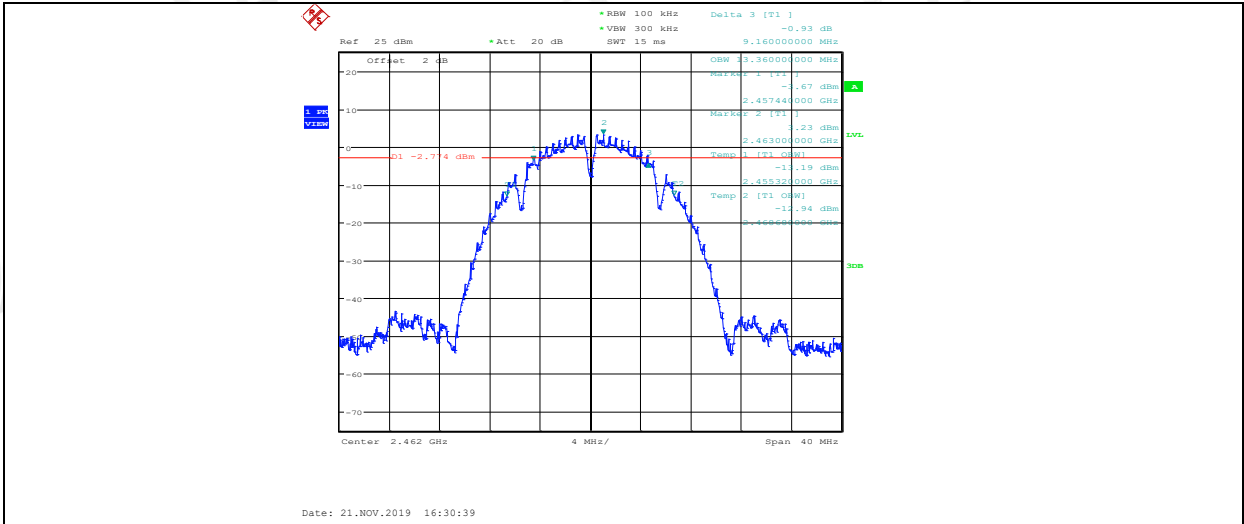

11G_ANT1_2412

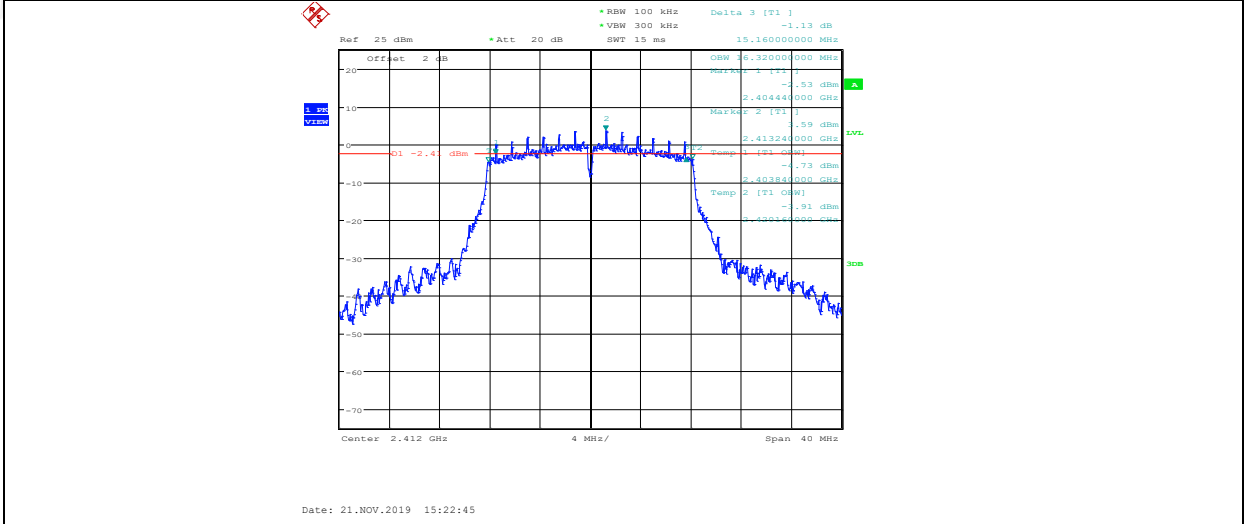

11G_ANT2_2412

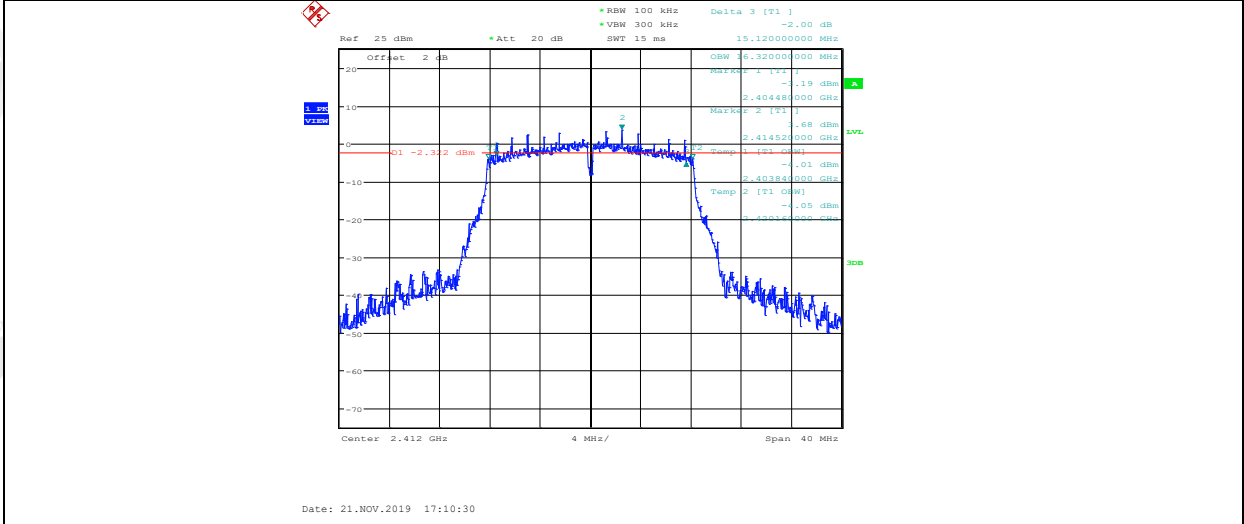

11G_ANT1_2437

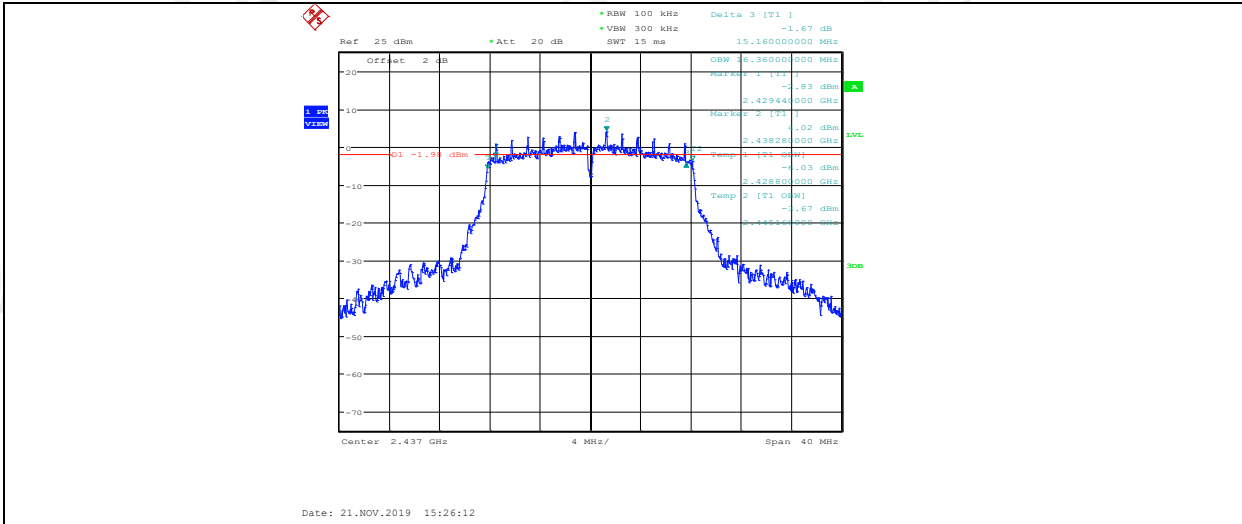

11G_ANT2_2437

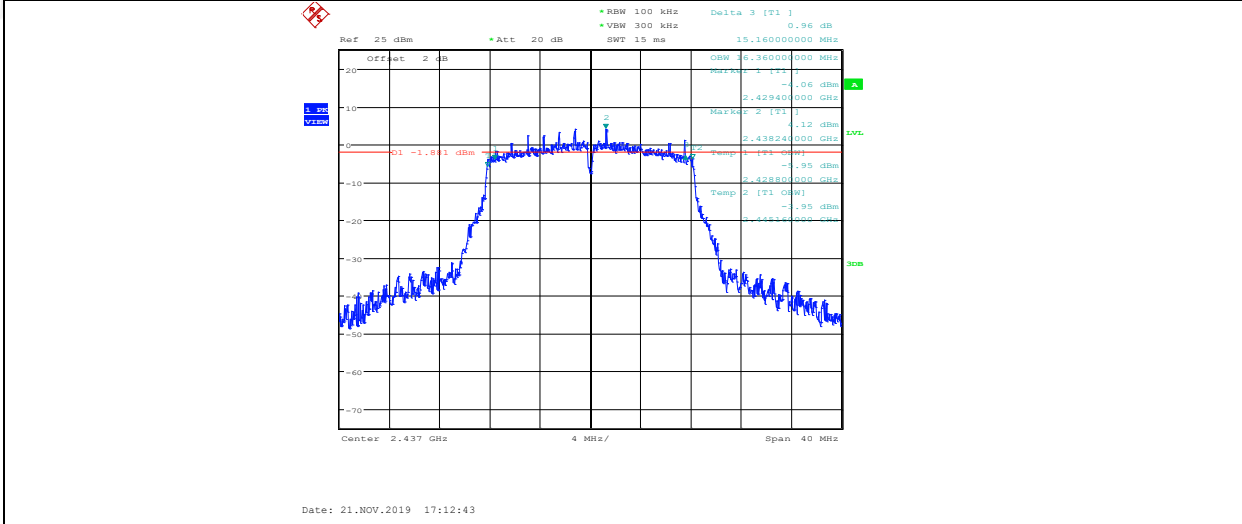

11G_ANT1_2462

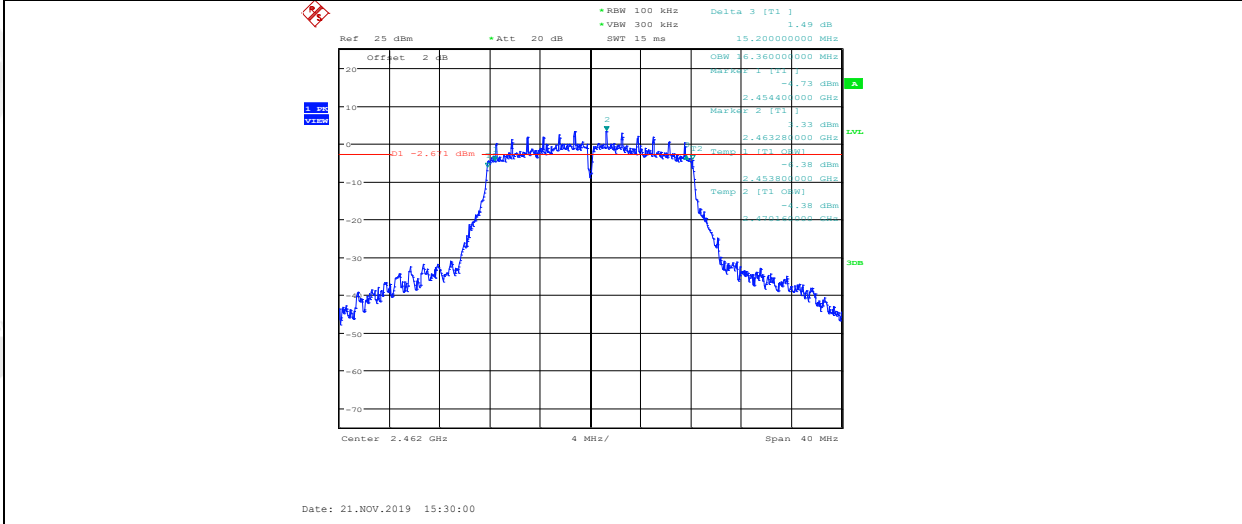

11G_ANT2_2462

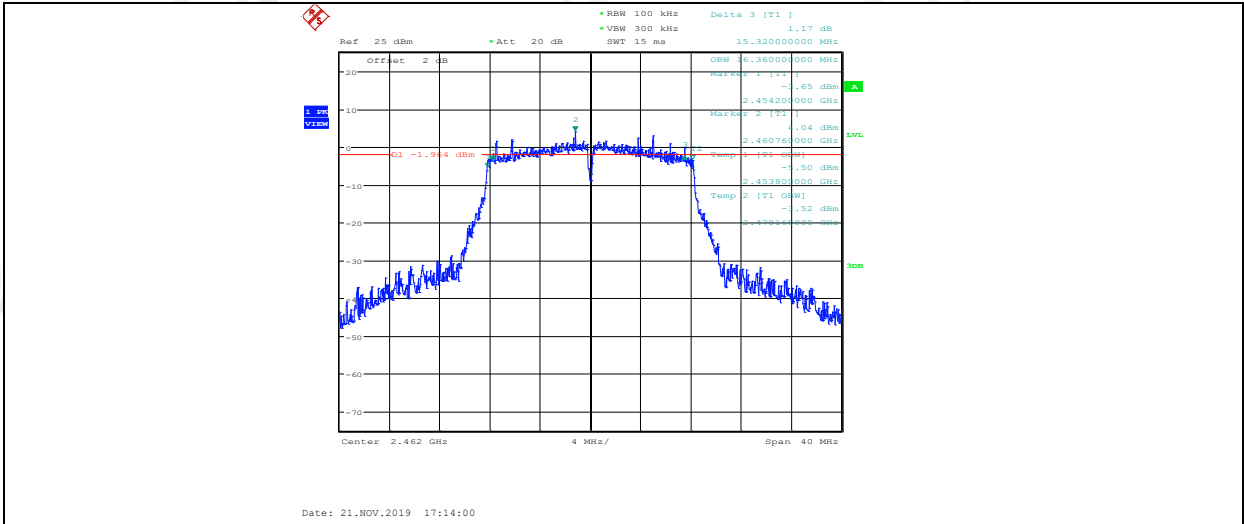

11N20MIMO_ANT1_2412

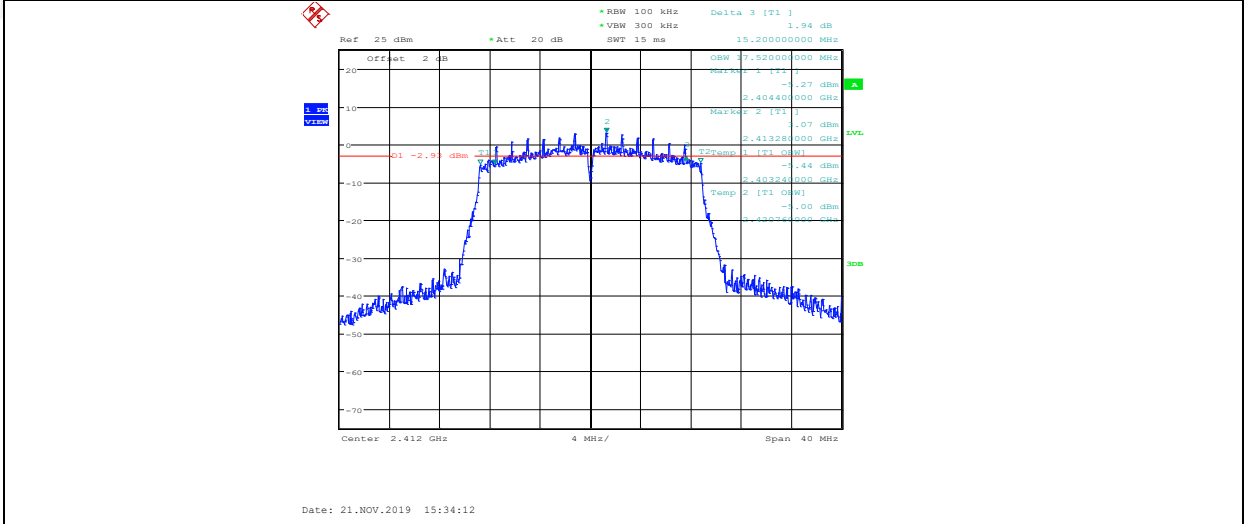

11N20MIMO_ANT2_2412

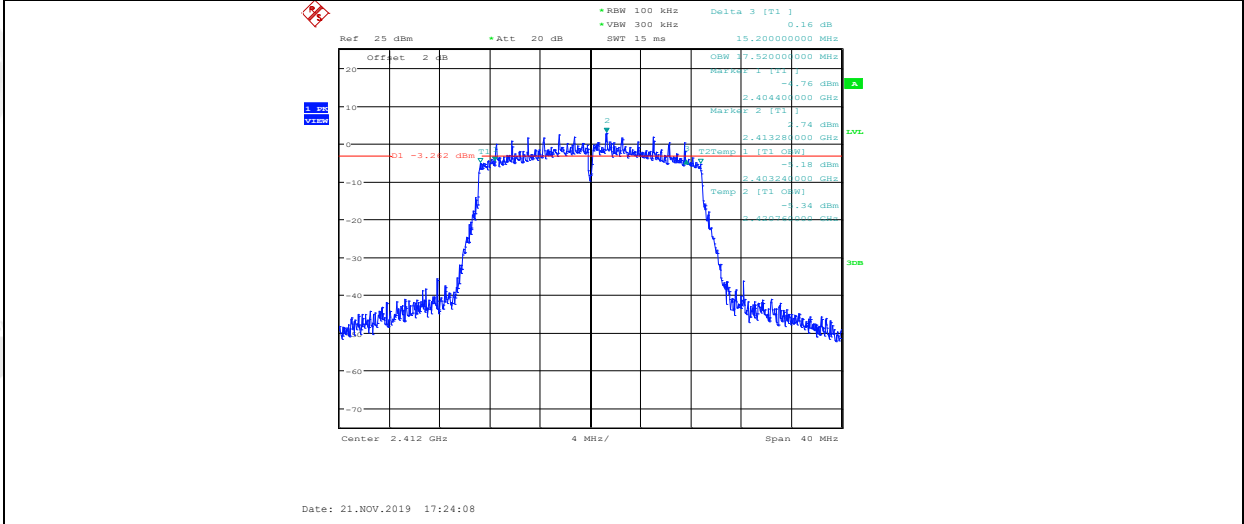

11N20MIMO_ANT1_2437

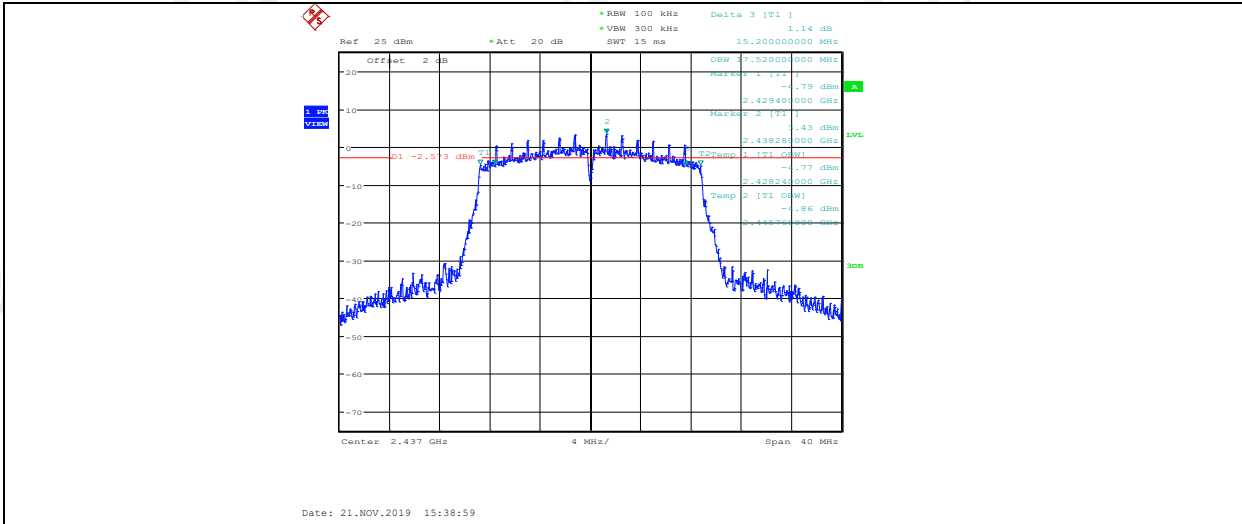

11N20MIMO_ANT2_2437

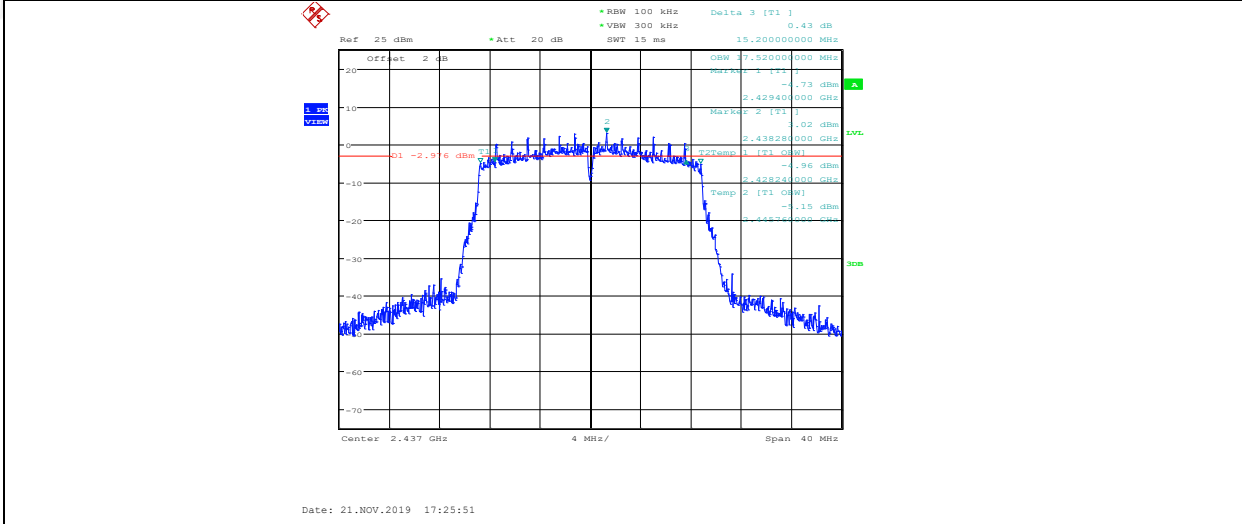

11N20MIMO_ANT1_2462

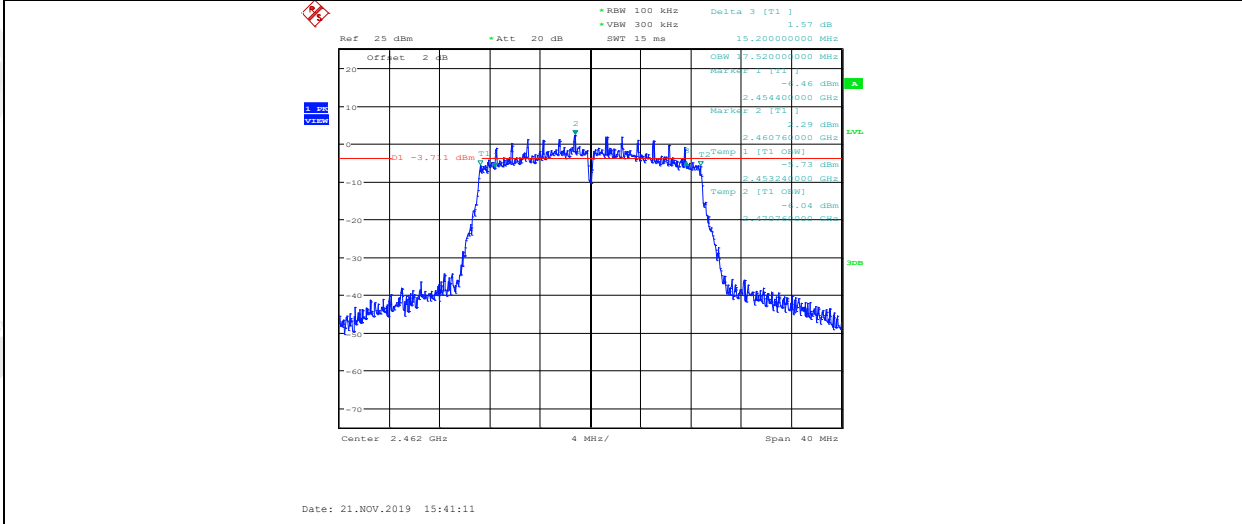

11N20MIMO_ANT2_2462

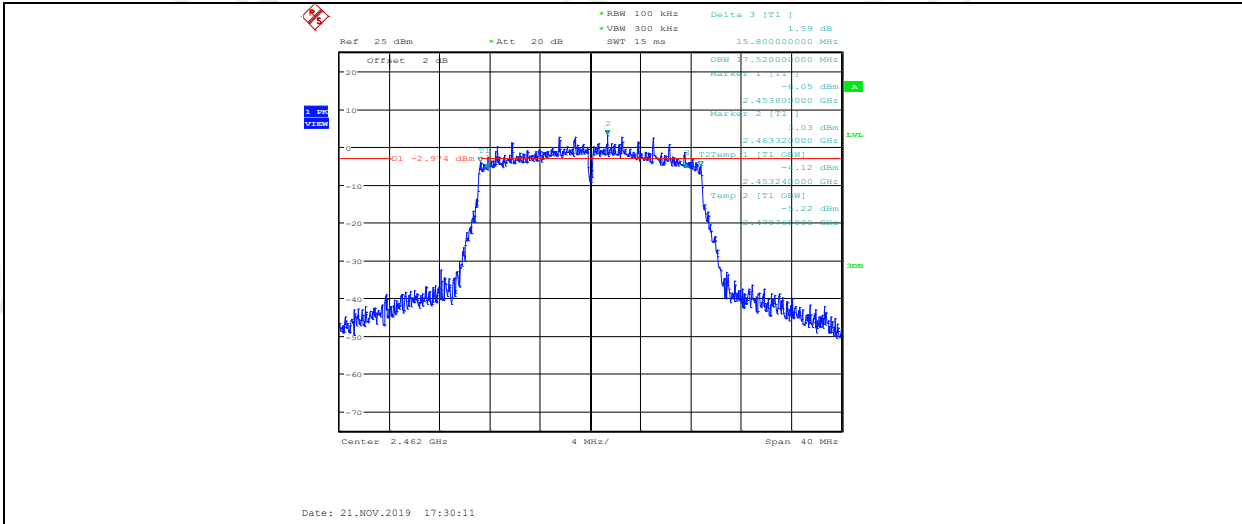

11N40MIMO_ANT1_2422

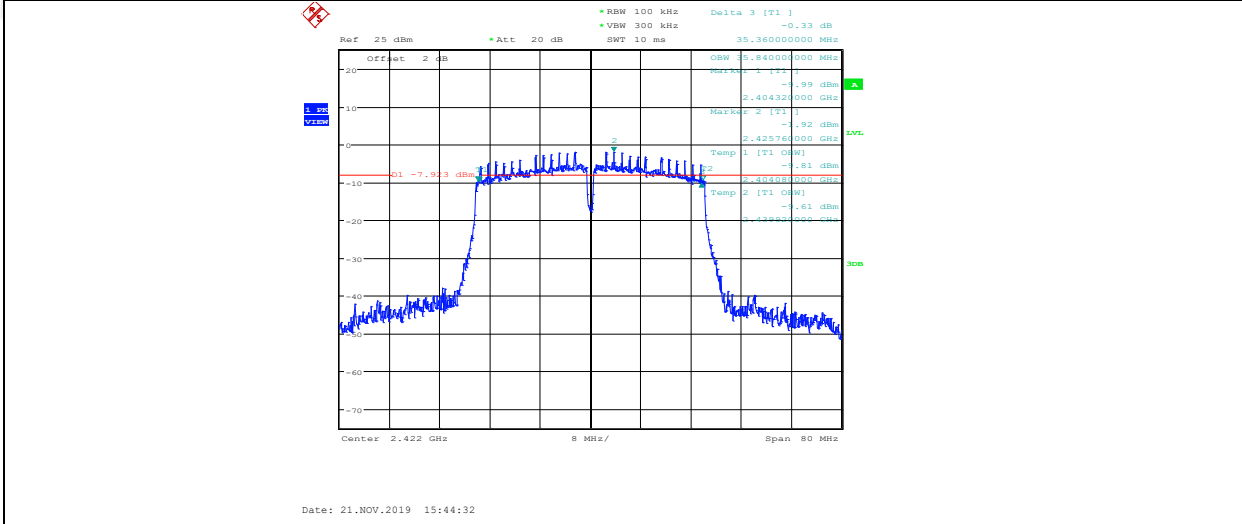

11N40MIMO_ANT2_2422

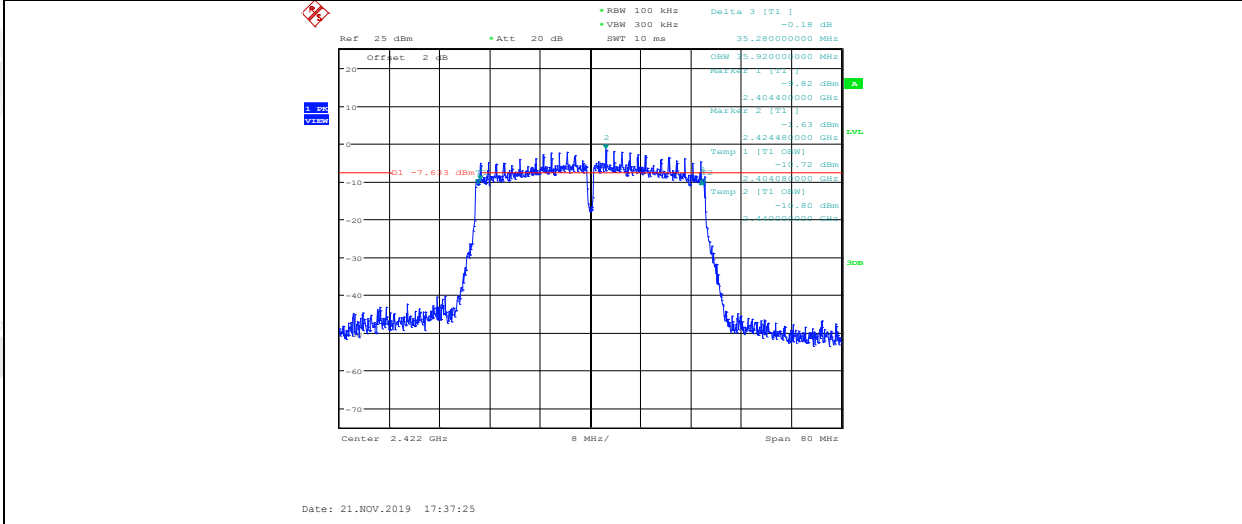

11N40MIMO_ANT1_2437

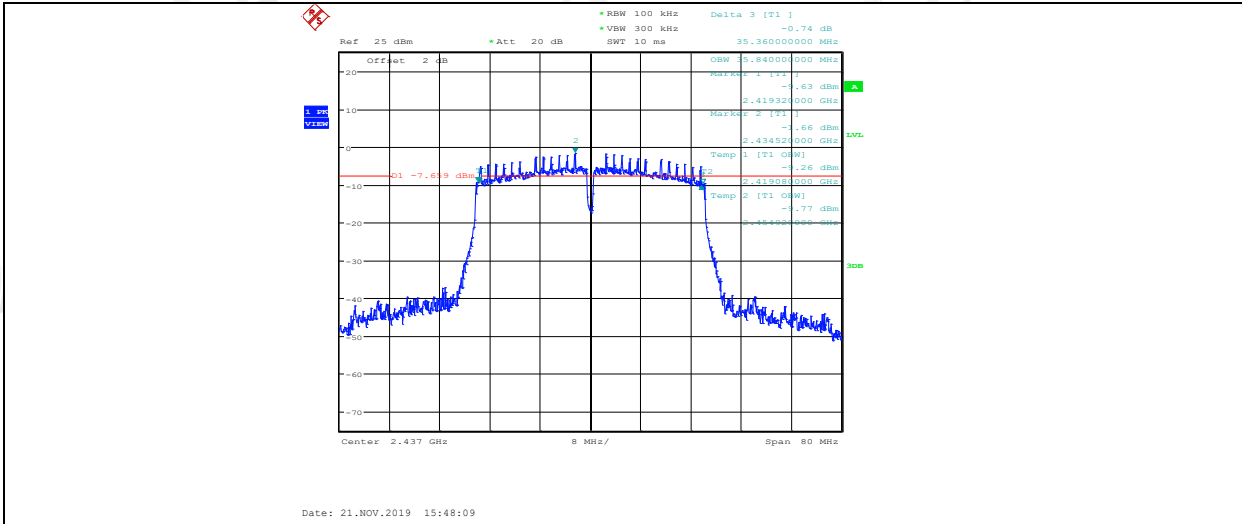

11N40MIMO_ANT2_2437

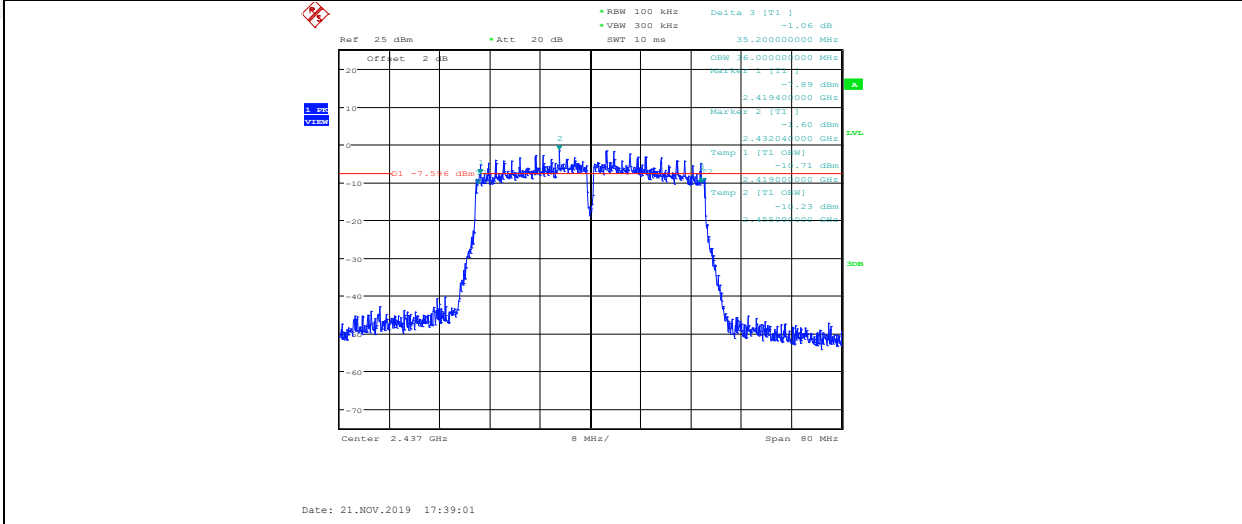

11N40MIMO_ANT1_2452

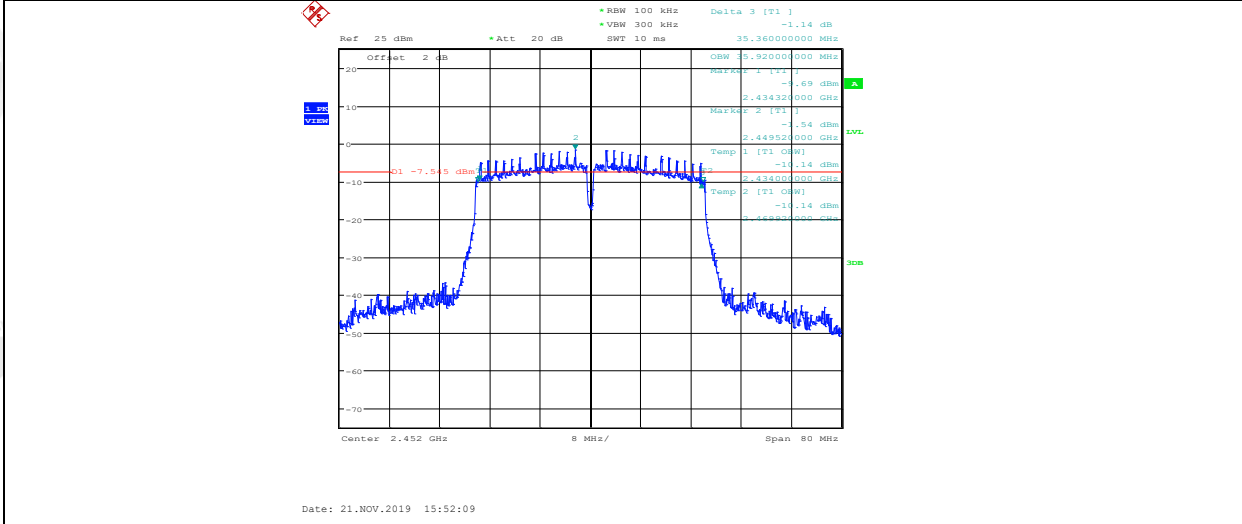

11N40MIMO_ANT2_2452

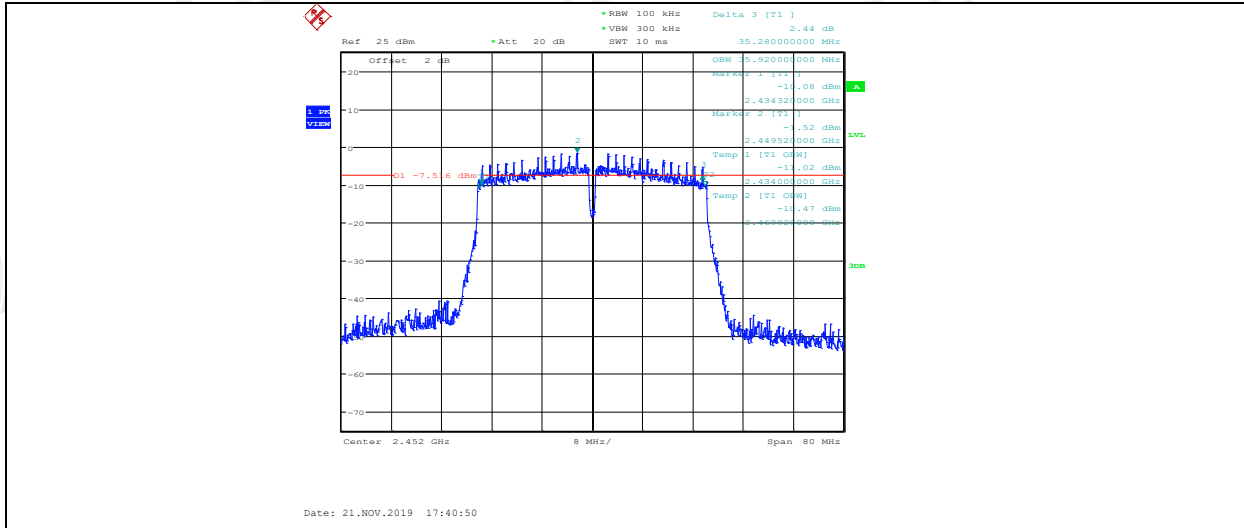

11B_ANT1_2412

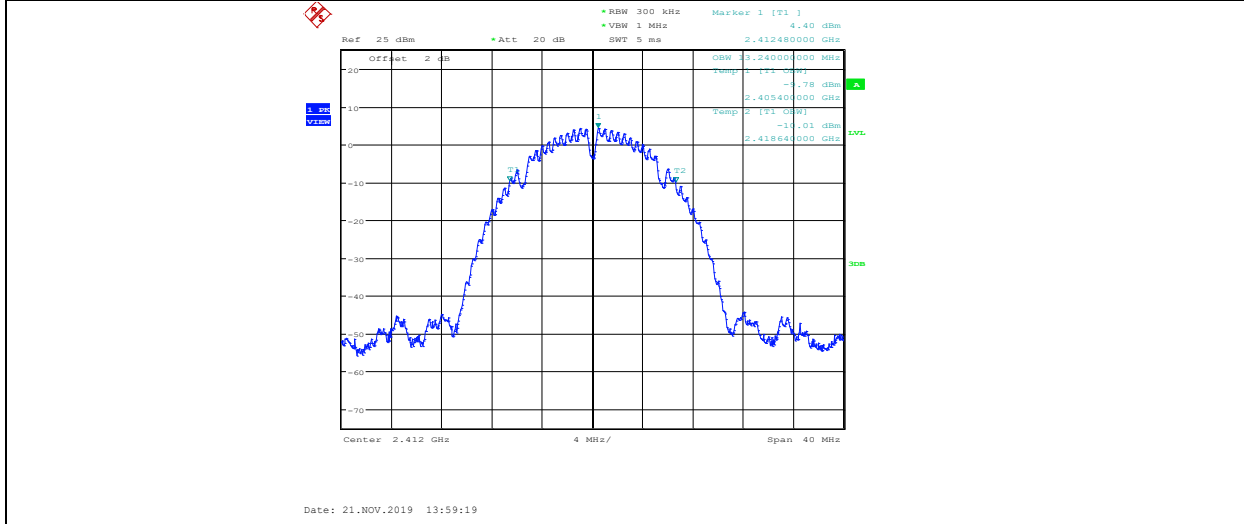

11B_ANT2_2412

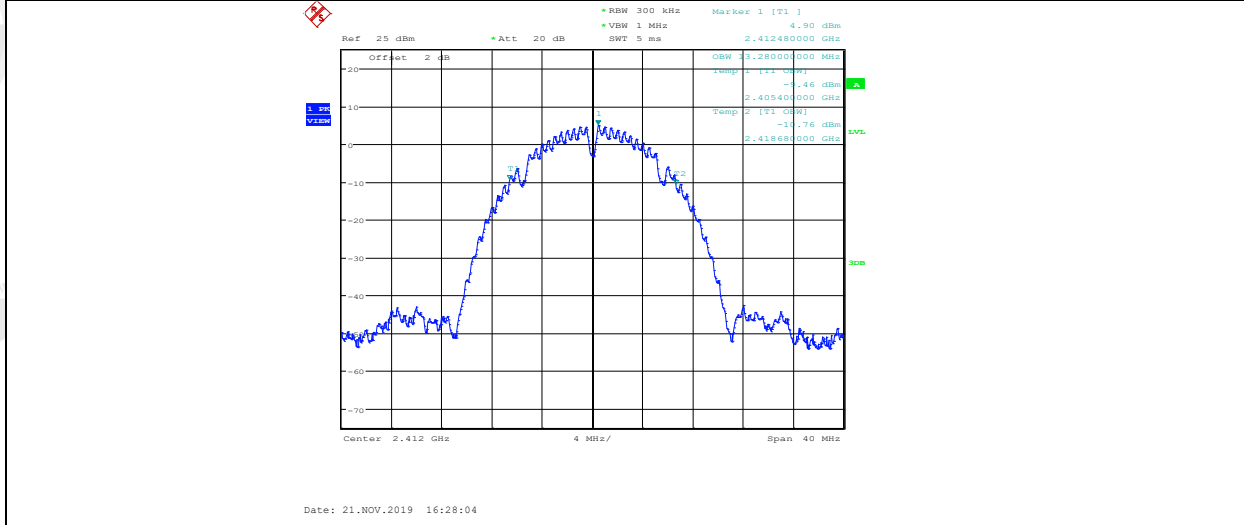

11B_ANT1_2437

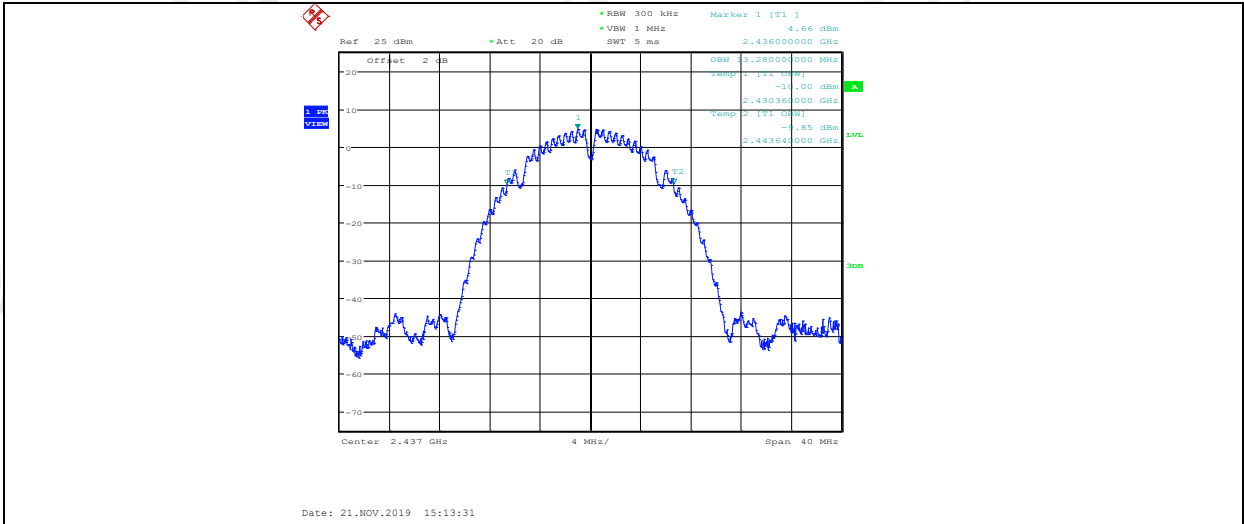

11B_ANT2_2437

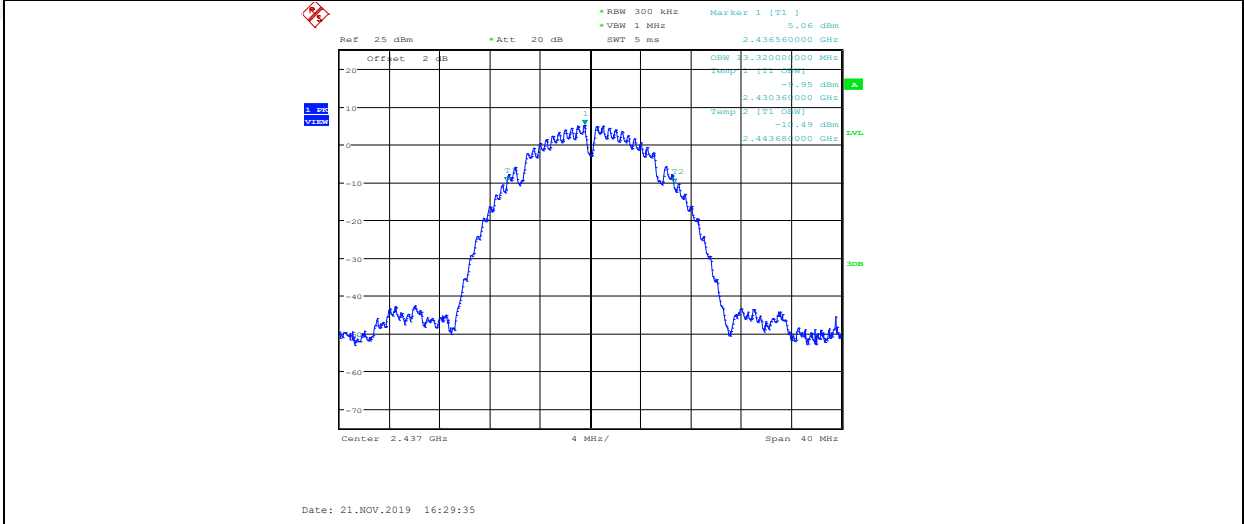

11B_ANT1_2462

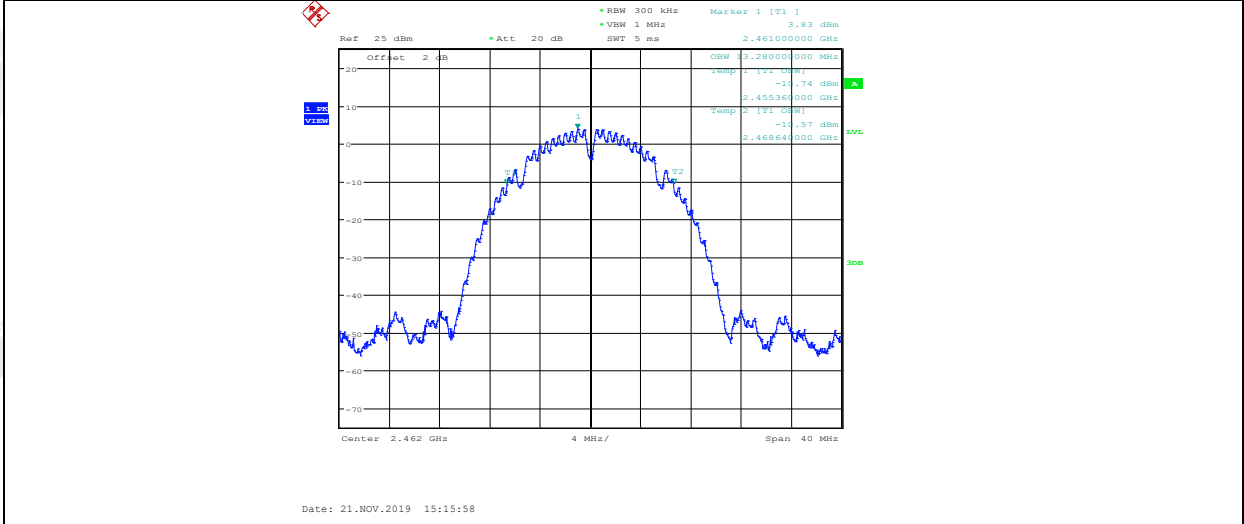

11B_ANT2_2462

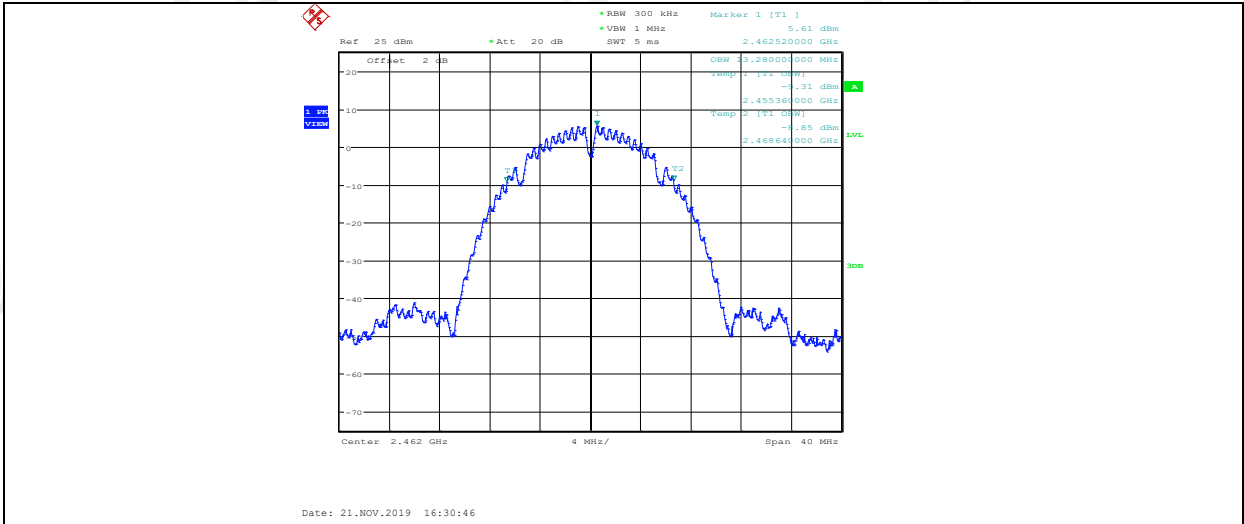

11G_ANT1_2412



11G_ANT2_2412

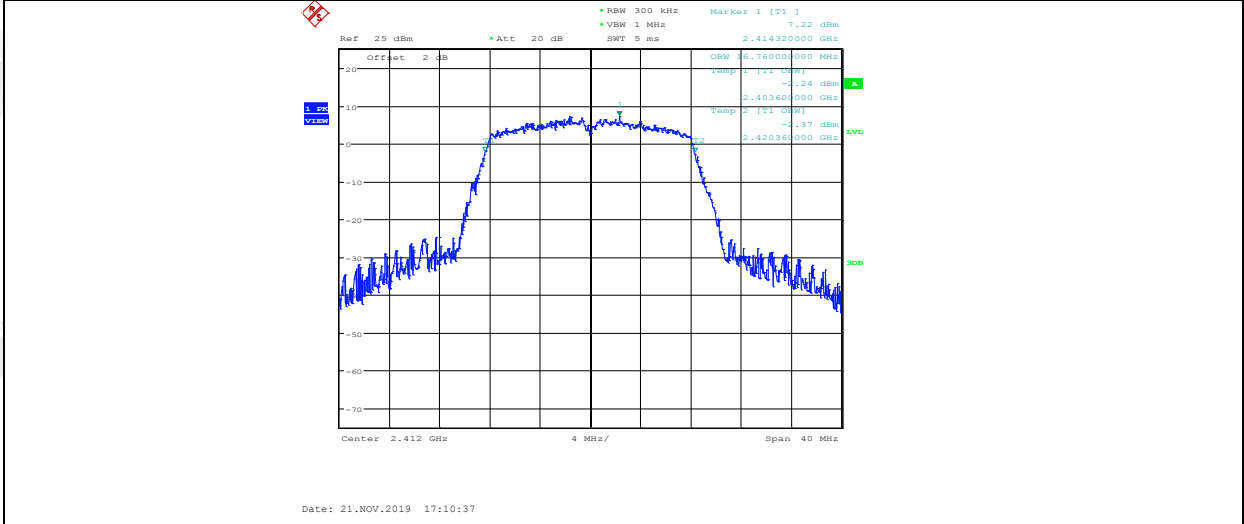

11G_ANT1_2437

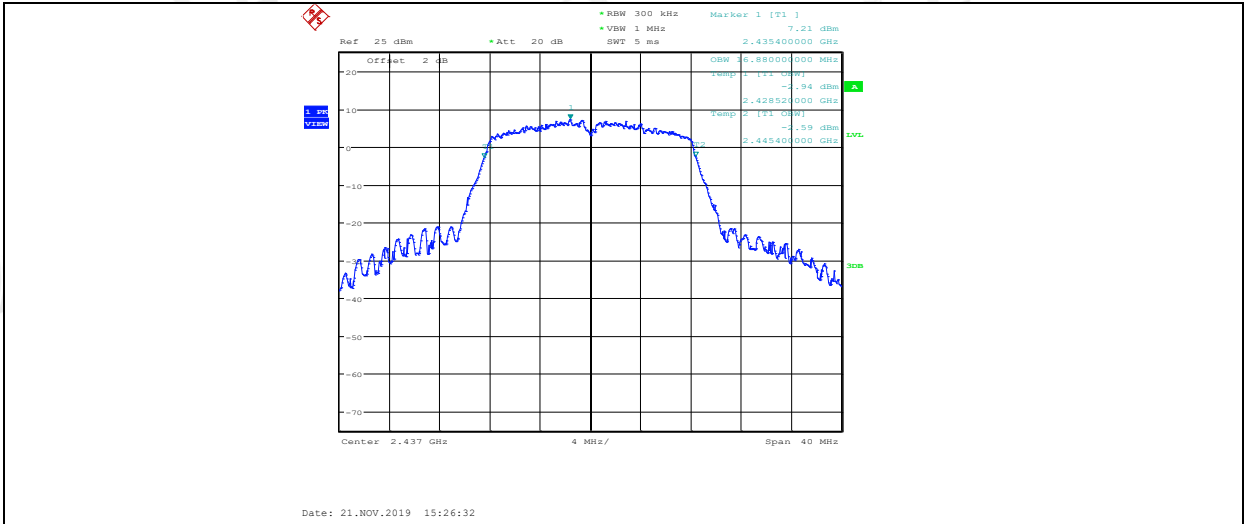

11G_ANT2_2437

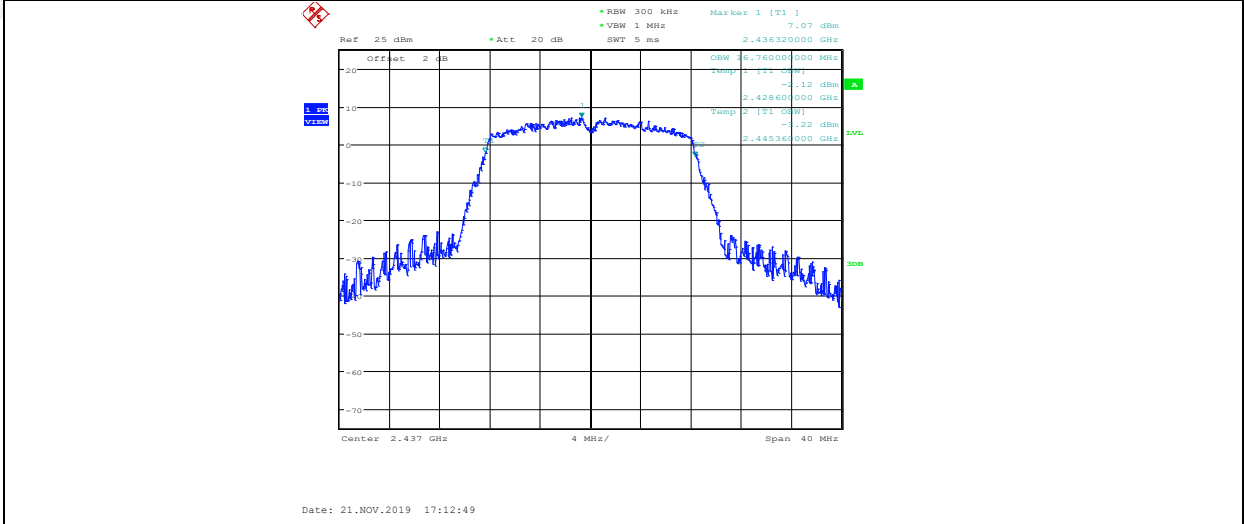

11G_ANT1_2462

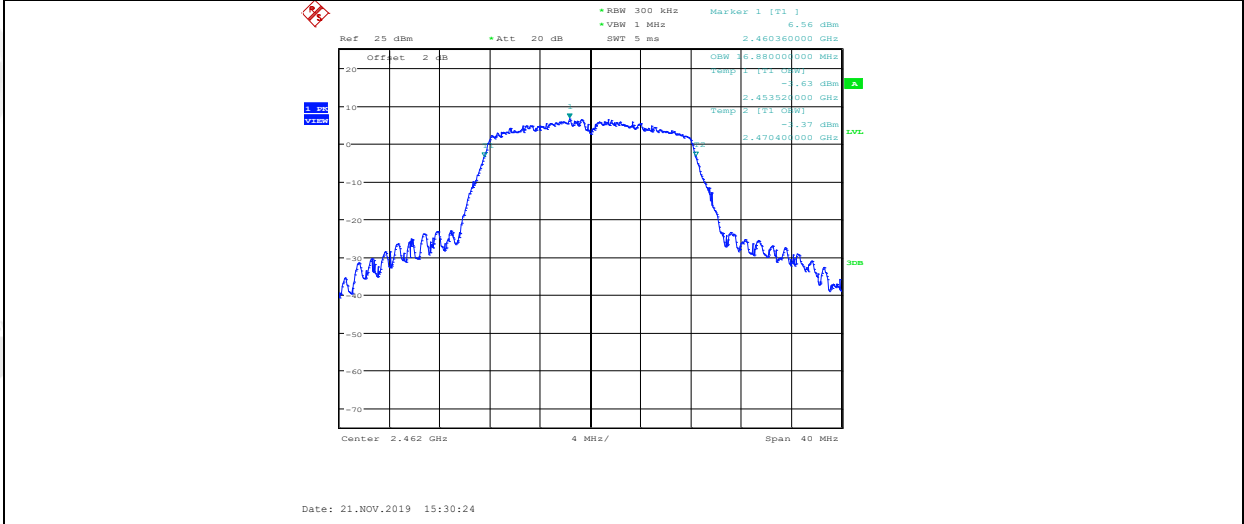

11G_ANT2_2462

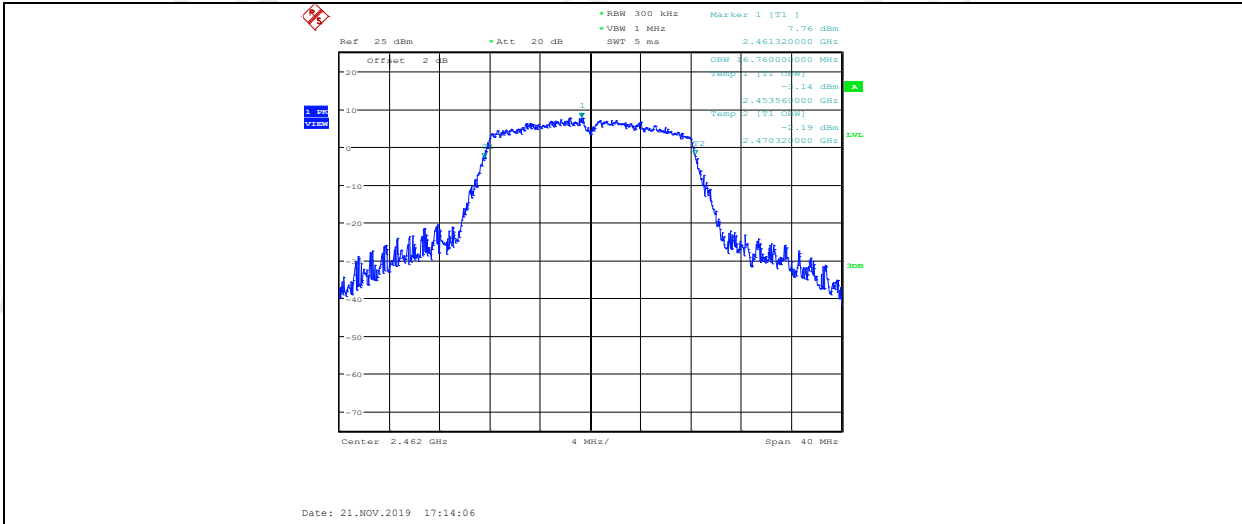

11N20MIMO_ANT1_2412

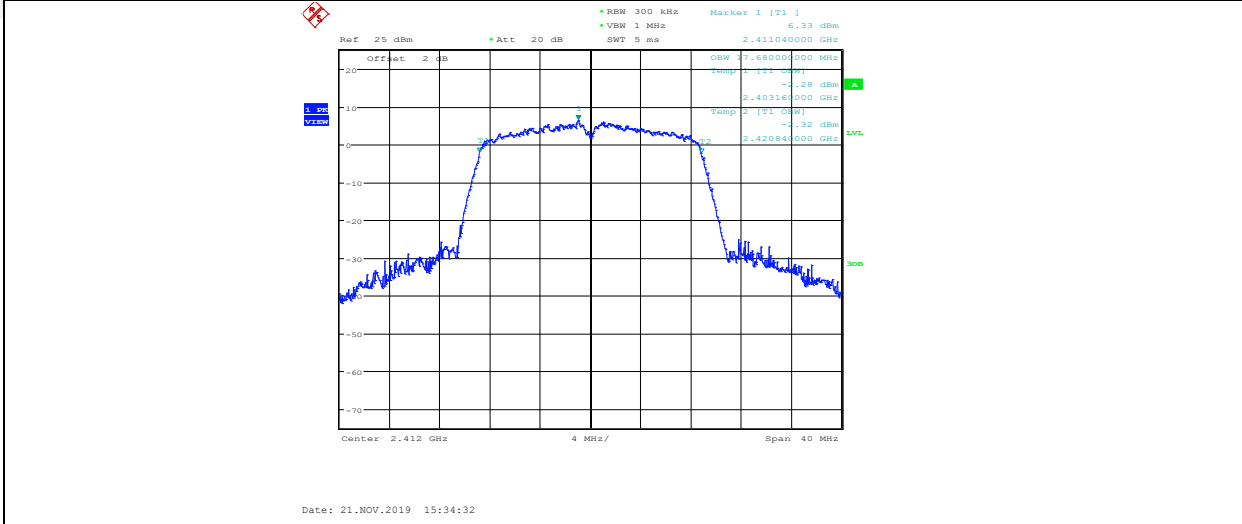

11N20MIMO_ANT2_2412

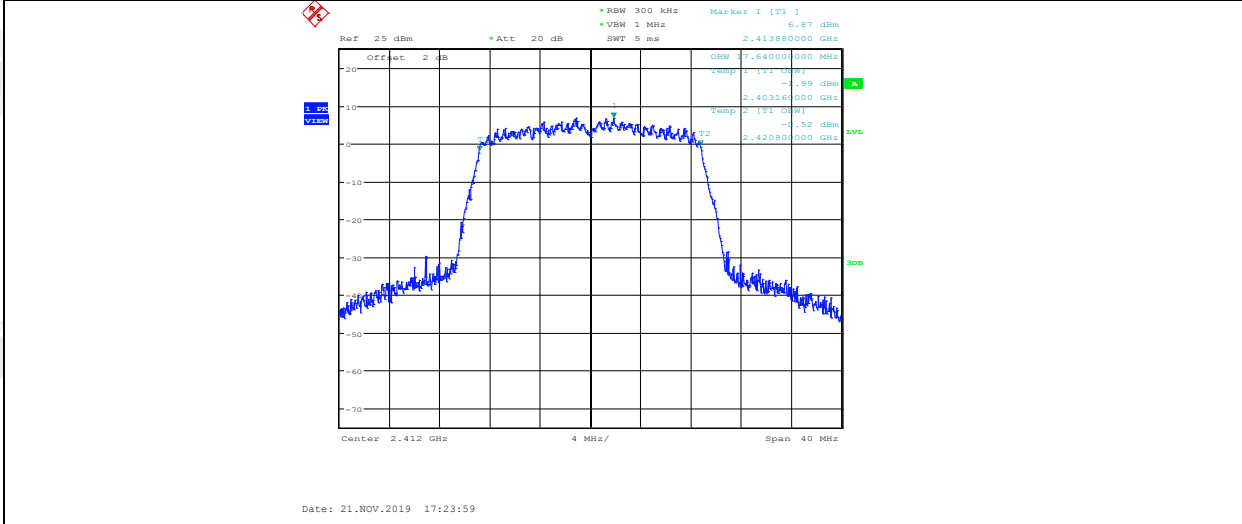

11N20MIMO_ANT1_2437

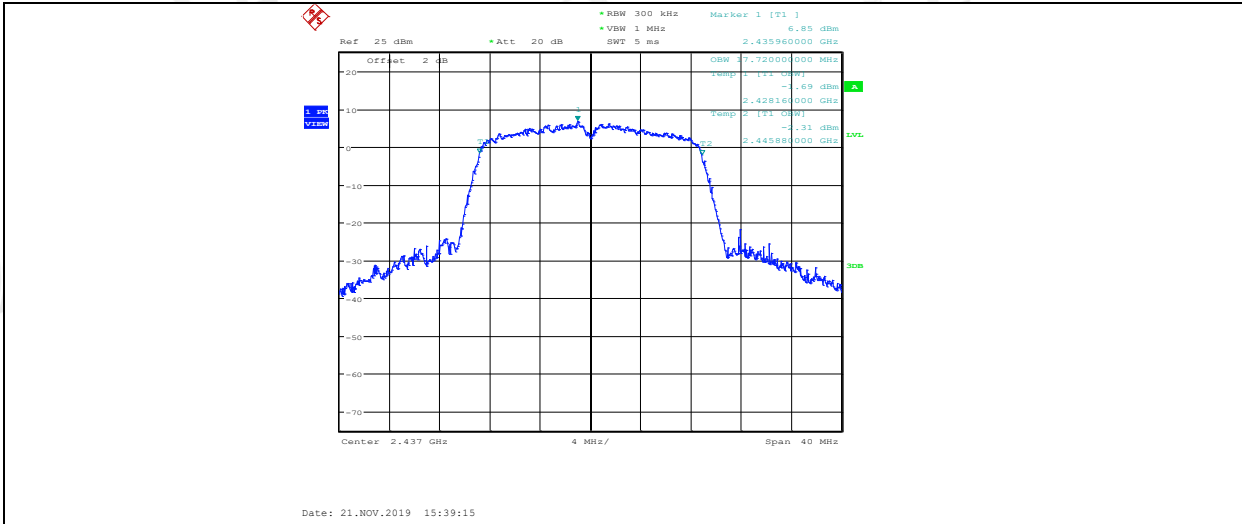

11N20MIMO_ANT2_2437

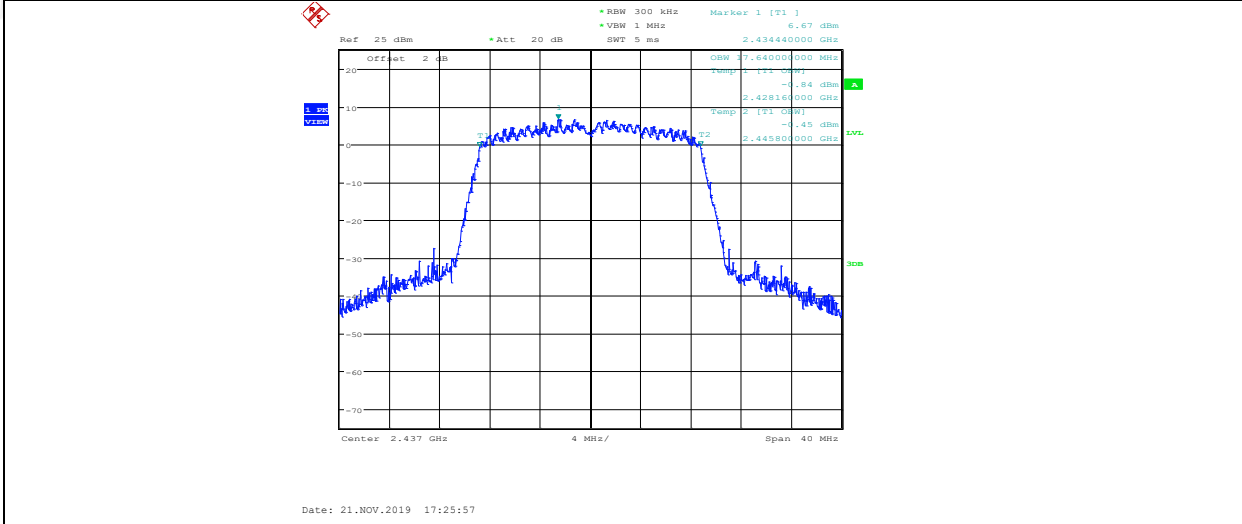

11N20MIMO_ANT1_2462

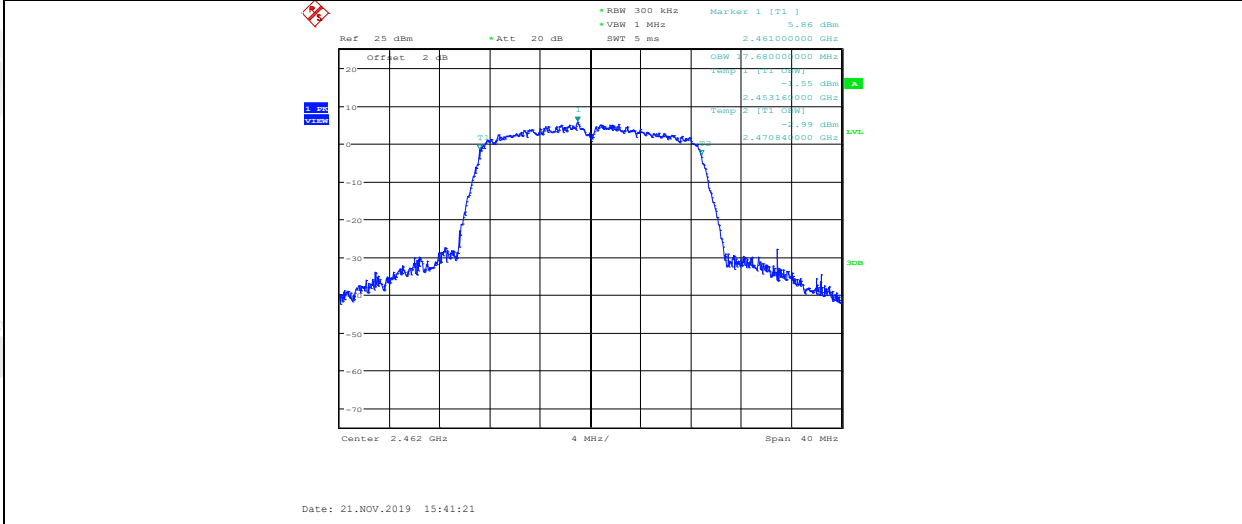

11N20MIMO_ANT2_2462

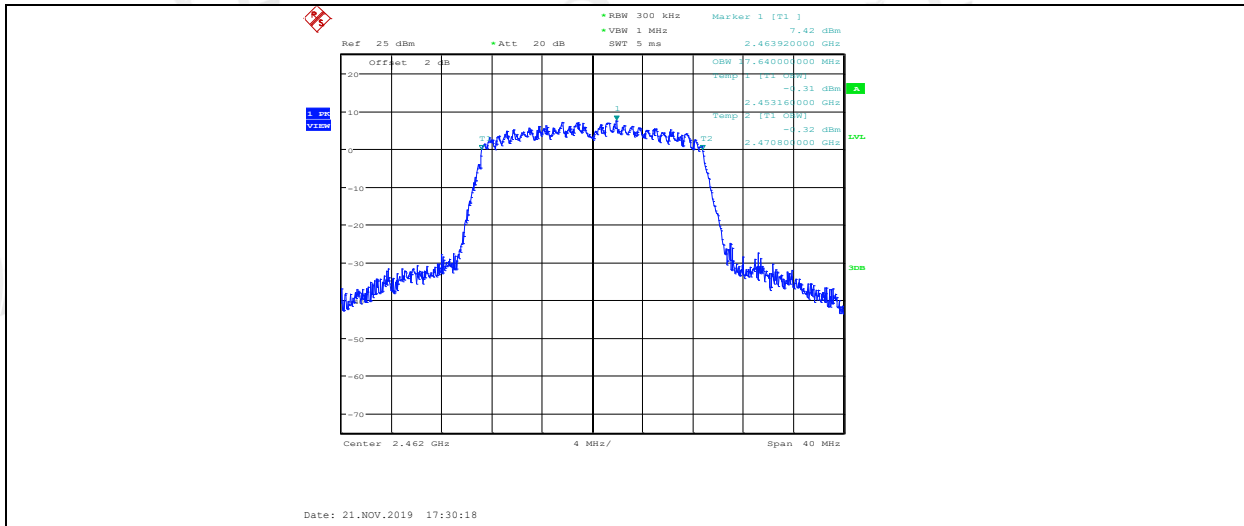

11N40MIMO_ANT1_2422



11N40MIMO_ANT2_2422

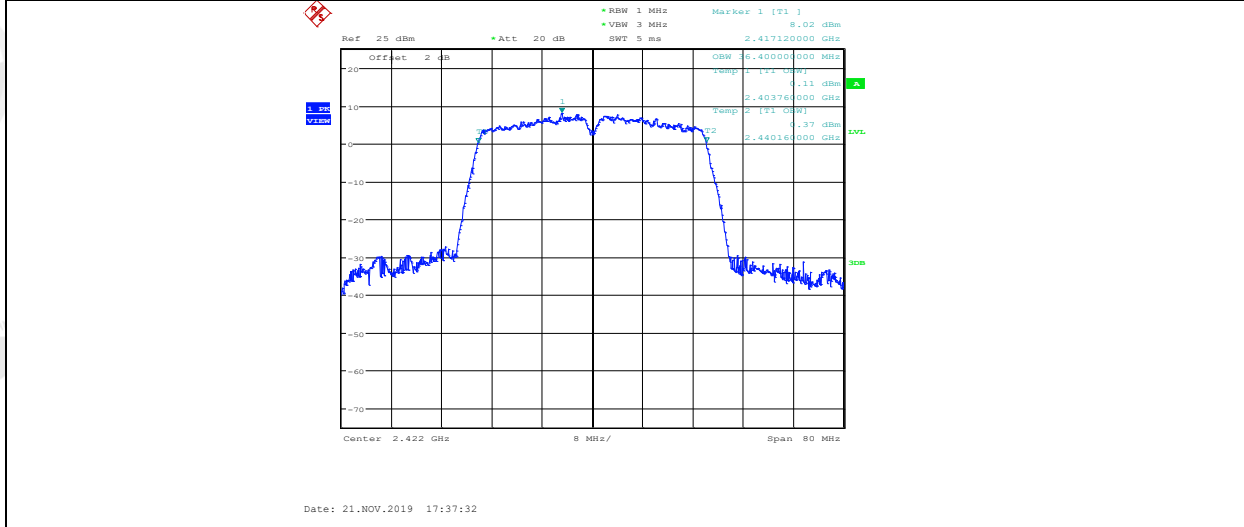

11N40MIMO_ANT1_2437

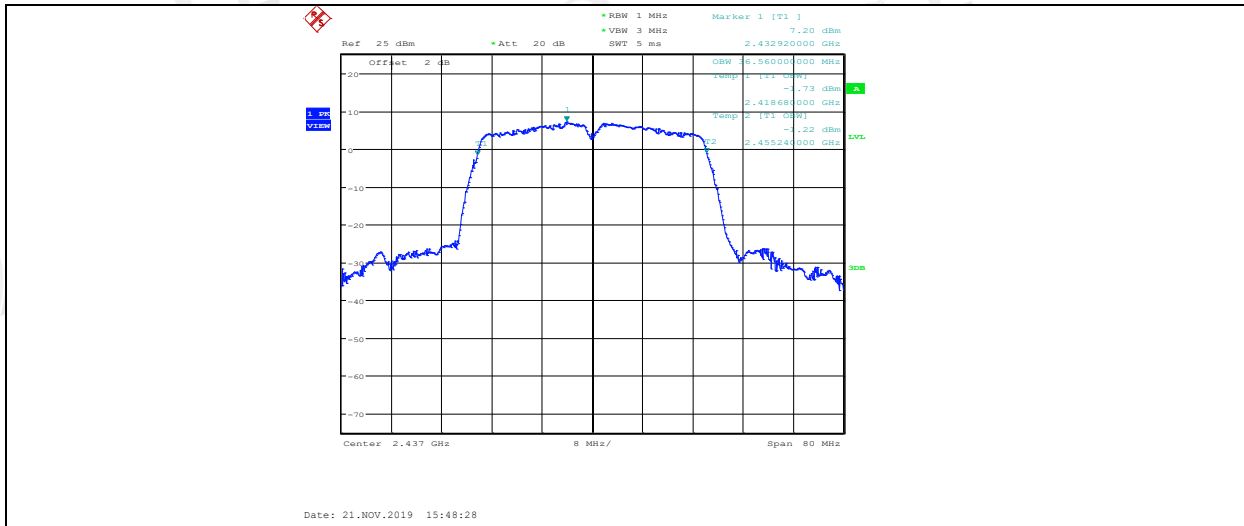

11N40MIMO_ANT2_2437

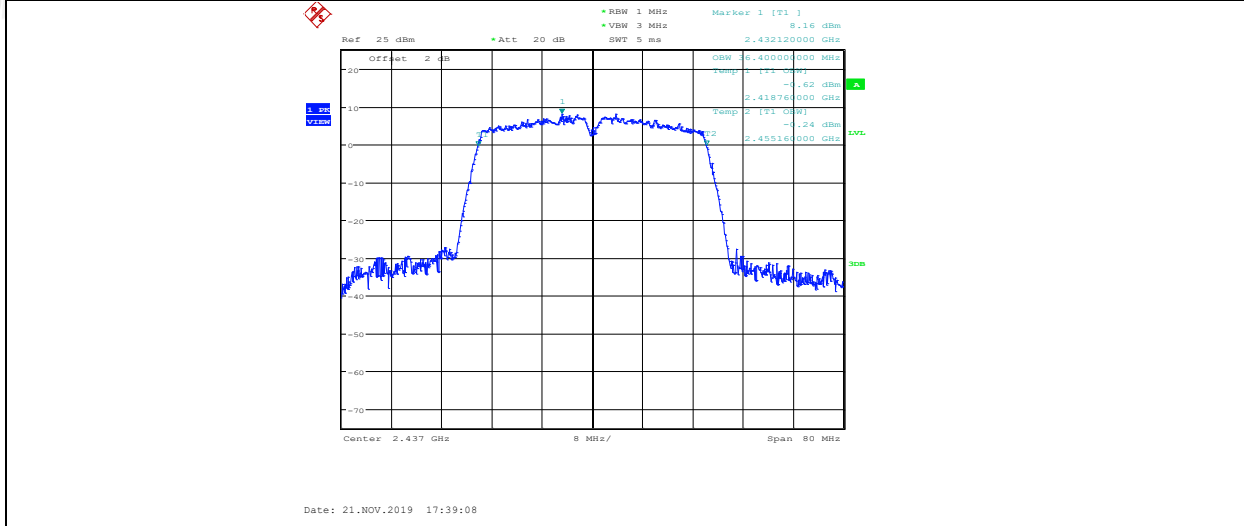

11N40MIMO_ANT1_2452



11N40MIMO_ANT2_2452

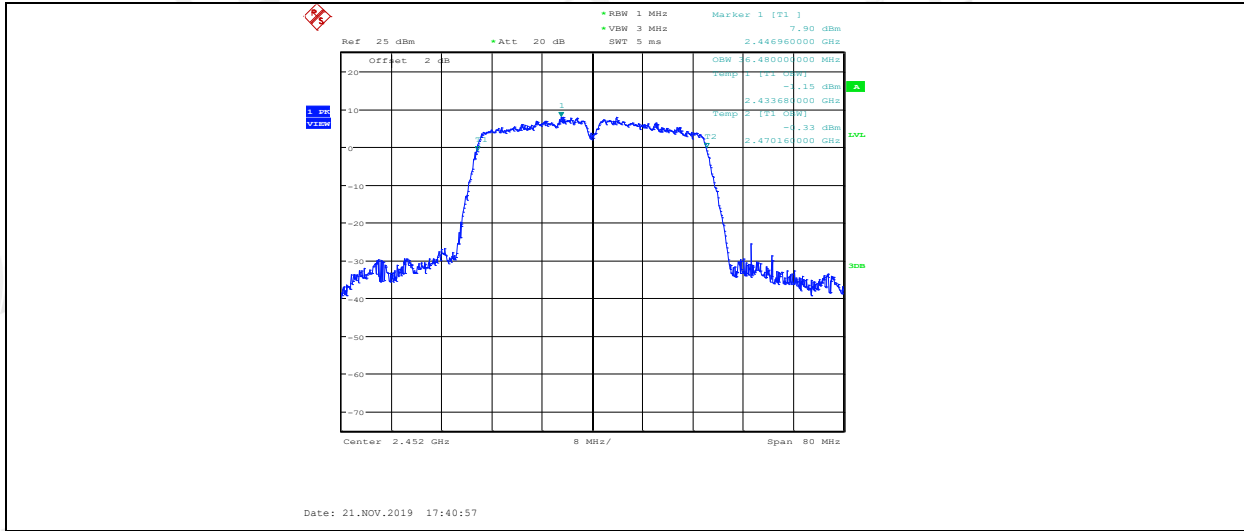

5. Conducted peak Output Power

5.1. Block diagram of test setup

Same as section 4.1

5.2. Limits

For systems using digital modulation in the 902-928 MHz, 2400-2483.5 MHz, and 5725-5850 MHz bands: 1 Watt. If transmitting antennas of directional gain greater than 6 dBi are used, the conducted output power from the intentional radiator shall be reduced below the stated values as appropriate, by the amount in dB that the directional gain of the antenna exceeds 6 dBi.

5.3. Test Procedure

Connect each EUT's antenna output to power sensor by RF cable and attenuator

Measure the PK output power of each antenna port by power sensor

5.4. Test Result

Test Mode	Test Channel	Ant	Power[dBm]	Limit[dBm]	Verdict
11B	2412	ANT1	15.68	30	PASS
11B	2412	ANT2	15.89	30	PASS
11B	2437	ANT1	15.95	30	PASS
11B	2437	ANT2	16.1	30	PASS
11B	2462	ANT1	15.45	30	PASS
11B	2462	ANT2	16.77	30	PASS
11G	2412	ANT1	22.75	30	PASS
11G	2412	ANT2	22.75	30	PASS
11G	2437	ANT1	23.02	30	PASS
11G	2437	ANT2	22.87	30	PASS
11G	2462	ANT1	22.35	30	PASS
11G	2462	ANT2	23.35	30	PASS
11N20MIMO	2412	ANT1	21.75	30	PASS
11N20MIMO	2412	ANT2	22.19	30	PASS
11N20MIMO	2412	total	25.01	30	PASS
11N20MIMO	2437	ANT1	21.97	30	PASS
11N20MIMO	2437	ANT2	22.12	30	PASS
11N20MIMO	2437	total	25.06	30	PASS
11N20MIMO	2462	ANT1	21.01	30	PASS
11N20MIMO	2462	ANT2	22.78	30	PASS
11N20MIMO	2462	total	25.00	30	PASS

11N40MIMO	2422	ANT1	19.91	30	PASS
11N40MIMO	2422	ANT2	20.37	30	PASS
11N40MIMO	2422	total	23.17	30	PASS
11N40MIMO	2437	ANT1	20.08	30	PASS
11N40MIMO	2437	ANT2	20.38	30	PASS
11N40MIMO	2437	total	23.26	30	PASS
11N40MIMO	2452	ANT1	20.24	30	PASS
11N40MIMO	2452	ANT2	20.35	30	PASS
11N40MIMO	2452	total	23.31	30	PASS

6. Power Spectral Density

6.1. Block diagram of test setup

Same as section 4.1

6.2. Limits

For digitally modulated systems, the power spectral density conducted from the intentional radiator to the antenna shall not be greater than 8 dBm in any 3 kHz band during any time interval of continuous transmission.

6.3. Test Procedure

- (1) Connect EUT's antenna output to spectrum analyzer by RF cable.
- (2) Set the spectrum analyzer as follows:

Center frequency	DTS Channel center frequency
RBW:	$3 \text{ kHz} \leq \text{RBW} \leq 100 \text{ kHz}$
VBW:	$\geq 3\text{RBW}$
Span	1.5 times the DTS bandwidth
Detector Mode:	RMS
Sweep time:	auto
Trace mode	Max hold

- (3) Allow the trace to stabilize, use the peak marker function to determine the maximum amplitude level within the RBW.
- (4) If measured value exceeds limit, reduce RBW (no less than 3 kHz) and repeat.

6.4. Test Result

TestMode	Antenna	Channel [MHz]	Result [dBm/ 3 kHz]	Limit [dBm/ 3 kHz]	Verdict
11B	ANT1	2412	-13.26	8	PASS
11B	ANT2	2412	-13.55	8	PASS
11B	ANT1	2437	-13.18	8	PASS
11B	ANT2	2437	-13.41	8	PASS
11B	ANT1	2462	-13.26	8	PASS
11B	ANT2	2462	-11.12	8	PASS
11G	ANT1	2412	-12.04	8	PASS
11G	ANT2	2412	-12.57	8	PASS
11G	ANT1	2437	-12.17	8	PASS
11G	ANT2	2437	-12.83	8	PASS
11G	ANT1	2462	-12.55	8	PASS
11G	ANT2	2462	-10.83	8	PASS
11N20MIMO	ANT1	2412	-12.31	8	PASS
11N20MIMO	ANT2	2412	-13.83	8	PASS
11N20MIMO	total	2412	-9.99	8	PASS

11N20MIMO	ANT1	2437	-13.45	8	PASS
11N20MIMO	ANT2	2437	-13.45	8	PASS
11N20MIMO	total	2437	-10.44	8	PASS
11N20MIMO	ANT1	2462	-14.17	8	PASS
11N20MIMO	ANT2	2462	-11.62	8	PASS
11N20MIMO	total	2462	-9.70	8	PASS
11N40MIMO	ANT1	2422	-17.31	8	PASS
11N40MIMO	ANT2	2422	-16.78	8	PASS
11N40MIMO	total	2422	-14.03	8	PASS
11N40MIMO	ANT1	2437	-17.67	8	PASS
11N40MIMO	ANT2	2437	-17.42	8	PASS
11N40MIMO	total	2437	-14.53	8	PASS
11N40MIMO	ANT1	2452	-17	8	PASS
11N40MIMO	ANT2	2452	-16.99	8	PASS
11N40MIMO	total	2452	-13.98	8	PASS

6.5. original test data

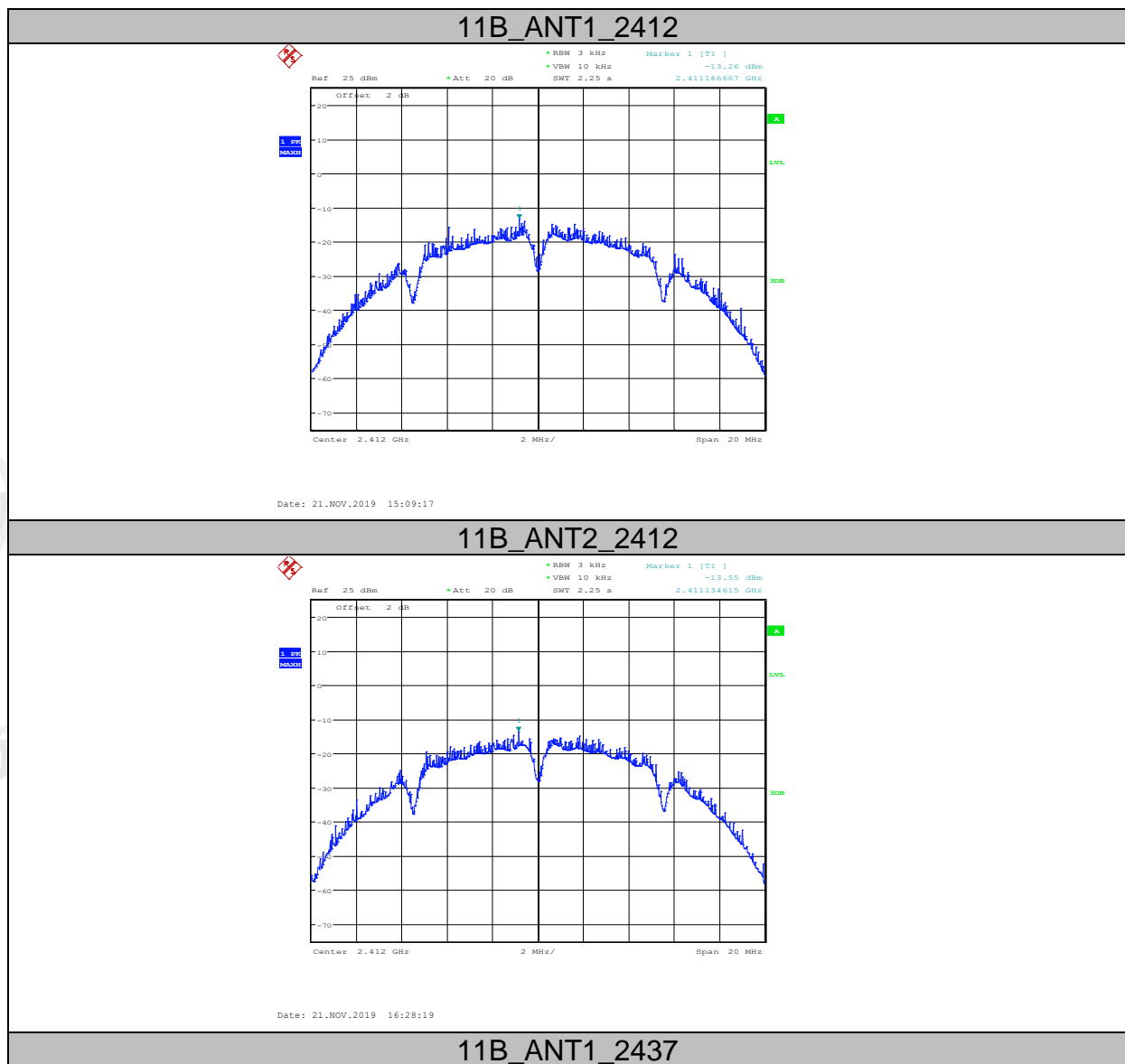

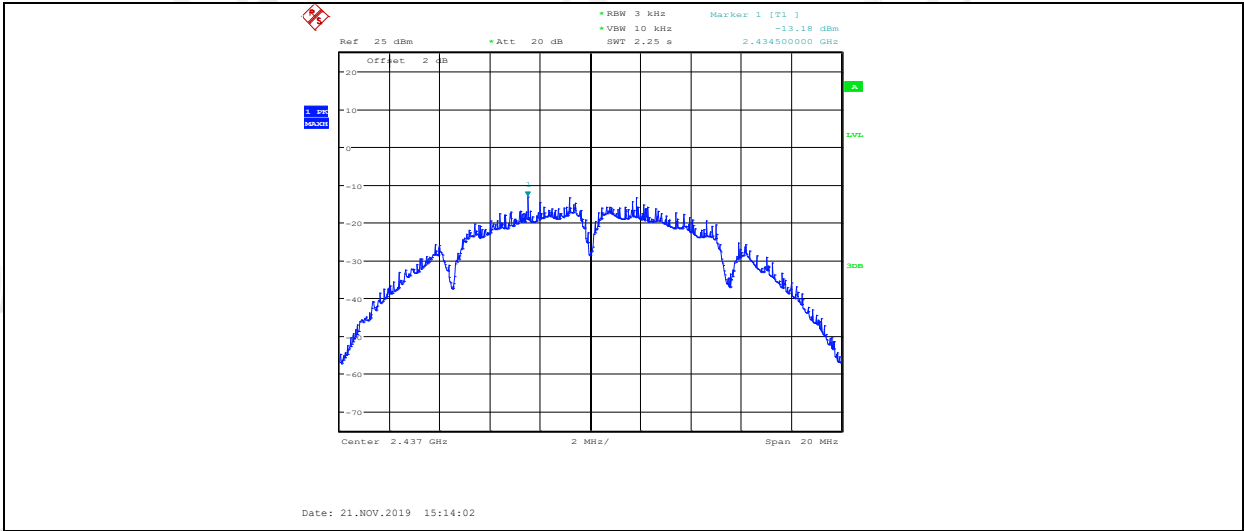

11B_ANT2_2437

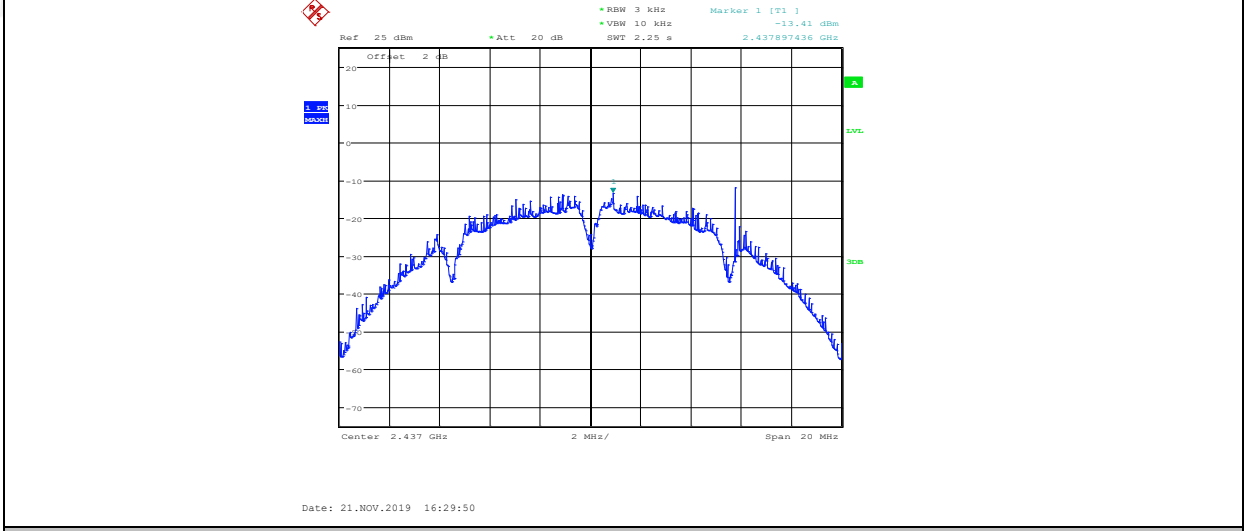

11B_ANT1_2462

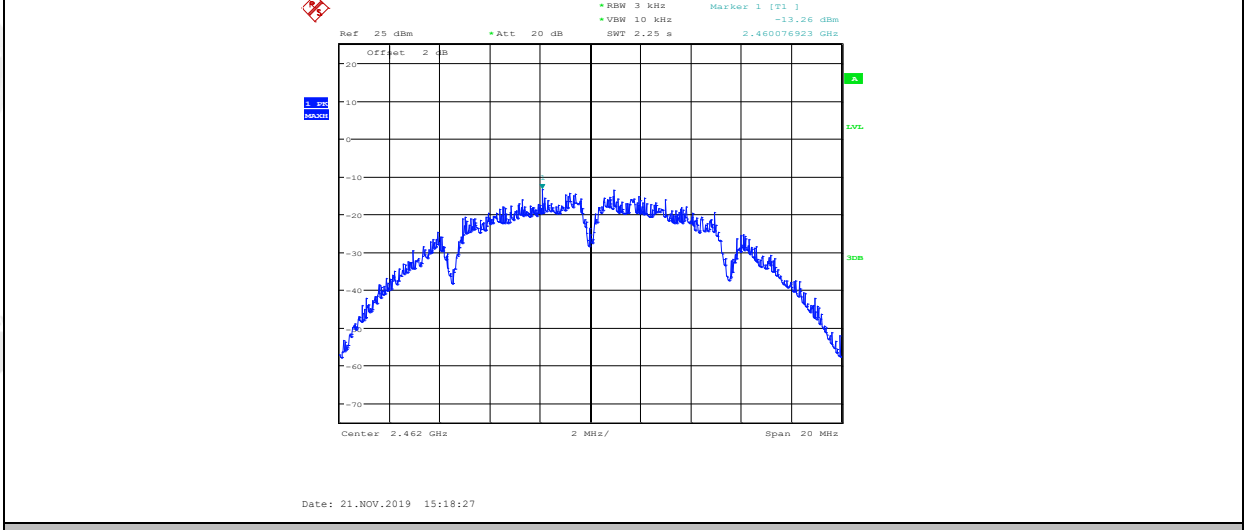

11B_ANT2_2462



11G_ANT1_2412

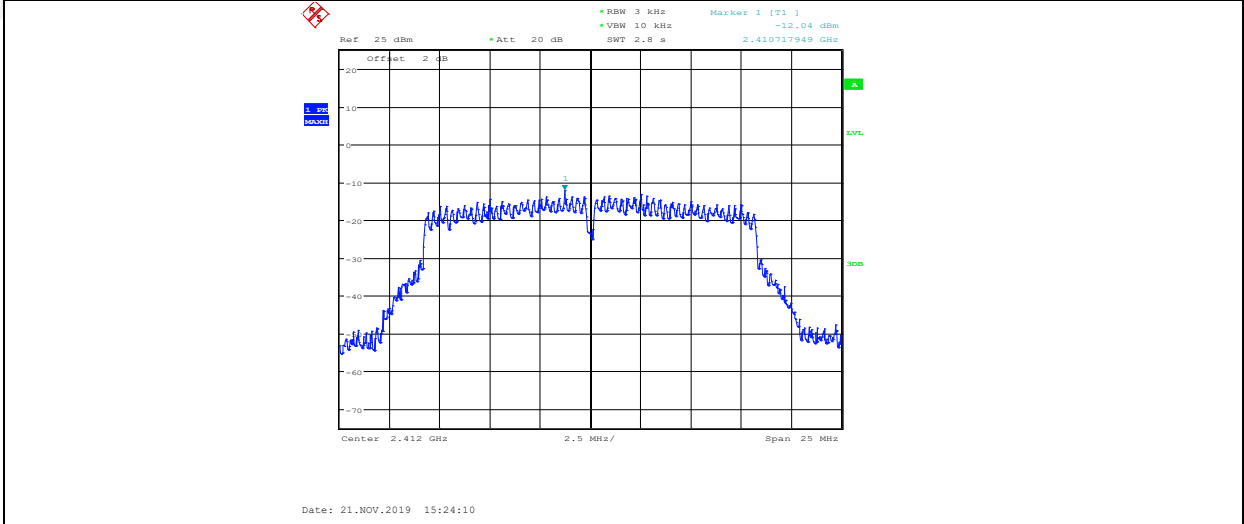

11G_ANT2_2412

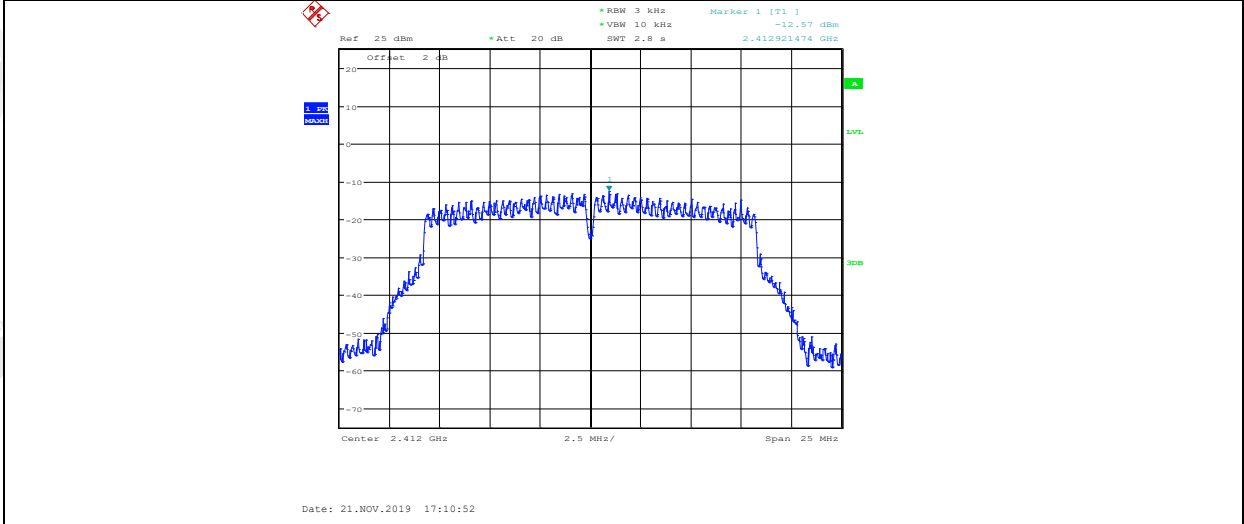

11G_ANT1_2437

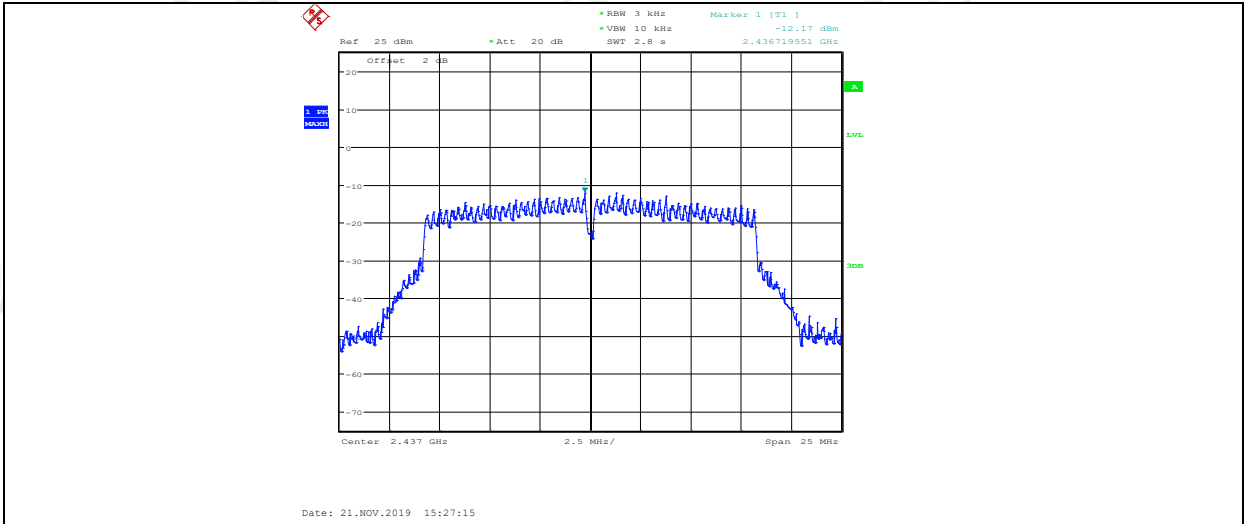

11G_ANT2_2437

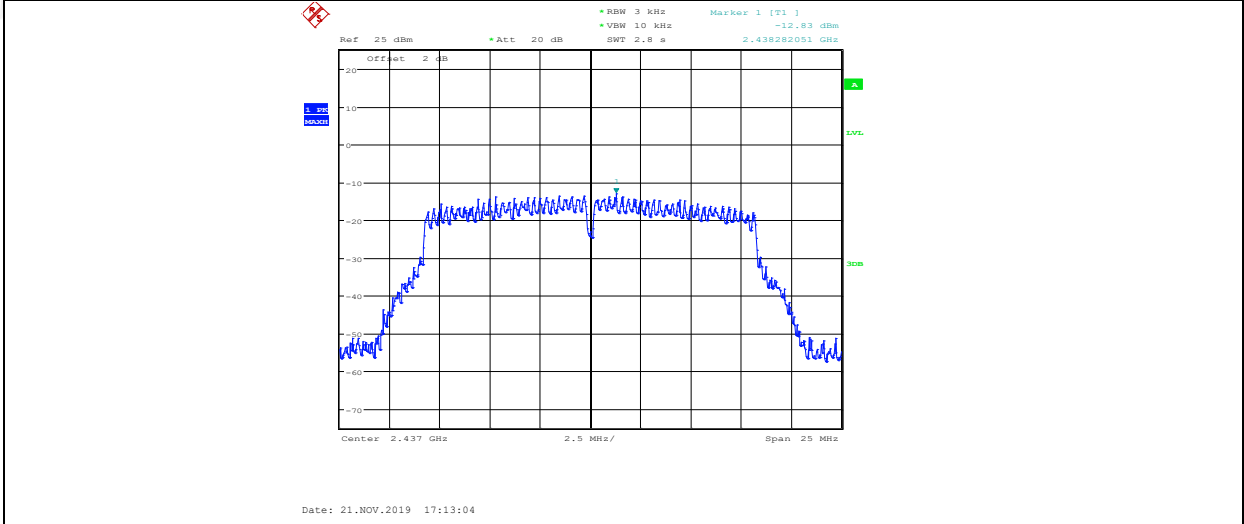

11G_ANT1_2462

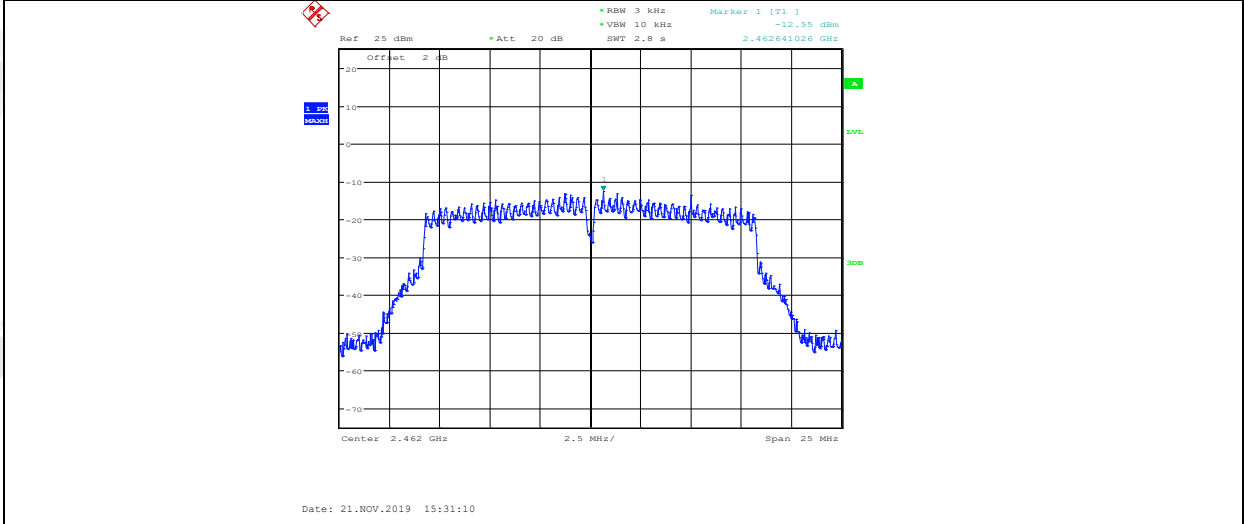

11G_ANT2_2462

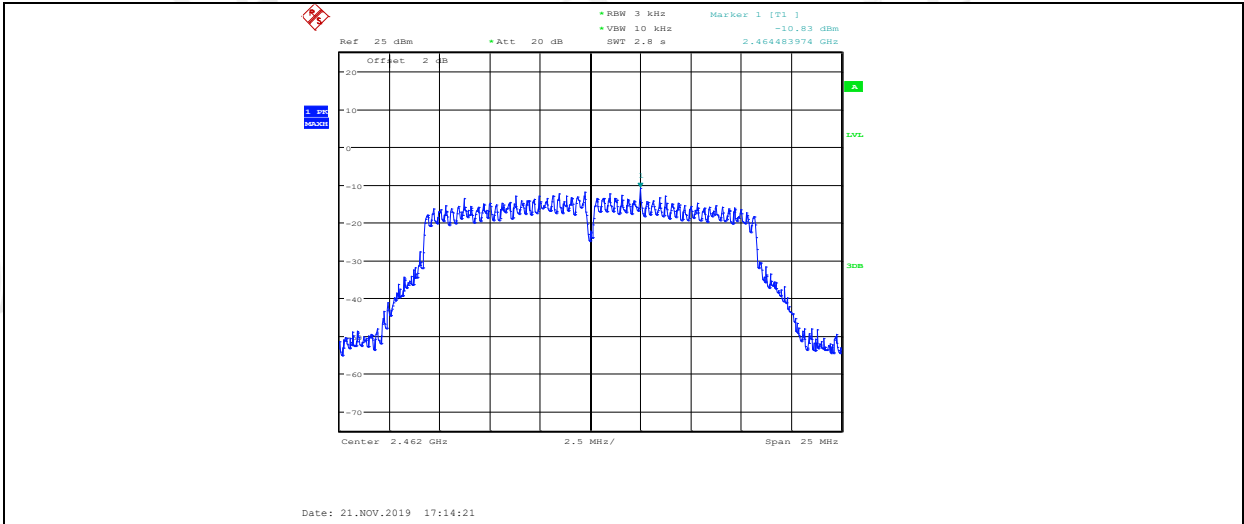

11N20MIMO_ANT1_2412

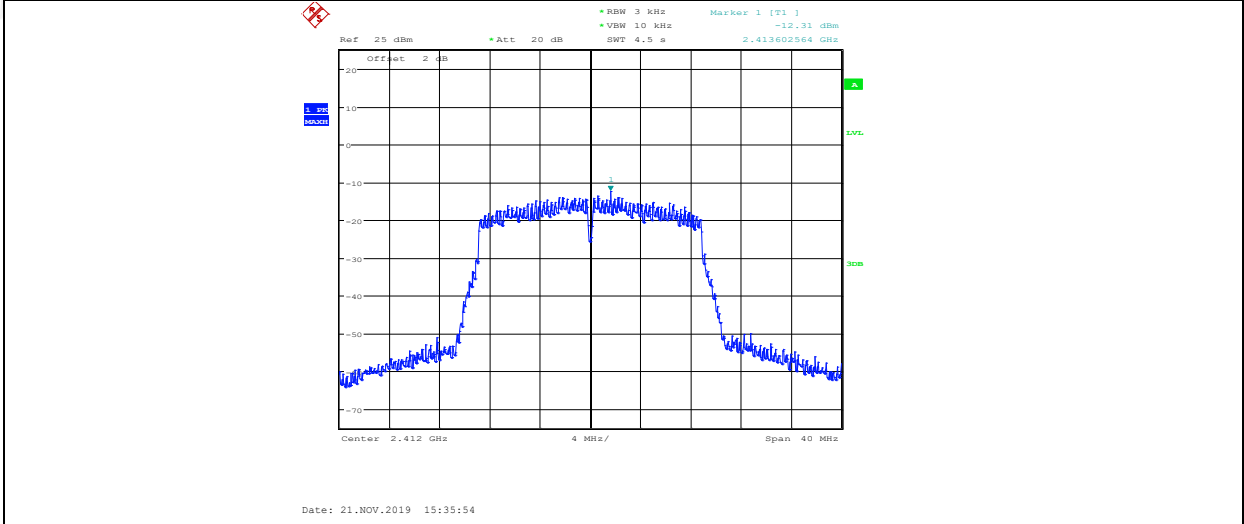

11N20MIMO_ANT2_2412

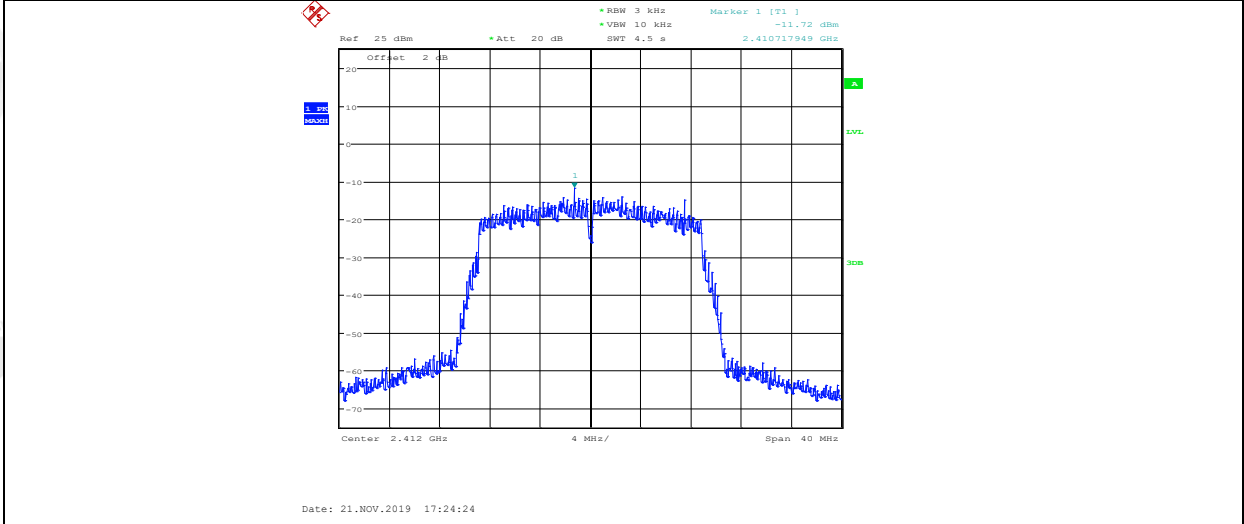

11N20MIMO_ANT1_2437

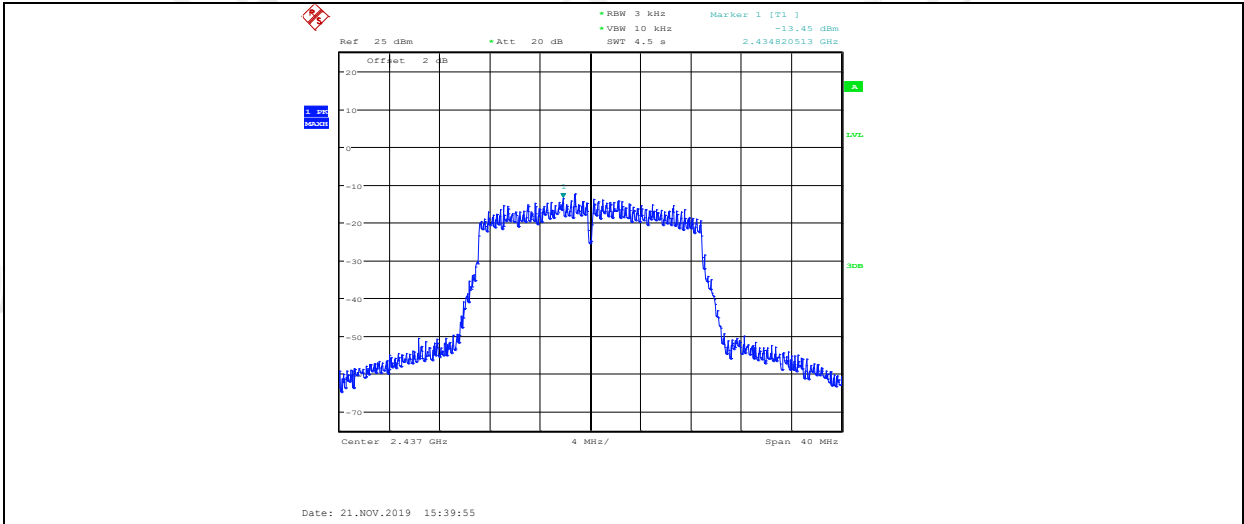

11N20MIMO_ANT2_2437

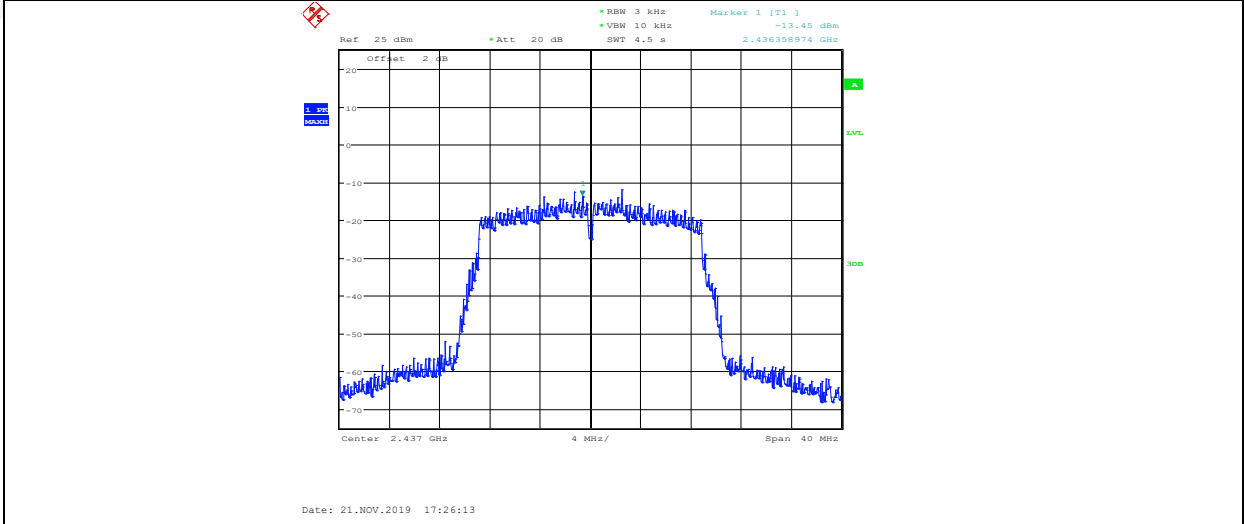

11N20MIMO_ANT1_2462

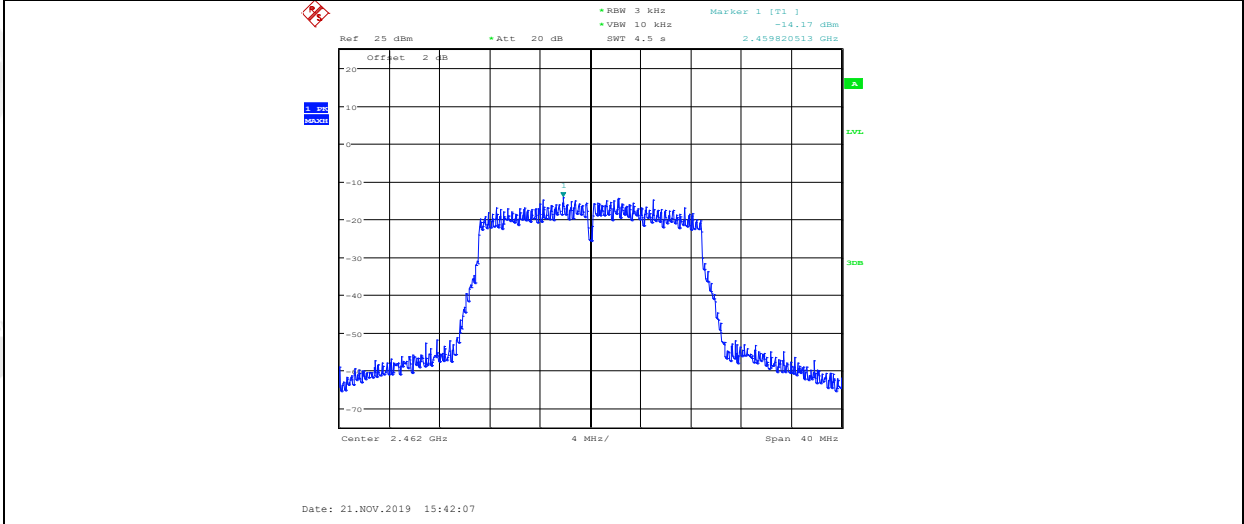

11N20MIMO_ANT2_2462

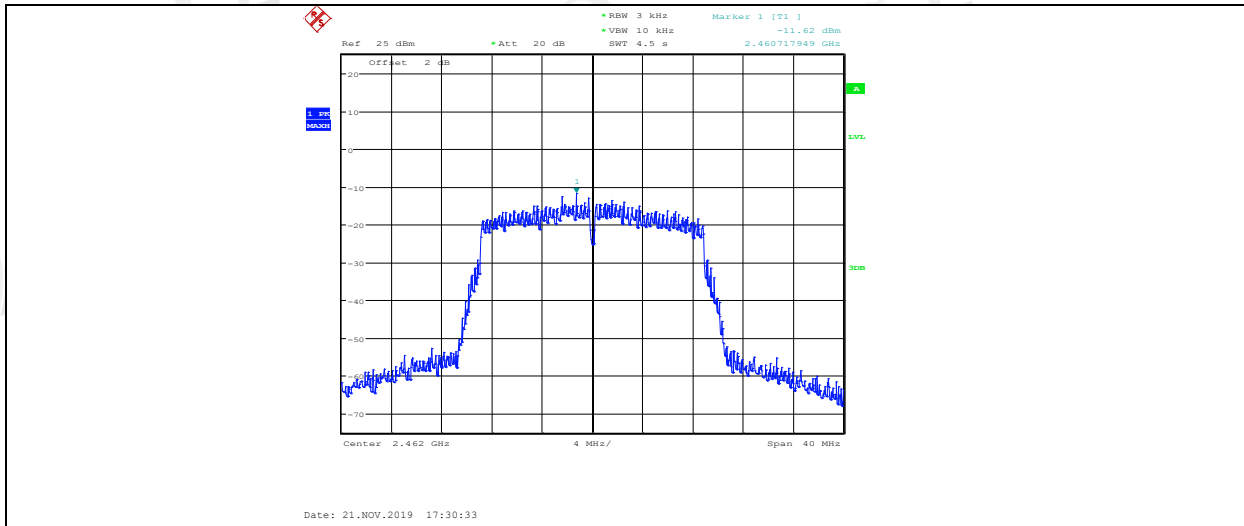

11N40MIMO_ANT1_2422

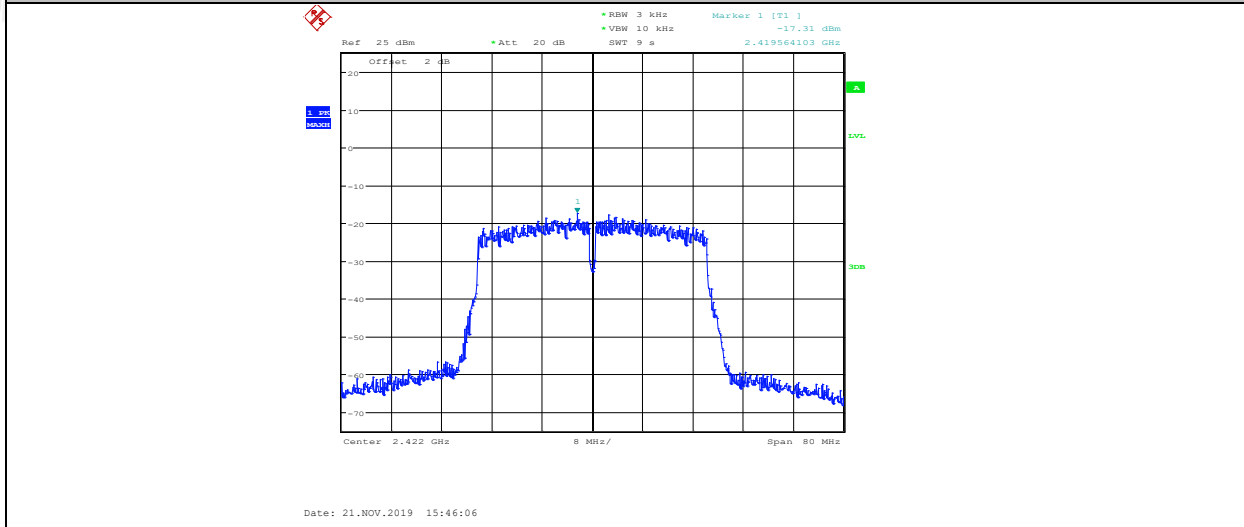

11N40MIMO_ANT2_2422

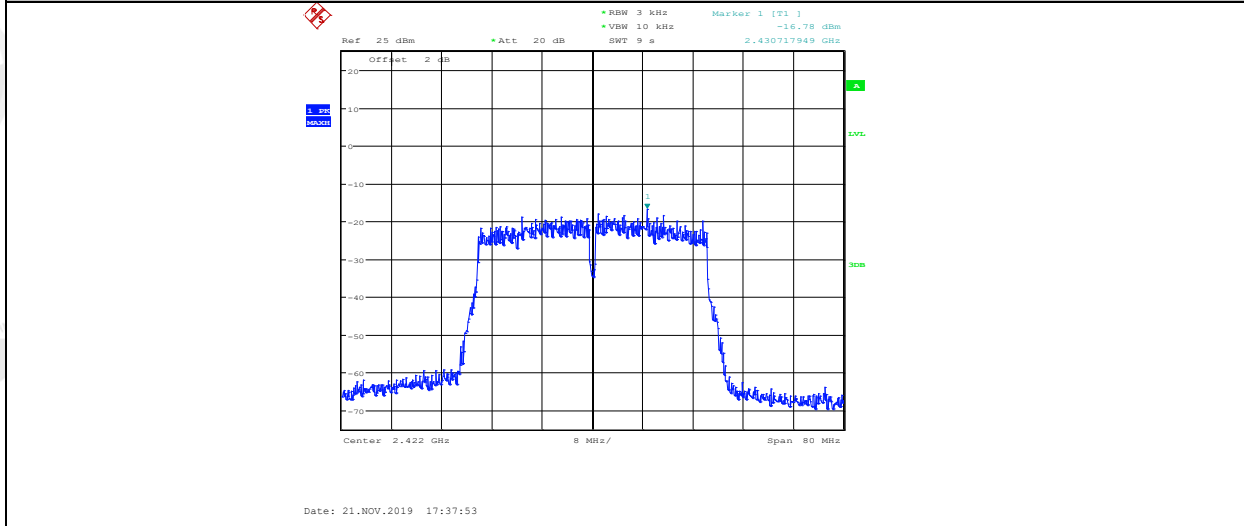

11N40MIMO_ANT1_2437

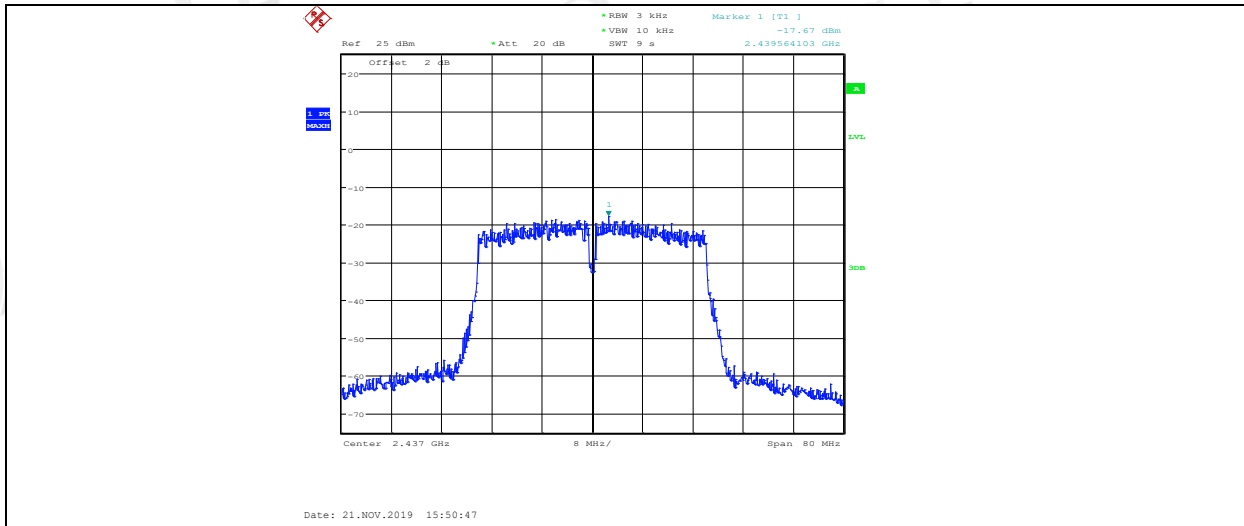

11N40MIMO_ANT2_2437

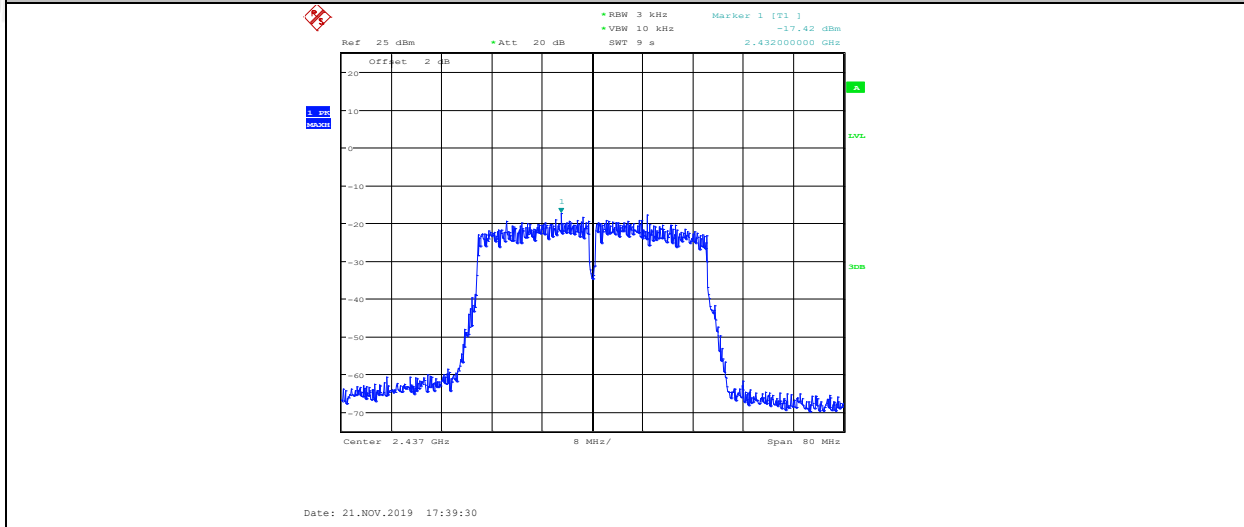

11N40MIMO_ANT1_2452

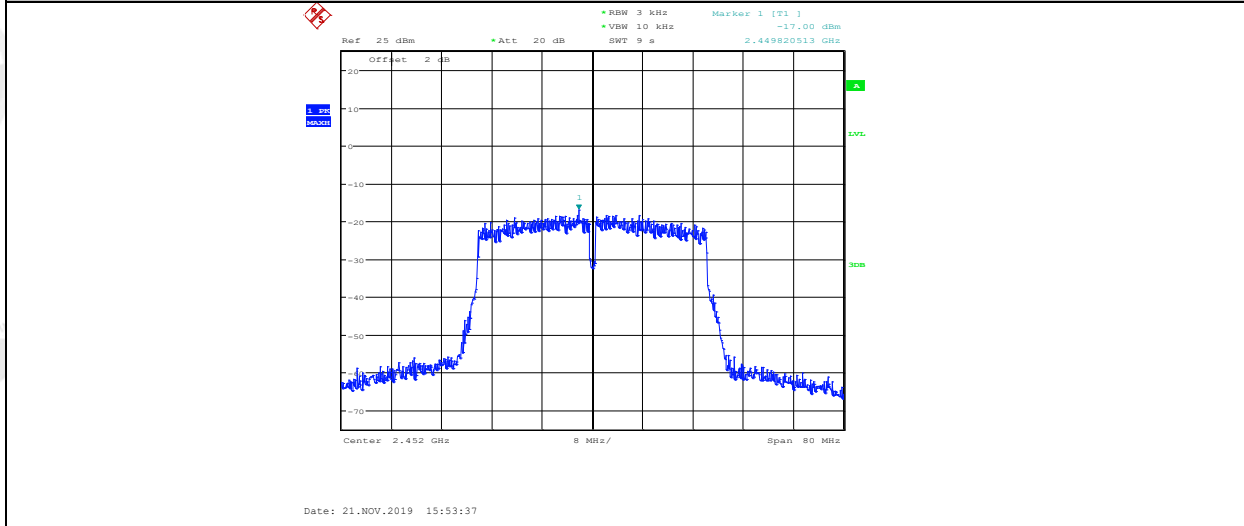

11N40MIMO_ANT2_2452

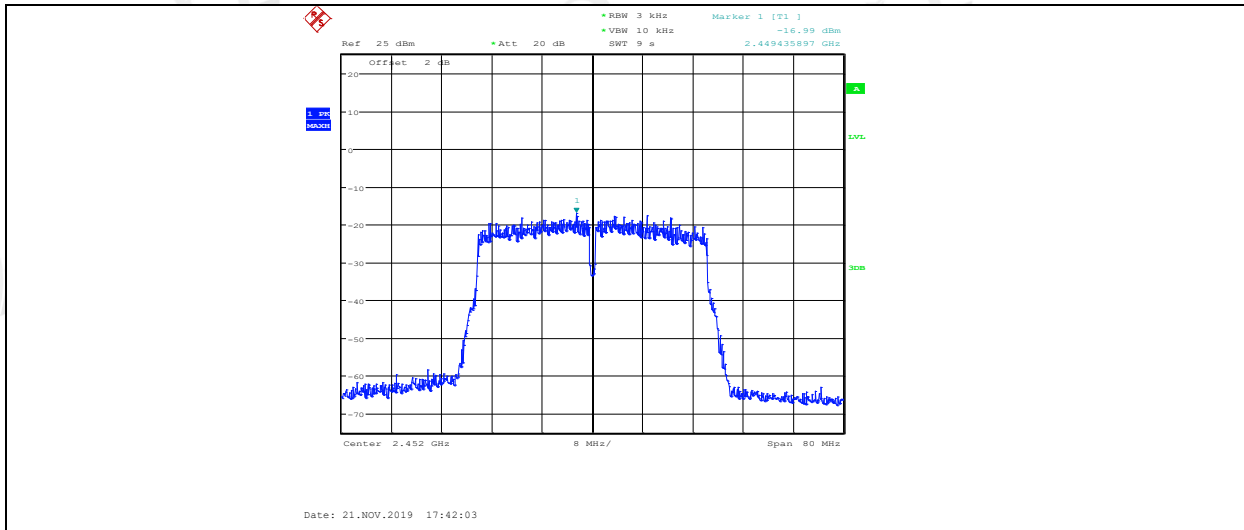

7. Band Edge and Spurious Emissions (Conducted)

7.1. Block diagram of test setup

Same as section 4.1

7.2. Limits

In any 100 kHz bandwidth outside the frequency bands in which the spread spectrum intentional radiator is operating, the radio frequency power that is produced by the intentional radiator shall be at least 30 dB below that in the 100 kHz bandwidth within the band that contains the highest level of the desired power.

7.3. Test Procedure

(1) Connect EUT's antenna output to spectrum analyzer by RF cable.

(2) Establish a reference level by using the following procedure:

Center frequency	DTS Channel center frequency
RBW:	100 kHz
VBW:	300 kHz
Span	1.5 times the DTS bandwidth
Detector Mode:	Peak
Sweep time:	auto
Trace mode	Max hold

(3) Allow the trace to stabilize, use the peak marker function to determine the maximum peak power level to establish the reference level.

(4) Set the spectrum analyzer as follows:

RBW:	100 kHz
VBW:	300 kHz
Span	Encompass frequency range to be measured
Number of measurement points	$\geq \text{span}/\text{RBW}$
Detector Mode:	Peak
Sweep time:	auto
Trace mode	Max hold

(5) Allow the trace to stabilize, use the peak marker function to determine the maximum amplitude of all unwanted emissions outside of the authorized frequency band

7.4. Test Result

EUT Set Mode	CH or Frequency	Ant1 Result (dBm)	EUT Set Mode	CH or Frequency	Ant1 Result (dBm)
11b	CH1	PASS	11n HT 20	CH1	PASS
	CH6	PASS		CH6	PASS
	CH11	PASS		CH11	PASS
11g	CH1	PASS	11n HT 40	CH3	PASS
	CH6	PASS		CH6	PASS
	CH11	PASS		CH9	PASS

EUT Set Mode	CH or Frequency	Ant2 Result (dBm)	EUT Set Mode	CH or Frequency	Ant2 Result (dBm)
11b	CH1	PASS	11n HT 20	CH1	PASS
	CH6	PASS		CH6	PASS
	CH11	PASS		CH11	PASS
11g	CH1	PASS	11n HT 40	CH3	PASS
	CH6	PASS		CH6	PASS
	CH11	PASS		CH9	PASS

7.5. original test data

Band Edge

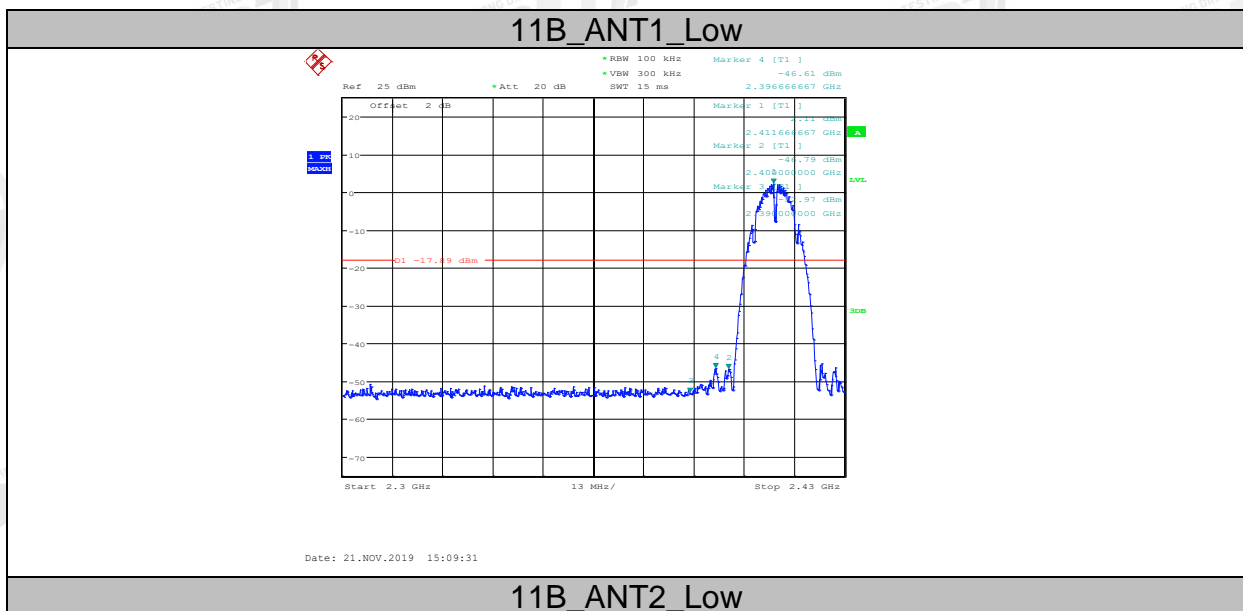

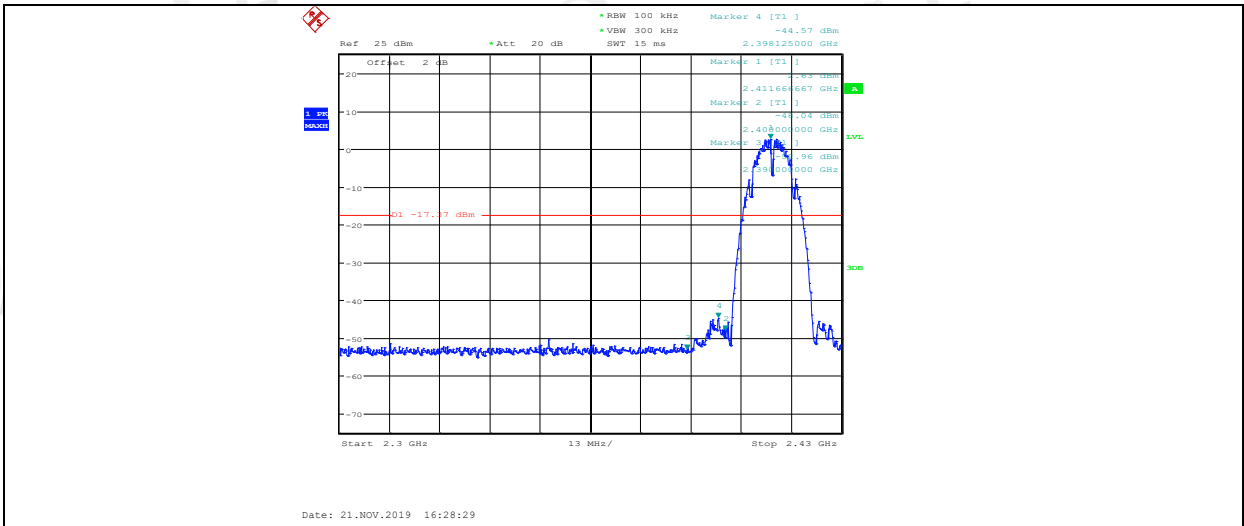

11B_ANT1_High

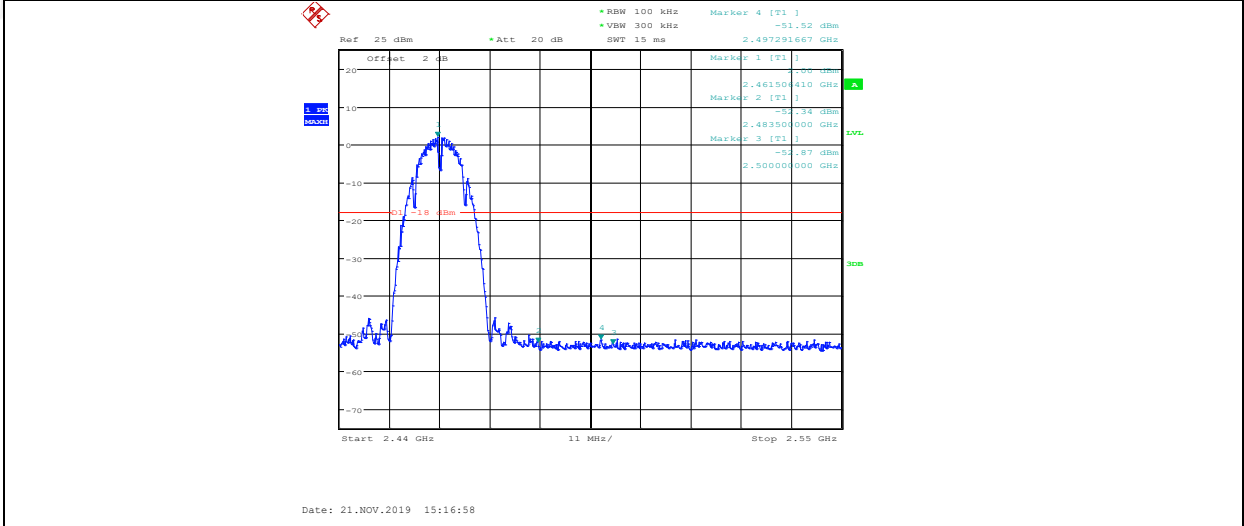

11B_ANT2_High

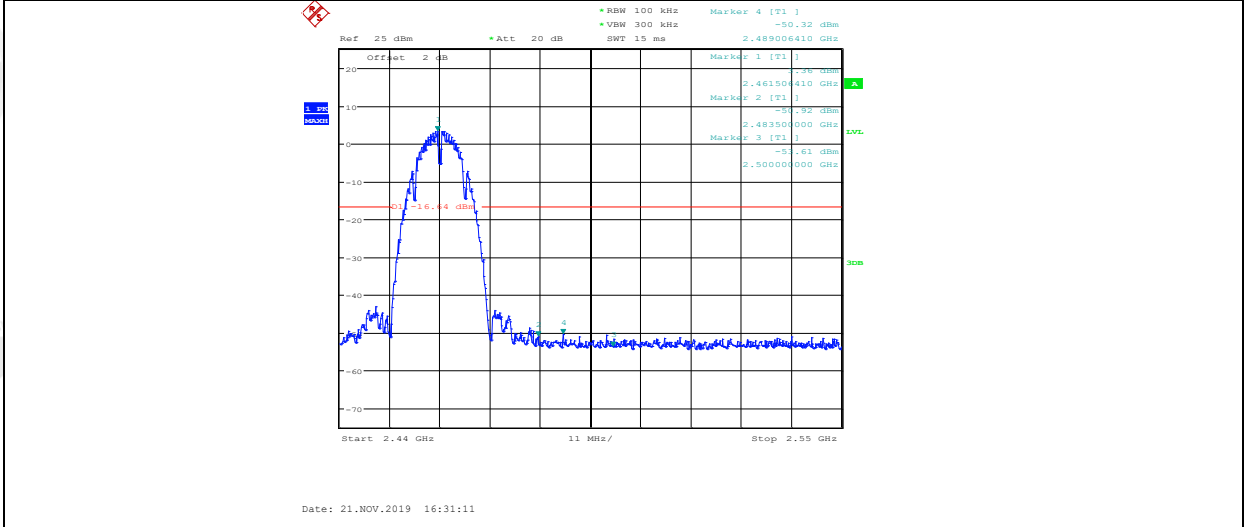

11G_ANT1_Low

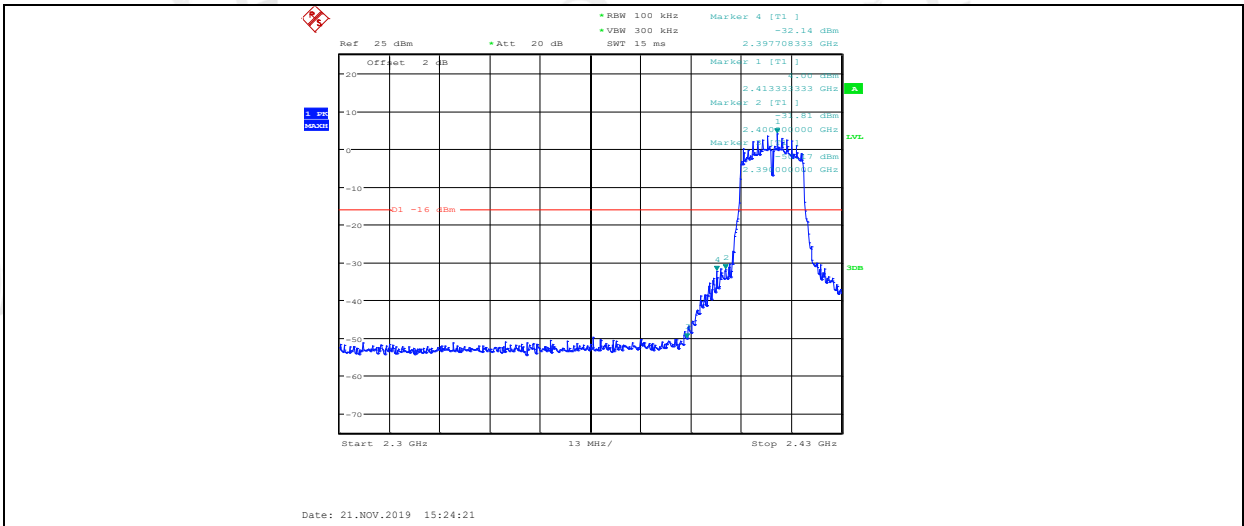

11G_ANT2_Low

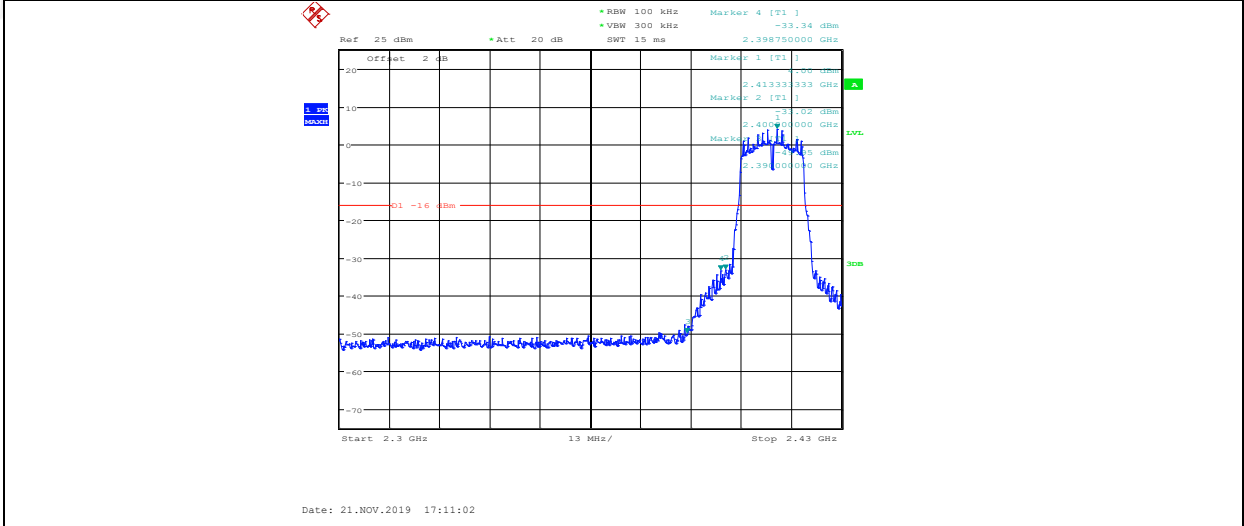

11G_ANT1_High

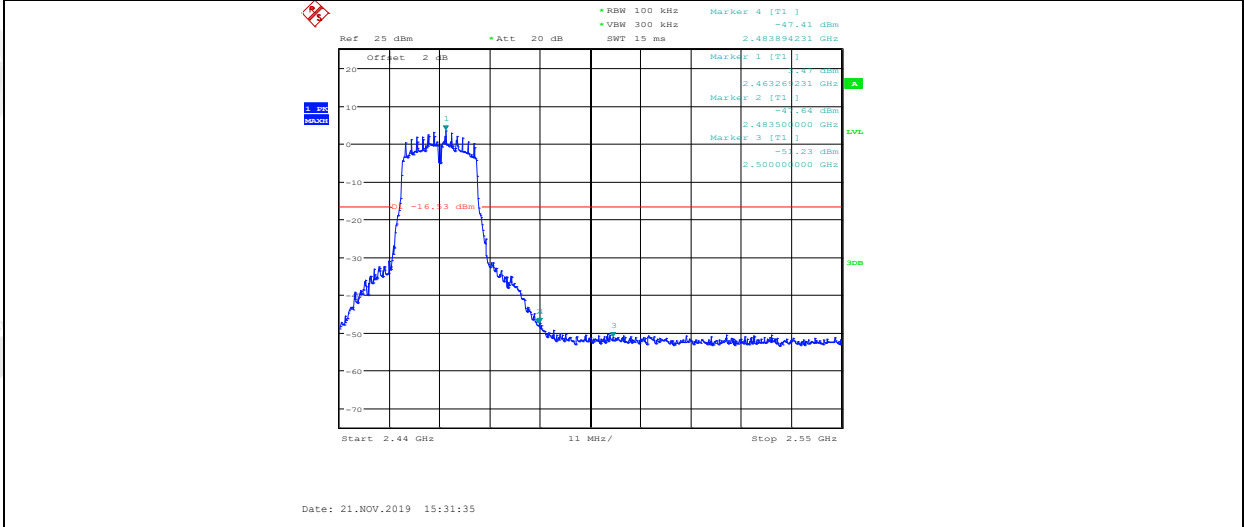

11G_ANT2_High

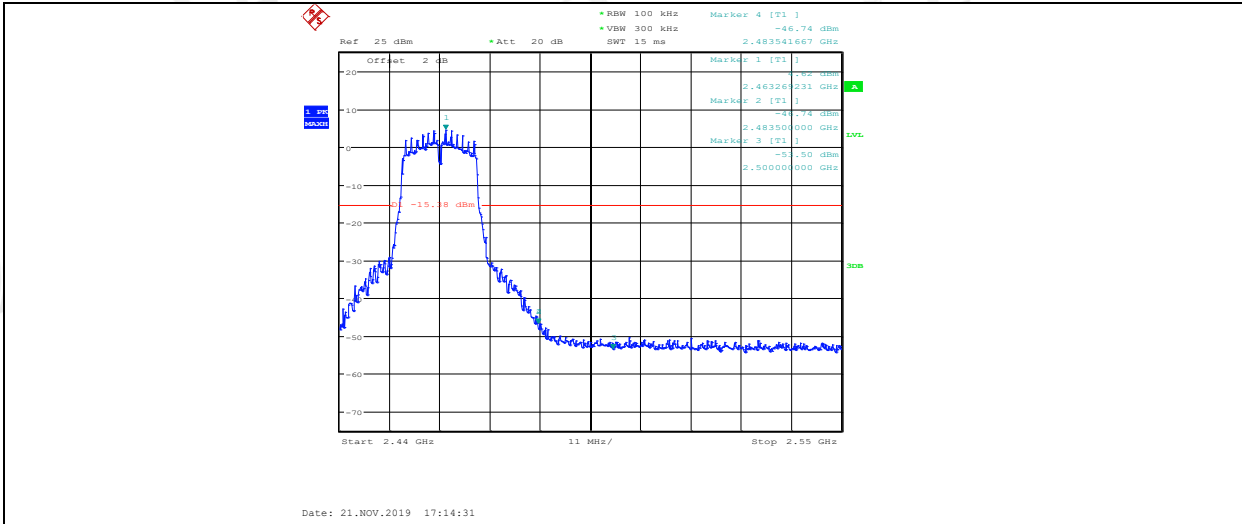

11N20MIMO_ANT1_Low

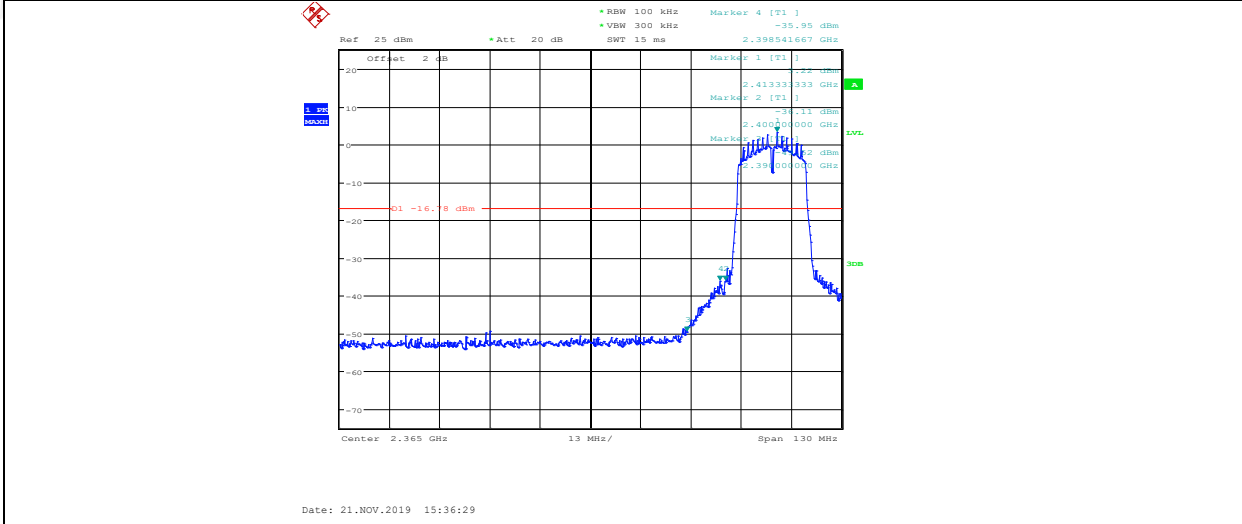

11N20MIMO_ANT2_Low

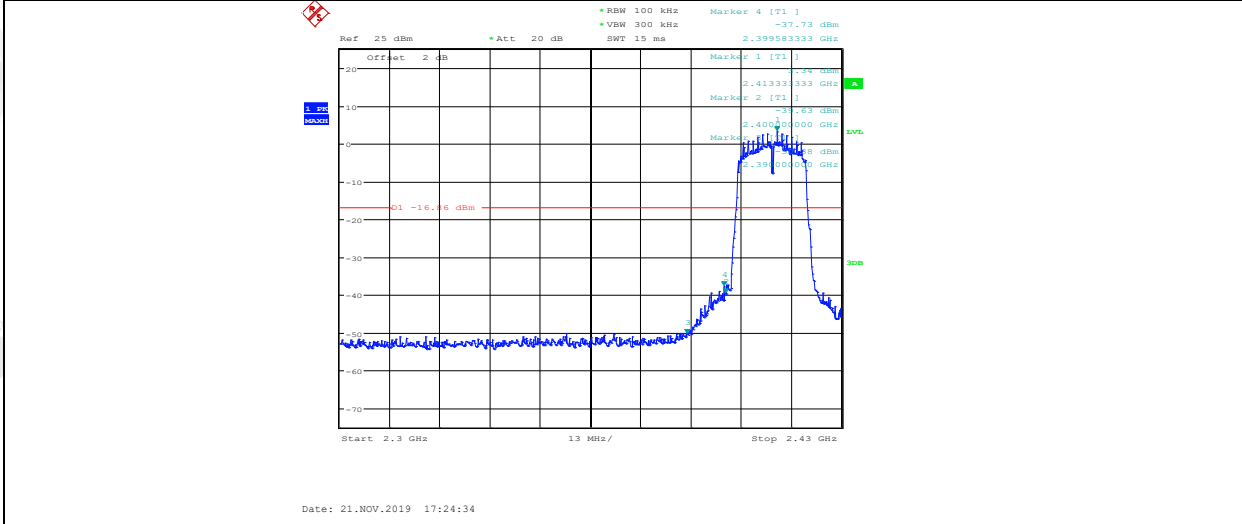

11N20MIMO_ANT1_High

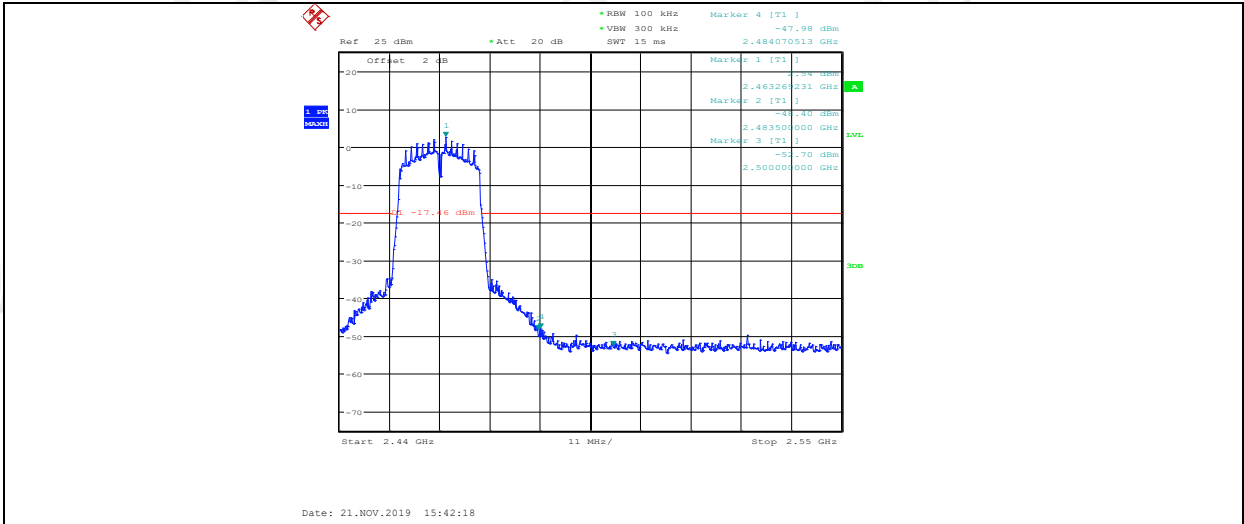

11N20MIMO_ANT2_High

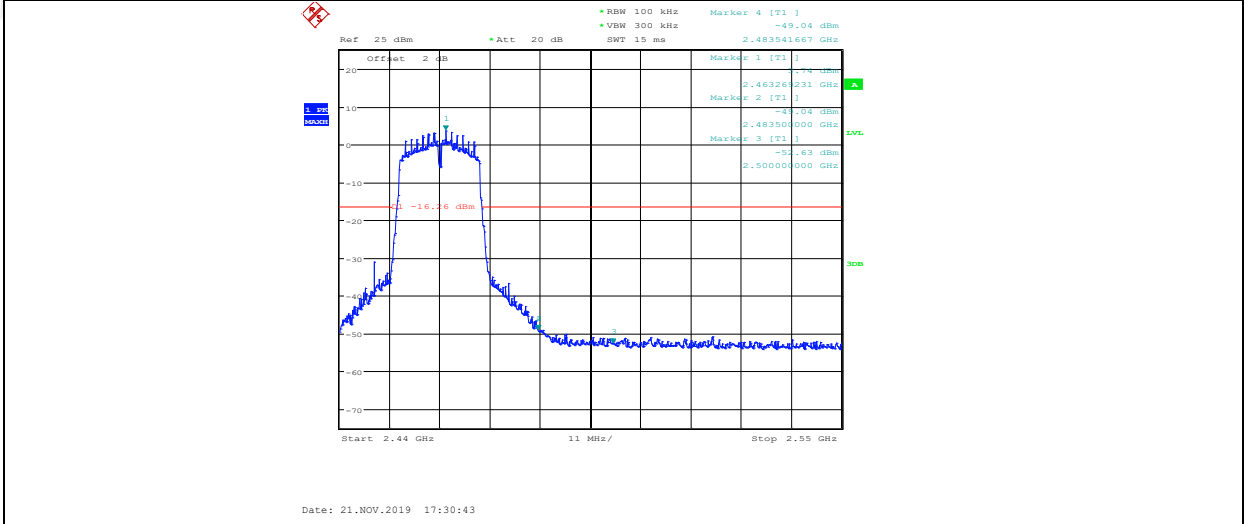

11N40MIMO_ANT1_Low

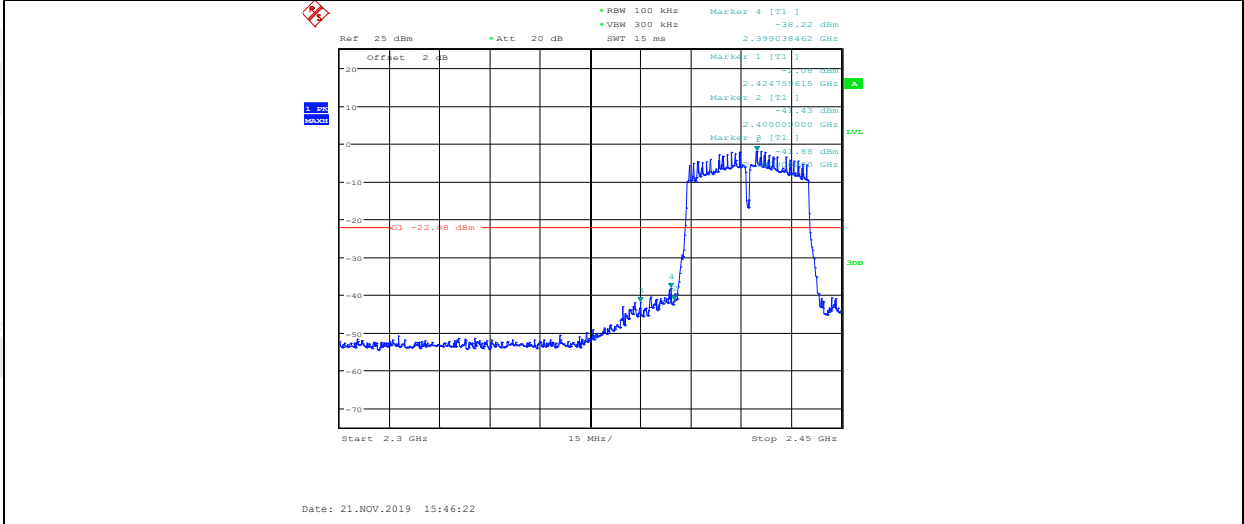

11N40MIMO_ANT2_Low

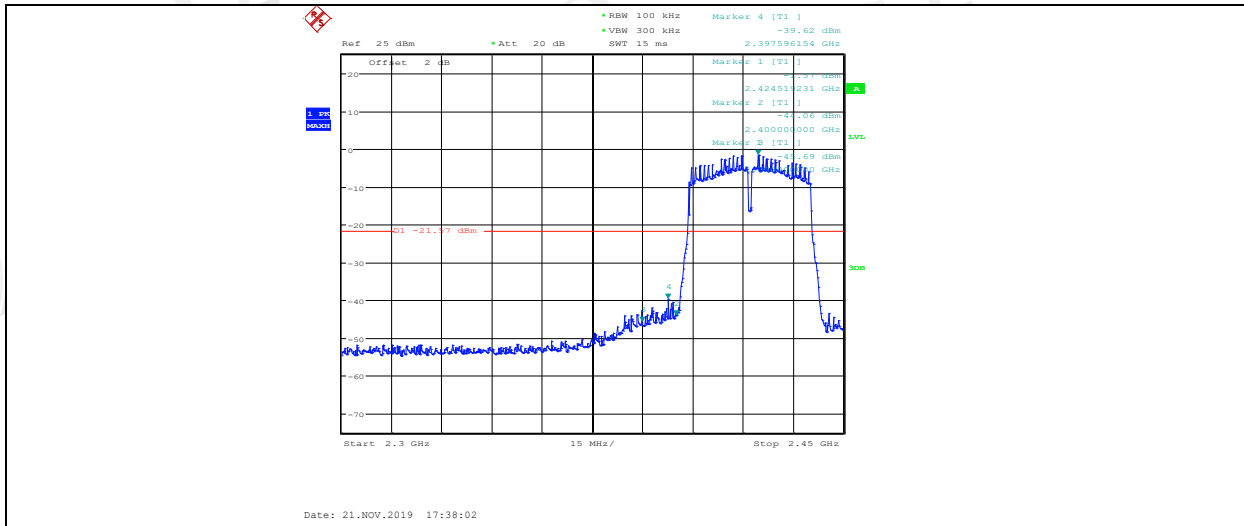

Date: 21.NOV.2019 17:38:02

11N40MIMO_ANT1_High

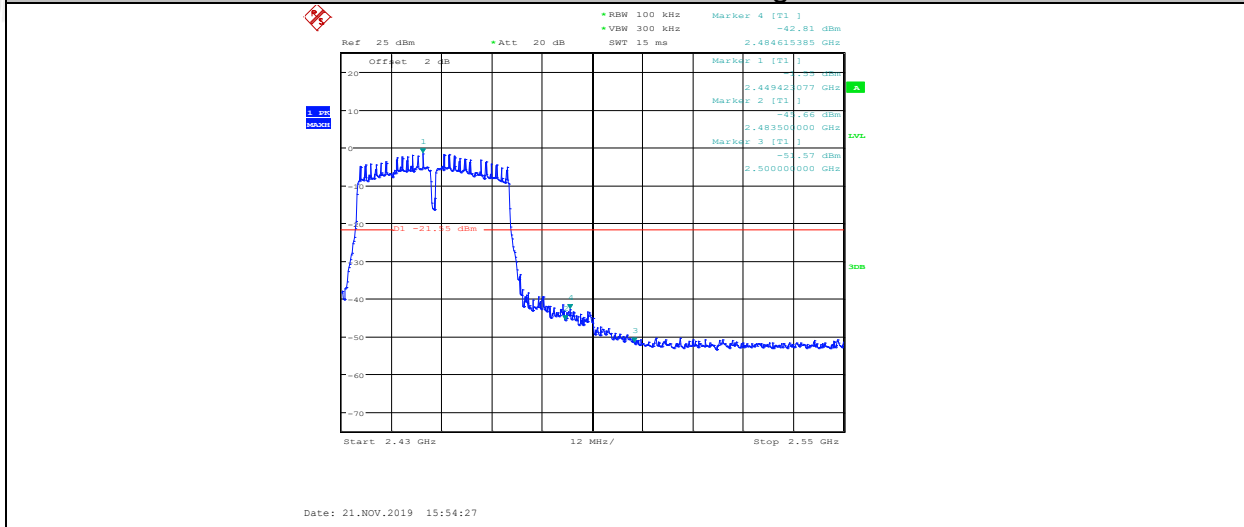

Date: 21.NOV.2019 15:54:27

11N40MIMO_ANT2_High

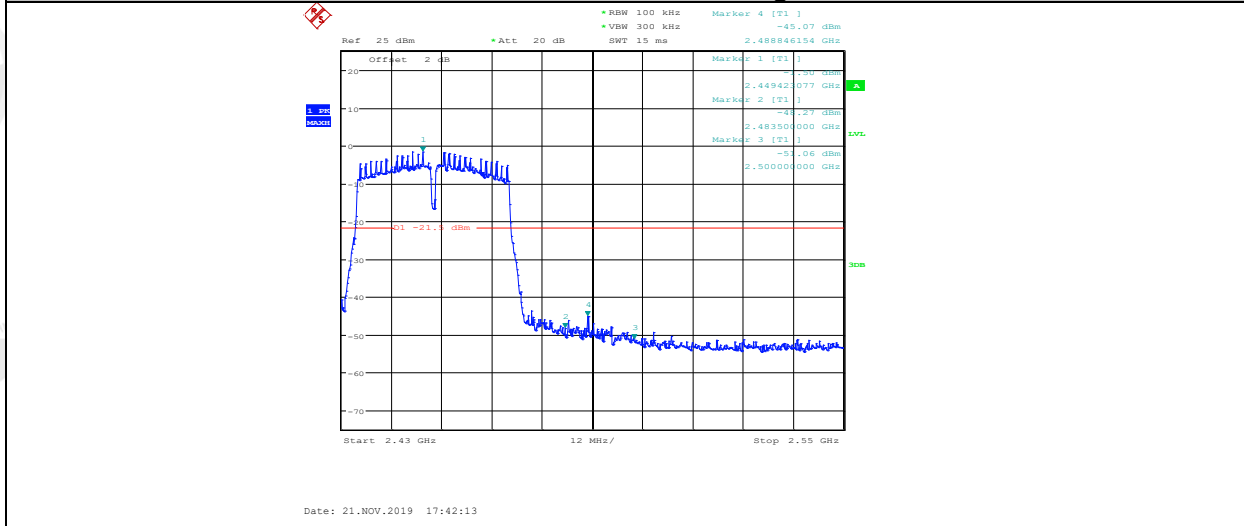

Date: 21.NOV.2019 17:42:13

Spurious Emissions

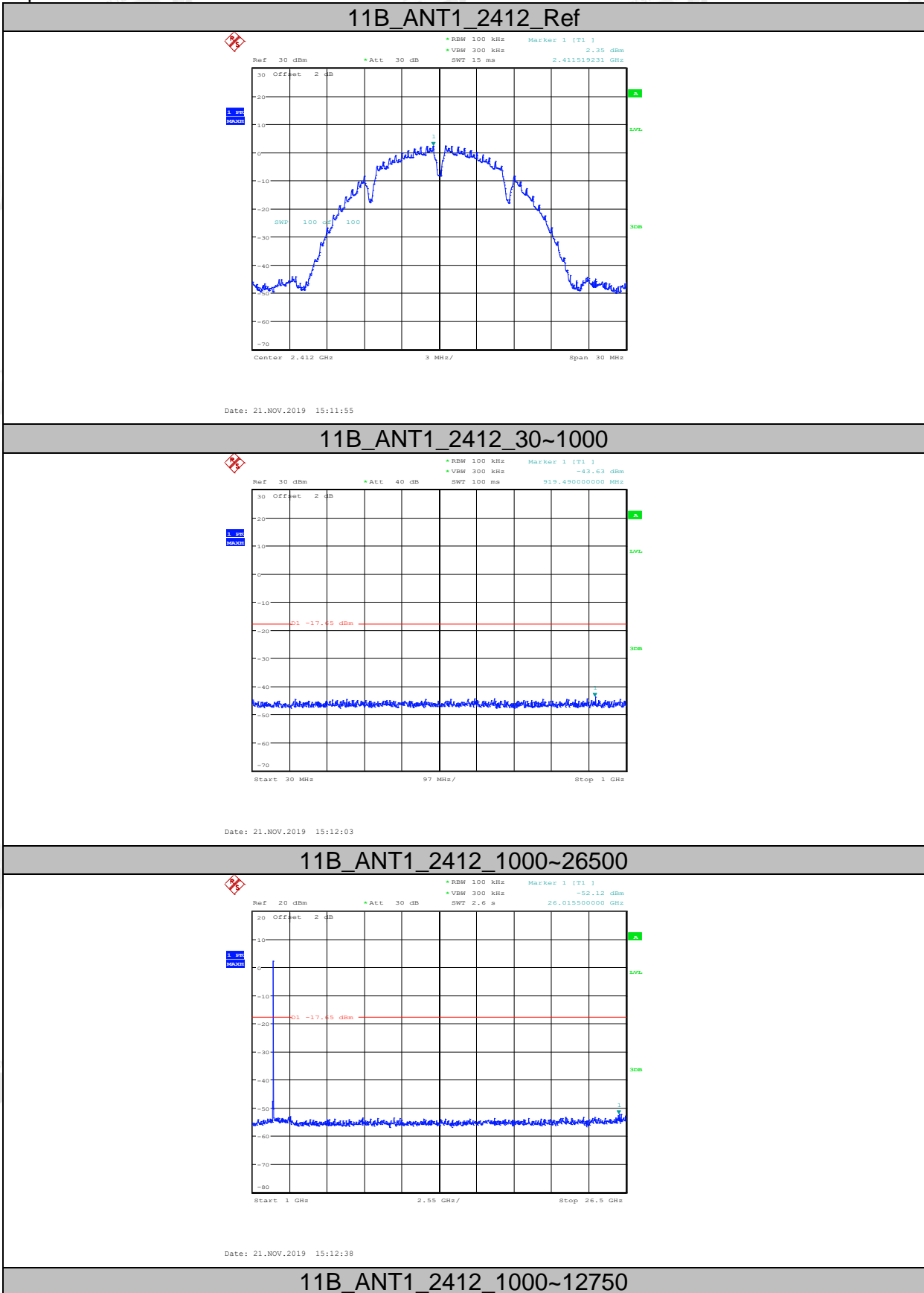

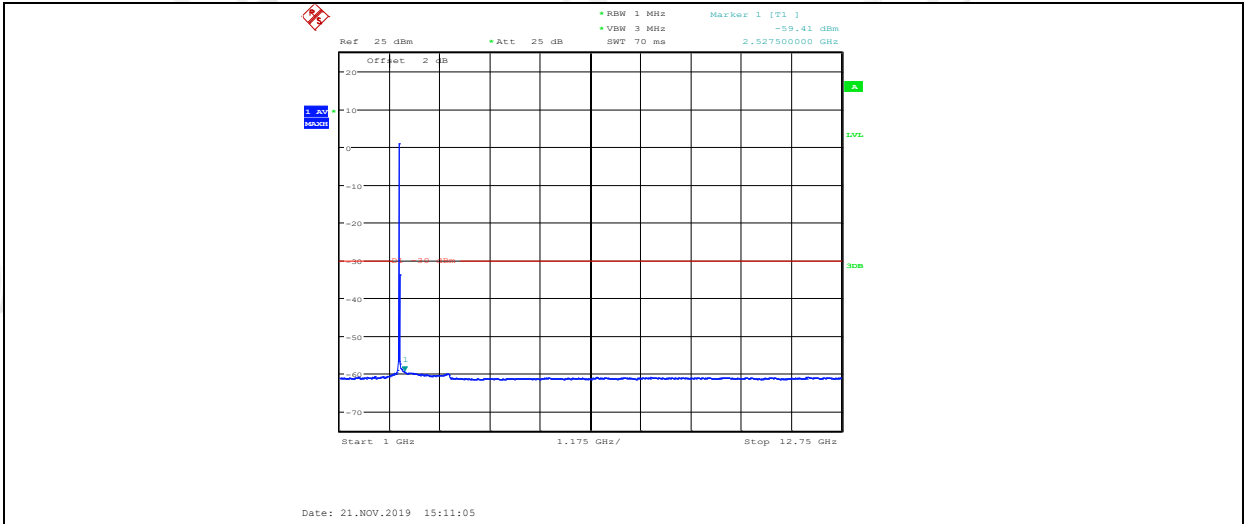

11B_ANT1_2412_2400~2483.5

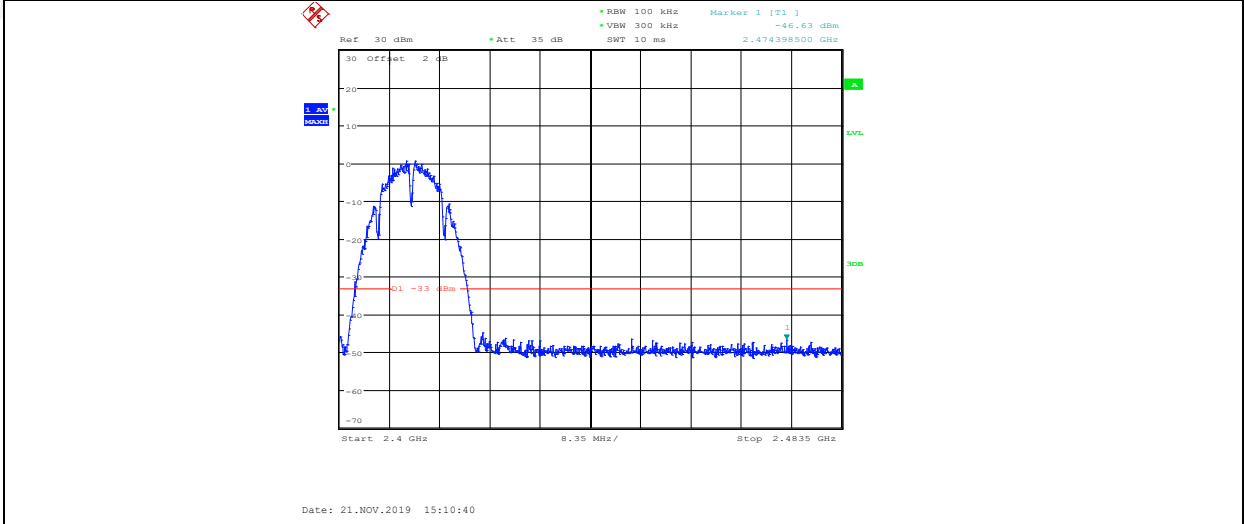

11B_ANT1_2412_3400~3530

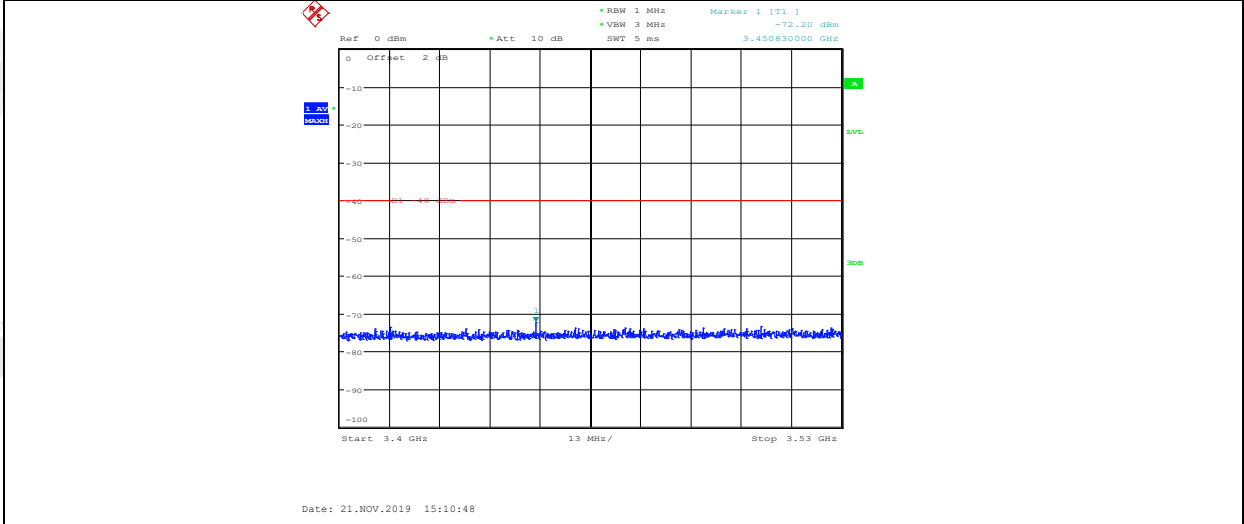

11B_ANT1_2412_5725~5850

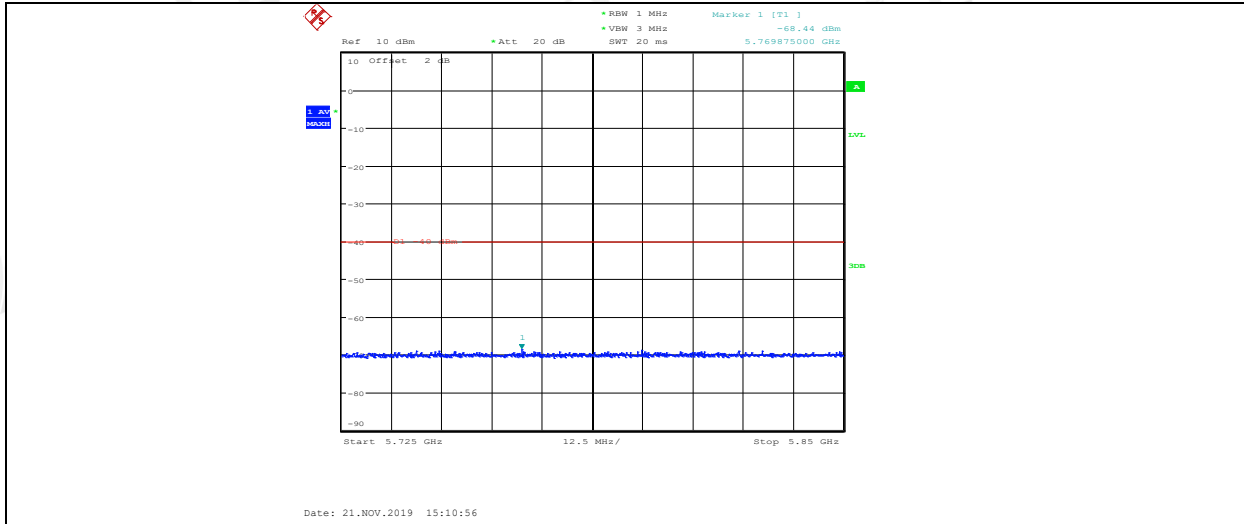

11B_ANT2_2412_Ref

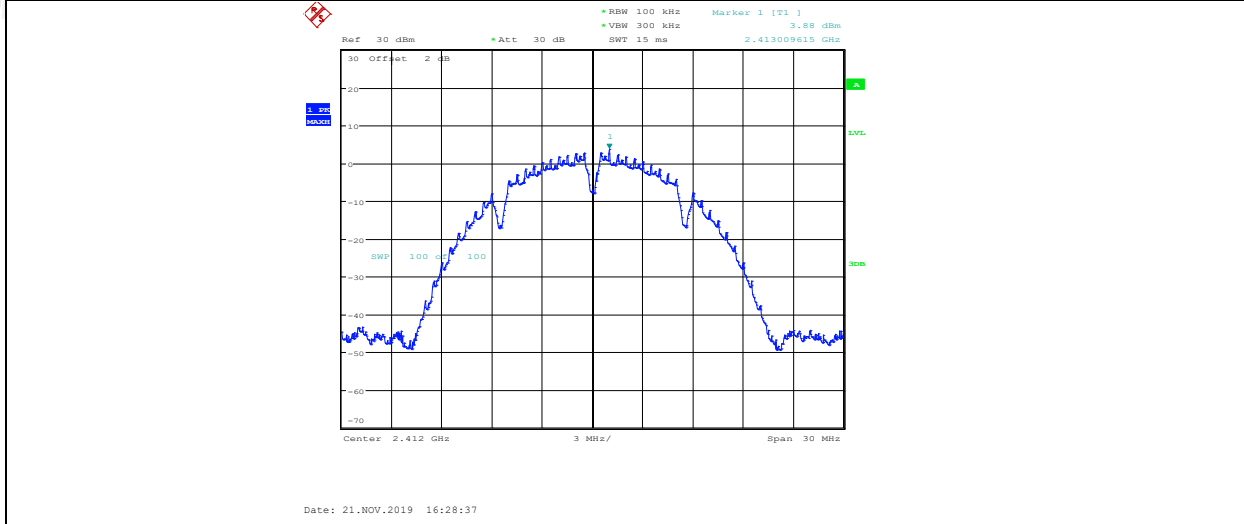

11B_ANT2_2412_30~1000

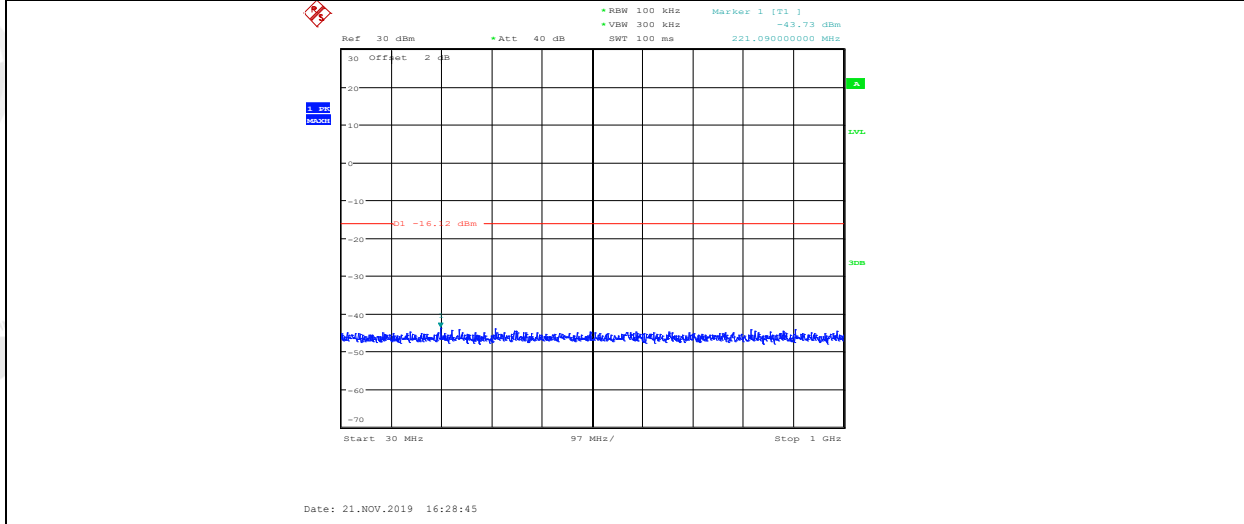

11B_ANT2_2412_1000~26500

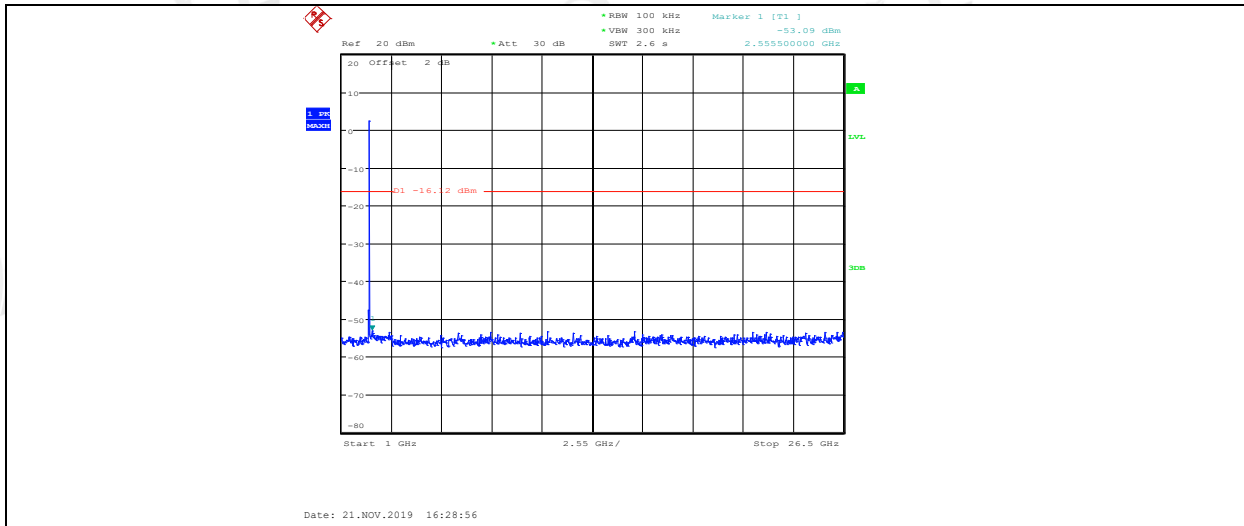

11B_ANT1_2437_Ref

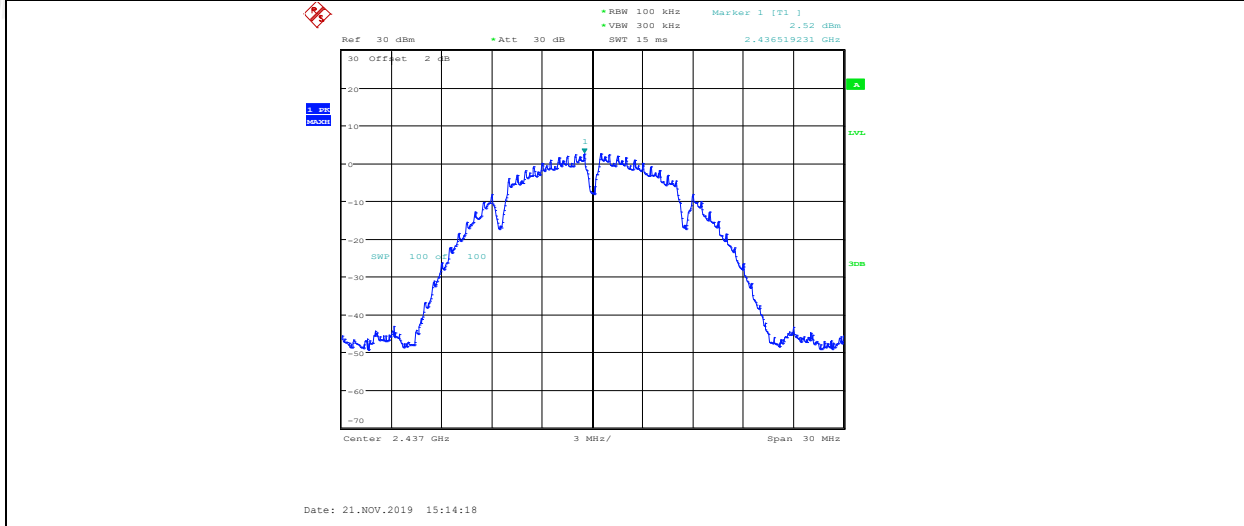

11B_ANT1_2437_30~1000

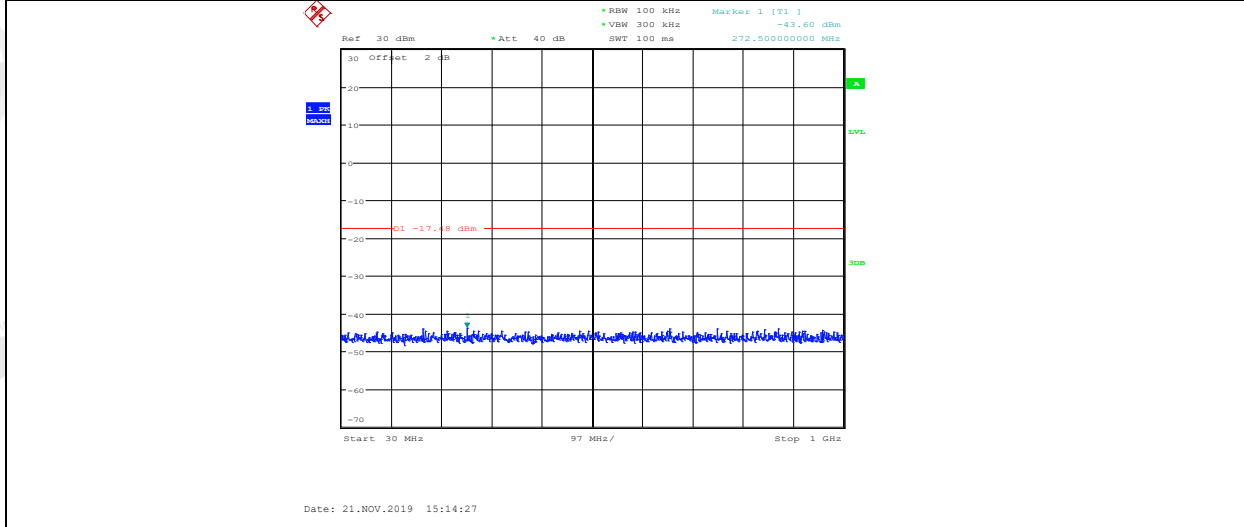

11B_ANT1_2437_1000~26500

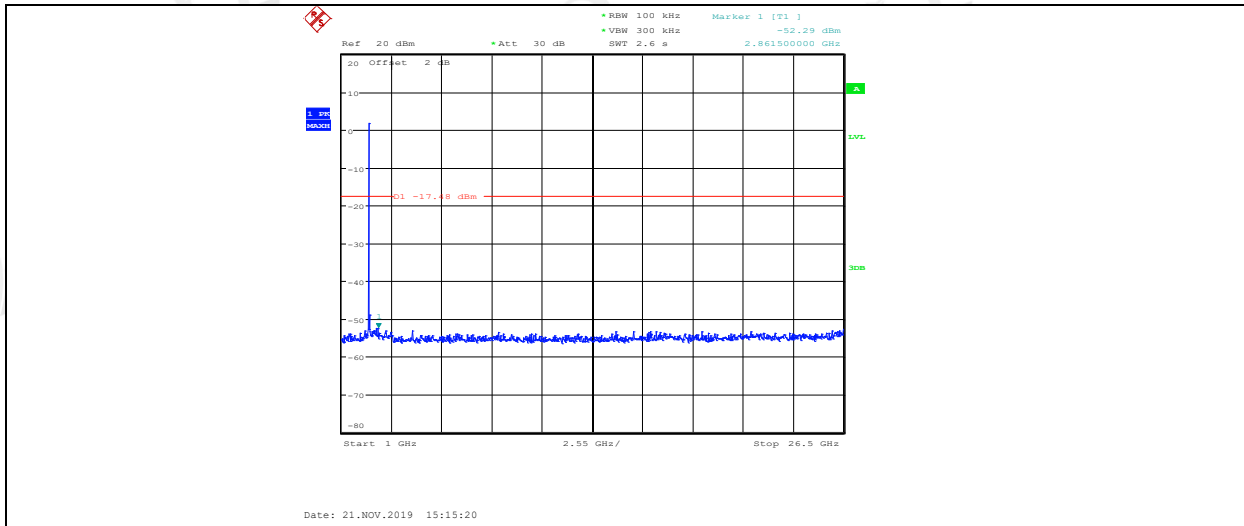

11B_ANT2_2437_Ref

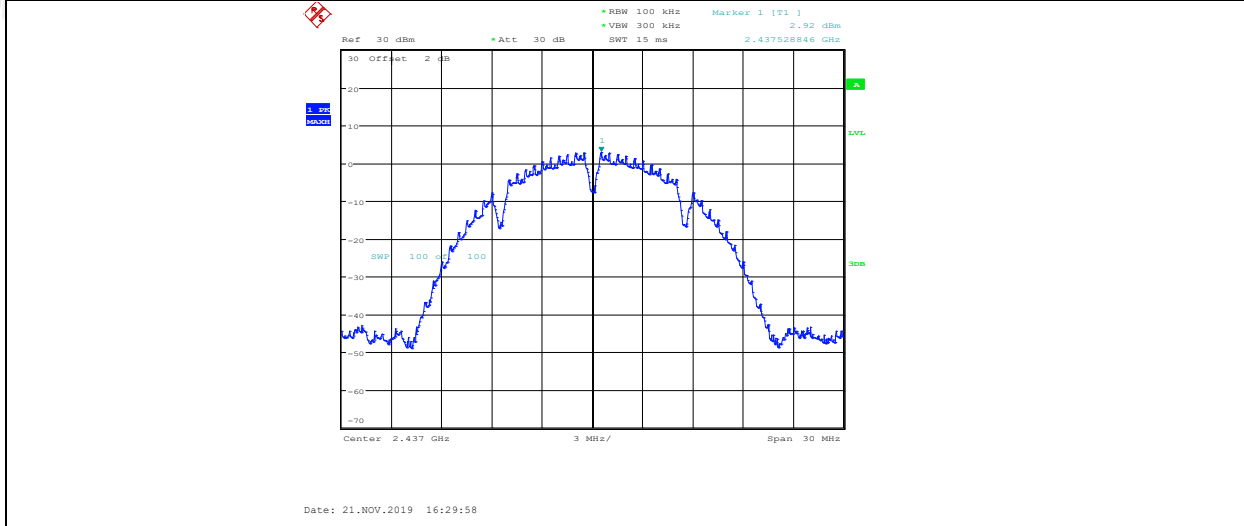

11B_ANT2_2437_30~1000

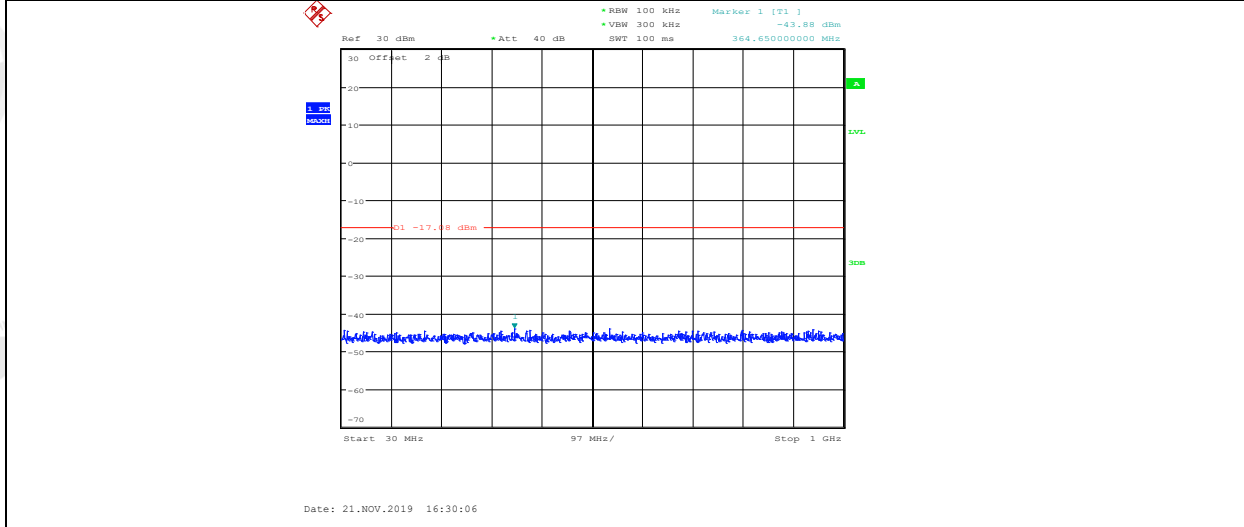

11B_ANT2_2437_1000~26500

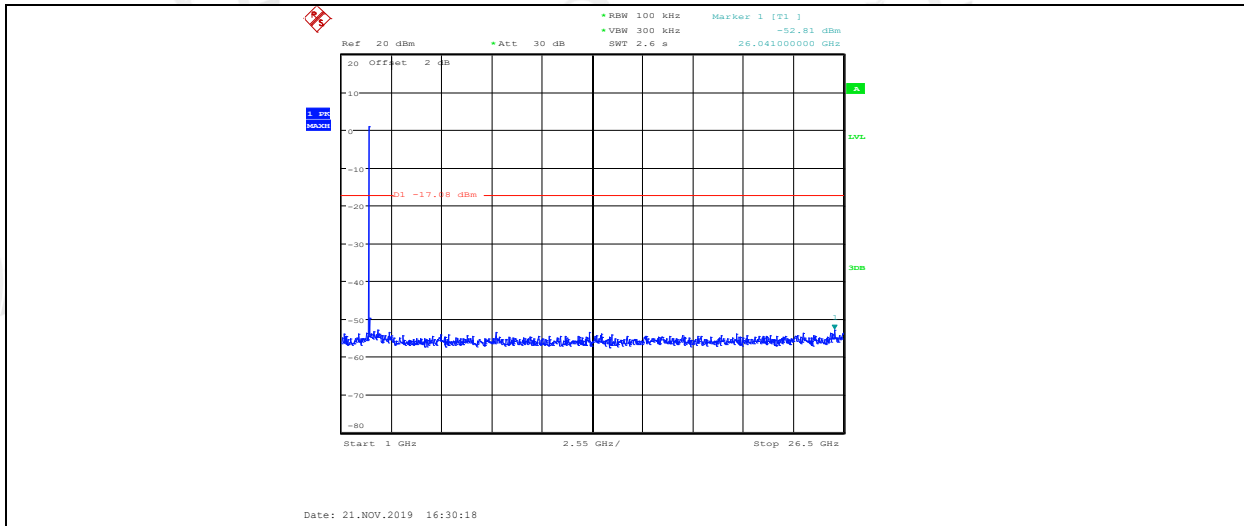

11B_ANT1_2462_Ref

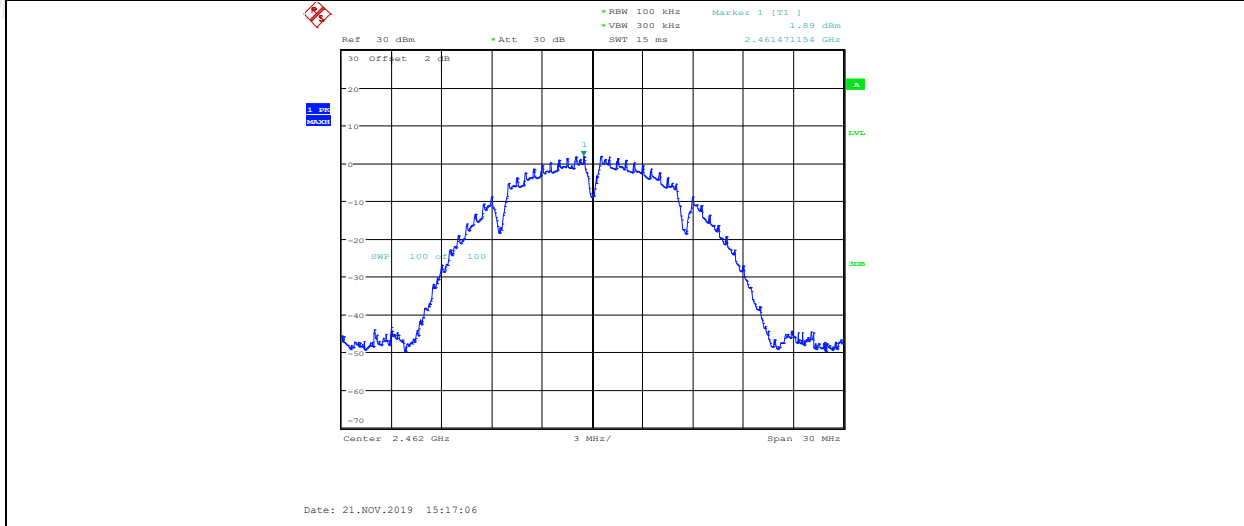

11B_ANT1_2462_30~1000

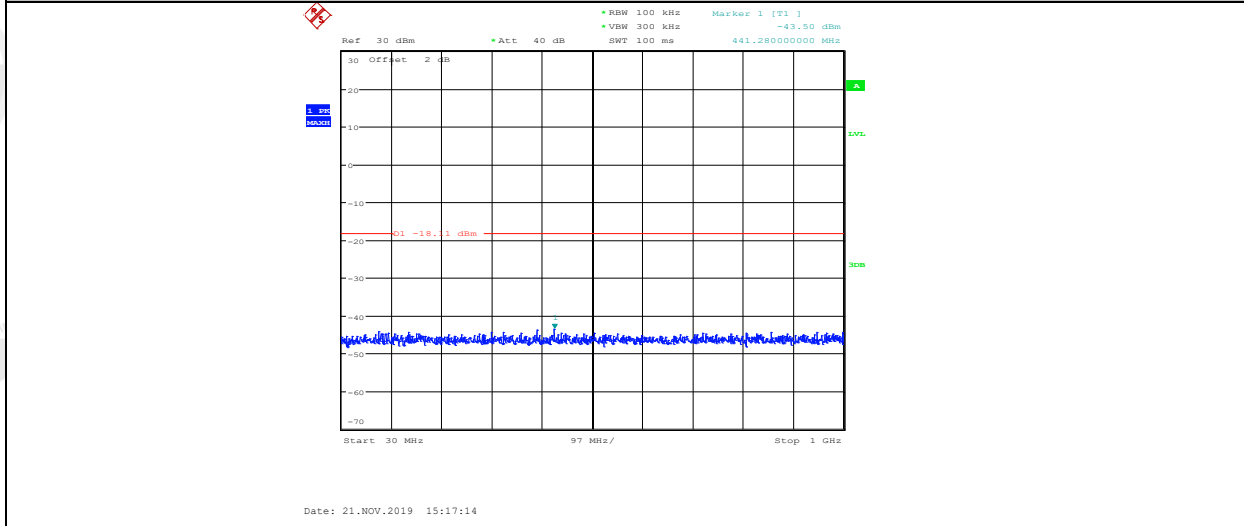

11B_ANT1_2462_1000~26500

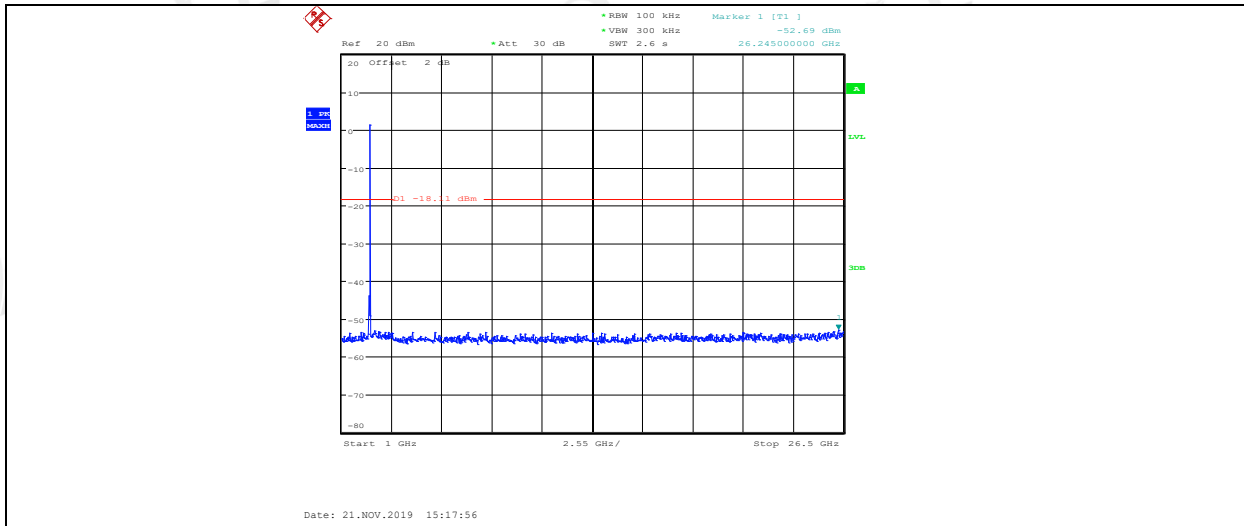

11B_ANT2_2462_Ref

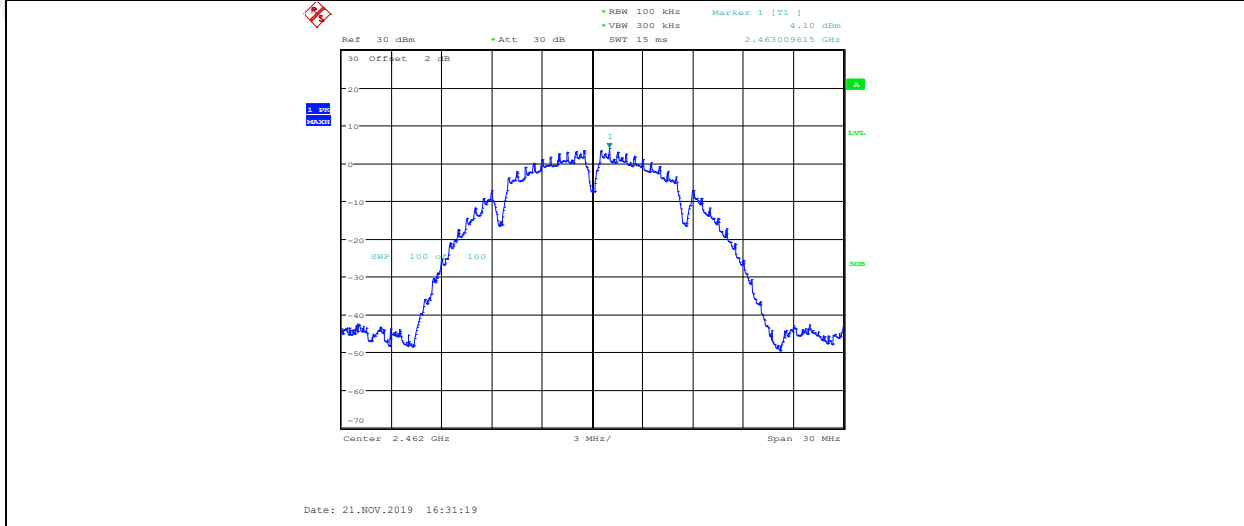

11B_ANT2_2462_30~1000

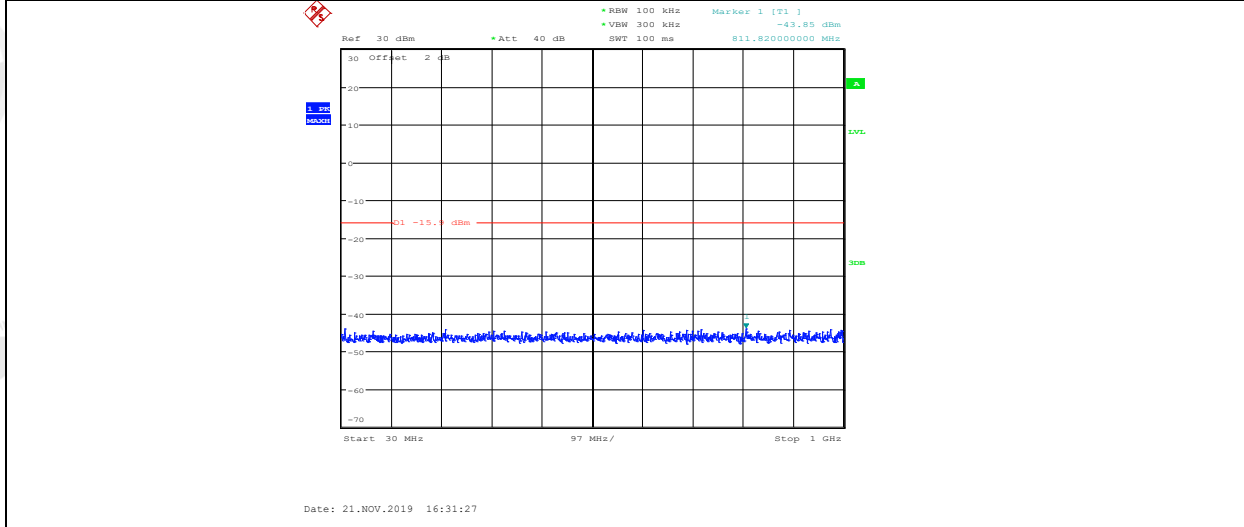

11B_ANT2_2462_1000~26500

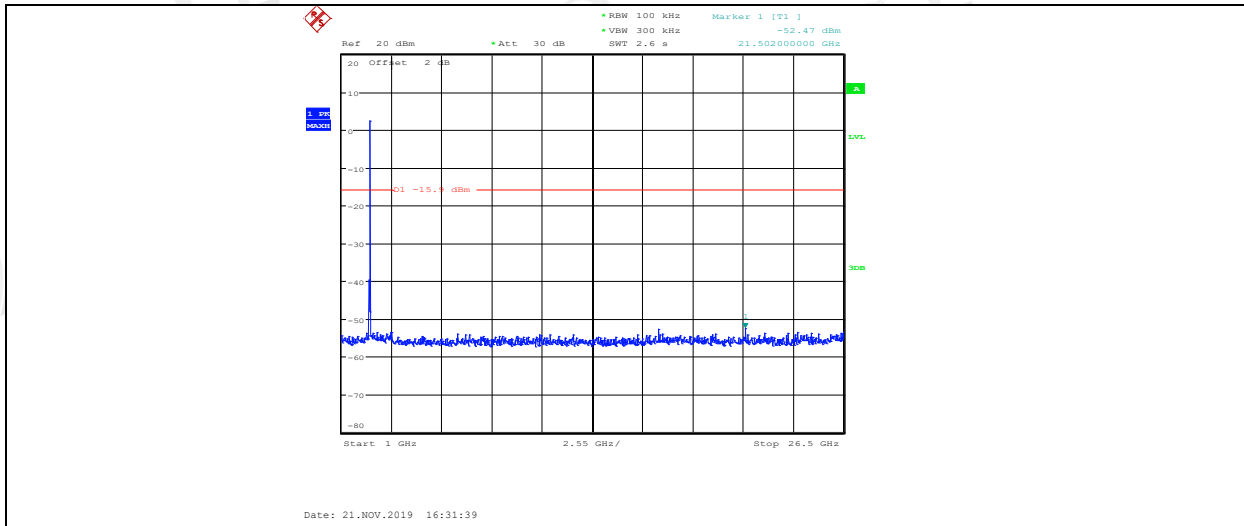

11G_ANT1_2412_Ref

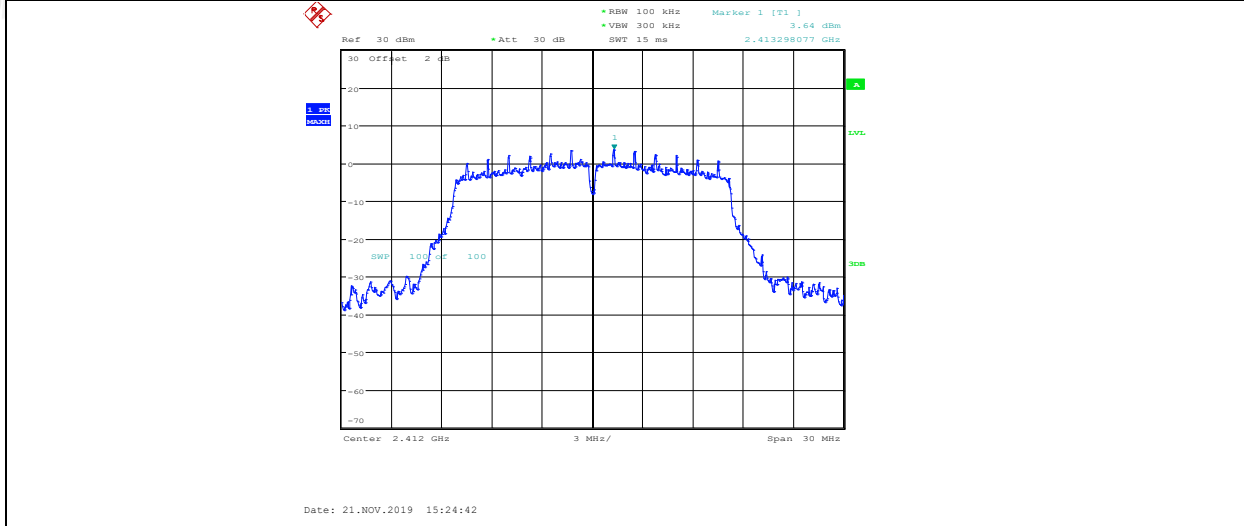

11G_ANT1_2412_30~1000

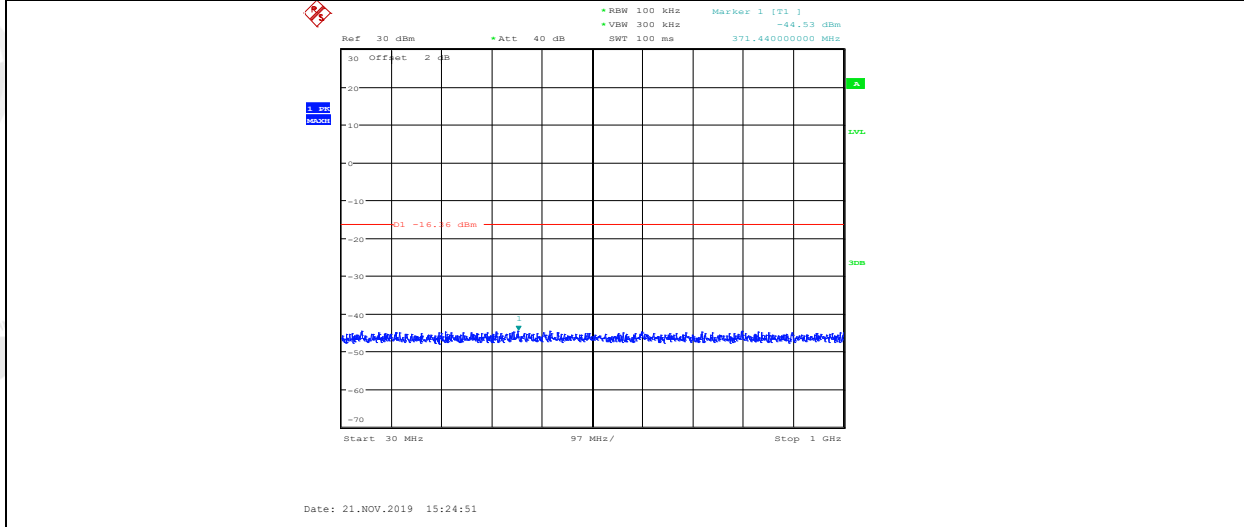

11G_ANT1_2412_1000~26500

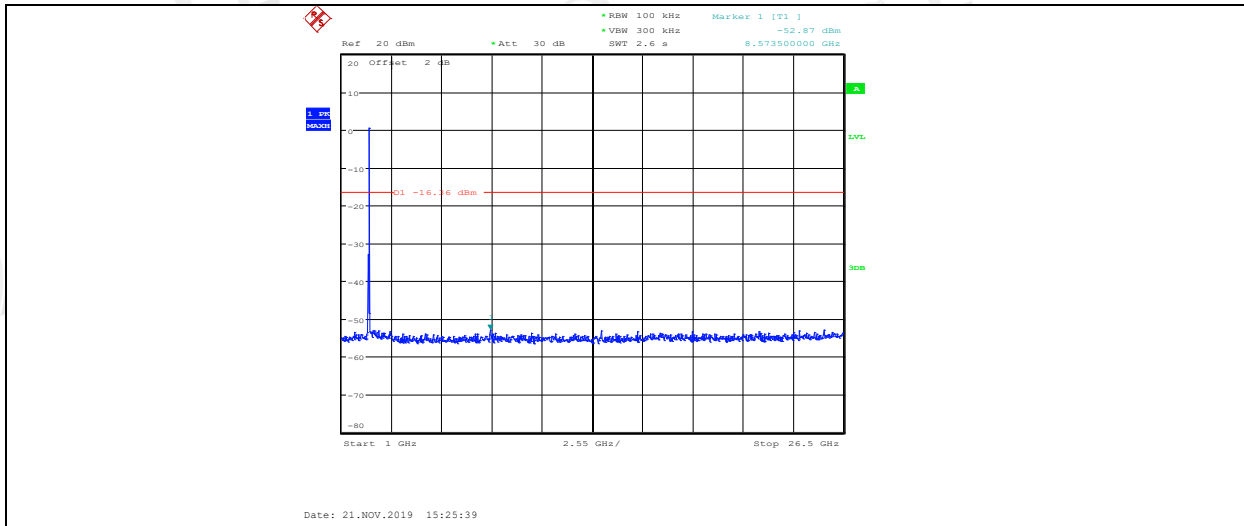

11G_ANT2_2412_Ref

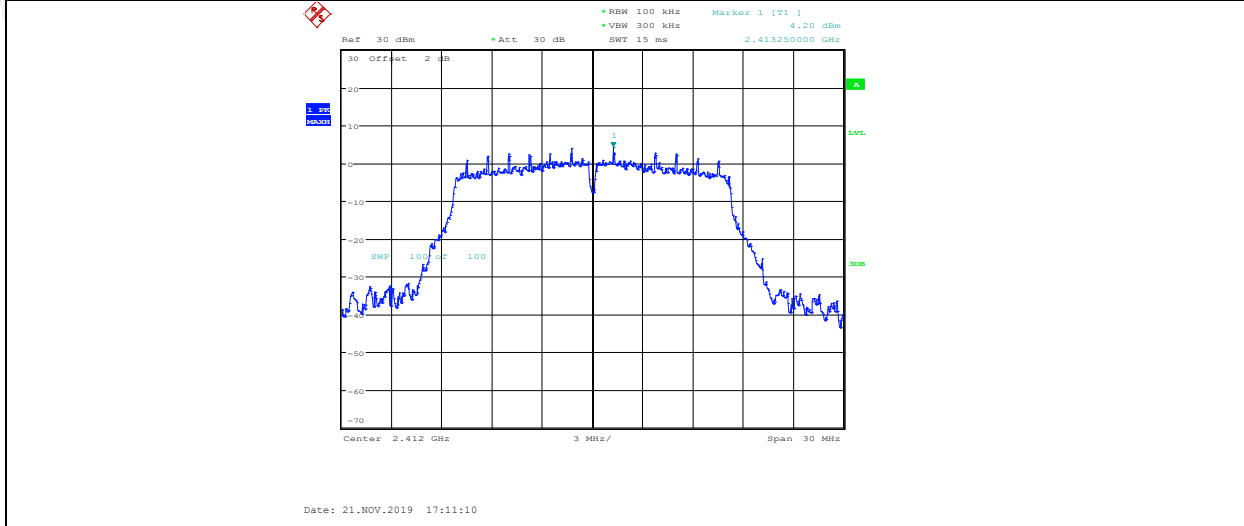

11G_ANT2_2412_30~1000

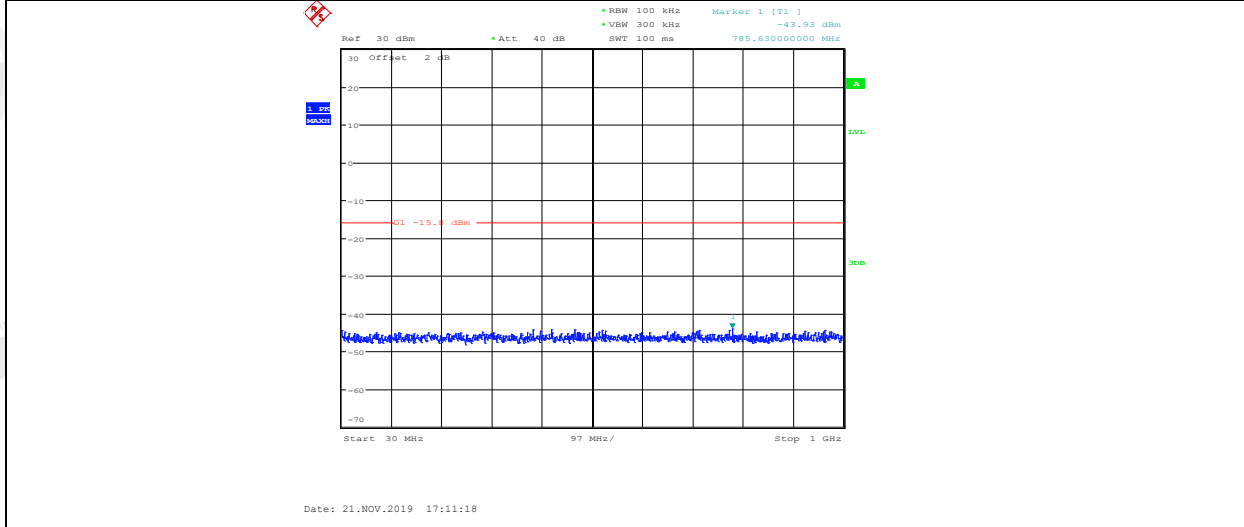

11G_ANT2_2412_1000~26500

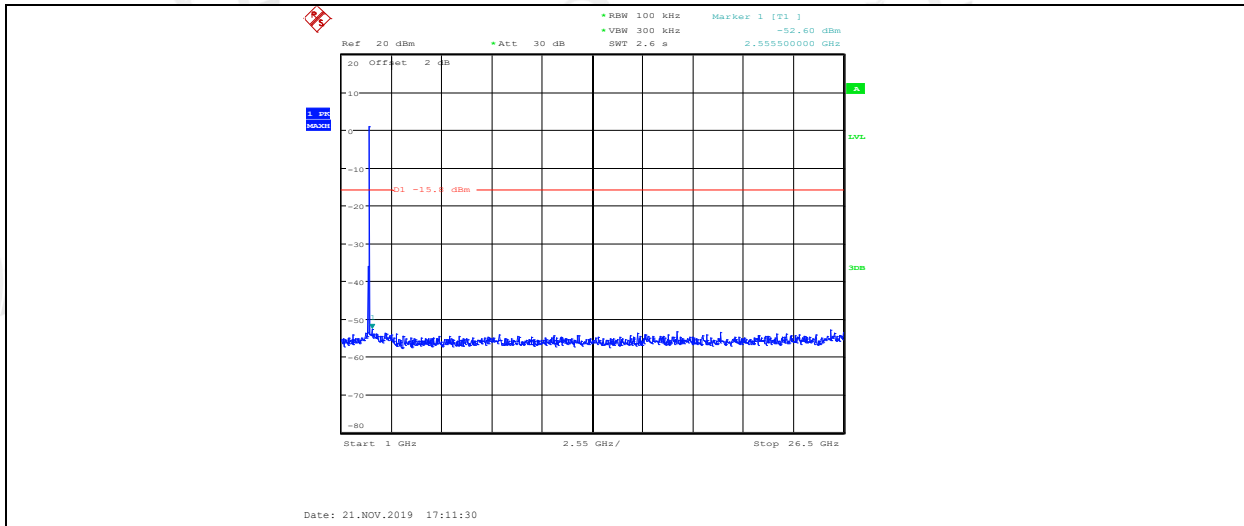

11G_ANT1_2437_Ref

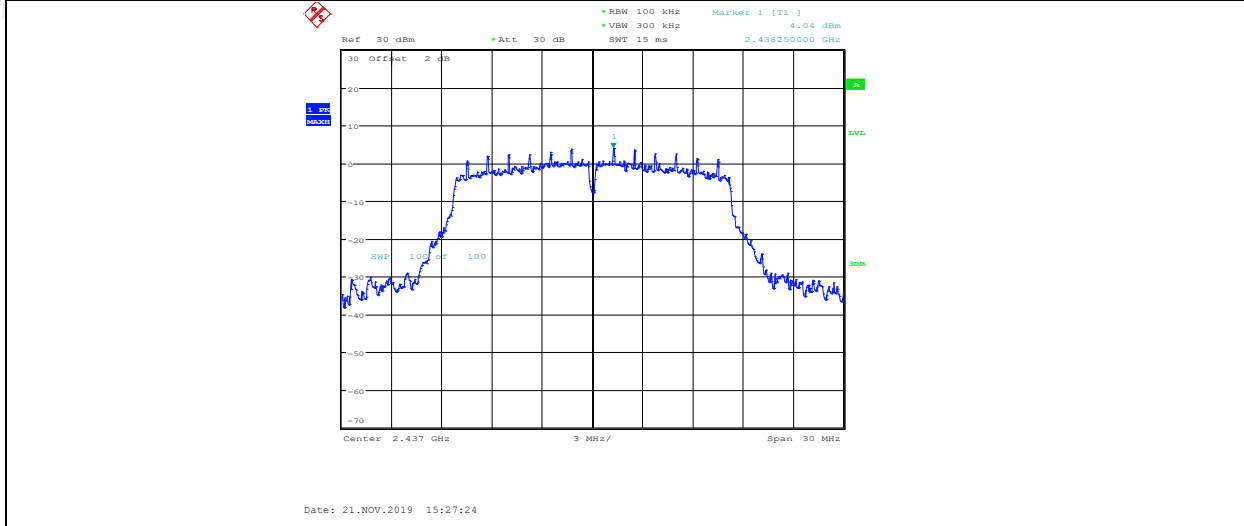

11G_ANT1_2437_30~1000

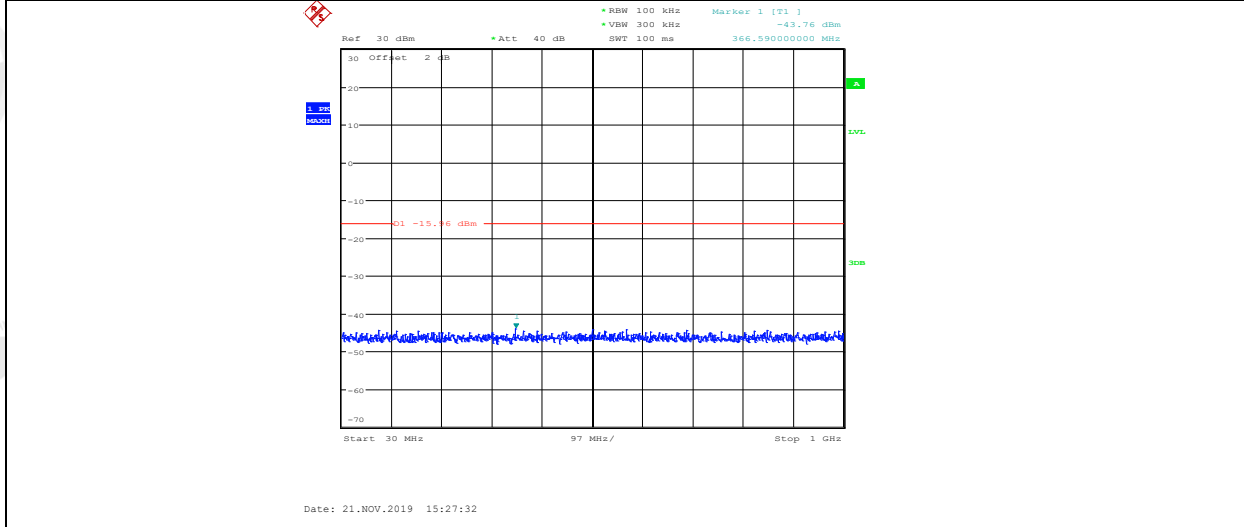

11G_ANT1_2437_1000~26500

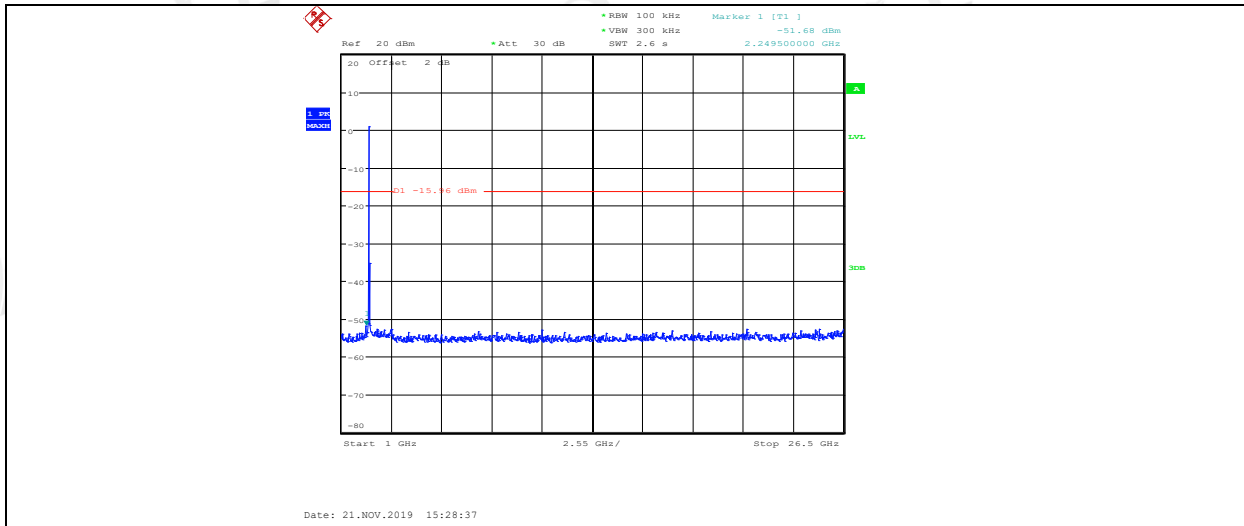

11G_ANT2_2437_Ref

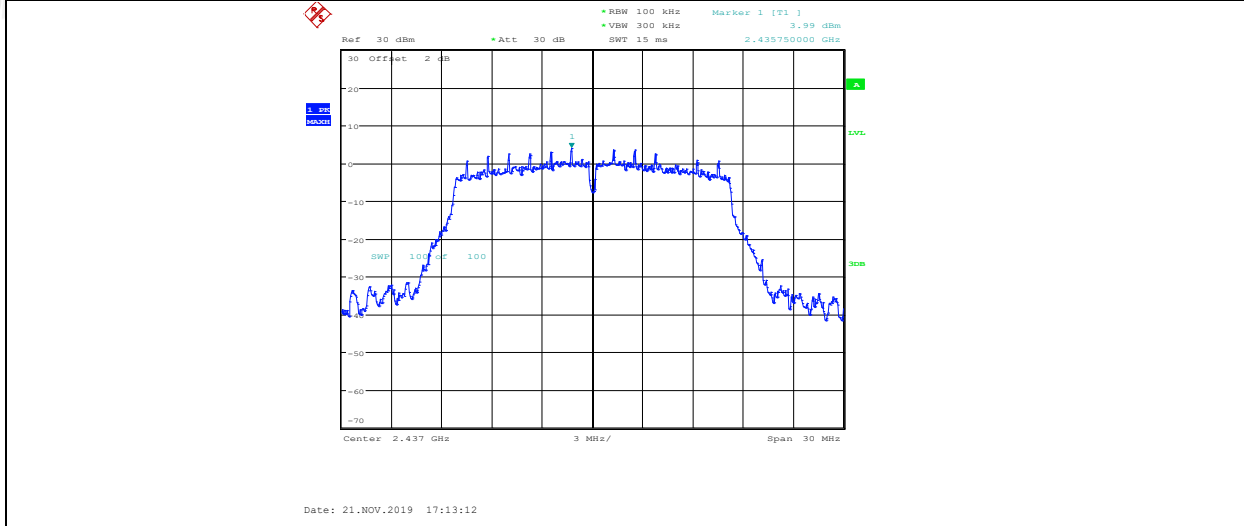

11G_ANT2_2437_30~1000

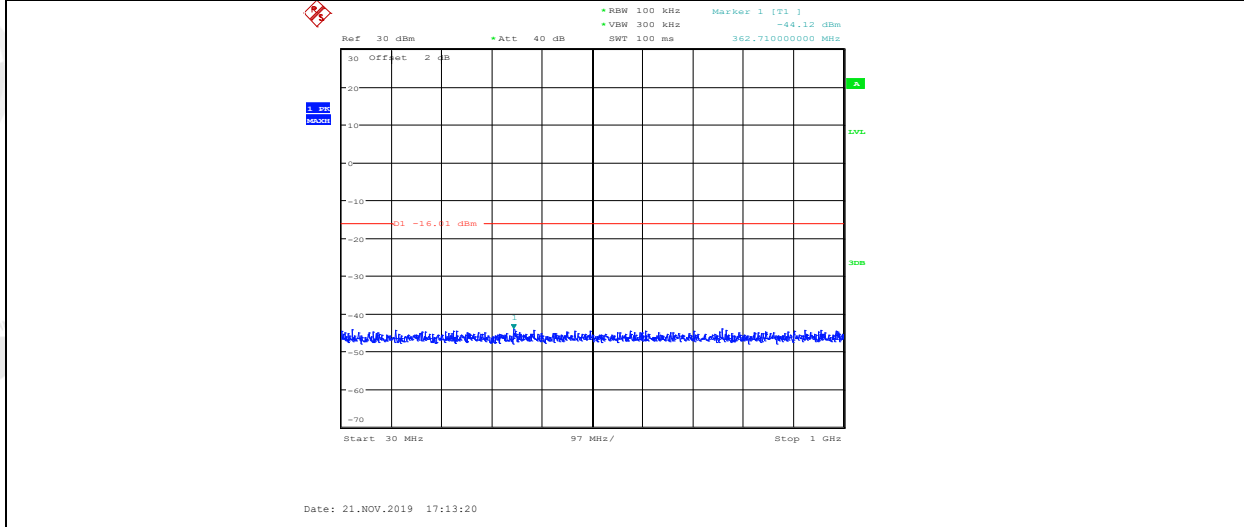

11G_ANT2_2437_1000~26500

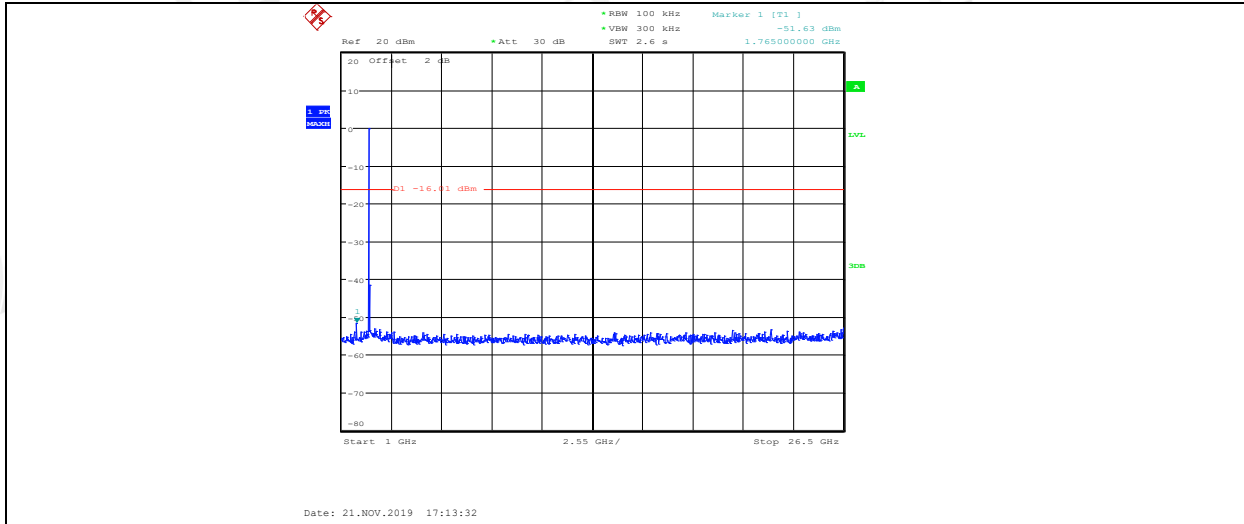

11G_ANT1_2462_Ref

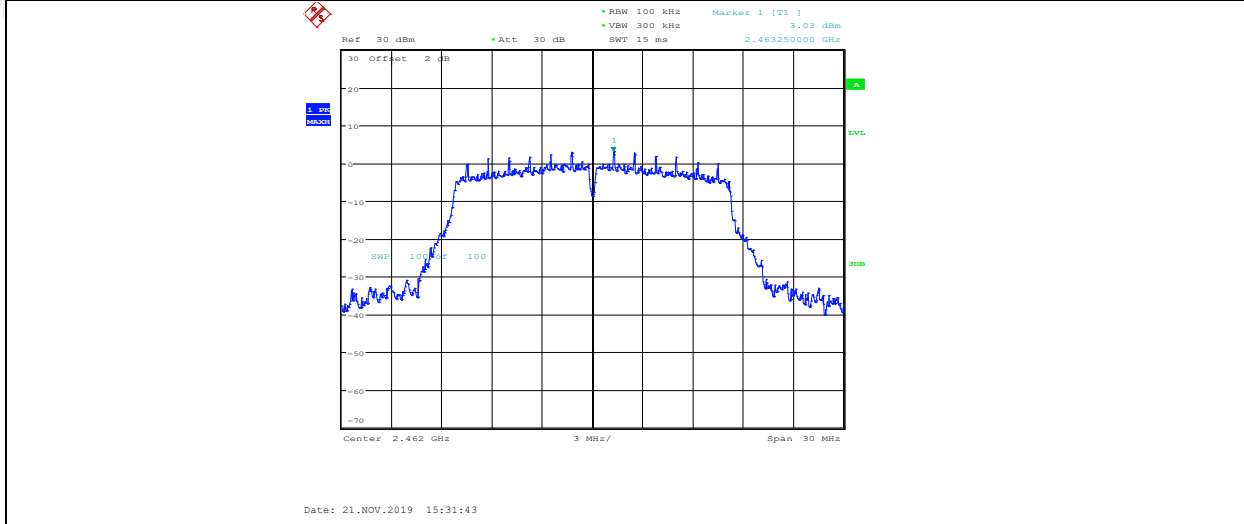

11G_ANT1_2462_30~1000

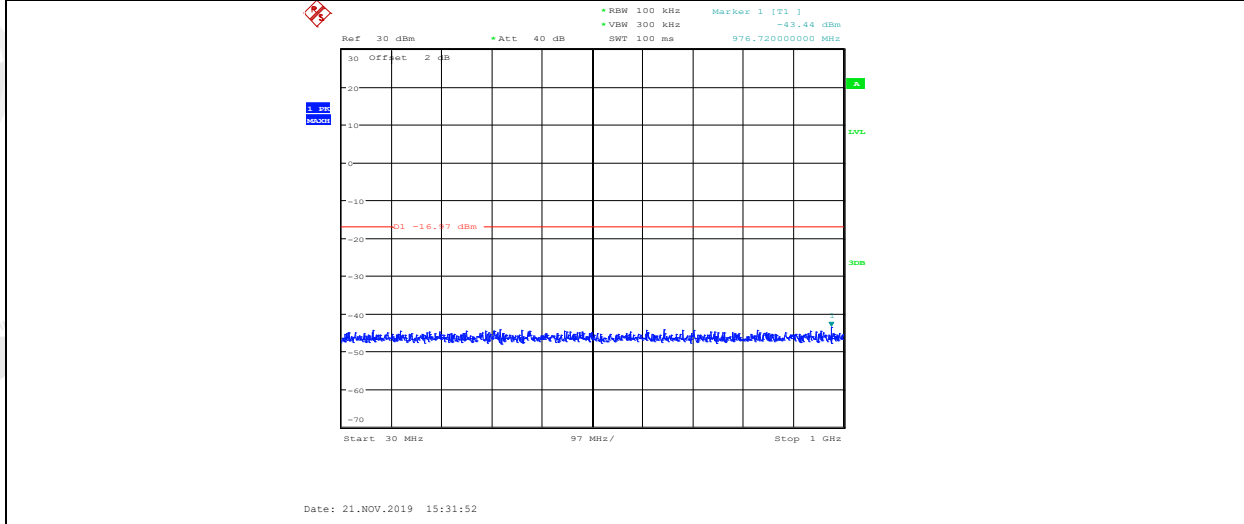

11G_ANT1_2462_1000~26500

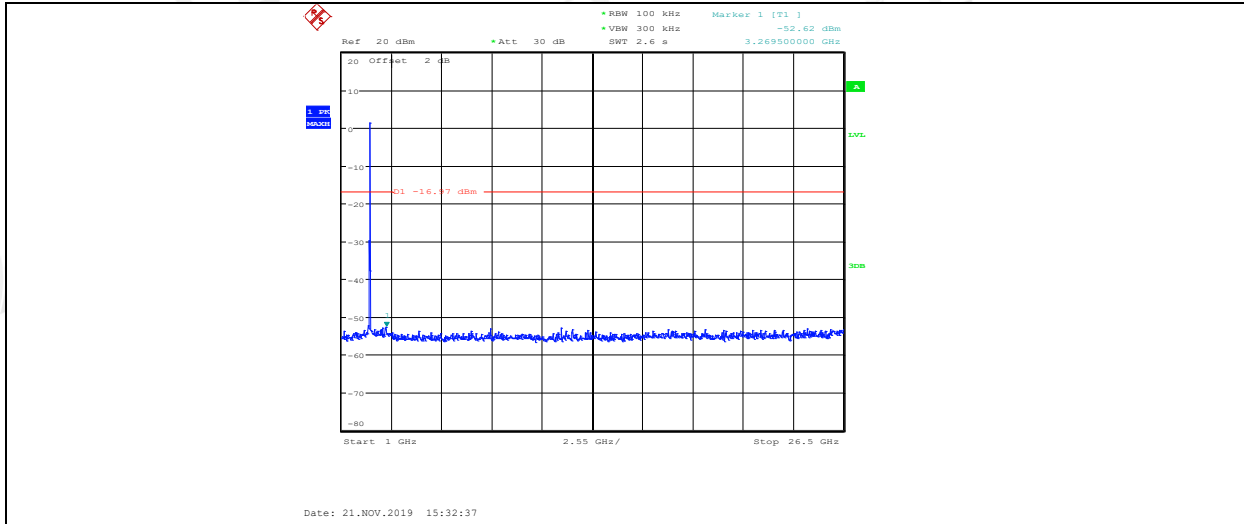

11G_ANT2_2462_Ref

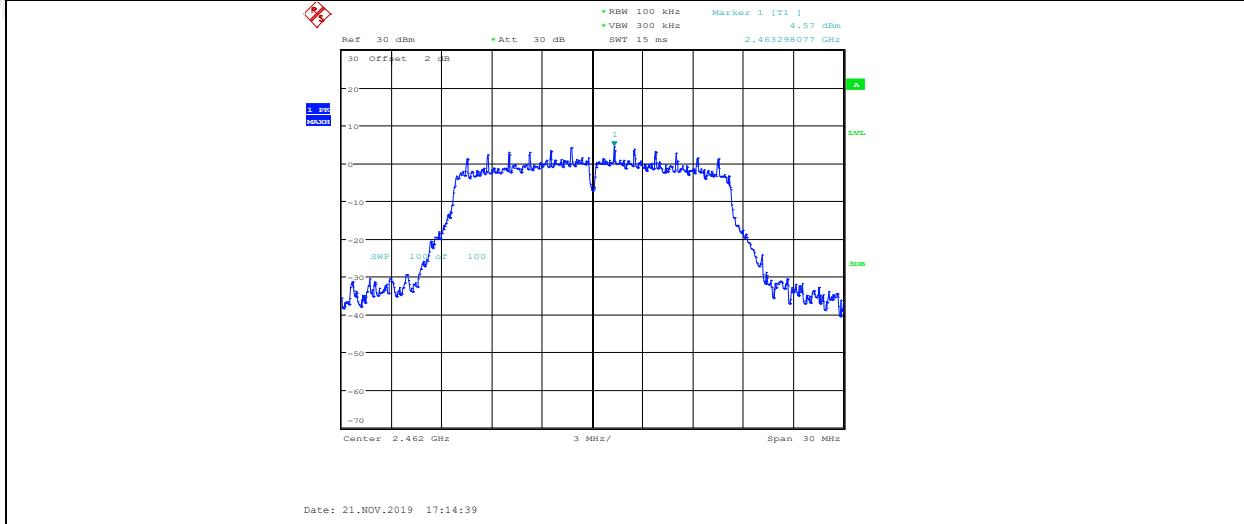

11G_ANT2_2462_30~1000

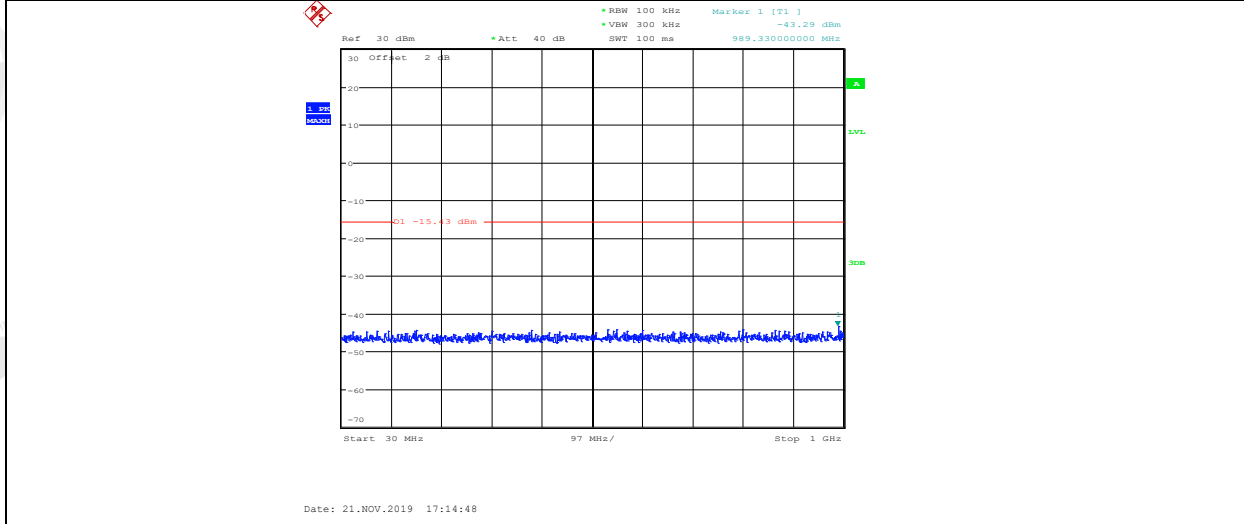

11G_ANT2_2462_1000~26500

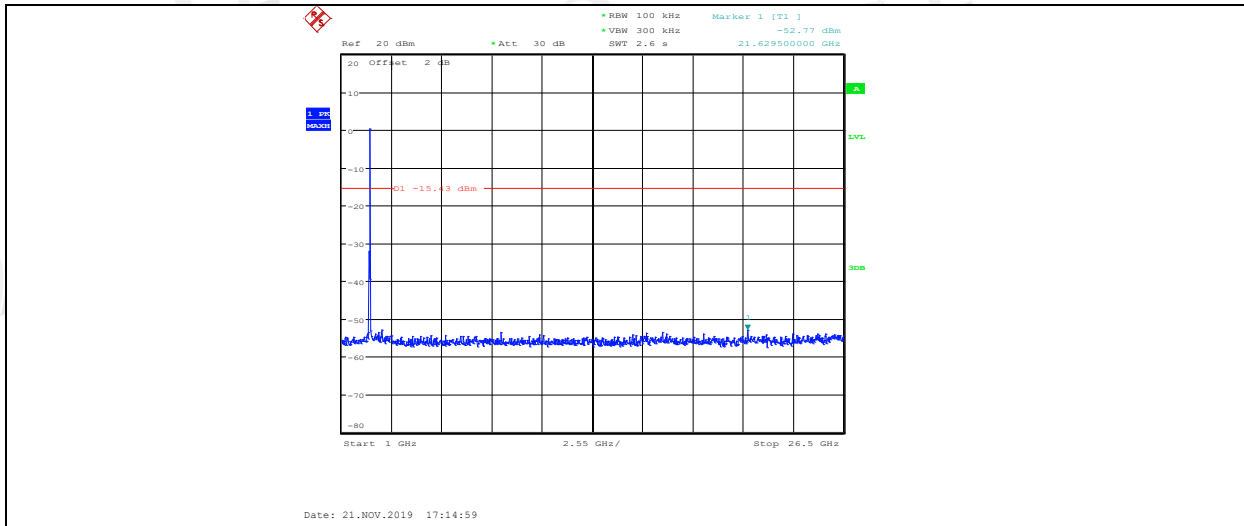

11N20MIMO_ANT1_2412_Ref

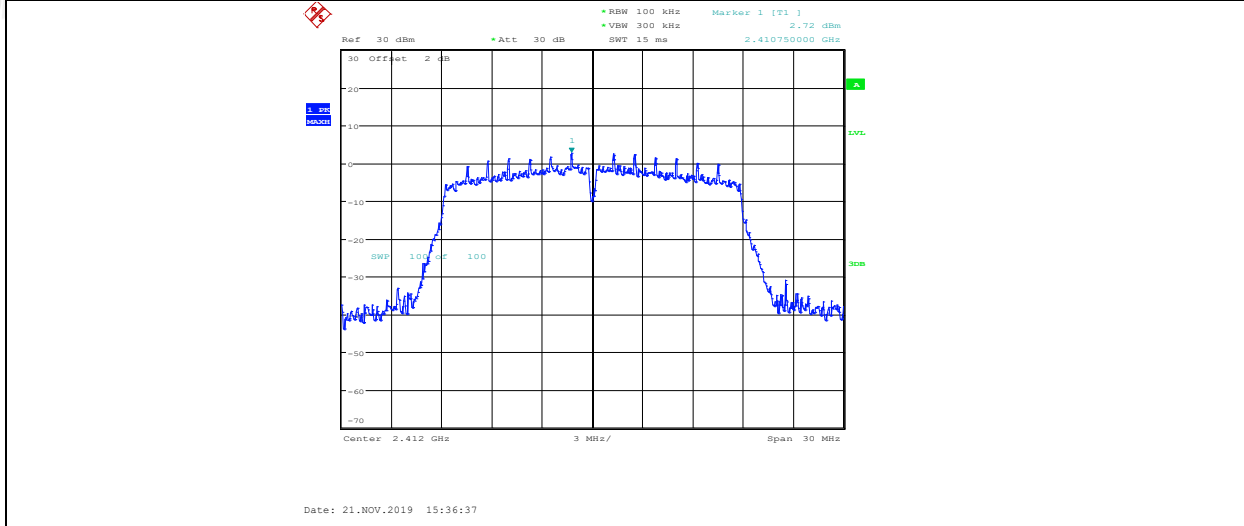

11N20MIMO_ANT1_2412_30~1000

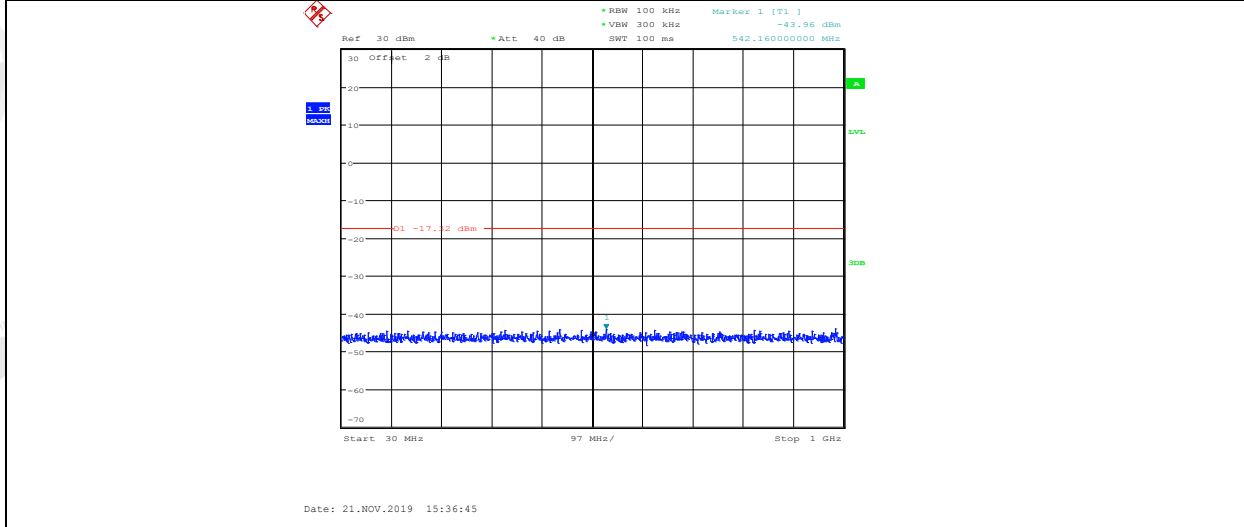

11N20MIMO_ANT1_2412_1000~26500

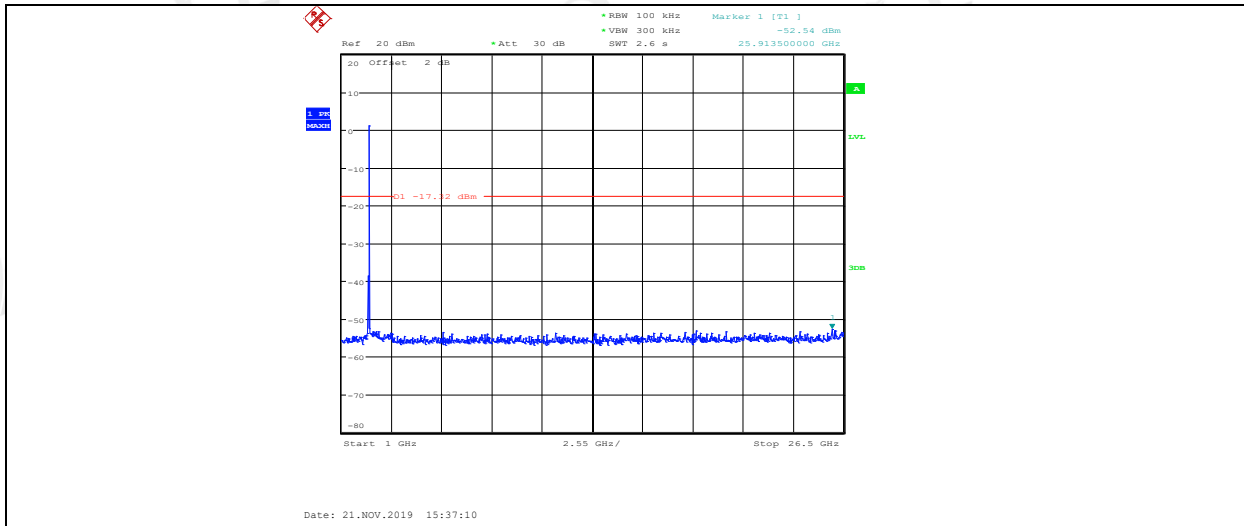

11N20MIMO_ANT2_2412_Ref

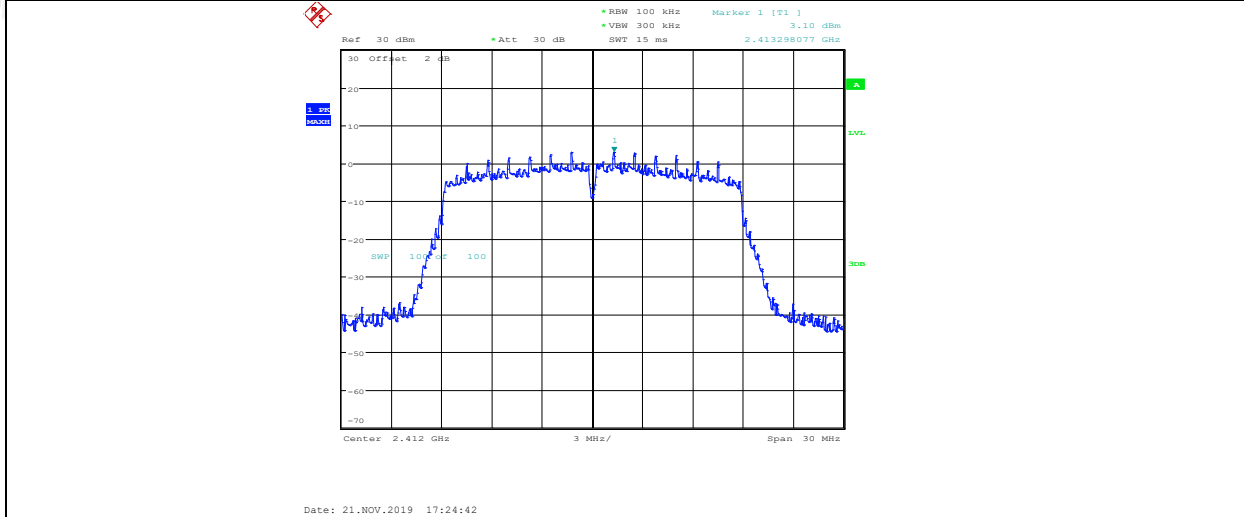

11N20MIMO_ANT2_2412_30~1000

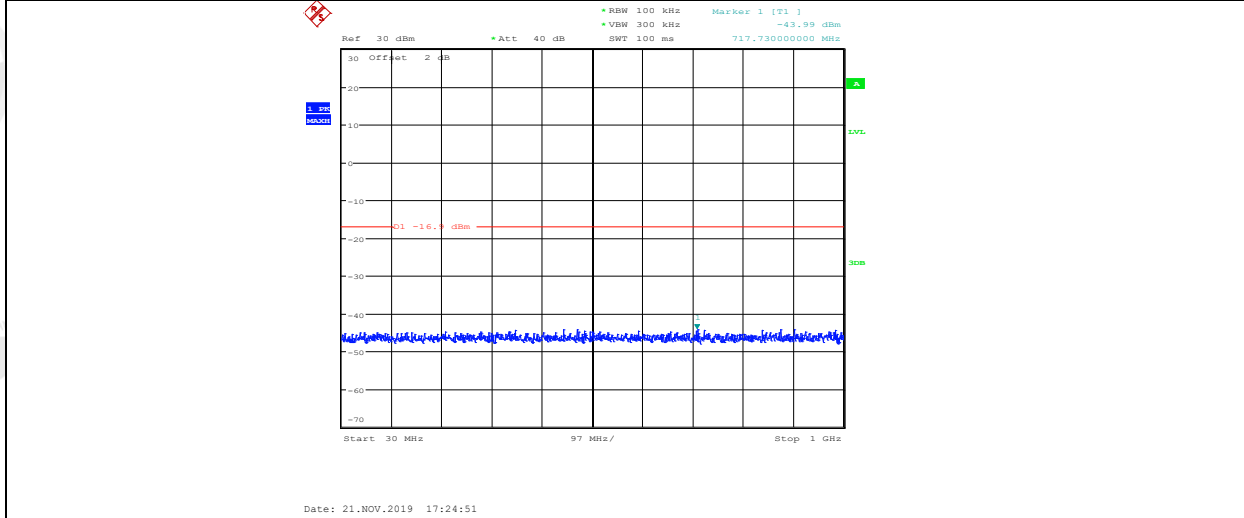

11N20MIMO_ANT2_2412_1000~26500

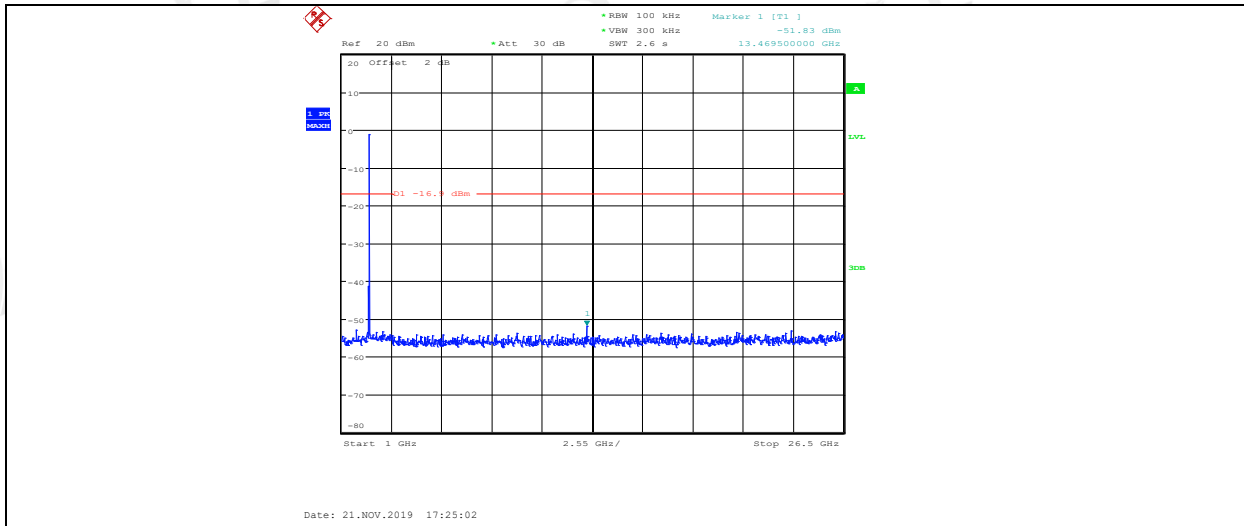

11N20MIMO_ANT1_2437_Ref

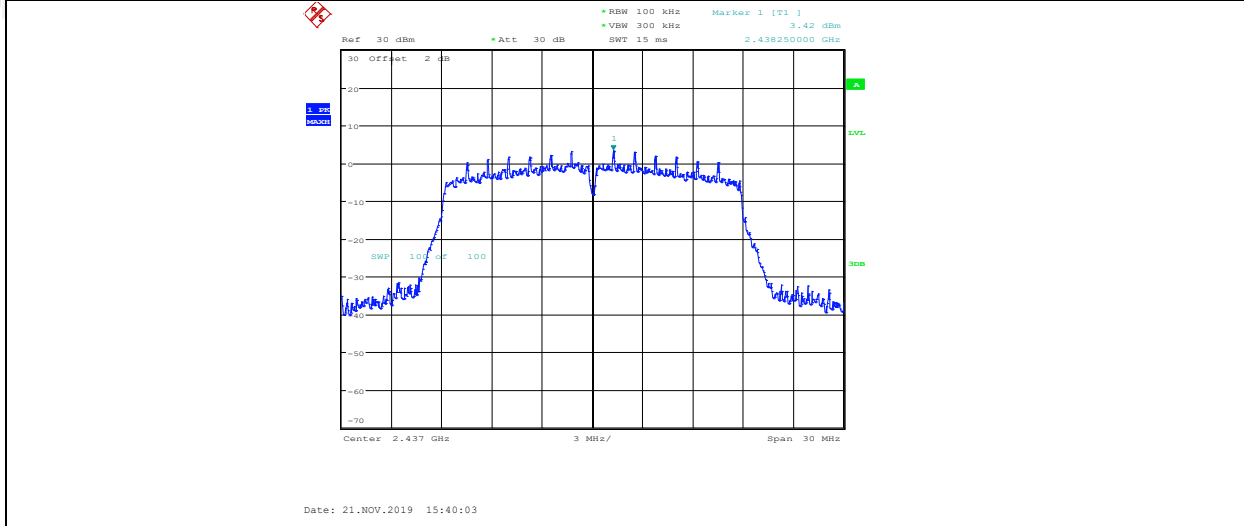

11N20MIMO_ANT1_2437_30~1000

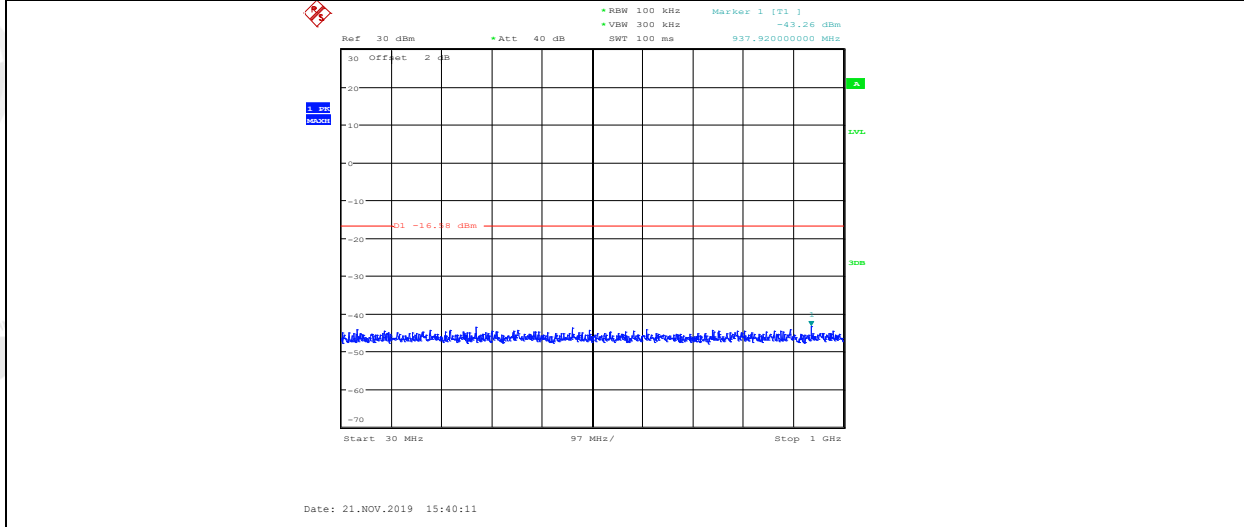

11N20MIMO_ANT1_2437_1000~26500

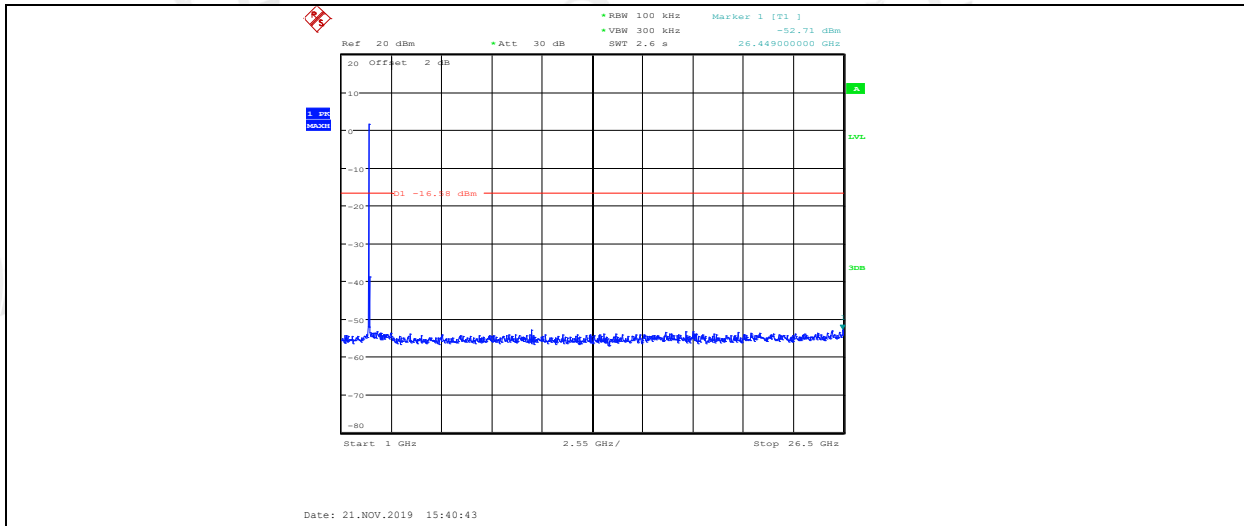

11N20MIMO_ANT2_2437_Ref

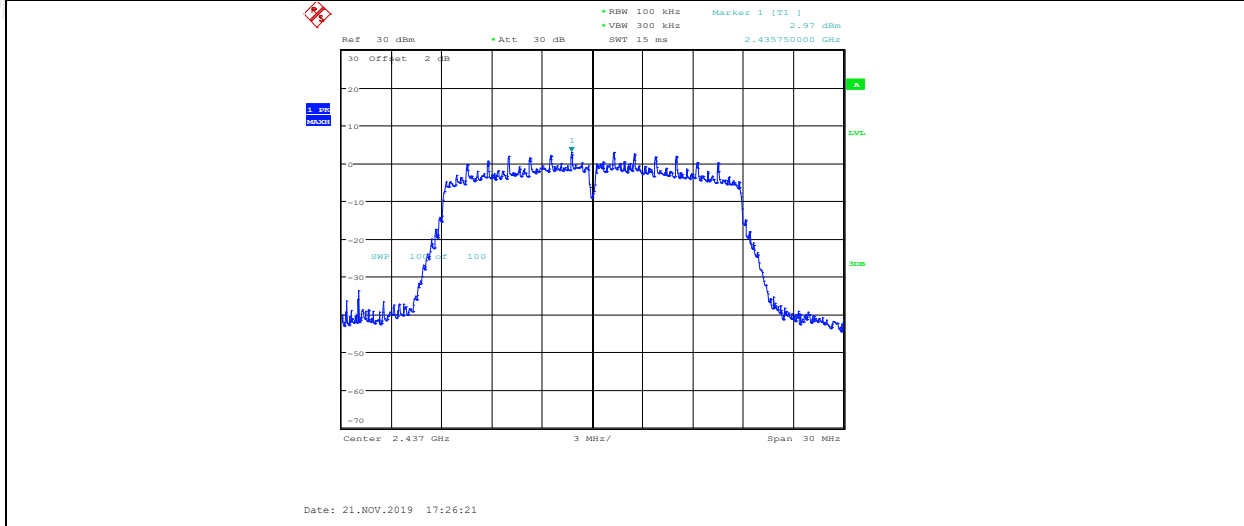

11N20MIMO_ANT2_2437_30~1000

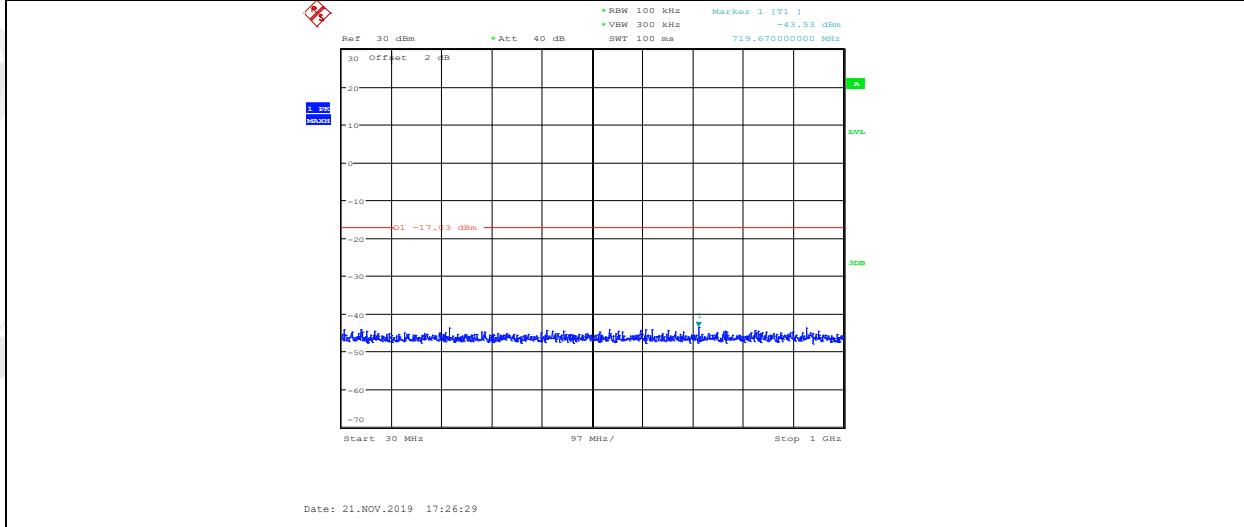

11N20MIMO_ANT2_2437_1000~26500

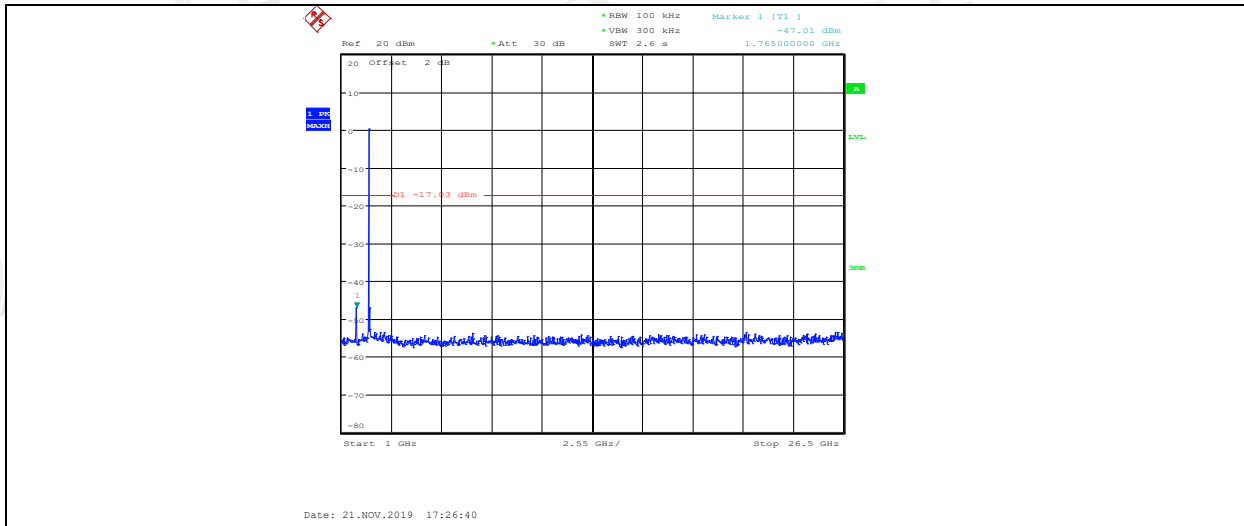

11N20MIMO_ANT1_2462_Ref

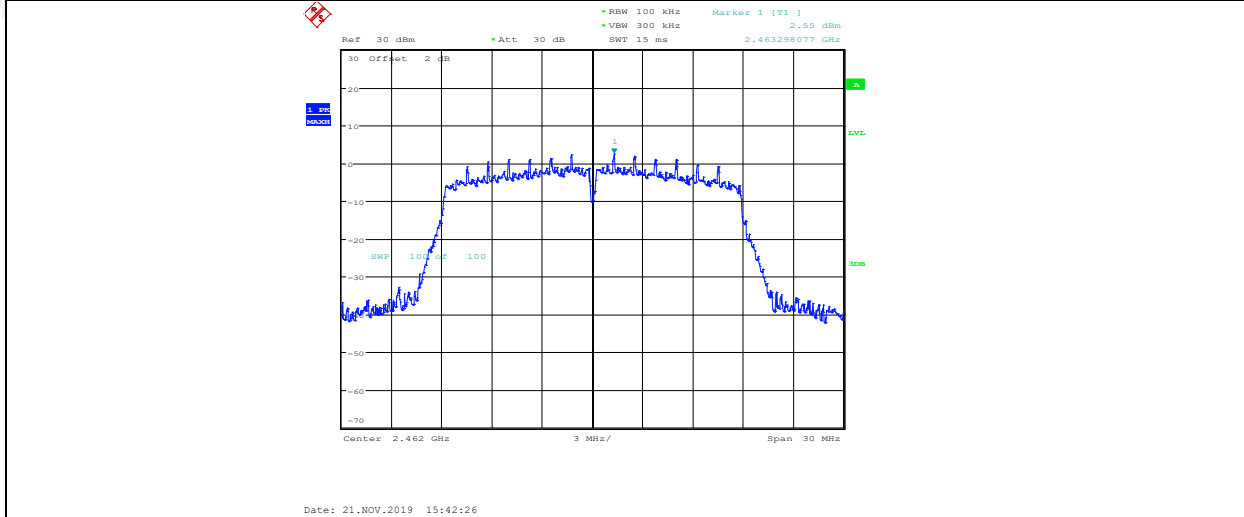

11N20MIMO_ANT1_2462_30~1000

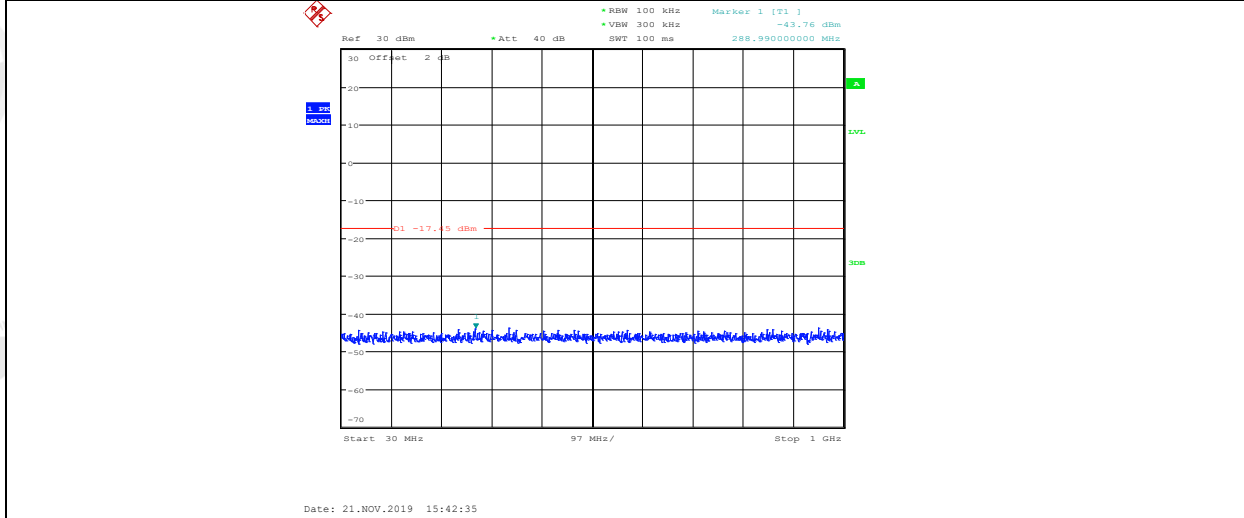

11N20MIMO_ANT1_2462_1000~26500

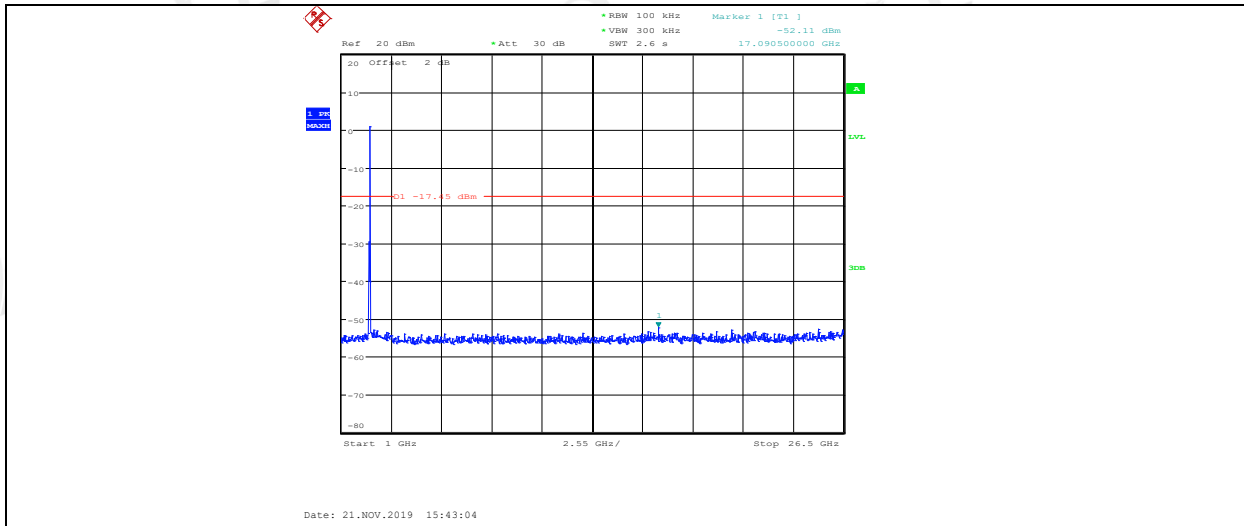

11N20MIMO_ANT2_2462_Ref

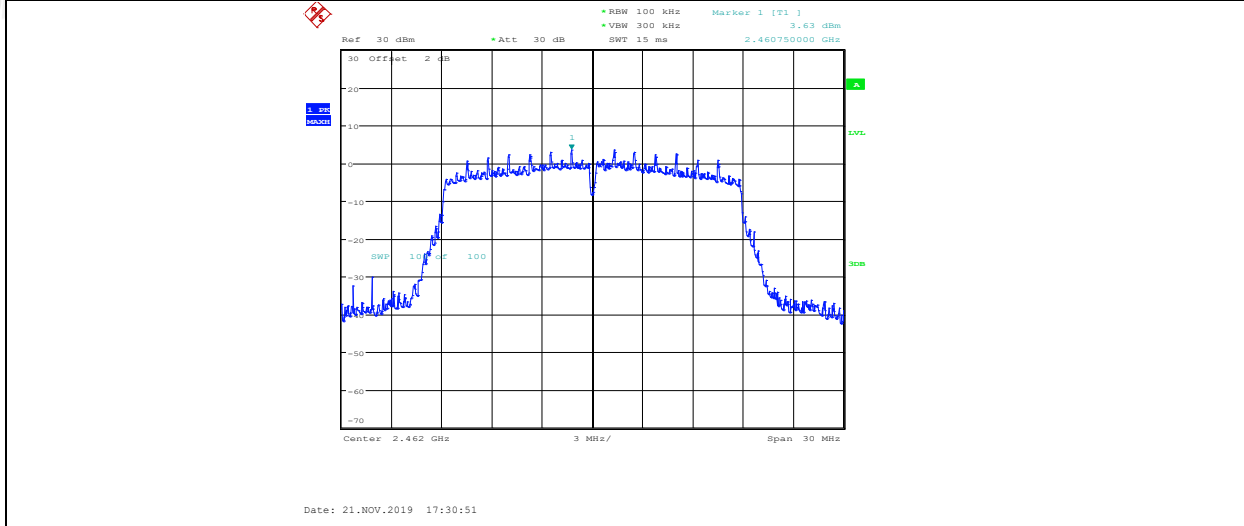

11N20MIMO_ANT2_2462_30~1000

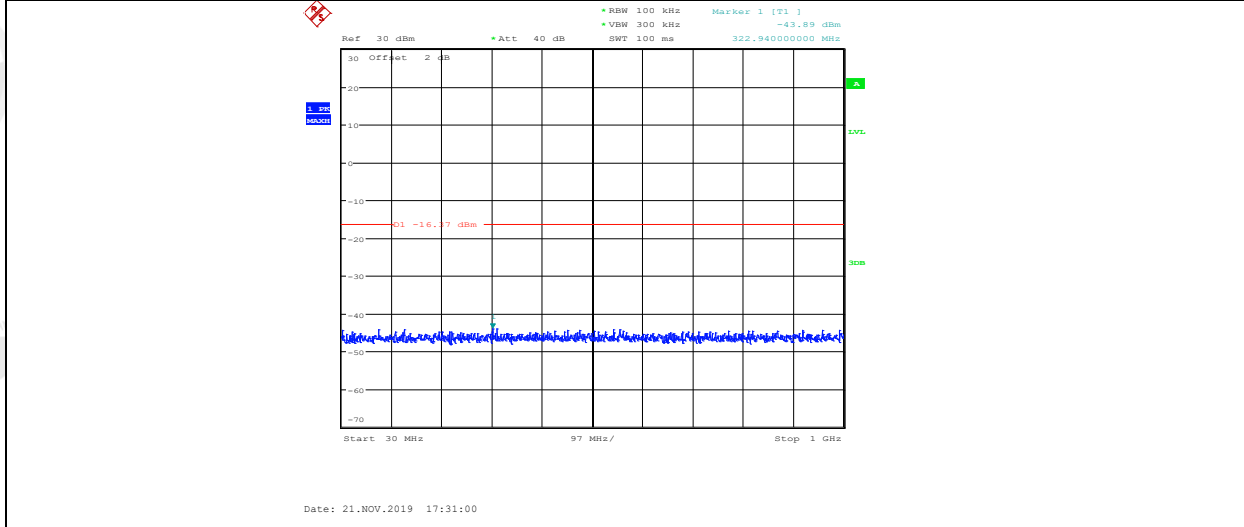

11N20MIMO_ANT2_2462_1000~26500

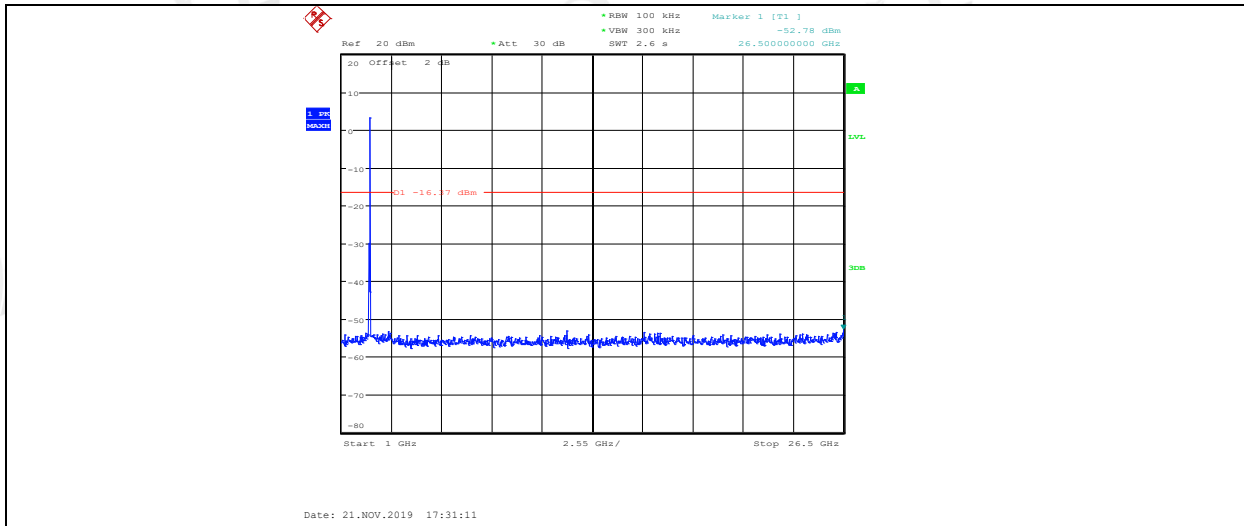

11N40MIMO_ANT1_2422_Ref

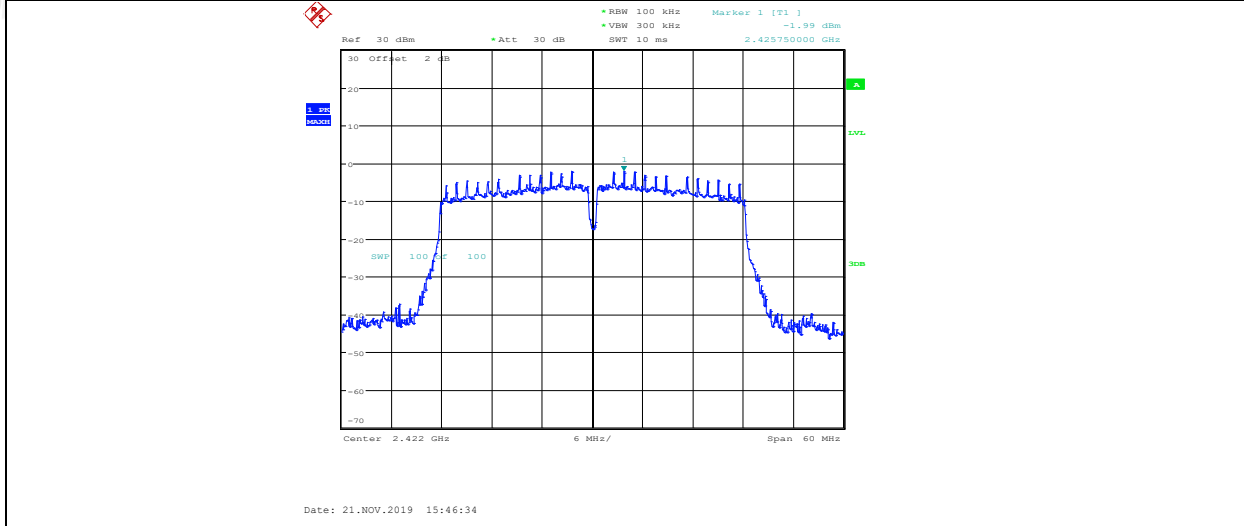

11N40MIMO_ANT1_2422_30~1000

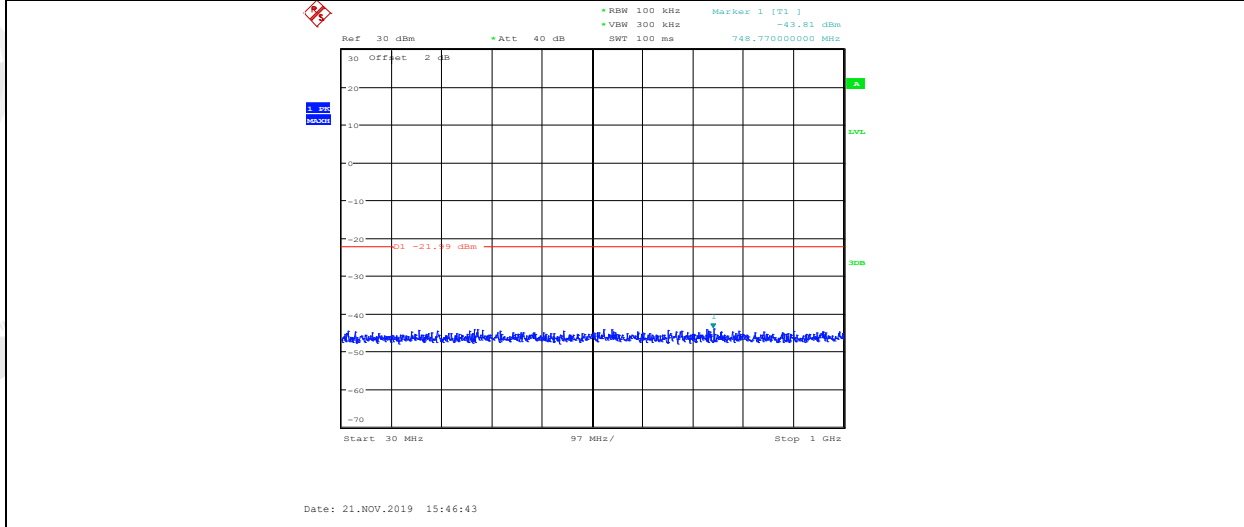

11N40MIMO_ANT1_2422_1000~26500

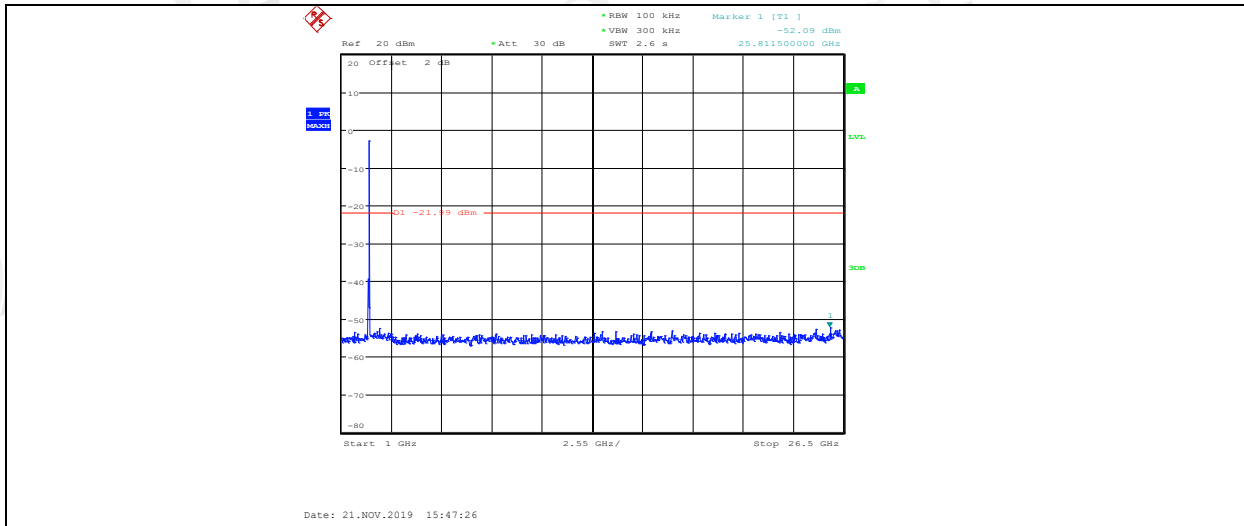

11N40MIMO_ANT2_2422_Ref

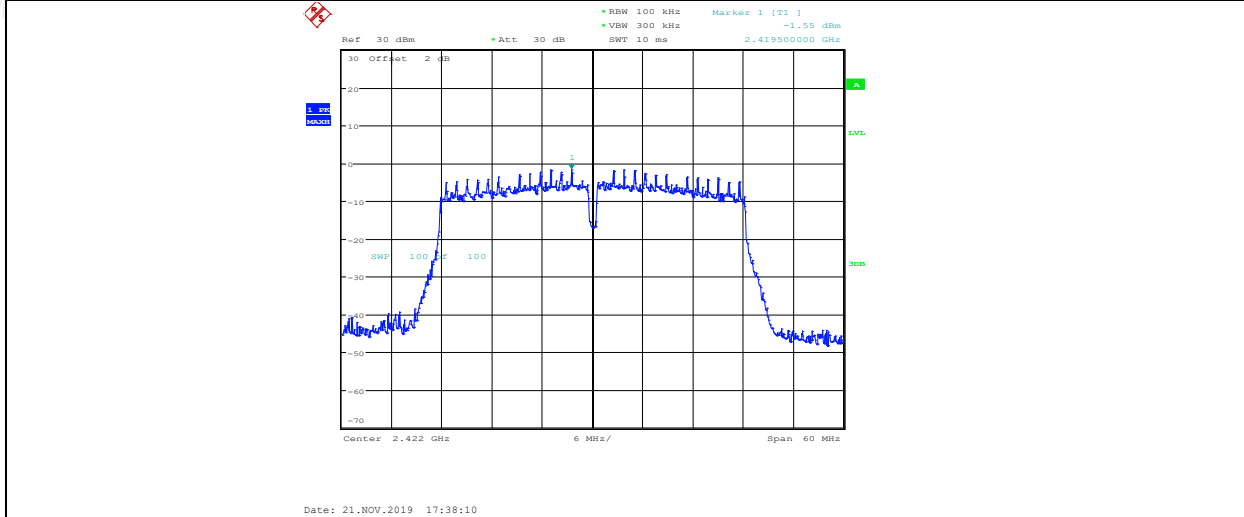

11N40MIMO_ANT2_2422_30~1000

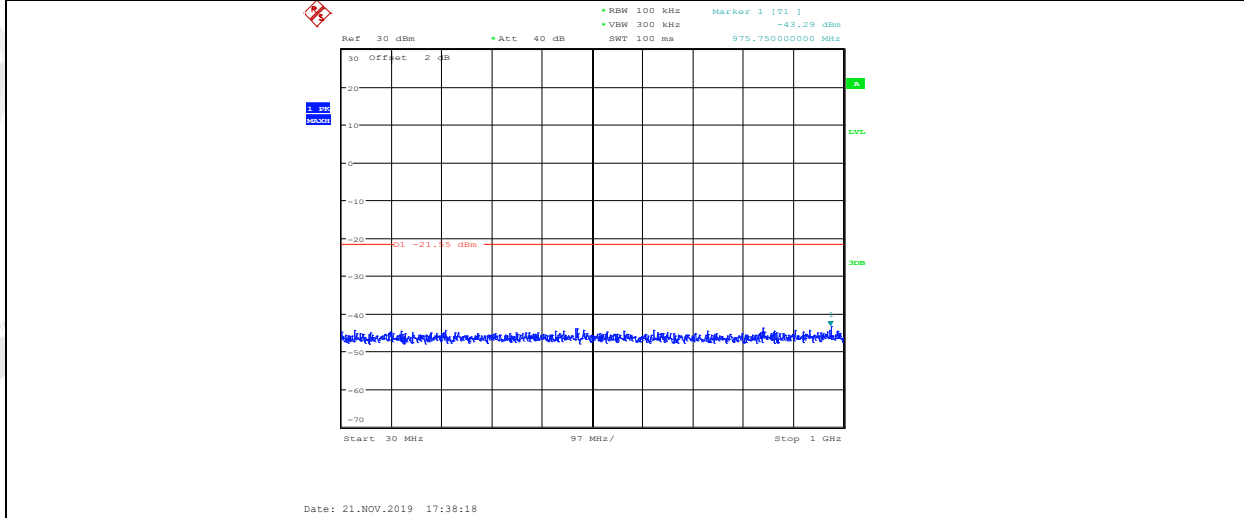

11N40MIMO_ANT2_2422_1000~26500

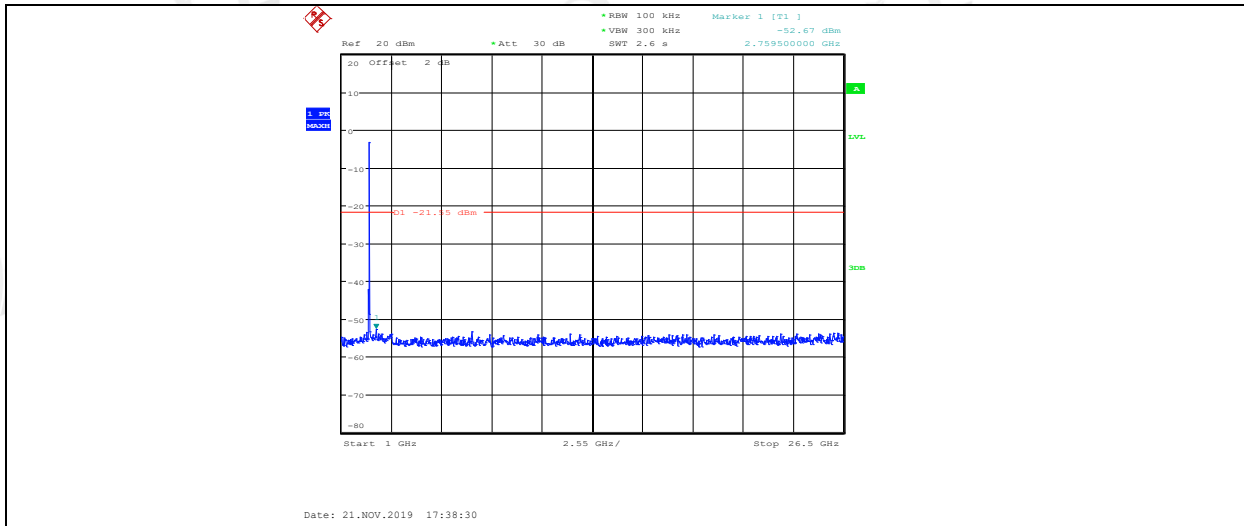

11N40MIMO_ANT1_2437_Ref

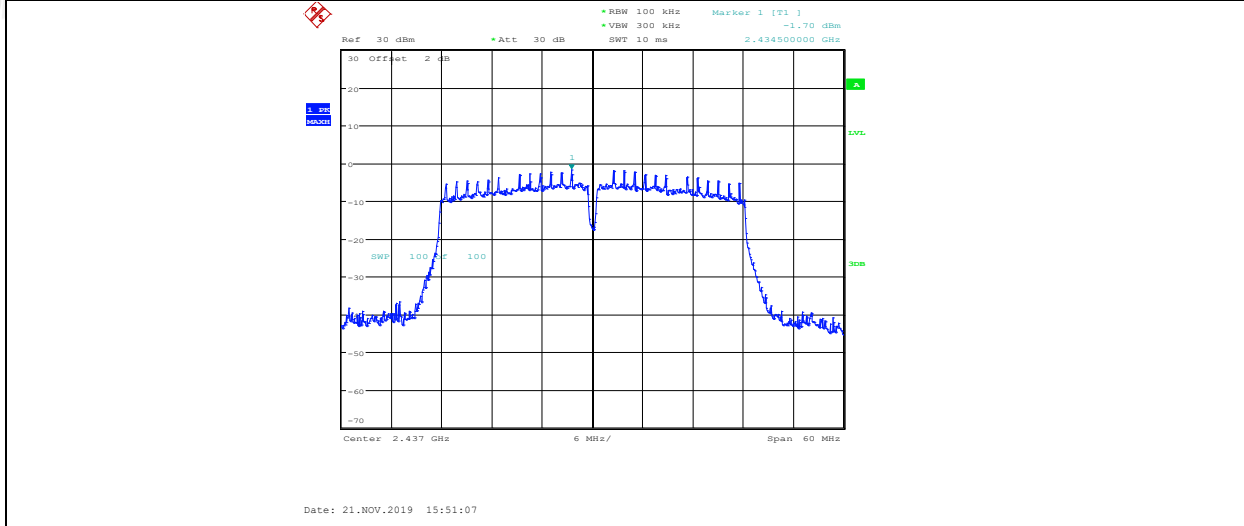

11N40MIMO_ANT1_2437_30~1000

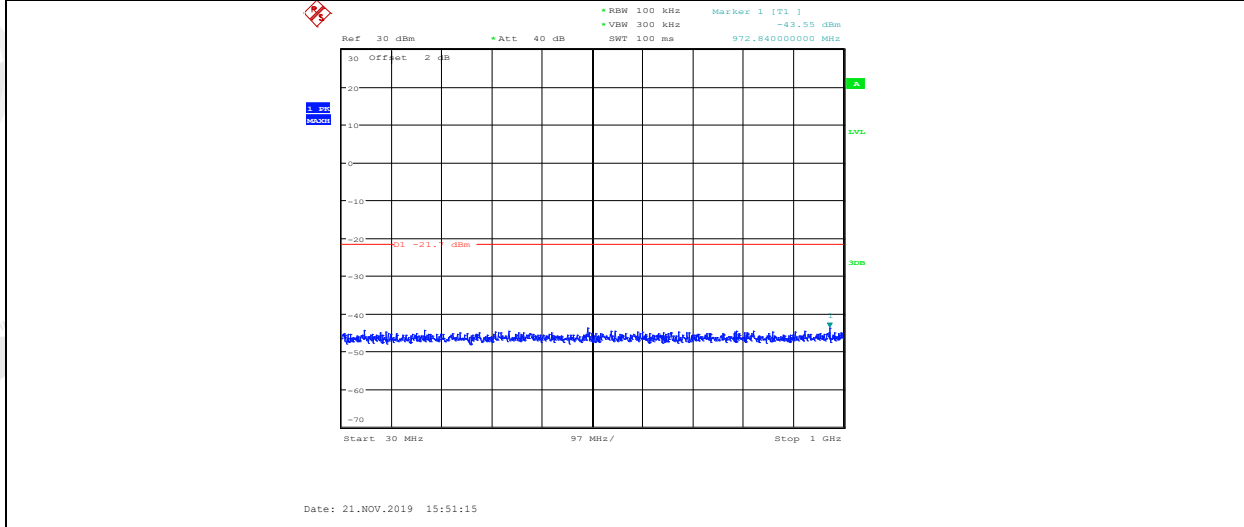

11N40MIMO_ANT1_2437_1000~26500

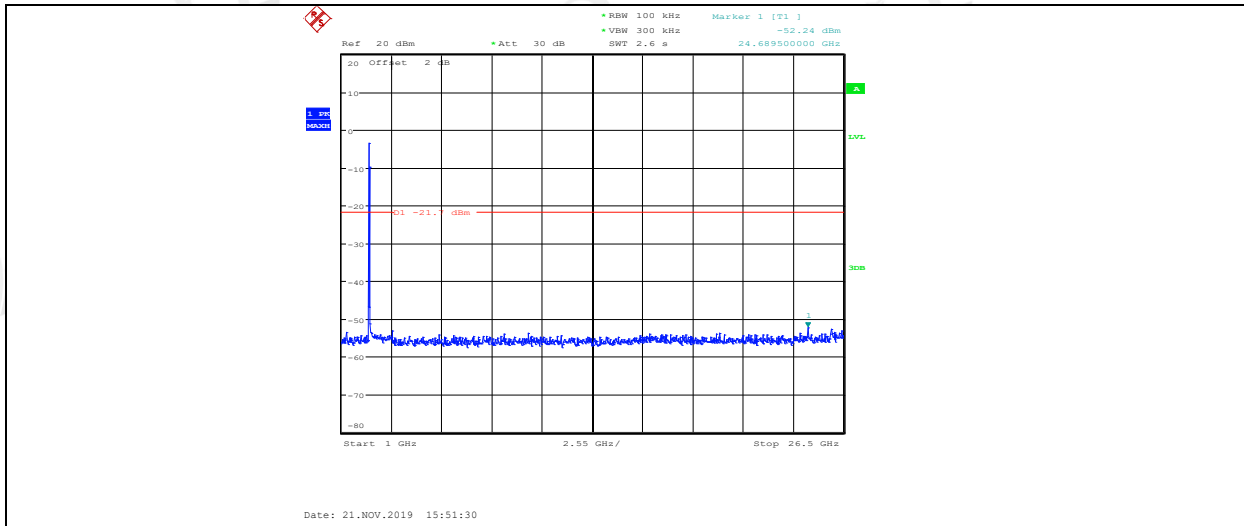

11N40MIMO_ANT2_2437_Ref

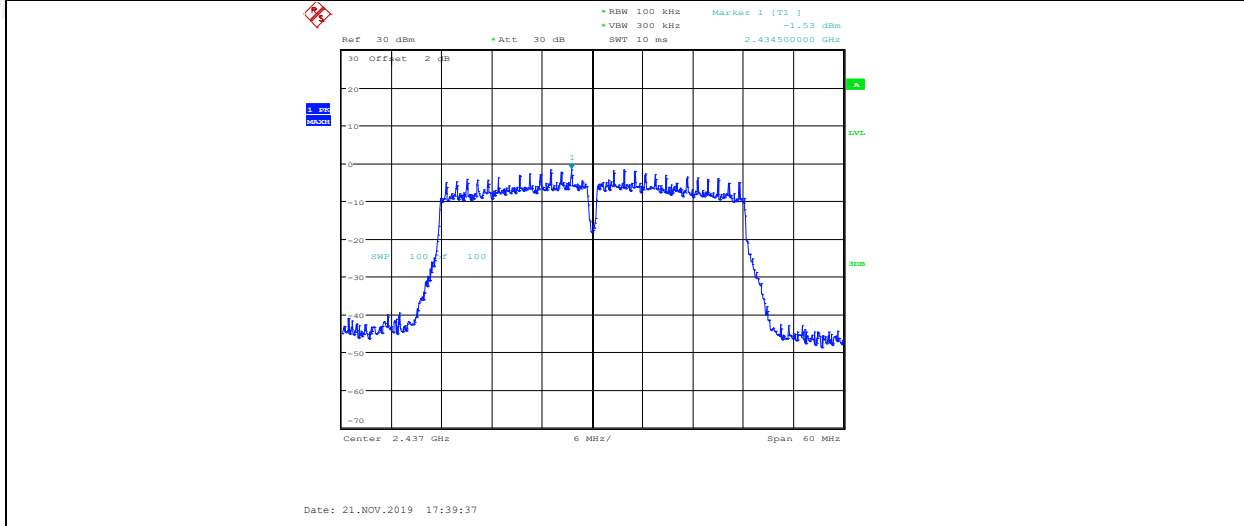

11N40MIMO_ANT2_2437_30~1000

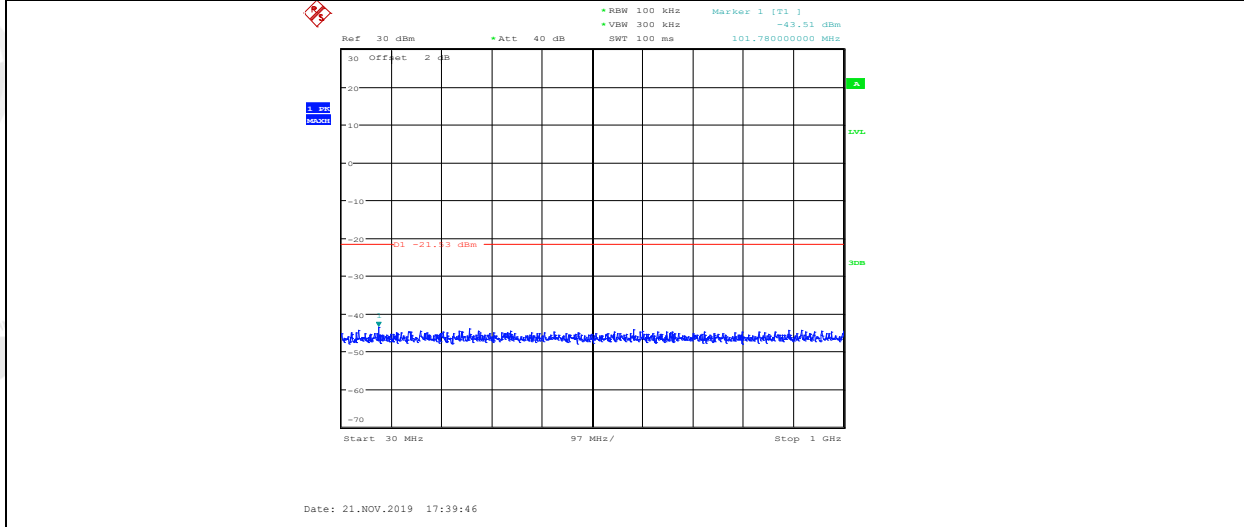

11N40MIMO_ANT2_2437_1000~26500

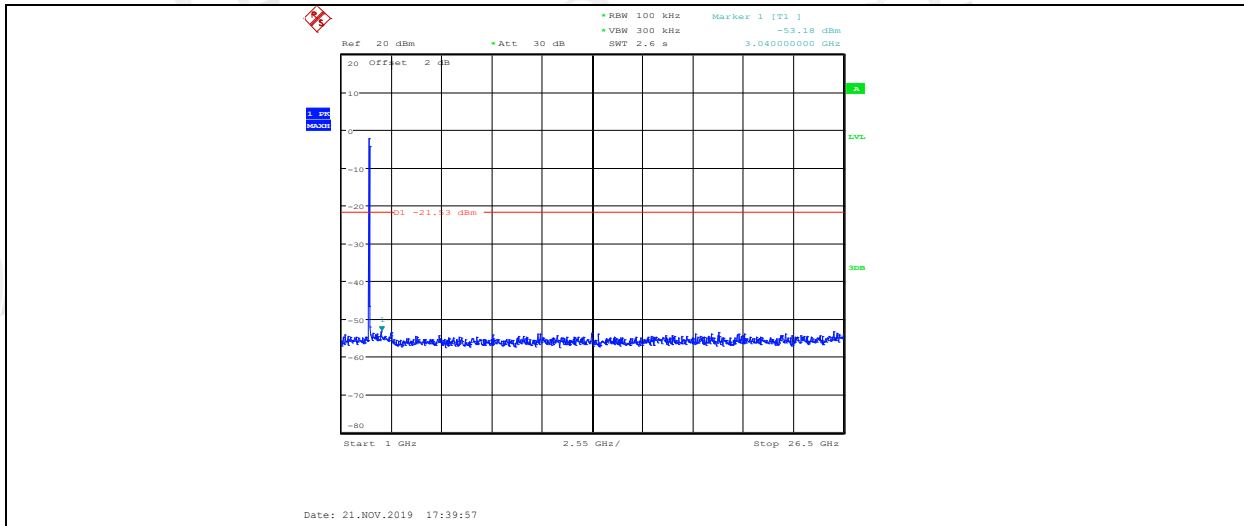

11N40MIMO_ANT1_2452_Ref

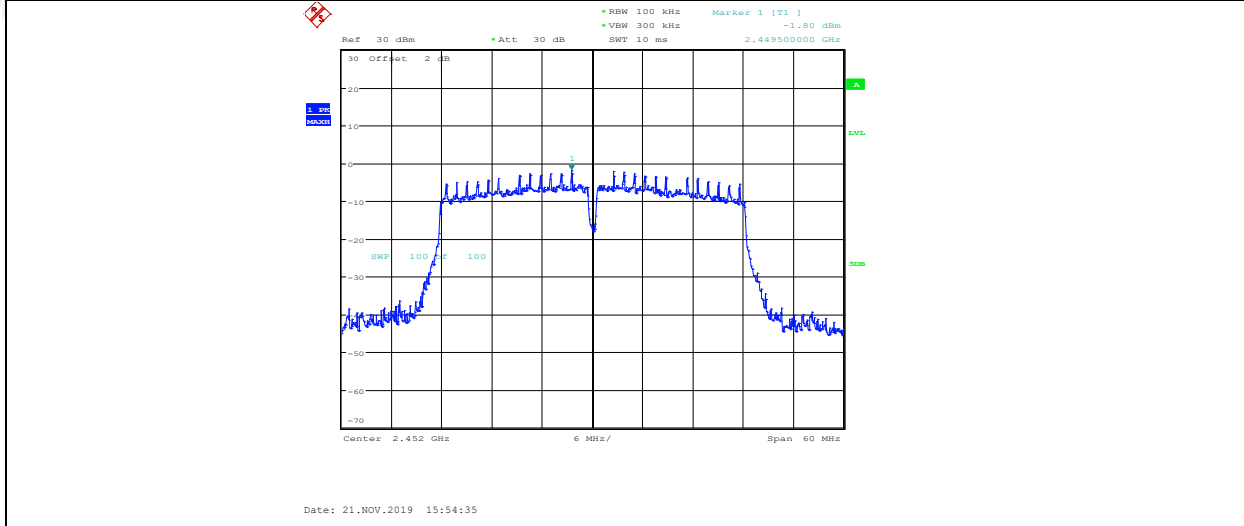

11N40MIMO_ANT1_2452_30~1000

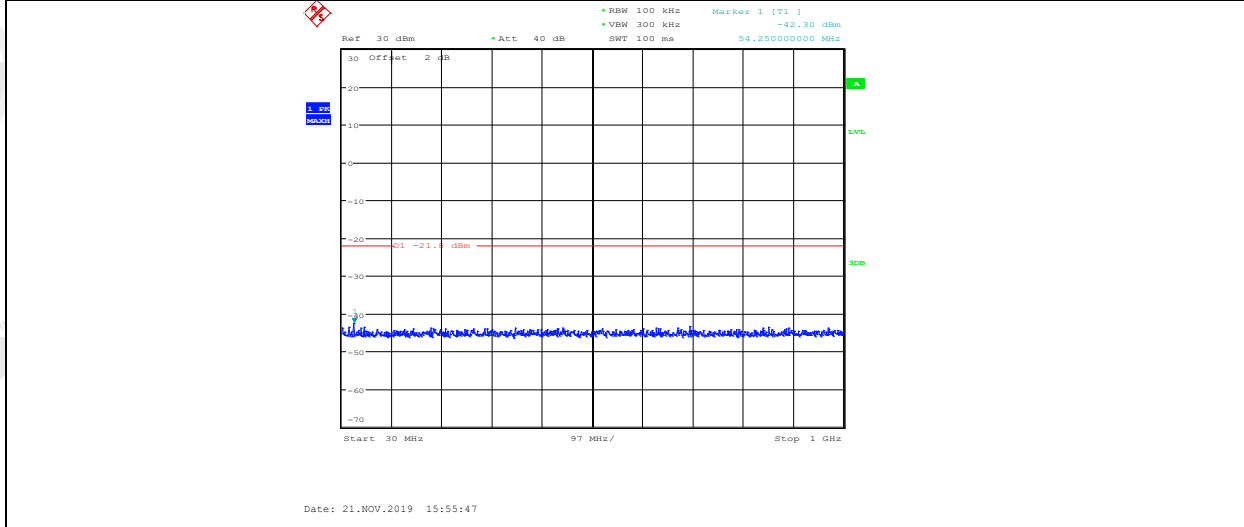

11N40MIMO_ANT1_2452_1000~26500

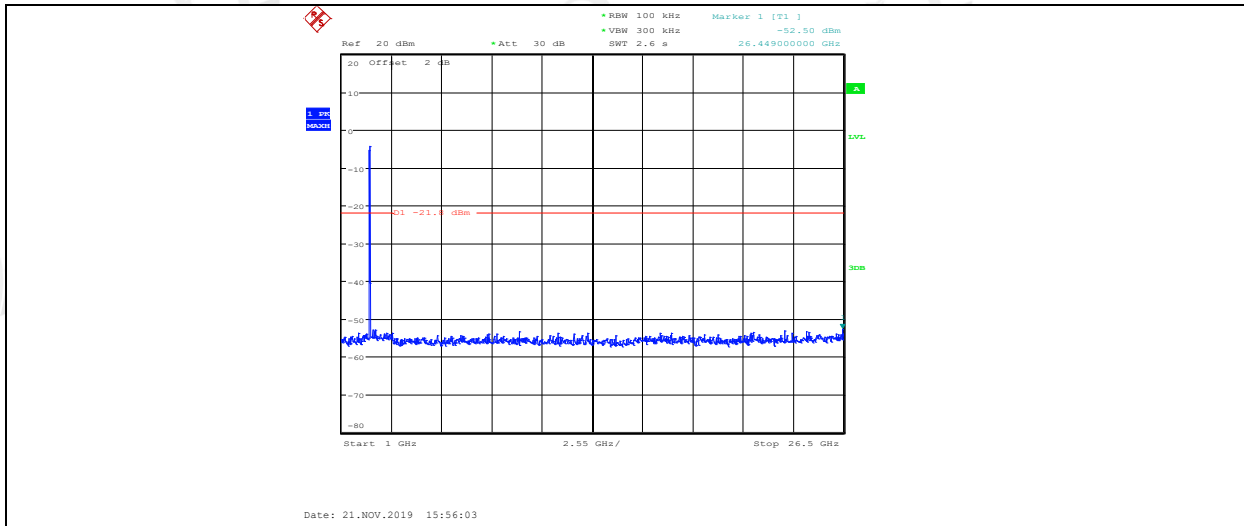

11N40MIMO_ANT2_2452_Ref

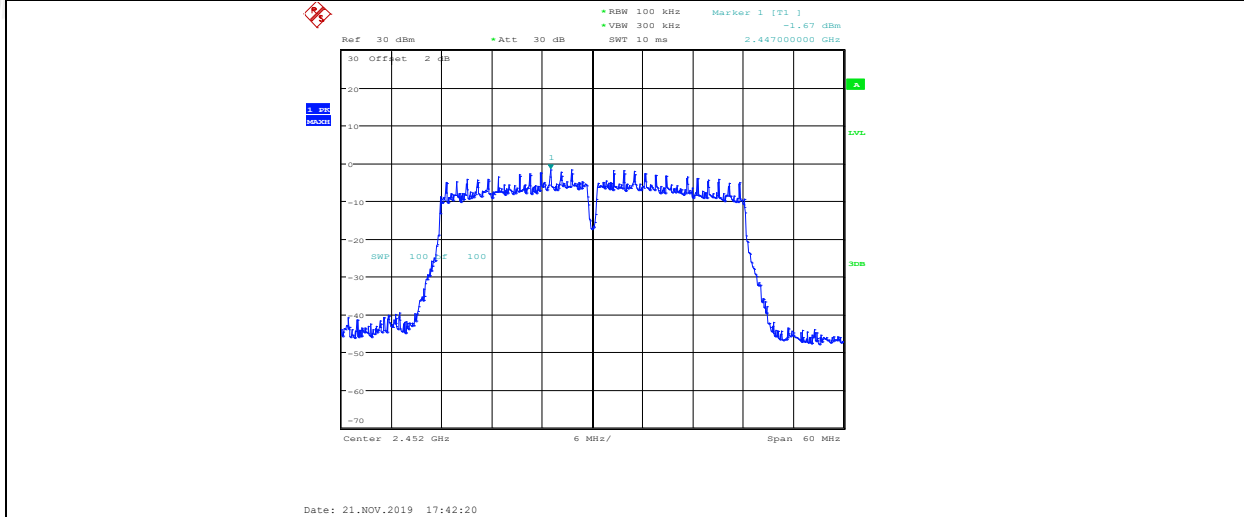

11N40MIMO_ANT2_2452_30~1000

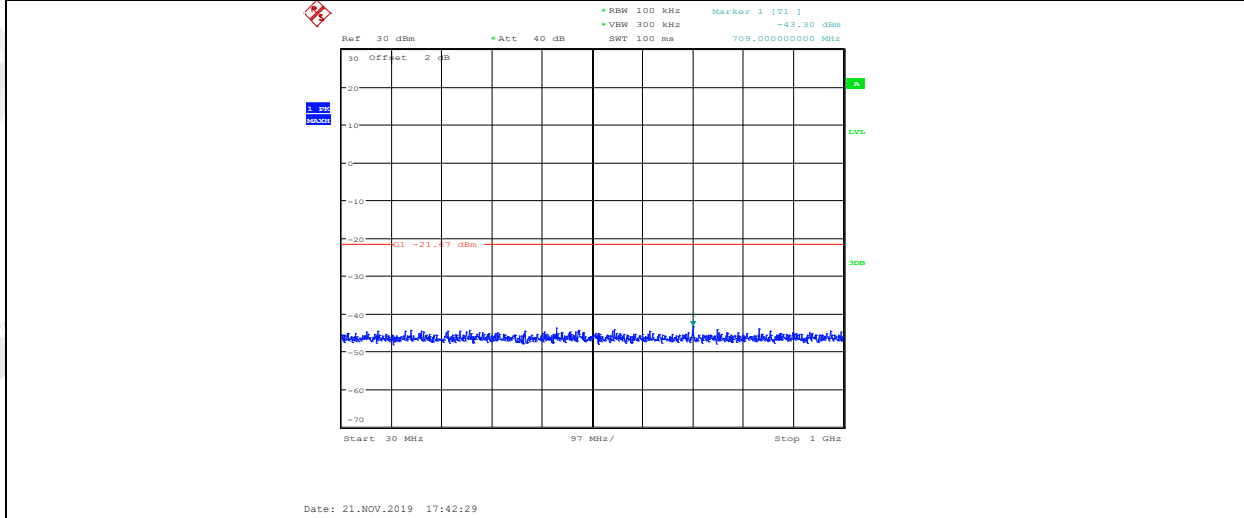

11N40MIMO_ANT2_2452_1000~26500

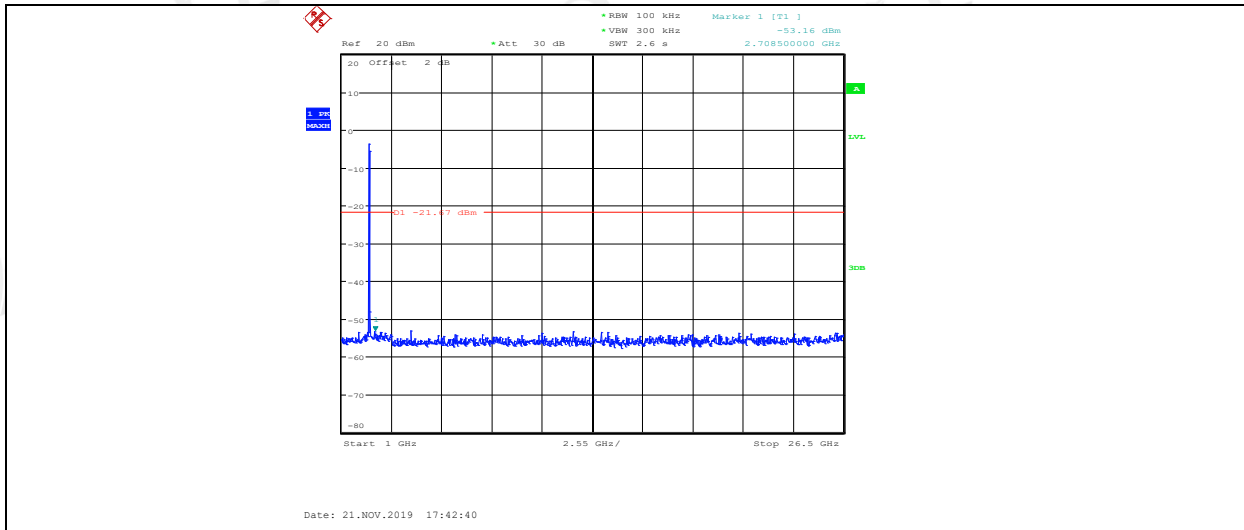

8. Radiated Spurious Emissions

8.1. Block diagram of test setup

In 3m Anechoic Chamber Test Setup Diagram for 9 kHz-30 MHz

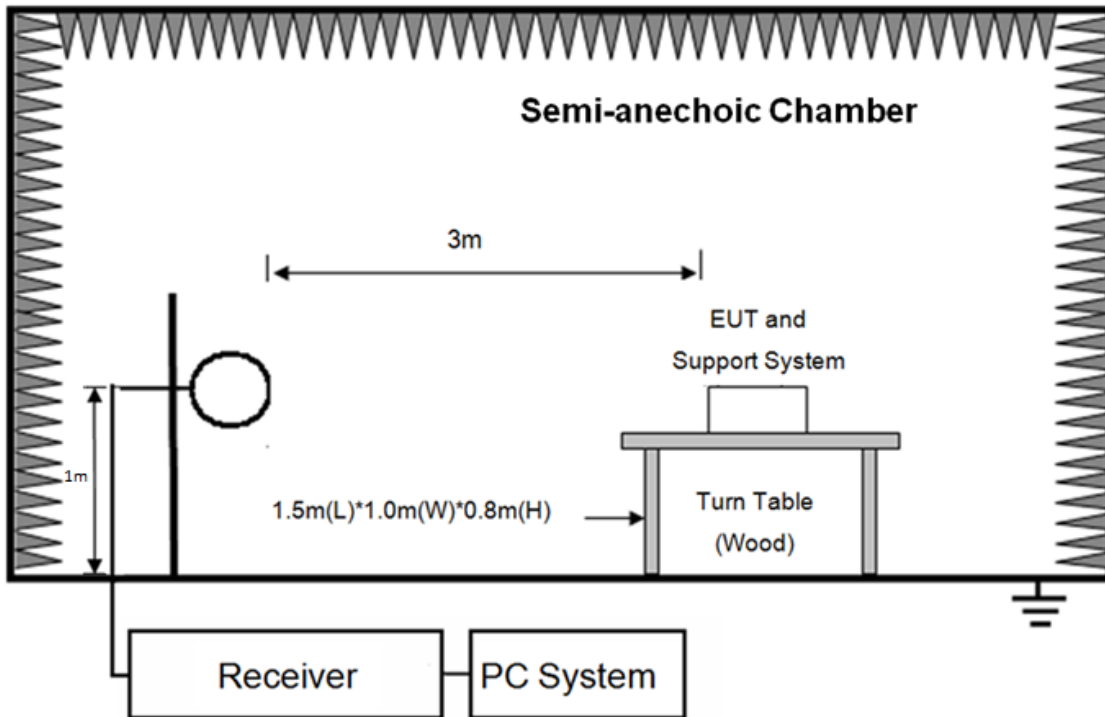

In 3m Anechoic Chamber Test Setup Diagram for 30MHz-1GHz

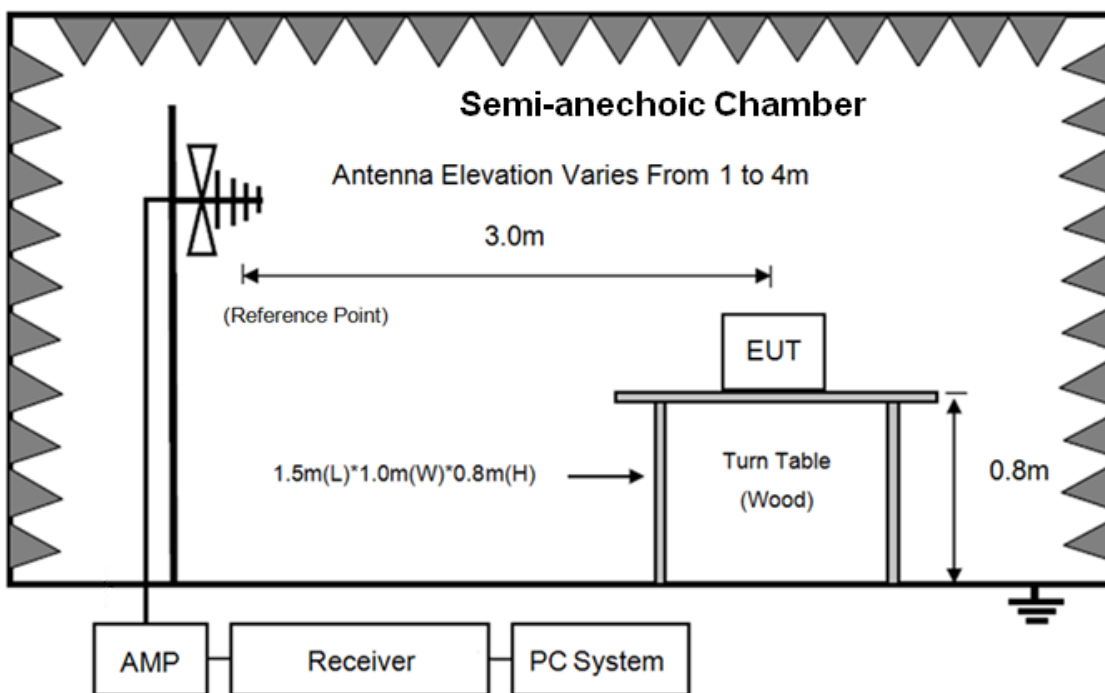

In 3m Anechoic Chamber Test Setup Diagram for frequency above 1GHz

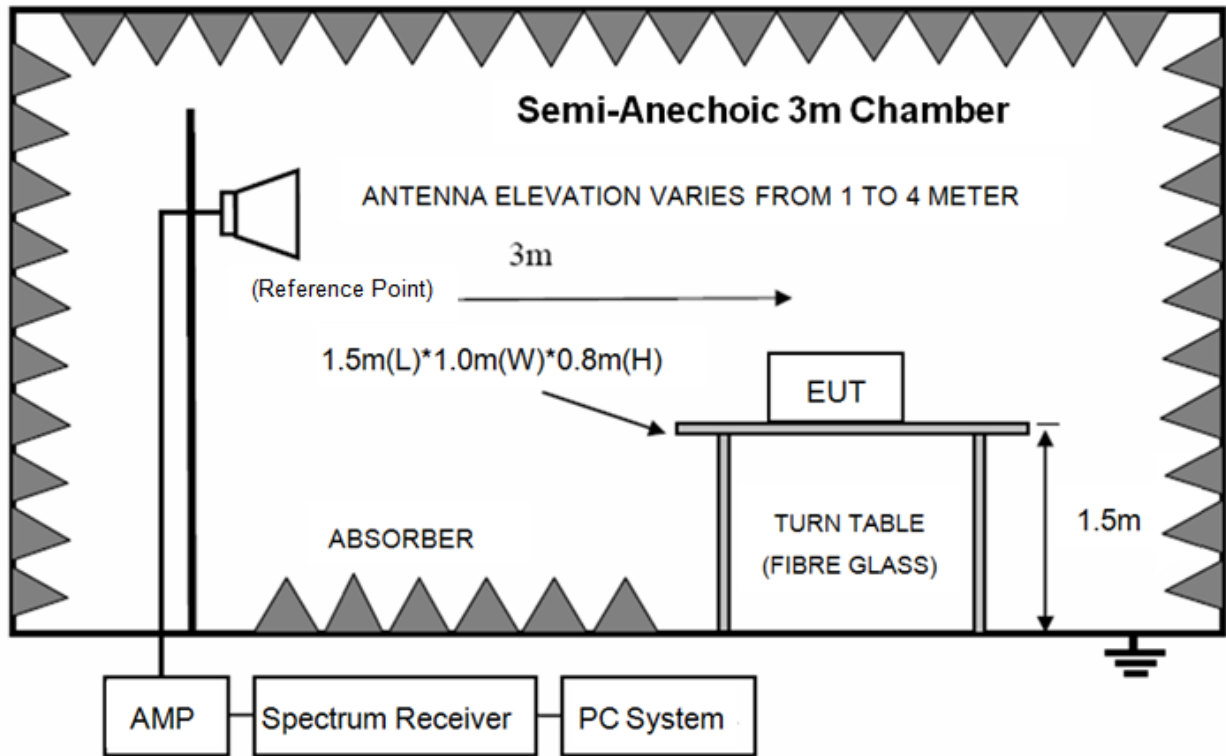

Note: For harmonic emissions test an appropriate high pass filter was inserted in the input port of AMP.

8.2. Limit

8.2.1 FCC 15.205 Restricted frequency band

MHz	MHz	MHz	GHz
0.090-0.110	16.42-16.423	399.9-410	4.5-5.15
1.495-0.505	16.69475-16.69525	608-614	5.35-5.46
2.1735-2.1905	16.80425-16.80475	960-1240	7.25-7.75
4.125-4.128	25.5-25.67	1300-1427	8.025-8.5
4.1772&4.17775	37.5-38.25	1435-1626.5	9.0-9.2
4.2072&4.20775	73-74.6	1645.5-1646.5	9.3-9.5
6.215-6.218	74.8-75.2	1660-1710	10.6-12.7
6.26775-6.26825	108-121.94	1718.8-1722.2	13.25-13.4
6.31175-6.31225	123-138	2200-2300	14.47-14.5
8.291-8.294	149.9-150.05	2310-2390	15.35-16.2
8.362-8.366	156.52475-156.52525	2483.5-2500	17.7-21.4
8.37625-8.38675	156.7-156.9	2690-2900	22.01-23.12
8.41425-8.41475	162.0125-167.17	3260-3267	23.6-24.0
12.29-12.293	167.72-173.2	3332-3339	31.2-31.8
12.51975-12.52025	240-285	3345.8-3358	36.43-36.5
12.57675-12.57725	322-335.4	3600-4400	(²)
13.36-13.41			

8.2.2 FCC 15.209 Limit.

FREQUENCY MHz	DISTANCE Meters	FIELD STRENGTHS LIMIT	
		$\mu\text{V}/\text{m}$	$\text{dB}(\mu\text{V})/\text{m}$
0.009 ~ 0.490	300	2400/F(kHz)	67.6-20log(F)
0.490 ~ 1.705	30	24000/F(kHz)	87.6-20log(F)
1.705 ~ 30.0	30	30	29.54
30 ~ 88	3	100	40.0
88 ~ 216	3	150	43.5
216 ~ 960	3	200	46.0
960 ~ 1000	3	500	54.0
Above 1000	3	74.0 dB(μV)/m (Peak) 54.0 dB(μV)/m (Average)	

Note: (1) The emission limits shown in the above table are based on measurements employing a CISPR QP detector except for the frequency bands 9-90 kHz, 110-490 kHz and above 1000MHz. Radiated emissions limits in these three bands are based on measurements employing an average detector.

(2) At frequencies below 30MHz, measurement may be performed at a distance closer than that specified, and the limit at closer measurement distance can be extrapolated by below formula:

$$\text{Limit}_{3\text{m}}(\text{dB}\mu\text{V}/\text{m}) = \text{Limit}_{30\text{m}}(\text{dB}\mu\text{V}/\text{m}) + 40\text{Log}(30\text{m}/3\text{m})$$

8.2.3 Limit for this EUT

All the emissions appearing within 15.205 restricted frequency bands shall not exceed the limits shown in 15.209, all the other emissions shall be at least 20dB below the fundamental emissions or comply with 15.209 limits.

8.3. Test Procedure

(1) EUT height should be 0.8 m for below 1 GHz at a semi-anechoic chamber while EUT height should be 1.5 m for above 1 GHz at full chamber or semi-anechoic chamber ground with absorbers.

(2) The antenna used as below table.

Test frequency range	Test antenna used	Measuring distance
9 kHz-30 MHz	Active Loop antenna	3 m
30 MHz-1 GHz	Trilog Broadband Antenna	3 m
1 GHz-18 GHz	Double Ridged Horn Antenna(1GHz-18GHz)	3 m
18 GHz-40 GHz	Horn Antenna(18GHz-40GHz)	1 m

According ANSI C63.10:2013 clause 6.4.4.2 and 6.5.3, for measurements below 30 MHz, the

loop antenna was positioned with its plane vertical from the EUT and rotated about its vertical axis for maximum response at each azimuth position around the EUT. And the loop antenna also be positioned with its plane horizontal at the specified distance from the EUT. The center of the loop is 1 m above the ground. for measurement above 30 MHz, the Trilog Broadband Antenna or Horn Antenna was located 3 m from EUT, Measurements were made with the antenna positioned in both the horizontal and vertical planes of Polarization, and the measurement antenna was varied from 1 m to 4 m. in height above the reference ground plane to obtain the maximum signal strength.

(3) Below pre-scan procedure was first performed in order to find prominent frequency spectrum radiated emissions from 9 kHz to 25 GHz:

(a) Scanning the peak frequency spectrum with the antenna specified in step (3), and the EUT was rotated 360 degree, the antenna height was varied from 1 m to 4 m (Except loop antenna, it's fixed 1m above ground.)

(b) Change work frequency or channel of device if practicable.

(c) Change modulation type of device if practicable.

(d) Change power supply range from 85% to 115% of the rated supply voltage

(e) Rotated EUT though three orthogonal axes to determine the attitude of EUT arrangement produces highest emissions.

Spectrum frequency from 9 kHz to 25 GHz (tenth harmonic of fundamental frequency) was investigated, and no any obvious emission were detected from 18GHz to 25GHz, so below final test was performed with frequency range from 9kHz to 18GHz.

(4) For final emissions measurements at each frequency of interest, the EUT was rotated and the antenna height was varied between 1 m and 4 m in order to maximize the emission. Measurements in both horizontal and vertical polarities were made and the data was recorded. In order to find the maximum emission, the relative positions of equipments and all of the interface cables were changed according to ANSI C63.10 2013 on Radiated Emission test.

(5) The emissions from 9 kHz to 1 GHz were measured based on CISPR QP detector except for the frequency bands 9-90 kHz, 110-490 kHz, for emissions from 9 kHz-90 kHz, 110 kHz-490 kHz and above 1 GHz were measured based on average detector, for emissions above 1 GHz, peak emissions also be measured and need comply with Peak limit.

(6) The emissions from 9 kHz to 1 GHz, QP or average values were measured with EMI receiver with below RBW

Frequency band	RBW
9 kHz-150 kHz	200 Hz
150 kHz-30 MHz	9 kHz
30 MHz-1 GHz	120 kHz

(7) For emissions above 1GHz, both Peak and Average level were measured with Spectrum Analyzer, and the RBW is set at 1 MHz, VBW is set at 3 MHz for Peak measure; About

Average measure refer to ANSI C63.10:2013 clause 4.2.3.2.3 procedure for average measure.

8.4. Test result

PASS. (See below detailed test result)

All the emissions except fundamental emission from 9 kHz to 25 GHz were comply with 15.209 limit.

Note1: According exploratory test no any obvious emission was detected from 9 kHz to 30 MHz and 18 GHz to 25 GHz, so the final test was performed with frequency range from 30 MHz to 18 GHz and recorded in below.

Note2: For emissions below 1 GHz, according exploratory explorer test, when change Tx mode and channel, have no distinct influence on emissions level, so for emissions below 1 GHz, the final test was only performed with EUT working in ANT1+ ANT2, 11n HT20, Tx CH11 mode.

Radiated Emission test (below 1GHz) TR-4-E-009 Radiated Emission Test Result

Test Site : DDT 3m Chamber 1#	D:\2019 RE1# Report Data\Q19080513-1E Bar9.1\FCC BELOW1G.EM6
Test Date : 2019-11-03	Tested By : Jacky
EUT : SOUNDBAR	Model Number : BAR 9.1 CNTR
Power Supply : AC 120 V/ 60Hz	Test Mode : Tx mode
Condition : Temp:24.5°C,Humi:55%,Press:101.4kPa	Antenna/Distance : 2018 VULB 9163 1#/3m/VERTICAL
Memo :	

Data: 5

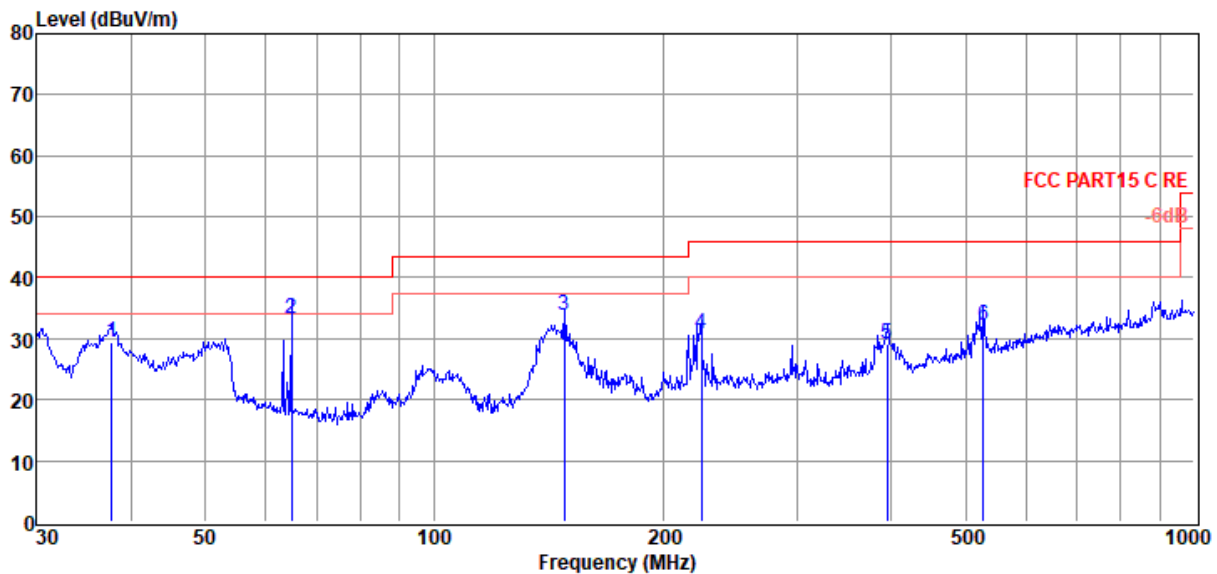

Item (Mark)	Freq. (MHz)	Read Level (dBμV)	Antenna Factor (dB/m)	Cable Loss (dB)	Result Level (dBμV/m)	Limit Line (dBμV/m)	Over Limit (dB)	Detector	Polarization
1	37.68	12.70	12.92	3.74	29.36	40.00	-10.64	QP	VERTICAL
2	64.89	18.78	10.43	3.99	33.20	40.00	-6.80	QP	VERTICAL
3	148.44	20.94	8.45	4.50	33.89	43.50	-9.61	QP	VERTICAL
4	224.52	13.85	12.14	4.90	30.89	46.00	-15.11	QP	VERTICAL
5	394.85	8.04	15.53	5.49	29.06	46.00	-16.94	QP	VERTICAL
6	528.25	8.75	17.52	5.90	32.17	46.00	-13.83	QP	VERTICAL

Note: 1. Result Level = Read Level + Antenna Factor + Cable loss.
 2. If Peak Result complies with QP limit, QP Result is deemed to comply with QP limit.
 3. Test setup: RBW: 120 kHz, VBW: 300 kHz, Sweep time: auto.

TR-4-E-009 Radiated Emission Test Result

Test Site : DDT 3m Chamber 1#
Test Date : 2019-11-03
EUT : SOUNDBAR
Power Supply : AC 120 V/ 60Hz
Condition : Temp:24.5°C,Humi:55%,Press:101.4kPa
Memo :

D:\2019 RE1# Report Data\Q19080513-1E Bar9.1\FCC BELOW1G.EM6
Tested By : Jacky
Model Number : BAR 9.1 CNTR
Test Mode : Tx mode
Antenna/Distance : 2018 VULB 9163 1#/3m/HORIZONTAL

Data: 6

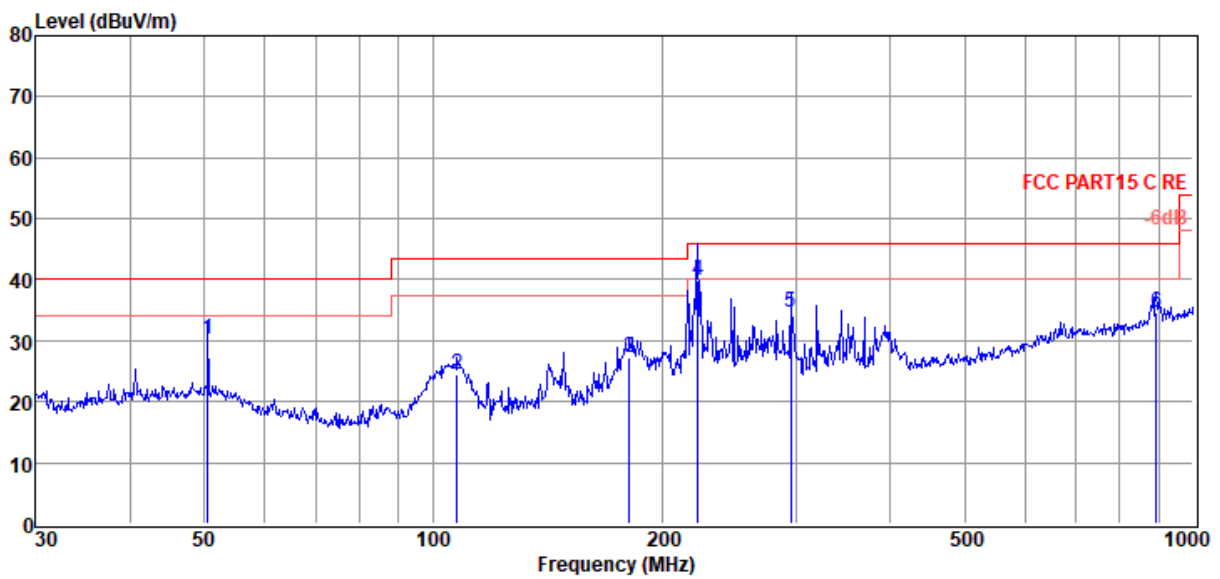

Item (Mark)	Freq. (MHz)	Read Level (dBμV)	Antenna Factor (dB/m)	Cable Loss (dB)	Result Level (dBμV/m)	Limit Line (dBμV/m)	Over Limit (dB)	Detector	Polarization
1	50.59	11.99	14.40	3.87	30.26	40.00	-9.74	QP	HORIZONTAL
2	107.51	8.33	11.78	4.24	24.35	43.50	-19.15	QP	HORIZONTAL
3	181.28	12.73	9.74	4.74	27.21	43.50	-16.29	QP	HORIZONTAL
4	222.95	22.81	12.10	4.90	39.81	46.00	-6.19	QP	HORIZONTAL
5	295.15	15.64	13.90	5.17	34.71	46.00	-11.29	QP	HORIZONTAL
6	893.86	6.13	21.64	6.89	34.66	46.00	-11.34	QP	HORIZONTAL

- Note: 1. Result Level = Read Level + Antenna Factor + Cable loss.
 2. If Peak Result complies with QP limit, QP Result is deemed to comply with QP limit.
 3. Test setup: RBW: 120 kHz, VBW: 300 kHz, Sweep time: auto.

Radiated Emission test (above 1GHz)

Freq (MHz)	Read level (dBμV)	Antenna Factor (dB/m)	PRM Factor(dB)	Cable Loss (dB)	Result Level (dBμV/m)	Limit (dBμV/m)	Margin (dB)	Detector type	Polarization
11n HT20 CH1									
4824.00	52.86	33.80	43.82	5.53	48.37	74.00	-25.63	Peak	HORIZONTAL
8004.00	45.85	36.30	43.15	7.34	46.34	74.00	-27.66	Peak	HORIZONTAL
9959.00	45.50	37.38	43.23	8.71	48.36	74.00	-25.64	Peak	HORIZONTAL
12016.00	46.16	38.00	42.68	9.13	50.61	74.00	-23.39	Peak	HORIZONTAL
13444.00	45.54	38.92	42.35	10.88	52.99	74.00	-21.01	Peak	HORIZONTAL
14090.00	43.94	40.22	41.75	11.11	53.52	74.00	-20.48	Peak	HORIZONTAL
4824.00	51.35	33.80	43.82	5.53	46.86	74.00	-27.14	Peak	VERTICAL
7239.00	47.08	35.75	43.24	6.44	46.03	74.00	-27.97	Peak	VERTICAL
9041.00	44.30	36.83	42.26	7.95	46.82	74.00	-27.18	Peak	VERTICAL
10180.00	45.49	37.51	43.00	8.79	48.79	74.00	-25.21	Peak	VERTICAL
12084.00	46.34	38.02	42.72	9.24	50.88	74.00	-23.12	Peak	VERTICAL
13750.00	44.24	39.61	42.03	11.00	52.82	74.00	-21.18	Peak	VERTICAL
11n HT20 CH6									
4876.00	53.22	33.83	43.78	5.54	48.81	74.00	-25.19	Peak	HORIZONTAL
6950.00	46.19	35.57	43.13	6.18	44.81	74.00	-29.19	Peak	HORIZONTAL
8871.00	43.99	36.80	42.18	7.85	46.46	74.00	-27.54	Peak	HORIZONTAL
10639.00	44.58	37.64	42.22	8.91	48.91	74.00	-25.09	Peak	HORIZONTAL
12730.00	45.05	38.19	42.91	10.28	50.61	74.00	-23.39	Peak	HORIZONTAL
13971.00	44.05	40.13	41.79	11.09	53.48	74.00	-20.52	Peak	HORIZONTAL
4876.00	50.25	33.83	43.78	5.54	45.84	74.00	-28.16	Peak	VERTICAL
7324.00	47.88	35.80	43.28	6.54	46.94	74.00	-27.06	Peak	VERTICAL
9670.00	45.41	37.21	43.10	8.47	47.99	74.00	-26.01	Peak	VERTICAL
11200.00	45.14	37.95	41.83	9.02	50.28	74.00	-23.72	Peak	VERTICAL
12951.00	46.01	38.28	42.84	10.63	52.08	74.00	-21.92	Peak	VERTICAL
14226.00	43.80	40.25	41.75	11.13	53.43	74.00	-20.57	Peak	VERTICAL
11n HT20 CH11									
4924.00	56.36	33.86	43.74	5.56	52.04	74.00	-21.96	Peak	HORIZONTAL
7386.00	50.33	35.83	43.30	6.62	49.48	74.00	-24.52	Peak	HORIZONTAL
9704.00	45.40	37.23	43.11	8.50	48.02	74.00	-25.98	Peak	HORIZONTAL
12050.00	46.12	38.01	42.70	9.18	50.61	74.00	-23.39	Peak	HORIZONTAL
13461.00	44.77	38.95	42.33	10.89	52.28	74.00	-21.72	Peak	HORIZONTAL
13971.00	43.93	40.13	41.79	11.09	53.36	74.00	-20.64	Peak	HORIZONTAL
4924.00	52.53	33.86	43.74	5.56	48.21	74.00	-25.79	Peak	VERTICAL
7386.00	49.63	35.83	43.30	6.62	48.78	74.00	-25.22	Peak	VERTICAL
9466.00	45.29	37.09	42.96	8.30	47.72	74.00	-26.28	Peak	VERTICAL
11336.00	45.08	38.24	42.15	9.03	50.20	74.00	-23.80	Peak	VERTICAL
13070.00	45.25	38.40	42.75	10.74	51.64	74.00	-22.36	Peak	VERTICAL
14141.00	43.91	40.23	41.75	11.12	53.51	74.00	-20.49	Peak	VERTICAL

Note: 1.30MHz~25GHz: (Scan with 11b mode ANT 1 and ANT 2, 11g mode ANT 1 and ANT 2, 11n HT20 mode ANT 1 and ANT 2, 11n HT40 mode ANT 1 and ANT 2, the worst case is 11n HT20 ANT 1 mode)

2. Result Level = Read Level + Antenna Factor + Cable loss - PRM Factor.

3. Test setup: RBW: 1 MHz, VBW: 3 MHz, Sweep time: auto.

4. For emissions above 1GHz. If peak results comply with AV limit, AV Result is deemed to comply with AV limit.

9. Radiated Band Edge Compliance

9.1. Block diagram of test setup

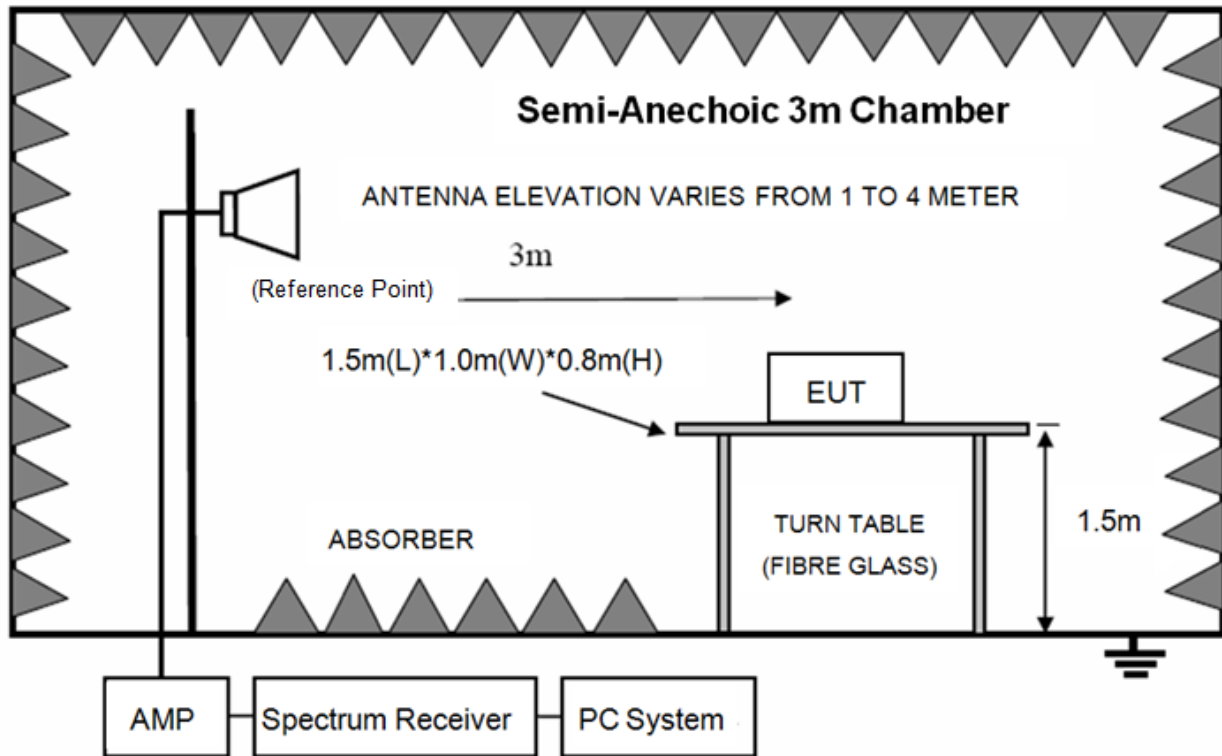

9.2. Limit

All restricted frequency bands shall not exceed the limits shown in 15.209, all the other emissions outside operation frequency band 2400 MHz to 2483.5 MHz shall be at least 20dB below the fundamental emissions or comply with RSS-Gen Issue 3 clause 7.2.5 (Same as FCC 15.209) limits.

9.3. Test Procedure

Same with clause 8.3 except change investigated frequency range from 2310 MHz to 2430 MHz and 2445 MHz to 2500 MHz, 2310 MHz to 2450 MHz and 2425 MHz to 2500MHz.

Remark: All restriction band have been tested, and only the worst case is shown in report.

9.4. Test result

PASS. (See below detailed test result)

Note: 11b, 11g, n20 mode ANT 1 and ANT 2 mode all have been tested, only Ant 1 mode is worse case and reported.

TR-4-E-009 Radiated Emission Test Result

Test Site : DDT 3m Chamber 1#

D:\2019 RE1# Report Data\Q19080513-1E Bar9.1\FCC ABOVE 1G.EM6

Test Date : 2019-11-24

Tested By : Jacky

EUT : SOUNDBAR

Model Number : BAR 9.1 CNTR

Power Supply : AC 230V/50Hz

Test Mode : Tx mode

Condition : Temp:24.5°C,Humi:55%,Press:100.1kPa

Antenna/Distance : 2019 BBHA 9120 D/3m/HORIZONTAL

Memo : 11B 2412 ANT1 POWER 16

Data: 217

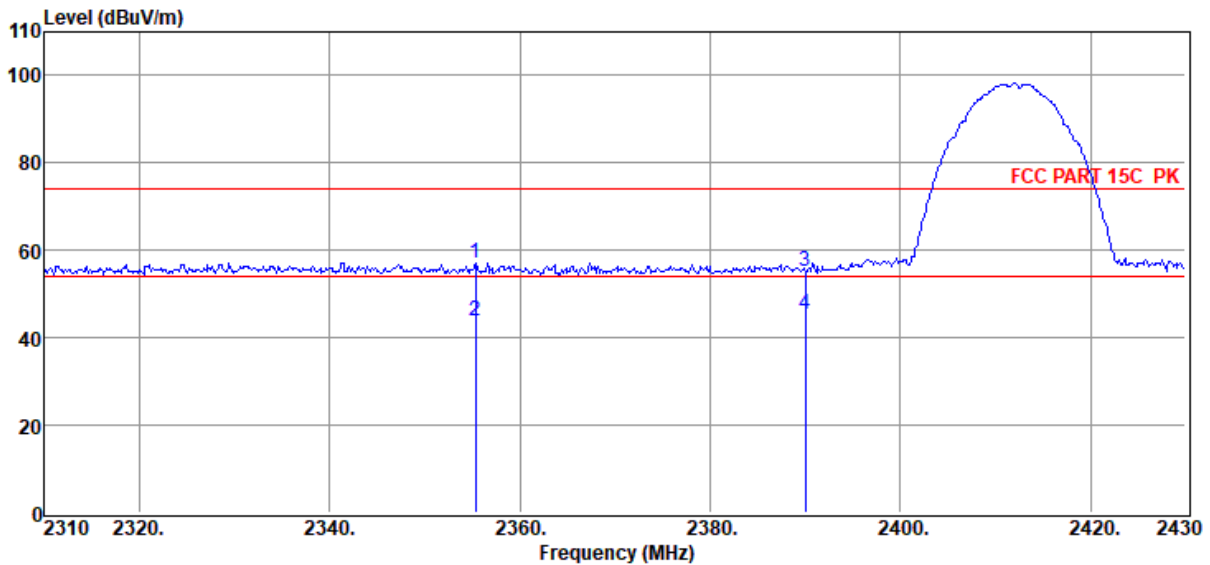

Item (Mark)	Freq. (MHz)	Read Level (dBμV)	Antenna Factor (dB/m)	PRM Factor (dB)	Cable Loss (dB)	Result Level (dBμV/m)	Limit Line (dBμV/m)	Over Limit (dB)	Detector	Polarization
1	2355.36	26.46	27.11	0.00	3.67	57.24	74.00	-16.76	Peak	HORIZONTAL
2	2355.36	13.11	27.11	0.00	3.67	43.89	54.00	-10.11	Average	HORIZONTAL
3	2390.00	24.22	27.23	0.00	3.73	55.18	74.00	-18.82	Peak	HORIZONTAL
4	2390.00	14.45	27.23	0.00	3.73	45.41	54.00	-8.59	Average	HORIZONTAL

Note: 1. Result Level = Read Level + Antenna Factor + Cable loss - PRM Factor.

2. If Peak Result complies with AV limit, AV Result is deemed to comply with AV limit.

3. Test setup: RBW: 1 MHz, VBW: 3 MHz, Sweep time: auto.

TR-4-E-009 Radiated Emission Test Result

Test Site : DDT 3m Chamber 1# D:\2019 RE1# Report Data\Q19080513-1E Bar9.1\FCC ABOVE 1G.EM6
Test Date : 2019-11-24 **Tested By** : Jacky
EUT : SOUNDBAR **Model Number** : BAR 9.1 CNTR
Power Supply : AC 230V/50Hz **Test Mode** : Tx mode
Condition : Temp:24.5°C,Humi:55%,Press:100.1kPa **Antenna/Distance** : 2019 BBHA 9120 D/3m/VERTICAL
Memo : 11B 2412 ANT1 POWER 16

Data: 218

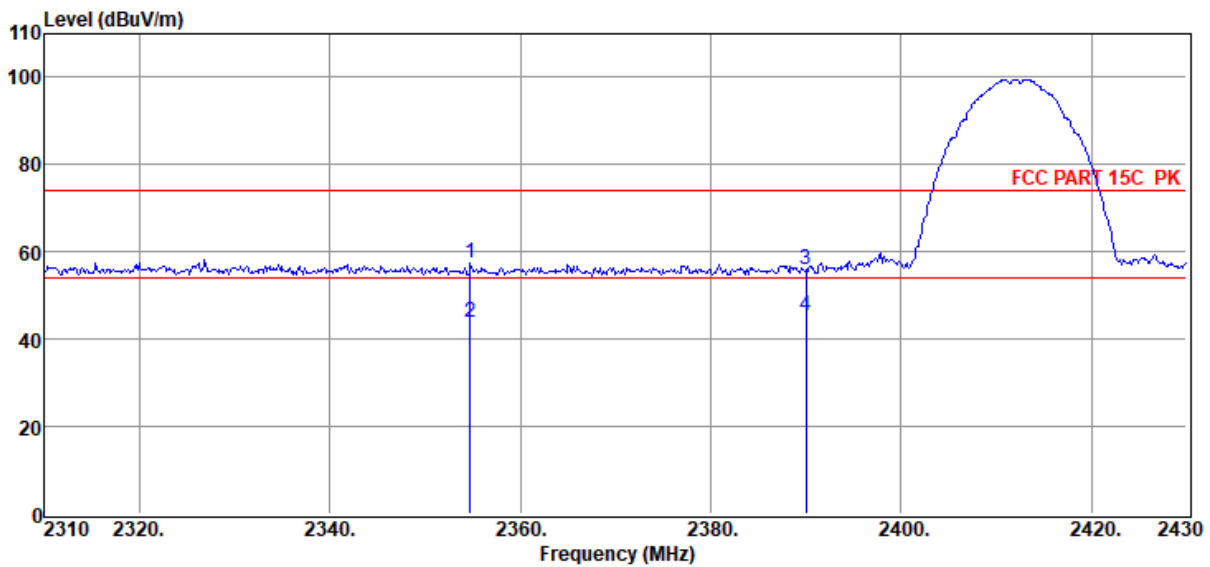

Item (Mark)	Freq. (MHz)	Read Level (dBμV)	Antenna Factor (dB/m)	PRM Factor (dB)	Cable Loss (dB)	Result Level (dBμV/m)	Limit Line (dBμV/m)	Over Limit (dB)	Detector	Polarization
1	2354.76	26.77	27.11	0.00	3.67	57.55	74.00	-16.45	Peak	VERTICAL
2	2354.76	13.04	27.11	0.00	3.67	43.82	54.00	-10.18	Average	VERTICAL
3	2390.00	24.82	27.23	0.00	3.73	55.78	74.00	-18.22	Peak	VERTICAL
4	2390.00	14.32	27.23	0.00	3.73	45.28	54.00	-8.72	Average	VERTICAL

Note: 1. Result Level = Read Level + Antenna Factor + Cable loss - PRM Factor.
 2. If Peak Result complies with AV limit, AV Result is deemed to comply with AV limit.
 3. Test setup: RBW: 1 MHz, VBW: 3 MHz, Sweep time: auto.

TR-4-E-009 Radiated Emission Test Result

Test Site : DDT 3m Chamber 1#

D:\2019 RE1# Report Data\Q19080513-1E Bar9.1\FCC ABOVE 1G.EM6

Test Date : 2019-11-24

Tested By : Jacky

EUT : SOUNDBAR

Model Number : BAR 9.1 CNTR

Power Supply : AC 230V/50Hz

Test Mode : Tx mode

Condition : Temp:24.5°C,Humi:55%,Press:100.1kPa

Antenna/Distance : 2019 BBHA 9120 D/3m/VERTICAL

Memo : 11B 2412 ANT2 POWER 16

Data: 219

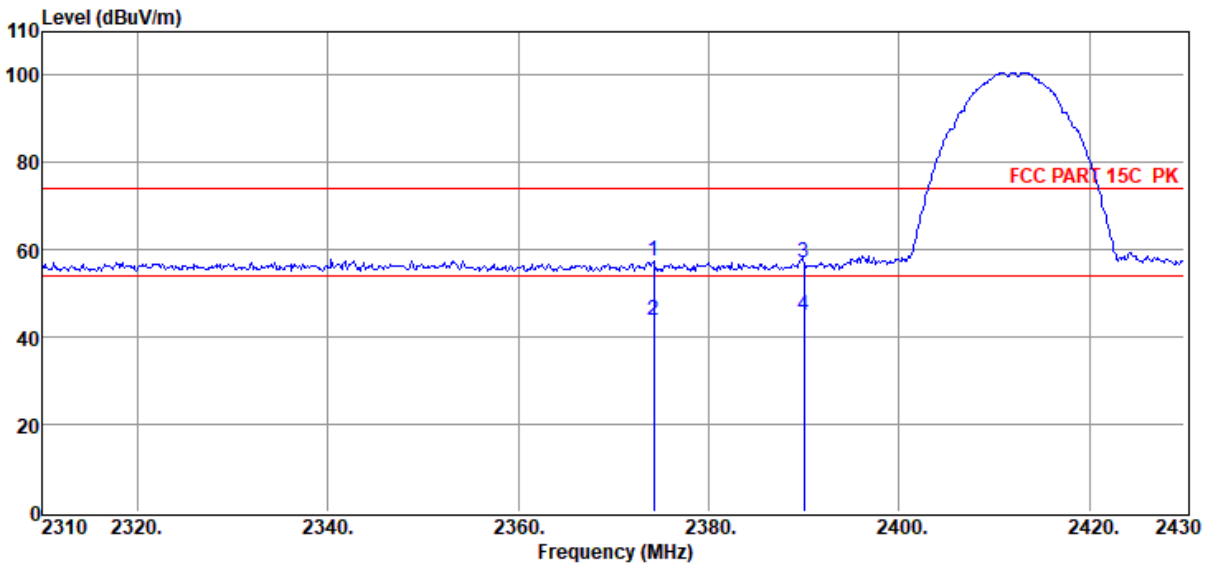

Item (Mark)	Freq. (MHz)	Read Level (dBμV)	Antenna Factor (dB/m)	PRM Factor (dB)	Cable Loss (dB)	Result Level (dBμV/m)	Limit Line (dBμV/m)	Over Limit (dB)	Detector	Polarization
1	2374.20	26.62	27.17	0.00	3.70	57.49	74.00	-16.51	Peak	VERTICAL
2	2374.20	13.02	27.17	0.00	3.70	43.89	54.00	-10.11	Average	VERTICAL
3	2390.00	26.07	27.23	0.00	3.73	57.03	74.00	-16.97	Peak	VERTICAL
4	2390.00	13.86	27.23	0.00	3.73	44.82	54.00	-9.18	Average	VERTICAL

Note: 1. Result Level = Read Level + Antenna Factor + Cable loss - PRM Factor.

2. If Peak Result complies with AV limit, AV Result is deemed to comply with AV limit.

3. Test setup: RBW: 1 MHz, VBW: 3 MHz, Sweep time: auto.

TR-4-E-009 Radiated Emission Test Result

Test Site : DDT 3m Chamber 1#

D:\2019 RE1# Report Data\Q19080513-1E Bar9.1\FCC ABOVE 1G.EM6

Test Date : 2019-11-24

Tested By : Jacky

EUT : SOUNDBAR

Model Number : BAR 9.1 CNTR

Power Supply : AC 230V/50Hz

Test Mode : Tx mode

Condition : Temp:24.5°C,Humi:55%,Press:100.1kPa

Antenna/Distance : 2019 BBHA 9120 D/3m/HORIZONTAL

Memo : 11B 2412 ANT2 POWER 16

Data: 220

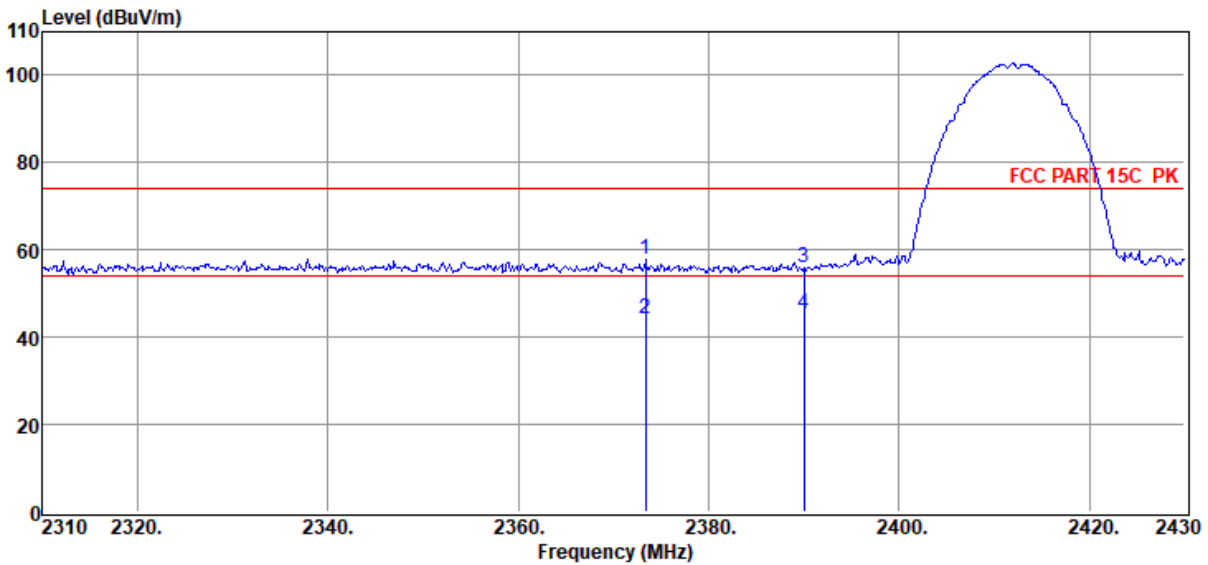

Item (Mark)	Freq. (MHz)	Read Level (dBμV)	Antenna Factor (dB/m)	PRM Factor (dB)	Cable Loss (dB)	Result Level (dBμV/m)	Limit Line (dBμV/m)	Over Limit (dB)	Detector	Polarization
1	2373.36	27.03	27.17	0.00	3.70	57.90	74.00	-16.10	Peak	HORIZONTAL
2	2373.36	13.17	27.17	0.00	3.70	44.04	54.00	-9.96	Average	HORIZONTAL
3	2390.00	25.09	27.23	0.00	3.73	56.05	74.00	-17.95	Peak	HORIZONTAL
4	2390.00	14.54	27.23	0.00	3.73	45.50	54.00	-8.50	Average	HORIZONTAL

Note: 1. Result Level = Read Level + Antenna Factor + Cable loss - PRM Factor.

2. If Peak Result complies with AV limit, AV Result is deemed to comply with AV limit.

3. Test setup: RBW: 1 MHz, VBW: 3 MHz, Sweep time: auto.

TR-4-E-009 Radiated Emission Test Result

Test Site : DDT 3m Chamber 1#

D:\2019 RE1# Report Data\Q19080513-1E Bar9.1\FCC ABOVE 1G.EM6

Test Date : 2019-11-24

Tested By : Jacky

EUT : SOUNDBAR

Model Number : BAR 9.1 CNTR

Power Supply : AC 230V/50Hz

Test Mode : Tx mode

Condition : Temp:24.5°C,Humi:55%,Press:100.1kPa

Antenna/Distance : 2019 BBHA 9120 D/3m/VERTICAL

Memo : 11B 2462 ANT1 POWER 16

Data: 221

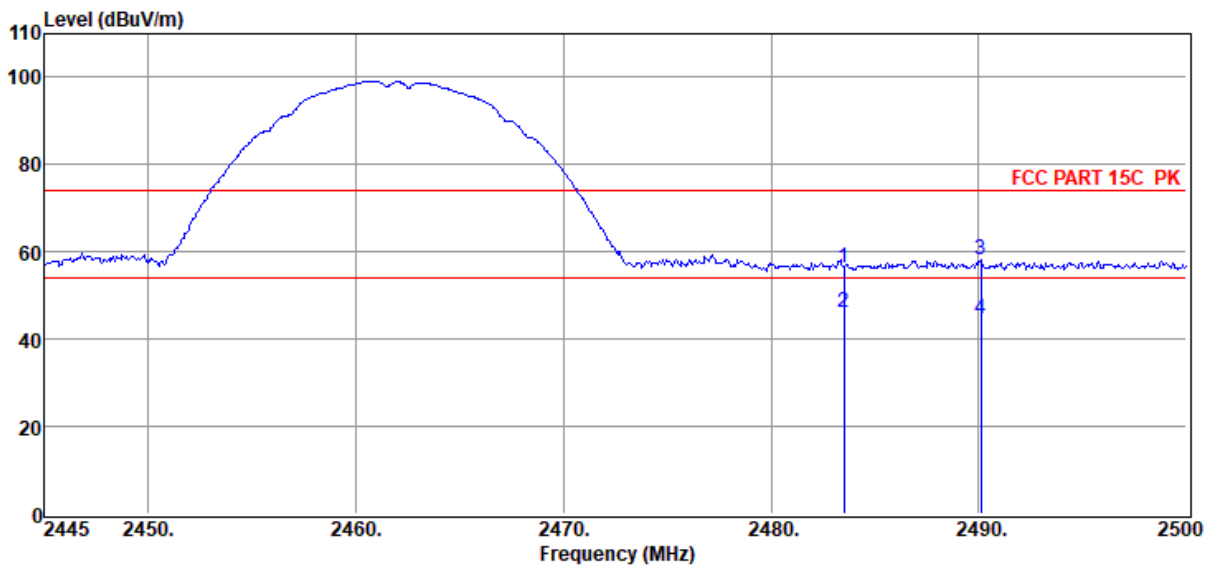

Item (Mark)	Freq. (MHz)	Read Level (dBμV)	Antenna Factor (dB/m)	PRM Factor (dB)	Cable Loss (dB)	Result Level (dBμV/m)	Limit Line (dBμV/m)	Over Limit (dB)	Detector	Polarization
1	2483.50	24.77	27.54	0.00	3.87	56.18	74.00	-17.82	Peak	VERTICAL
2	2483.50	14.57	27.54	0.00	3.87	45.98	54.00	-8.02	Average	VERTICAL
3	2490.10	26.65	27.57	0.00	3.88	58.10	74.00	-15.90	Peak	VERTICAL
4	2490.10	13.23	27.57	0.00	3.88	44.68	54.00	-9.32	Average	VERTICAL

Note: 1. Result Level = Read Level + Antenna Factor + Cable loss - PRM Factor.

2. If Peak Result complies with AV limit, AV Result is deemed to comply with AV limit.

3. Test setup: RBW: 1 MHz, VBW: 3 MHz, Sweep time: auto.

TR-4-E-009 Radiated Emission Test Result

Test Site : DDT 3m Chamber 1#

D:\2019 RE1# Report Data\Q19080513-1E Bar9.1\FCC ABOVE 1G.EM6

Test Date : 2019-11-24

Tested By : Jacky

EUT : SOUNDBAR

Model Number : BAR 9.1 CNTR

Power Supply : AC 230V/50Hz

Test Mode : Tx mode

Condition : Temp:24.5°C,Humi:55%,Press:100.1kPa

Antenna/Distance : 2019 BBHA 9120 D/3m/HORIZONTAL

Memo : 11B 2462 ANT1 POWER 16

Data: 222

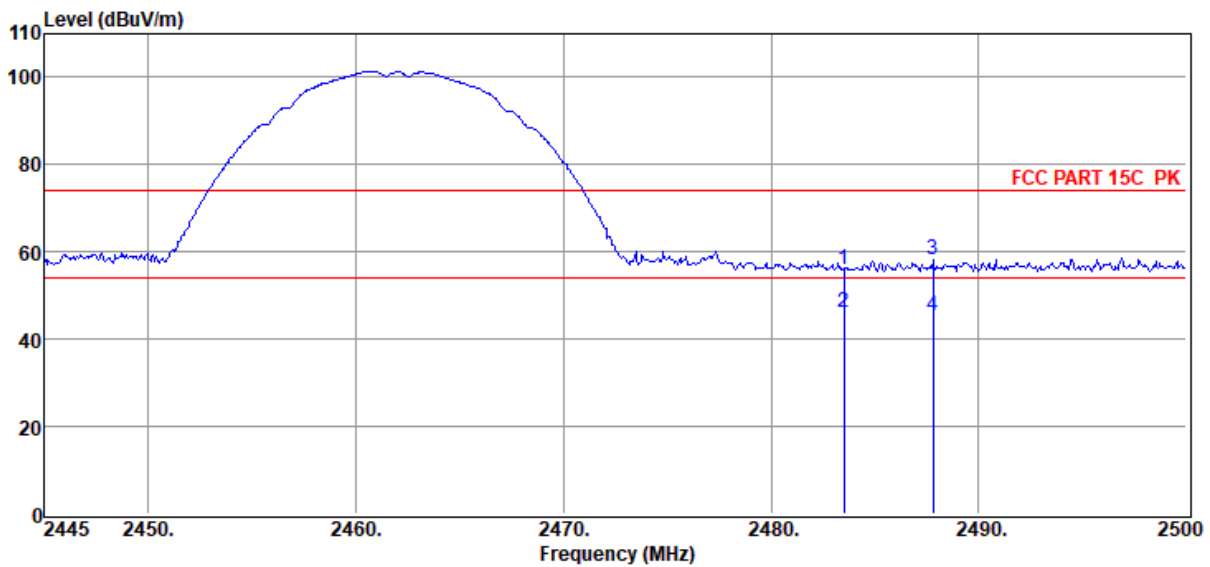

Item (Mark)	Freq. (MHz)	Read Level (dBμV)	Antenna Factor (dB/m)	PRM Factor (dB)	Cable Loss (dB)	Result Level (dBμV/m)	Limit Line (dBμV/m)	Over Limit (dB)	Detector	Polarization
1	2483.50	24.53	27.54	0.00	3.87	55.94	74.00	-18.06	Peak	HORIZONTAL
2	2483.50	14.63	27.54	0.00	3.87	46.04	54.00	-7.96	Average	HORIZONTAL
3	2487.79	26.62	27.56	0.00	3.87	58.05	74.00	-15.95	Peak	HORIZONTAL
4	2487.79	13.82	27.56	0.00	3.87	45.25	54.00	-8.75	Average	HORIZONTAL

Note: 1. Result Level = Read Level + Antenna Factor + Cable loss - PRM Factor.

2. If Peak Result complies with AV limit, AV Result is deemed to comply with AV limit.

3. Test setup: RBW: 1 MHz, VBW: 3 MHz, Sweep time: auto.

TR-4-E-009 Radiated Emission Test Result

Test Site : DDT 3m Chamber 1#

D:\2019 RE1# Report Data\Q19080513-1E Bar9.1\FCC ABOVE 1G.EM6

Test Date : 2019-11-24

Tested By : Jacky

EUT : SOUNDBAR

Model Number : BAR 9.1 CNTR

Power Supply : AC 230V/50Hz

Test Mode : Tx mode

Condition : Temp:24.5°C,Humi:55%,Press:100.1kPa

Antenna/Distance : 2019 BBHA 9120 D/3m/HORIZONTAL

Memo : 11B 2462 ANT2 POWER 16

Data: 223

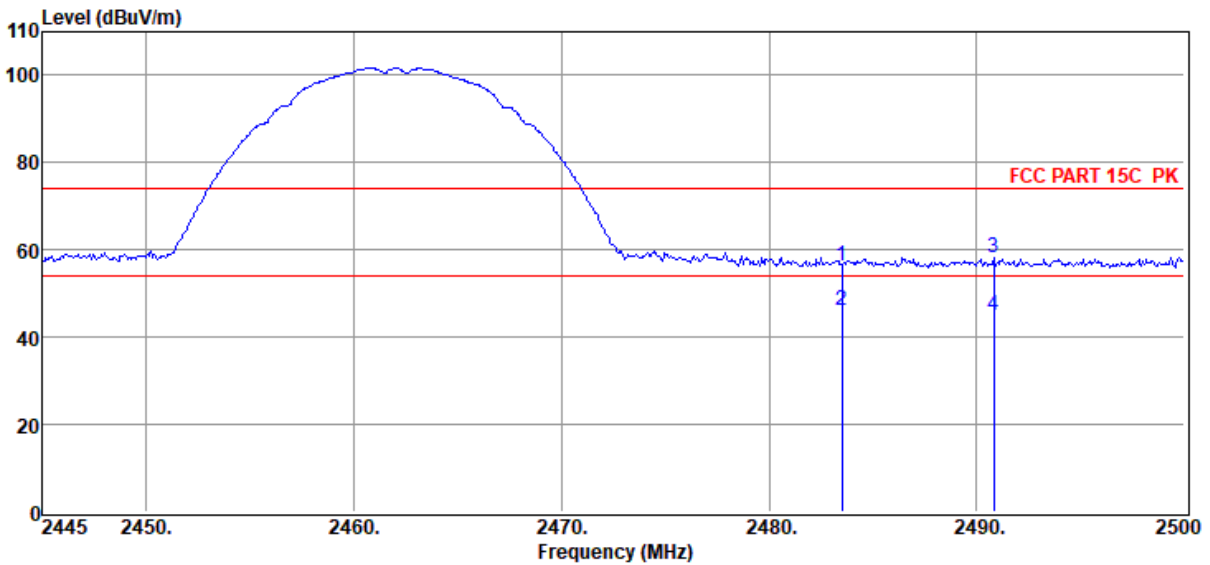

Item (Mark)	Freq. (MHz)	Read Level (dBμV)	Antenna Factor (dB/m)	PRM Factor (dB)	Cable Loss (dB)	Result Level (dBμV/m)	Limit Line (dBμV/m)	Over Limit (dB)	Detector	Polarization
1	2483.50	25.08	27.54	0.00	3.87	56.49	74.00	-17.51	Peak	HORIZONTAL
2	2483.50	14.66	27.54	0.00	3.87	46.07	54.00	-7.93	Average	HORIZONTAL
3	2490.82	26.59	27.57	0.00	3.88	58.04	74.00	-15.96	Peak	HORIZONTAL
4	2490.82	13.47	27.57	0.00	3.88	44.92	54.00	-9.08	Average	HORIZONTAL

Note: 1. Result Level = Read Level + Antenna Factor + Cable loss - PRM Factor.

2. If Peak Result complies with AV limit, AV Result is deemed to comply with AV limit.

3. Test setup: RBW: 1 MHz, VBW: 3 MHz, Sweep time: auto.

TR-4-E-009 Radiated Emission Test Result

Test Site : DDT 3m Chamber 1#

D:\2019 RE1# Report Data\Q19080513-1E Bar9.1\FCC ABOVE 1G.EM6

Test Date : 2019-11-24

Tested By : Jacky

EUT : SOUNDBAR

Model Number : BAR 9.1 CNTR

Power Supply : AC 230V/50Hz

Test Mode : Tx mode

Condition : Temp:24.5°C,Humi:55%,Press:100.1kPa

Antenna/Distance : 2019 BBHA 9120 D/3m/VERTICAL

Memo : 11B 2462 ANT2 POWER 16

Data: 224

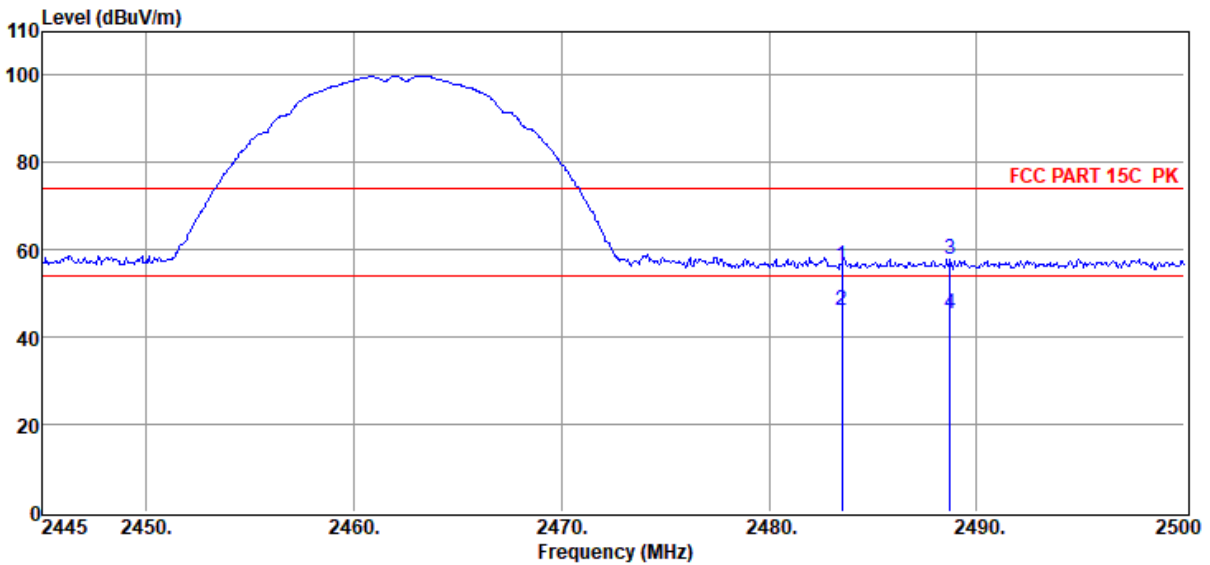

Item (Mark)	Freq. (MHz)	Read Level (dBμV)	Antenna Factor (dB/m)	PRM Factor (dB)	Cable Loss (dB)	Result Level (dBμV/m)	Limit Line (dBμV/m)	Over Limit (dB)	Detector	Polarization
1	2483.50	25.07	27.54	0.00	3.87	56.48	74.00	-17.52	Peak	VERTICAL
2	2483.50	14.77	27.54	0.00	3.87	46.18	54.00	-7.82	Average	VERTICAL
3	2488.73	26.50	27.56	0.00	3.87	57.93	74.00	-16.07	Peak	VERTICAL
4	2488.73	13.84	27.56	0.00	3.87	45.27	54.00	-8.73	Average	VERTICAL

Note: 1. Result Level = Read Level + Antenna Factor + Cable loss - PRM Factor.

2. If Peak Result complies with AV limit, AV Result is deemed to comply with AV limit.

3. Test setup: RBW: 1 MHz, VBW: 3 MHz, Sweep time: auto.

TR-4-E-009 Radiated Emission Test Result

Test Site : DDT 3m Chamber 1#

D:\2019 RE1# Report Data\Q19080513-1E Bar9.1\FCC ABOVE 1G.EM6

Test Date : 2019-11-19

Tested By : Jacky

EUT : SOUNDBAR

Model Number : BAR 9.1 CNTR

Power Supply : AC 230V/50Hz

Test Mode : Tx mode

Condition : Temp:24.5°C,Humi:55%,Press:100.1kPa

Antenna/Distance : 2019 BBHA 9120 D/3m/HORIZONTAL

Memo : 11G 2462 ANT1 POWER 16

Data: 225

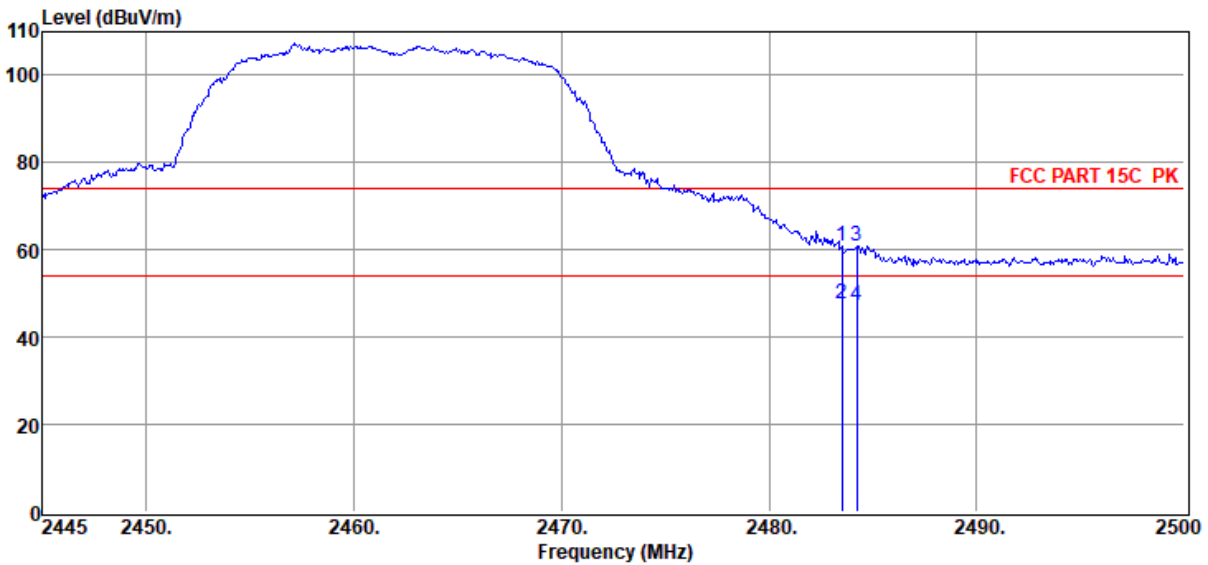

Item (Mark)	Freq. (MHz)	Read Level (dBμV)	Antenna Factor (dB/m)	PRM Factor (dB)	Cable Loss (dB)	Result Level (dBμV/m)	Limit Line (dBμV/m)	Over Limit (dB)	Detector	Polarization
1	2483.50	29.56	27.54	0.00	3.87	60.97	74.00	-13.03	Peak	HORIZONTAL
2	2483.50	16.20	27.54	0.00	3.87	47.61	54.00	-6.39	Average	HORIZONTAL
3	2484.22	29.51	27.55	0.00	3.87	60.93	74.00	-13.07	Peak	HORIZONTAL
4	2484.22	15.73	27.55	0.00	3.87	47.15	54.00	-6.85	Average	HORIZONTAL

Note: 1. Result Level = Read Level + Antenna Factor + Cable loss - PRM Factor.

2. If Peak Result complies with AV limit, AV Result is deemed to comply with AV limit.

3. Test setup: RBW: 1 MHz, VBW: 3 MHz, Sweep time: auto.

TR-4-E-009 Radiated Emission Test Result

Test Site : DDT 3m Chamber 1#

D:\2019 RE1# Report Data\Q19080513-1E Bar9.1\FCC ABOVE 1G.EM6

Test Date : 2019-11-19

Tested By : Jacky

EUT : SOUNDBAR

Model Number : BAR 9.1 CNTR

Power Supply : AC 230V/50Hz

Test Mode : Tx mode

Condition : Temp:24.5°C,Humi:55%,Press:100.1kPa

Antenna/Distance : 2019 BBHA 9120 D/3m/VERTICAL

Memo : 11G 2462 ANT1 POWER 16

Data: 226

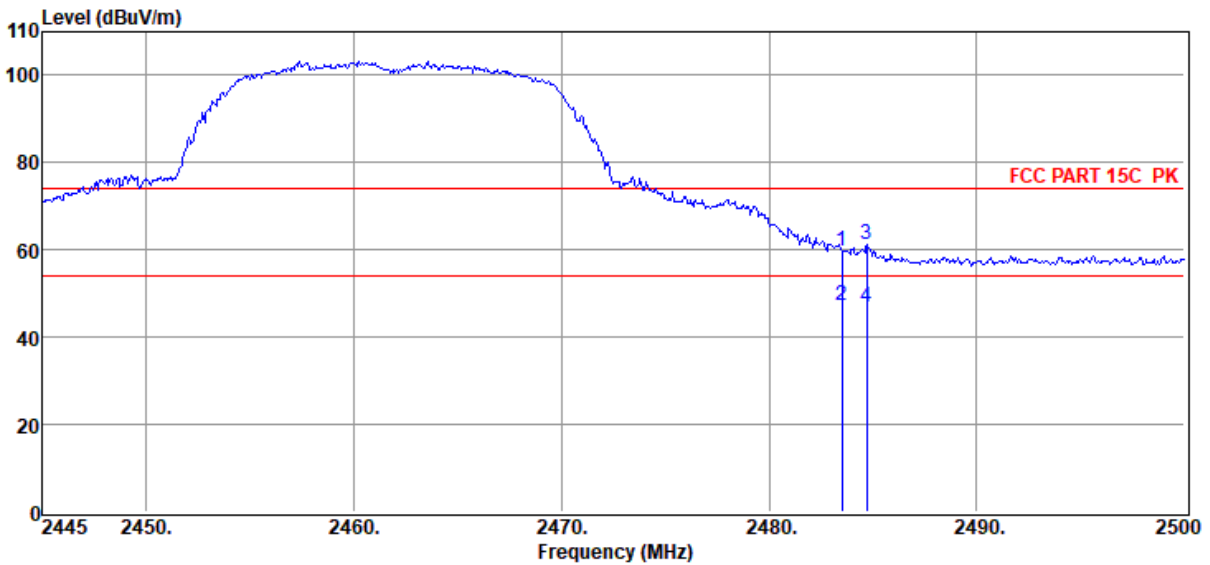

Item (Mark)	Freq. (MHz)	Read Level (dBμV)	Antenna Factor (dB/m)	PRM Factor (dB)	Cable Loss (dB)	Result Level (dBμV/m)	Limit Line (dBμV/m)	Over Limit (dB)	Detector	Polarization
1	2483.50	28.37	27.54	0.00	3.87	59.78	74.00	-14.22	Peak	VERTICAL
2	2483.50	15.83	27.54	0.00	3.87	47.24	54.00	-6.76	Average	VERTICAL
3	2484.71	29.71	27.55	0.00	3.87	61.13	74.00	-12.87	Peak	VERTICAL
4	2484.71	15.37	27.55	0.00	3.87	46.79	54.00	-7.21	Average	VERTICAL

Note: 1. Result Level = Read Level + Antenna Factor + Cable loss - PRM Factor.

2. If Peak Result complies with AV limit, AV Result is deemed to comply with AV limit.

3. Test setup: RBW: 1 MHz, VBW: 3 MHz, Sweep time: auto.

TR-4-E-009 Radiated Emission Test Result

Test Site : DDT 3m Chamber 1#

D:\2019 RE1# Report Data\Q19080513-1E Bar9.1\FCC ABOVE 1G.EM6

Test Date : 2019-11-19

Tested By : Jacky

EUT : SOUNDBAR

Model Number : BAR 9.1 CNTR

Power Supply : AC 230V/50Hz

Test Mode : Tx mode

Condition : Temp:24.5°C,Humi:55%,Press:100.1kPa

Antenna/Distance : 2019 BBHA 9120 D/3m/VERTICAL

Memo : 11G 2462 ANT2 POWER 16

Data: 227

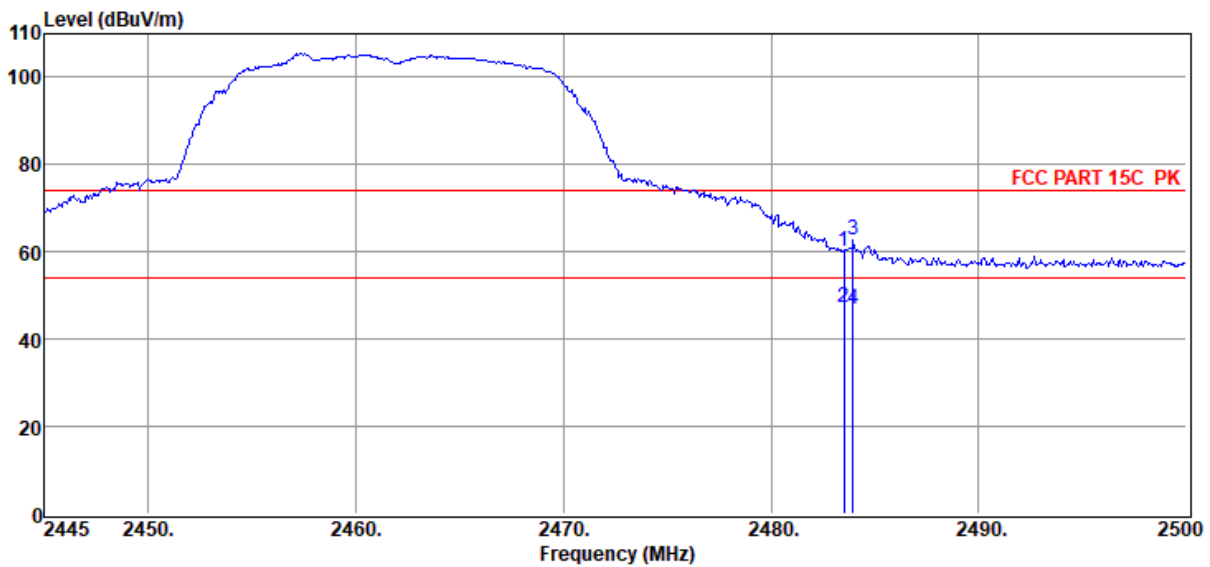

Item (Mark)	Freq. (MHz)	Read Level (dBμV)	Antenna Factor (dB/m)	PRM Factor (dB)	Cable Loss (dB)	Result Level (dBμV/m)	Limit Line (dBμV/m)	Over Limit (dB)	Detector	Polarization
1	2483.50	28.79	27.54	0.00	3.87	60.20	74.00	-13.80	Peak	VERTICAL
2	2483.50	15.80	27.54	0.00	3.87	47.21	54.00	-6.79	Average	VERTICAL
3	2483.94	31.22	27.55	0.00	3.87	62.64	74.00	-11.36	Peak	VERTICAL
4	2483.94	15.40	27.55	0.00	3.87	46.82	54.00	-7.18	Average	VERTICAL

Note: 1. Result Level = Read Level + Antenna Factor + Cable loss - PRM Factor.

2. If Peak Result complies with AV limit, AV Result is deemed to comply with AV limit.

3. Test setup: RBW: 1 MHz, VBW: 3 MHz, Sweep time: auto.

TR-4-E-009 Radiated Emission Test Result

Test Site : DDT 3m Chamber 1#

D:\2019 RE1# Report Data\Q19080513-1E Bar9.1\FCC ABOVE 1G.EM6

Test Date : 2019-11-19

Tested By : Jacky

EUT : SOUNDBAR

Model Number : BAR 9.1 CNTR

Power Supply : AC 230V/50Hz

Test Mode : Tx mode

Condition : Temp:24.5°C,Humi:55%,Press:100.1kPa

Antenna/Distance : 2019 BBHA 9120 D/3m/HORIZONTAL

Memo : 11G 2462 ANT2 POWER 16

Data: 228

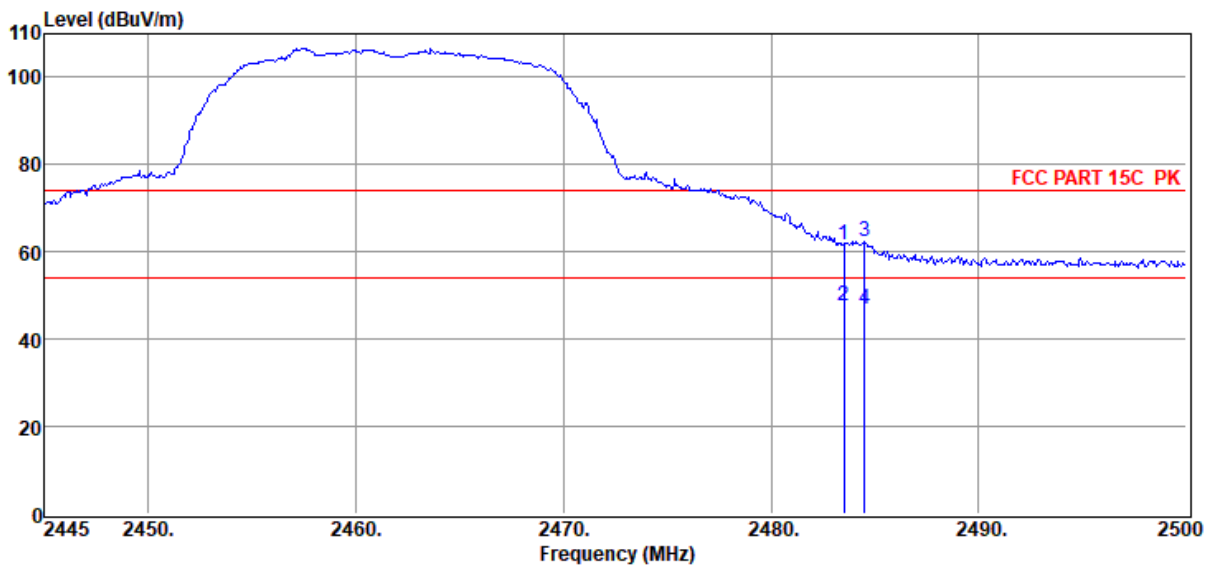

Item (Mark)	Freq. (MHz)	Read Level (dBμV)	Antenna Factor (dB/m)	PRM Factor (dB)	Cable Loss (dB)	Result Level (dBμV/m)	Limit Line (dBμV/m)	Over Limit (dB)	Detector	Polarization
1	2483.50	30.39	27.54	0.00	3.87	61.80	74.00	-12.20	Peak	HORIZONTAL
2	2483.50	16.27	27.54	0.00	3.87	47.68	54.00	-6.32	Average	HORIZONTAL
3	2484.49	30.95	27.55	0.00	3.87	62.37	74.00	-11.63	Peak	HORIZONTAL
4	2484.49	15.61	27.55	0.00	3.87	47.03	54.00	-6.97	Average	HORIZONTAL

Note: 1. Result Level = Read Level + Antenna Factor + Cable loss - PRM Factor.

2. If Peak Result complies with AV limit, AV Result is deemed to comply with AV limit.

3. Test setup: RBW: 1 MHz, VBW: 3 MHz, Sweep time: auto.

TR-4-E-009 Radiated Emission Test Result

Test Site : DDT 3m Chamber 1#

D:\2019 RE1# Report Data\Q19080513-1E Bar9.1\FCC ABOVE 1G.EM6

Test Date : 2019-11-20

Tested By : Jacky

EUT : SOUNDBAR

Model Number : BAR 9.1 CNTR

Power Supply : AC 230V/50Hz

Test Mode : Tx mode

Condition : Temp:24.5°C,Humi:55%,Press:100.1kPa

Antenna/Distance : 2019 BBHA 9120 D/3m/VERTICAL

Memo : 11G 2412 ANT1 POWER 16

Data: 229

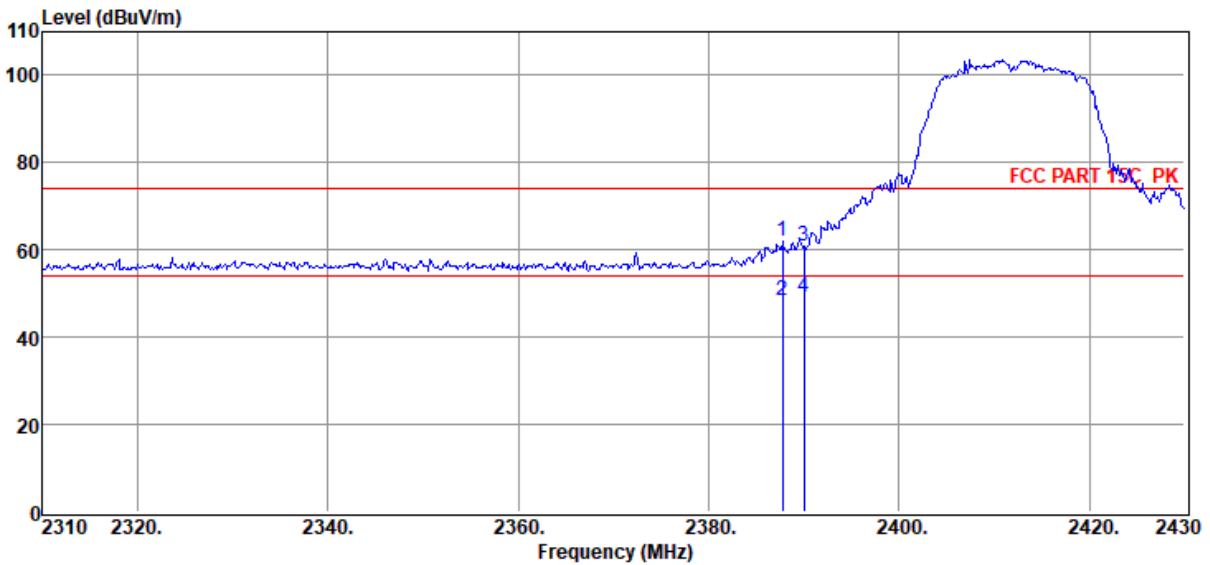

Item (Mark)	Freq. (MHz)	Read Level (dBμV)	Antenna Factor (dB/m)	PRM Factor (dB)	Cable Loss (dB)	Result Level (dBμV/m)	Limit Line (dBμV/m)	Over Limit (dB)	Detector	Polarization
1	2387.76	31.21	27.22	0.00	3.72	62.15	74.00	-11.85	Peak	VERTICAL
2	2387.76	17.33	27.22	0.00	3.72	48.27	54.00	-5.73	Average	VERTICAL
3	2390.00	29.77	27.23	0.00	3.73	60.73	74.00	-13.27	Peak	VERTICAL
4	2390.00	18.09	27.23	0.00	3.73	49.05	54.00	-4.95	Average	VERTICAL

Note: 1. Result Level = Read Level + Antenna Factor + Cable loss - PRM Factor.

2. If Peak Result complies with AV limit, AV Result is deemed to comply with AV limit.

3. Test setup: RBW: 1 MHz, VBW: 3 MHz, Sweep time: auto.

TR-4-E-009 Radiated Emission Test Result

Test Site : DDT 3m Chamber 1#

D:\2019 RE1# Report Data\Q19080513-1E Bar9.1\FCC ABOVE 1G.EM6

Test Date : 2019-11-20

Tested By : Jacky

EUT : SOUNDBAR

Model Number : BAR 9.1 CNTR

Power Supply : AC 230V/50Hz

Test Mode : Tx mode

Condition : Temp:24.5°C,Humi:55%,Press:100.1kPa

Antenna/Distance : 2019 BBHA 9120 D/3m/HORIZONTAL

Memo : 11G 2412 ANT1 POWER 16

Data: 230

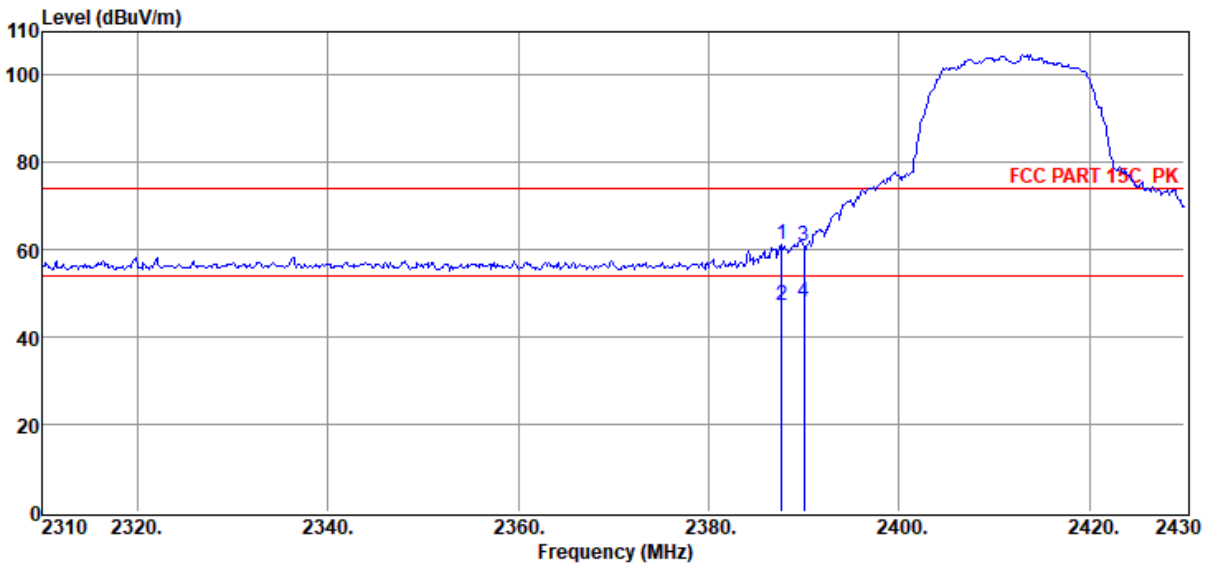

Item (Mark)	Freq. (MHz)	Read Level (dBμV)	Antenna Factor (dB/m)	PRM Factor (dB)	Cable Loss (dB)	Result Level (dBμV/m)	Limit Line (dBμV/m)	Over Limit (dB)	Detector	Polarization
1	2387.64	30.26	27.22	0.00	3.72	61.20	74.00	-12.80	Peak	HORIZONTAL
2	2387.64	16.38	27.22	0.00	3.72	47.32	54.00	-6.68	Average	HORIZONTAL
3	2390.00	29.93	27.23	0.00	3.73	60.89	74.00	-13.11	Peak	HORIZONTAL
4	2390.00	16.99	27.23	0.00	3.73	47.95	54.00	-6.05	Average	HORIZONTAL

Note: 1. Result Level = Read Level + Antenna Factor + Cable loss - PRM Factor.

2. If Peak Result complies with AV limit, AV Result is deemed to comply with AV limit.

3. Test setup: RBW: 1 MHz, VBW: 3 MHz, Sweep time: auto.

TR-4-E-009 Radiated Emission Test Result

Test Site : DDT 3m Chamber 1#

D:\2019 RE1# Report Data\Q19080513-1E Bar9.1\FCC ABOVE 1G.EM6

Test Date : 2019-11-20

Tested By : Jacky

EUT : SOUNDBAR

Model Number : BAR 9.1 CNTR

Power Supply : AC 230V/50Hz

Test Mode : Tx mode

Condition : Temp:24.5°C,Humi:55%,Press:100.1kPa

Antenna/Distance : 2019 BBHA 9120 D/3m/HORIZONTAL

Memo : 11G 2412 ANT2 POWER 16

Data: 231

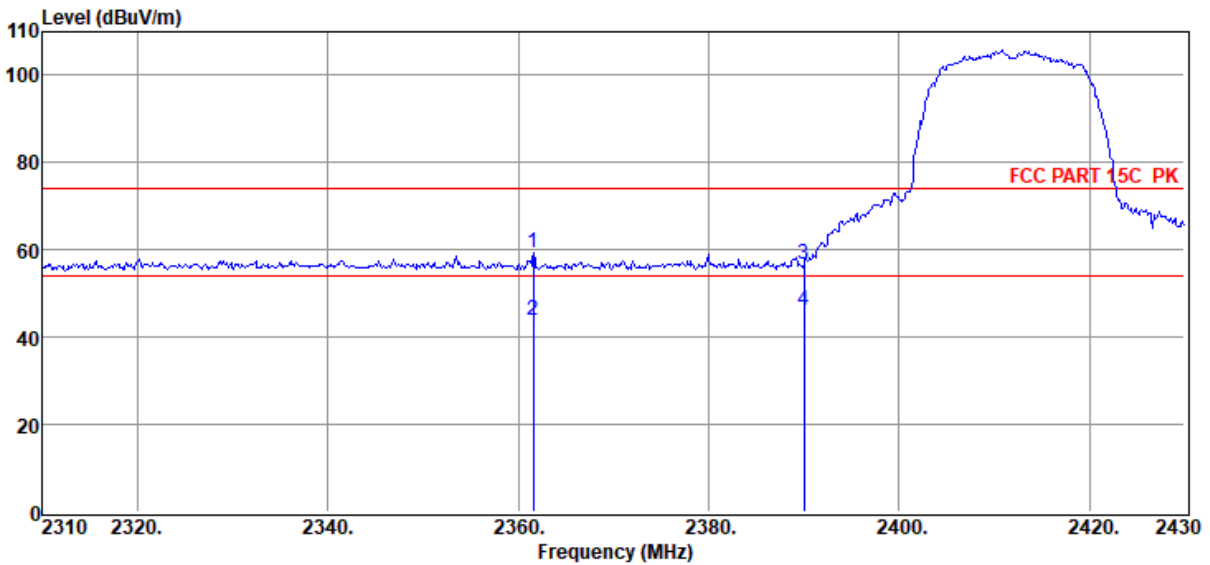

Item (Mark)	Freq. (MHz)	Read Level (dBμV)	Antenna Factor (dB/m)	PRM Factor (dB)	Cable Loss (dB)	Result Level (dBμV/m)	Limit Line (dBμV/m)	Over Limit (dB)	Detector	Polarization
1	2361.60	28.51	27.13	0.00	3.68	59.32	74.00	-14.68	Peak	HORIZONTAL
2	2361.60	13.21	27.13	0.00	3.68	44.02	54.00	-9.98	Average	HORIZONTAL
3	2390.00	25.87	27.23	0.00	3.73	56.83	74.00	-17.17	Peak	HORIZONTAL
4	2390.00	14.99	27.23	0.00	3.73	45.95	54.00	-8.05	Average	HORIZONTAL

Note: 1. Result Level = Read Level + Antenna Factor + Cable loss - PRM Factor.

2. If Peak Result complies with AV limit, AV Result is deemed to comply with AV limit.

3. Test setup: RBW: 1 MHz, VBW: 3 MHz, Sweep time: auto.

TR-4-E-009 Radiated Emission Test Result

Test Site : DDT 3m Chamber 1#

D:\2019 RE1# Report Data\Q19080513-1E Bar9.1\FCC ABOVE 1G.EM6

Test Date : 2019-11-20

Tested By : Jacky

EUT : SOUNDBAR

Model Number : BAR 9.1 CNTR

Power Supply : AC 230V/50Hz

Test Mode : Tx mode

Condition : Temp:24.5°C,Humi:55%,Press:100.1kPa

Antenna/Distance : 2019 BBHA 9120 D/3m/VERTICAL

Memo : 11G 2412 ANT2 POWER 16

Data: 232

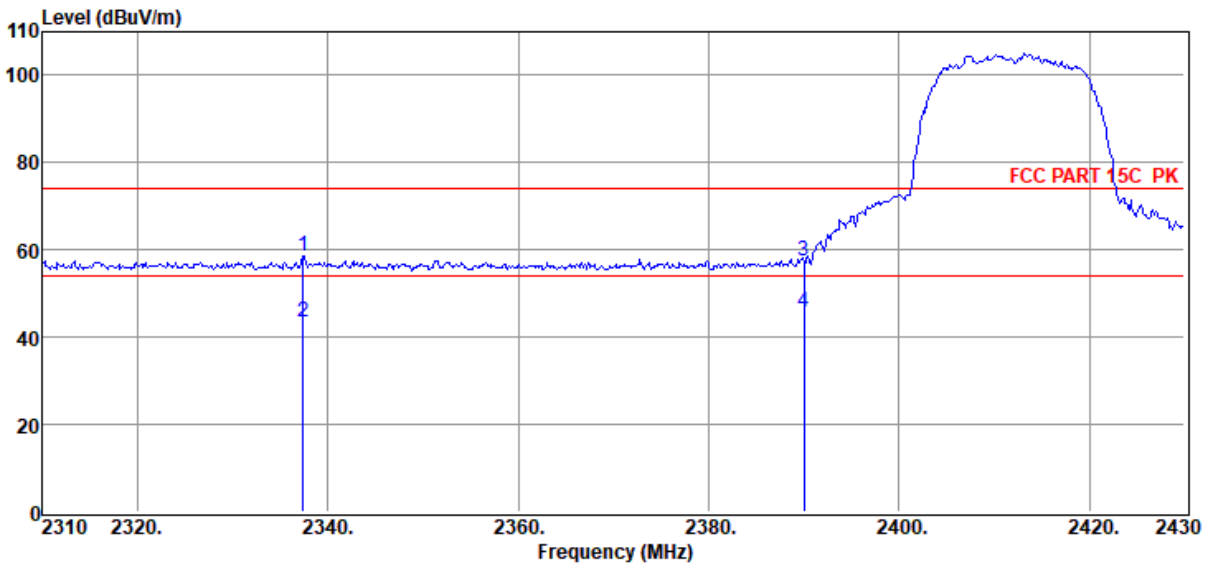

Item (Mark)	Freq. (MHz)	Read Level (dBμV)	Antenna Factor (dB/m)	PRM Factor (dB)	Cable Loss (dB)	Result Level (dBμV/m)	Limit Line (dBμV/m)	Over Limit (dB)	Detector	Polarization
1	2337.36	27.93	27.05	0.00	3.65	58.63	74.00	-15.37	Peak	VERTICAL
2	2337.36	12.84	27.05	0.00	3.65	43.54	54.00	-10.46	Average	VERTICAL
3	2390.04	26.43	27.23	0.00	3.73	57.39	74.00	-16.61	Peak	VERTICAL
4	2390.04	14.72	27.23	0.00	3.73	45.68	54.00	-8.32	Average	VERTICAL

Note: 1. Result Level = Read Level + Antenna Factor + Cable loss - PRM Factor.

2. If Peak Result complies with AV limit, AV Result is deemed to comply with AV limit.

3. Test setup: RBW: 1 MHz, VBW: 3 MHz, Sweep time: auto.

TR-4-E-009 Radiated Emission Test Result

Test Site : DDT 3m Chamber 1#

D:\2019 RE1# Report Data\Q19080513-1E Bar9.1\FCC ABOVE 1G.EM6

Test Date : 2019-11-20

Tested By : Jacky

EUT : SOUNDBAR

Model Number : BAR 9.1 CNTR

Power Supply : AC 230V/50Hz

Test Mode : Tx mode

Condition : Temp:24.5°C,Humi:55%,Press:100.1kPa

Antenna/Distance : 2019 BBHA 9120 D/3m/VERTICAL

Memo : 11N20 2412 POWER 15

Data: 233

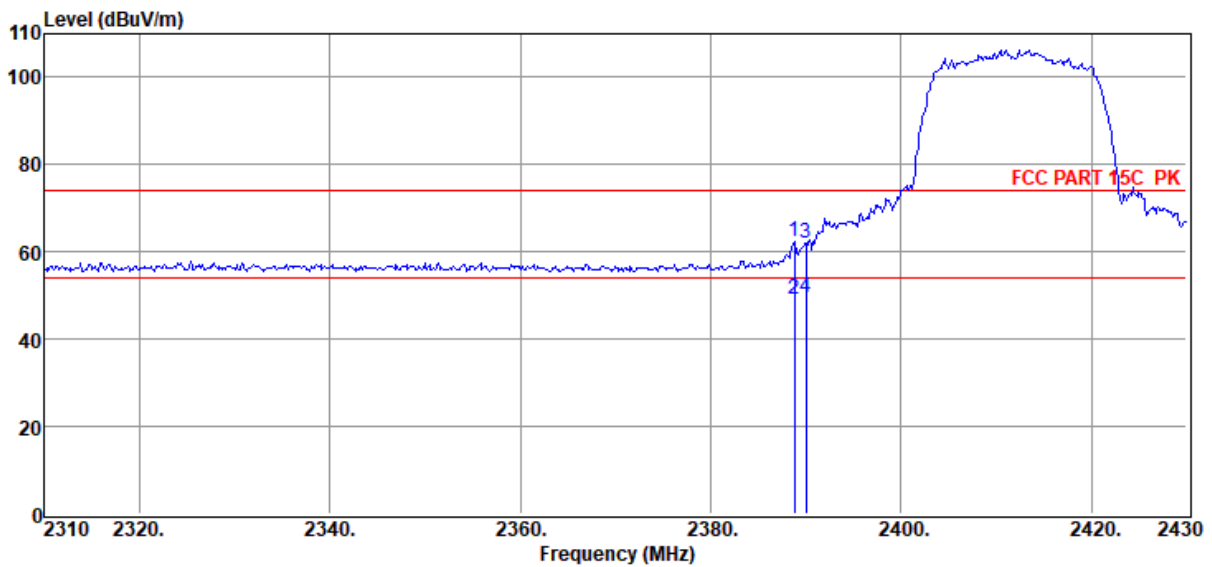

Item (Mark)	Freq. (MHz)	Read Level (dBμV)	Antenna Factor (dB/m)	PRM Factor (dB)	Cable Loss (dB)	Result Level (dBμV/m)	Limit Line (dBμV/m)	Over Limit (dB)	Detector	Polarization
1	2388.84	31.32	27.22	0.00	3.72	62.26	74.00	-11.74	Peak	VERTICAL
2	2388.84	18.13	27.22	0.00	3.72	49.07	54.00	-4.93	Average	VERTICAL
3	2390.00	31.09	27.23	0.00	3.73	62.05	74.00	-11.95	Peak	VERTICAL
4	2390.00	18.63	27.23	0.00	3.73	49.59	54.00	-4.41	Average	VERTICAL

Note: 1. Result Level = Read Level + Antenna Factor + Cable loss - PRM Factor.

2. If Peak Result complies with AV limit, AV Result is deemed to comply with AV limit.

3. Test setup: RBW: 1 MHz, VBW: 3 MHz, Sweep time: auto.

TR-4-E-009 Radiated Emission Test Result

Test Site : DDT 3m Chamber 1#

D:\2019 RE1# Report Data\Q19080513-1E Bar9.1\FCC ABOVE 1G.EM6

Test Date : 2019-11-20

Tested By : Jacky

EUT : SOUNDBAR

Model Number : BAR 9.1 CNTR

Power Supply : AC 230V/50Hz

Test Mode : Tx mode

Condition : Temp:24.5°C,Humi:55%,Press:100.1kPa

Antenna/Distance : 2019 BBHA 9120 D/3m/HORIZONTAL

Memo : 11N20 2412 POWER 15

Data: 234

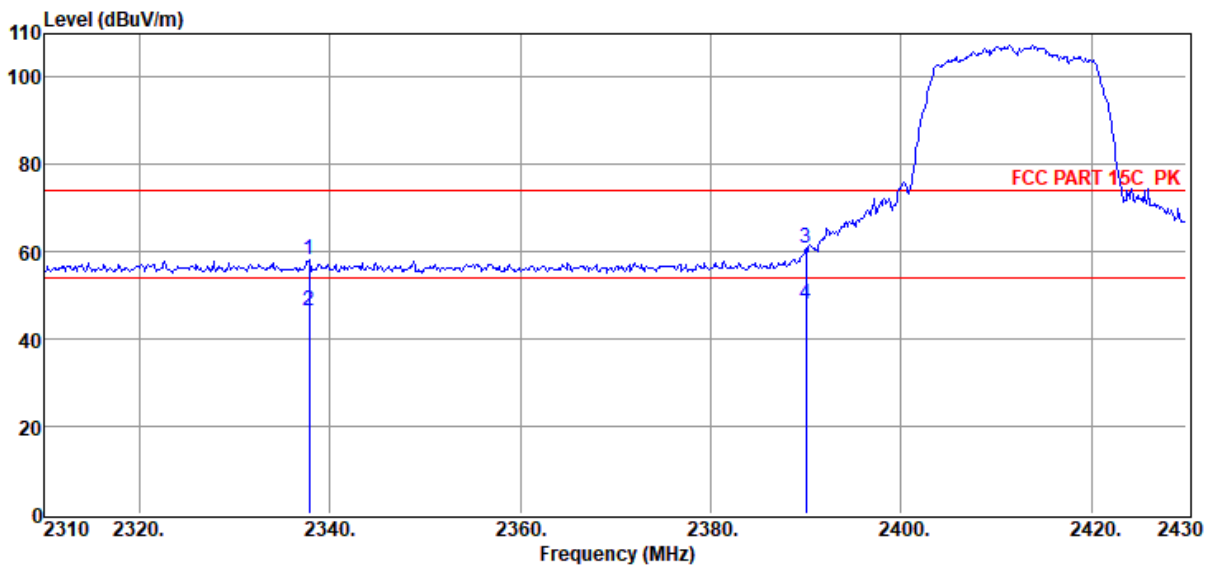

Item (Mark)	Freq. (MHz)	Read Level (dBμV)	Antenna Factor (dB/m)	PRM Factor (dB)	Cable Loss (dB)	Result Level (dBμV/m)	Limit Line (dBμV/m)	Over Limit (dB)	Detector	Polarization
1	2337.84	27.49	27.05	0.00	3.65	58.19	74.00	-15.81	Peak	HORIZONTAL
2	2337.84	15.87	27.05	0.00	3.65	46.57	54.00	-7.43	Average	HORIZONTAL
3	2390.00	29.92	27.23	0.00	3.73	60.88	74.00	-13.12	Peak	HORIZONTAL
4	2390.00	17.19	27.23	0.00	3.73	48.15	54.00	-5.85	Average	HORIZONTAL

Note: 1. Result Level = Read Level + Antenna Factor + Cable loss - PRM Factor.

2. If Peak Result complies with AV limit, AV Result is deemed to comply with AV limit.

3. Test setup: RBW: 1 MHz, VBW: 3 MHz, Sweep time: auto.

TR-4-E-009 Radiated Emission Test Result

Test Site : DDT 3m Chamber 1#

D:\2019 RE1# Report Data\Q19080513-1E Bar9.1\FCC ABOVE 1G.EM6

Test Date : 2019-11-19

Tested By : Jacky

EUT : SOUNDBAR

Model Number : BAR 9.1 CNTR

Power Supply : AC 230V/50Hz

Test Mode : Tx mode

Condition : Temp:24.5°C,Humi:55%,Press:100.1kPa

Antenna/Distance : 2019 BBHA 9120 D/3m/HORIZONTAL

Memo : 11N20 2462 POWER 15

Data: 235

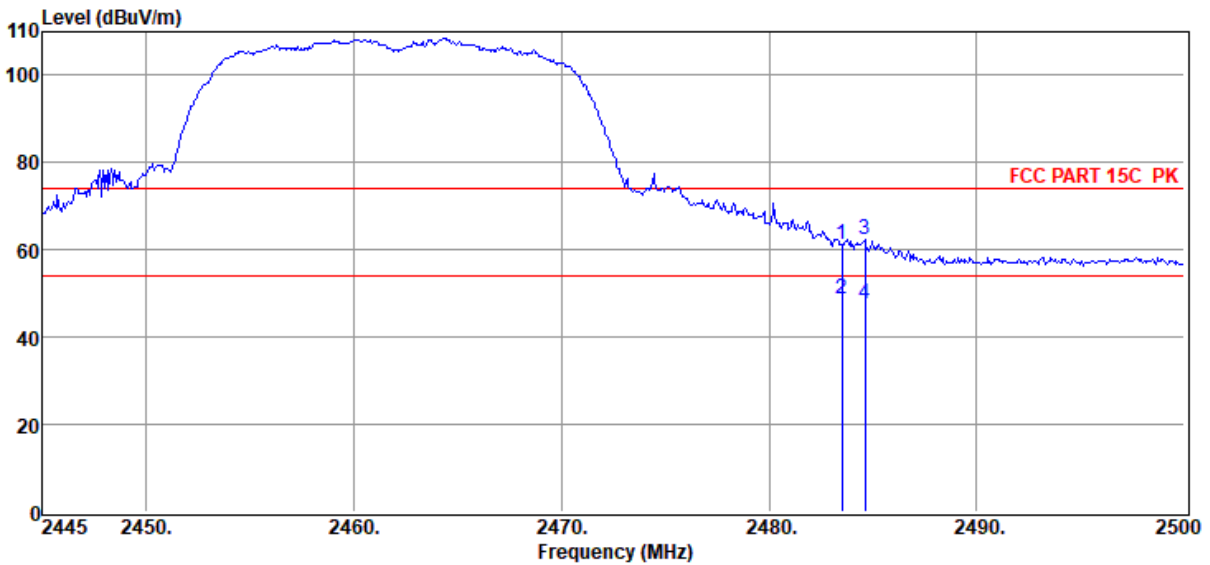

Item (Mark)	Freq. (MHz)	Read Level (dBμV)	Antenna Factor (dB/m)	PRM Factor (dB)	Cable Loss (dB)	Result Level (dBμV/m)	Limit Line (dBμV/m)	Over Limit (dB)	Detector	Polarization
1	2483.50	29.94	27.54	0.00	3.87	61.35	74.00	-12.65	Peak	HORIZONTAL
2	2483.50	17.24	27.54	0.00	3.87	48.65	54.00	-5.35	Average	HORIZONTAL
3	2484.60	30.78	27.55	0.00	3.87	62.20	74.00	-11.80	Peak	HORIZONTAL
4	2484.60	16.23	27.55	0.00	3.87	47.65	54.00	-6.35	Average	HORIZONTAL

Note: 1. Result Level = Read Level + Antenna Factor + Cable loss - PRM Factor.

2. If Peak Result complies with AV limit, AV Result is deemed to comply with AV limit.

3. Test setup: RBW: 1 MHz, VBW: 3 MHz, Sweep time: auto.

TR-4-E-009 Radiated Emission Test Result

Test Site : DDT 3m Chamber 1#

D:\2019 RE1# Report Data\Q19080513-1E Bar9.1\FCC ABOVE 1G.EM6

Test Date : 2019-11-19

Tested By : Jacky

EUT : SOUNDBAR

Model Number : BAR 9.1 CNTR

Power Supply : AC 230V/50Hz

Test Mode : Tx mode

Condition : Temp:24.5°C,Humi:55%,Press:100.1kPa

Antenna/Distance : 2019 BBHA 9120 D/3m/VERTICAL

Memo : 11N20 2462 POWER 15

Data: 236

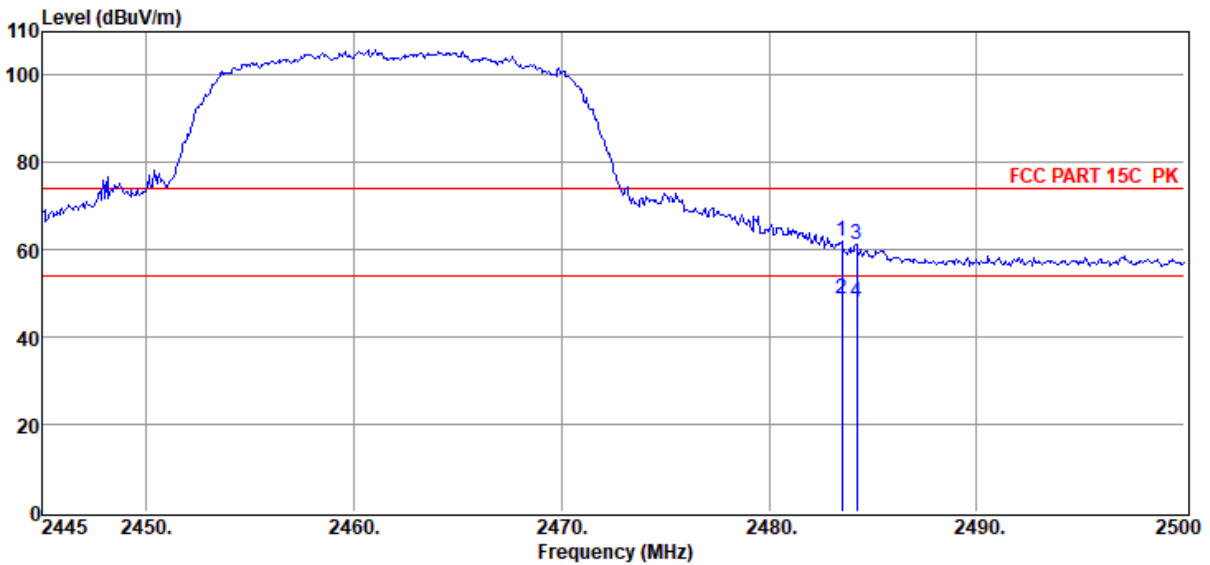

Item (Mark)	Freq. (MHz)	Read Level (dBμV)	Antenna Factor (dB/m)	PRM Factor (dB)	Cable Loss (dB)	Result Level (dBμV/m)	Limit Line (dBμV/m)	Over Limit (dB)	Detector	Polarization
1	2483.50	30.57	27.54	0.00	3.87	61.98	74.00	-12.02	Peak	VERTICAL
2	2483.50	17.50	27.54	0.00	3.87	48.91	54.00	-5.09	Average	VERTICAL
3	2484.22	29.85	27.55	0.00	3.87	61.27	74.00	-12.73	Peak	VERTICAL
4	2484.22	16.61	27.55	0.00	3.87	48.03	54.00	-5.97	Average	VERTICAL

Note: 1. Result Level = Read Level + Antenna Factor + Cable loss - PRM Factor.

2. If Peak Result complies with AV limit, AV Result is deemed to comply with AV limit.

3. Test setup: RBW: 1 MHz, VBW: 3 MHz, Sweep time: auto.

TR-4-E-009 Radiated Emission Test Result

Test Site : DDT 3m Chamber 1#

D:\2019 RE1# Report Data\Q19080513-1E Bar9.1\FCC ABOVE 1G.EM6

Test Date : 2019-11-19

Tested By : Jacky

EUT : SOUNDBAR

Model Number : BAR 9.1 CNTR

Power Supply : AC 230V/50Hz

Test Mode : Tx mode

Condition : Temp:24.5°C,Humi:55%,Press:100.1kPa

Antenna/Distance : 2019 BBHA 9120 D/3m/HORIZONTAL

Memo : 11N40 2422 POWER 14

Data: 237

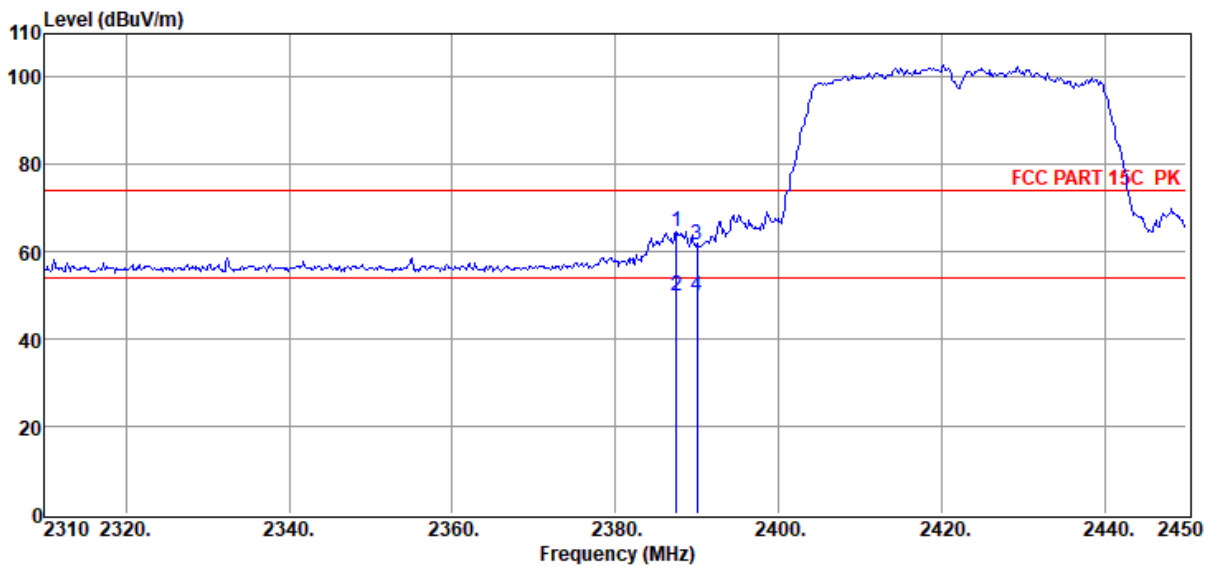

Item (Mark)	Freq. (MHz)	Read Level (dBμV)	Antenna Factor (dB/m)	PRM Factor (dB)	Cable Loss (dB)	Result Level (dBμV/m)	Limit Line (dBμV/m)	Over Limit (dB)	Detector	Polarization
1	2387.42	33.74	27.22	0.00	3.72	64.68	74.00	-9.32	Peak	HORIZONTAL
2	2387.42	18.89	27.22	0.00	3.72	49.83	54.00	-4.17	Average	HORIZONTAL
3	2390.00	30.74	27.23	0.00	3.73	61.70	74.00	-12.30	Peak	HORIZONTAL
4	2390.00	19.11	27.23	0.00	3.73	50.07	54.00	-3.93	Average	HORIZONTAL

Note: 1. Result Level = Read Level + Antenna Factor + Cable loss - PRM Factor.

2. If Peak Result complies with AV limit, AV Result is deemed to comply with AV limit.

3. Test setup: RBW: 1 MHz, VBW: 3 MHz, Sweep time: auto.

TR-4-E-009 Radiated Emission Test Result

Test Site : DDT 3m Chamber 1#

D:\2019 RE1# Report Data\Q19080513-1E Bar9.1\FCC ABOVE 1G.EM6

Test Date : 2019-11-20

Tested By : Jacky

EUT : SOUNDBAR

Model Number : BAR 9.1 CNTR

Power Supply : AC 230V/50Hz

Test Mode : Tx mode

Condition : Temp:24.5°C,Humi:55%,Press:100.1kPa

Antenna/Distance : 2019 BBHA 9120 D/3m/VERTICAL

Memo : 11N40 2422 POWER 14

Data: 238

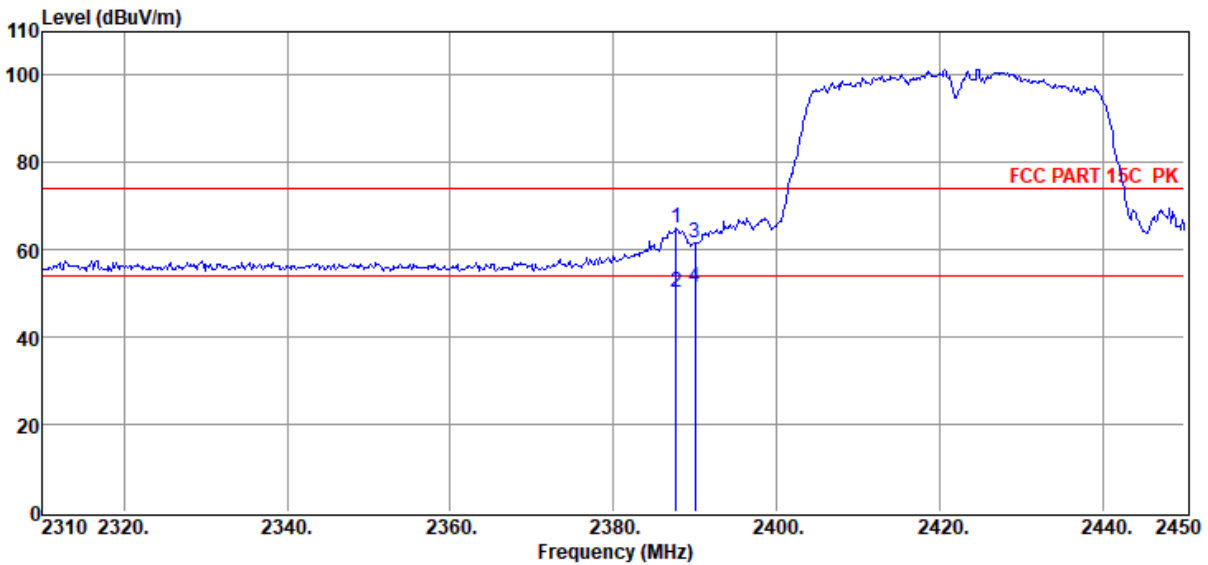

Item (Mark)	Freq. (MHz)	Read Level (dBμV)	Antenna Factor (dB/m)	PRM Factor (dB)	Cable Loss (dB)	Result Level (dBμV/m)	Limit Line (dBμV/m)	Over Limit (dB)	Detector	Polarization
1	2387.70	34.15	27.22	0.00	3.72	65.09	74.00	-8.91	Peak	VERTICAL
2	2387.70	19.44	27.22	0.00	3.72	50.38	54.00	-3.62	Average	VERTICAL
3	2390.00	30.58	27.23	0.00	3.73	61.54	74.00	-12.46	Peak	VERTICAL
4	2390.00	20.62	27.23	0.00	3.73	51.58	54.00	-2.42	Average	VERTICAL

Note: 1. Result Level = Read Level + Antenna Factor + Cable loss - PRM Factor.

2. If Peak Result complies with AV limit, AV Result is deemed to comply with AV limit.

3. Test setup: RBW: 1 MHz, VBW: 3 MHz, Sweep time: auto.

TR-4-E-009 Radiated Emission Test Result

Test Site : DDT 3m Chamber 1#

D:\2019 RE1# Report Data\Q19080513-1E Bar9.1\FCC ABOVE 1G.EM6

Test Date : 2019-11-19

Tested By : Jacky

EUT : SOUNDBAR

Model Number : BAR 9.1 CNTR

Power Supply : AC 230V/50Hz

Test Mode : Tx mode

Condition : Temp:24.5°C,Humi:55%,Press:100.1kPa

Antenna/Distance : 2019 BBHA 9120 D/3m/VERTICAL

Memo : 11N40 2452 POWER 14

Data: 239

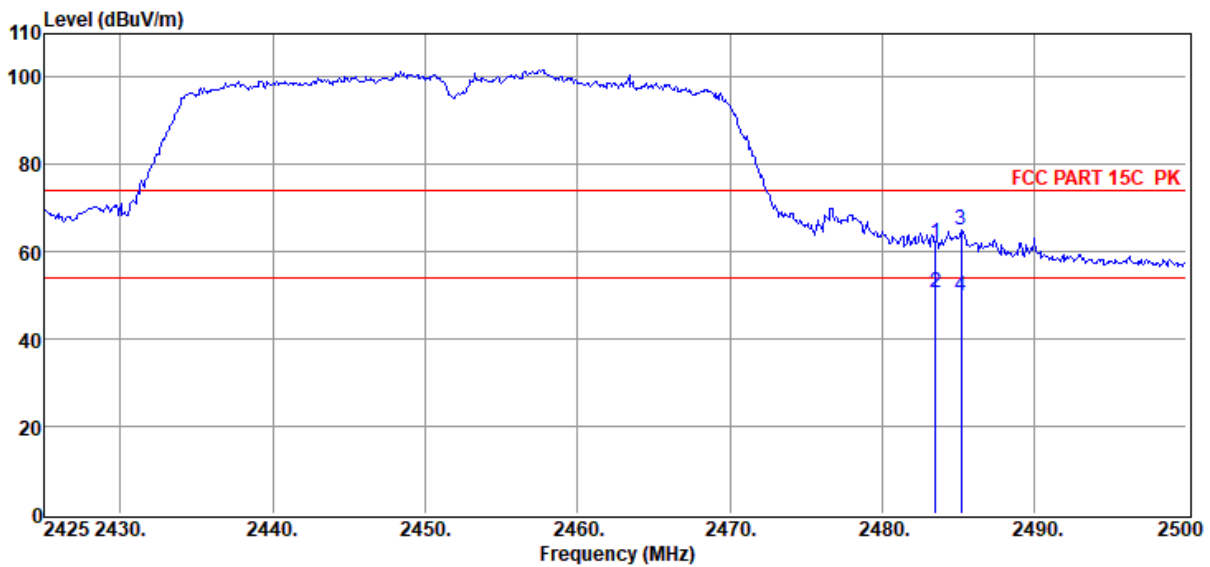

Item (Mark)	Freq. (MHz)	Read Level (dBμV)	Antenna Factor (dB/m)	PRM Factor (dB)	Cable Loss (dB)	Result Level (dBμV/m)	Limit Line (dBμV/m)	Over Limit (dB)	Detector	Polarization
1	2483.50	30.55	27.54	0.00	3.87	61.96	74.00	-12.04	Peak	VERTICAL
2	2483.50	19.34	27.54	0.00	3.87	50.75	54.00	-3.25	Average	VERTICAL
3	2485.23	33.65	27.55	0.00	3.87	65.07	74.00	-8.93	Peak	VERTICAL
4	2485.23	18.44	27.55	0.00	3.87	49.86	54.00	-4.14	Average	VERTICAL

Note: 1. Result Level = Read Level + Antenna Factor + Cable loss - PRM Factor.

2. If Peak Result complies with AV limit, AV Result is deemed to comply with AV limit.

3. Test setup: RBW: 1 MHz, VBW: 3 MHz, Sweep time: auto.

TR-4-E-009 Radiated Emission Test Result

Test Site : DDT 3m Chamber 1# D:\2019 RE1# Report Data\Q19080513-1E Bar9.1\FCC ABOVE 1G.EM6
Test Date : 2019-11-19 **Tested By** : Jacky
EUT : SOUNDBAR **Model Number** : BAR 9.1 CNTR
Power Supply : AC 230V/50Hz **Test Mode** : Tx mode
Condition : Temp:24.5°C,Humi:55%,Press:100.1kPa **Antenna/Distance** : 2019 BBHA 9120 D/3m/HORIZONTAL
Memo : 11N40 2452 POWER 14

Data: 240

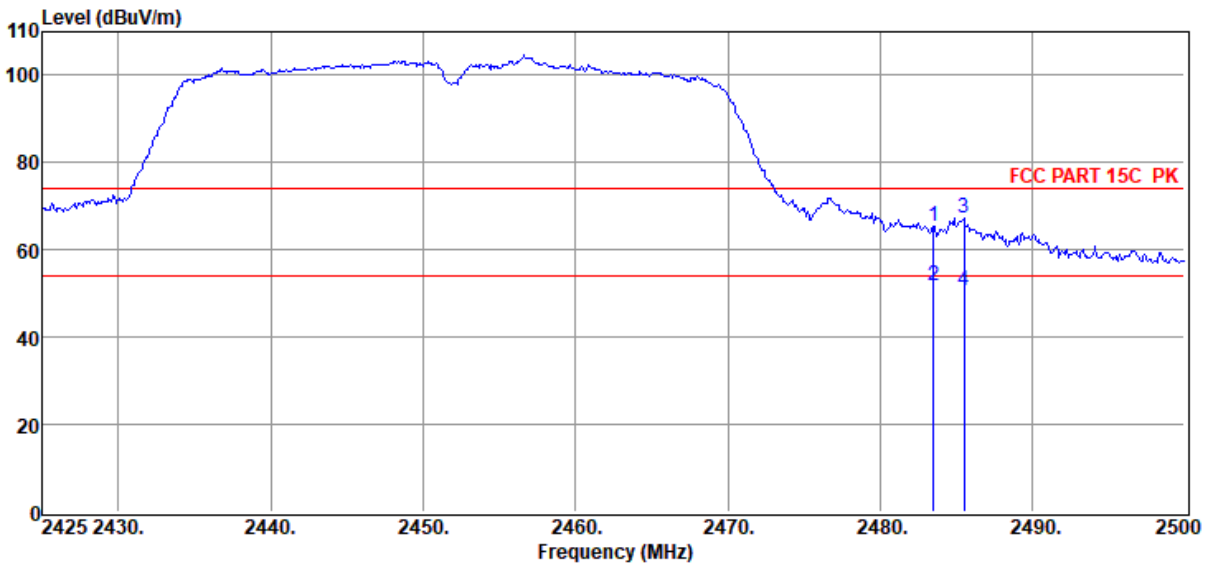

Item (Mark)	Freq. (MHz)	Read Level (dBuV)	Antenna Factor (dB/m)	PRM Factor (dB)	Cable Loss (dB)	Result Level (dBuV/m)	Limit Line (dBuV/m)	Over Limit (dB)	Detector	Polarization
1	2483.50	34.07	27.54	0.00	3.87	65.48	74.00	-8.52	Peak	HORIZONTAL
2	2483.50	20.22	27.54	0.00	3.87	51.63	54.00	-2.37	Average	HORIZONTAL
3	2485.53	35.80	27.55	0.00	3.87	67.22	74.00	-6.78	Peak	HORIZONTAL
4	2485.53	19.16	27.55	0.00	3.87	50.58	54.00	-3.42	Average	HORIZONTAL

- Note: 1. Result Level = Read Level + Antenna Factor + Cable loss - PRM Factor.
 2. If Peak Result complies with AV limit, AV Result is deemed to comply with AV limit.
 3. Test setup: RBW: 1 MHz, VBW: 3 MHz, Sweep time: auto.

10. Power Line Conducted Emission

10.1. Block diagram of test setup

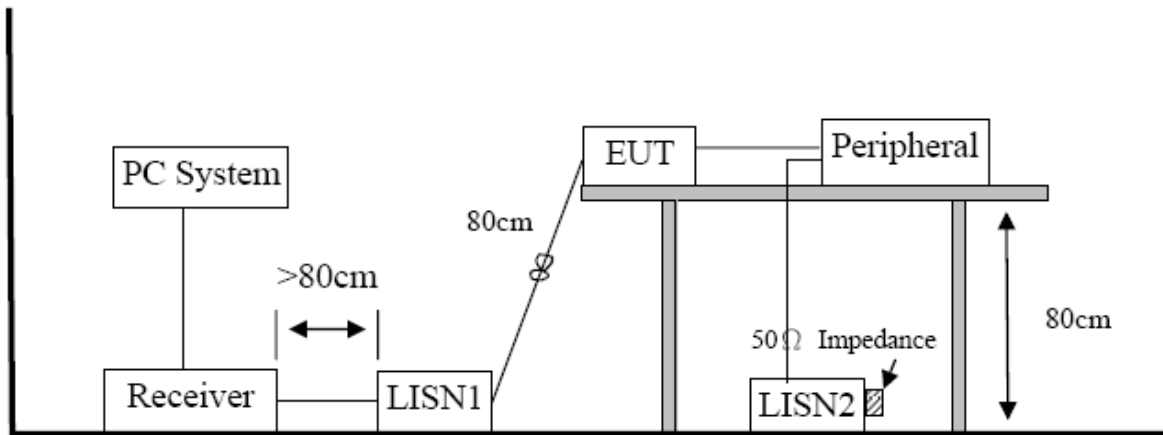

10.2. Power Line Conducted Emission Limits (Class B)

Frequency	Quasi-Peak Level dB(μ V)	Average Level dB(μ V)
150 kHz ~ 500 kHz	66 ~ 56*	56 ~ 46*
500 kHz ~ 5 MHz	56	46
5 MHz ~ 30 MHz	60	50

Note 1: * Decreasing linearly with logarithm of frequency.

Note 2: The lower limit shall apply at the transition frequencies.

10.3. Test Procedure

The EUT and Support equipment, if needed, were put placed on a non-metallic table, 80cm above the ground plane.

All I/O cables were positioned to simulate typical actual usage as per ANSI C63.4.

All support equipment power received from a second LISN.

Emissions were measured on each current carrying line of the EUT using an EMI Test Receiver connected to the LISN powering the EUT.

The Receiver scanned from 150 kHz to 30MHz for emissions in each of the test modes.

During the above scans, the emissions were maximized by cable manipulation.

After the preliminary scan, we found the test mode producing the highest emission level.

The EUT configuration and worse cable configuration of the above highest emission levels were recorded for reference of the final test.

EUT and support equipment were set up on the test bench as per the configuration with highest emission level in the preliminary test.

A scan was taken on both power lines, Neutral and Line, recording at least the six highest emissions.

Emission frequency and amplitude were recorded into a computer in which correction factors were used to calculate the emission level and compare reading to the applicable limit.

The test data of the worst-case condition(s) was recorded.

The bandwidth of test receiver is set at 9 kHz.

10.4. Test Result

PASS. (See below detailed test result)

Note1: All emissions not reported below are too low against the prescribed limits.

Note2: “-----” means peak detection; “-----” means average detection

Note3: Pre-test AC conducted emission at both voltage AC 120V/60Hz and AC 240V/60Hz, recorded worse case.

TR-4-E-010 Conducted Emission Test Result

Test Site : DDT 1# Shield Room D:\2019 CE report data\Q19080513-1E\20191104 CE.EM6
Test Date : 2019-11-05 **Tested By** : Huang
EUT : SOUNDBAR **Model Number** : BAR 9.1 CNTR
Power Supply : AC 120V/60Hz **Test Mode** : WIFI mode
Condition : Temp:24.5°C,Humi:61.5%,Press:101.4kPa **LISN** : 2018 ENV216/LINE

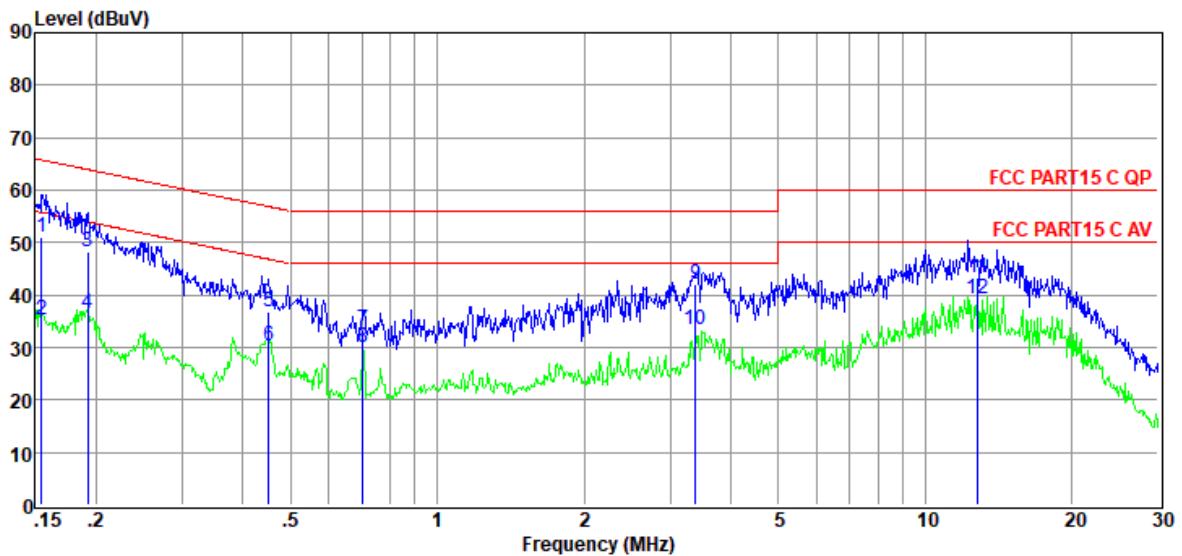

Item (Mark)	Freq. (MHz)	Read Level (dBμV)	LISN Factor (dB)	Cable Loss (dB)	Pulse Limiter Factor (dB)	Result Level (dBμV)	Limit Line (dBμV)	Over Limit (dB)	Detector	Phase
1	0.15	31.59	9.63	0.02	9.86	51.10	65.74	-14.64	QP	LINE
2	0.15	15.88	9.63	0.02	9.86	35.39	55.74	-20.35	Average	LINE
3	0.19	28.62	9.63	0.02	9.86	48.13	63.93	-15.80	QP	LINE
4	0.19	16.84	9.63	0.02	9.86	36.35	53.93	-17.58	Average	LINE
5	0.45	17.24	9.64	0.02	9.86	36.76	56.85	-20.09	QP	LINE
6	0.45	10.64	9.64	0.02	9.86	30.16	46.85	-16.69	Average	LINE
7	0.70	13.90	9.64	0.04	9.86	33.44	56.00	-22.56	QP	LINE
8	0.70	10.47	9.64	0.04	9.86	30.01	46.00	-15.99	Average	LINE
9	3.38	22.41	9.67	0.04	9.87	41.99	56.00	-14.01	QP	LINE
10	3.38	13.91	9.67	0.04	9.87	33.49	46.00	-12.51	Average	LINE
11	12.80	23.20	10.05	0.10	9.92	43.27	60.00	-16.73	QP	LINE
12	12.80	19.13	10.05	0.10	9.92	39.20	50.00	-10.80	Average	LINE

- Note: 1. Result Level = Read Level + LISN Factor + Pulse Limiter Factor + Cable loss.
 2. If QP Result complies with AV limit, AV Result is deemed to comply with AV limit.
 3. Test setup: RBW: 200 Hz (9 kHz—150 kHz), 9 kHz (150 kHz—30 MHz).
 4. Step size: 80Hz (0.009MHz-0.15MHz), 4 kHz (0.15MHz-30MHz), Scan time: auto.

TR-4-E-010 Conducted Emission Test Result

: DDT 1# Shield Room
 D:\2019 CE report data\Q19080513-1E\20191104 CE.EM6
Test Date : 2019-11-05 **Tested By** : Huang
EUT : SOUNDBAR **Model Number** : BAR 9.1 CNTR
Power Supply : AC 120V/60Hz **Test Mode** : WIFI mode
Condition : Temp:24.5°C,Humi:61.5%,Press:101.4kPa **LISN** : 2018 ENV216/NEUTRAL

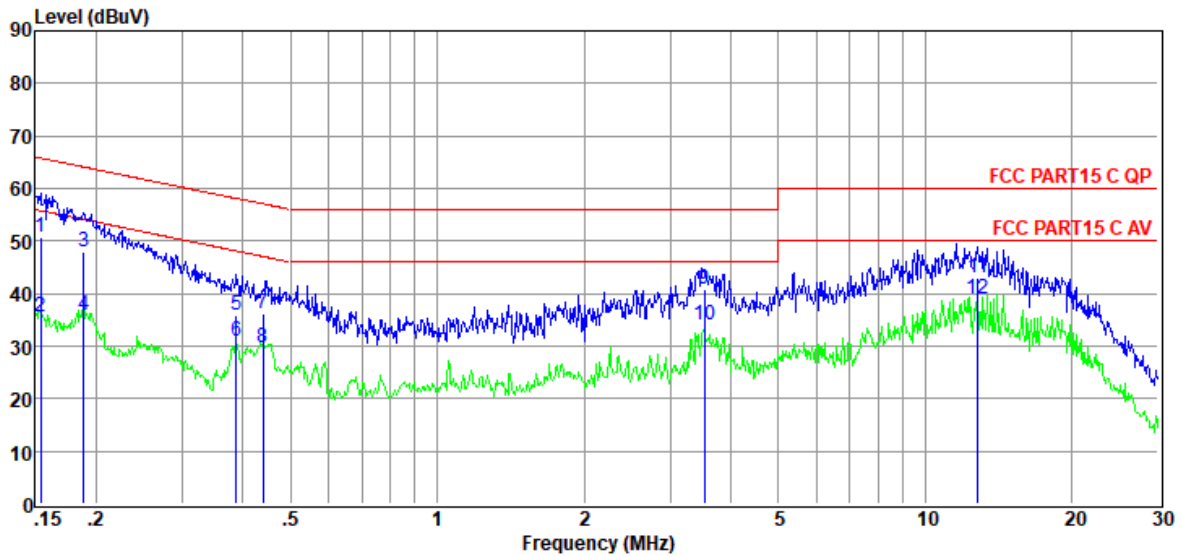

Item (Mark)	Freq. (MHz)	Read Level (dBμV)	LISN Factor (dB)	Cable Loss (dB)	Pulse Limiter Factor (dB)	Result Level (dBμV)	Limit Line (dBμV)	Over Limit (dB)	Detector	Phase
1	0.15	31.26	9.64	0.02	9.86	50.78	65.78	-15.00	QP	NEUTRAL
2	0.15	15.98	9.64	0.02	9.86	35.50	55.78	-20.28	Average	NEUTRAL
3	0.19	28.45	9.64	0.02	9.86	47.97	64.11	-16.14	QP	NEUTRAL
4	0.19	16.37	9.64	0.02	9.86	35.89	54.11	-18.22	Average	NEUTRAL
5	0.39	16.49	9.64	0.02	9.86	36.01	58.12	-22.11	QP	NEUTRAL
6	0.39	11.32	9.64	0.02	9.86	30.84	48.12	-17.28	Average	NEUTRAL
7	0.44	16.59	9.64	0.02	9.86	36.11	57.07	-20.96	QP	NEUTRAL
8	0.44	10.12	9.64	0.02	9.86	29.64	47.07	-17.43	Average	NEUTRAL
9	3.53	21.19	9.69	0.05	9.87	40.80	56.00	-15.20	QP	NEUTRAL
10	3.53	14.33	9.69	0.05	9.87	33.94	46.00	-12.06	Average	NEUTRAL
11	12.80	22.90	10.12	0.10	9.92	43.04	60.00	-16.96	QP	NEUTRAL
12	12.80	18.74	10.12	0.10	9.92	38.88	50.00	-11.12	Average	NEUTRAL

- Note: 1. Result Level = Read Level + LISN Factor + Pulse Limiter Factor + Cable loss.
 2. If QP Result complies with AV limit, AV Result is deemed to comply with AV limit.
 3. Test setup: RBW: 200 Hz (9 kHz—150 kHz), 9 kHz (150 kHz—30 MHz).
 4. Step size: 80Hz (0.009MHz-0.15MHz), 4 kHz (0.15MHz-30MHz), Scan time: auto.

11. Antenna Requirements

11.1. Limit

For intentional device, according to FCC 47 CFR Section 15.203, an intentional radiator shall be designed to ensure that no antenna other than that furnished by the responsible party shall be used with the device. And according to FCC 47 CFR Section 15.247 (b), if transmitting antennas of directional gain greater than 6dBi are used, the power shall be reduced by the amount in dB that the directional gain of the antenna exceeds 6dBi.

11.2. Result

The device support 2T2R MIMO, the antennas both used for this product are External FPC antennas and no antenna other than that furnished by the responsible party shall be used with the device, maximum antenna gain is 2.34 dBi for antenna 1, 2.97 dBi for antenna 2.

END OF REPORT