

FCC AND ISED CERTIFICATION TEST REPORT

FOR

Applicant	:	Harman International Industries, Inc.
Address	:	8500 Balboa Boulevard, Northridge, CA 91329, UNITED STATES
Equipment under Test	:	SOUNDBAR
Model No.	:	Bar 2.1 Deep Bass CNTR
HVIN	:	JBL Bar 2.1 Deep Bass CNTR
Trade Mark	:	JBL
FCC ID	:	APIBAR300CNTRM
IC	:	6132A-BAR300CNTRM
Manufacturer	:	Harman International Industries, Inc.
Address	:	8500 Balboa Boulevard, Northridge, CA 91329, UNITED STATES

Issued By: Dongguan Dongdian Testing Service Co., Ltd.

Add.: No. 17, Zongbu Road 2, Songshan Lake Sci&Tech, Industry Park,
Dongguan City, Guangdong Province, China, 523808

Tel.: +86-0769-38826678, **E-mail:** ddt@dgddt.com, <http://www.dgddt.com>

REPORT

Table of Contents

	Test report declares.....	4
1.	Summary of Test Results.....	6
2.	General Test Information	7
2.1.	Description of EUT	7
2.2.	Accessories of EUT.....	8
2.3.	Assistant equipment used for test.....	8
2.4.	Block diagram of EUT configuration for test.....	8
2.5.	Test environment conditions	8
2.6.	Deviations of test standard.....	8
2.7.	Test laboratory	9
2.8.	Measurement uncertainty.....	9
3.	Equipment Used During Test.....	10
4	Duty Cycle	11
4.1.	Block diagram of test setup.....	11
4.2.	Limits	11
4.3.	Test procedure	11
4.4.	Test result.....	11
4.5.	Original test data	12
5.	20 dB Bandwidth and 99% Bandwidth.....	13
5.1.	Block diagram of test setup.....	13
5.2.	Limits	13
5.3.	Test procedure	13
5.4.	Test result.....	13
5.5.	Original test data	14
6.	Radiated Emission	17
6.1.	Block diagram of test setup.....	17
6.2.	Limit.....	18
6.3.	Test procedure	19
6.4.	Test result.....	20
7.	Band Edge Compliance	36
7.1.	Block diagram of test setup.....	36
7.2.	Limit.....	36
7.3.	Test procedure	36
7.4.	Test result.....	36
8.	Power Line Conducted Emission.....	41
8.1.	Block diagram of test setup.....	41
8.2.	Power line conducted emission limits.....	41

8.3. Test procedure 41

8.4. Test result..... 42

9. Antenna Requirements 45

9.1. Limit 45

9.2. Result 45

10. Test Setup Photograph 46

11. Photos of the EUT 48

Test Report Declare

Applicant	:	Harman International Industries, Inc.
Address	:	8500 Balboa Boulevard, Northridge, CA 91329, UNITED STATES
Equipment under Test	:	SOUNDBAR
Model No.	:	Bar 2.1 Deep Bass CNTR
Trade mark	:	JBL
Manufacturer	:	Harman International Industries, Inc.
Address	:	8500 Balboa Boulevard, Northridge, CA 91329, UNITED STATES

Test Standard Used:

FCC Rules and Regulations Part 15 Subpart C, RSS-210 Issue 10 December 2019, Amendment (April 2020).

Test procedure used:

ANSI C63.10:2013, RSS-Gen Issue 5, Apr. 2018, Amendment 2 (February 2021).

We Declare:

The equipment described above is tested by Dongguan Dongdian Testing Service Co., Ltd. and in the configuration tested the equipment complied with the standards specified above. The test results are contained in this test report and Dongguan Dongdian Testing Service Co., Ltd. is assumed of full responsibility for the accuracy and completeness of these tests.

After test and evaluation, our opinion is that the equipment provided for test compliance with the requirement of the above FCC&ISED standards.

Report No:	DDT-R21121302-1E01		
Date of Receipt:	Dec. 13, 2021	Date of Test:	Dec. 13, 2021 ~ Jan. 19, 2022

Prepared By:

Sam Li

Sam Li/Engineer

Approved By:



Damon Hu/EMC Manager

Note: This report applies to above tested sample only. This report shall not be reproduced in parts without written approval of Dongguan Dongdian Testing Service Co., Ltd.

Revision History

Rev.	Revisions	Issue Date	Revised By
---	Initial issue	Jan. 19, 2022	

1. Summary of Test Results

The EUT have been tested according to the applicable standards as referenced below.		
Description of Test Item	Standard	Results
20 dB Bandwidth and 99% Bandwidth	FCC Part 15: 15.215 ANSI C63.10:2013 RSS-210 Issue 10 RSS-Gen Issue 5	Pass
Radiated Emission	FCC Part 15: 15.209 FCC Part 15: 15.249 ANSI C63.10:2013 RSS-210 Issue 10 RSS-Gen Issue 5	Pass
Band Edge Compliance	FCC Part 15: 15.205 FCC Part 15: 15.249 ANSI C63.10:2013 RSS-210 Issue 10 RSS-Gen Issue 5	Pass
Power Line Conducted Emission	FCC Part 15: 15.207 ANSI C63.10:2013 RSS-Gen Issue 5	Pass
Antenna Requirement	FCC Part 15: 15.203 RSS-Gen Issue 5	Pass

2. General Test Information

2.1. Description of EUT

EUT* Name	: SOUNDBAR
Model Number	: Bar 2.1 Deep Bass CNTR
EUT function description	: Please reference user manual of this device
Power Supply	: AC 100-240V, 50/60Hz
Operation frequency	: 5743 MHz - 5832 MHz
Modulation	: FSK
Antenna Type	: Antenna 1: Integral PCB antenna, maximum PK gain: 1.57 dBi Antenna 2: Integral PCB antenna, maximum PK gain: 1.57 dBi The EUT supports the antenna with TX and RX diversity functions. Both Ant. 1 and Ant. 2 support transmit and receive functions, but only one of them will be used at one time, and Ant. 1 generated the worst case, so it was selected to test and record in the report.
Serial Number	: RS0072-JL0000174 for conducted test RS0072-JL0000156 for radiation test

Note: EUT is the abbreviation of equipment under test.

EUT channels and frequencies list:

Channel information					
Channel	Frequency (MHz)	Channel	Frequency (MHz)	Channel	Frequency (MHz)
1	5743	17	5775	33	5807
2	5745	18	5777	34	5809
3	5747	19	5779	35	5811
4	5749	20	5781	36	5813
5	5751	21	5783	37	5815
6	5753	22	5785	38	5817
7	5755	23	5787	39	5819
8	5757	24	5789	40	5821
9	5759	25	5791	41	5823
10	5761	26	5793	42	5825
11	5763	27	5795	43	5827
12	5765	28	5797	44	5829
13	5767	29	5799	45	5831
14	5769	30	5801	46	5832
15	5771	31	5803	/	/
16	5773	32	5805		

2.2. Accessories of EUT

Description of Accessories	Manufacturer	Model number	Serial No.	Other
AC cable	Harman	N/A	N/A	Length: 1.5m, unshielded
HDMI cable	Harman	N/A	N/A	Length: 1.5m, shielded, two core

2.3. Assistant equipment used for test

Assistant equipment	Manufacturer	Model number	EMC Compliance	SN
N/A	N/A	N/A	N/A	N/A

2.4. Block diagram of EUT configuration for test



Test software: EMI_Tool

The test software was used to control EUT work in Continuous Tx mode, and select test channel, wireless mode as below table.

Tested mode, channel, information			
Mode	Setting Tx Power	Channel	Frequency (MHz)
FSK Tx mode	5	CH1	5743
	5	CH23	5787
	5	CH46	5832

2.5. Test environment conditions

During the measurement the environmental conditions were within the listed ranges:

Temperature range:	21-25 °C
Humidity range:	40-75%
Pressure range:	86-106 kPa

2.6. Deviations of test standard

No deviation.

2.7. Test laboratory

Dongguan Dongdian Testing Service Co., Ltd.

Add.: No. 17, Zongbu Road 2, Songshan Lake Sci&Tech, Industry Park, Dongguan City, Guangdong Province, China, 523808.

Tel.: +86-0769-38826678, <http://www.dgddt.com>, Email: ddt@dgddt.com.

CNAS Accreditation No. L6451; A2LA Accreditation Number: 3870.01

FCC Designation Number: CN1182, Test Firm Registration Number: 540522

Innovation, Science and Economic Development Canada Site Registration Number: 10288A

Conformity Assessment Body identifier: CN0048

VCCI facility registration number: C-20087, T-20088, R-20123, G-20118

2.8. Measurement uncertainty

Test Item	Uncertainty
Bandwidth	1.1%
Peak Output Power (Conducted) (Spectrum Analyzer)	0.86 dB (10 MHz ≤ f < 3.6 GHz);
	1.38 dB (3.6 GHz ≤ f < 8 GHz)
Peak Output Power (Conducted) (Power Sensor)	0.74 dB
Power Spectral Density	0.74 dB (10 MHz ≤ f < 3.6 GHz);
	1.38 dB (3.6 GHz ≤ f < 8 GHz)
Frequencies Stability	6.7 x 10 ⁻⁸ (Antenna couple method)
	5.5 x 10 ⁻⁸ (Conducted method)
Conducted Spurious Emissions	0.86 dB (10 MHz ≤ f < 3.6 GHz);
	1.40 dB (3.6 GHz ≤ f < 8 GHz)
	1.66 dB (8 GHz ≤ f < 22 GHz)
Uncertainty for Radio Frequency (RBW < 20 kHz)	3x10 ⁻⁸
Temperature	0.4 °C
Humidity	2 %
Uncertainty for Radiation Emission Test (9 kHz – 30 MHz)	3.44 dB
Uncertainty for Radiation Emission Test (30 MHz - 1 GHz)	4.70 dB (Antenna Polarize: V)
	4.84 dB (Antenna Polarize: H)
Uncertainty for Radiation Emission Test (1 GHz - 40 GHz)	4.10 dB (1 - 6 GHz)
	4.40 dB (6 GHz - 18 GHz)
	3.54 dB (18 GHz - 26 GHz)
	4.30 dB (26 GHz - 40 GHz)
Uncertainty for Power Line Conduction Emission Test	3.32 dB (150 kHz - 30 MHz)
Note: This uncertainty represents an expanded uncertainty expressed at approximately the 95% confidence level using a coverage factor of k=2.	

3. Equipment Used During Test

Equipment	Manufacturer	Model No.	Serial No.	Last Cal.	Cal. Interval
<input checked="" type="checkbox"/> RF Connected Test (Tonscend RF Measurement System 1#)					
Spectrum analyzer	R&S	FSU26	200071	Sep. 02, 2021	1 Year
Wideband Radio Communication tester	R&S	CMW500	120259	Sep. 02, 2021	1 Year
Vector Signal Generator	Agilent	E8267D	US49060192	Sep. 18, 2021	1 Year
Vector Signal Generator	Agilent	N5182A	MY48180737	Jun. 01, 2021	1 Year
RF Control Unit	Tonsend	JS0806-2	158060010	Jun. 01, 2021	1 Year
Temp&Humi Programmable	ZHIXIANG	ZXGDJS-150L	ZX170110-A	Jun. 01, 2021	1 Year
Test Software	JS Tonscend	JS1120-3	Ver.2.6.77.0518	N/A	N/A
<input checked="" type="checkbox"/> Radiation 3#chamber					
EMI Test Receiver	R&S	ESU	100472	Jun. 01, 2021	1 Year
Spectrum analyzer	Agilent	E4447A	MY50180031	Jun. 01, 2021	1 Year
Active Loop antenna	Schwarzbeck	FMZB-1519	1519-038	Sep. 19, 2021	1 Year
Trilog Broadband Antenna	Schwarzbeck	VULB 9163	01429	Aug. 07, 2021	1 Year
Double Ridged Horn Antenna	Schwarzbeck	BBHA9120	02108	Jul. 17, 2021	1 Year
Broad Band Horn Antenna	Schwarzbeck	BBHA 9170	790	May 08, 2021	1 Year
Pre-amplifier	COM-POWER	PAM-118A	18040084	Sep. 02, 2021	1 Year
Pre-amplifier	COM-POWER	PAM-840A	461369	Mar. 15, 2021	1 Year
Test software	Audix	E3	V 6.1.1.1	N/A	N/A
<input type="checkbox"/> Power Line Conducted Emissions Test 1#					
Test Receiver	R&S	ESCI	100551	Sep. 02, 2021	1 Year
LISN 1	R&S	ENV216	101109	Sep. 02, 2021	1 Year
LISN 2	R&S	ESH2-Z5	100309	Sep. 02, 2021	1 Year
Pulse Limiter	R&S	ESH3-Z2	101242	Sep. 02, 2021	1 Year
CE Cable 1	HUBSER	N/A	W10.01	Sep. 02, 2021	1 Year
LISN 3	SCHWARZBECK	NSLK 8163	00017	Sep. 02, 2021	1 Year
Test software	Audix	E3	V 6.11111b	N/A	N/A
<input checked="" type="checkbox"/> Power Line Conducted Emissions Test 2#					
Test Receiver	R&S	ESCI	101028	Sep. 02, 2021	1 Year
LISN 1	R&S	ENV216	101170	Sep. 02, 2021	1 Year
Pulse Limiter	R&S	KH43101	431011801568-12#	Jun. 01, 2021	1 Year
CE Cable 2	HUBSER	RG214-5	N/A	Jun. 01, 2021	1 Year
Test software	Audix	E3	V 6.11111b	N/A	N/A

4 Duty Cycle

4.1. Block diagram of test setup

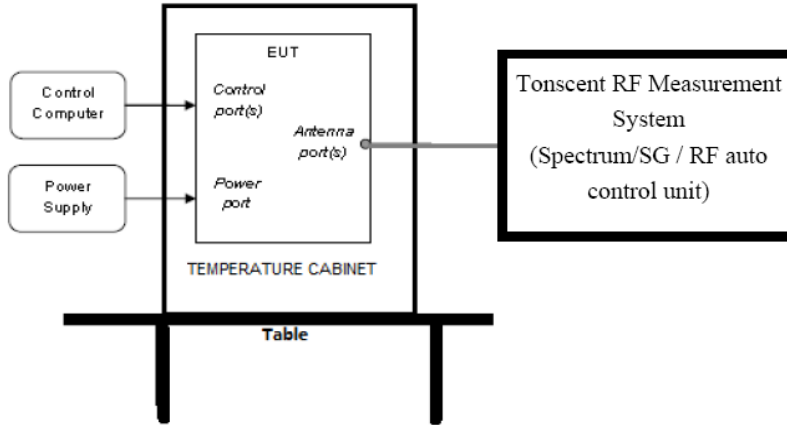

4.2. Limits

None: for reporting purposes only.

4.3. Test procedure

Set the Centre frequency of the spectrum analyzer to the transmitting frequency;
 Set the span = 0, RBW = 3 MHz, VBW = 3 MHz, Sweep time = 100 ms;
 Trace mode = Single hold.

4.4. Test result

Test Channel [MHz]	Duty Cycle [%]	20log(Δ) Factor[dB]
5743	13.82	-17.19

Average value:	
Calculate Formula:	Average value = Peak value + PDCF
	PDCF = 20 log(Duty cycle)
	Duty cycle = $T_{on\ time} / T_{period}$
Test data:	$T_{on\ time} = (0.384 * 36) \text{ ms} = 13.82 \text{ ms}$
	$T_{period} = 100 \text{ ms}$
	PDCF = 20 log(Duty cycle) = 20 log(13.82/100) = -17.19 dB

4.5. Original test data

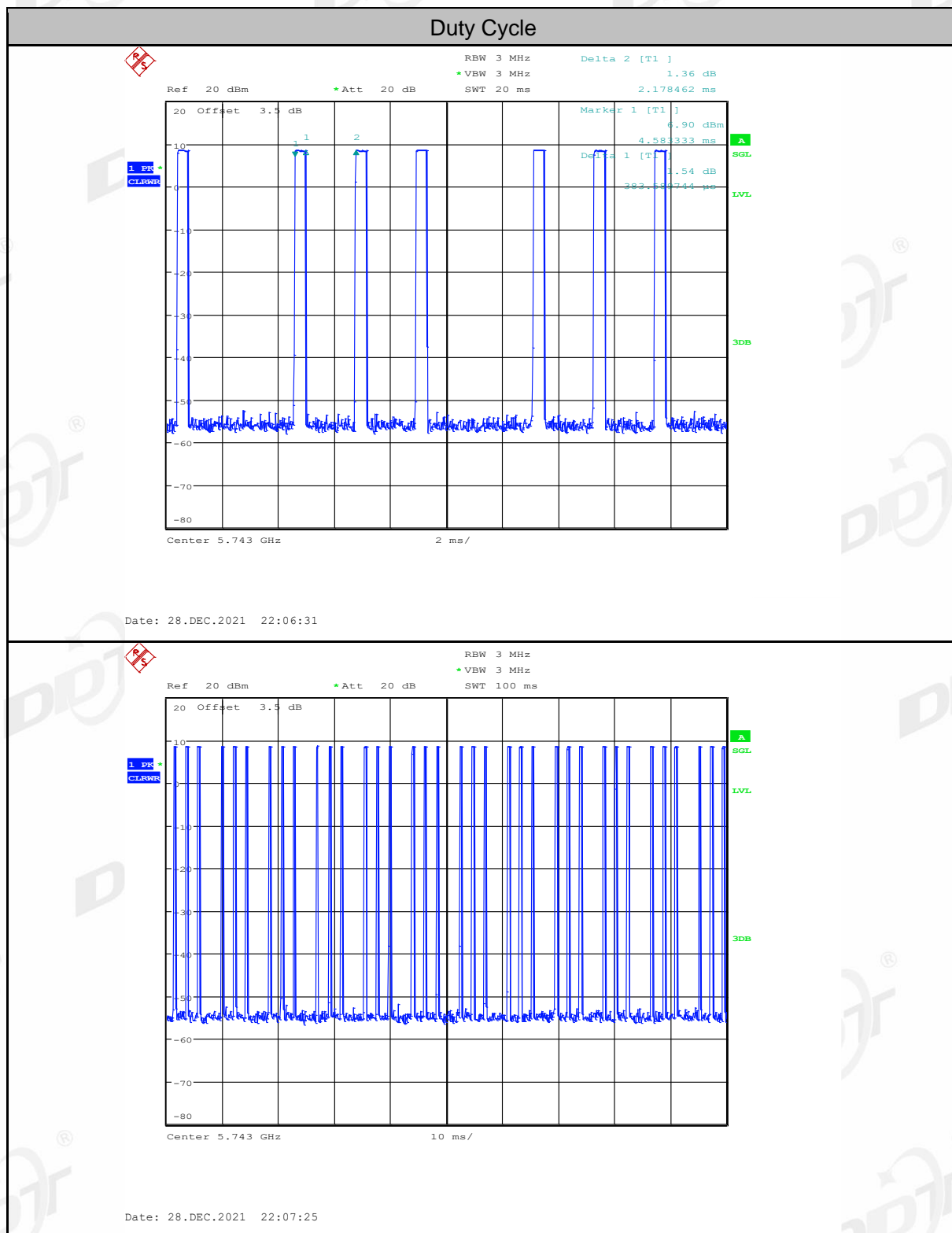

5. 20 dB Bandwidth and 99% Bandwidth

5.1. Block diagram of test setup

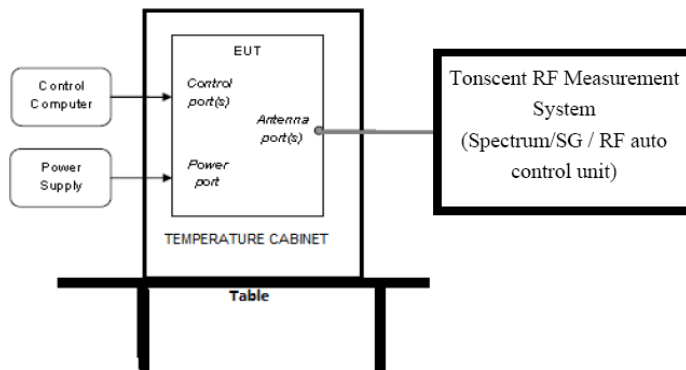

5.2. Limits

Intentional radiators operating under the alternative provisions to the general emission limits, as contained in § 15.217 through 15.257 and in Subpart E of this part, must be designed to ensure that the 20 dB bandwidth of the emission, or whatever bandwidth may otherwise be specified in the specific rule section under which the equipment operates, is contained within the frequency band designated in the rule section under which the equipment is operated.

5.3. Test procedure

(1) Connect EUT's antenna output to spectrum analyzer by RF cable.

(2) Set the spectrum analyzer as follows:

RBW:	100 kHz
VBW:	300 kHz
Detector Mode:	Peak/RMS
Sweep time:	auto
Trace mode	Max hold

(3) Allow the trace to stabilize, measure the 20 dB and 99% bandwidth of signal.

5.4. Test result

Test Mode	Freq. (MHz)	20 dB bandwidth Result (MHz)	99% bandwidth Result (MHz)	Verdict
FSK Tx mode	5743	2.676	2.372	Pass
	5787	2.612	2.420	Pass
	5832	2.548	2.420	Pass

5.5. Original test data

20 dB bandwidth:

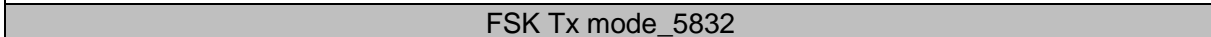
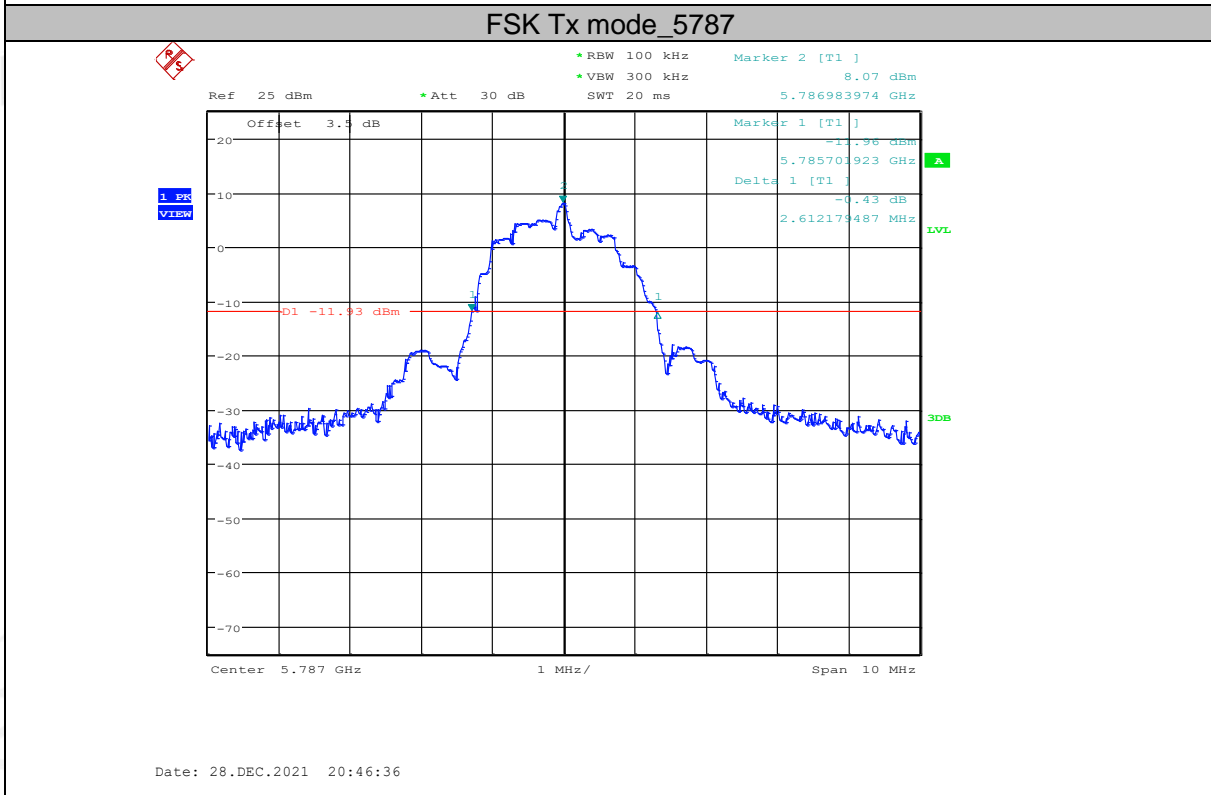
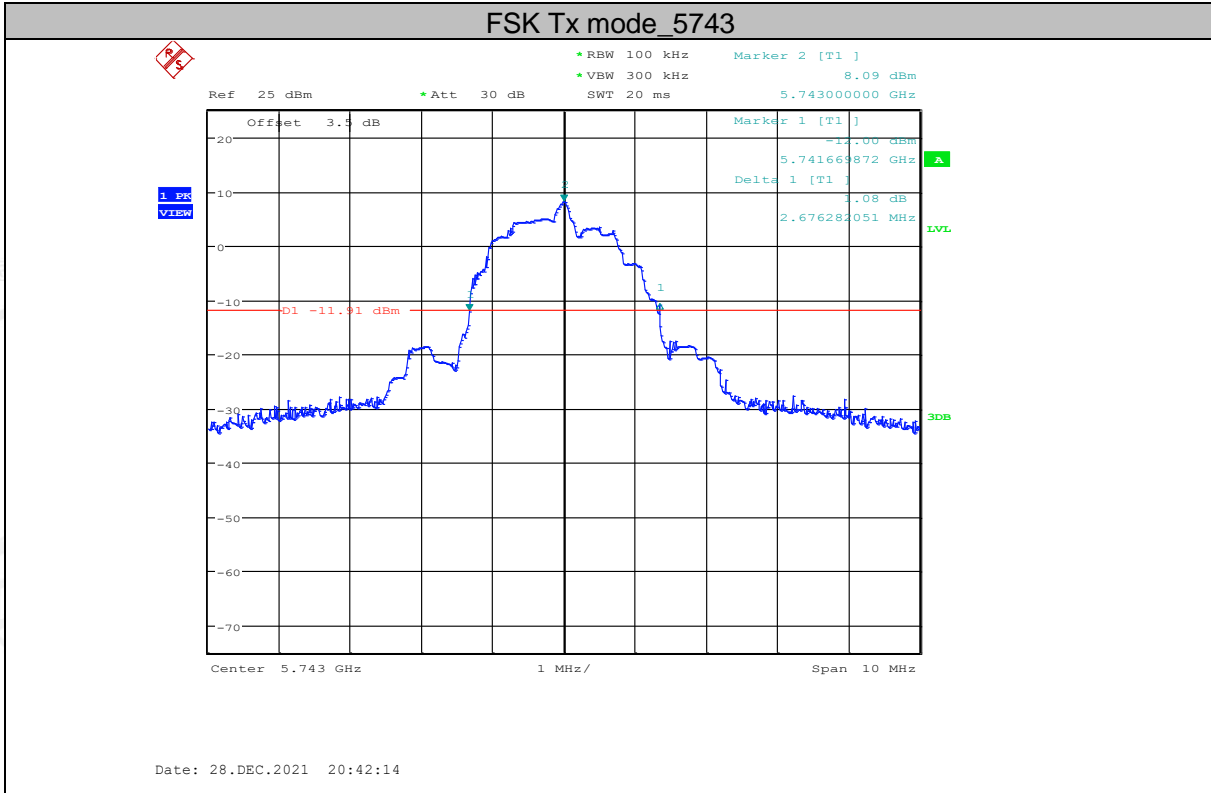

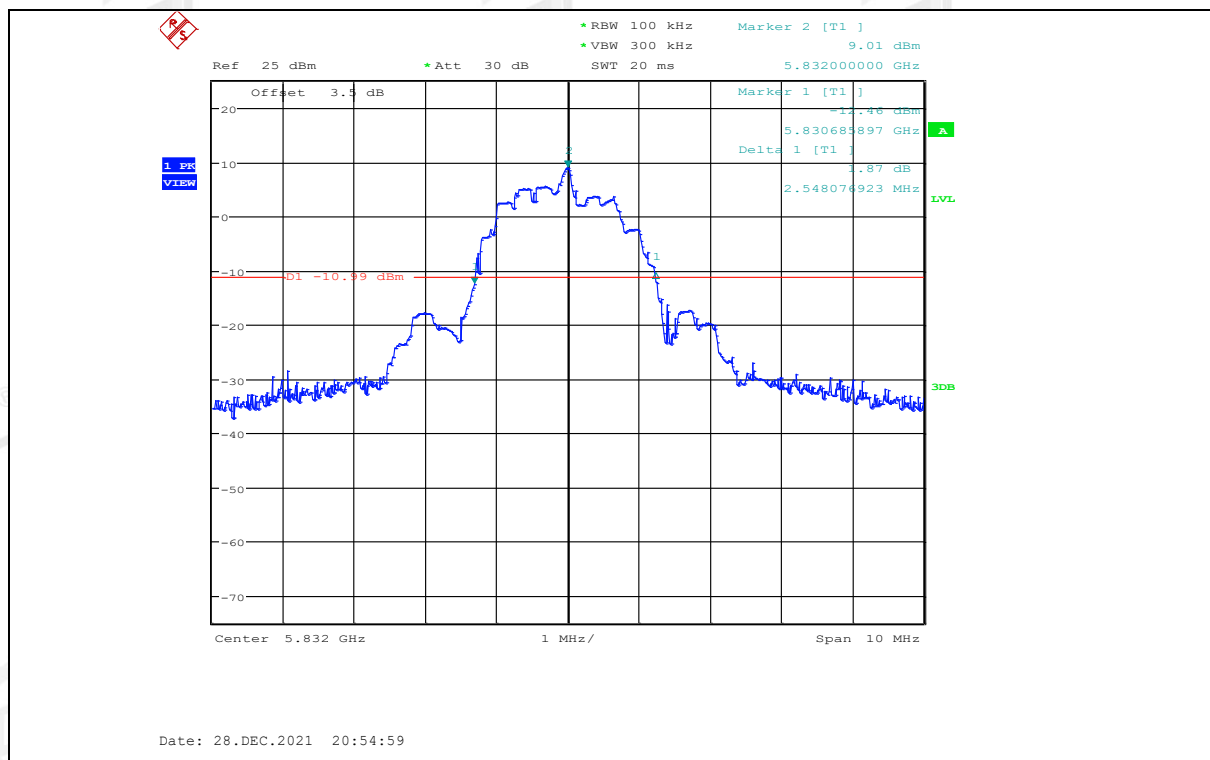

99% bandwidth

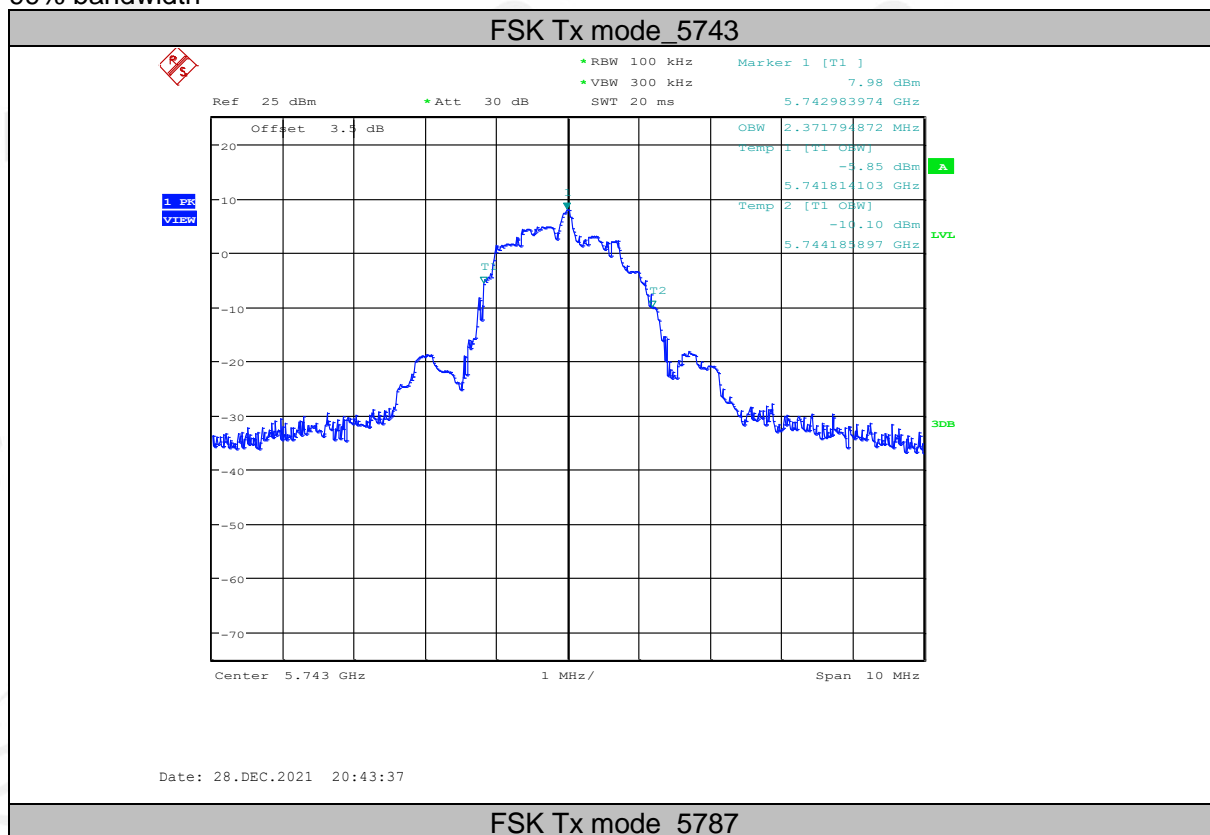

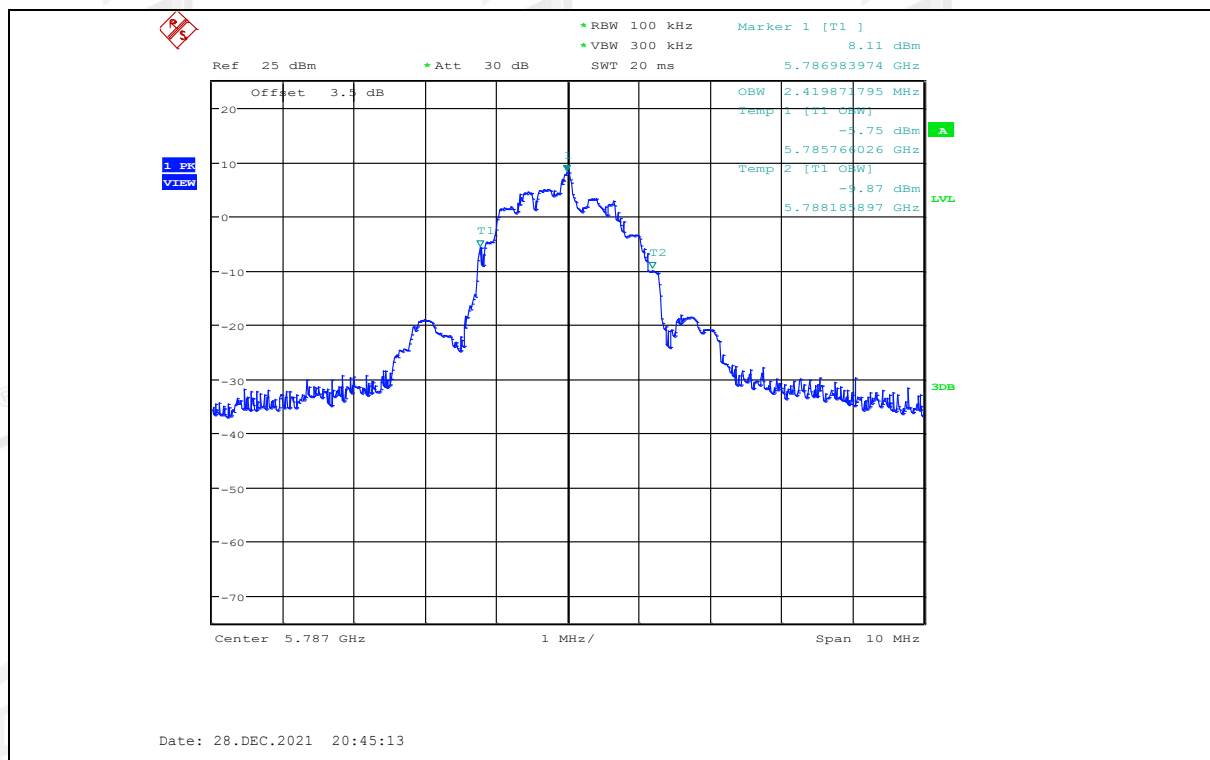

FSK Tx mode_5832

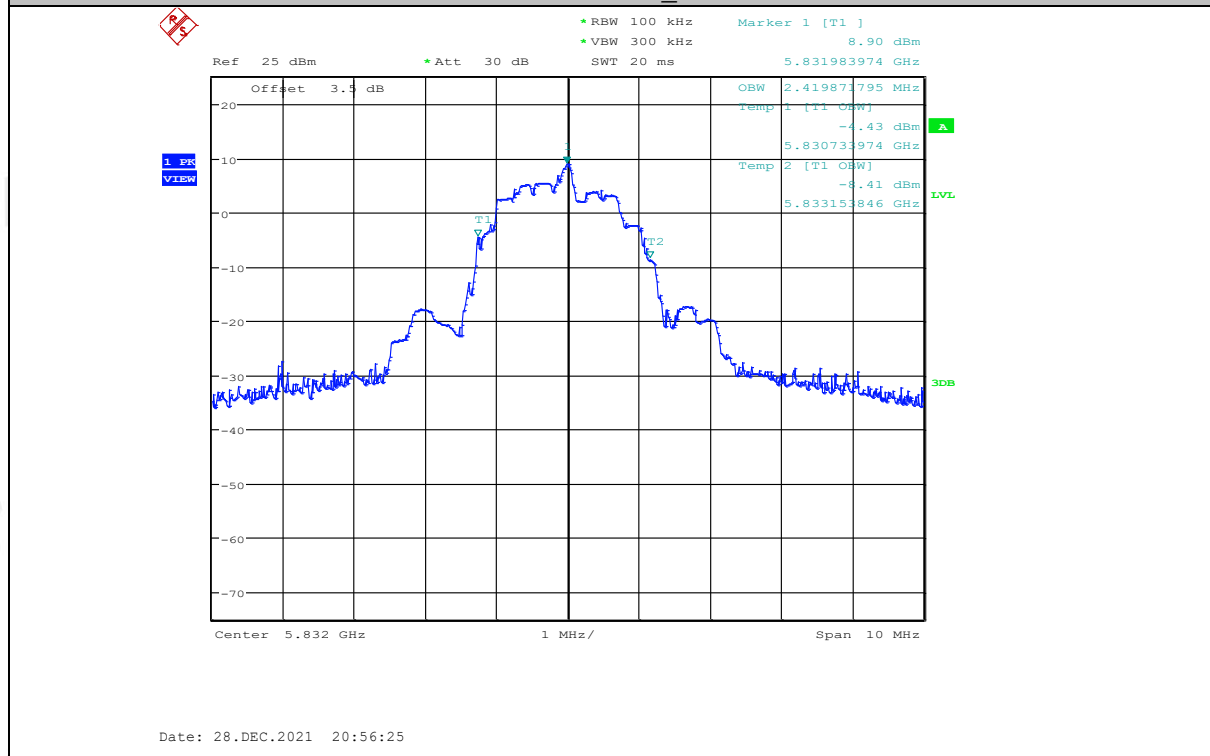

6. Radiated Emission

6.1. Block diagram of test setup

In 3 m Anechoic Chamber, test setup diagram for 9 kHz - 30 MHz:

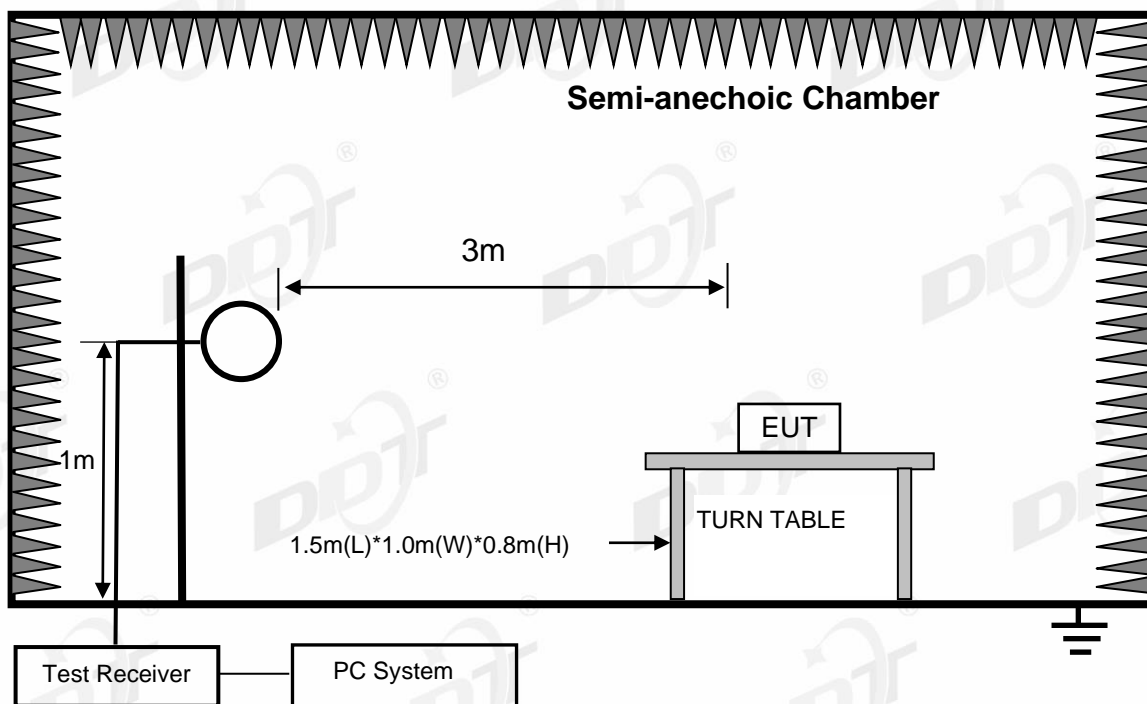

In 3 m Anechoic Chamber, test setup diagram for 30 MHz - 1 GHz:

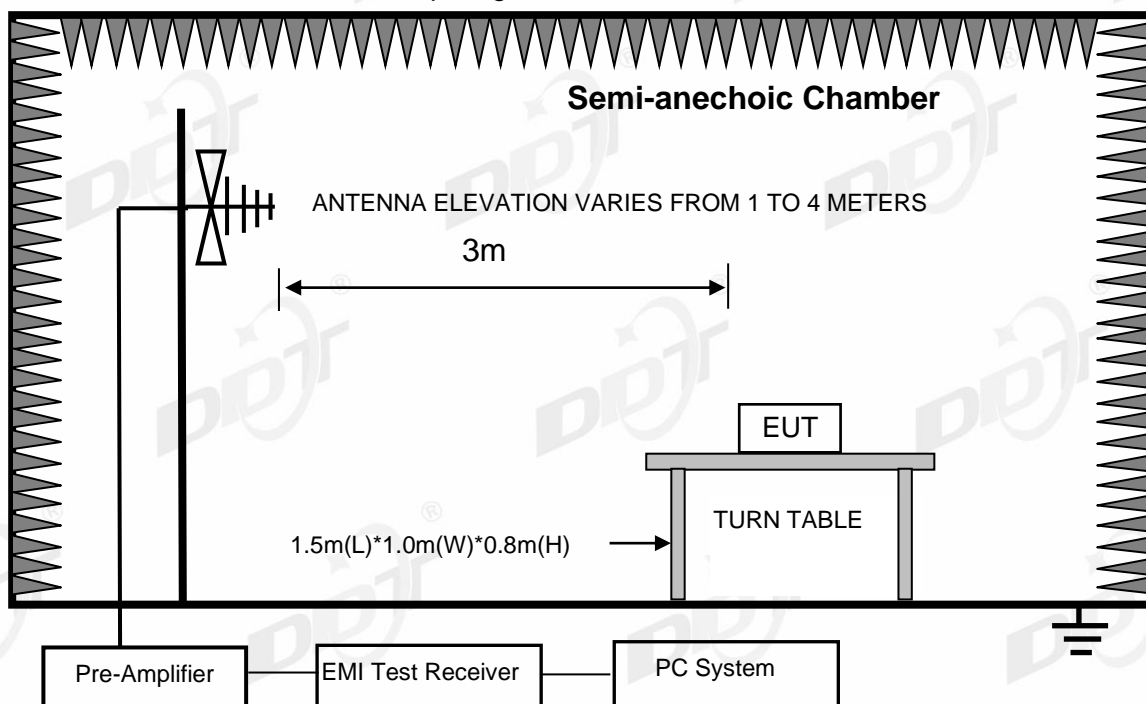

In 3 m Anechoic Chamber, test setup diagram for frequency above 1 GHz:

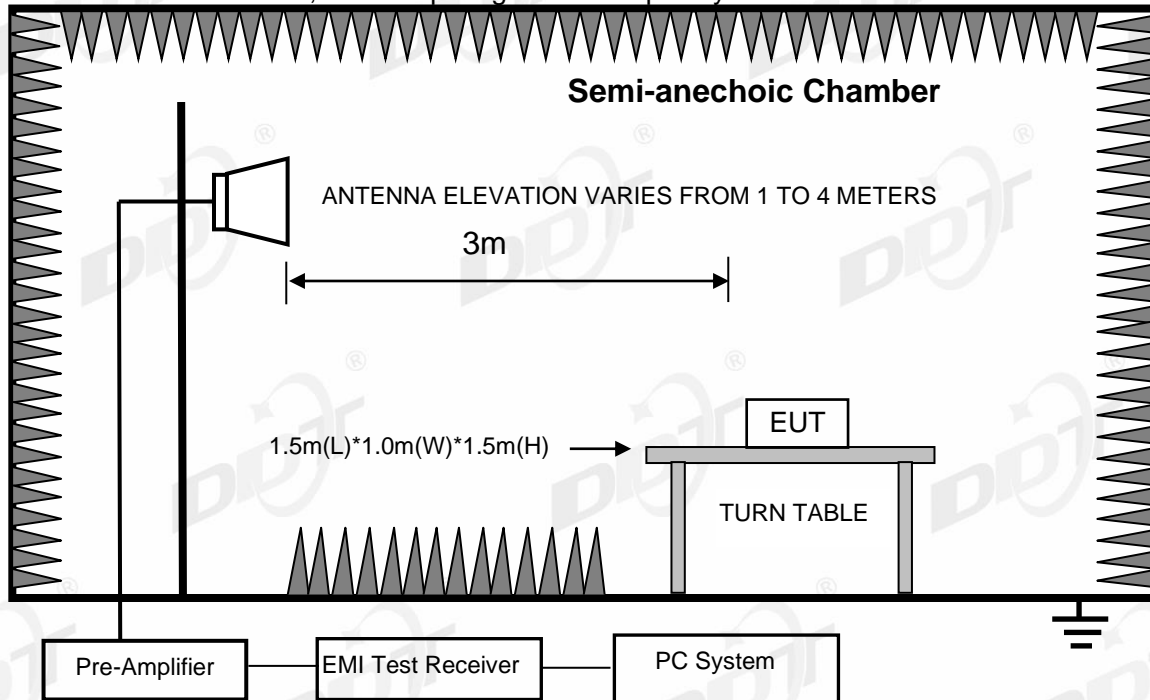

Note: For harmonic emissions test an appropriate high pass filter was inserted in the input port of AMP.

6.2. Limit

FREQUENCY MHz	DISTANCE Meters	FIELD STRENGTHS LIMIT	
		μV/m	dB(μV)/m
30 ~ 88	3	100	40.0
88 ~ 216	3	150	43.5
216 ~ 960	3	200	46.0
960 ~ 1000	3	500	54.0
Above 1000 MHz	3	74.0 dB(μV)/m (Peak) 54.0 dB(μV)/m (Average)	
Field Strength of Fundamental emission for 5725 MHz - 5875 MHz	3	94.0 dB(μV)/m (Average) 114.0 dB(μV)/m (Peak)	
Field Strength of Harmonics	3	74.0 dB(μV)/m (Peak) 54.0 dB(μV)/m (Average)	

Remark:

- (1) Emission level $dB_{\mu V} = 20 \log$ Emission level $\mu V/m$
- (2) The smaller limit shall apply at the cross point between two frequency bands.
- (3) Distance is the distance in meters between the measuring instrument, antenna and the closest point of any part of the device or system.
- (4) The emission limits shown in the above table are based on measurements employing a CISPR quasi-peak detector except for the frequency bands 9-90 kHz, 110-490 kHz and above 1000 MHz, radiated emission limits in these three bands are based on measurements employing an average detector.

6.3. Test procedure

- (1) EUT was placed on a non-metallic table, 80 cm above the ground plane inside a semi-anechoic chamber.
- (2) Setup EUT and assistant system according clause 2.3
- (3) Test antenna was located 3 m from the EUT on an adjustable mast. Below pre-scan procedure was first performed in order to find prominent radiated emissions.
 - (a) Change work frequency or channel of device if practicable.
 - (b) Change modulation type of device if practicable.
 - (c) Change power supply range from 85% to 115% of the rated supply voltage
 - (d) Rotated EUT though three orthogonal axes to determine the attitude of EUT arrangement produces highest emissions
- (4) Spectrum frequency from 9 kHz to 40 GHz (tenth harmonic of fundamental frequency) was investigated, and no any obvious emission were detected from 9 kHz to 30 MHz and 18 GHz to 40 GHz, so below final test was performed with frequency range from 30 MHz to 18 GHz.
- (5) For final emissions measurements at each frequency of interest, the EUT were rotated and the antenna height was varied between 1 m and 4 m in order to maximize the emission. Measurements in both horizontal and vertical polarities were made and the data was recorded. In order to find the maximum emission, the relative positions of equipments and all of the interface cables were changed according to ANSI C63.10:2013 on Radiated Emission test.
- (6) For emissions from 30 MHz to 1 GHz, Quasi-Peak values were measured with EMI Receiver and the bandwidth of Receiver is 120 kHz.
- (7) For emissions above 1 GHz, both Peak and Average level were measured with Spectrum Analyzer, and the RBW is set at 1 MHz, VBW is set at 3 MHz for Peak measure; according ANSI C63.10:2013 clause 4.1.4.2.2 procedure for average measure.
- (8) For fundamental frequency test, set spectrum analyzer's RBW = 3 MHz, VBW = 10 MHz. Peak detector for PK, according ANSI C63.10:2013 clause 4.1.4.2.2 procedure for average measure.

6.4. Test result

Pass. (See below detailed test result)

All the emissions except fundamental emission from 9 kHz to 40 GHz were comply with 15.209 limit.

Note1: According exploratory test no any obvious emission was detected from 9 kHz to 30 MHz and 18 GHz to 40 GHz, so the final test was performed with frequency range from 30 MHz to 18 GHz and recorded in below.

Note2: For emissions below 1 GHz, according exploratory explorer test, when change Tx mode and channel, have no distinct influence on emissions level, so for emissions below 1 GHz, the final test was only performed with EUT working in FSK, Tx 5743 MHz mode.

Note3: For emissions above 1 GHz. If peak results comply with AV limit, AV Result is deemed to comply with AV limit.

Note4: For simultaneous transmission of multiple channels in the 2.4GHz BT and 5.8GHz SRD bands, no noticeable emission was found.

Field Strength of the Fundamental Signal

Frequency (MHz)	PK Level (dBuV/m)	PK Limit Line (dBuV/m)	Over Limit (dB)	Polarization
5743	88.22	114.00	-25.78	Horizontal
5787	94.76	114.00	-19.24	Horizontal
5832	93.91	114.00	-20.09	Horizontal
5743	92.23	114.00	-21.77	Vertical
5787	95.06	114.00	-18.94	Vertical
5832	93.99	114.00	-20.01	Vertical

Frequency (MHz)	AV Level (dBuV/m)	AV Limit Line (dBuV/m)	Over Limit (dB)	Polarization
5743	71.03	94.00	-22.97	Horizontal
5787	77.57	94.00	-16.43	Horizontal
5832	76.72	94.00	-17.28	Horizontal
5743	75.04	94.00	-18.96	Vertical
5787	77.87	94.00	-16.13	Vertical
5832	76.80	94.00	-17.20	Vertical

Note: AV Level = PK Level + PDCF, PDCF = -17.19 dB

Radiated Emission test (below 1 GHz)

TR-4-E-009 Radiated Emission Test Result

Test Site : DDT 3m Chamber 3# D:\2021 report data\Q21121302-1E JBL Bar
2.1\bar\FCC BELOW 1G\FCC BELOW 1G_00001.EMI
Test Date : 2022-01-06 **Tested By** : James Gan
EUT : SOUNDBAR **Model Number** : Bar 2.1 Deep Bass CNTR
Power Supply : AC 120V/60Hz **Test Mode** : Tx Mode
Condition : Temp:22.6°,Humi:52.6%,Press:100.6kPa **Antenna/Distance** : VLUB 9163 3#/3m/Horizontal
Memo :

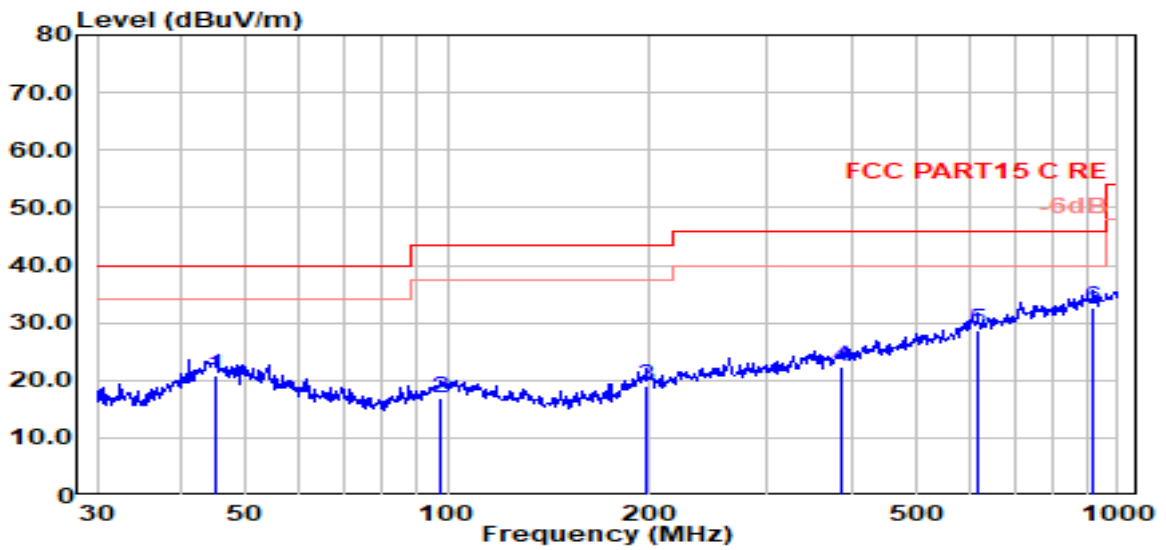

Item (Mark)	Freq. (MHz)	Read Level (dBUV)	Antenna Factor (dB/m)	Cable Loss (dB)	Result Level (dBUV/m)	Limit Line (dBUV/m)	Over Limit (dB)	Detector	Polarization
1	45.22	2.13	14.99	3.62	20.74	40.00	-19.26	QP	Horizontal
2	97.80	1.61	11.48	3.97	17.06	43.50	-26.44	QP	Horizontal
3	197.89	2.79	11.89	4.44	19.12	43.50	-24.38	QP	Horizontal
4	386.63	1.93	15.17	5.11	22.20	46.00	-23.80	QP	Horizontal
5	618.54	3.73	19.03	5.78	28.55	46.00	-17.45	QP	Horizontal
6	919.29	3.57	22.40	6.51	32.49	46.00	-13.51	QP	Horizontal

Note:

1. Result Level = Read Level + Antenna Factor + Cable loss.
2. If Peak Result complies with QP limit, QP Result is deemed to comply with QP limit.
3. Test setup: RBW: 120 kHz, VBW: 300 kHz, Sweep time: auto

TR-4-E-009 Radiated Emission Test Result

Test Site : DDT 3m Chamber 3#

D:\2021 report data\Q21121302-1E JBL Bar
2.1\bar\FCC BELOW 1G\FCC BELOW 1G_00002.EMI

Test Date : 2022-01-06

Tested By : James Gan

EUT : SOUNDBAR

Model Number : Bar 2.1 Deep Bass CNTR

Power Supply : AC 120V/60Hz

Test Mode : Tx Mode

Condition : Temp:22.6°,Humi:52.6%,Press:100.6kPa **Antenna/Distance** : VLUB 9163 3#/3m/Vertical

Memo :

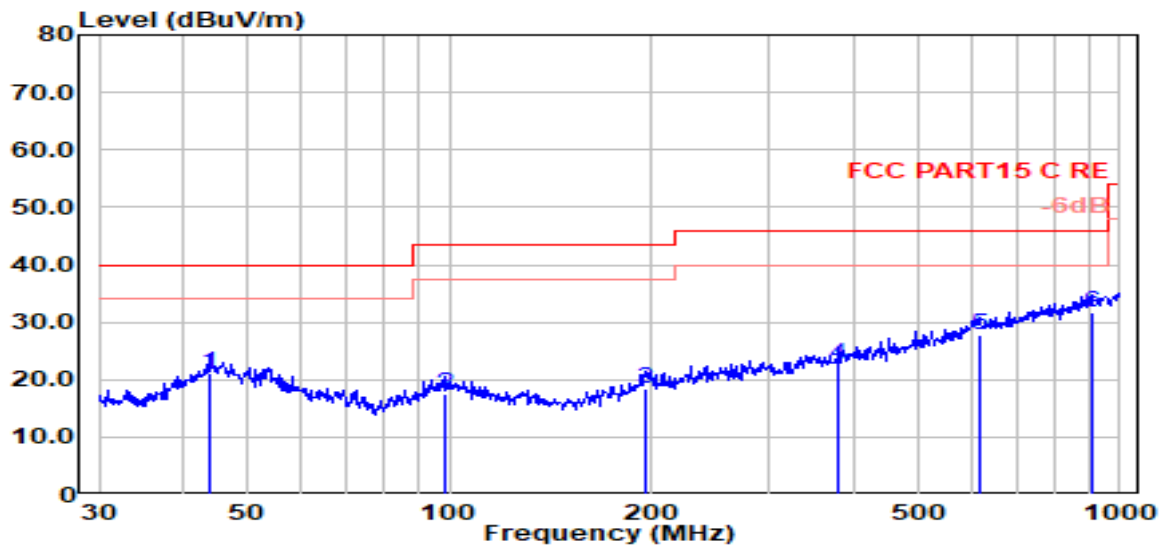

Item (Mark)	Freq. (MHz)	Read Level (dBUV)	Antenna Factor (dB/m)	Cable Loss (dB)	Result Level (dBUV/m)	Limit Line (dBUV/m)	Over Limit (dB)	Detector	Polarization
1	43.81	2.71	14.89	3.61	21.21	40.00	-18.79	QP	Vertical
2	98.83	2.16	11.50	3.97	17.63	43.50	-25.87	QP	Vertical
3	195.82	2.07	11.78	4.43	18.29	43.50	-25.21	QP	Vertical
4	381.25	2.66	14.95	5.09	22.70	46.00	-23.30	QP	Vertical
5	618.54	2.87	19.03	5.78	27.68	46.00	-18.32	QP	Vertical
6	906.48	2.89	22.23	6.49	31.61	46.00	-14.39	QP	Vertical

Note:

1. Result Level = Read Level + Antenna Factor + Cable loss.
2. If Peak Result complies with QP limit, QP Result is deemed to comply with QP limit.
3. Test setup: RBW: 120 kHz, VBW: 300 kHz, Sweep time: auto

Radiated Emission test (above 1 GHz) TR-4-E-009 Radiated Emission Test Result

Test Site : DDT 3m Chamber 3#
Test Date : 2022-01-06
EUT : SOUNDBAR
Power Supply : AC 120V/60Hz
Condition : Temp:22.6°,Humi:52.5%,Press:100.6kPa
Memo : SDR 5743

D:\2021 report data\Q21121302-1E JBL Bar 2.1\bar\FCC ABOVE 1G\FCC ABOVE 1G_00005.EMI
Tested By : James Gan
Model Number : Bar 2.1 Deep Bass CNTR
Test Mode : Tx Mode
Antenna/Distance : 2021 BBHA 9120D 3#
 NEW/3m/Vertical

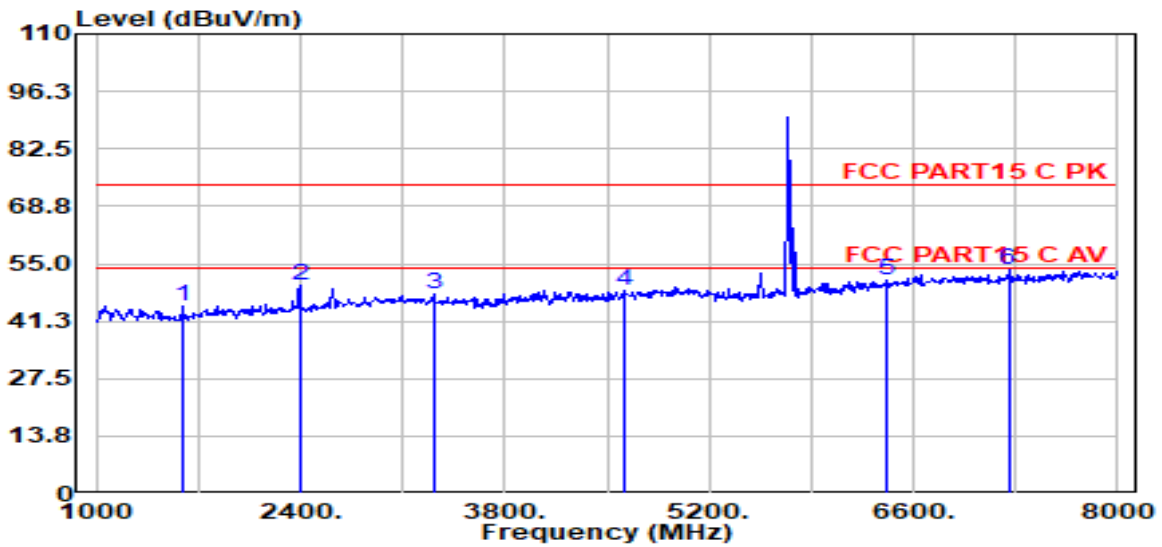

Item (Mark)	Freq. (MHz)	Read Level (dBuV)	Antenna Factor (dB/m)	Cable Loss (dB)	PRM Factor (dB)	Result Level (dBuV/m)	Limit Line (dBuV/m)	Over Limit (dB)	Detector	Polarization
1	1595.00	56.72	25.65	1.42	38.79	44.99	74.00	-29.01	Peak	Vertical
2	2393.00	60.49	27.41	1.71	39.60	50.02	74.00	-23.98	Peak	Vertical
3	3310.00	56.69	29.44	1.76	39.99	47.89	74.00	-26.11	Peak	Vertical
4	4612.00	54.81	31.86	2.40	40.32	48.75	74.00	-25.25	Peak	Vertical
5	6425.00	52.87	35.02	3.23	40.16	50.97	74.00	-23.03	Peak	Vertical
6	7251.00	53.89	36.20	3.08	39.73	53.45	74.00	-20.55	Peak	Vertical

Note:

1. Result Level = Read Level + Antenna Factor + Cable loss - PRM Factor.
2. If Peak Result complies with AV limit, AV Result is deemed to comply with AV limit.
3. Test setup: RBW: 1 MHz, VBW: 3 MHz, Sweep time: auto.

TR-4-E-009 Radiated Emission Test Result

Test Site : DDT 3m Chamber 3#

D:\2021 report data\Q21121302-1E JBL Bar
2.1\bar\FCC ABOVE 1G\FCC ABOVE 1G_00006.EMI

Test Date : 2022-01-06

Tested By : James Gan

EUT : SOUNDBAR

Model Number : Bar 2.1 Deep Bass CNTR

Power Supply : AC 120V/60Hz

Test Mode : Tx Mode

Condition : Temp:22.6°,Humi:52.5%,Press:100.6kPa

Antenna/Distance : 2021 BBHA 9120D 3#
NEW/3m/Horizontal

Memo : SDR 5743

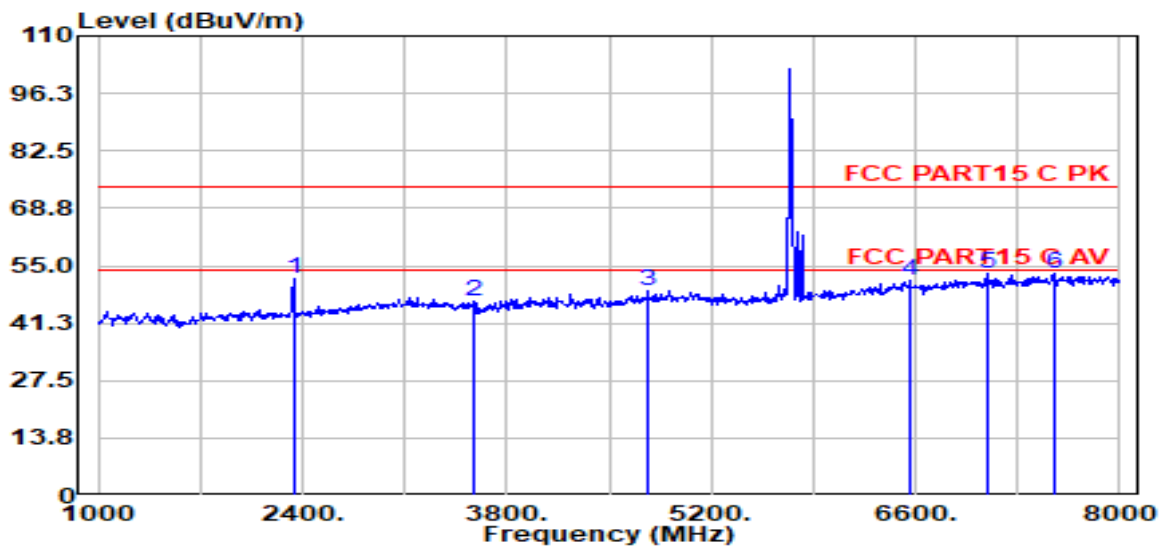

Item (Mark)	Freq. (MHz)	Read Level (dBuV)	Antenna Factor (dB/m)	Cable Loss (dB)	PRM Factor (dB)	Result Level (dBuV/m)	Limit Line (dBuV/m)	Over Limit (dB)	Detector	Polarization
1	2337.00	62.50	27.31	1.69	39.57	51.93	74.00	-22.07	Peak	Horizontal
2	3583.00	55.06	29.68	1.76	40.07	46.43	74.00	-27.57	Peak	Horizontal
3	4766.00	54.68	32.35	2.46	40.35	49.13	74.00	-24.87	Peak	Horizontal
4	6565.00	53.06	35.30	3.24	40.05	51.55	74.00	-22.45	Peak	Horizontal
5	7090.00	53.52	36.07	3.04	39.71	52.93	74.00	-21.07	Peak	Horizontal
6	7545.00	53.45	36.45	3.14	39.75	53.30	74.00	-20.70	Peak	Horizontal

Note:

1. Result Level = Read Level + Antenna Factor + Cable loss - PRM Factor.
2. If Peak Result complies with AV limit, AV Result is deemed to comply with AV limit.
3. Test setup: RBW: 1 MHz, VBW: 3 MHz, Sweep time: auto.

TR-4-E-009 Radiated Emission Test Result

Test Site : DDT 3m Chamber 3#

D:\2021 report data\Q21121302-1E JBL Bar
2.1\bar\FCC ABOVE 1G\FCC ABOVE 1G_00013.EMI

Test Date : 2022-01-06

Tested By : James Gan

EUT : SOUNDBAR

Model Number : Bar 2.1 Deep Bass CNTR

Power Supply : AC 120V/60Hz

Test Mode : Tx Mode

Condition : Temp:22.6°,Humi:52.5%,Press:100.6kPa **Antenna/Distance** : 2021 BBHA 9120D 3#
NEW/3m/Vertical

Memo : SRD 5787

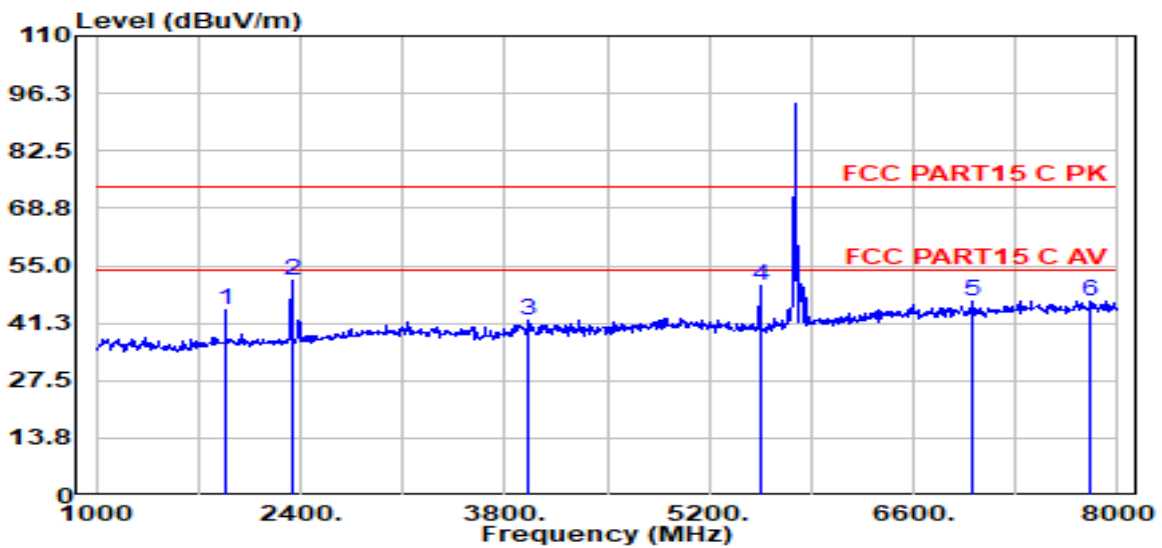

Item (Mark)	Freq. (MHz)	Read Level (dBμV)	Antenna Factor (dB/m)	Cable Loss (dB)	PRM Factor (dB)	Result Level (dBμV/m)	Limit Line (dBμV/m)	Over Limit (dB)	Detector	Polarization
1	1889.00	55.76	26.41	1.55	39.23	44.49	74.00	-29.51	Peak	Vertical
2	2337.00	61.91	27.31	1.69	39.57	51.34	74.00	-22.66	Peak	Vertical
3	3968.00	49.01	30.99	2.08	40.19	41.89	74.00	-32.11	Peak	Vertical
4	5550.00	55.31	32.92	2.62	40.46	50.39	74.00	-23.61	Peak	Vertical
5	6999.00	46.98	36.00	3.02	39.70	46.30	74.00	-27.70	Peak	Vertical
6	7818.00	46.40	36.78	3.17	39.78	46.57	74.00	-27.43	Peak	Vertical

Note:

1. Result Level = Read Level + Antenna Factor + Cable loss - PRM Factor.
2. If Peak Result complies with AV limit, AV Result is deemed to comply with AV limit.
3. Test setup: RBW: 1 MHz, VBW: 3 MHz, Sweep time: auto.

TR-4-E-009 Radiated Emission Test Result

Test Site : DDT 3m Chamber 3#

D:\2021 report data\Q21121302-1E JBL Bar
2.1\bar\FCC ABOVE 1G\FCC ABOVE 1G_00014.EMI

Test Date : 2022-01-06

Tested By : James Gan

EUT : SOUNDBAR

Model Number : Bar 2.1 Deep Bass CNTR

Power Supply : AC 120V/60Hz

Test Mode : Tx Mode

Condition : Temp:22.6°,Humi:52.5%,Press:100.6kPa **Antenna/Distance** : 2021 BBHA 9120D 3#
NEW/3m/Horizontal

Memo : SRD 5787

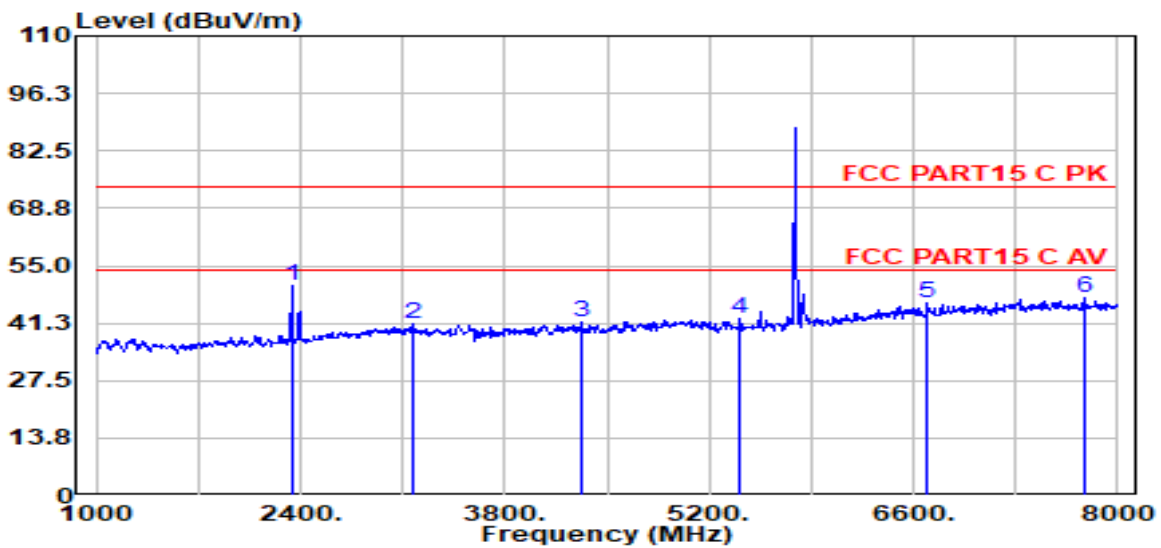

Item (Mark)	Freq. (MHz)	Read Level (dBμV)	Antenna Factor (dB/m)	Cable Loss (dB)	PRM Factor (dB)	Result Level (dBμV/m)	Limit Line (dBμV/m)	Over Limit (dB)	Detector	Polarization
1	2337.00	60.61	27.31	1.69	39.57	50.05	74.00	-23.95	Peak	Horizontal
2	3163.00	49.58	29.47	1.81	39.95	40.91	74.00	-33.09	Peak	Horizontal
3	4325.00	48.13	31.36	2.27	40.27	41.50	74.00	-32.50	Peak	Horizontal
4	5410.00	47.32	32.85	2.56	40.44	42.29	74.00	-31.71	Peak	Horizontal
5	6698.00	47.27	35.52	3.17	39.94	46.01	74.00	-27.99	Peak	Horizontal
6	7769.00	47.35	36.72	3.17	39.78	47.47	74.00	-26.53	Peak	Horizontal

Note:

1. Result Level = Read Level + Antenna Factor + Cable loss - PRM Factor.
2. If Peak Result complies with AV limit, AV Result is deemed to comply with AV limit.
3. Test setup: RBW: 1 MHz, VBW: 3 MHz, Sweep time: auto.

TR-4-E-009 Radiated Emission Test Result

Test Site : DDT 3m Chamber 3#

D:\2021 report data\Q21121302-1E JBL Bar 2.1\bar\FCC ABOVE 1G\FCC ABOVE 1G_00007.EMI

Test Date : 2022-01-06

Tested By : James Gan

EUT : SOUNDBAR

Model Number : Bar 2.1 Deep Bass CNTR

Power Supply : AC 120V/60Hz

Test Mode : Tx Mode

Condition : Temp:22.6°,Humi:52.5%,Press:100.6kPa **Antenna/Distance** : 2021 BBHA 9120D 3# NEW/3m/Horizontal

Memo : SRD 5832

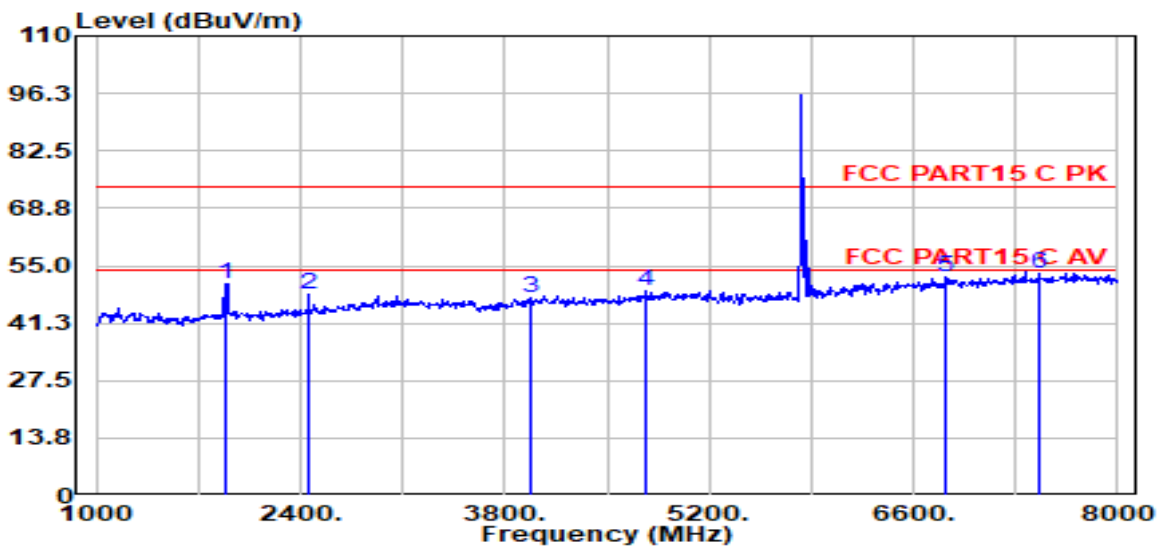

Item (Mark)	Freq. (MHz)	Read Level (dBμV)	Antenna Factor (dB/m)	Cable Loss (dB)	PRM Factor (dB)	Result Level (dBμV/m)	Limit Line (dBμV/m)	Over Limit (dB)	Detector	Polarization
1	1882.00	62.01	26.39	1.55	39.22	50.73	74.00	-23.27	Peak	Horizontal
2	2456.00	58.37	27.52	1.73	39.63	47.99	74.00	-26.01	Peak	Horizontal
3	3975.00	54.28	31.02	2.09	40.19	47.19	74.00	-26.81	Peak	Horizontal
4	4766.00	54.45	32.35	2.46	40.35	48.90	74.00	-25.10	Peak	Horizontal
5	6824.00	53.13	35.72	3.11	39.84	52.11	74.00	-21.89	Peak	Horizontal
6	7454.00	53.55	36.36	3.13	39.75	53.30	74.00	-20.70	Peak	Horizontal

Note:

1. Result Level = Read Level + Antenna Factor + Cable loss - PRM Factor.
2. If Peak Result complies with AV limit, AV Result is deemed to comply with AV limit.
3. Test setup: RBW: 1 MHz, VBW: 3 MHz, Sweep time: auto.

TR-4-E-009 Radiated Emission Test Result

Test Site : DDT 3m Chamber 3#

D:\2021 report data\Q21121302-1E JBL Bar
2.1\bar\FCC ABOVE 1G\FCC ABOVE 1G_00008.EMI

Test Date : 2022-01-06

Tested By : James Gan

EUT : SOUNDBAR

Model Number : Bar 2.1 Deep Bass CNTR

Power Supply : AC 120V/60Hz

Test Mode : Tx Mode

Condition : Temp:22.6°,Humi:52.5%,Press:100.6kPa **Antenna/Distance** : 2021 BBHA 9120D 3#
NEW/3m/Vertical

Memo : SRD 5832

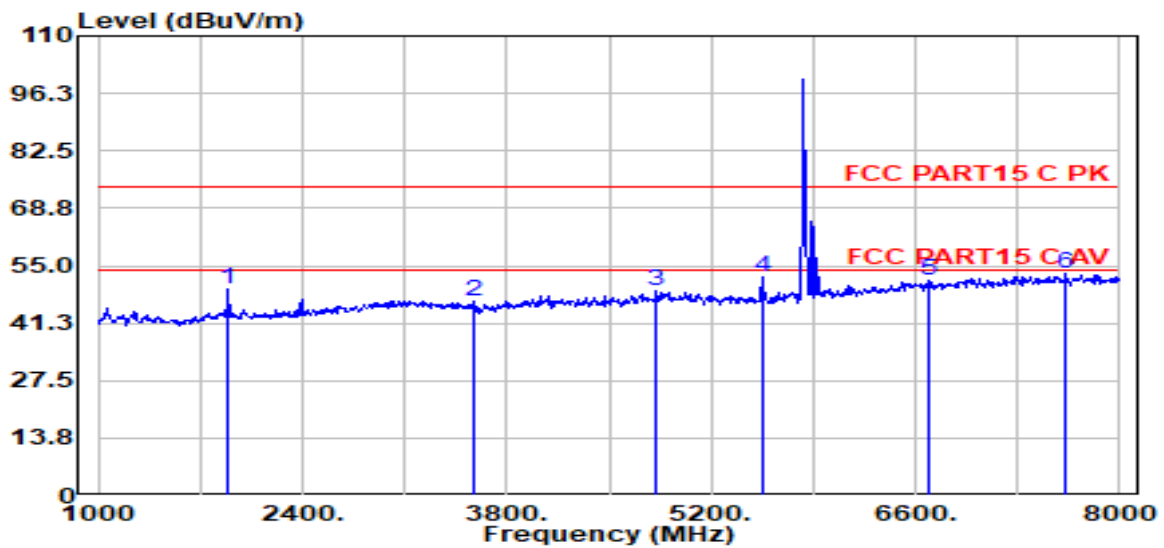

Item (Mark)	Freq. (MHz)	Read Level (dBμV)	Antenna Factor (dB/m)	Cable Loss (dB)	PRM Factor (dB)	Result Level (dBμV/m)	Limit Line (dBμV/m)	Over Limit (dB)	Detector	Polarization
1	1896.00	60.50	26.43	1.55	39.24	49.24	74.00	-24.76	Peak	Vertical
2	3576.00	55.01	29.66	1.75	40.07	46.35	74.00	-27.65	Peak	Vertical
3	4829.00	54.35	32.55	2.48	40.37	49.02	74.00	-24.98	Peak	Vertical
4	5550.00	57.38	32.92	2.62	40.46	52.46	74.00	-21.54	Peak	Vertical
5	6684.00	52.83	35.49	3.18	39.95	51.55	74.00	-22.45	Peak	Vertical
6	7629.00	53.14	36.55	3.15	39.76	53.09	74.00	-20.91	Peak	Vertical

Note:

1. Result Level = Read Level + Antenna Factor + Cable loss - PRM Factor.
2. If Peak Result complies with AV limit, AV Result is deemed to comply with AV limit.
3. Test setup: RBW: 1 MHz, VBW: 3 MHz, Sweep time: auto.

TR-4-E-009 Radiated Emission Test Result

Test Site : DDT 3m Chamber 3#

D:\2021 report data\Q21121302-1E JBL Bar
2.1\bar\FCC ABOVE 1G\FCC ABOVE 1G_00017.EMI

Test Date : 2022-01-05

Tested By : James Gan

EUT : SOUNDBAR

Model Number : Bar 2.1 Deep Bass CNTR

Power Supply : AC 120V/60Hz

Test Mode : Tx Mode

Condition : Temp:22.6°,Humi:52.5%,Press:100.6kPa **Antenna/Distance** : 2021 BBHA 9120D 3#
NEW/3m/Vertical

Memo : SRD 5743

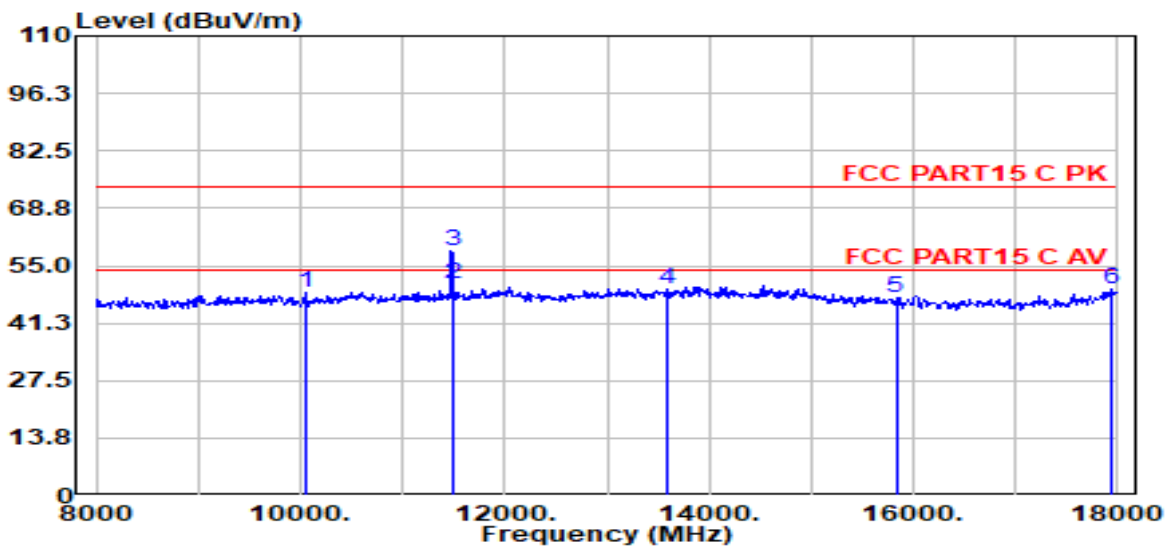

Item (Mark)	Freq. (MHz)	Read Level (dBμV)	Antenna Factor (dB/m)	Cable Loss (dB)	PRM Factor (dB)	Result Level (dBμV/m)	Limit Line (dBμV/m)	Over Limit (dB)	Detector	Polarization	
1	10060.00	46.89	38.47	3.67	40.58	48.45	74.00	-25.55	Peak	Vertical	
2	11486.00	58.46-17.19=41.27						54.00	-12.73	Average	Vertical
3	11486.00	55.64	39.01	3.97	40.15	58.46	74.00	-15.54	Peak	Vertical	
4	13600.00	45.29	39.98	4.10	39.98	49.39	74.00	-24.61	Peak	Vertical	
5	15830.00	44.48	38.21	4.59	39.85	47.42	74.00	-26.58	Peak	Vertical	
6	17930.00	42.89	42.07	4.94	40.66	49.24	74.00	-24.76	Peak	Vertical	

Note:

1. Result Level = Read Level + Antenna Factor + Cable loss - PRM Factor.
2. If Peak Result complies with AV limit, AV Result is deemed to comply with AV limit.
3. Test setup: RBW: 1 MHz, VBW: 3 MHz, Sweep time: auto.
4. AV Level = PK Level + PDCF, PDCF= -17.19

TR-4-E-009 Radiated Emission Test Result

Test Site : DDT 3m Chamber 3#

D:\2021 report data\Q21121302-1E JBL Bar
2.1\bar\FCC ABOVE 1G\FCC ABOVE 1G_00018.EMI

Test Date : 2022-01-05

Tested By : James Gan

EUT : SOUNDBAR

Model Number : Bar 2.1 Deep Bass CNTR

Power Supply : AC 120V/60Hz

Test Mode : Tx Mode

Condition : Temp:22.6°,Humi:52.5%,Press:100.6kPa

Antenna/Distance : 2021 BBHA 9120D 3#
NEW/3m/Horizontal

Memo : SRD 5743

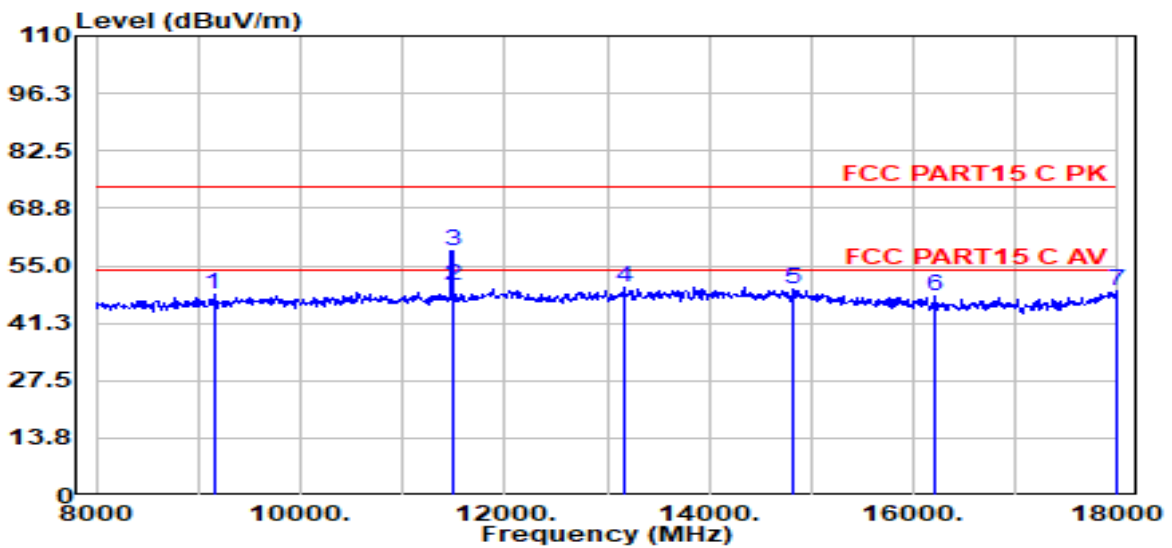

Item (Mark)	Freq. (MHz)	Read Level (dB μ V)	Antenna Factor (dB/m)	Cable Loss (dB)	PRM Factor (dB)	Result Level (dB μ V/m)	Limit Line (dB μ V/m)	Over Limit (dB)	Detector	Polarization	
1	9150.00	46.13	38.42	3.42	40.01	47.96	74.00	-26.04	Peak	Horizontal	
2	11486.00	58.65-17.19=41.46						54.00	-12.54	Average	Horizontal
3	11486.00	55.83	39.01	3.97	40.15	58.65	74.00	-15.35	Peak	Horizontal	
4	13160.00	45.93	39.73	4.27	40.29	49.63	74.00	-24.37	Peak	Horizontal	
5	14820.00	44.91	39.64	4.43	39.62	49.36	74.00	-24.64	Peak	Horizontal	
6	16210.00	45.18	37.90	4.65	39.94	47.79	74.00	-26.21	Peak	Horizontal	
7	17980.00	42.48	42.38	4.95	40.69	49.12	74.00	-24.88	Peak	Horizontal	

Note:

1. Result Level = Read Level + Antenna Factor + Cable loss - PRM Factor.
2. If Peak Result complies with AV limit, AV Result is deemed to comply with AV limit.
3. Test setup: RBW: 1 MHz, VBW: 3 MHz, Sweep time: auto.
4. AV Level = PK Level + PDCF, PDCF= -17.19

TR-4-E-009 Radiated Emission Test Result

Test Site : DDT 3m Chamber 3#

D:\2021 report data\Q21121302-1E JBL Bar
2.1\bar\FCC ABOVE 1G\FCC ABOVE 1G_00019.EMI

Test Date : 2022-01-06

Tested By : James Gan

EUT : SOUNDBAR

Model Number : Bar 2.1 Deep Bass CNTR

Power Supply : AC 120V/60Hz

Test Mode : Tx Mode

Condition : Temp:22.6°,Humi:52.5%,Press:100.6kPa **Antenna/Distance** : 2021 BBHA 9120D 3#
NEW/3m/Horizontal

Memo : SRD 5787

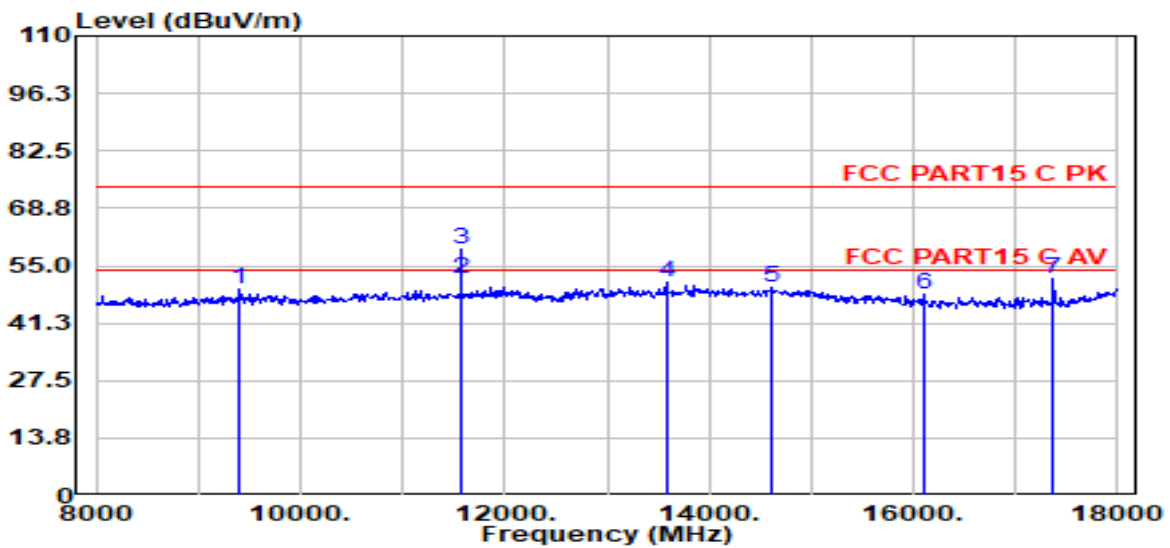

Item (Mark)	Freq. (MHz)	Read Level (dBuV)	Antenna Factor (dB/m)	Cable Loss (dB)	PRM Factor (dB)	Result Level (dBuV/m)	Limit Line (dBuV/m)	Over Limit (dB)	Detector	Polarization
1	9410.00	47.30	38.63	3.57	40.19	49.31	74.00	-24.69	Peak	Horizontal
2	11574.00	59.15-17.19=41.96					54.00	-12.04	Average	Horizontal
3	11574.00	56.28	39.03	3.98	40.14	59.15	74.00	-14.85	Peak	Horizontal
4	13580.00	46.80	39.98	4.08	39.99	50.86	74.00	-23.14	Peak	Horizontal
5	14620.00	45.27	39.80	4.38	39.64	49.82	74.00	-24.18	Peak	Horizontal
6	16100.00	45.62	37.90	4.63	39.92	48.23	74.00	-25.77	Peak	Horizontal
7	17360.00	48.20	39.15	4.79	40.32	51.82	74.00	-22.18	Peak	Horizontal

Note:

1. Result Level = Read Level + Antenna Factor + Cable loss - PRM Factor.
2. If Peak Result complies with AV limit, AV Result is deemed to comply with AV limit.
3. Test setup: RBW: 1 MHz, VBW: 3 MHz, Sweep time: auto.
4. AV Level = PK Level + PDCF, PDCF= -17.19

TR-4-E-009 Radiated Emission Test Result

Test Site : DDT 3m Chamber 3#

D:\2021 report data\Q21121302-1E JBL Bar
2.1\bar\FCC ABOVE 1G\FCC ABOVE 1G_00020.EMI

Test Date : 2022-01-06

Tested By : James Gan

EUT : SOUNDBAR

Model Number : Bar 2.1 Deep Bass CNTR

Power Supply : AC 120V/60Hz

Test Mode : Tx Mode

Condition : Temp:22.6°,Humi:52.5%,Press:100.6kPa **Antenna/Distance** : 2021 BBHA 9120D 3#
NEW/3m/Vertical

Memo : SRD 5787

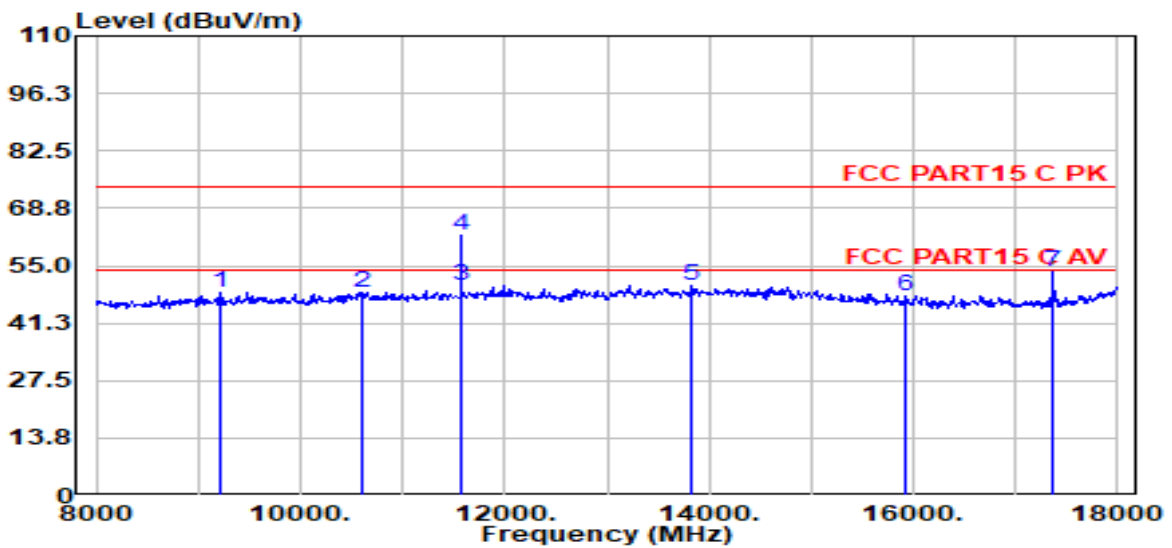

Item (Mark)	Freq. (MHz)	Read Level (dBμV)	Antenna Factor (dB/m)	Cable Loss (dB)	PRM Factor (dB)	Result Level (dBμV/m)	Limit Line (dBμV/m)	Over Limit (dB)	Detector	Polarization
1	9220.00	46.70	38.48	3.46	40.05	48.58	74.00	-25.42	Peak	Vertical
2	10600.00	46.36	39.06	3.70	40.36	48.75	74.00	-25.25	Peak	Vertical
3	11574.00	62.13-17.19=44.94					54.00	-9.06	Average	Vertical
4	11574.00	59.26	39.03	3.98	40.14	62.13	74.00	-11.87	Peak	Vertical
5	13830.00	45.93	39.93	4.35	39.82	50.39	74.00	-23.61	Peak	Vertical
6	15930.00	44.99	38.03	4.59	39.88	47.73	74.00	-26.27	Peak	Vertical
7	17360.00	49.93	39.15	4.79	40.32	53.55	74.00	-20.45	Peak	Vertical

Note:

1. Result Level = Read Level + Antenna Factor + Cable loss - PRM Factor.
2. If Peak Result complies with AV limit, AV Result is deemed to comply with AV limit.
3. Test setup: RBW: 1 MHz, VBW: 3 MHz, Sweep time: auto.
4. AV Level = PK Level + PDCF, PDCF= -17.19

TR-4-E-009 Radiated Emission Test Result

Test Site : DDT 3m Chamber 3#

D:\2021 report data\Q21121302-1E JBL Bar
2.1\bar\FCC ABOVE 1G\FCC ABOVE 1G_00021.EMI

Test Date : 2022-01-06

Tested By : James Gan

EUT : SOUNDBAR

Model Number : Bar 2.1 Deep Bass CNTR

Power Supply : AC 120V/60Hz

Test Mode : Tx Mode

Condition : Temp:22.6°,Humi:52.5%,Press:100.6kPa

Antenna/Distance : 2021 BBHA 9120D 3#
NEW/3m/Vertical

Memo : SRD 5832

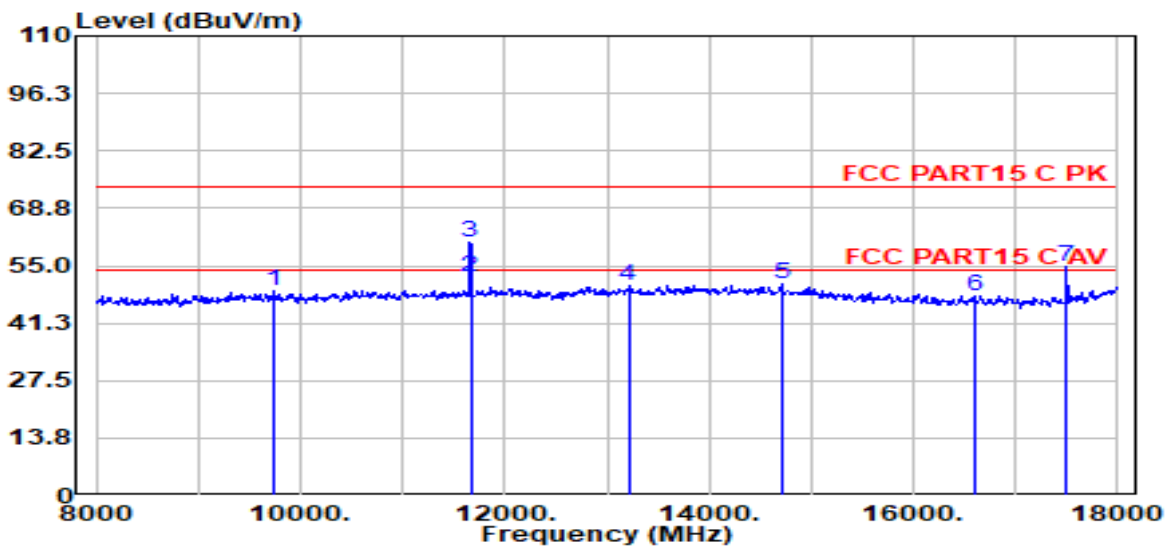

Item (Mark)	Freq. (MHz)	Read Level (dBμV)	Antenna Factor (dB/m)	Cable Loss (dB)	PRM Factor (dB)	Result Level (dBμV/m)	Limit Line (dBμV/m)	Over Limit (dB)	Detector	Polarization	
1	9730.00	47.06	38.56	3.64	40.41	48.86	74.00	-25.14	Peak	Vertical	
2	11664.00	60.56-17.19=43.37						54.00	-10.63	Average	Vertical
3	11664.00	57.63	39.07	4.00	40.13	60.56	74.00	-13.44	Peak	Vertical	
4	13210.00	46.60	39.77	4.23	40.25	50.34	74.00	-23.66	Peak	Vertical	
5	14710.00	46.30	39.73	4.40	39.63	50.81	74.00	-23.19	Peak	Vertical	
6	16600.00	45.02	38.02	4.73	40.02	47.74	74.00	-26.26	Peak	Vertical	
7	17500.00	51.12	39.40	4.82	40.40	54.94	74.00	-19.06	Peak	Vertical	
7	17500.00	54.94-17.19=37.75						54.00	-16.25	Average	Vertical

Note:

1. Result Level = Read Level + Antenna Factor + Cable loss - PRM Factor.
2. If Peak Result complies with AV limit, AV Result is deemed to comply with AV limit.
3. Test setup: RBW: 1 MHz, VBW: 3 MHz, Sweep time: auto.
4. AV Level = PK Level + PDCF, PDCF= -17.19

TR-4-E-009 Radiated Emission Test Result

Test Site : DDT 3m Chamber 3#

D:\2021 report data\Q21121302-1E JBL Bar
2.1\bar\FCC ABOVE 1G\FCC ABOVE 1G_0022.EMI

Test Date : 2022-01-06

Tested By : James Gan

EUT : SOUNDBAR

Model Number : Bar 2.1 Deep Bass CNTR

Power Supply : AC 120V/60Hz

Test Mode : Tx Mode

Condition : Temp:22.6°,Humi:52.5%,Press:100.6kPa

Antenna/Distance : 2021 BBHA 9120D 3#
NEW/3m/Horizontal

Memo : SRD 5832

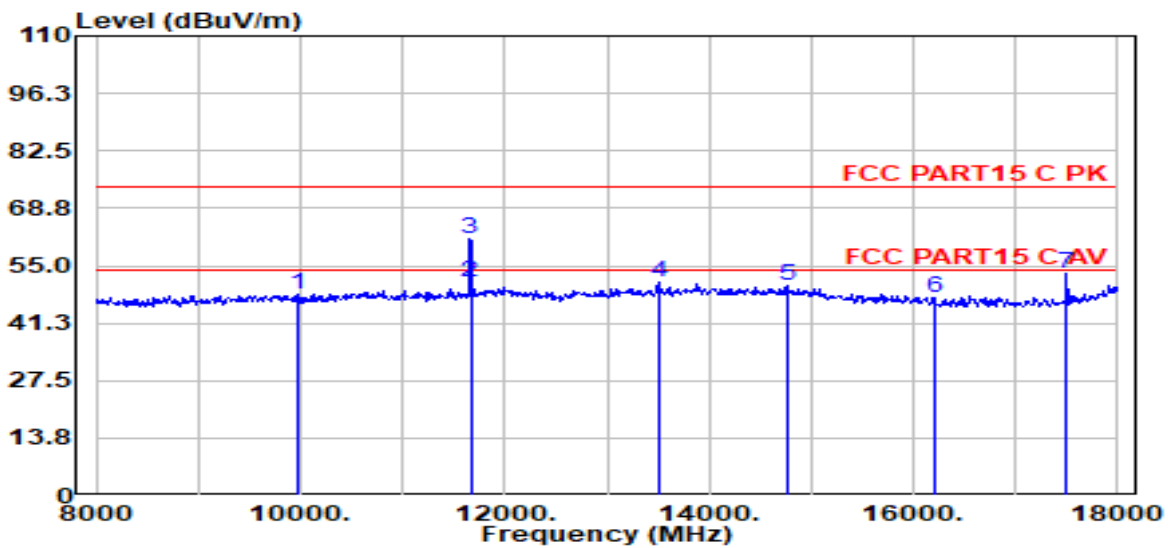

Item (Mark)	Freq. (MHz)	Read Level (dBμV)	Antenna Factor (dB/m)	Cable Loss (dB)	PRM Factor (dB)	Result Level (dBUV/m)	Limit Line (dBUV/m)	Over Limit (dB)	Detector	Polarization
1	9970.00	46.78	38.42	3.67	40.58	48.28	74.00	-25.72	Peak	Horizontal
2	11664.00	61.36-17.19=44.17					54.00	-9.83	Average	Horizontal
3	11664.00	58.43	39.07	4.00	40.13	61.36	74.00	-12.64	Peak	Horizontal
4	13520.00	47.00	40.00	4.01	40.04	50.97	74.00	-23.03	Peak	Horizontal
5	14770.00	45.74	39.68	4.41	39.62	50.21	74.00	-23.79	Peak	Horizontal
6	16200.00	44.83	37.90	4.65	39.94	47.44	74.00	-26.56	Peak	Horizontal
7	17500.00	49.42	39.40	4.82	40.40	53.24	74.00	-20.76	Peak	Horizontal

Note:

1. Result Level = Read Level + Antenna Factor + Cable loss - PRM Factor.
2. If Peak Result complies with AV limit, AV Result is deemed to comply with AV limit.
3. Test setup: RBW: 1 MHz, VBW: 3 MHz, Sweep time: auto.
4. AV Level = PK Level + PDCF, PDCF= -17.19

7. Band Edge Compliance

7.1. Block diagram of test setup

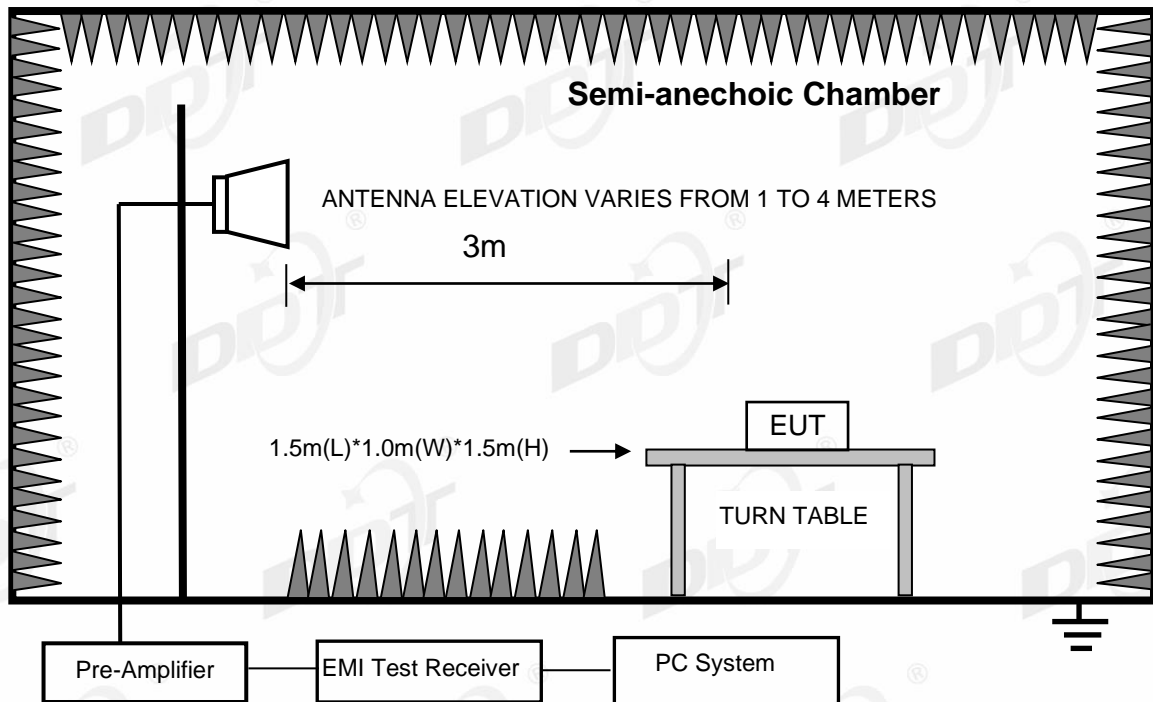

7.2. Limit

Emissions radiated outside of the specified frequency bands, except for harmonics, shall be attenuated by at least 50 dB below the level of the fundamental or to the general radiated emission limits in §15.209, whichever is the lesser attenuation.

7.3. Test procedure

Same with clause 5.3 except change investigated frequency range from 5710 MHz to 5750 MHz and 5822 MHz to 5885 MHz.

Remark: All restriction band have been tested, and only the worst case is shown in report.

7.4. Test result

Pass. (See below detailed test result)

TR-4-E-009 Radiated Emission Test Result

Test Site : DDT 3m Chamber 3#

D:\2021 report data\Q21121302-1E JBL Bar
2.1\bar\FCC ABOVE 1G\FCC ABOVE 1G_00003.EMI

Test Date : 2022-01-05

Tested By : James Gan

EUT : SOUNDBAR

Model Number : Bar 2.1 Deep Bass CNTR

Power Supply : AC 120V/60Hz

Test Mode : Tx Mode

Condition : Temp:22.6°,Humi:52.5%,Press:100.6kPa

Antenna/Distance : 2021 BBHA 9120D 3#
NEW/3m/Horizontal

Memo : SDR 5743

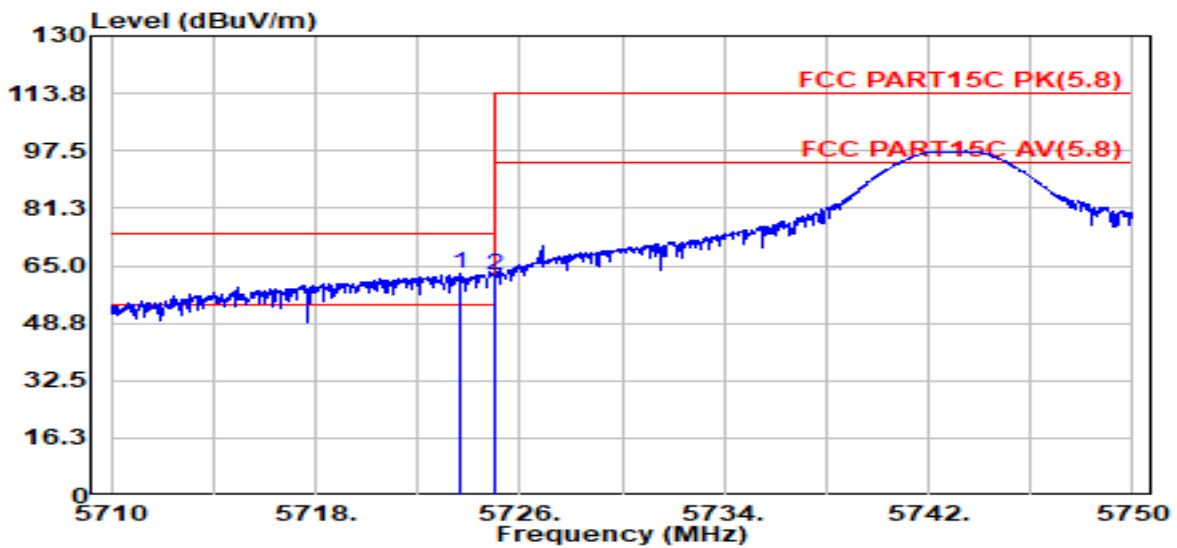

Item (Mark)	Freq. (MHz)	Read Level (dBuV)	Antenna Factor (dB/m)	Cable Loss (dB)	PRM Factor (dB)	Result Level (dBuV/m)	Limit Line (dBuV/m)	Over Limit (dB)	Detector	Polarization	
1	5723.64	67.03	33.34	2.78	40.47	62.67	74.00	-11.33	Peak	Horizontal	
1	5723.64	62.67-17.19=45.48						54.00	-8.52	Average	Horizontal
2	5725.00	66.63	33.34	2.78	40.47	62.28	74.00	-11.72	Peak	Horizontal	
2	5725.00	62.28-17.19=45.09						44.00	-8.91	Average	Horizontal

Note:

1. Result Level = Read Level + Antenna Factor + Cable loss - PRM Factor.
2. If Peak Result complies with AV limit, AV Result is deemed to comply with AV limit.
3. Test setup: RBW: 1 MHz, VBW: 3 MHz, Sweep time: auto.
4. AV Level = PK Level + PDCF, PDCF= -17.19

TR-4-E-009 Radiated Emission Test Result

Test Site : DDT 3m Chamber 3#

D:\2021 report data\Q21121302-1E JBL Bar
2.1\bar\FCC ABOVE 1G\FCC ABOVE 1G_00004.EMI

Test Date : 2022-01-05

Tested By : James Gan

EUT : SOUNDBAR

Model Number : Bar 2.1 Deep Bass CNTR

Power Supply : AC 120V/60Hz

Test Mode : Tx Mode

Condition : Temp:22.6°,Humi:52.5%,Press:100.6kPa **Antenna/Distance** : 2021 BBHA 9120D 3#
NEW/3m/Vertical

Memo : SDR 5743

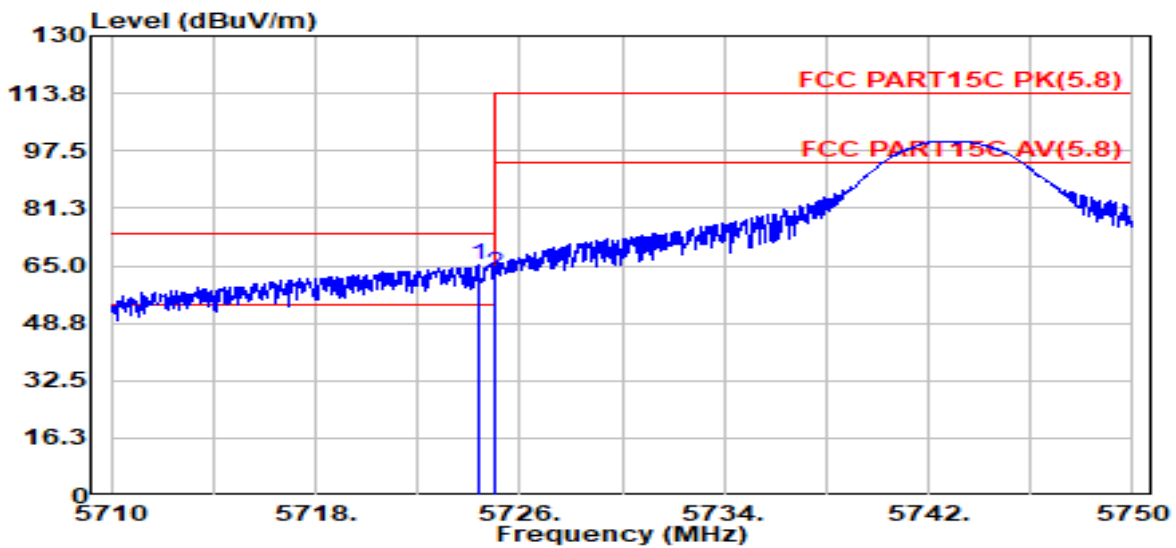

Item (Mark)	Freq. (MHz)	Read Level (dBuV)	Antenna Factor (dB/m)	Cable Loss (dB)	PRM Factor (dB)	Result Level (dBuV/m)	Limit Line (dBuV/m)	Over Limit (dB)	Detector	Polarization
1	5724.40	69.43	33.34	2.78	40.47	65.07	74.00	-8.93	Peak	Vertical
1	5724.40	65.07-17.19=47.88					54.00	-6.12	Average	Vertical
2	5725.00	67.05	33.34	2.78	40.47	62.69	74.00	-11.31	Peak	Vertical
2	5725.00	62.69-17.19=45.50					54.00	-8.50	Average	Vertical

Note:

1. Result Level = Read Level + Antenna Factor + Cable loss - PRM Factor.
2. If Peak Result complies with AV limit, AV Result is deemed to comply with AV limit.
3. Test setup: RBW: 1 MHz, VBW: 3 MHz, Sweep time: auto.
4. AV Level = PK Level + PDCF, PDCF= -17.19

TR-4-E-009 Radiated Emission Test Result

Test Site : DDT 3m Chamber 3#

D:\2021 report data\Q21121302-1E JBL Bar
2.1\bar\FCC ABOVE 1G\FCC ABOVE 1G_00011.EMI

Test Date : 2022-01-05

Tested By : James Gan

EUT : SOUNDBAR

Model Number : Bar 2.1 Deep Bass CNTR

Power Supply : AC 120V/60Hz

Test Mode : Tx Mode

Condition : Temp:22.6°,Humi:52.5%,Press:100.6kPa

Antenna/Distance : 2021 BBHA 9120D 3#
NEW/3m/Horizontal

Memo : SRD 5832

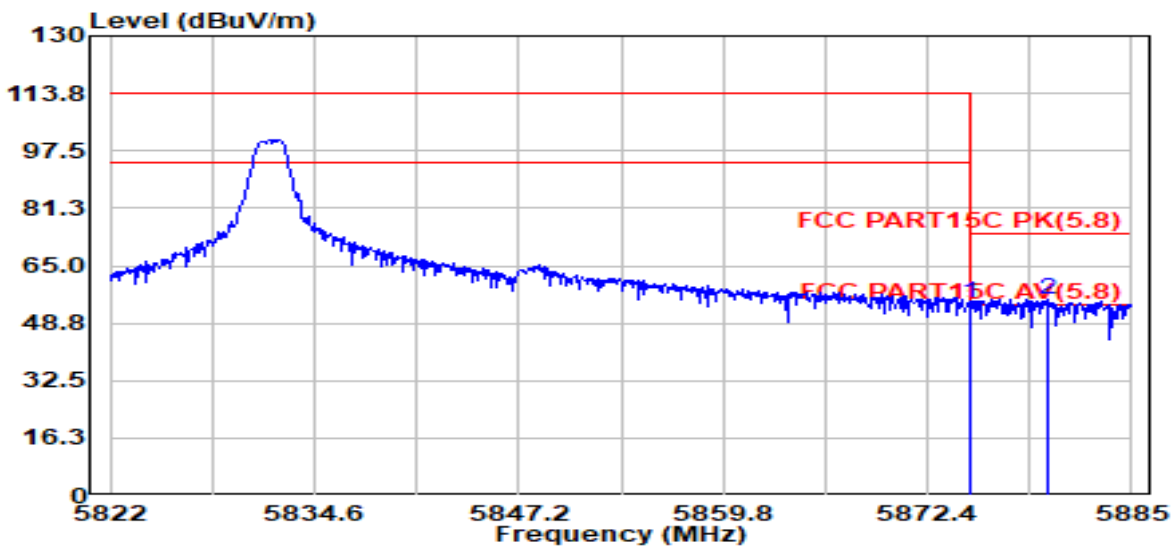

Item (Mark)	Freq. (MHz)	Read Level (dBUV)	Antenna Factor (dB/m)	Cable Loss (dB)	PRM Factor (dB)	Result Level (dBUV/m)	Limit Line (dBUV/m)	Over Limit (dB)	Detector	Polarization
1	5875.00	58.48	33.70	2.91	40.49	54.61	74.00	-19.39	Peak	Horizontal
1	5875.00	54.61-17.19=37.42					54.00	-16.58	Average	Horizontal
2	5879.77	59.52	33.71	2.92	40.49	55.66	74.00	-18.34	Peak	Horizontal
2	5879.77	55.66-17.19=38.47					54.00	-15.53	Average	Horizontal

Note:

1. Result Level = Read Level + Antenna Factor + Cable loss - PRM Factor.
2. If Peak Result complies with AV limit, AV Result is deemed to comply with AV limit.
3. Test setup: RBW: 1 MHz, VBW: 3 MHz, Sweep time: auto.
4. AV Level = PK Level + PDCF, PDCF= -17.19

TR-4-E-009 Radiated Emission Test Result

Test Site : DDT 3m Chamber 3#

D:\2021 report data\Q21121302-1E JBL Bar
2.1\bar\FCC ABOVE 1G\FCC ABOVE 1G_00012.EMI

Test Date : 2022-01-05

Tested By : James Gan

EUT : SOUNDBAR

Model Number : Bar 2.1 Deep Bass CNTR

Power Supply : AC 120V/60Hz

Test Mode : Tx Mode

Condition : Temp:22.6°,Humi:52.5%,Press:100.6kPa **Antenna/Distance** : 2021 BBHA 9120D 3#
NEW/3m/Vertical

Memo : SRD 5832

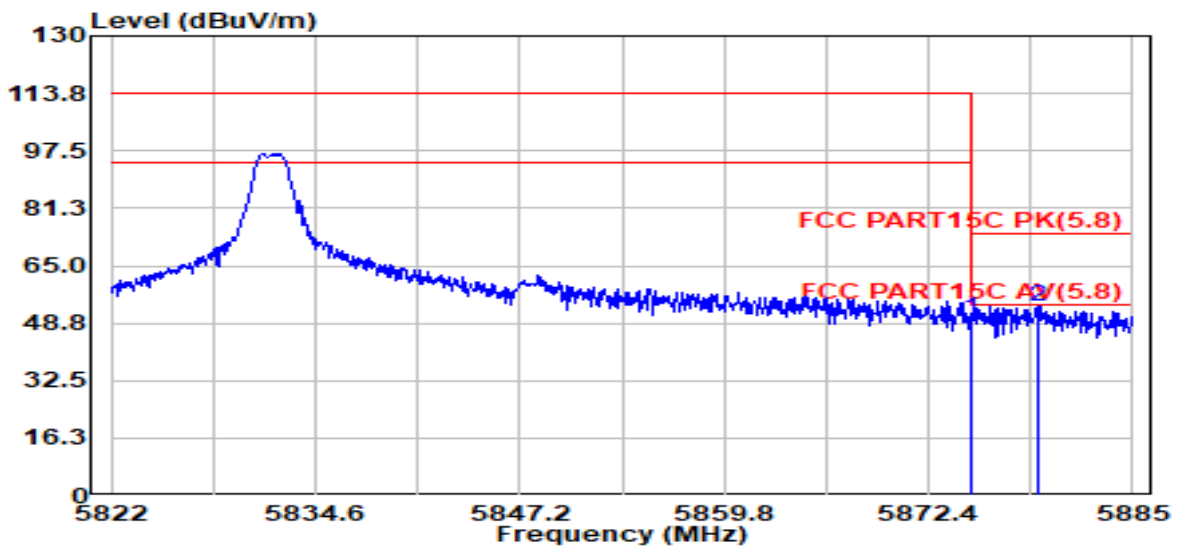

Item (Mark)	Freq. (MHz)	Read Level (dBUV)	Antenna Factor (dB/m)	Cable Loss (dB)	PRM Factor (dB)	Result Level (dBUV/m)	Limit Line (dBUV/m)	Over Limit (dB)	Detector	Polarization
1	5875.00	54.08	33.70	2.91	40.49	50.20	74.00	-23.80	Peak	Vertical
2	5879.14	57.42	33.71	2.92	40.49	53.56	74.00	-20.44	Peak	Vertical

Note:

1. Result Level = Read Level + Antenna Factor + Cable loss - PRM Factor.
2. If Peak Result complies with AV limit, AV Result is deemed to comply with AV limit.
3. Test setup: RBW: 1 MHz, VBW: 3 MHz, Sweep time: auto.
4. AV Level = PK Level + PDCF, PDCF= -17.19

8. Power Line Conducted Emission

8.1. Block diagram of test setup

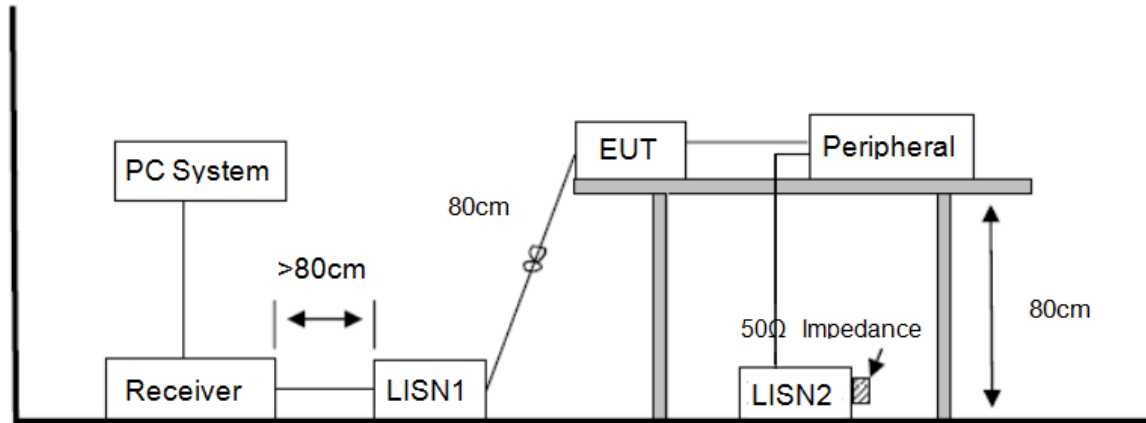

8.2. Power line conducted emission limits

Frequency	Quasi-Peak Level dB(μ V)	Average Level dB(μ V)
150 kHz ~ 500 kHz	66 ~ 56*	56 ~ 46*
500 kHz ~ 5 MHz	56	46
5 MHz ~ 30 MHz	60	50

Note 1: * Decreasing linearly with logarithm of frequency.

Note 2: The lower limit shall apply at the transition frequencies.

8.3. Test procedure

The EUT and Support equipment, if needed, were put placed on a non-metallic table, 80 cm above the ground plane.

Configuration EUT to simulate typical usage as described in clause 2.4 and test equipment as described in clause 7.1 of this report.

All I/O cables were positioned to simulate typical actual usage as per ANSI C63.10.

All support equipment power received from a second LISN.

Emissions were measured on each current carrying line of the EUT using an EMI Test Receiver connected to the LISN powering the EUT.

The Receiver scanned from 150 kHz to 30 MHz for emissions in each of the test modes.

During the above scans, the emissions were maximized by cable manipulation.

The test mode(s) described in clause 2.4 were scanned during the preliminary test.

After the preliminary scan, we found the test mode producing the highest emission level. The EUT configuration and worse cable configuration of the above highest emission levels were

recorded for reference of the final test.

EUT and support equipment were set up on the test bench as per the configuration with highest emission level in the preliminary test.

A scan was taken on both power lines, Neutral and Line, recording at least the six highest emissions.

Emission frequency and amplitude were recorded into a computer in which correction factors were used to calculate the emission level and compare reading to the applicable limit.

The test data of the worst-case condition(s) was recorded.

The bandwidth of test receiver is set at 9 kHz.

8.4. Test result

Pass. (See below detailed test result)

Note1: All emissions not reported below are too low against the prescribed limits.

Note2: "----" means Peak detection; "----" means Average detection.

Note3: Pre-test AC conducted emission at both voltage AC 120V/60Hz and AC 240V/60Hz, recorded worst case.

TR-4-E-010 Conducted Emission Test Result

Test Site : DDT 5# Shield Room D:\2021 report data\Q21121302-2E\FCC-CE.EM6
Test Date : 2022-01-07 **Tested By** : Kennys Zhang
EUT : SOUNDBAR **Model Number** : Bar 2.1 Deep Bass CNTR
Power Supply : AC 120V/60Hz **Test Mode** : Tx Mode
Condition : Temp:23.0°C,Humi:45.8%,Press:101.4kPa **LISN** : 2021 ENV 216 3#/LINE

Memo :

Data: 6

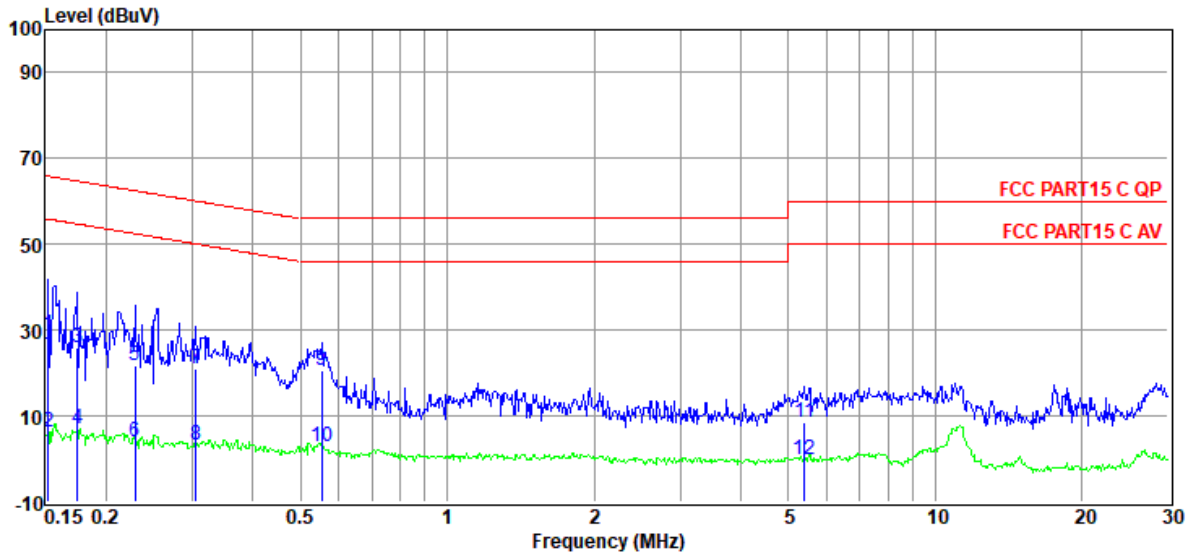

Item (Mark)	Freq. (MHz)	Read Level (dBμV)	LISN Factor (dB)	Cable Loss (dB)	Result Level (dBμV)	Limit Line (dBμV)	Over Limit (dB)	Detector	Phase
1	0.15	9.69	9.50	9.84	29.03	65.87	-36.84	QP	LINE
2	0.15	-12.94	9.50	9.84	6.40	55.87	-49.47	Average	LINE
3	0.17	6.69	9.50	9.83	26.02	64.72	-38.70	QP	LINE
4	0.17	-12.34	9.50	9.83	6.99	54.72	-47.73	Average	LINE
5	0.23	2.26	9.50	9.83	21.59	62.48	-40.89	QP	LINE
6	0.23	-15.36	9.50	9.83	3.97	52.48	-48.51	Average	LINE
7	0.31	1.57	9.50	9.83	20.90	60.10	-39.20	QP	LINE
8	0.31	-16.13	9.50	9.83	3.20	50.10	-46.90	Average	LINE
9	0.55	1.26	9.50	9.84	20.60	56.00	-35.40	QP	LINE
10	0.55	-16.36	9.50	9.84	2.98	46.00	-43.02	Average	LINE
11	5.39	-10.75	9.51	9.94	8.70	60.00	-51.30	QP	LINE
12	5.39	-19.72	9.51	9.94	-0.27	50.00	-50.27	Average	LINE

- Note: 1. Result Level = Read Level + LISN Factor + Cable loss.
 2. If QP Result complies with AV limit, AV Result is deemed to comply with AV limit.
 3. Test setup: RBW: 200 Hz (9 kHz—150 kHz), 9 kHz (150 kHz—30 MHz).
 4. Step size: 80Hz (0.009MHz-0.15MHz), 4 kHz (0.15MHz-30MHz), Scan time: auto.

TR-4-E-010 Conducted Emission Test Result

Test Site : DDT 5# Shield Room D:\2021 report data\Q21121302-2E\FCC-CE.EM6
Test Date : 2022-01-07 **Tested By** : Kennys Zhang
EUT : SOUNDBAR **Model Number** : Bar 2.1 Deep Bass CNTR
Power Supply : AC 120V/60Hz **Test Mode** : Tx Mode
Condition : Temp:23.0°C,Humi:45.8%,Press:101.4kPa **LISN** : 2021 ENV 216 3#/NEUTRAL

Memo :

Data: 8

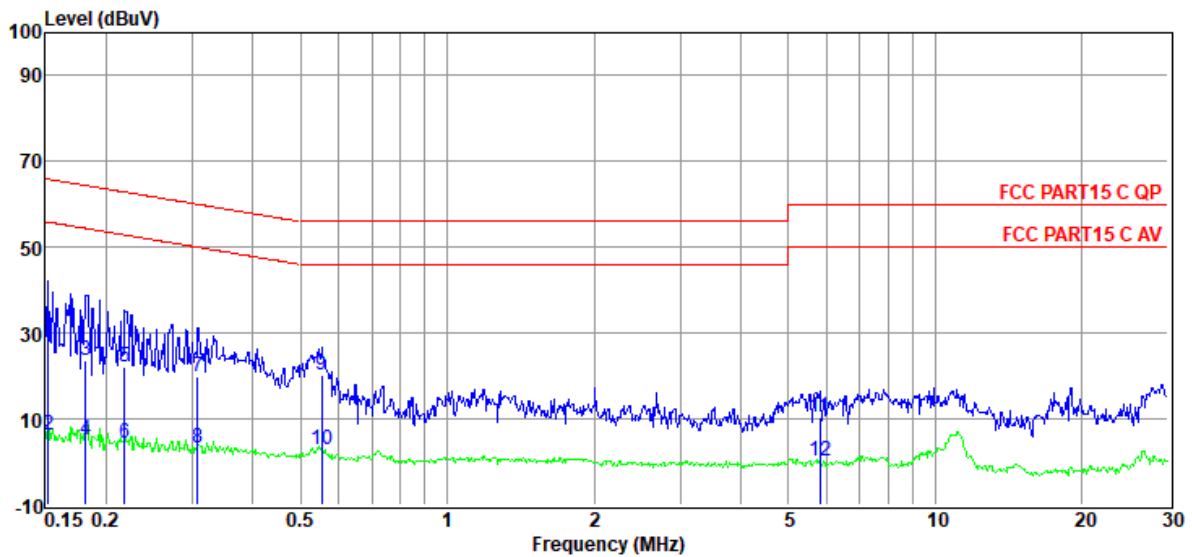

Item (Mark)	Freq. (MHz)	Read Level (dBμV)	LISN Factor (dB)	Cable Loss (dB)	Result Level (dBμV)	Limit Line (dBμV)	Over Limit (dB)	Detector	Phase
1	0.15	9.55	9.31	9.84	28.70	65.87	-37.17	QP	NEUTRAL
2	0.15	-12.78	9.31	9.84	6.37	55.87	-49.50	Average	NEUTRAL
3	0.18	4.62	9.37	9.83	23.82	64.42	-40.60	QP	NEUTRAL
4	0.18	-14.12	9.37	9.83	5.08	54.42	-49.34	Average	NEUTRAL
5	0.22	2.78	9.38	9.83	21.99	62.88	-40.89	QP	NEUTRAL
6	0.22	-15.01	9.38	9.83	4.20	52.88	-48.68	Average	NEUTRAL
7	0.31	0.87	9.31	9.83	20.01	60.02	-40.01	QP	NEUTRAL
8	0.31	-15.82	9.31	9.83	3.32	50.02	-46.70	Average	NEUTRAL
9	0.55	1.03	9.20	9.84	20.07	56.00	-35.93	QP	NEUTRAL
10	0.55	-16.29	9.20	9.84	2.75	46.00	-43.25	Average	NEUTRAL
11	5.81	-8.83	9.33	9.94	10.44	60.00	-49.56	QP	NEUTRAL
12	5.81	-19.18	9.33	9.94	0.09	50.00	-49.91	Average	NEUTRAL

- Note: 1. Result Level = Read Level + LISN Factor + Cable loss.
 2. If QP Result complies with AV limit, AV Result is deemed to comply with AV limit.
 3. Test setup: RBW: 200 Hz (9 kHz—150 kHz), 9 kHz (150 kHz—30 MHz).
 4. Step size: 80Hz (0.009MHz-0.15MHz), 4 kHz (0.15MHz-30MHz), Scan time: auto.

9. Antenna Requirements

9.1. Limit

For intentional device, according to FCC 47 CFR Section 15.203, an intentional radiator shall be designed to ensure that no antenna other than that furnished by the responsible party shall be used with the device.

9.2. Result

The antennas used for this product are integral PCB antenna and that no antenna other than that furnished by the responsible party shall be used with the device, the maximum peak gain of the transmit antenna is only 1.57 dBi.