



■ Report No.: DDT-R21042025-2E03

■ Issued Date: Jun. 09, 2021

FCC AND ISED CERTIFICATION TEST REPORT

FOR

Applicant	:	Harman International Industries, Inc.
Address	:	8500 Balboa Boulevard, Northridge, CA 91329, UNITED STATES
Equipment under Test	:	SOUNDBAR
Model No.	:	Bar 2.1 Deep Bass CNTR
Trade Mark	:	JBL
FCC ID	:	APIBAR300CNTRM
IC	:	6132A-BAR300CNTRM
Manufacturer	:	Harman International Industries, Inc.
Address	:	8500 Balboa Boulevard, Northridge, CA 91329, UNITED STATES

Issued By: Dongguan Dongdian Testing Service Co., Ltd.

Add.: No. 17, Zongbu Road 2, Songshan Lake Sci&Tech, Industry Park,
Dongguan City, Guangdong Province, China, 523808

Tel.: +86-0769-38826678, **E-mail:** ddt@dgddt.com, <http://www.dgddt.com>

REPORT

Table of Contents

	Test report declares.....	4
1.	Summary of Test Results.....	6
2.	General Test Information	7
2.1.	Description of EUT	7
2.2.	Accessories of EUT.....	8
2.3.	Assistant equipment used for test.....	8
2.4.	Block diagram of EUT configuration for test.....	8
2.5.	Test environment conditions	8
2.6.	Deviations of test standard.....	8
2.7.	Test laboratory.....	9
2.8.	Measurement uncertainty.....	9
3.	Equipment Used During Test.....	10
4	Duty Cycle	12
4.1.	Block diagram of test setup.....	12
4.2.	Limits	12
4.3.	Test procedure	12
4.4.	Test result.....	12
4.5.	Original test data	13
5.	20 dB Bandwidth and 99% Bandwidth	14
5.1.	Block diagram of test setup.....	14
5.2.	Limits	14
5.3.	Test procedure	14
5.4.	Test result.....	14
5.5.	Original test data	15
6.	Radiated Emission	17
6.1.	Block diagram of test setup.....	17
6.2.	Limit.....	18
6.3.	Test procedure	19
6.4.	Test result.....	20
7.	Band Edge Compliance	26
7.1.	Block diagram of test setup.....	26
7.2.	Limit.....	26
7.3.	Test procedure	26
7.4.	Test result.....	26
8.	Power Line Conducted Emission.....	31
8.1.	Block diagram of test setup.....	31

8.2. Power line conducted emission limits 31

8.3. Test procedure 31

8.4. Test result 32

9. Antenna Requirements 35

9.1. Limit 35

9.2. Result 35

Test Report Declare

Applicant	:	Harman International Industries, Inc.
Address	:	8500 Balboa Boulevard, Northridge, CA 91329, UNITED STATES
Equipment under Test	:	SOUNDBAR
Model No.	:	Bar 2.1 Deep Bass CNTR
Trade mark	:	JBL
Manufacturer	:	Harman International Industries, Inc.
Address	:	8500 Balboa Boulevard, Northridge, CA 91329, UNITED STATES

Test Standard Used:

FCC Rules and Regulations Part 15 Subpart C, RSS-210 Issue 10 December 2019.

Test procedure used:

ANSI C63.10:2013, RSS-Gen Issue 5, Apr. 2018.

We Declare:

The equipment described above is tested by Dongguan Dongdian Testing Service Co., Ltd. and in the configuration tested the equipment complied with the standards specified above. The test results are contained in this test report and Dongguan Dongdian Testing Service Co., Ltd. is assumed of full responsibility for the accuracy and completeness of these tests.

After test and evaluation, our opinion is that the equipment provided for test compliance with the requirement of the above FCC&ISED standards.

Report No:	DDT-R21042025-2E03		
Date of Receipt:	May 09, 2021	Date of Test:	May 09, 2021 ~ Jun. 07, 2021

Prepared By:

Sam Li

Sam Li/Engineer

Approved By:

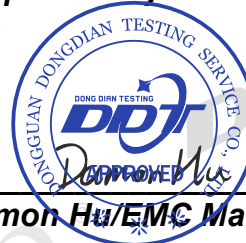

Damon Hu/EMC Manager

Note: This report applies to above tested sample only. This report shall not be reproduced in parts without written approval of Dongguan Dongdian Testing Service Co., Ltd.

Revision History

Rev.	Revisions	Issue Date	Revised By
---	Initial issue	Jun. 09, 2021	

1. Summary of Test Results

The EUT have been tested according to the applicable standards as referenced below.		
Description of Test Item	Standard	Results
20 dB Bandwidth and 99% Bandwidth	FCC Part 15: 15.215 ANSI C63.10:2013 RSS-210 Issue 10 RSS-Gen Issue 5	Pass
Radiated Emission	FCC Part 15: 15.209 FCC Part 15: 15.249 ANSI C63.10:2013 RSS-210 Issue 10 RSS-Gen Issue 5	Pass [®]
Band Edge Compliance	FCC Part 15: 15.205 FCC Part 15: 15.249 ANSI C63.10:2013 RSS-210 Issue 10 RSS-Gen Issue 5	Pass
Power Line Conducted Emission	FCC Part 15: 15.207 ANSI C63.10:2013 RSS-Gen Issue 5	Pass
Antenna Requirement	FCC Part 15: 15.203 RSS-Gen Issue 5	Pass

2. General Test Information

2.1. Description of EUT

EUT* Name	: SOUNDBAR
Model Number	: Bar 2.1 Deep Bass CNTR
EUT function description	: Please reference user manual of this device
Power Supply	: AC 100-240V, 50/60Hz
Operation frequency	: 5732 MHz - 5848 MHz
Modulation	: FSK
Antenna Type	: Antenna 1: Integral PCB antenna, maximum PK gain: 1.57 dBi Antenna 2: Integral PCB antenna, maximum PK gain: 1.57 dBi The EUT supports the antenna with TX and RX diversity functions. Both Ant. 1 and Ant. 2 support transmit and receive functions, but only one of them will be used at one time, and Ant. 1 generated the worst case, so it was selected to test and record in the report.
Serial Number	: RS0073-DL0000063 for conducted test RS0073-DL0000058 for radiation test

Note: EUT is the abbreviation of equipment under test.

EUT channels and frequencies list:

Channel information					
Channel	Frequency (MHz)	Channel	Frequency (MHz)	Channel	Frequency (MHz)
1	5732	21	5771	41	5811
2	5733	22	5773	42	5813
3	5735	23	5775	43	5815
4	5737	24	5777	44	5817
5	5739	25	5780	45	5819
6	5741	26	5781	46	5821
7	5743	27	5783	47	5823
8	5745	28	5785	48	5825
9	5747	29	5787	49	5827
10	5749	30	5789	50	5829
11	5751	31	5791	51	5831
12	5753	32	5793	52	5833
13	5755	33	5795	53	5835
14	5757	34	5797	54	5837
15	5759	35	5799	55	5839
16	5761	36	5801	56	5841
17	5763	37	5803	57	5843
18	5765	38	5805	58	5845
19	5767	39	5807	59	5847
20	5769	40	5809	60	5848

2.2. Accessories of EUT

Description of Accessories	Manufacturer	Model number	Serial No.	Other
AC cable	Harman	N/A	N/A	Length: 1.5m, unshielded
HDMI cable	Harman	N/A	N/A	Length: 1.5m, shielded, two core

2.3. Assistant equipment used for test

Assistant equipment	Manufacturer	Model number	EMC Compliance	SN
Notebook	Lenovo Beijing Co. Ltd.	ThinkPad	FCC/CE	TP00015A

2.4. Block diagram of EUT configuration for test



Test software: EMI_Tool

The test software was used to control EUT work in Continuous Tx mode, and select test channel, wireless mode as below table.

Tested mode, channel, information		
Mode	Channel	Frequency (MHz)
FSK Tx mode	CH1	5732
	CH25	5780
	CH60	5848

2.5. Test environment conditions

During the measurement the environmental conditions were within the listed ranges:

Temperature range:	21-25 °C
Humidity range:	40-75%
Pressure range:	86-106 kPa

2.6. Deviations of test standard

No deviation.

2.7. Test laboratory

Dongguan Dongdian Testing Service Co., Ltd.

Add.: No. 17, Zongbu Road 2, Songshan Lake Sci&Tech, Industry Park, Dongguan City, Guangdong Province, China, 523808.

Tel.: +86-0769-38826678, <http://www.dgddt.com>, Email: ddt@dgddt.com.

CNAS Accreditation No. L6451; A2LA Accreditation Number: 3870.01

FCC Designation Number: CN1182, Test Firm Registration Number: 540522

Innovation, Science and Economic Development Canada Site Registration Number: 10288A

Conformity Assessment Body identifier: CN0048

VCCI facility registration number: C-20087, T-20088, R-20123, G-20118

2.8. Measurement uncertainty

Test Item	Uncertainty
Bandwidth	1.1%
Peak Output Power (Conducted) (Spectrum analyzer)	0.86 dB (10 MHz ≤ f < 3.6 GHz);
	1.38 dB (3.6 GHz ≤ f < 8 GHz)
Peak Output Power (Conducted) (Power Sensor)	0.74 dB
Power Spectral Density	0.74 dB (10 MHz ≤ f < 3.6 GHz);
	1.38 dB (3.6 GHz ≤ f < 8 GHz)
Conducted spurious emissions	0.86 dB (10 MHz ≤ f < 3.6 GHz);
	1.40 dB (3.6 GHz ≤ f < 8 GHz)
	1.66 dB (8 GHz ≤ f < 22 GHz)
Uncertainty for radio frequency (RBW < 20 kHz)	3×10^{-8}
Temperature	0.4 °C
Humidity	2%
Uncertainty for Radiation Emission test (30 MHz - 1 GHz)	4.70 dB (Antenna Polarize: V)
	4.84 dB (Antenna Polarize: H)
Uncertainty for Radiation Emission test (1 GHz - 18 GHz)	4.10 dB (1-6 GHz)
	4.40 dB (6 GHz - 18 GHz)
Uncertainty for Power line conduction emission test	3.32 dB (150 kHz - 30 MHz)
Note: This uncertainty represents an expanded uncertainty expressed at approximately the 95% confidence level using a coverage factor of k=2.	

3. Equipment Used During Test

Equipment	Manufacturer	Model No.	Serial No.	Last Cal.	Cal. Interval
<input type="checkbox"/> RF Connected Test (Tonscend RF Measurement System 1#)					
Spectrum analyzer	R&S	FSU26	101272	Jul. 01, 2020	1 Year
Spectrum analyzer	Agilent	N9020D	MY49100362	Sep. 28, 2020	1 Year
Wideband Radio Communication tester	R&S	CMW500	117491	Jul. 01, 2020	1 Year
Vector Signal Generator	Agilent	E8267D	US49060192	Sep. 24, 2020	1 Year
Vector Signal Generator	Agilent	N5182A	MY48180737	Jul. 01, 2020	1 Year
Power Sensor	Agilent	U2021XA	MY55150010	Jul. 01, 2020	1 Year
Power Sensor	Agilent	U2021XA	MY55150011	Jul. 01, 2020	1 Year
RF Cable	Micable	C10-01-01-1	100309	Sep. 28, 2020	1 Year
Temp&Humi Programmable	ZHIXIANG	ZXGDJS-15 0L	ZX170110-A	Jul. 01, 2020	1 Year
Test Software	JS Tonscend	JS1120-3	Ver.2.7	N/A	N/A
<input checked="" type="checkbox"/> RF Connected Test (Tonscend RF Measurement System 2#)					
Spectrum analyzer	R&S	FSU26	200071	Sep. 25, 2020	1 Year
Spectrum analyzer	Agilent	N9020D	MY49100362	Sep. 28, 2020	1 Year
Wideband Radio Communication tester	R&S	CMW500	117491	Jul. 01, 2020	1 Year
Vector Signal Generator	Agilent	N5182A	MY19060405	Jul. 01, 2020	1 Year
Vector Signal Generator	Agilent	N5182A	MY48180912	Jul. 01, 2020	1 Year
RF Control Unit	Tonsend	JS0806-2	DDT-ZC01449	Jul. 01, 2020	1 Year
RF Cable	Micable	C10-01-01-1	100309	Sep. 28, 2020	1 Year
Temp&Humi Programmable	ZHIXIANG	ZXGDJS-15 0L	ZX170110-A	Jul. 01, 2020	1 Year
Test Software	JS Tonscend	JS1120-3	Ver.2.7	N/A	N/A
<input type="checkbox"/> Radiation 1#chamber					
EMI Test Receiver	R&S	ESU8	100316	Sep. 24, 2020	1 Year
Spectrum analyzer	Agilent	E4447A	MY50180031	Jul. 01, 2020	1 Year
Trilog Broadband Antenna	Schwarzbeck	VULB9163	9163-462	Nov. 13, 2020	1 Year
Active Loop antenna	Schwarzbeck	FMZB-1519	1519-038	Nov. 18, 2020	1 Year
Double Ridged Horn Antenna	R&S	HF907	100276	Nov. 13, 2020	1 Year
Broad Band Horn Antenna	Schwarzbeck	BBHA 9170	790	May 08, 2021	1 Year
Pre-amplifier	A.H.	PAM-0118	360	Sep. 28, 2020	1 Year
RF Cable	HUBSER	CP-X2+ CP-X1	W11.03+ W12.02	Sep. 24, 2020	1 Year
RF Cable	N/A	5m+6m+1m	06270619	Sep. 30, 2020	1 Year
MI Cable	HUBSER	C10-01-01-1 M	1091629	Sep. 30, 2020	1 Year
Test software	Audix	E3	V 6.11111b	N/A	N/A

<input checked="" type="checkbox"/> Radiation 2#chamber					
EMI Test Receiver	R&S	ESCI	101364	Sep. 28, 2020	1 Year
Spectrum analyzer	Agilent	E4447A	MY50180031	Jul. 01, 2020	1 Year
Trilog Broadband Antenna	Schwarzbeck	VULB 9163	9163-994	Nov. 13, 2020	1 Year
Active Loop antenna	Schwarzbeck	FMZB-1519	1519-038	Nov. 18, 2020	1 Year
Double Ridged Horn Antenna	Schwarzbeck	BBHA9120	02108	Jul. 11, 2020	1 Year
Broad Band Horn Antenna	Schwarzbeck	BBHA 9170	790	May 08, 2021	1 Year
Pre-amplifier	TERA-MW	TRLA-0040 G35	1013 03	Sep. 28, 2020	1 Year
RF Cable	N/A	14+1.5m	06270619	Sep. 28, 2020	1 Year
Test software	Audix	E3	V 6.11111b	N/A	N/A
<input checked="" type="checkbox"/> Power Line Conducted Emissions Test 1#					
EMI Test Receiver	R&S	ESU8	100316	Sep. 24, 2020	1 Year
LISN 1	R&S	ENV216	101109	Sep. 28, 2020	1 Year
LISN 2	R&S	ESH2-Z5	100309	Sep. 28, 2020	1 Year
Pulse Limiter	R&S	ESH3-Z2	101242	Sep. 24, 2020	1 Year
CE Cable 1	HUBSER	N/A	W10.01	Sep. 24, 2020	1 Year
Test software	Audix	E3	V 6.11111b	N/A	N/A
<input type="checkbox"/> Power Line Conducted Emissions Test 2#					
Test Receiver	R&S	ESPI	101761	Sep. 24, 2020	1 Year
LISN 1	R&S	ENV216	101170	Sep. 28, 2020	1 Year
LISN 2	R&S	ESH2-Z5	100309	Sep. 28, 2020	1 Year
Pulse Limiter	R&S	KH43101	43101180156 8-12#	Jul. 01, 2020	1 Year
CE Cable 2	HUBSER	N/A	W11.02	Sep. 24, 2020	1 Year
Test software	Audix	E3	V 6.11111b	N/A	N/A

4 Duty Cycle

4.1. Block diagram of test setup

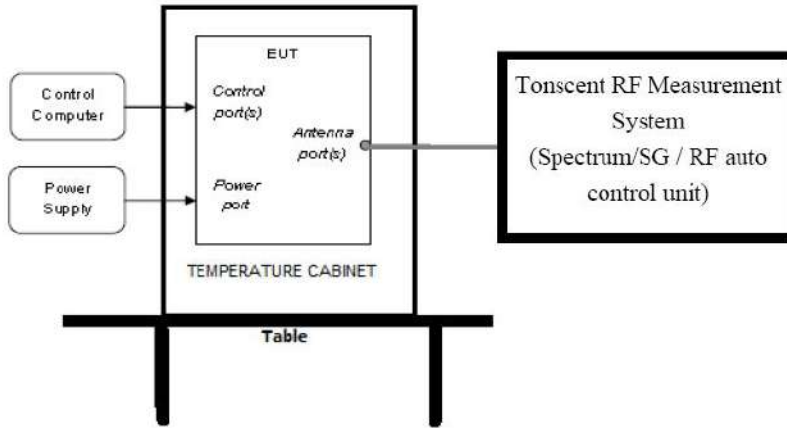

4.2. Limits

None: for reporting purposes only.

4.3. Test procedure

Set the Centre frequency of the spectrum analyzer to the transmitting frequency;

Set the span = 0, RBW = 3 MHz, VBW = 3 MHz, Sweep time = 100 ms;

Trace mode = Single hold.

4.4. Test result

Test Channel [MHz]	Duty Cycle [%]	20log(Δ) Factor[dB]
5732	14.60	-16.71

Average value:	
Calculate Formula:	Average value = Peak value + PDCF
	PDCF = 20 log(Duty cycle)
	Duty cycle = $T_{on\ time} / T_{period}$
Test data:	$T_{on\ time} = (0.417 \times 35) \text{ ms} = 14.60 \text{ ms}$
	$T_{period} = 100 \text{ ms}$
	PDCF = 20 log(Duty cycle) = 20 log(14.60/100) = -16.71 dB

4.5. Original test data



5. 20 dB Bandwidth and 99% Bandwidth

5.1. Block diagram of test setup

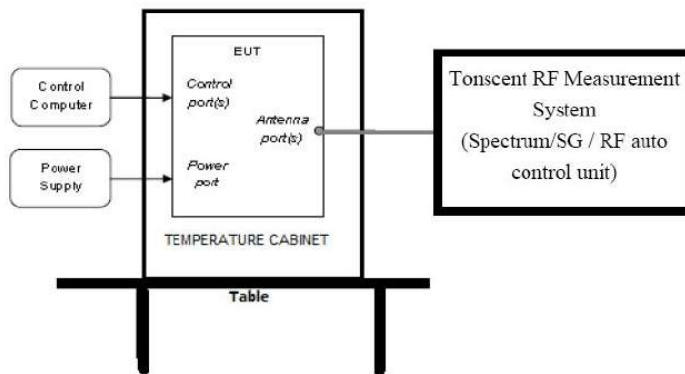

5.2. Limits

Intentional radiators operating under the alternative provisions to the general emission limits, as contained in § 15.217 through 15.257 and in Subpart E of this part, must be designed to ensure that the 20 dB bandwidth of the emission, or whatever bandwidth may otherwise be specified in the specific rule section under which the equipment operates, is contained within the frequency band designated in the rule section under which the equipment is operated.

5.3. Test procedure

(1) Connect EUT's antenna output to spectrum analyzer by RF cable.

(2) Set the spectrum analyzer as follows:

RBW:	100 kHz
VBW:	300 kHz
Detector Mode:	Peak/RMS
Sweep time:	auto
Trace mode	Max hold

(3) Allow the trace to stabilize, measure the 20 dB and 99% bandwidth of signal.

5.4. Test result

Test Mode	Freq. (MHz)	20 dB bandwidth Result (MHz)	99% bandwidth Result (MHz)	Verdict
FSK Tx mode	5732	2.468	2.356	Pass
	5780	2.468	2.356	Pass
	5848	2.452	2.340	Pass

5.5. Original test data

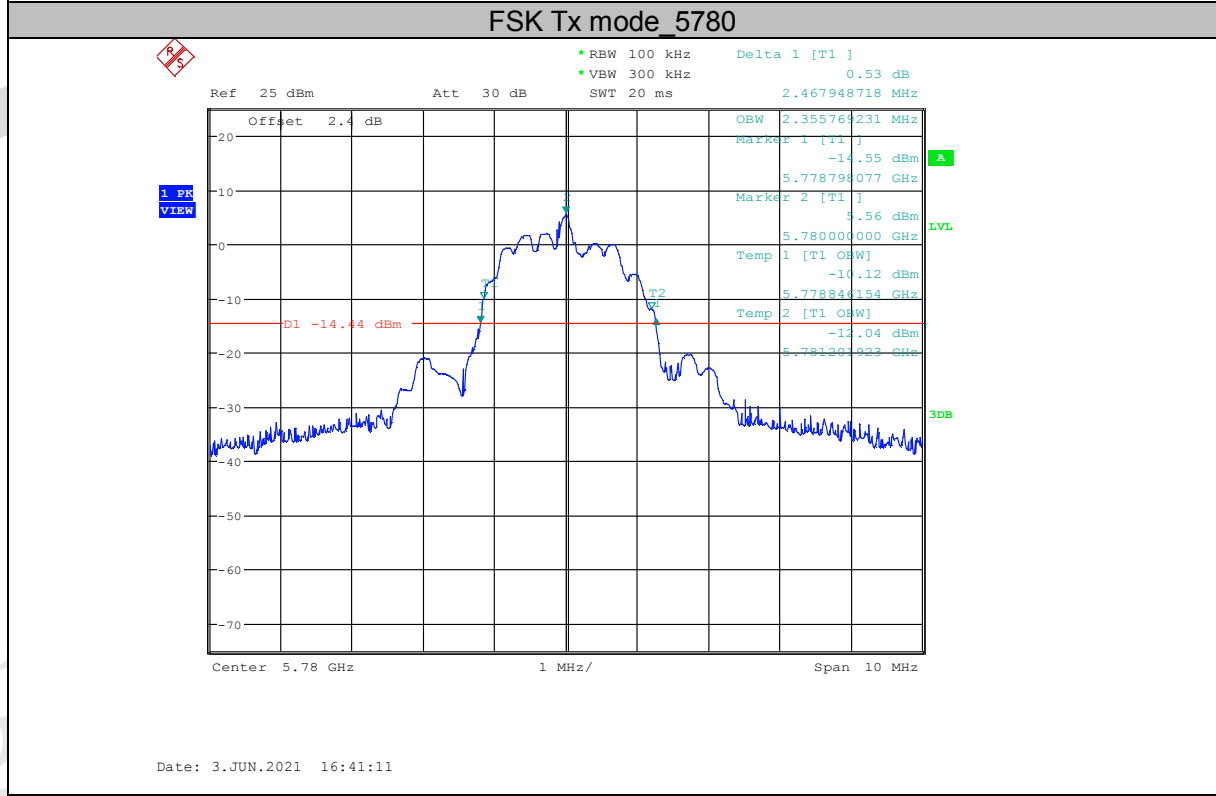
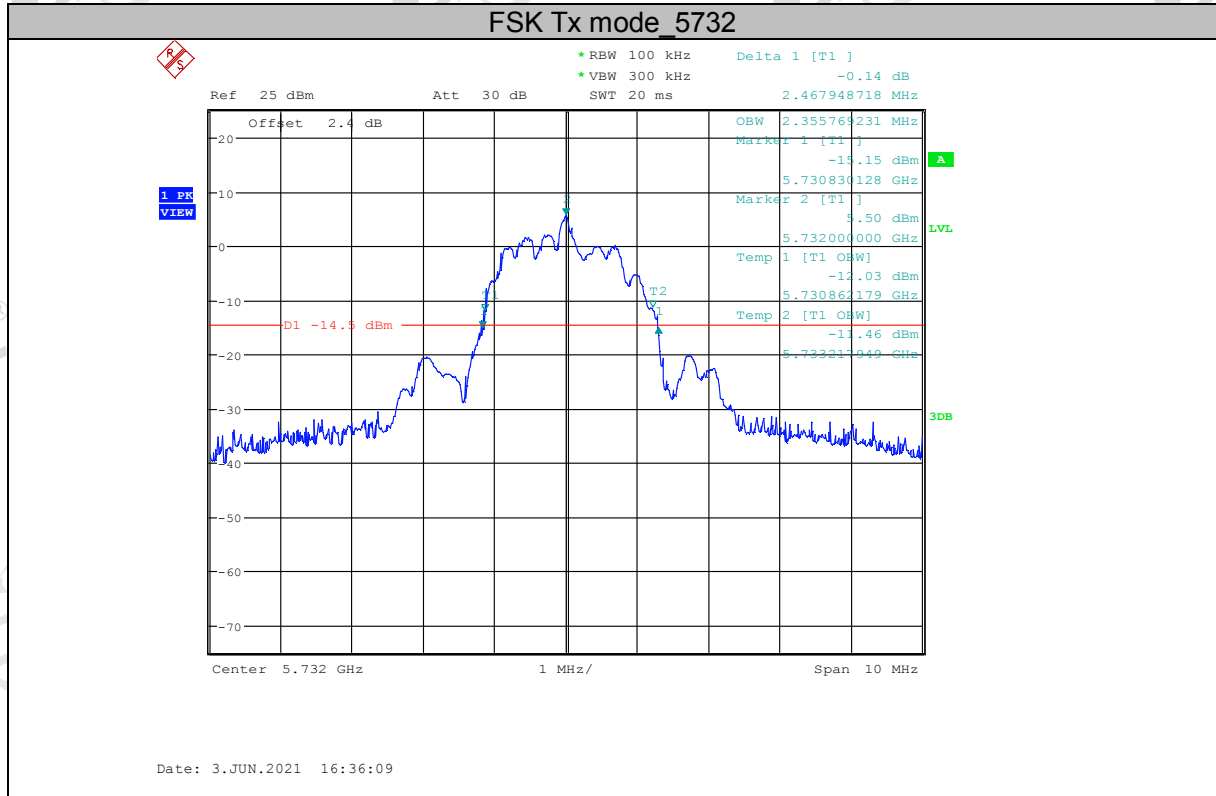

FSK Tx mode_5848

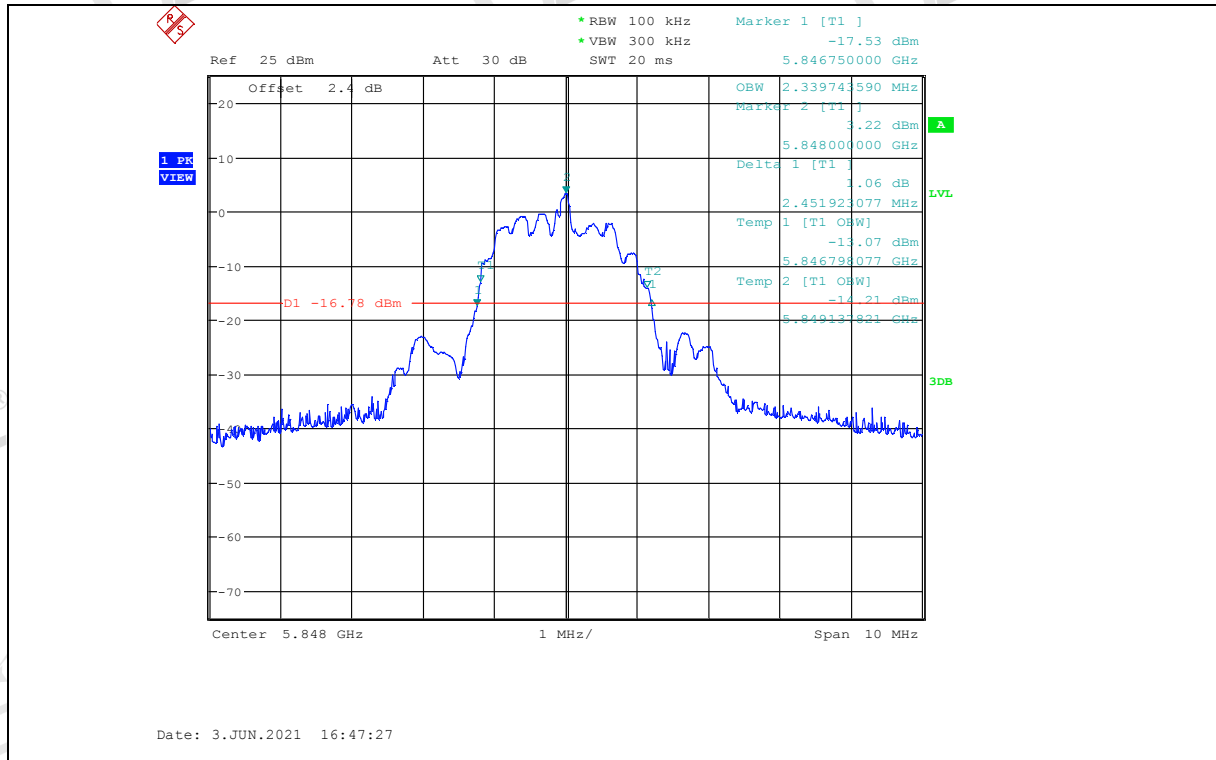

6. Radiated Emission

6.1. Block diagram of test setup

In 3 m Anechoic Chamber Test Setup Diagram for 9 kHz - 30 MHz

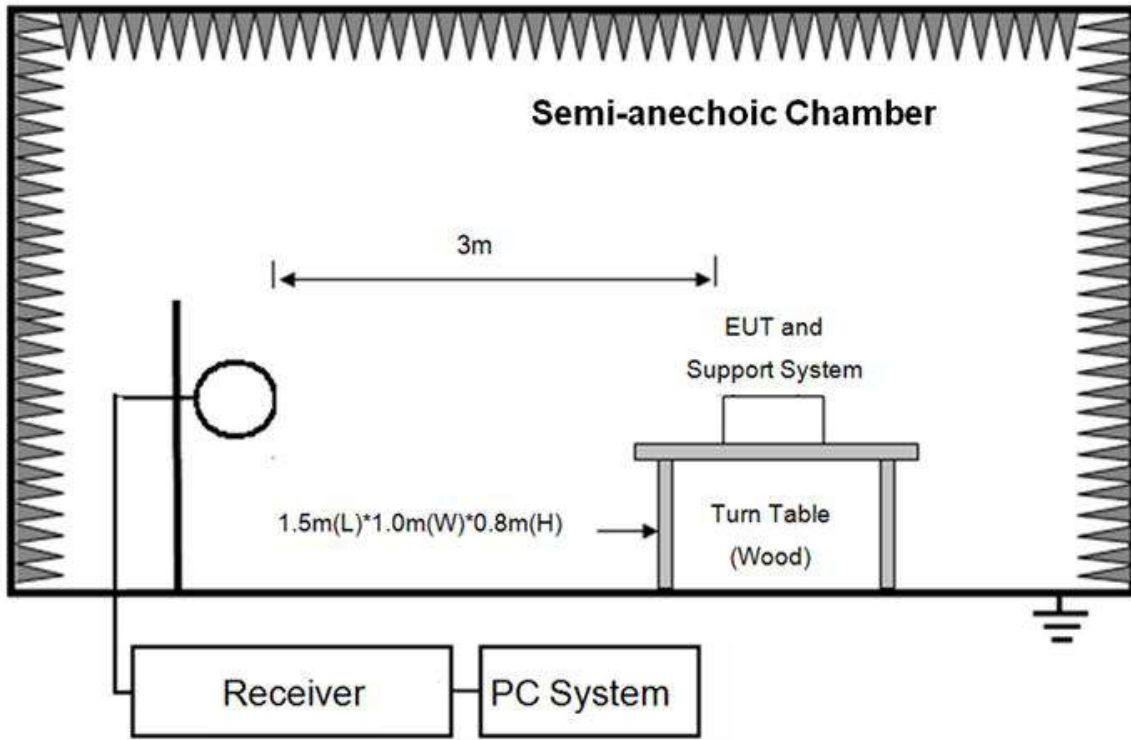

In 3 m Anechoic Chamber Test Setup Diagram for 30 MHz - 1 GHz

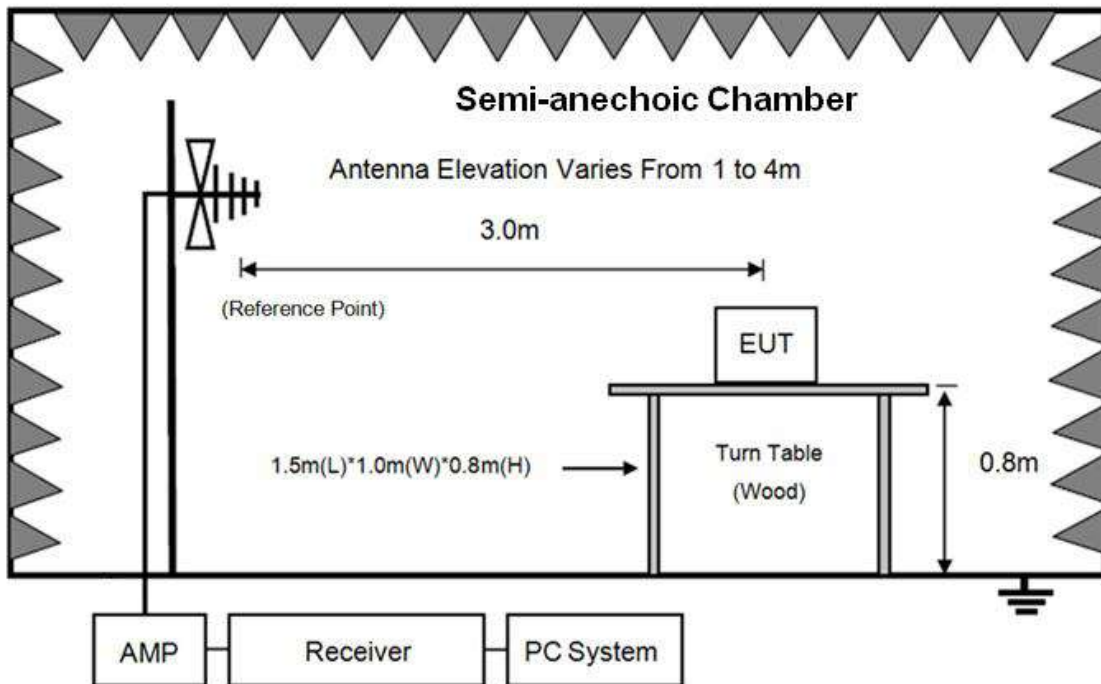

In 3 m Anechoic Chamber Test Setup Diagram for frequency above 1 GHz

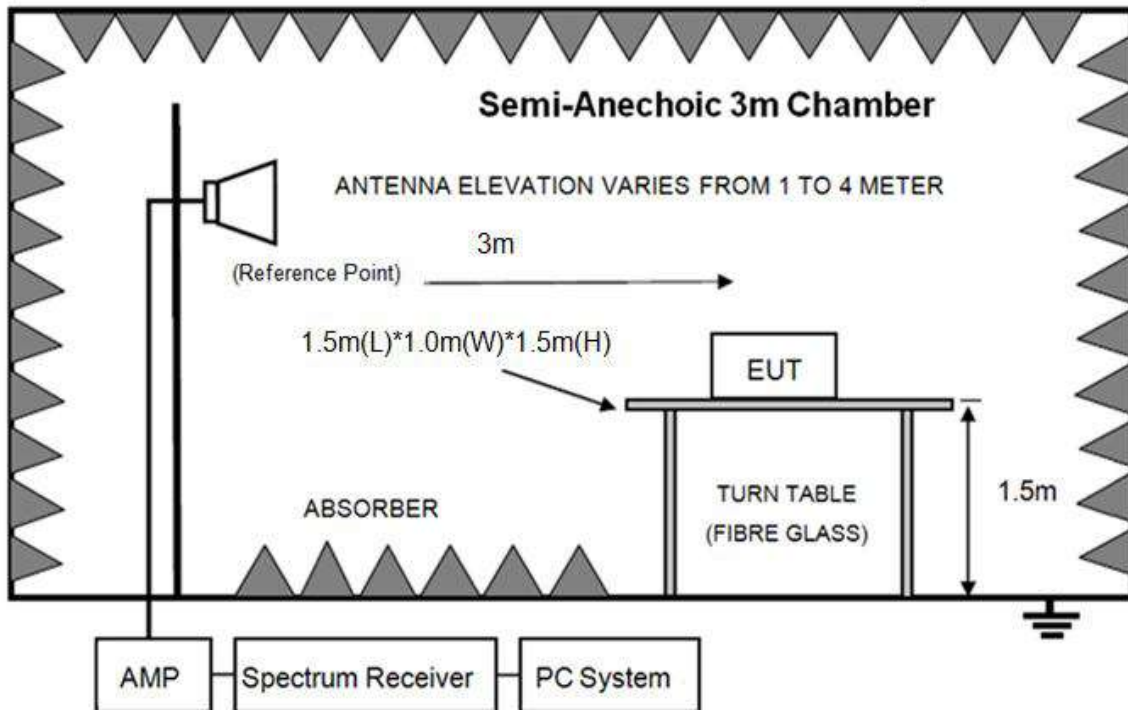

Note: For harmonic emissions test an appropriate high pass filter was inserted in the input port of AMP.

6.2. Limit

FREQUENCY MHz	DISTANCE Meters	FIELD STRENGTHS LIMIT	
		μV/m	dB(μV)/m
30 ~ 88	3	100	40.0
88 ~ 216	3	150	43.5
216 ~ 960	3	200	46.0
960 ~ 1000	3	500	54.0
Above 1000 MHz	3	74.0 dB(μV)/m (Peak) 54.0 dB(μV)/m (Average)	
Field Strength of Fundamental emission for 5725 MHz - 5875 MHz	3	94.0 dB(μV)/m (Average) 114.0 dB(μV)/m (Peak)	
Field Strength of Harmonics	3	74.0 dB(μV)/m (Peak) 54.0 dB(μV)/m (Average)	

Remark:

- (1) Emission level dBμV = 20 log Emission level μV/m
- (2) The smaller limit shall apply at the cross point between two frequency bands.
- (3) Distance is the distance in meters between the measuring instrument, antenna and the closest point of any part of the device or system.
- (4) The emission limits shown in the above table are based on measurements employing a CISPR quasi-peak detector except for the frequency bands 9-90 kHz, 110-490 kHz and above 1000 MHz, radiated emission limits in these three bands are based on measurements employing

an average detector.

6.3. Test procedure

- (1) EUT was placed on a non-metallic table, 80 cm above the ground plane inside a semi-anechoic chamber.
- (2) Setup EUT and assistant system according clause 2.3
- (3) Test antenna was located 3 m from the EUT on an adjustable mast. Below pre-scan procedure was first performed in order to find prominent radiated emissions.
 - (a) Change work frequency or channel of device if practicable.
 - (b) Change modulation type of device if practicable.
 - (c) Change power supply range from 85% to 115% of the rated supply voltage
 - (d) Rotated EUT though three orthogonal axes to determine the attitude of EUT arrangement produces highest emissions
- (4) Spectrum frequency from 9 kHz to 40 GHz (tenth harmonic of fundamental frequency) was investigated, and no any obvious emission were detected from 9 kHz to 30 MHz and 18 GHz to 40 GHz, so below final test was performed with frequency range from 30 MHz to 18 GHz.
- (5) For final emissions measurements at each frequency of interest, the EUT were rotated and the antenna height was varied between 1 m and 4 m in order to maximize the emission. Measurements in both horizontal and vertical polarities were made and the data was recorded. In order to find the maximum emission, the relative positions of equipments and all of the interface cables were changed according to ANSI C63.10:2013 on Radiated Emission test.
- (6) For emissions from 30 MHz to 1 GHz, Quasi-Peak values were measured with EMI Receiver and the bandwidth of Receiver is 120 kHz.
- (7) For emissions above 1 GHz, both Peak and Average level were measured with Spectrum Analyzer, and the RBW is set at 1 MHz, VBW is set at 3 MHz for Peak measure; according ANSI C63.10:2013 clause 4.1.4.2.2 procedure for average measure.
- (8) For fundamental frequency test, set spectrum analyzer's RBW = 3 MHz, VBW = 10 MHz. Peak detector for PK, according ANSI C63.10:2013 clause 4.1.4.2.2 procedure for average measure.

6.4. Test result

Pass. (See below detailed test result)

All the emissions except fundamental emission from 9 kHz to 40 GHz were comply with 15.209 limit.

Note1: According exploratory test no any obvious emission was detected from 9 kHz to 30 MHz and 18 GHz to 40 GHz, so the final test was performed with frequency range from 30 MHz to 18 GHz and recorded in below.

Note2: For emissions below 1 GHz, according exploratory explorer test, when change Tx mode and channel, have no distinct influence on emissions level, so for emissions below 1 GHz, the final test was only performed with EUT working in FSK, Tx 5780 MHz mode.

Note3: For emissions above 1 GHz. If peak results comply with AV limit, AV Result is deemed to comply with AV limit.

Note4: For simultaneous transmission of multiple channels in the 2.4GHz BT and 5.8GHz SRD bands, no noticeable emission was found.

Field Strength of the Fundamental Signal

Frequency (MHz)	PK Level (dBuV/m)	PK Limit Line (dBuV/m)	Over Limit (dB)	Polarization
5732	89.72	114.00	-24.28	Horizontal
5780	95.32	114.00	-18.68	Horizontal
5848	94.19	114.00	-19.81	Horizontal
5732	93.19	114.00	-20.81	Vertical
5780	95.88	114.00	-18.12	Vertical
5848	94.51	114.00	-19.49	Vertical

Frequency (MHz)	AV Level (dBuV/m)	AV Limit Line (dBuV/m)	Over Limit (dB)	Polarization
5732	73.01	94.00	-20.99	Horizontal
5780	78.61	94.00	-15.39	Horizontal
5848	77.48	94.00	-16.52	Horizontal
5732	76.48	94.00	-17.52	Vertical
5780	79.17	94.00	-14.83	Vertical
5848	77.80	94.00	-16.20	Vertical

Note: AV Level = PK Level + PDCF

Radiated Emission test (below 1 GHz) TR-4-E-009 Radiated Emission Test Result

Test Site : DDT 3m Chamber 2#

D:\2021 RE2# Report Data\Q21042025-2E Bar2.1\RF\FCC BELOW1G.EM6

Test Date : 2021-05-19

Tested By : Kennys

EUT : SOUNDBAR

Model Number : Bar 2.1 Deep Bass CNTR

Power Supply : AC 120V/60Hz

Test Mode : Tx mode

Condition : Temp:24.5°C,Humi:55%,Press:100.1kPa

Antenna/Distance : 2020 VULB 9163 2#/3m/VERTICAL

Memo :

Data:
5

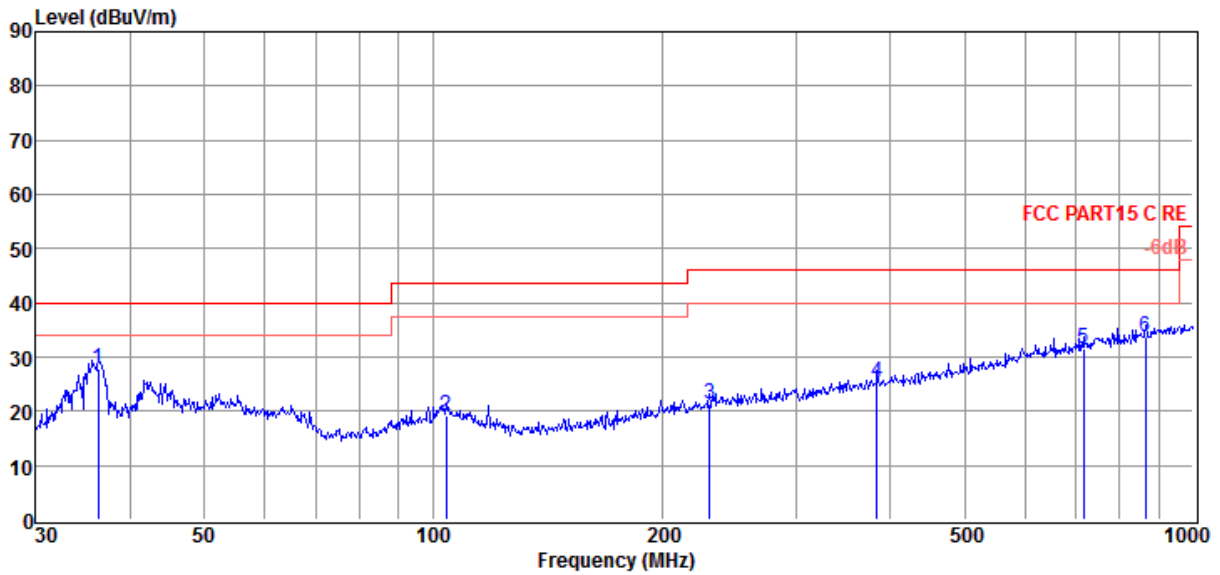

Item (Mark)	Freq. (MHz)	Read Level (dBμV)	Antenna Factor (dB/m)	Cable Loss (dB)	Result Level (dBμV/m)	Limit Line (dBμV/m)	Over Limit (dB)	Detector	Polarization
1	36.25	13.56	10.55	3.74	27.85	40.00	-12.15	QP	VERTICAL
2	104.17	3.05	11.84	4.44	19.33	43.50	-24.17	QP	VERTICAL
3	230.91	4.25	11.81	5.19	21.25	46.00	-24.75	QP	VERTICAL
4	383.93	4.28	15.28	5.86	25.42	46.00	-20.58	QP	VERTICAL
5	716.68	4.38	20.08	7.11	31.57	46.00	-14.43	QP	VERTICAL
6	866.09	4.72	21.50	7.59	33.81	46.00	-12.19	QP	VERTICAL

Note: 1. Result Level = Read Level + Antenna Factor + Cable loss.
 2. If Peak Result complies with QP limit, QP Result is deemed to comply with QP limit.
 3. Test setup: RBW: 120 kHz, VBW: 300 kHz, Sweep time: auto.

TR-4-E-009 Radiated Emission Test Result

Test Site : DDT 3m Chamber 2#

D:\2021 RE2# Report Data\Q21042025-2E Bar2.1\RF\FCC BELOW1G.EM6

Test Date : 2021-05-19

Tested By : Kennys

EUT : SOUNDBAR

Model Number : Bar 2.1 Deep Bass CNTR

Power Supply : AC 120V/60Hz

Test Mode : Tx mode

Condition : Temp:24.5°C,Humi:55%,Press:100.1kPa

Antenna/Distance : 2020 VULB 9163 2#/3m/HORIZONTAL

Memo :

Data:
6

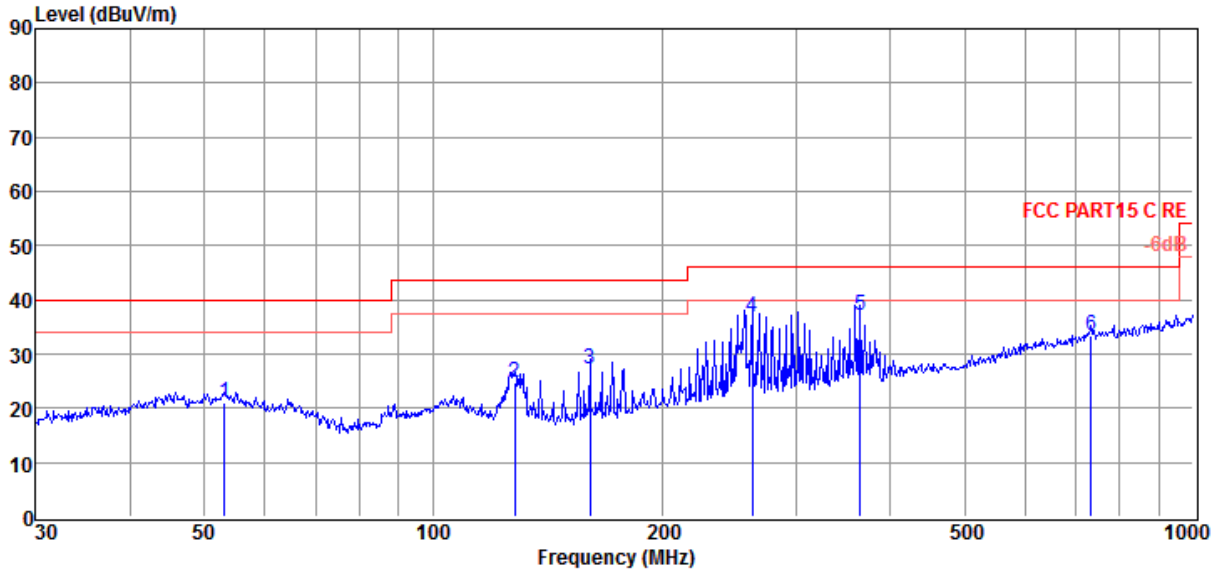

Item (Mark)	Freq. (MHz)	Read Level (dBμV)	Antenna Factor (dB/m)	Cable Loss (dB)	Result Level (dBμV/m)	Limit Line (dBμV/m)	Over Limit (dB)	Detector	Polarization
1	53.13	3.42	13.73	3.89	21.04	40.00	-18.96	QP	HORIZONTAL
2	128.11	12.15	7.84	4.61	24.60	43.50	-18.90	QP	HORIZONTAL
3	160.91	14.01	8.32	4.82	27.15	43.50	-16.35	QP	HORIZONTAL
4	262.90	18.92	12.44	5.33	36.69	46.00	-9.31	QP	HORIZONTAL
5	364.26	16.23	15.12	5.77	37.12	46.00	-8.88	QP	HORIZONTAL
6	734.49	5.62	20.47	7.17	33.26	46.00	-12.74	QP	HORIZONTAL

- Note: 1. Result Level = Read Level + Antenna Factor + Cable loss.
 2. If Peak Result complies with QP limit, QP Result is deemed to comply with QP limit.
 3. Test setup: RBW: 120 kHz, VBW: 300 kHz, Sweep time: auto.

Radiated Emission test (above 1 GHz)

Freq. (MHz)	Read level (dB μ V)	Antenna Factor (dB/m)	PRM Factor (dB)	Cable Loss (dB)	Result Level (dB μ V/m)	Limit (dB μ V/m)	Margin (dB)	Detector type	Polarization
Tx mode 5732 MHz									
8089.00	47.50	37.92	42.25	8.66	51.83	74.00	-22.17	Peak	HORIZONTAL
10299.00	45.07	39.28	42.42	10.33	52.26	74.00	-21.74	Peak	HORIZONTAL
11464.00	44.94	39.80	42.19	11.08	53.63	74.00	-20.37	Peak	HORIZONTAL
14056.00	43.76	41.48	42.45	12.26	55.05	74.00	-18.95	Peak	HORIZONTAL
14056.00	55.05-16.71=38.34					54.00	-15.66	Average	HORIZONTAL
15875.00	43.30	39.15	42.23	12.58	52.80	74.00	-21.20	Peak	HORIZONTAL
6474.00	47.73	35.02	43.25	7.79	47.29	74.00	-26.71	Peak	VERTICAL
8021.00	46.70	37.90	42.29	8.64	50.95	74.00	-23.05	Peak	VERTICAL
9840.00	45.80	38.80	42.14	10.09	52.55	74.00	-21.45	Peak	VERTICAL
11464.00	45.80	39.80	42.19	11.08	54.49	74.00	-19.51	Peak	VERTICAL
11464.00	54.49-16.71=37.78					54.00	-16.22	Average	VERTICAL
14719.00	44.08	40.91	41.92	12.50	55.57	74.00	-18.43	Peak	VERTICAL
14719.00	55.57-16.71=38.86					54.00	-15.14	Average	VERTICAL
Tx mode 5780 MHz									
7171.00	47.02	36.57	42.87	8.27	48.99	74.00	-25.01	Peak	HORIZONTAL
9466.00	45.51	38.77	41.99	9.65	51.94	74.00	-22.06	Peak	HORIZONTAL
10469.00	45.65	39.55	42.54	10.36	53.02	74.00	-20.98	Peak	HORIZONTAL
11560.00	45.21	39.78	42.04	11.11	54.06	74.00	-19.94	Peak	HORIZONTAL
11560.00	54.06-16.71=37.35					54.00	-16.65	Average	HORIZONTAL
14736.00	43.72	40.88	41.91	12.54	55.23	74.00	-18.77	Peak	HORIZONTAL
14736.00	55.23-16.71=38.52					54.00	-15.48	Average	HORIZONTAL
7766.00	47.17	37.53	42.46	8.73	50.97	74.00	-23.03	Peak	VERTICAL
10639.00	45.46	39.66	42.65	10.42	52.89	74.00	-21.11	Peak	VERTICAL
11560.00	49.23	39.78	42.04	11.11	58.08	74.00	-15.92	Peak	VERTICAL
11560.00	58.08-16.71=41.37					54.00	-12.63	Average	VERTICAL
14719.00	44.15	40.91	41.92	12.50	55.64	74.00	-18.36	Peak	VERTICAL
14719.00	55.64-16.71=38.93					54.00	-14.07	Average	VERTICAL
Tx mode 5848 MHz									
7579.00	47.07	37.23	42.58	8.81	50.53	74.00	-23.47	Peak	HORIZONTAL
10180.00	45.68	39.09	42.33	10.31	52.75	74.00	-21.25	Peak	HORIZONTAL
11696.00	47.43	39.72	41.84	11.10	56.41	74.00	-17.59	Peak	HORIZONTAL
11696.00	56.41-16.71=39.70					54.00	-14.30	Average	HORIZONTAL
14039.00	44.34	41.48	42.47	12.27	55.62	74.00	-18.38	Peak	HORIZONTAL
14039.00	55.62-16.71=38.91					54.00	-15.09	Average	HORIZONTAL
6899.00	47.95	36.06	43.05	7.94	48.90	74.00	-25.10	Peak	VERTICAL
8769.00	46.10	38.16	41.91	9.19	51.54	74.00	-22.46	Peak	VERTICAL
11696.00	47.57	39.72	41.84	11.10	56.55	74.00	-17.45	Peak	VERTICAL
11696.00	56.55-16.71=39.84					54.00	-14.16	Average	VERTICAL
14906.00	44.14	40.57	41.77	12.90	55.84	74.00	-18.16	Peak	VERTICAL
14906.00	55.84-16.71=39.13					54.00	-14.87	Average	VERTICAL
Result: Pass									

Note: 1. Result Level = Read Level + Antenna Factor + Cable loss - PRM Factor.

2. AV Level = PK Level + PDCF, PDCF= -16.71

3: For emissions above 1 GHz. If peak results comply with AV limit, AV Result is deemed to comply with AV limit.

7. Band Edge Compliance

7.1. Block diagram of test setup

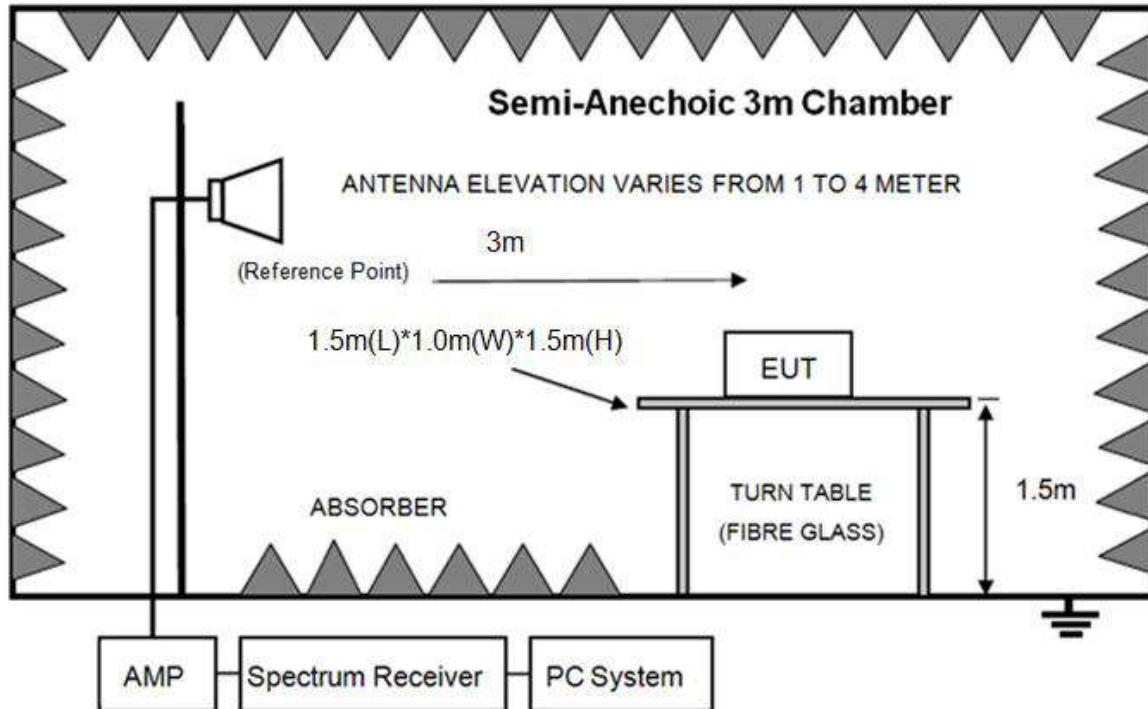

7.2. Limit

Emissions radiated outside of the specified frequency bands, except for harmonics, shall be attenuated by at least 50 dB below the level of the fundamental or to the general radiated emission limits in §15.209, whichever is the lesser attenuation.

7.3. Test procedure

- Same with clause 5.3 except change investigated frequency range from 5710 MHz to 5735 MHz and 5840 MHz to 5885 MHz.

Remark: All restriction band have been tested, and only the worst case is shown in report.

7.4. Test result

Pass. (See below detailed test result)

TR-4-E-009 Radiated Emission Test Result

Test Site : DDT 3m Chamber 2#

D:\2021 RE2# Report Data\Q21042025-2E Bar2.1\RF\FCC ABOVE 1G 2.4G.EM6

Test Date : 2021-05-27

Tested By : Kennys

EUT : SOUNDBAR

Model Number : Bar 2.1 Deep Bass CNTR

Power Supply : AC 120V/60Hz

Test Mode : Tx mode

Condition : Temp:24.5°C,Humi:55%,Press:100.1kPa

Antenna/Distance : 2020 BBHA9120D/3m/HORIZONTAL

Memo : 5732

Data: 55

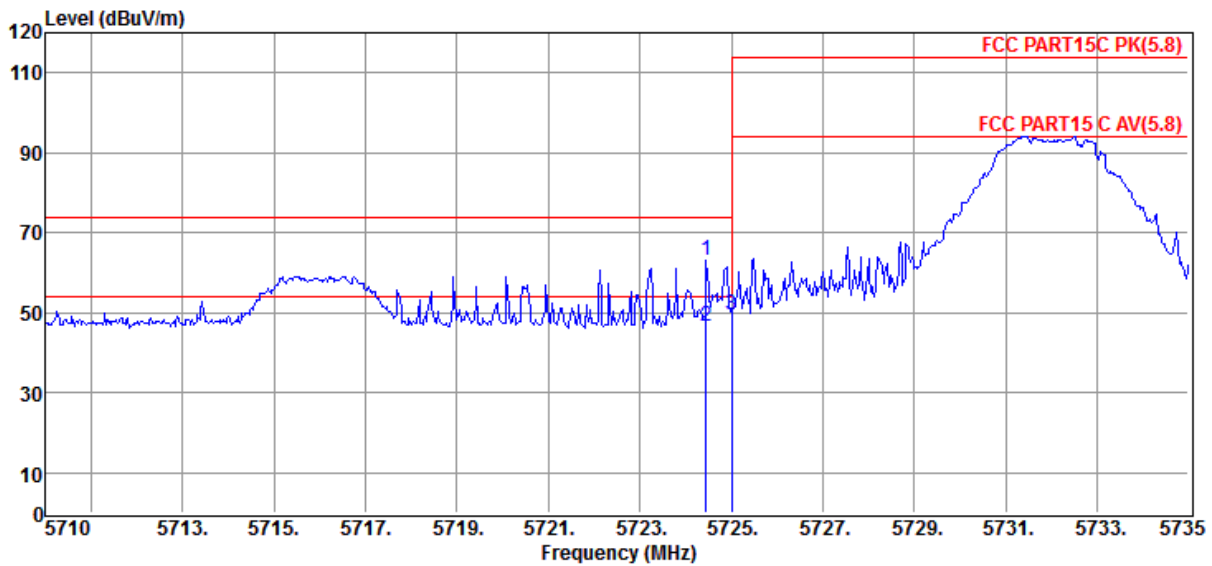

Item (Mark)	Freq. (MHz)	Read Level (dBμV)	Antenna Factor (dB/m)	PRM Factor (dB)	Cable Loss (dB)	Result Level (dBμV/m)	Limit Line (dBμV/m)	Over Limit (dB)	Detector	Polarization	
1	5724.45	65.99	33.17	43.42	7.24	62.98	74.00	-11.02	Peak	HORIZONTAL	
2	5724.45	62.98-16.71=46.27						54.00	-7.73	Average	HORIZONTAL
3	5725.00	52.51	33.17	43.42	7.24	49.50	74.00	-24.50	Peak	HORIZONTAL	

Note: 1. Result Level = Read Level + Antenna Factor + Cable loss - PRM Factor.

2. If Peak Result complies with AV limit, AV Result is deemed to comply with AV limit.

3. Test setup: RBW: 1 MHz, VBW: 3 MHz, Sweep time: auto.

4. AV Level = PK Level + PDCF, PDCF=-16.71

TR-4-E-009 Radiated Emission Test Result

Test Site : DDT 3m Chamber 2#

D:\2021 RE2# Report Data\Q21042025-2E Bar2.1\RF\FCC ABOVE 1G 2.4G.EM6

Test Date : 2021-05-27

Tested By : Kennys

EUT : SOUNDBAR

Model Number : Bar 2.1 Deep Bass CNTR

Power Supply : AC 120V/60Hz

Test Mode : Tx mode

Condition : Temp:24.5°C,Humi:55%,Press:100.1kPa

Antenna/Distance : 2020 BBHA9120D/3m/VERTICAL

Memo : 5732

Data: 56

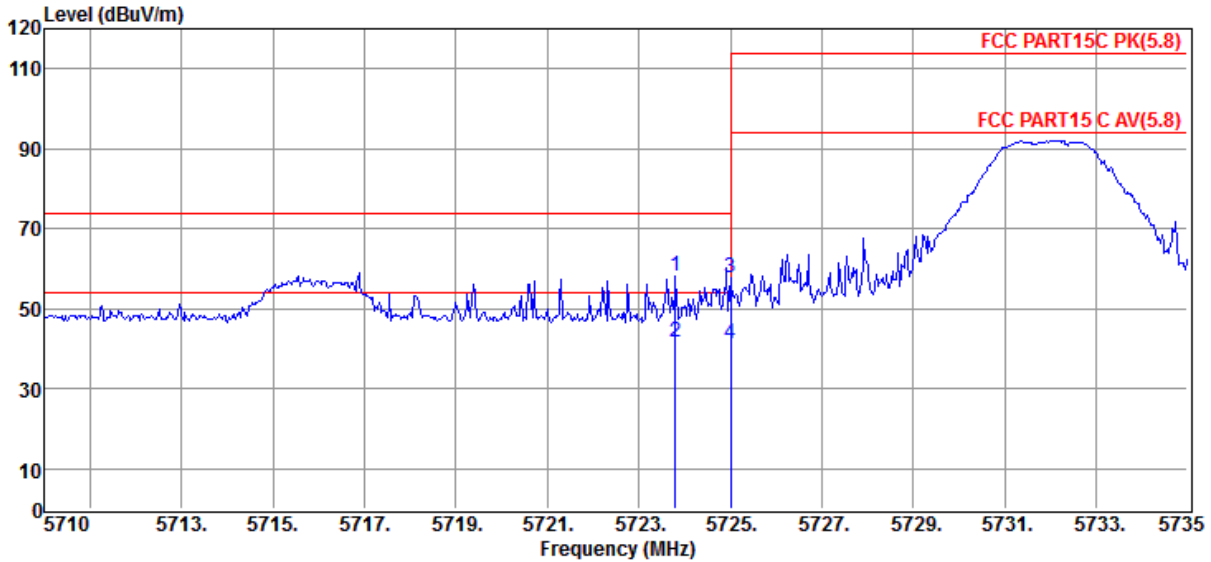

Item (Mark)	Freq. (MHz)	Read Level (dBμV)	Antenna Factor (dB/m)	PRM Factor (dB)	Cable Loss (dB)	Result Level (dBμV/m)	Limit Line (dBμV/m)	Over Limit (dB)	Detector	Polarization
1	5723.80	61.18	33.17	43.42	7.24	58.17	74.00	-15.83	Peak	VERTICAL
2	5723.80	58.17-16.71=41.46					54.00	-12.54	Average	VERTICAL
3	5725.00	60.73	33.17	43.42	7.24	57.72	74.00	-16.28	Peak	VERTICAL
4	5725.00	57.72-16.71=41.01					54.00	-12.99	Average	VERTICAL

Note: 1. Result Level = Read Level + Antenna Factor + Cable loss - PRM Factor.

2. If Peak Result complies with AV limit, AV Result is deemed to comply with AV limit.

3. Test setup: RBW: 1 MHz, VBW: 3 MHz, Sweep time: auto.

4. AV Level = PK Level + PDCF, PDCF=-16.71

TR-4-E-009 Radiated Emission Test Result

Test Site : DDT 3m Chamber 2#

D:\2021 RE2# Report Data\Q21042025-2E Bar2.1\RF\FCC ABOVE 1G 2.4G.EM6

Test Date : 2021-05-27

Tested By : Kennys

EUT : SOUNDBAR

Model Number : Bar 2.1 Deep Bass CNTR

Power Supply : AC 120V/60Hz

Test Mode : Tx mode

Condition : Temp:24.5°C,Humi:55%,Press:100.1kPa

Antenna/Distance : 2020 BBHA9120D/3m/VERTICAL

Memo : 5848

Data: 57

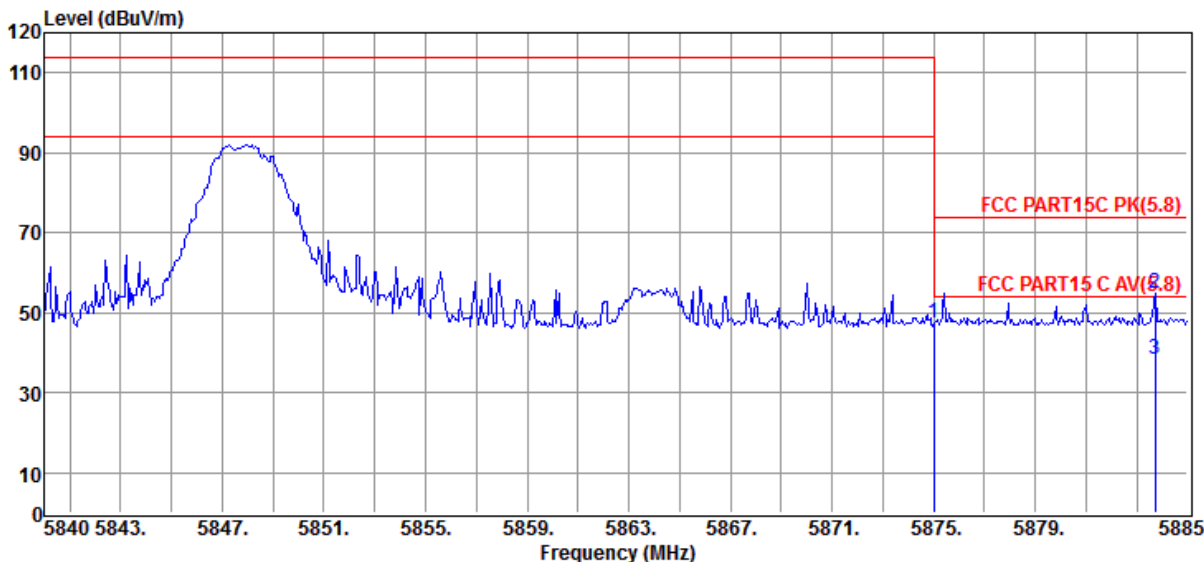

Item (Mark)	Freq. (MHz)	Read Level (dBuV)	Antenna Factor (dB/m)	PRM Factor (dB)	Cable Loss (dB)	Result Level (dBuV/m)	Limit Line (dBuV/m)	Over Limit (dB)	Detector	Polarization
1	5875.00	50.18	33.35	43.47	7.32	47.38	74.00	-26.62	Peak	VERTICAL
2	5883.74	57.52	33.36	43.47	7.33	54.74	74.00	-19.26	Peak	VERTICAL
3	5883.74	54.74-16.71=38.03					54.00	-15.97	Average	VERTICAL

Note: 1. Result Level = Read Level + Antenna Factor + Cable loss - PRM Factor.

2. If Peak Result complies with AV limit, AV Result is deemed to comply with AV limit.

3. Test setup: RBW: 1 MHz, VBW: 3 MHz, Sweep time: auto.

4. AV Level = PK Level + PDCF, PDCF=-16.71

TR-4-E-009 Radiated Emission Test Result

Test Site : DDT 3m Chamber 2#

D:\2021 RE2# Report Data\Q21042025-2E Bar2.1\RF\FCC ABOVE 1G 2.4G.EM6

Test Date : 2021-05-27

Tested By : Kennys

EUT : SOUNDBAR

Model Number : Bar 2.1 Deep Bass CNTR

Power Supply : AC 120V/60Hz

Test Mode : Tx mode

Condition : Temp:24.5°C,Humi:55%,Press:100.1kPa

Antenna/Distance : 2020 BBHA9120D/3m/HORIZONTAL

Memo : 5848

Data: 58

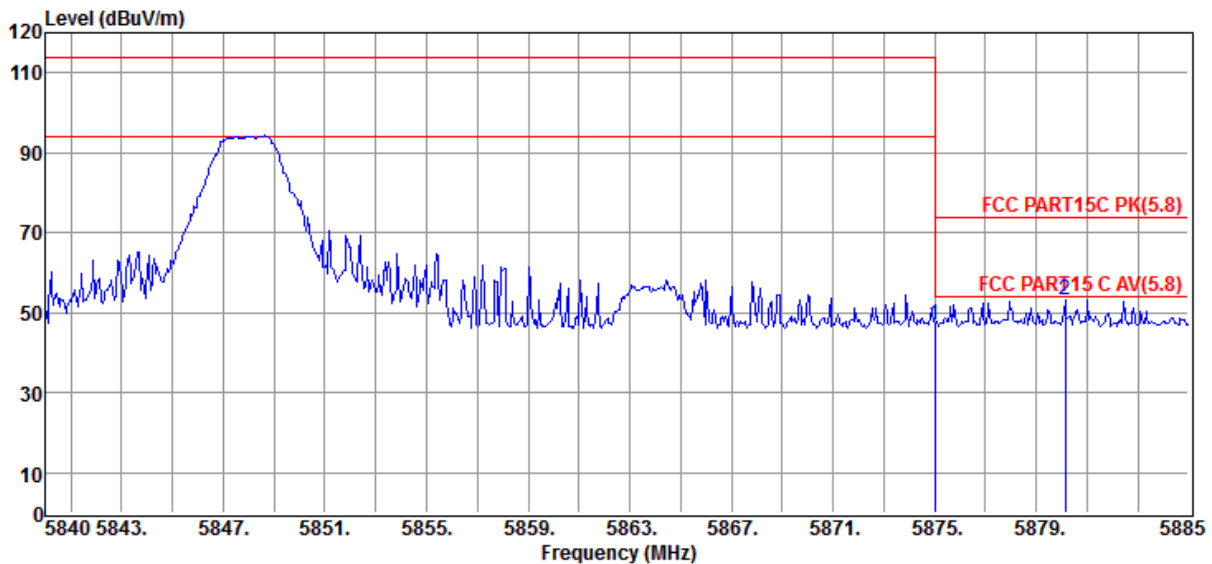

Item (Mark)	Freq. (MHz)	Read Level (dBμV)	Antenna Factor (dB/m)	PRM Factor (dB)	Cable Loss (dB)	Result Level (dBμV/m)	Limit Line (dBμV/m)	Over Limit (dB)	Detector	Polarization
1	5875.00	49.89	33.35	43.47	7.32	47.09	74.00	-26.91	Peak	HORIZONTAL
2	5880.14	56.09	33.36	43.47	7.33	53.31	74.00	-20.69	Peak	HORIZONTAL

Note: 1. Result Level = Read Level + Antenna Factor + Cable loss - PRM Factor.

2. If Peak Result complies with AV limit, AV Result is deemed to comply with AV limit.

3. Test setup: RBW: 1 MHz, VBW: 3 MHz, Sweep time: auto.

4. AV Level = PK Level + PDCF, PDCF=-16.71

8. Power Line Conducted Emission

8.1. Block diagram of test setup

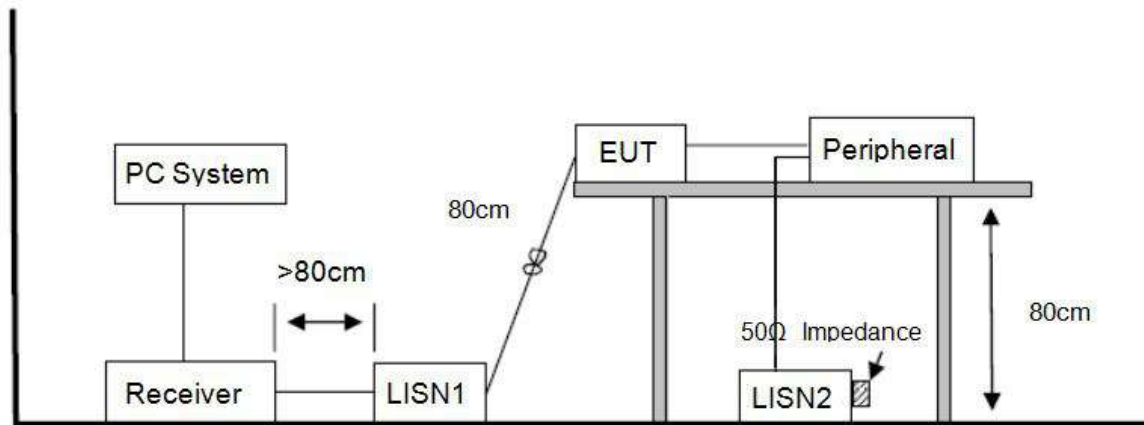

8.2. Power line conducted emission limits

Frequency	Quasi-Peak Level dB(μ V)	Average Level dB(μ V)
150 kHz ~ 500 kHz	66 ~ 56*	56 ~ 46*
500 kHz ~ 5 MHz	56	46
5 MHz ~ 30 MHz	60	50

Note 1: * Decreasing linearly with logarithm of frequency.

Note 2: The lower limit shall apply at the transition frequencies.

8.3. Test procedure

The EUT and Support equipment, if needed, were put placed on a non-metallic table, 80 cm above the ground plane.

Configuration EUT to simulate typical usage as described in clause 2.4 and test equipment as described in clause 7.1 of this report.

All I/O cables were positioned to simulate typical actual usage as per ANSI C63.10.

All support equipment power received from a second LISN.

Emissions were measured on each current carrying line of the EUT using an EMI Test Receiver connected to the LISN powering the EUT.

The Receiver scanned from 150 kHz to 30 MHz for emissions in each of the test modes.

During the above scans, the emissions were maximized by cable manipulation.

The test mode(s) described in clause 2.4 were scanned during the preliminary test.

After the preliminary scan, we found the test mode producing the highest emission level. The EUT configuration and worse cable configuration of the above highest emission levels were

recorded for reference of the final test.

EUT and support equipment were set up on the test bench as per the configuration with highest emission level in the preliminary test.

A scan was taken on both power lines, Neutral and Line, recording at least the six highest emissions.

Emission frequency and amplitude were recorded into a computer in which correction factors were used to calculate the emission level and compare reading to the applicable limit.

The test data of the worst-case condition(s) was recorded.

The bandwidth of test receiver is set at 9 kHz.

8.4. Test result

Pass. (See below detailed test result)

Note1: All emissions not reported below are too low against the prescribed limits.

Note2: "----" means Peak detection; "----" means Average detection.

Note3: Pre-test AC conducted emission at both voltage AC 120V/60Hz and AC 240V/60Hz, recorded worst case.

TR-4-E-010 Conducted Emission Test Result

Test Site : DDT 1# Shield Room D:\2021 CE report date\Q21042025-1E\CE.EM6
Test Date : 2021-05-11 **Tested By** : Chunchieh Huang
EUT : SOUNDBAR **Model Number** : Bar 2.1 Deep Bass CNTR
Power Supply : AC 120V/60Hz **Test Mode** : Tx mode
Condition : TEMP:24.8°C, RH:53.8%, BP:101.4kPa **LISN** : 2020 ENV 216 1#/NEUTRAL

Memo :

Data: 134

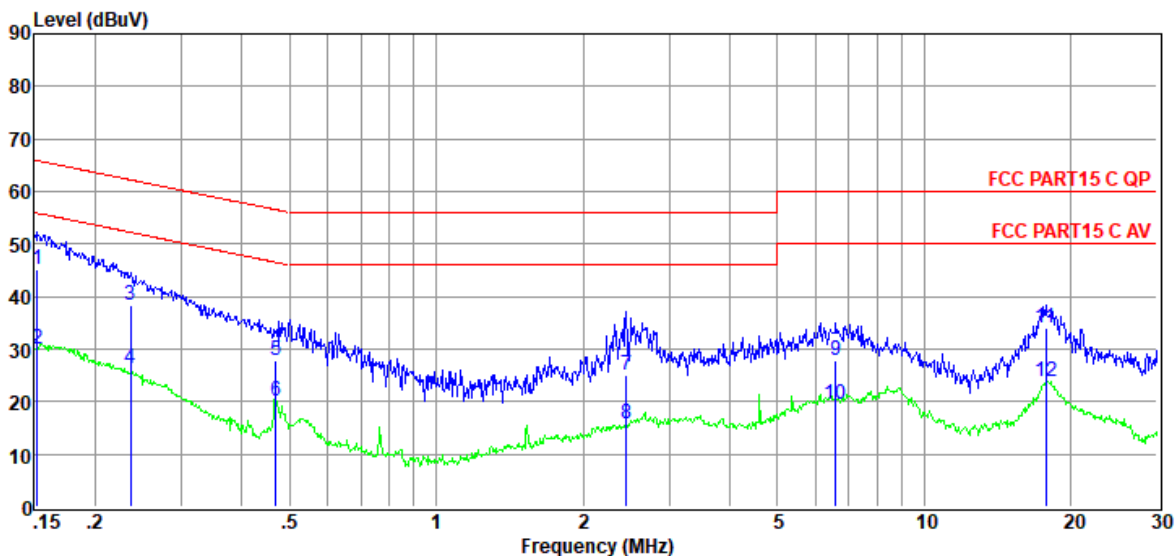

Item (Mark)	Freq. (MHz)	Read Level (dBuV)	LISN Factor (dB)	Cable Loss (dB)	Pulse Limiter Factor (dB)	Result Level (dBuV)	Limit Line (dBuV)	Over Limit (dB)	Detector	Phase
1	0.15	26.00	9.38	0.02	9.86	45.26	65.87	-20.61	QP	NEUTRAL
2	0.15	10.88	9.38	0.02	9.86	30.14	55.87	-25.73	Average	NEUTRAL
3	0.24	19.18	9.37	0.02	9.86	38.43	62.22	-23.79	QP	NEUTRAL
4	0.24	7.06	9.37	0.02	9.86	26.31	52.22	-25.91	Average	NEUTRAL
5	0.47	8.48	9.39	0.02	9.86	27.75	56.54	-28.79	QP	NEUTRAL
6	0.47	0.77	9.39	0.02	9.86	20.04	46.54	-26.50	Average	NEUTRAL
7	2.45	5.70	9.40	0.06	9.87	25.03	56.00	-30.97	QP	NEUTRAL
8	2.45	-3.58	9.40	0.06	9.87	15.75	46.00	-30.25	Average	NEUTRAL
9	6.59	8.37	9.51	0.09	9.88	27.85	60.00	-32.15	QP	NEUTRAL
10	6.59	-0.12	9.51	0.09	9.88	19.36	50.00	-30.64	Average	NEUTRAL
11	17.76	14.12	9.74	0.15	9.93	33.94	60.00	-26.06	QP	NEUTRAL
12	17.76	3.84	9.74	0.15	9.93	23.66	50.00	-26.34	Average	NEUTRAL

Note:

1. Result Level = Read Level + LISN Factor + Pulse Limiter Factor + Cable loss.
2. If QP Result complies with AV limit, AV Result is deemed to comply with AV limit.
3. Test setup: RBW: 200 Hz (9 kHz—150 kHz), 9 kHz (150 kHz—30 MHz).
4. Step size: 80Hz (0.009MHz-0.15MHz), 4 kHz (0.15MHz-30MHz), Scan time: auto.

TR-4-E-010 Conducted Emission Test Result

Test Site : DDT 1# Shield Room D:\2021 CE report date\Q21042025-1E\CE.EM6
Test Date : 2021-05-11 **Tested By** : Chunchieh Huang
EUT : SOUNDBAR **Model Number** : Bar 2.1 Deep Bass CNTR
Power Supply : AC 120V/60Hz **Test Mode** : Tx mode
Condition : TEMP:24.8°C, RH:53.8%, BP:101.4kPa **LISN** : 2020 ENV 216 1#/LINE

Memo :

Data: 136

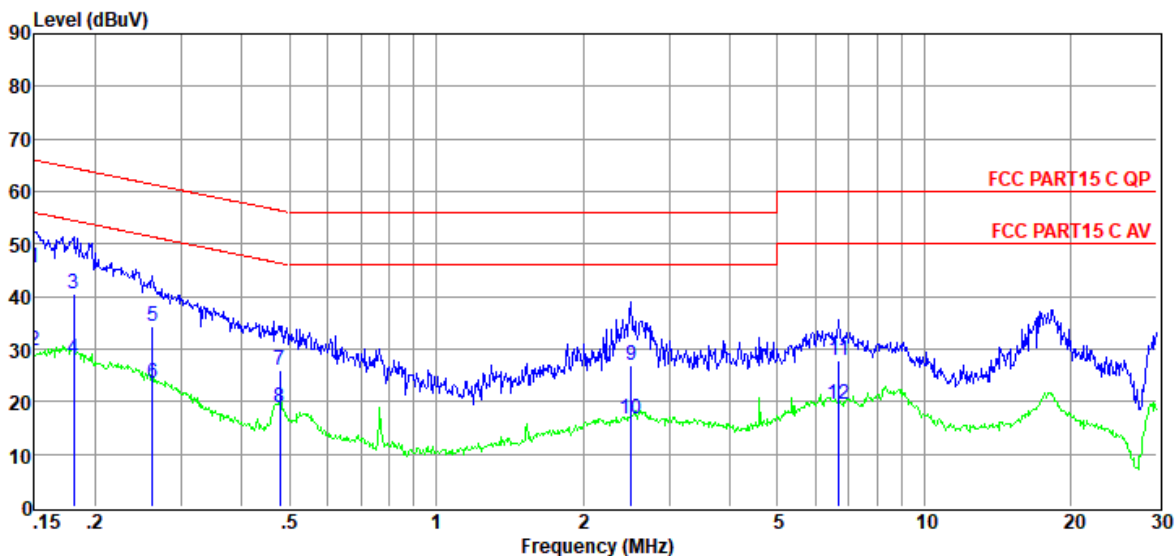

Item (Mark)	Freq. (MHz)	Read Level (dBuV)	LISN Factor (dB)	Cable Loss (dB)	Pulse Limiter Factor (dB)	Result Level (dBuV)	Limit Line (dBuV)	Over Limit (dB)	Detector	Phase
1	0.15	26.20	9.39	0.02	9.86	45.47	66.00	-20.53	QP	LINE
2	0.15	10.55	9.39	0.02	9.86	29.82	56.00	-26.18	Average	LINE
3	0.18	21.14	9.40	0.02	9.86	40.42	64.46	-24.04	QP	LINE
4	0.18	8.86	9.40	0.02	9.86	28.14	54.46	-26.32	Average	LINE
5	0.26	14.98	9.41	0.02	9.86	34.27	61.38	-27.11	QP	LINE
6	0.26	4.10	9.41	0.02	9.86	23.39	51.38	-27.99	Average	LINE
7	0.48	6.74	9.41	0.02	9.86	26.03	56.36	-30.33	QP	LINE
8	0.48	-0.54	9.41	0.02	9.86	18.75	46.36	-27.61	Average	LINE
9	2.51	7.55	9.43	0.06	9.87	26.91	56.00	-29.09	QP	LINE
10	2.51	-2.79	9.43	0.06	9.87	16.57	46.00	-29.43	Average	LINE
11	6.70	8.40	9.54	0.09	9.88	27.91	60.00	-32.09	QP	LINE
12	6.70	0.04	9.54	0.09	9.88	19.55	50.00	-30.45	Average	LINE

Note:

1. Result Level = Read Level + LISN Factor + Pulse Limiter Factor + Cable loss.
2. If QP Result complies with AV limit, AV Result is deemed to comply with AV limit.
3. Test setup: RBW: 200 Hz (9 kHz—150 kHz), 9 kHz (150 kHz—30 MHz).
4. Step size: 80Hz (0.009MHz-0.15MHz), 4 kHz (0.15MHz-30MHz), Scan time: auto.

9. Antenna Requirements

9.1. Limit

For intentional device, according to FCC 47 CFR Section 15.203, an intentional radiator shall be designed to ensure that no antenna other than that furnished by the responsible party shall be used with the device.

9.2. Result

The antennas used for this product are integral PCB antenna and that no antenna other than that furnished by the responsible party shall be used with the device, the maximum peak gain of the transmit antenna is only 1.57 dBi.

END OF REPORT