



Bar 300 - Sound bar

CMF + Artworks **V27** - 31/03/2022

Artwork update history

[...]

06-JAN-2022 - ANDRIANEOLY Soarivo - V22

12-JAN-2022 - ANDRIANEOLY Soarivo - V23

14-JAN-2022 - ANDRIANEOLY Soarivo - V24

21-FEB-2022 - ZHANG Doris & ANDRIANOELY Soarivo - V25

07-MAR-2022 - ANDRIANOELY Soarivo - V26

31-MAR-2022 - ANDRIANOELY Soarivo - V27



Bar 300 : Document Updates History





Bar 300 : Document Updates History

Artwork update history

[...]

V22 - Bottom outline updated/ SN sticker added on bar and subwoofer

V23 - RC Power key finish corrected/ SN sticker updated on bar and subwoofer

V24 - RC Power key finish updated/ IO connectors silk print updated

V25 - Compliance updated

V26 - RC Dolby icon updated

V27 - Bar and RC silk print color change/ IO wording scale up

V27

Bar:

IO connectors names silkprint colors change to

Pantone cool Gray 8C

IO connectors "wordings" scale up

RC:

Buttons Icons silkprint colors change to Pantone
cool Gray 8C

Subwoofer:



BAR BODY

Color: Pantone 10393C
Material: Plastic
Finish: Satin Paint
Top panel deco and bar body are the same component but with different tooling texture

LOGO

Color: Pantone Black 6C
Material: Ink
Debossed plastic
Finish: Matte
Dimension Follow 3D

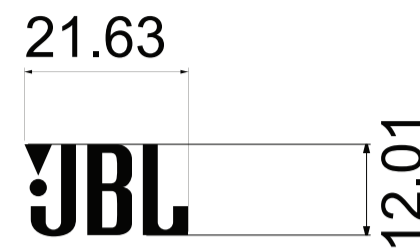

TOP PANEL DECO

Color: Pantone 10393C
Material: Plastic
Finish: Satin Paint
Texture VDI 36

Top panel deco and bar body are the same component but with different tooling texture

LED

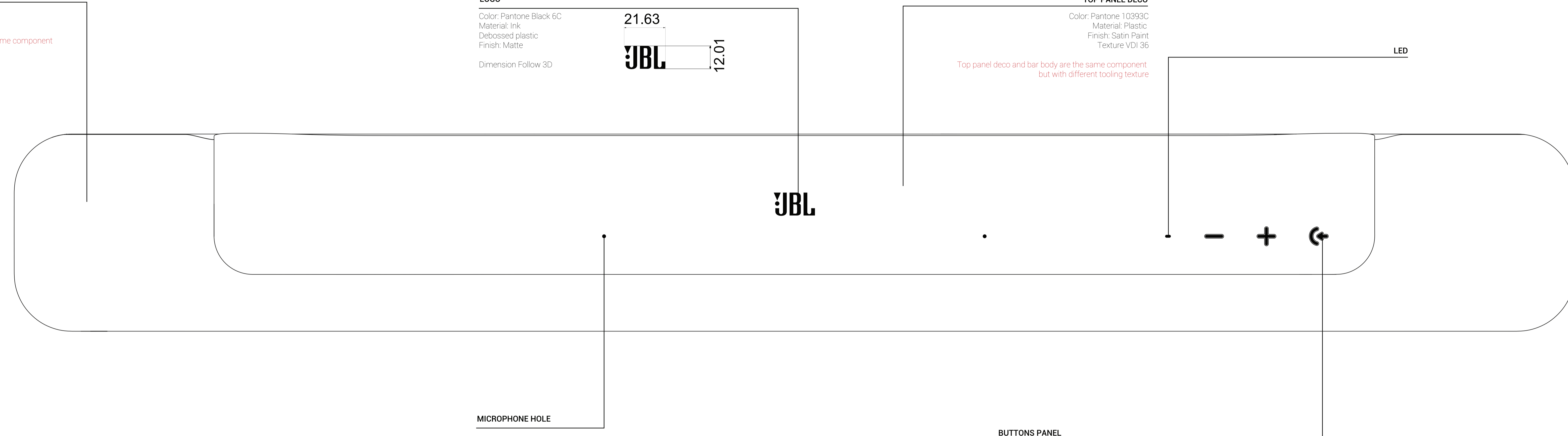

MICROPHONE HOLE

BUTTONS PANEL

Color: Pantone 10393C
Material: Hard Plastic
Finish: Matte Paint
Texture VDI 30



Dimension Follow 3D

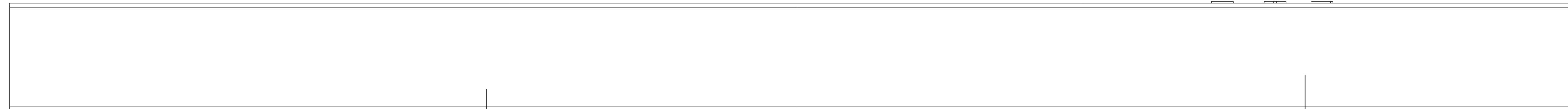

ACOUSTIC FABRIC - Behind metal grille
Color: Pantone Black C
Material: Acoustic Fabric
Finish: Matte

BODY METAL GRILLE
DOTS PATTERN
Color: Pantone 10393C
Material: Sand Blasted Metal
Finish: Satin Paint
Grille pattern: 0.6T/0.8W/1.25P
Black Felt under Grille
Approx. 3.325 mm blank area along top to bottom edges



Note of Metal Grille on Side
3.325 mm blank edge along with Top and Bottom panels
Metal Grill refer to Artwork below

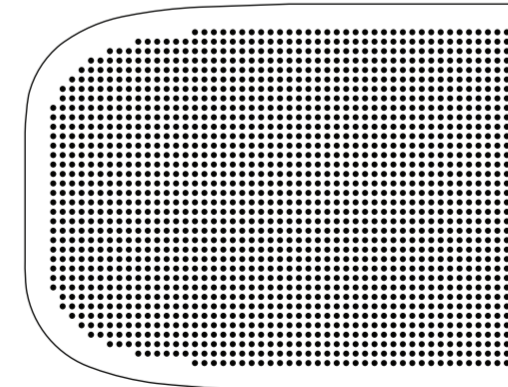

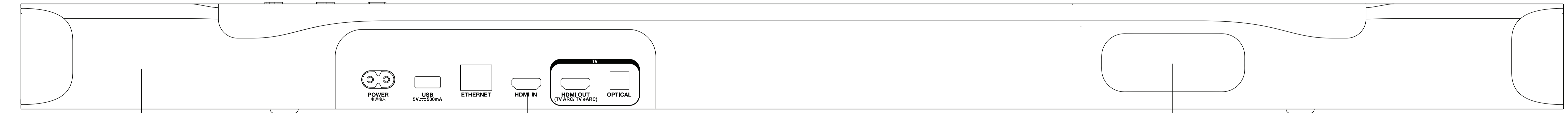

BOTTOM BODY
Color: Pantone 10393C
Material: Hard Plastic
Finish: Satin Paint

IO CONNECTORS NAMES
Color: Pantone Cool Gray 8C
Material: Silk screen Icons
Finish: Matte

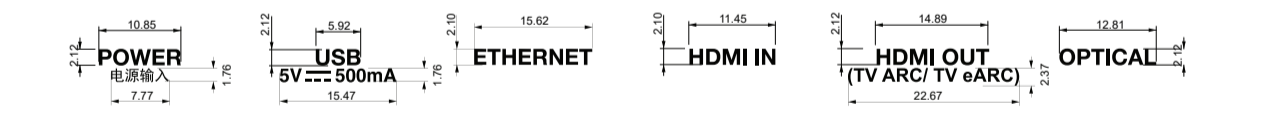

BASS PORT
Color: Pantone 432C
Material: Hard Plastic

HDMI Plug Cable
Material: According to EE standard
Finish: Matte + Spray paint
Reference: Sonos Beam cable
Color: Pantone Black 6C

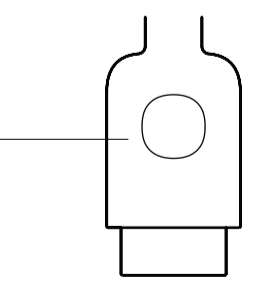

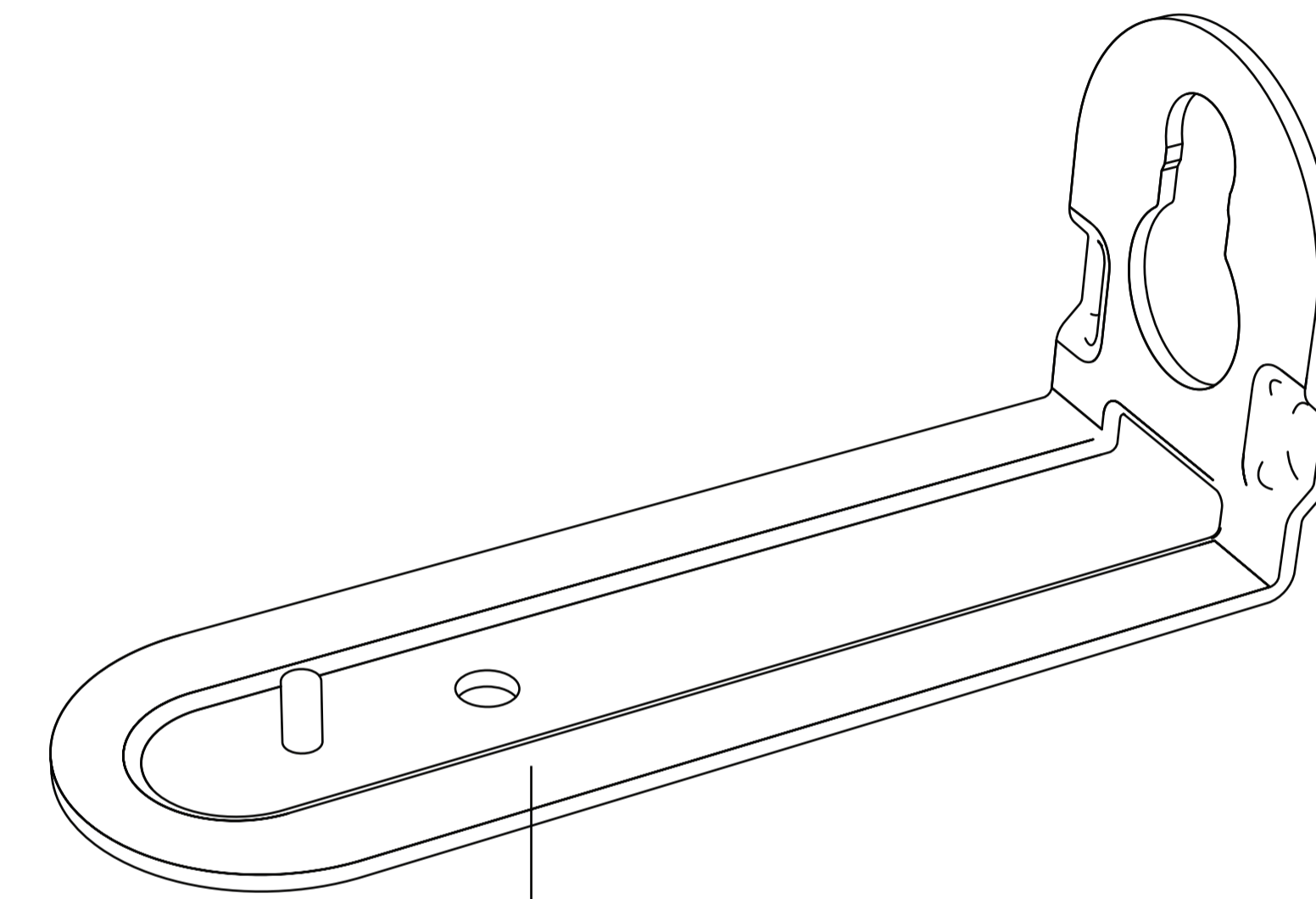

BRACKET
Color: Pantone Black 6C
Material: Metal
Finish: Matte - Spray paint

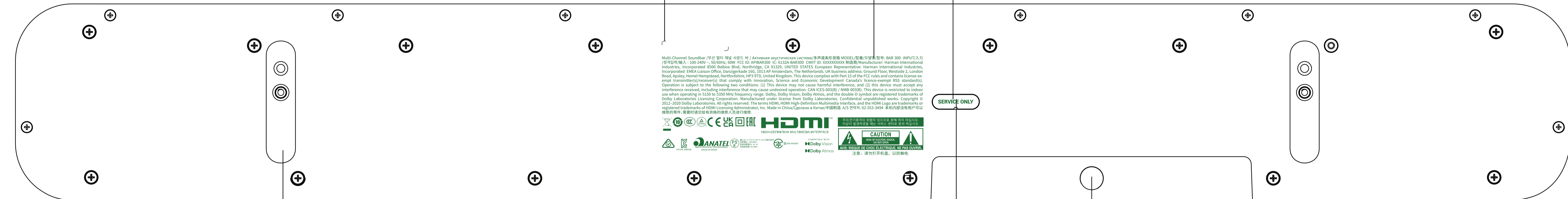

SN STICKER
Color: Pantone Black 6C
Material: Silk Print
Finish: Matte

COMPLIANCES
Color: Pantone Black 6C
Material: Silk Print
Finish: Matte

USB SERVICE ONLY CAP
Color: Pantone 10393C
Material: Hard Plastic
Finish: Satin Paint

BAR RUBBER RING & FEET
Color: Pantone Black 6C
Material: Rubber
Finish: Soft touch

SERVICE ONLY
Color: Pantone Black 6C
Material: Silk Print
Finish: Matte

SCREW CAP
Color: Pantone 10393C
Material: Hard Plastic
Finish: Satin Paint

Multi-Channel Soundbar / 多声道环绕声系统 / 多声道环绕声系统 MODEL/型号/型号: BAR 300 INPUT/输入 / 输入: 100-240V ~ 50/60Hz, 60W FCC ID: A19BAR300 IC: 6132A, BAR300 CHIT ID: XXXXXXXX Manufacturer: Harman International Industries, Incorporated 8000 Balboa Blvd, Northridge, CA 91329, UNITED STATES European Representative: Harman International Industries, Incorporated EMA Liaison Office, Danzigerade 166, 1013 AP Amsterdam, The Netherlands UK Business address: Ground Floor, Westside 2, London Road, Andley, Hemel Hempstead, Hertfordshire, HX1 9TE, United Kingdom. This device complies with Part 15 of the FCC rules and contains license-exempt transmitter(s)/receiver(s) that comply with Innovation, Science and Economic Development Canada's license-exempt RSS standard(s). Operation is subject to the following two conditions: (1) This device may not cause harmful interference, and (2) this device must accept any interference received, including interference that may cause undesired operation. CAN ICES 0038 / NMB 0038. This device is restricted to indoor use when operating in 5200 to 5300 MHz frequency range. Dolby, Dolby Vision, Dolby Atmos, and the double-D symbol are registered trademarks of Dolby Laboratories Licensing Corporation. Manufactured under license from Dolby Laboratories. Confidential unpublished works. Copyright © 2012-2020 Dolby Laboratories. All rights reserved. The terms HDMI, HDMI High Definition Multimedia Interface, and the HDMI logo are trademarks or registered trademarks of HDMI Licensing Administrator, Inc. Made in China/Сделано в Китае/中国制造 AS 型号号: 03-553-3494 本机内部没有用户可以更换零件, 维修请联系专业的维修人员, 请勿自行维修。

SERVICE ONLY

SERVICE ONLY

SERVICE ONLY



BAR 300: RC View - OUTSIDE PART - Scale 1:1

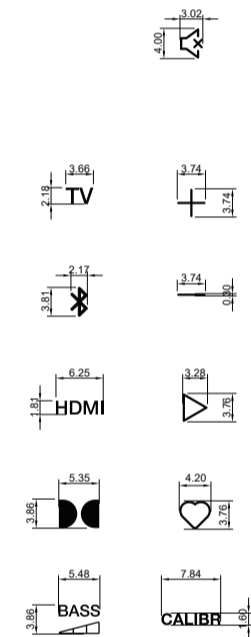

BUTTONS - ICONS

Buttons

Color: Pantone 432C
Material: Plastic
Finish: Tooling Texture VDI 30

Icons

Color: Pantone Cool Gray 8C
Material: Silk Print Icons
Finish: Matte

FRONT COVER PART 1

Color: Pantone 432C
Material: Plastic
Finish: Tooling Texture VDI 30

JBL LOGO

Color: Pantone 432C
Material: Hard Plastic
Debossed
Finish: In mold High Glossy

Dimension: Follow artwork & 3D

POWER BUTTON

Color: Pantone Black 6C
Material: Hard Plastic
Finish: Matte painting
Dimension Follow 3D

BUTTONS & ICONS

Buttons

Color: Pantone 432C
Material: Plastic
Finish: Tooling Texture VDI 27

Icons

Color: Pantone Cool Gray 8C
Material: Silk Print Icons
Finish: Matte

FRONT COVER PART 2

Color: Pantone 432C
Material: Plastic
Finish: Tooling Texture VDI 27

INFRA RED

Color: Pantone Black 6C
Material: Plastic
Finish: High Glossy

BACK COVER

Color: Pantone 432C
Material: Hard Plastic
Finish: Tooling Texture VDI 27

GRIP PATTERN

Follow 3D

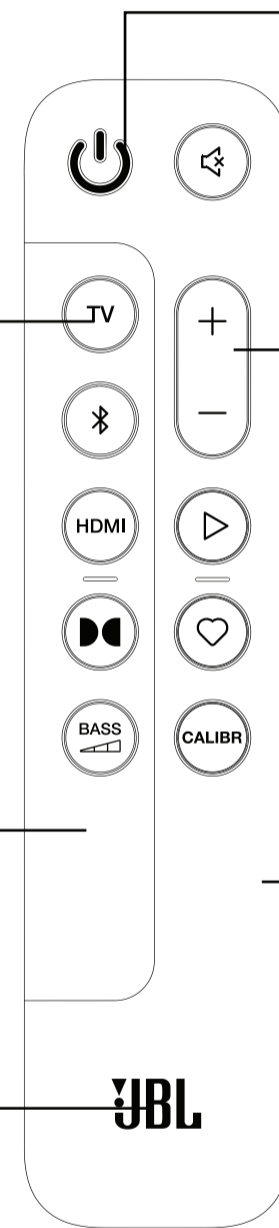



INNER COVER

Color: Pantone Black 6C
Material: Hard Plastic
Finish: cf Inner cover text ref A picture

COMPLIANCE

Color: Transparent
Material: Silk Print
Finish: High Glossy

Battery Notch

color: Pantone Black 6C
material: Plastic
finishes: In mold color - Matte
Reference: 2nd GEN RC

Battery Icon

color: Pantone Black 6C
material: Plastic
finishes: In mold color - Semi Shiny
0.15mm debossed

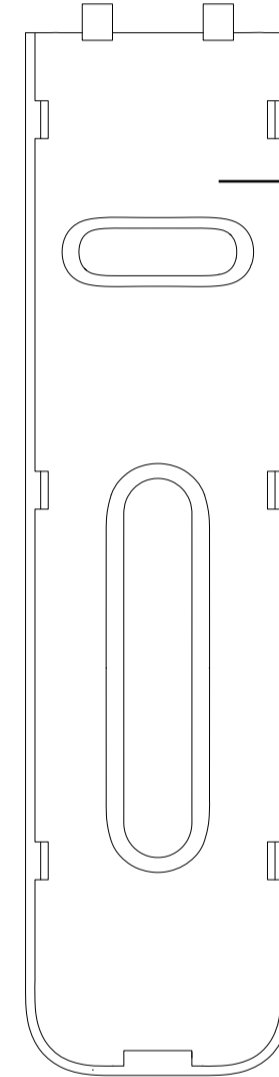
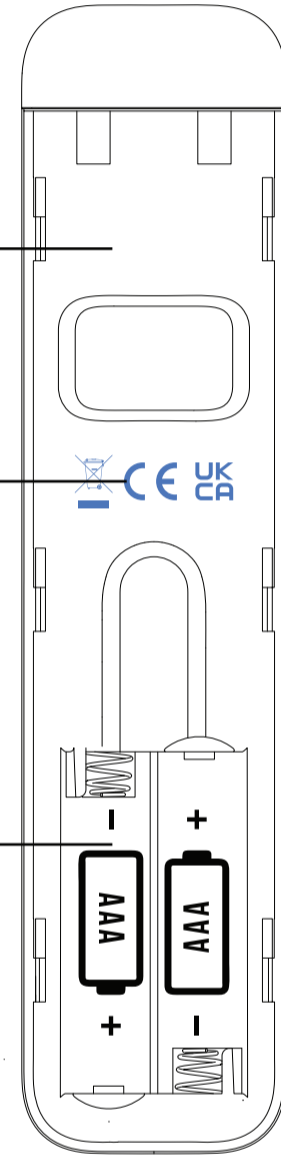
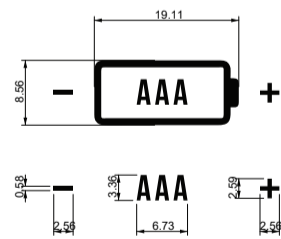

INNER BACK COVER 1

Color: Pantone 432C
Material: Hard Plastic
Finish: cf Inner back cover text ref B - picture below

