



CRUISE



1 What's in the box



x 2

Design for M10 PE bag



M10 bolt
x 2



M10 Adjust screw
x 2



M10 Nut
x 4

Ø10 Spring washer for M10 x 4
Ø10 washer for M10 x 4

Design for MS PE bag



MS#60 bolt
x 2



Adjust screw MS
x 2

Design for Design for Harley
Davidson 1200 custom PE bag



MS#90 bolt
x 2



UNF5/16 '' Adjust screw
x 2



UNF5/16 '' Nut
x 2

Share parts for M8&Harley
Davidson 1200 custom PE bag



M8 Nut
x 6



Ø8.5 Spring washer
x 8



Ø8.5 washer
x 8

2 Buttons

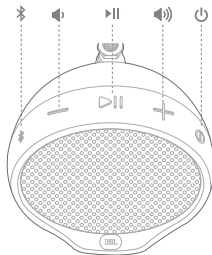

3 Speaker for M10 installation

1. Disassemble left M10 mirror from motorcycle

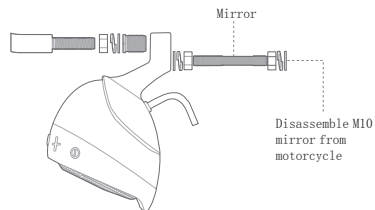

2: Take the M10 bolt with M10 nut 2pcs, €10.5 washer 2pcs and €10.5 spring washer 2pcs from M10 PE bag

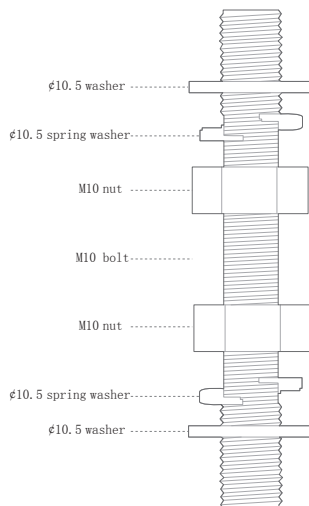

3. Screw M10 bolt into the left speaker holder

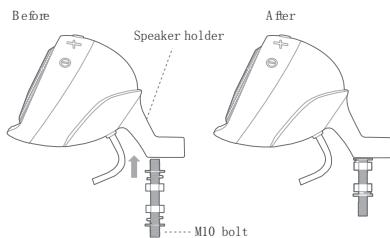

4. Screw M10 bolt into left motorcycle mirror hole

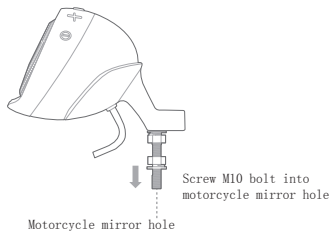

5. Screw M10 Adjust screw into left speaker holder hole

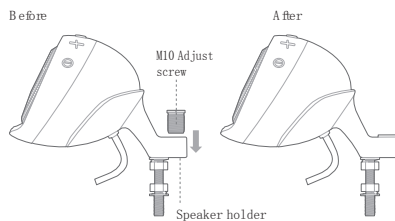

6. Screw the M10 mirror into left speaker holder

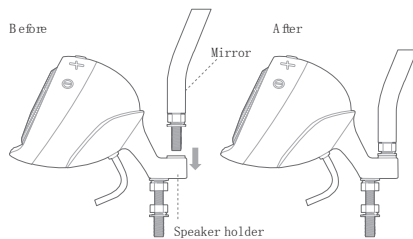

4 Speaker for M8 installation

1. Disassemble M8 mirror from motorcycle

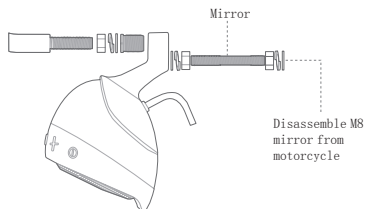

2: Take the M8*60 bolt from M8 PE bag and take M8 nut 2pcs, $\varnothing 8.5$ washer 2pcs and $\varnothing 8.5$ spring washer 2pcs from share part PE bag

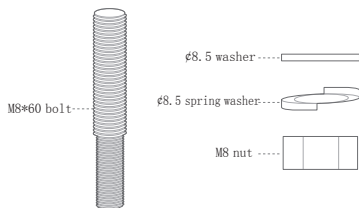

3. Screw M8 nut, $\varnothing 8.5$ washer and $\varnothing 8.5$ spring washer onto M8*60 bolt

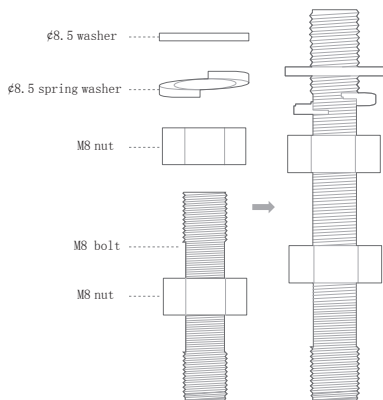

4. Screw M8*60 bolt into the Left speaker holder

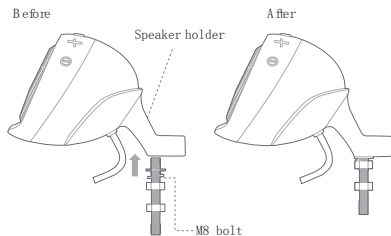

5. Screw M8*60 bolt into left mirror hole after assembled $\phi 8.5$ spring washer, $\phi 8.5$ washer on it.

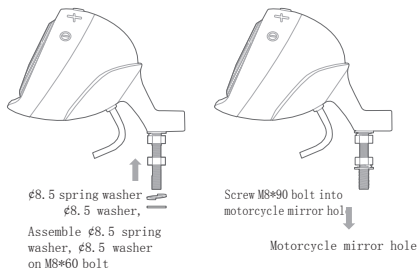

6. Screw M8 Adjust screw into hole of the left speaker holder

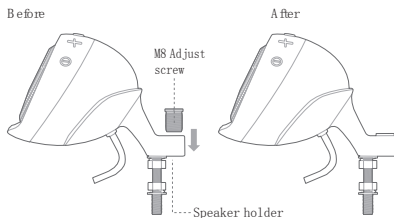

7. Screw M8 Left mirror into speaker holder hole

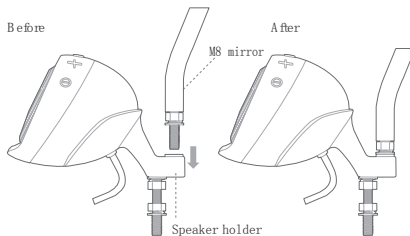

5 Speaker for Harley Davidson 1200 custom installation

1. Disassemble UNF5/16" left mirror from motorcycle

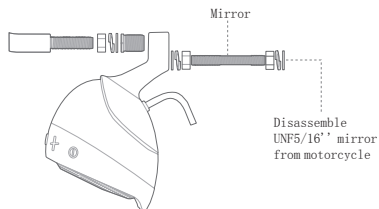

2: Take the M8*90 bolt from Design for Harley Davidson 1200 custom PE bag and take M8 nut 3pcs, ø8.5 washer 3pcs and ø8.5 spring washer 3pcs from share part PE bag

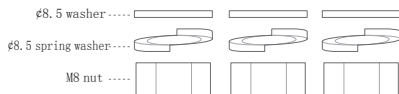
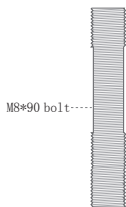

3. Screw M8 nut, ø8.5 washer and ø8.5 spring washer onto M8*90 bolt

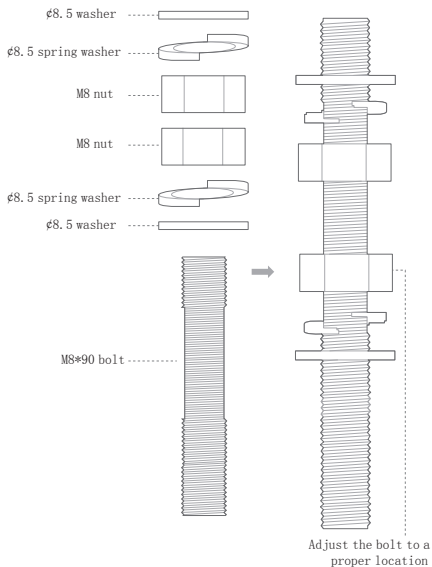

4. Screw M8*60 bolt into the Left speaker holder

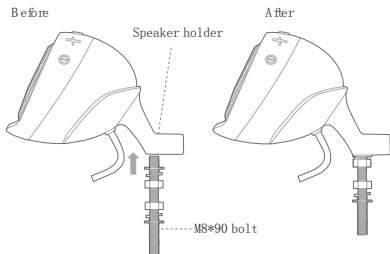

5. Screw M8*90 bolt into left mirror hole after assembled #8.5 washer, #8.5 spring washer, M8 nut on it.

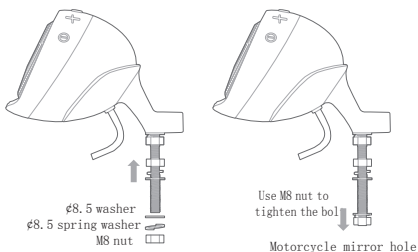

Assemble #8.5 spring washer, #8.5 washer on M8*90 bolt

6. Screw UNF5/16" Adjust screw into hole of the left speaker holder

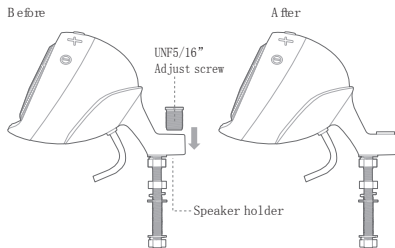

7. Screw UNF5/16" nut, #8.5 washer and #8.5 spring washer onto mirror bolt

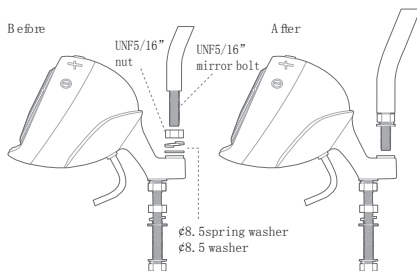

8. Screw UNF5/16" Left mirror into speaker holder hole

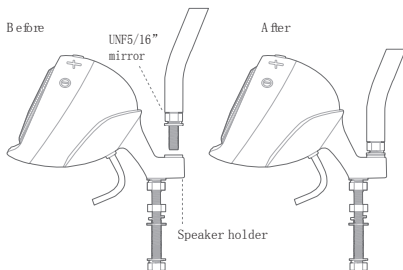

6 Bluetooth* pairing mode

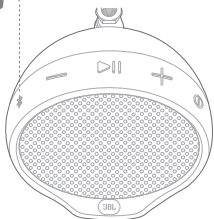

Short press to enter Bluetooth pairing mode

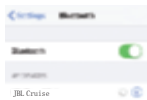

Choose "JBL Cruise" to connect

7 LED indication

EN

Status	LED indication
➤ Pairing mode	🔴 Blinking
➤ Power on, no BT	🔵 Slow blinking
➤ Bluetooth connected	🟢 On

8 USB port on right speaker

5W output to charge smart phone

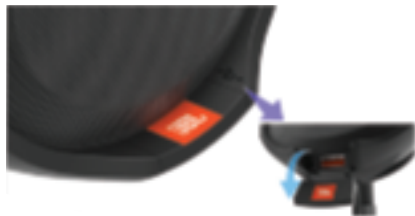

9 **WARNING**

THERE MAY BE UNEXPECTED SHAKE AND VIBRATION DURING YOUR DRIVE. PLEASE MAKE SURE THE SPEAKER IS MOUNTED TIGHTLY TO YOUR VISOR AND WON'T FALL DOWN DURING YOUR DRIVE.

10 Specifications

EN

- Transducer: 2 x 65mm
- Rated Power: 2 x 20W
- Operation Frequency: 2402MHz - 2480MHz
- Max Output Power: <4dBm
- Bluetooth Version: 3.0
- Support: A2DP V1.3, AVRCP V1.4
- Multi-points (up to 2 phones)
- Dimensions (H x W x D): 100mm x 609mm x 160mm
- Weight: 350g

Торговая марка	: JBL
Назначение товара	: АКТИВНАЯ АКУСТИЧЕСКАЯ СИСТЕМА
Изготовитель	: ХАРМАН ИНТЕРНЭШН ЛИНДАСТРИЗ ИНКОРПОРЕЙТЕД, США, 06901 ВОННЕКТИКУТ, Г.С.ТЭМФОРД, АТЛАНТИК СТРИТ100, ОФИС 1500
Страна происхождения	: Китай
Импортер в Россию	: ООО "ХАРМАН РУС СиАйЭс", РОССИЯ, 123137, МОСКВА, ПРЯВЕНЕНСКАЯ НАБ, Д. 10
Гарантийный период	: 1 год
Информация о сервисных центрах	: www.harman.com/russia , +7-800-700-0467
Срок службы	: 5 лет
Срок хранения	: неограничен
Условия хранения	: Стандартные при нормальных значениях климатических факторов внешней среды
Номер документа соответствия	: Товарсертифицирован EAC
Дата производства	: Дата изготовления устройства определяется по двум буквенным обозначениям на второй группы символов серийного номера изделия, следующих после разделительного знака «-». Кодировка соответствует порядку букв латинского алфавита, начиная с января 2010 года: 000000-MY0000000, где «M» - месяц производства (А - январь, В - февраль, С - март и т.д.) и «Y» - год производства (А - 2010, В - 2011, С - 2012 и т.д.).



Este equipamento opera em caráter secundário, isto é, não tem direito a proteção contra interferência prejudicial, mesmo de estações do mesmo tipo, e não pode causar interferência a sistemas operando em caráter primário*

Este produto está homologado pela ANATEL, de acordo com os procedimentos regulamentados pela Resolução 242/2000, e atende aos requisitos técnicos aplicados.

Para maiores informações, consulte o site da ANATEL - www.anatel.gov.br



The Bluetooth word mark and logos are registered trademarks owned by Bluetooth SIG, Inc. and any use of such marks by HARMAN International Industries, Incorporated is under license. Other trademarks and trade names are those of their respective owners.