



Prüfbericht-Nr.: Test report no.:	CN23FUH4 001	Auftrags-Nr.: Order no.:	168453215	Page 1 of 25 Seite 1 von 25
Kunden-Referenz-Nr.: Client reference no.:	N/A	Auftragsdatum: Order date:	2023-11-24	
Auftraggeber: Client:	Harman International Industries, Incorporated 8500 Balboa Blvd, Northridge, California, 91329, United States			
Prüfgegenstand: Test item:	Bluetooth Module			
Bezeichnung / Typ-Nr.: Identification / Type no.:	AC6951 (Trademark: JBL)			
Auftrags-Inhalt: Order content:	Type test			
Prüfgrundlage: Test specification:	CFR47 FCC Part 15: Subpart C Section 15.247 RSS-247-Issue 3 August 2023 CFR47 FCC Part 15: Subpart C Section 15.207 RSS-Gen Issue 5 March 2019 CFR47 FCC Part 15: Subpart C Section 15.209			
Wareneingangsdatum: Date of sample receipt:	2023-11-21	Refer to photos document		
Prüfmuster-Nr.: Test sample no.:	A003605155			
Prüfzeitraum: Testing period:	2023-12-12 – 2024-01-24			
Ort der Prüfung: Place of testing:	TÜV Rheinland (Shenzhen) Co., Ltd.			
Prüflaboratorium: Testing laboratory:	TÜV Rheinland (Shenzhen) Co., Ltd.			
Prüfergebnis*: Test result*:	Pass			
geprüft von: tested by:		genehmigt von: authorized by:		
Datum: Date:	2024-01-29 <small>Signed by: Harry W. C. Wu</small>	Ausstellungsdatum: Issue date:	2024-01-29 <small>Signed by: Alex Lan</small>	
Stellung / Position:	Project Manager	Stellung / Position:	Reviewer	
Sonstiges / Other:	FCC ID: API-AC6951 IC: 6132A-AC6951 HVIN: AC6951			
Zustand des Prüfgegenstandes bei Anlieferung: Condition of the test item at delivery:	Prüfmuster vollständig und unbeschädigt Test item complete and undamaged			
* Legende:	P(ass) = entspricht o.g. Prüfgrundlage(n)	F(ail) = entspricht nicht o.g. Prüfgrundlage(n)	N/A = nicht anwendbar	N/T = nicht getestet
* Legend:	P(ass) = passed a.m. test specification(s)	F(ail) = failed a.m. test specification(s)	N/A = not applicable	N/T = not tested
Dieser Prüfbericht bezieht sich nur auf das o.g. Prüfmuster und darf ohne Genehmigung der Prüfstelle nicht auszugsweise vervielfältigt werden. Dieser Bericht berechtigt nicht zur Verwendung eines Prüfzeichens. <i>This test report only relates to the above mentioned test sample. Without permission of the test center this test report is not permitted to be duplicated in extracts. This test report does not entitle to carry any test mark.</i>				

v05

Prüfbericht-Nr.: CN23FUH4 001
Test report no.:

Page 2 of 25
Seite 2 von 25

Remarks
Anmerkungen

<p>1</p>	<p>The equipment used during the specified testing period was calibrated according to our test laboratory calibration program. The equipment fulfils the requirements included in the relevant standards. The traceability of the test equipment used is ensured by compliance with the regulations of our management system. Detailed information regarding test conditions, equipment and measurement uncertainty is available in the test laboratory and could be provided on request.</p> <p><i>Alle eingesetzten Prüfmittel waren zum angegebenen Prüfzeitraum gemäß eines festgelegten Kalibrierungsprogramms unseres Prüfhauses kalibriert. Sie entsprechen den in den Prüfprogrammen hinterlegten Anforderungen. Die Rückverfolgbarkeit der eingesetzten Prüfmittel ist durch die Einhaltung der Regelungen unseres Managementsystems gegeben. Detaillierte Informationen bezüglich Prüfbedingungen, Prüfequipment und Messunsicherheiten sind im Prüflabor vorhanden und können auf Wunsch bereitgestellt werden.</i></p>
<p>2</p>	<p>As contractually agreed, this document has been signed digitally only. TÜV Rheinland has not verified and unable to verify which legal or other pertaining requirements are applicable for this document. Such verification is within the responsibility of the user of this document. Upon request by its client, TÜV Rheinland can confirm the validity of the digital signature by a separate document. Such request shall be addressed to our Sales department. An environmental fee for such additional service will be charged.</p> <p><i>Wie vertraglich vereinbart, wurde dieses Dokument nur digital unterzeichnet. Der TÜV Rheinland hat nicht überprüft, welche rechtlichen oder sonstigen diesbezüglichen Anforderungen für dieses Dokument gelten. Diese Überprüfung liegt in der Verantwortung des Benutzers dieses Dokuments. Auf Verlangen des Kunden kann der TÜV Rheinland die Gültigkeit der digitalen Signatur durch ein gesondertes Dokument bestätigen. Diese Anfrage ist an unseren Vertrieb zu richten. Eine Umweltgebühr für einen solchen zusätzlichen Service wird erhoben.</i></p>
<p>3</p>	<p>Test clauses with remark of * are subcontracted to qualified subcontractors and described under the respective test clause in the report. Deviations of testing specification(s) or customer requirements are listed in specific test clause in the report.</p> <p><i>Prüfklausel mit der Note * wurden an qualifizierte Unterauftragnehmer vergeben und sind unter der jeweiligen Prüfklausel des Berichts beschrieben. Abweichungen von Prüfspezifikation(en) oder Kundenanforderungen sind in der jeweiligen Prüfklausel im Bericht aufgeführt.</i></p>
<p>4</p>	<p>The decision rule for statements of conformity, based on numerical measurement results, in this test report is based on the "Zero Guard Band Rule" and "Simple Acceptance" in accordance with ILAC G8:2019 and IEC Guide 115:2021, unless otherwise specified in the applied standard mentioned on Page 1 of this report or requested by the customer. This means that measurement uncertainty is not taken in account and hence also not declared in the test report. For additional information to the resulting risk based of this decision rule please refer to ILAC G8:2019.</p> <p><i>Die Entscheidungsregel für Konformitätserklärungen basierend auf numerischen Messergebnissen in diesem Prüfbericht basiert auf der "Null-Grenzwert-Regel" und der "Einfachen Akzeptanz" gemäß ILAC G8:2019 und IEC Guide 115:2021, es sei denn, in der auf Seite 1 dieses Berichts genannten angewandten Norm ist etwas anderes festgelegt oder vom Kunden gewünscht. Dies bedeutet, dass die Messunsicherheit nicht berücksichtigt wird und daher auch nicht im Prüfbericht angegeben wird. Zu weiteren Informationen bezüglich des Risikos durch diese Entscheidungsregel siehe ILAC G8:2019.</i></p>

Prüfbericht-Nr.: CN23FUH4 001
Test report no.:Seite 3 von 25
Page 3 of 25

Test Summary

5.1.1 ANTENNA REQUIREMENT*RESULT: Pass***5.1.2 MAXIMUM CONDUCTED OUTPUT POWER***RESULT: Pass***5.1.3 99% BANDWIDTH***RESULT: Pass***5.1.4 CONDUCTED SPURIOUS EMISSIONS MEASURED IN 100 KHz BANDWIDTH***RESULT: Pass***5.1.5 RADIATED SPURIOUS EMISSION***RESULT: Pass***5.1.6 20dB BANDWIDTH***RESULT: Pass***5.1.7 CARRIER FREQUENCY SEPARATION***RESULT: Pass***5.1.8 FREQUENCY STABILITY***RESULT: Pass***5.1.9 NUMBER OF HOPPING FREQUENCY***RESULT: Pass***5.1.10 TIME OF OCCUPANCY***RESULT: Pass***5.1.11 CONDUCTED EMISSION ON AC MAINS***RESULT: Pass*

Prüfbericht-Nr.: CN23FUH4 001
Test report no.:

 Seite 4 von 25
 Page 4 of 25

Contents

1	GENERAL REMARKS	5
1.1	COMPLEMENTARY MATERIALS	5
2	TEST SITES.....	5
2.1	TEST FACILITIES.....	5
2.2	LIST OF TEST AND MEASUREMENT INSTRUMENTS	6
2.3	TRACEABILITY.....	7
2.4	CALIBRATION	7
2.5	MEASUREMENT UNCERTAINTY	7
2.6	LOCATION OF ORIGINAL DATA	7
2.7	STATUS OF FACILITY USED FOR TESTING.....	7
3	GENERAL PRODUCT INFORMATION.....	8
3.1	PRODUCT FUNCTION AND INTENDED USE.....	8
3.2	RATINGS AND SYSTEM DETAILS	8
3.3	INDEPENDENT OPERATION MODES	10
3.4	NOISE GENERATING AND NOISE SUPPRESSING PARTS.....	10
3.5	SUBMITTED DOCUMENTS.....	10
4	TEST SET-UP AND OPERATION MODES	11
4.1	PRINCIPLE OF CONFIGURATION SELECTION.....	11
4.2	TEST OPERATION AND TEST SOFTWARE.....	11
4.3	SPECIAL ACCESSORIES AND AUXILIARY EQUIPMENT.....	11
4.4	COUNTERMEASURES TO ACHIEVE EMC COMPLIANCE.....	11
4.5	TEST SETUP DIAGRAM	12
5	TEST RESULTS.....	14
5.1	TRANSMITTER REQUIREMENT & TEST SUITES.....	14
5.1.1	<i>Antenna Requirement.....</i>	<i>14</i>
5.1.2	<i>Maximum Conducted Output Power</i>	<i>15</i>
5.1.3	<i>99% Bandwidth</i>	<i>16</i>
5.1.4	<i>Conducted Spurious Emissions Measured in 100 kHz Bandwidth</i>	<i>17</i>
5.1.5	<i>Radiated Spurious Emission.....</i>	<i>18</i>
5.1.6	<i>20dB Bandwidth</i>	<i>19</i>
5.1.7	<i>Carrier Frequency Separation.....</i>	<i>20</i>
5.1.8	<i>Frequency stability</i>	<i>21</i>
5.1.9	<i>Number of Hopping Frequency.....</i>	<i>22</i>
5.1.10	<i>Time of Occupancy</i>	<i>23</i>
5.1.11	<i>Conducted Emission on AC Mains.....</i>	<i>24</i>
6	PHOTOGRAPHS OF THE TEST SET-UP.....	25
7	LIST OF TABLES	25

Prüfbericht-Nr.: CN23FUH4 001
Test report no.:

Seite 5 von 25
Page 5 of 25

1 General Remarks

1.1 Complementary Materials

All attachments are integral parts of this test report. This applies especially to the following appendix:

Appendix A: Test Results of Classical Bluetooth.

Appendix B: Photographs of the Test Set-up.

2 Test Sites

2.1 Test Facilities

TÜV Rheinland (Shenzhen) Co., Ltd.

No.362, Huanguan Middle Road, Songyuansha Community, Guanhu Subdistrict, Longhua District, Shenzhen, Guangdong, China/518110

FCC Registration No.: 694916

IC Registration No.: 25069 and the CAB identifier is CN0078.

Prüfbericht-Nr.: CN23FUH4 001
Test report no.:

 Seite 6 von 25
 Page 6 of 25

2.2 List of Test and Measurement Instruments

Table 1: List of Test and Measurement Equipment

Radio Spectrum Testing (TS8997)				
Equipment	Manufacturer	Model	Serial No.	Cal. until
EXA Signal Analyzer, Multi-touch	Keysight	N9010B	MY60241175	21.09.2024
MXG X-Series RF Vector Signal Generator	Keysight	N5182B	MY61250137	21.09.2024
EXG X-Series Microwave Analog Signal Generator	Keysight	N5173B	MY61250141	21.09.2024
DC Power Supply	Keysight	E3642A	MY61276100	21.09.2024
Wireless Connectivity Tester	R&S	CMW270	102505	21.09.2024
Power Control Unit	Tonscend	JS0806-4ADC	N/A	21.09.2024
Automation Control Unit	Tonscend	JS0806-2	21C8060396	21.09.2024
Test Software	Tonscend	JS1120-3	N/A	N/A
Control PC	Lenovo	TianYi510S-071MB	YLX23JMF	N/A
Unwanted Emission Testing (TS9975)				
Equipment	Manufacturer	Model	Serial No.	Cal. until
EMI Test Receiver	R&S	ESR 7	102021	25.07.2024
Signal Analyzer	R&S	FSV 40	101439	25.07.2024
System Controller Interface	R&S	SCI-100	S10010038	N/A
Filterbank	R&S	Wlan	100759	25.07.2024
OSP	R&S	OSP 120	102040	N/A
Pre-amplifier	R&S	SCU08F1	08320031	25.07.2024
Amplifier	R&S	SCU-18F	180070	25.07.2024
Amplifier	R&S	SCU40A	100475	25.07.2024
Trilog Broadband Antenna (30 MHz - 7 GHz)	Schwarzbeck	VULB 9162	193	06.08.2024
Double-Ridged Antenna (1 -18 GHz)	ETS-LINDGREN	3117	00218717	06.08.2024
Wideband Ridged Horn Antenna (18-40 GHz)	Steatite	QMS-00880	19067	27.08.2024
Active Loop Antenna	Schwarzbeck	FMZB 1513	302	06.08.2024
Test software	R&S	EMC32 (V10.60.10)	N/A	N/A
Control PC	Dell	OptiPlex 7050	36NV9P2	N/A
3m Semi-Anechoic Chamber	Albatross	SAC-3m	APC17151-SAC	22.06.2024
Conducted Emissions on AC Mains				
Equipment	Manufacturer	Model	Serial No.	Cal. until
EMI Test Receiver	R&S	ESR3	102428	30.07.2024
Artificial Mains Network	R&S	ENV216	102333	30.07.2024
EMC32 test software	R&S	EMC32(Ver.10.50.00)	N/A	N/A

Prüfbericht-Nr.: CN23FUH4 001
Test report no.:Seite 7 von 25
Page 7 of 25

2.3 Traceability

All measurement equipment calibrations are traceable to NIM (National Institute of Metrology) or where calibration is performed in other countries, to equivalent nationally recognized standards organizations.

2.4 Calibration

Equipment requiring calibration is calibrated periodically by the manufacturer or according to manufacturer's specifications. Additionally all equipment is verified for proper performance on a regular basis using in house standards or comparisons.

2.5 Measurement Uncertainty

The estimated combined standard uncertainty for radiated emissions and conducted emissions measurements as below table

Parameter	Uncertainty (k=2)
Occupied Channel Bandwidth	± 2.08 %
RF output power, conducted	± 0.99 dB
RF power density, conducted	± 0.99 dB
Unwanted Emissions, conducted	± 0.89 dB
All emissions, radiated	± 4.17 dB
Conducted Emission, (9kHz to 150kHz)/(150kHz to 30MHz)	± 3.70 dB / ± 3.30 dB

2.6 Location of Original Data

The original copies of all test data taken during actual testing were attached at Appendix A & B of this report and delivered to the applicant. A copy has been retained in the TÜV Rheinland (Shenzhen) file for certification follow-up purposes.

2.7 Status of Facility Used for Testing

The TÜV Rheinland (Shenzhen) Co., Ltd. Test facility located at No.362, Huanguan Middle Road, Songyuansha Community, Guanhu Subdistrict, Longhua District, Shenzhen, Guangdong, China/518110 is listed on the US Federal Communications Commission list of facilities approved to perform measurements.

Prüfbericht-Nr.: CN23FUH4 001
Test report no.:

 Seite 8 von 25
 Page 8 of 25

3 General Product Information

3.1 Product Function and Intended Use

The EUT is a Bluetooth module, which supports Bluetooth dual mode technology.

For details refer to the User Manual, Technical Description and Circuit Diagram.

3.2 Ratings and System Details

Table 2: Technical Specification of EUT

General Information of EUT	Value
Kind of Equipment	Bluetooth Module
Type Designation	AC6951
Trademark	JBL
FCC ID	API-AC6951
IC	6132A-AC6951
HVIN	AC6951
Extreme Temperature Range	-40°C to +85°C
Operating Voltage	DC 5V
Technical Specification of Classical Bluetooth	
Bluetooth Core Version	Bluetooth 5.3
Operating Frequency band	2402 ~ 2480 MHz
Channel Number	79 channels
Channel separation	1MHz
Modulation	GFSK, $\pi/4$ DQPSK
Antenna Type	Dipole Antenna
Antenna Gain	1.24 dBi (Provided by the Client)
Technical Specification of Bluetooth Low Energy	
Bluetooth Core Version	Bluetooth 5.3
Operating Frequency band	2402 ~ 2480 MHz
Channel Number	40 channels
Channel separation	2MHz
Data rate	1Mbps
Modulation	GFSK
Antenna Type	Dipole Antenna
Antenna Gain	1.24 dBi (Provided by the Client)

Prüfbericht-Nr.: CN23FUH4 001

Seite 9 von 25

Test report no.:

Page 9 of 25

Table 3: RF Channel and Frequency of Classic Bluetooth

RF Channel	Frequency (MHz)	RF Channel	Frequency (MHz)	RF Channel	Frequency (MHz)	RF Channel	Frequency (MHz)
00	2402.00	20	2422.00	40	2442.00	60	2462.00
01	2403.00	21	2423.00	41	2443.00	61	2463.00
02	2404.00	22	2424.00	42	2444.00	62	2464.00
03	2405.00	23	2425.00	43	2445.00	63	2465.00
04	2406.00	24	2426.00	44	2446.00	64	2466.00
05	2407.00	25	2427.00	45	2447.00	65	2467.00
06	2408.00	26	2428.00	46	2448.00	66	2468.00
07	2409.00	27	2429.00	47	2449.00	67	2469.00
08	2410.00	28	2430.00	48	2450.00	68	2470.00
09	2411.00	29	2431.00	49	2451.00	69	2471.00
10	2412.00	30	2432.00	50	2452.00	70	2472.00
11	2413.00	31	2433.00	51	2453.00	71	2473.00
12	2414.00	32	2434.00	52	2454.00	72	2474.00
13	2415.00	33	2435.00	53	2455.00	73	2475.00
14	2416.00	34	2436.00	54	2456.00	74	2476.00
15	2417.00	35	2437.00	55	2457.00	75	2477.00
16	2418.00	36	2438.00	56	2458.00	76	2478.00
17	2419.00	37	2439.00	57	2459.00	77	2479.00
18	2420.00	38	2440.00	58	2460.00	78	2480.00
19	2421.00	39	2441.00	59	2461.00	--	--

Table 4: RF Channel and Frequency of Bluetooth Low Energy

RF Channel	Frequency (MHz)	RF Channel	Frequency (MHz)	RF Channel	Frequency (MHz)	RF Channel	Frequency (MHz)
00	2402.00	10	2422.00	20	2442.00	30	2462.00
01	2404.00	11	2424.00	21	2444.00	31	2464.00
02	2406.00	12	2426.00	22	2446.00	32	2466.00
03	2408.00	13	2428.00	23	2448.00	33	2468.00
04	2410.00	14	2430.00	24	2450.00	34	2470.00
05	2412.00	15	2432.00	25	2452.00	35	2472.00
06	2414.00	16	2434.00	26	2454.00	36	2474.00
07	2416.00	17	2436.00	27	2456.00	37	2476.00
08	2418.00	18	2438.00	28	2458.00	38	2478.00
09	2420.00	19	2440.00	29	2460.00	39	2480.00

Prüfbericht-Nr.: CN23FUH4 001
Test report no.:Seite 10 von 25
Page 10 of 25

3.3 Independent Operation Modes

The basic operation modes are:

- A. On
 - 1. Bluetooth transmitting mode (BR & EDR mode)
 - a) Low Channel
 - b) Middle Channel
 - c) High Channel
- B. On, Transmitting on Hopping channel
- C. Off

3.4 Noise Generating and Noise Suppressing Parts

Refer to Circuit Diagram for further details.

3.5 Submitted Documents

- Application Form
- Block Diagram
- Schematics
- Technical Description
- FCC/IC Label and Location Info
- Photo Document
- User Manual

Prüfbericht-Nr.: CN23FUH4 001
Test report no.:Seite 11 von 25
Page 11 of 25

4 Test Set-up and Operation Modes

4.1 Principle of Configuration Selection

Radio Spectrum: The equipment under test (EUT) was configured at its highest power output in order to measure its highest possible radiation and conducted level. The test modes were adapted accordingly in reference to the instructions for use.

Emission: The equipment under test (EUT) was configured to measure its highest possible radiation level. The test modes were adapted accordingly in reference to the instructions for use.

4.2 Test Operation and Test Software

Test operation refers to test setup in chapter 5. All testing were performed according to the procedures in ANSI C63.10: 2013.

4.3 Special Accessories and Auxiliary Equipment

Table 5: List of Accessories and Auxiliary Equipment

Description	Manufacturer	Model	S/N or Rating
Laptop	Lenovo	T480	PF-16A6N8
Laptop Adapter	Lenovo	ADLX65YLC3D	Input: AC 100~240V, 50/60Hz Output: DC 5V/2A, 9V/2A

4.4 Countermeasures to Achieve EMC Compliance

The test sample which has been tested contained the noise suppression parts as described in the Technical Construction File (TCF).

No additional measures were employed to achieve compliance.

4.5 Test Setup Diagram

Diagram of Measurement Configuration for Radiation Test (Below 30MHz)

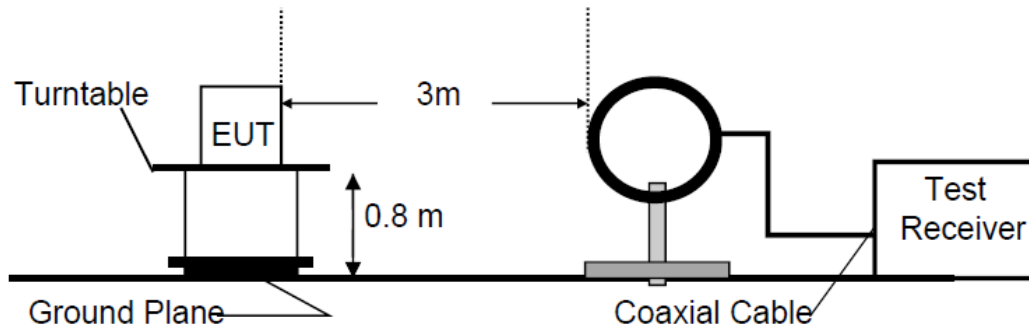

Diagram of Measurement Configuration for Radiation Test (Below 1GHz)

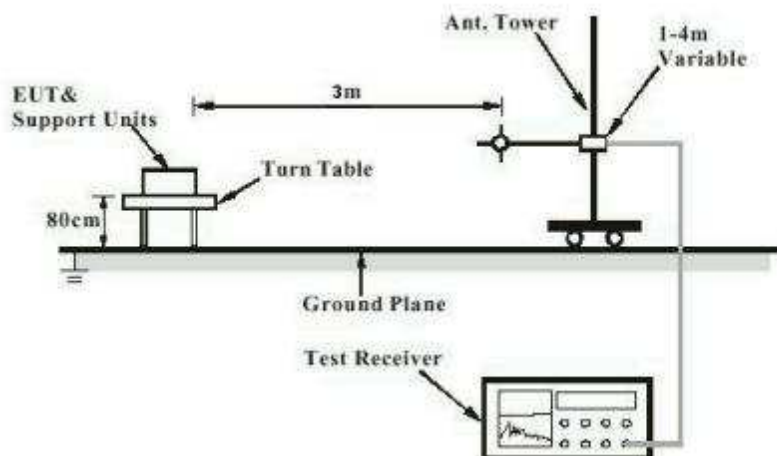

Diagram of Measurement Configuration for Radiation Test (Above 1GHz)

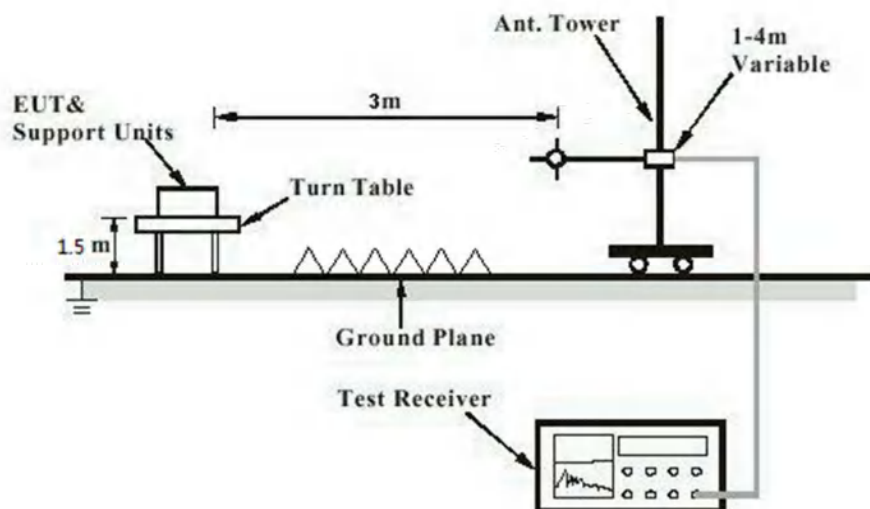

Diagram of Measurement Configuration for Conducted Transmitter Measurement

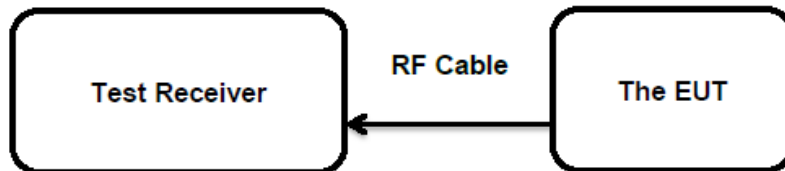
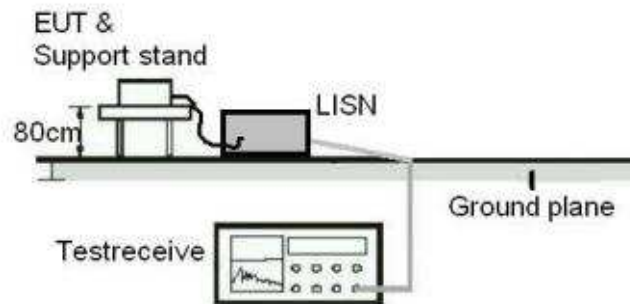

Diagram of Measurement Equipment Configuration for Mains Conduction Measurement



Prüfbericht-Nr.: CN23FUH4 001
Test report no.:Seite 14 von 25
Page 14 of 25

5 Test Results

5.1 Transmitter Requirement & Test Suites

5.1.1 Antenna Requirement

RESULT:**Pass****Test Specification**Test standard : FCC Part 15.247(b)(4) and Part 15.203
RSS-Gen Clause 8.3

According to the manufacturer declared, the EUT has one Dipole Antenna , the directional gain of antennas is 1.24 dBi, and the antenna connector is designed with permanent attachment and no consideration of replacement. Therefore the EUT is considered sufficient to comply with the provision.

Refer to EUT Photo for further details.

Prüfbericht-Nr.: CN23FUH4 001
Test report no.:

 Seite 15 von 25
 Page 15 of 25

5.1.2 Maximum Conducted Output Power

RESULT: **Pass**
Test Specification

Test standard	FCC Part 15.247(b)(1) RSS-247 Clause 5.4(b)
Basic standard	ANSI C63.10: 2013
Limits	FHSS<0.125W(Maximum peak conducted output power) < 4 W (e.i.r.p.)
Kind of test site	Shielded Room

Test Setup

Date of testing	2023-12-12 to 2024-01-24
Input voltage	DC 5V
Operation mode	A.1
Test channel	Low / Middle / High
Ambient temperature	26.1 °C
Relative humidity	40 %
Atmospheric pressure	101 kPa

Table 6: Test Result of Maximum Conducted Output Power

Test Mode	Channel Frequency (MHz)	Measured Peak Output Power		Limit (W)
		(dBm)	(W)	
BR - GFSK	2402	0.63	0.00116	< 0.125
	2441	1.84	0.00153	
	2480	2.48	0.00177	
EDR - π /4DQPSK	2402	1.60	0.00145	< 0.125
	2441	2.56	0.00180	
	2480	3.00	0.00200	

Note: The cable loss is taken into account in results and the maximum e.i.r.p. is 4.24dBm less than 4W(36dBm).

Prüfbericht-Nr.: CN23FUH4 001
Test report no.:

 Seite 16 von 25
 Page 16 of 25

5.1.3 99% Bandwidth

RESULT: **Pass**
Test Specification

 Test standard : RSS-Gen Clause 6.7
 Basic standard : ANSI C63.10: 2013
 Kind of test site : Shielded Room

Test Setup

 Date of testing : 2023-12-12 to 2024-01-24
 Input voltage : DC 5V
 Operation mode : A.1
 Test channel : Low / Middle / High
 Ambient temperature : 26.1 °C
 Relative humidity : 40 %
 Atmospheric pressure : 101 kPa

For the measurement records, refer to the appendix A

Table 7: Test Result of 99% Bandwidth

Test Mode	Channel Frequency (MHz)	Measured 99% Bandwidth	Limit
		(MHz)	
BR - GFSK	2402	0.84571	/
	2441	0.85346	
	2480	0.85037	
EDR - $\pi/4$ DQPSK	2402	1.1820	/
	2441	1.1963	
	2480	1.1884	

Note: The fundamental emissions stay within the allocated band 2400-2483.5MHz.

Prüfbericht-Nr.: CN23FUH4 001
Test report no.:Seite 17 von 25
Page 17 of 25

5.1.4 Conducted Spurious Emissions Measured in 100 kHz Bandwidth

RESULT: Pass**Test Specification**

Test standard : FCC Part 15.247(d)
RSS-247 Clause 5.5

Basic standard : ANSI C63.10: 2013

Limits : 20dB (below that in the 100kHz bandwidth within the band that contains the highest level of the desired power);

Kind of test site : Shielded Room

Test Setup

Date of testing : 2023-12-12 to 2024-01-24

Input voltage : DC 5V

Operation mode : A.1

Test channel : Low / Middle / High

Ambient temperature : 26.1 °C

Relative humidity : 40 %

Atmospheric pressure : 101 kPa

Test results of 100kHz Bandwidth of Frequency Band Edge by Conducted method refer to following test plot, and compliance is achieved as well.

For the measurement records, refer to the appendix A

Prüfbericht-Nr.: CN23FUH4 001
Test report no.:Seite 18 von 25
Page 18 of 25

5.1.5 Radiated Spurious Emission

RESULT: **Pass****Test Specification**

Test standard : FCC Part 15.247(d) & FCC Part 15.205
RSS-247 Clause 3.3

Basic standard : ANSI C63.10: 2013

Limits : Refer to 15.209(a) of FCC part 15.247(d)
RSS-Gen Table 6 & Table 7

Kind of test site : 3m Semi-anechoic Chamber

Test Setup

Date of testing : 2023-12-12 to 2024-01-24

Input voltage : DC 5V

Operation mode : A.1

Test channel : Low / Middle / High

Ambient temperature : Refer to test result

Relative humidity : Refer to test result

Atmospheric pressure : 101 kPa

Remark:

Testing was carried out within frequency range 9kHz to the tenth harmonics.

For the measurement records, refer to the appendix A

Prüfbericht-Nr.: **CN23FUH4 001**
Test report no.:

Seite 19 von 25
Page 19 of 25

5.1.6 20dB Bandwidth

RESULT:
Pass
Test Specification

Test standard : FCC Part 15.247(a)(1)
 RSS-247 Clause 5.1(a)

Basic standard : ANSI C63.10: 2013

Kind of test site : Shielded Room

Test Setup

Date of testing : 2023-12-12 to 2024-01-24

Input voltage : DC 5V

Operation mode : A.1

Test channel : Low / Middle / High

Ambient temperature : 26.1 °C

Relative humidity : 40 %

Atmospheric pressure : 101 kPa

For the measurement records, refer to the appendix A

Table 8: Test Result of -20dB Bandwidth

Test Mode	Channel Frequency (MHz)	20dB Bandwidth (kHz)	2/3 of 20dB Bandwidth (kHz)	Limit (MHz)
BR - GFSK	2402	930	620.000	/
	2441	939	626.000	
	2480	936	624.000	
EDR - $\pi/4$ DQPSK	2402	1320	880.000	/
	2441	1338	892.000	
	2480	1320	880.000	

Prüfbericht-Nr.: CN23FUH4 001
Test report no.:

Seite 20 von 25
Page 20 of 25

5.1.7 Carrier Frequency Separation

RESULT:
Pass
Test Specification

Test standard : FCC Part 15.247(a)(1)
RSS-247 Clause 5.1(b)

Basic standard : ANSI C63.10: 2013

Limits : $\geq 25\text{kHz}$ or 2/3 of 20dB bandwidth, whichever is greater

Kind of test site : Shielded Room

Test Setup

Date of testing : 2023-12-12 to 2024-01-24

Input voltage : DC 5V

Operation mode : B

Test channel : Low / Middle / High

Ambient temperature : 26.1 °C

Relative humidity : 40 %

Atmospheric pressure : 101 kPa

For the measurement records, refer to the appendix A

Table 9: Test Result of Carrier Frequency Separation

Test Mode	Channel	Result[MHz]	Limit[MHz]	Verdict
BR - GFSK	Hop	1.106	≥ 0.939	PASS
EDR - $\pi/4$ DQPSK	Hop	1.004	≥ 0.892	PASS

Note:

The limit is maximum 2/3 of the 20 dB bandwidth: 892KHz.

Prüfbericht-Nr.: CN23FUH4 001
Test report no.:Seite 21 von 25
Page 21 of 25

5.1.8 Frequency stability

RESULT:**Pass****Test Specification**

Test standard : RSS-247 Clause 8.11
Basic standard : ANSI C63.10: 2013
Limits : within at least the central 80% of its permitted operating frequency band (2400-2483.5MHz)
Kind of test site : Shielded Room

Test Setup

Date of testing : 2023-12-12 to 2024-01-24
Input voltage : DC 5V
Operation mode : B
Ambient temperature : 26.1 °C
Relative humidity : 40 %
Atmospheric pressure : 101 kPa

For the measurement records, refer to the appendix A

Prüfbericht-Nr.: CN23FUH4 001
Test report no.:

Seite 22 von 25
Page 22 of 25

5.1.9 Number of Hopping Frequency

RESULT: **Pass**
Test Specification

Test standard : FCC part 15.247(a)(1)(iii)
RSS-247 Clause 5.1(d)

Basic standard : ANSI C63.10: 2013

Limits : ≥ 15 non-overlapping channels

Kind of test site : Shielded Room

Test Setup

Date of testing : 2023-12-12 to 2024-01-24

Input voltage : DC 5V

Operation mode : B

Ambient temperature : 26.1 °C

Relative humidity : 40 %

Atmospheric pressure : 101 kPa

For the measurement records, refer to the appendix A.

Table 10: Test Result of Number of Hopping Frequency

Frequency Range	Measured Quantity of Hopping Channel	Limit	Result
2402 to 2480 MHz	79	≥15	Pass

Prüfbericht-Nr.: CN23FUH4 001
Test report no.:Seite 23 von 25
Page 23 of 25

5.1.10 Time of Occupancy

RESULT: **Pass****Test Specification**

Test standard : FCC part 15.247(a)(1)(iii)
RSS-247 Clause 5.1(d)

Basic standard : ANSI C63.10: 2013

Limits : < 0.4s

Kind of test site : Shielded Room

Test Setup

Date of testing : 2023-12-12 to 2024-01-24

Input voltage : DC 5V

Operation mode : B

Test channel : Low / Middle / High

Ambient temperature : 26.1 °C

Relative humidity : 40 %

Atmospheric pressure : 101 kPa

For the measurement records, refer to the appendix A.

Prüfbericht-Nr.: CN23FUH4 001
Test report no.:Seite 24 von 25
Page 24 of 25

5.1.11 Conducted Emission on AC Mains

RESULT: **Pass****Test Specification**

Test standard : FCC Part 15.207(a)
RSS-Gen Clause 8.8

Basic standard : ANSI C63.10: 2013

Frequency range : 0.15 – 30MHz

Limits : FCC Part 15.207(a)
RSS-Gen Table 4

Kind of test site : Shielded Room

Test Setup

Date of testing : 2023-12-12 to 2024-01-24

Input voltage : DC 5V via PC

Operation mode : B

Earthing : Connected

Ambient temperature : 24.9 °C

Relative humidity : 51.8 %

Atmospheric pressure : 101 kPa

For the measurement records, refer to the appendix A.

6 Photographs of the Test Set-Up

For photographs of the test set-up, refer to the appendix A.

7 List of Tables

Table 1: List of Test and Measurement Equipment.....	6
Table 2: Technical Specification of EUT	8
Table 3: RF Channel and Frequency of Classic Bluetooth.....	9
Table 4: RF Channel and Frequency of Bluetooth Low Energy.....	9
Table 5: List of Accessories and Auxiliary Equipment.....	11
Table 6: Test Result of Maximum Conducted Output Power.....	15
Table 7: Test Result of 99% Bandwidth	16
Table 8: Test Result of -20dB Bandwidth.....	19
Table 9: Test Result of Carrier Frequency Separation	20
Table 10: Test Result of Number of Hopping Frequency	22

Appendix A: Test Results of Classical Bluetooth

APPENDIX A: TEST RESULTS OF CLASSICAL BLUETOOTH	1
APPENDIX A.1: TEST RESULTS OF 99% BANDWIDTH	2
APPENDIX A.2: TEST RESULTS OF 20dB BANDWIDTH	5
APPENDIX A.3: TEST RESULTS OF FREQUENCY STABILITY	8
APPENDIX A.4: TEST RESULTS OF CARRIER FREQUENCY SEPARATION	10
APPENDIX A.5: TEST RESULTS OF NUMBER OF HOPPING FREQUENCY	11
APPENDIX A.6: TEST RESULTS OF TIME OF OCCUPANCY	12
APPENDIX A.7: TEST RESULTS OF CONDUCTED SPURIOUS EMISSIONS MEASURED IN 100 kHz BANDWIDTH	17
<i>Conducted measurements</i>	17
<i>Band edge measurements</i>	24
APPENDIX A.8: TEST RESULTS OF RADIATED SPURIOUS EMISSIONS	27
30MHz - 1GHz	27
1GHz - 18GHz	29
APPENDIX A.9: TEST RESULTS OF RADIATED EMISSIONS IN RESTRICTED BANDS	41
APPENDIX A.10: TEST RESULTS OF CONDUCTED EMISSIONS	45

Appendix A.1: Test Results of 99% Bandwidth

TestMode	Antenna	Channel	OCB [MHz]	FL[MHz]	FH[MHz]	Limit[MHz]	Verdict
DH5	Ant1	2402	0.84571	2401.5742	2402.4199	---	---
		2441	0.85346	2440.5721	2441.4256	---	---
		2480	0.85037	2479.5701	2480.4205	---	---
2DH5	Ant1	2402	1.1820	2401.4082	2402.5902	---	---
		2441	1.1963	2440.4032	2441.5995	---	---
		2480	1.1884	2479.4037	2480.5921	---	---

DH5 Ant1 2402



DH5 Ant1 2441

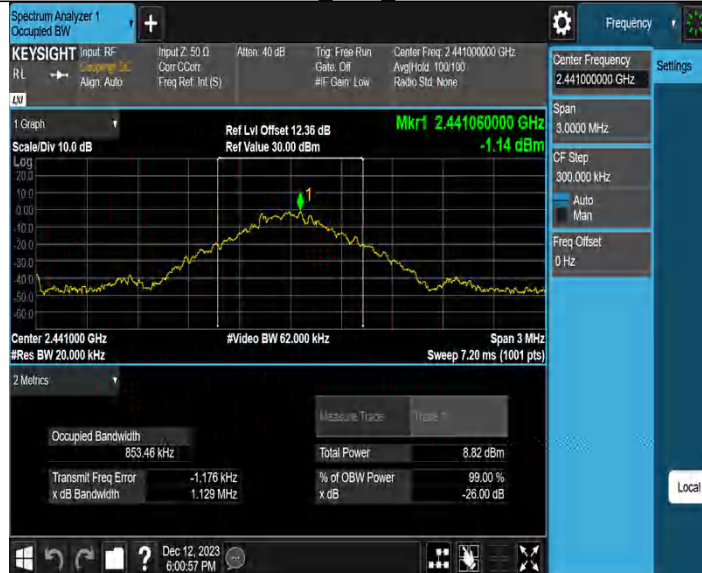

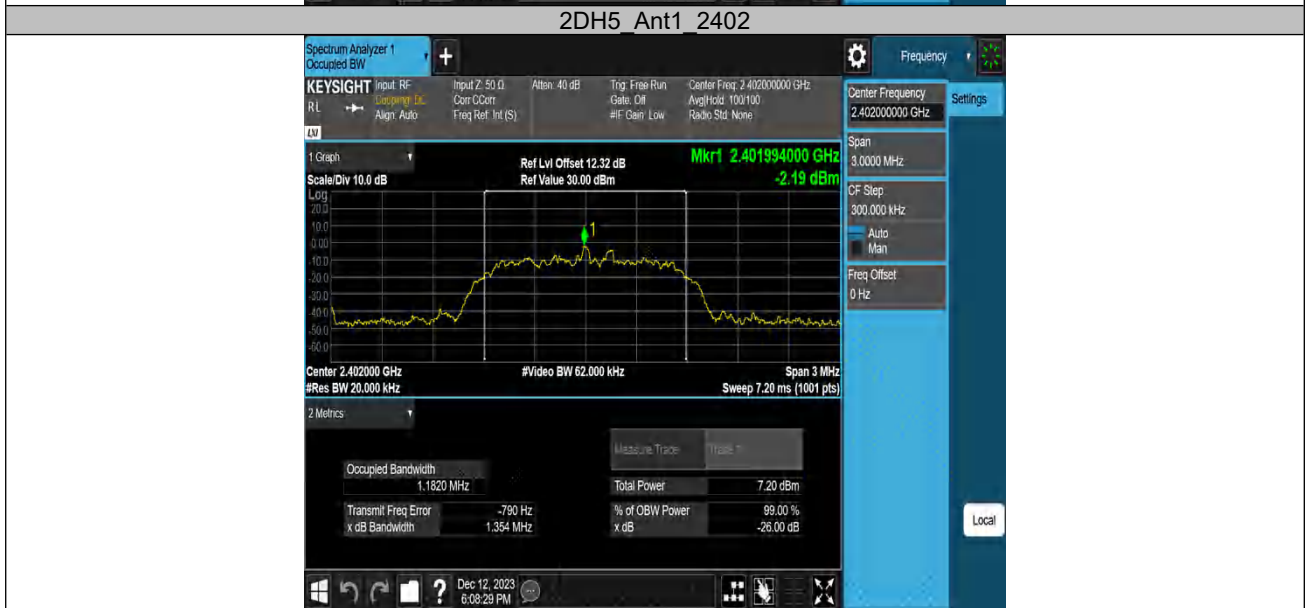
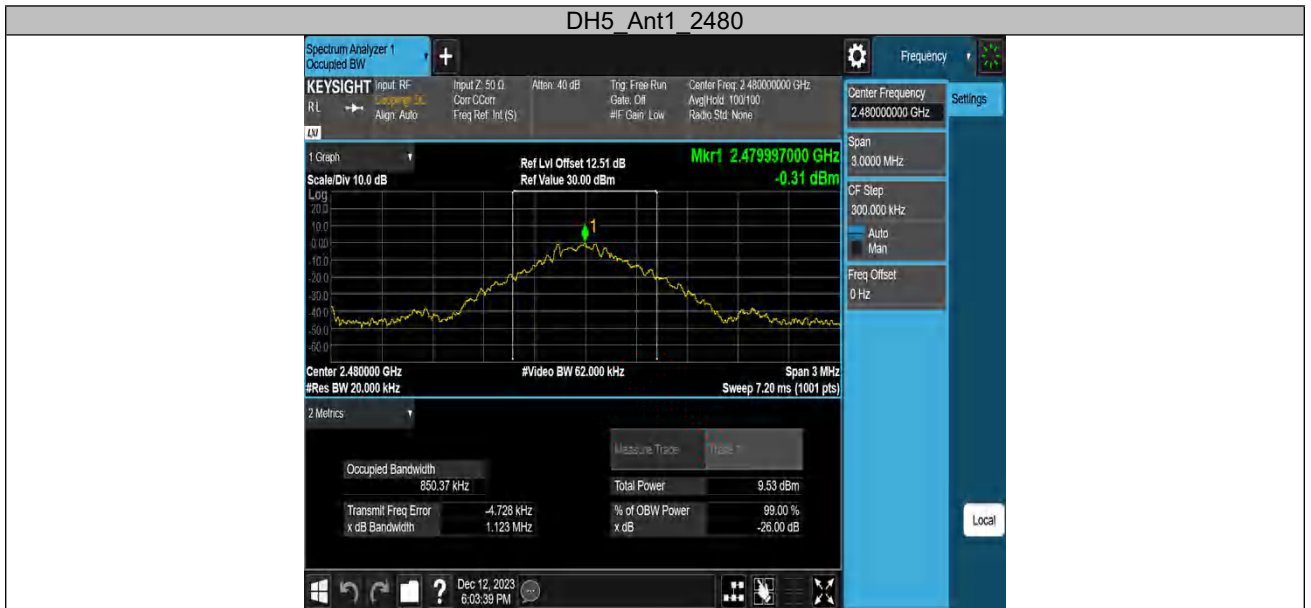

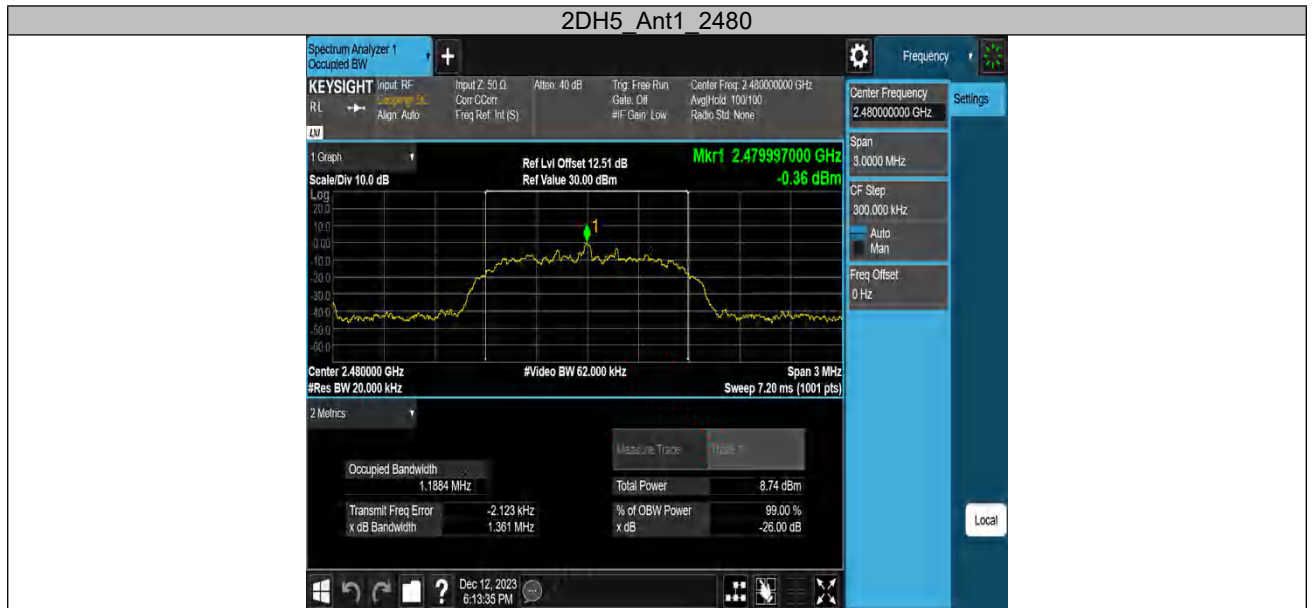

Appendix A.2: Test Results of 20dB Bandwidth

TestMode	Antenna	Channel	20db EBW[MHz]	FL[MHz]	FH[MHz]	Limit[MHz]	Verdict
DH5	Ant1	2402	0.930	2401.541	2402.471	---	---
		2441	0.939	2440.541	2441.480	---	---
		2480	0.936	2479.547	2480.483	---	---
2DH5	Ant1	2402	1.320	2401.340	2402.660	---	---
		2441	1.338	2440.334	2441.672	---	---
		2480	1.320	2479.340	2480.660	---	---

DH5 Ant1 2402



DH5 Ant1 2441



DH5_Ant1_2480



2DH5_Ant1_2402



2DH5_Ant1_2441



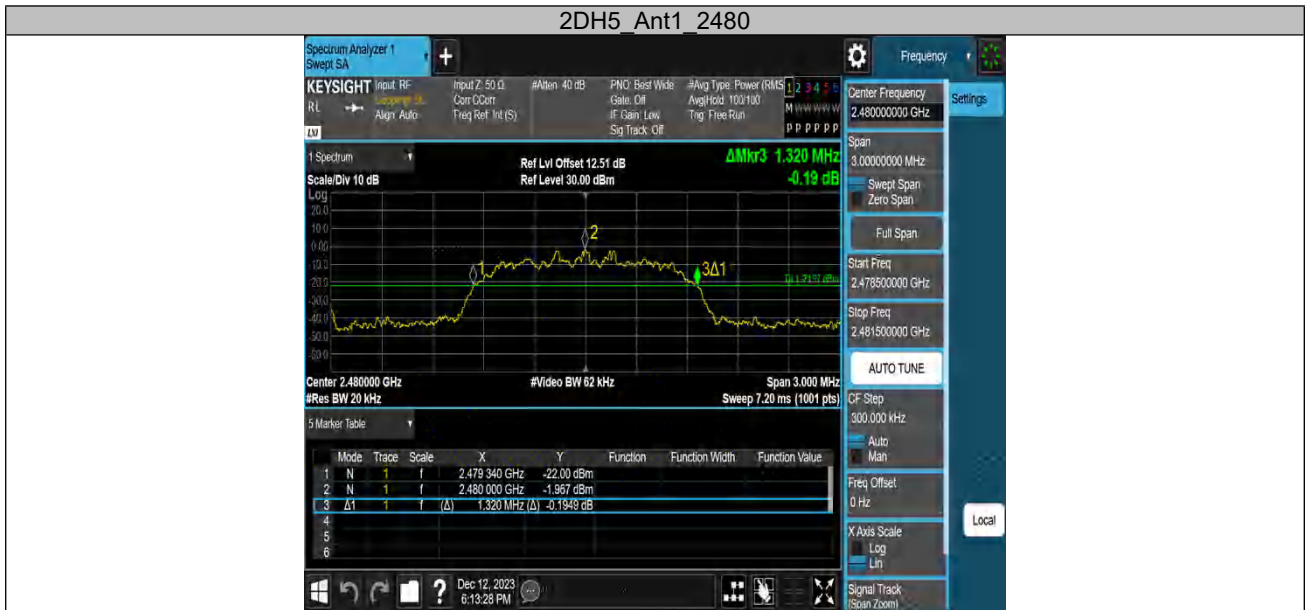

Appendix A.3: Test Results of Frequency stability

Test Channel (MHz)	2402
--------------------	------

Test result of frequency tolerance of voltage variation

Voltage	Test result (MHz)	Deviation Frequency (KHz)	Test result (ppm)	Limit (ppm)
DC 5V	2401.9971	-2.9	-1.21	10
DC 5V	2401.9975	-2.5	-1.04	
DC 4.5V	2401.9968	-3.2	-1.33	

Test result of frequency tolerance of temperature variation

Temperature (°C)	Test result (MHz)	Deviation Frequency (KHz)	Test result (ppm)	Limit (ppm)
-30	2401.9961	-3.9	-1.62	10
-20	2401.9962	-3.8	-1.58	
-10	2401.9965	-3.5	-1.46	
0	2401.9969	-3.1	-1.29	
10	2401.9971	-2.9	-1.21	
20	2401.9970	-3.0	-1.25	
30	2401.9971	-2.9	-1.21	
40	2401.9971	-2.9	-1.21	
50	2401.9972	-2.8	-1.17	
55	2401.9975	-2.5	-1.04	

Test Channel (MHz)	2441
--------------------	------

Test result of frequency tolerance of voltage variation

Voltage	Test result (MHz)	Deviation Frequency (KHz)	Test result (ppm)	Limit (ppm)
DC 5V	2440.9988	-1.2	-0.49	10
DC 5V	2440.9983	-1.7	-0.70	
DC 4.5V	2440.9986	-1.4	-0.57	

Test result of frequency tolerance of temperature variation

Temperature (°C)	Test result (MHz)	Deviation Frequency (KHz)	Test result (ppm)	Limit (ppm)
-30	2440.9979	-2.1	-0.86	10
-20	2440.9982	-1.8	-0.74	
-10	2440.9983	-1.7	-0.70	
0	2440.9987	-1.3	-0.53	
10	2440.9988	-1.2	-0.49	
20	2440.9989	-1.1	-0.45	
30	2440.9991	-0.9	-0.37	
40	2440.9992	-0.8	-0.33	
50	2440.9994	-0.6	-0.25	
55	2440.9996	-0.4	-0.16	

Test Channel (MHz)	2480
--------------------	------

Test result of frequency tolerance of voltage variation

Voltage	Test result (MHz)	Deviation Frequency (KHz)	Test result (ppm)	Limit (ppm)
DC 5V	2479.9953	-4.7	-1.90	10
DC 5V	2479.9944	-5.6	-2.26	
DC 4.5V	2479.9956	-4.4	-1.77	

Test result of frequency tolerance of temperature variation

Temperature (°C)	Test result (MHz)	Deviation Frequency (KHz)	Test result (ppm)	Limit (ppm)
-30	2479.9944	-5.6	-2.26	10
-20	2479.9946	-5.4	-2.18	
-10	2479.9949	-5.1	-2.06	
0	2479.9950	-5.0	-2.02	
10	2479.9952	-4.8	-1.94	
20	2479.9954	-4.6	-1.85	
30	2479.9956	-4.4	-1.77	
40	2479.9957	-4.3	-1.73	
50	2479.9958	-4.2	-1.69	
55	2479.9961	-3.9	-1.57	

Appendix A.4: Test Results of Carrier Frequency Separation

TestMode	Antenna	Channel	Result[MHz]	Limit[MHz]	Verdict
DH5	Ant1	Hop	1.106	≥0.939	PASS
2DH5	Ant1	Hop	1.004	≥0.892	PASS

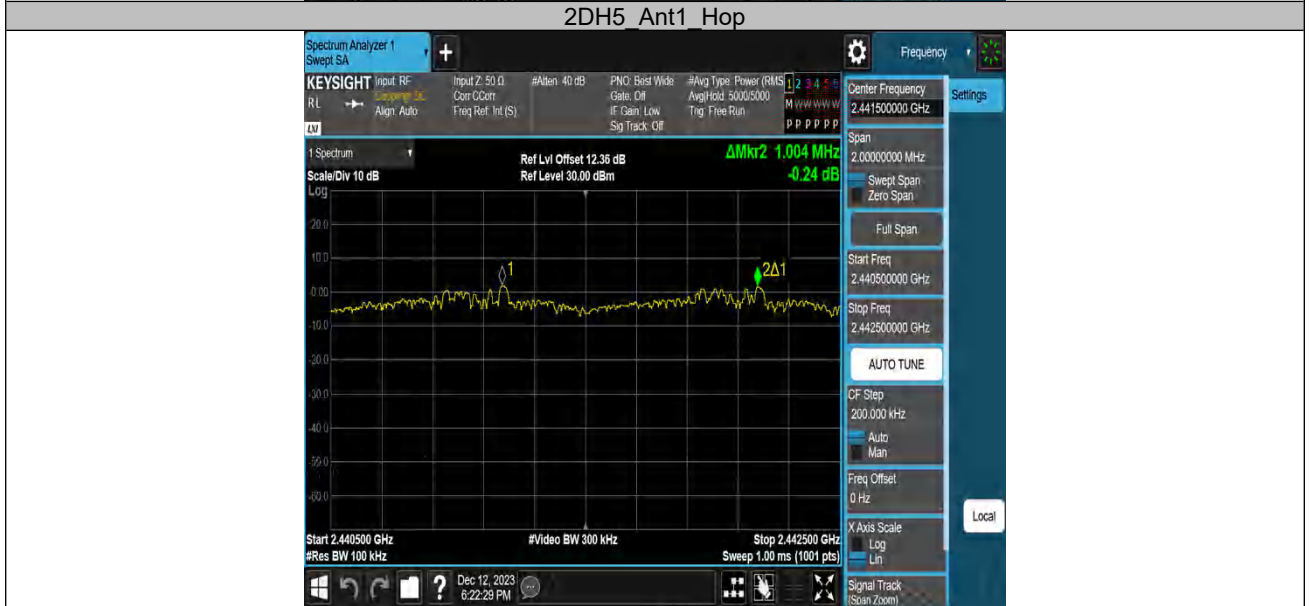

Appendix A.5: Test Results of Number of Hopping Frequency

TestMode	Antenna	Channel	Result[Num]	Limit[Num]	Verdict
DH5	Ant1	Hop	79	≥15	PASS
2DH5	Ant1	Hop	79	≥15	PASS

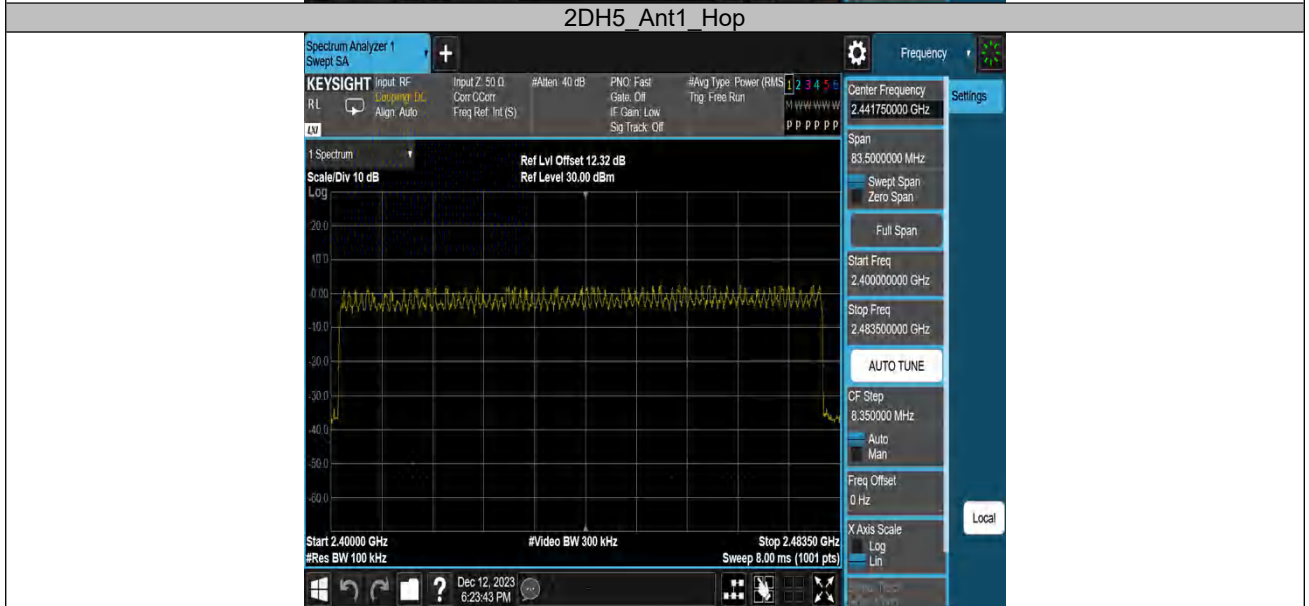
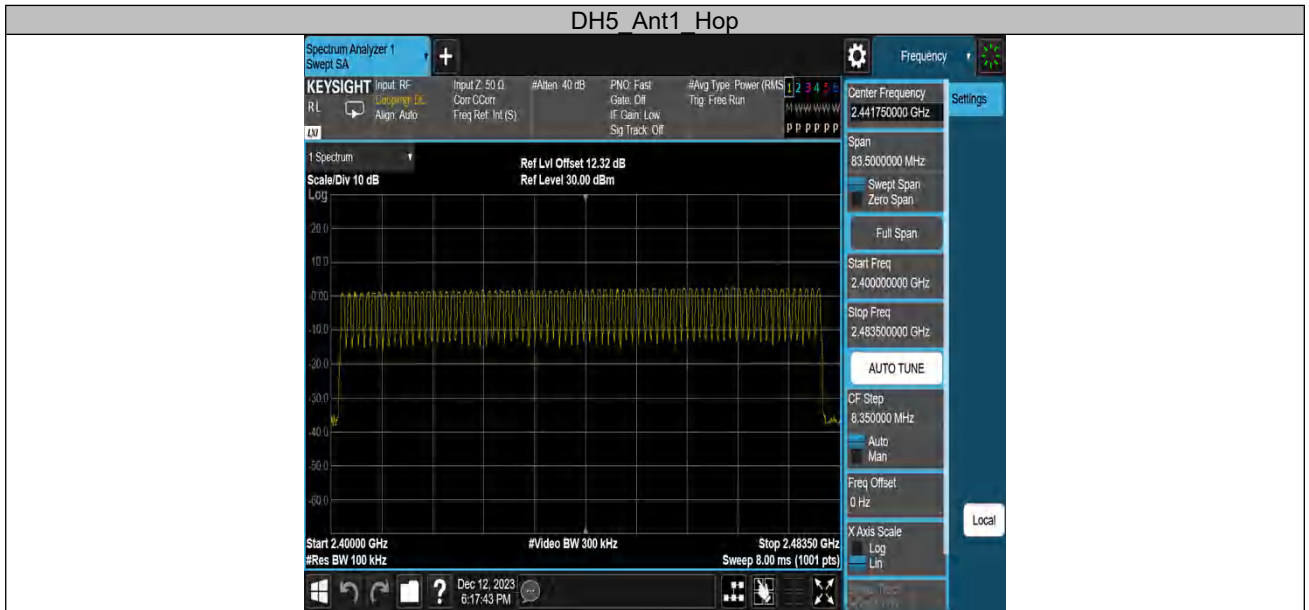

Appendix A.6: Test Results of Time of Occupancy

TestMode	Antenna	Channel	BurstWidth [ms]	TotalHops [Num]	Result[s]	Limit[s]	Verdict
DH1	Ant1	Hop	0.374	316	0.118	≤0.4	PASS
DH3	Ant1	Hop	1.630	164	0.267	≤0.4	PASS
DH5	Ant1	Hop	2.879	107	0.308	≤0.4	PASS
2DH1	Ant1	Hop	0.384	318	0.122	≤0.4	PASS
2DH3	Ant1	Hop	1.637	164	0.268	≤0.4	PASS
2DH5	Ant1	Hop	2.884	116	0.335	≤0.4	PASS



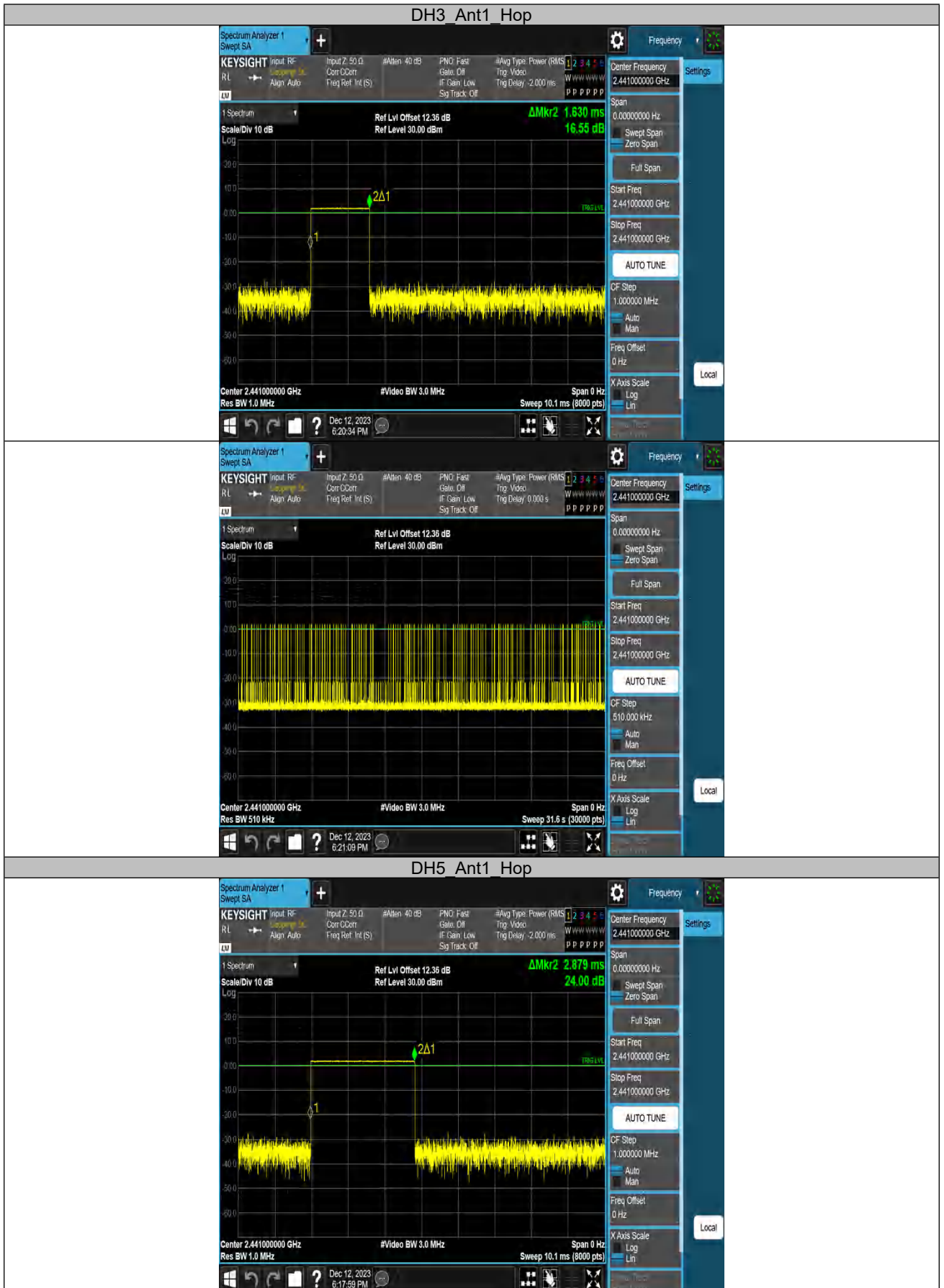



2DH1 Ant1 Hop



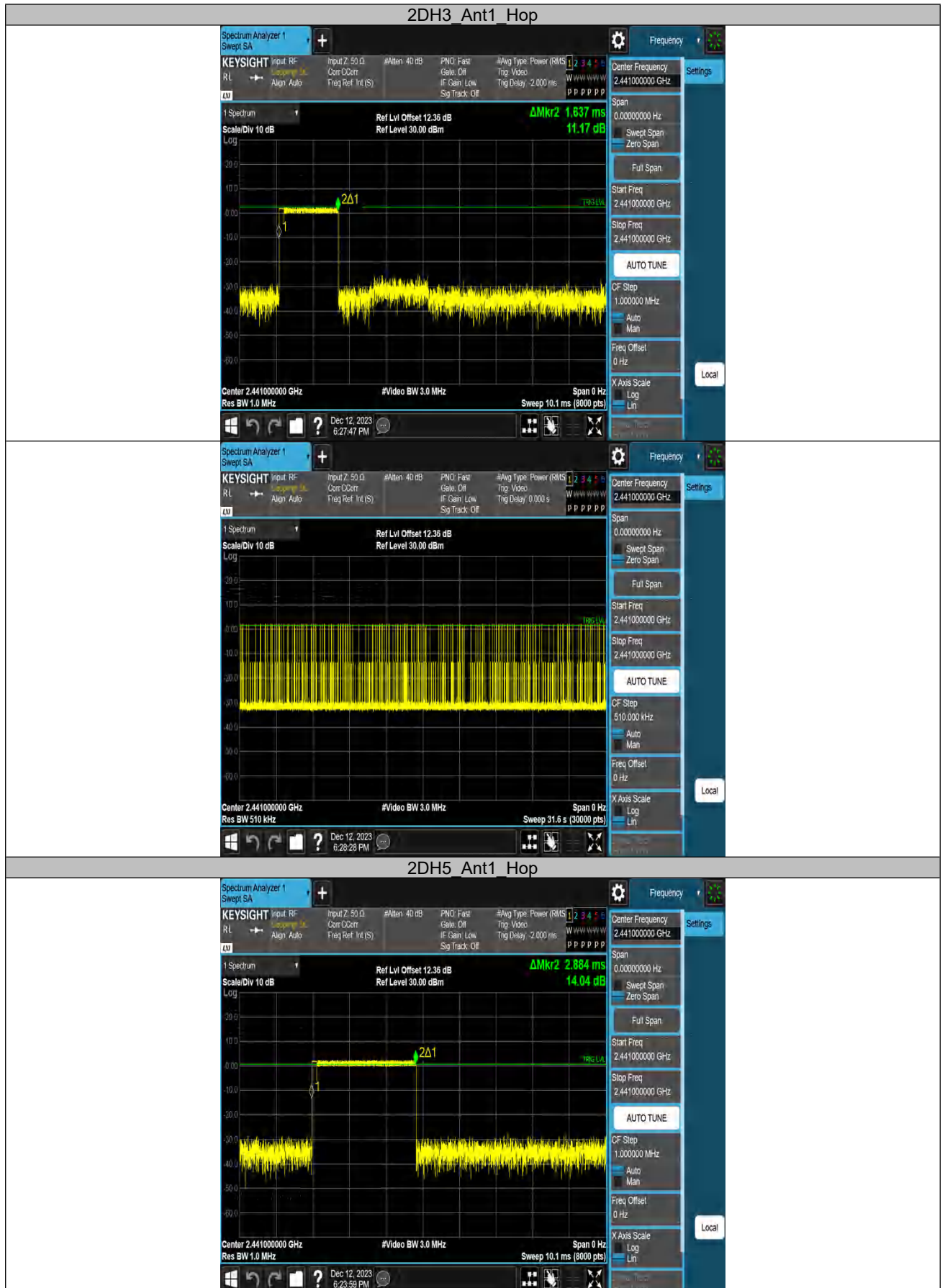



Appendix A.7: Test Results of Conducted Spurious Emissions Measured in 100 kHz Bandwidth

Conducted measurements

TestMode	Antenna	Channel	FreqRange [MHz]	RefLevel [dBm]	Result [dBm]	Limit [dBm]	Verdict
DH5	Ant1	2402	Reference	0.36	0.36	---	PASS
			30~1000	0.36	-47.46	≤-19.64	PASS
			1000~26500	0.36	-37.63	≤-19.64	PASS
		2441	Reference	1.46	1.46	---	PASS
			30~1000	1.46	-47.57	≤-18.54	PASS
			1000~26500	1.46	-38.25	≤-18.54	PASS
		2480	Reference	2.75	2.75	---	PASS
			30~1000	2.75	-47.9	≤-17.25	PASS
			1000~26500	2.75	-37.91	≤-17.25	PASS
2DH5	Ant1	2402	Reference	0.67	0.67	---	PASS
			30~1000	0.67	-47.54	≤-19.33	PASS
			1000~26500	0.67	-37.84	≤-19.33	PASS
		2441	Reference	-1.64	-1.64	---	PASS
			30~1000	-1.64	-47.53	≤-21.64	PASS
			1000~26500	-1.64	-38.3	≤-21.64	PASS
		2480	Reference	1.50	1.50	---	PASS
			30~1000	1.50	-47.07	≤-18.5	PASS
			1000~26500	1.50	-37.97	≤-18.5	PASS

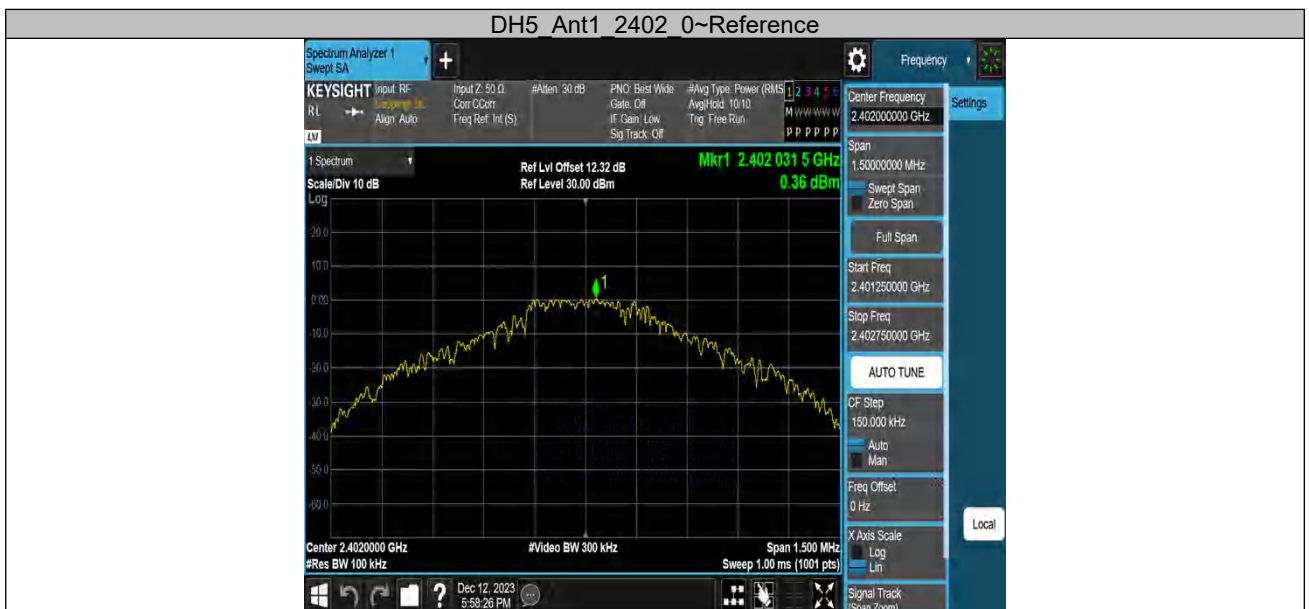

DH5_Ant1_2402_30~1000



DH5_Ant1_2402_1000~26500



DH5_Ant1_2441_0~Reference



DH5_Ant1_2441_30~1000



DH5_Ant1_2441_1000~26500



DH5_Ant1_2480_0~Reference



DH5_Ant1_2480_30~1000

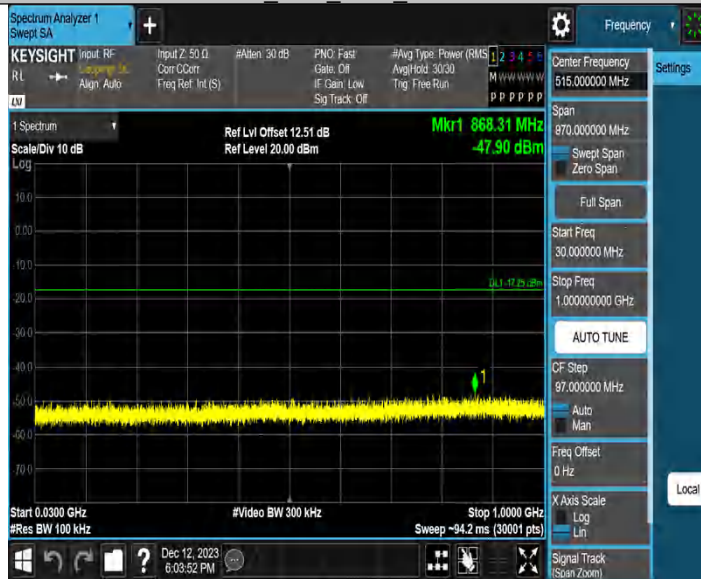

DH5_Ant1_2480_1000~26500



2DH5_Ant1_2402_0~Reference



2DH5_Ant1_2402_30~1000



2DH5_Ant1_2402_1000~26500



2DH5_Ant1_2441_0~Reference



2DH5_Ant1_2441_30~1000

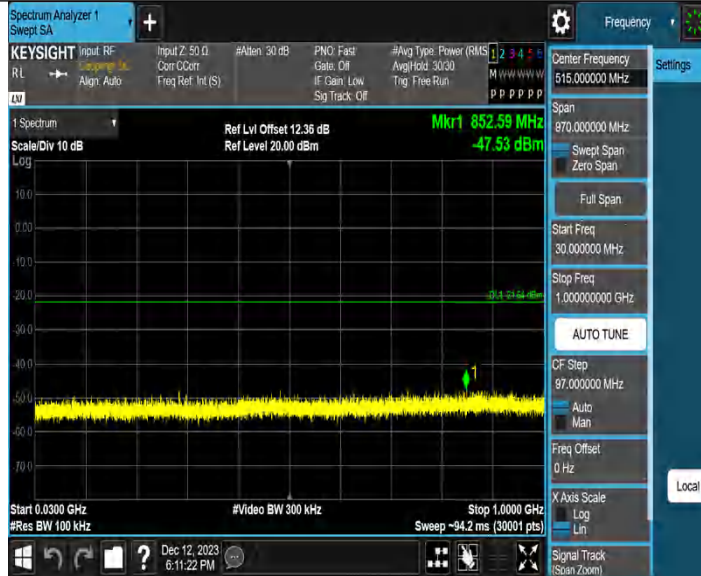

2DH5_Ant1_2441_1000~26500



2DH5_Ant1_2480_0~Reference



2DH5_Ant1_2480_30~1000

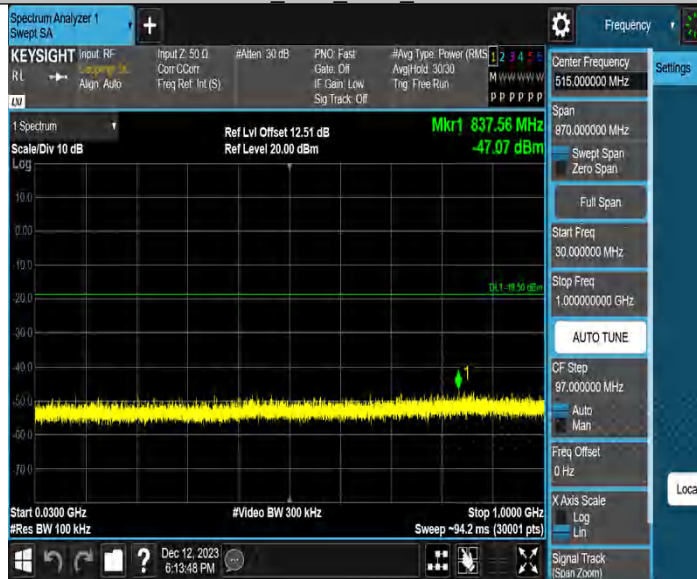

2DH5_Ant1_2480_1000~26500



Band edge measurements

TestMode	Antenna	ChName	Channel	RefLevel [dBm]	Result [dBm]	Limit [dBm]	Verdict
DH5	Ant1	Low	2402	0.9654	-48.5	≤-19.04	PASS
		High	2480	2.696	-41.05	≤-17.3	PASS
2DH5	Ant1	Low	2402	0.9482	-48.16	≤-19.05	PASS
		High	2480	2.669	-43.58	≤-17.33	PASS
DH5	Ant1	Hopping	2402	0.7623	-40.68	≤-19.24	PASS
		Hopping	2480	1.898	-43.6	≤-18.1	PASS
2DH5	Ant1	Hopping	2402	-0.5867	-47.73	≤-20.59	PASS
		Hopping	2480	-1.811	-47.83	≤-21.81	PASS

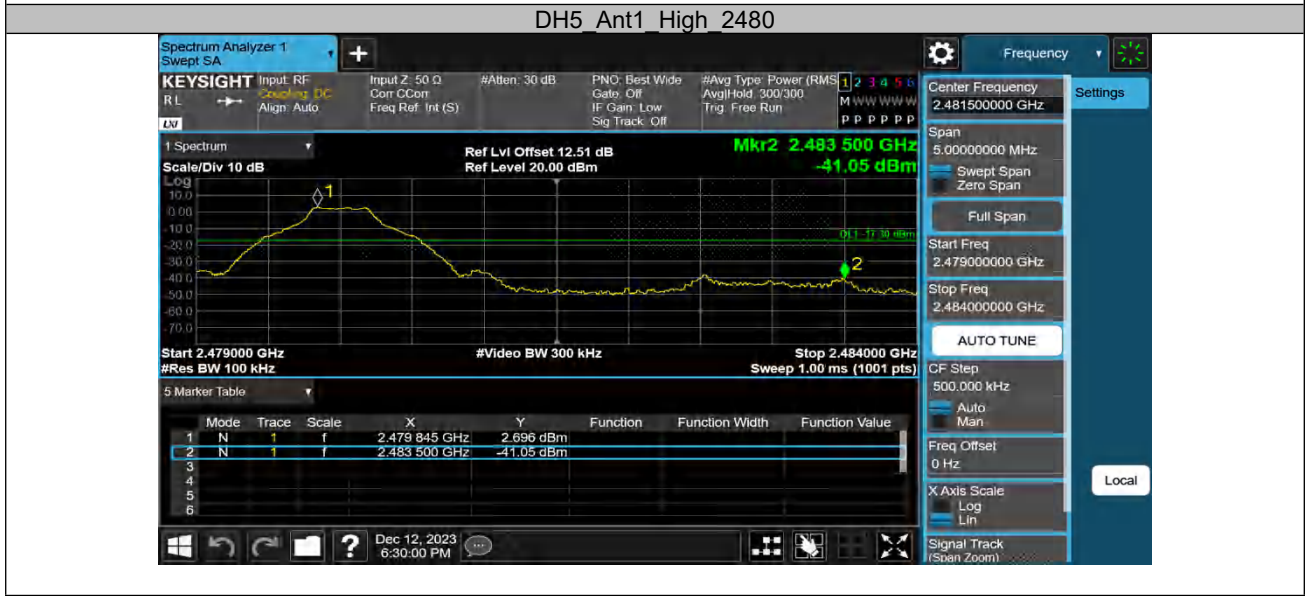
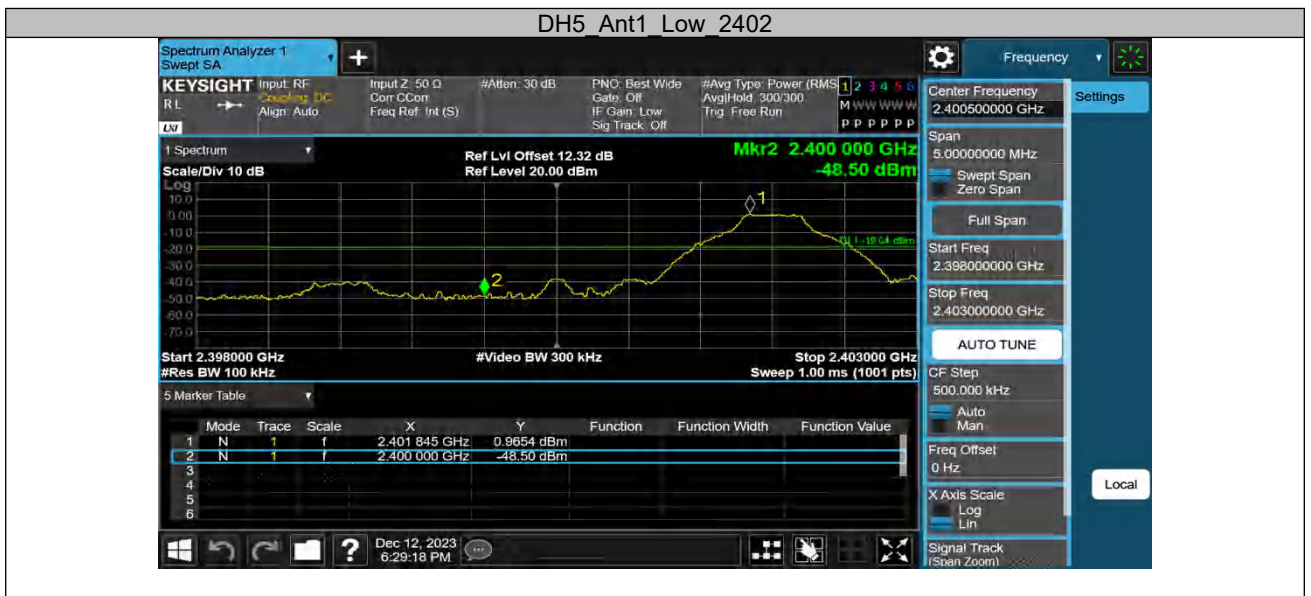

2DH5 Ant1 Low 2402



2DH5 Ant1 High 2480

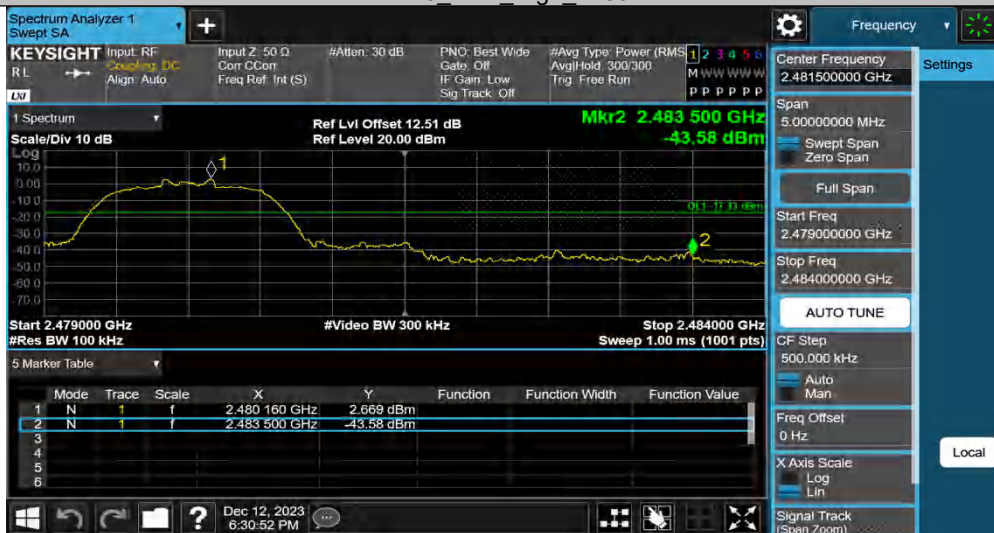

DH5 Ant1 Hopping 2402



DH5 Ant1 Hopping 2480



2DH5 Ant1 Hopping 2402



2DH5 Ant1 Hopping 2480



Appendix A.8: Test Results of Radiated Spurious Emissions

Note: 1. Testing was carried out within frequency range 9kHz to the tenth harmonics. The measurement results below 30MHz and 18GHz - 26.5GHz were greater than 20dB below the limit, so only the radiated spurious emissions from 30MHz to 18GHz were reported. 2. This testing was carried out on different modulations, but only the worst case (GFSK) was presented in this report.

30MHz - 1GHz

EUT Information

EUT Name:	Bluetooth module
Model:	AC6951
Test Mode:	BR_DH5_Mid channel
Order No/Sample No:	168453215/A003605155-008
Test Voltage:::	DC 5V
Remark:	Temp 23 Humi:53%
Test Standard:	FCC 15.247
Tested By:	Kei Zhang
Reviewed By:	Terry Yin

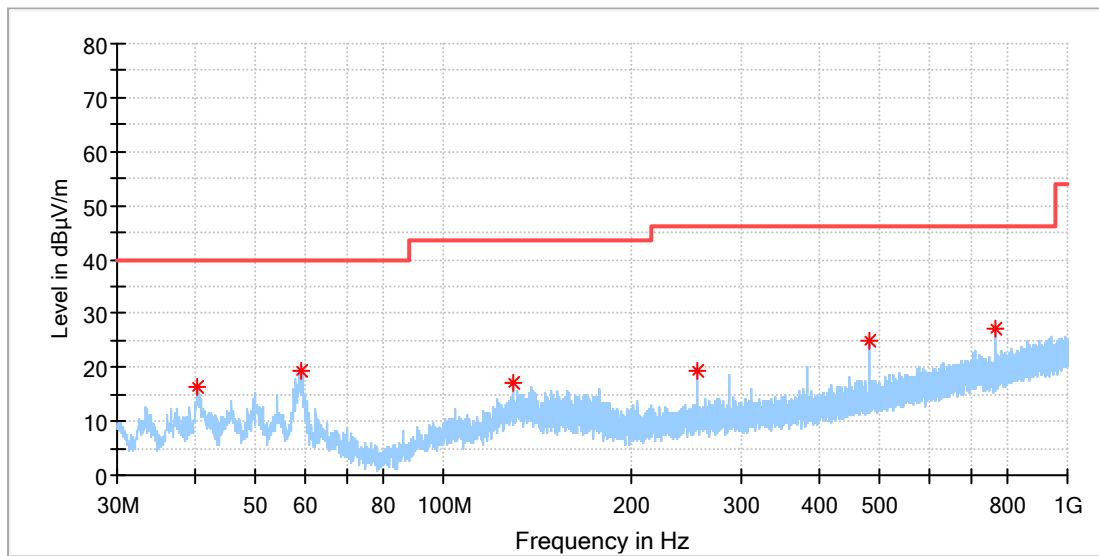

Critical Freqs

Frequency (MHz)	MaxPeak (dBµV/m)	Limit (dBµV/m)	Margin (dB)	Height (cm)	Pol	Azimuth (deg)	Corr. (dB/m)
40.408846	16.37	40.00	23.63	100.0	H	60.0	-20.3
59.361154	19.25	40.00	20.75	100.0	H	256.0	-19.2
129.648846	17.13	43.50	26.37	100.0	H	318.0	-22.1
256.010000	19.30	46.00	26.70	100.0	H	113.0	-17.6
480.005385	24.89	46.00	21.11	100.0	H	60.0	-12.6
768.020769	27.22	46.00	18.78	100.0	H	141.0	-7.3

EUT Information

EUT Name:	Bluetooth module
Model:	AC6951
Test Mode:	BR_DH5_Mid channel
Order No/Sample No:	168453215/A003605155-008
Test Voltage:::	DC 5V
Remark:	Temp 23 Humi:53%
Test Standard:	FCC 15.247
Tested By:	Kei Zhang
Reviewed By:	Terry Yin

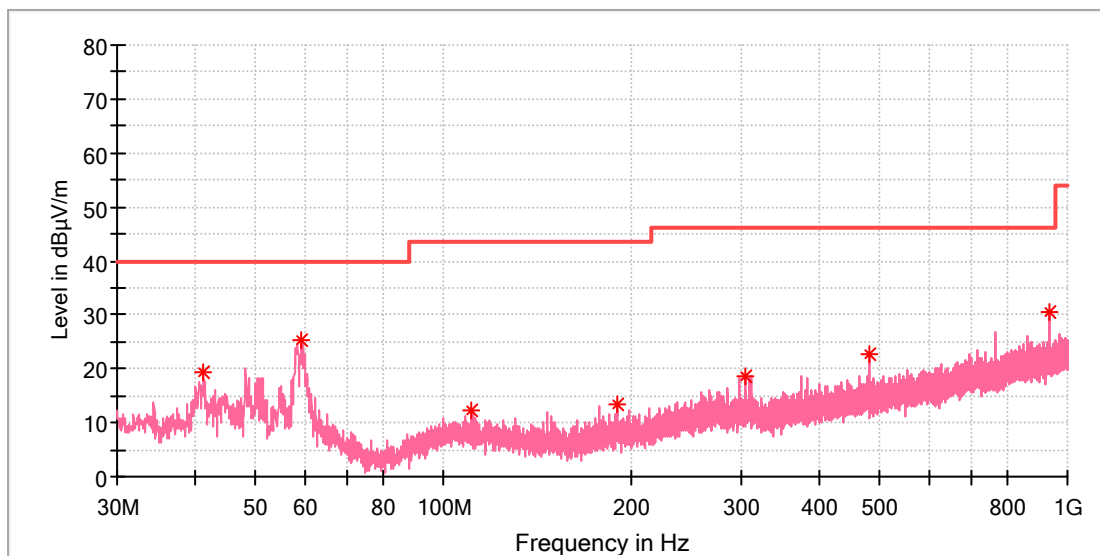

Critical Freqs

Frequency (MHz)	MaxPeak (dBµV/m)	Limit (dBµV/m)	Margin (dB)	Height (cm)	Pol	Azimuth (deg)	Corr. (dB/m)
41.229615	19.52	40.00	20.48	100.0	V	79.0	-20.1
59.361154	25.18	40.00	14.82	100.0	V	339.0	-19.2
110.696539	12.40	43.50	31.10	100.0	V	71.0	-19.5
189.341154	13.40	43.50	30.10	100.0	V	189.0	-19.9
304.957692	18.55	46.00	27.45	100.0	V	278.0	-16.5
480.005385	22.74	46.00	23.26	100.0	V	56.0	-12.6
937.546923	30.53	46.00	15.48	100.0	V	339.0	-5.0

1GHz - 18GHz

Note: The highest waveform in the figure is Bluetooth Fundamental.

EUT Information

EUT Name:	Bluetooth module
Model:	AC6951
Test Mode:	BR_DH5_Low channel
Order No/Sample No:	168453215/A003605155-008
Test Voltage::	DC 5V
Remark:	Temp 23 Humi:53%
Test Standard:	FCC 15.247
Tested By:	Kei Zhang
Reviewed By:	Terry Yin

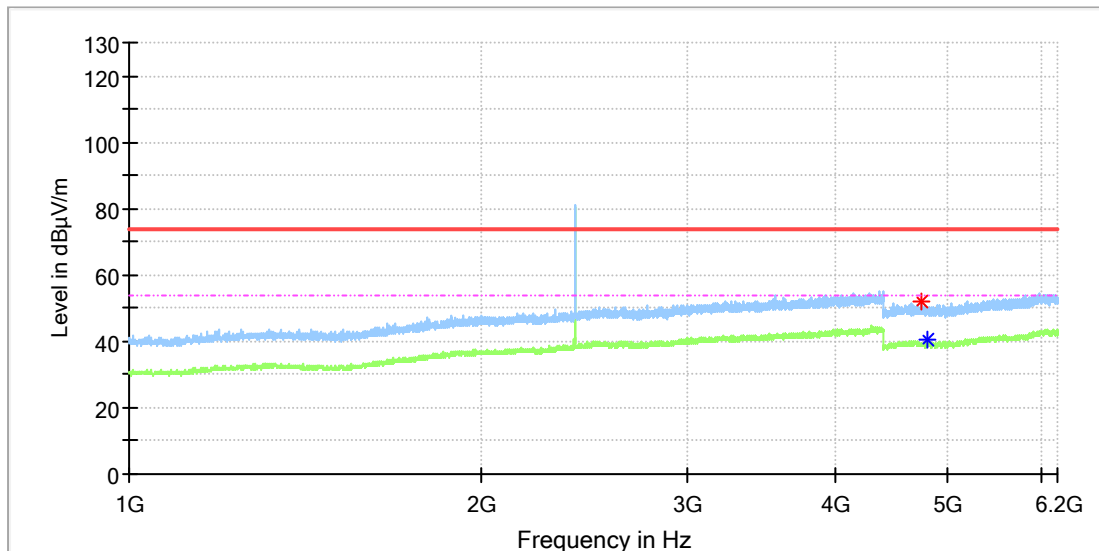

Critical_Freqs

Frequency (MHz)	MaxPeak (dBµV/m)	Average (dBµV/m)	Limit (dBµV/m)	Margin (dB)	Height (cm)	Pol	Azimuth (deg)	Corr. (dB/m)
4747.000000	52.28	---	74.00	21.72	150.0	H	207.0	11.9
4804.000000	---	40.66	54.00	13.34	150.0	H	5.0	11.8

EUT Information

EUT Name:	Bluetooth module
Model:	AC6951
Test Mode:	BR_DH5_Low channel
Order No/Sample No:	168453215/A003605155-008
Test Voltage:::	DC 5V
Remark:	Temp 23 Humi:53%
Test Standard:	FCC 15.247
Tested By:	Kei Zhang
Reviewed By:	Terry Yin

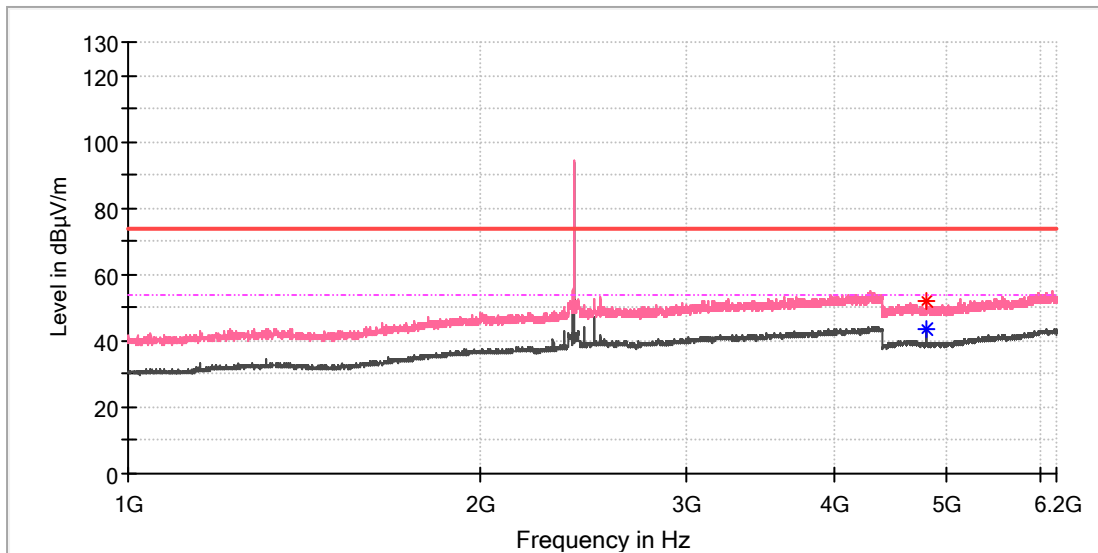

Critical Freqs

Frequency (MHz)	MaxPeak (dBµV/m)	Average (dBµV/m)	Limit (dBµV/m)	Margin (dB)	Height (cm)	Pol	Azimuth (deg)	Corr. (dB/m)
4803.500000	51.89	---	74.00	22.11	150.0	V	127.0	11.8
4804.000000	---	43.67	54.00	10.33	150.0	V	24.0	11.8

EUT Information

EUT Name:	Bluetooth module
Model:	AC6951
Test Mode:	BR_DH5_Mid channel
Order No/Sample No:	168453215/A003605155-008
Test Voltage:::	DC 5V
Remark:	Temp 23 Humi:53%
Test Standard:	FCC 15.247
Tested By:	Kei Zhang
Reviewed By:	Terry Yin

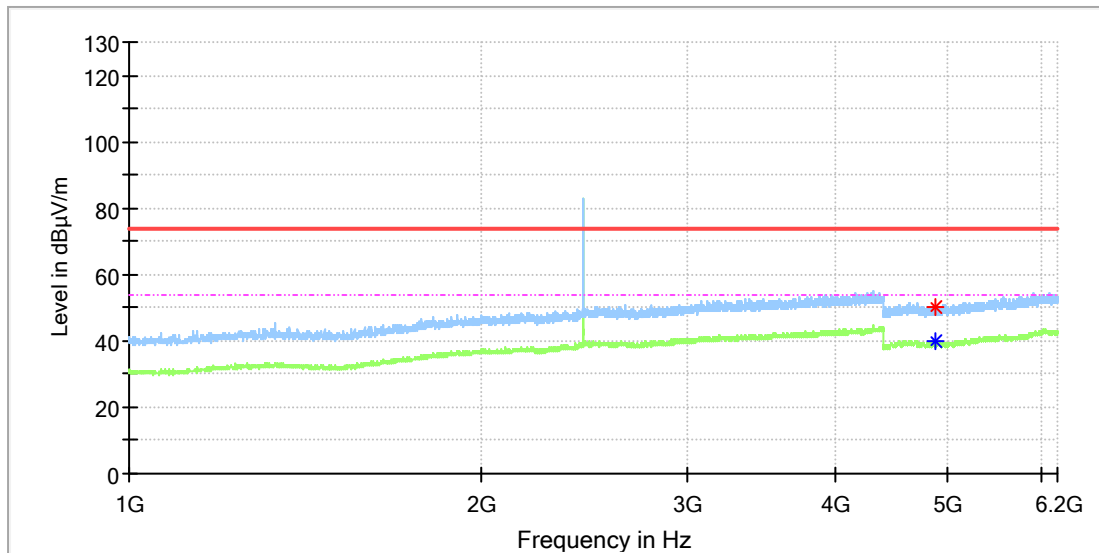

Critical Freqs

Frequency (MHz)	MaxPeak (dBµV/m)	Average (dBµV/m)	Limit (dBµV/m)	Margin (dB)	Height (cm)	Pol	Azimuth (deg)	Corr. (dB/m)
4871.500000	50.42	---	74.00	23.58	150.0	H	8.0	11.8
4882.000000	---	40.18	54.00	13.82	150.0	H	301.0	11.8

EUT Information

EUT Name:	Bluetooth module
Model:	AC6951
Test Mode:	BR_DH5_Mid channel
Order No/Sample No:	168453215/A003605155-008
Test Voltage:::	DC 5V
Remark:	Temp 23 Humi:53%
Test Standard:	FCC 15.247
Tested By:	Kei Zhang
Reviewed By:	Terry Yin

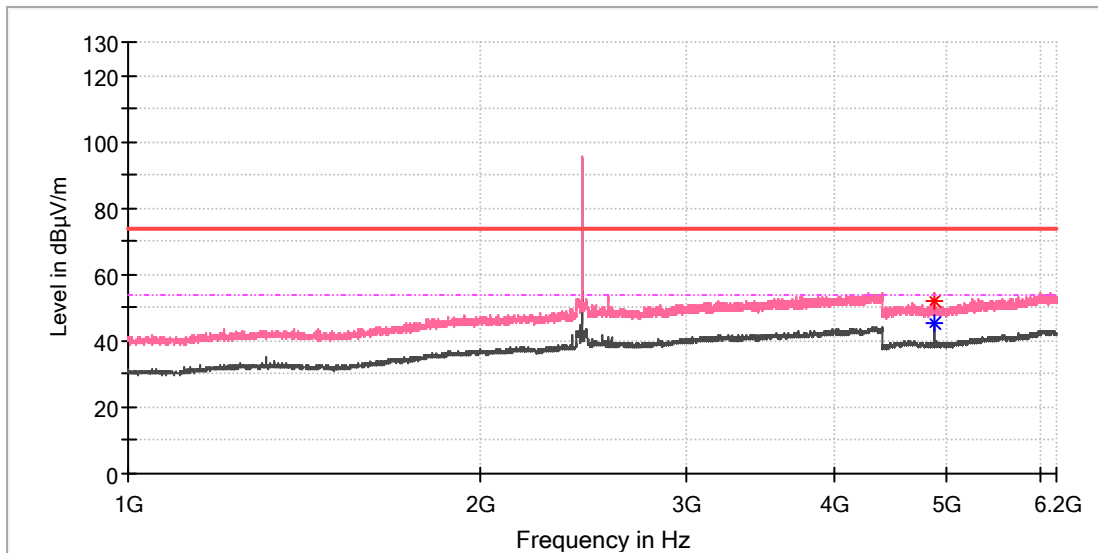

Critical Freqs

Frequency (MHz)	MaxPeak (dBµV/m)	Average (dBµV/m)	Limit (dBµV/m)	Margin (dB)	Height (cm)	Pol	Azimuth (deg)	Corr. (dB/m)
4881.500000	51.96	---	74.00	22.04	150.0	V	124.0	11.8
4882.000000	---	45.29	54.00	8.71	150.0	V	14.0	11.8

EUT Information

EUT Name:	Bluetooth module
Model:	AC6951
Test Mode:	BR_DH5_High channel
Order No/Sample No:	168453215/A003605155-008
Test Voltage::	DC 5V
Remark:	Temp 23 Humi:53%
Test Standard:	FCC 15.247
Tested By:	Kei Zhang
Reviewed By:	Terry Yin

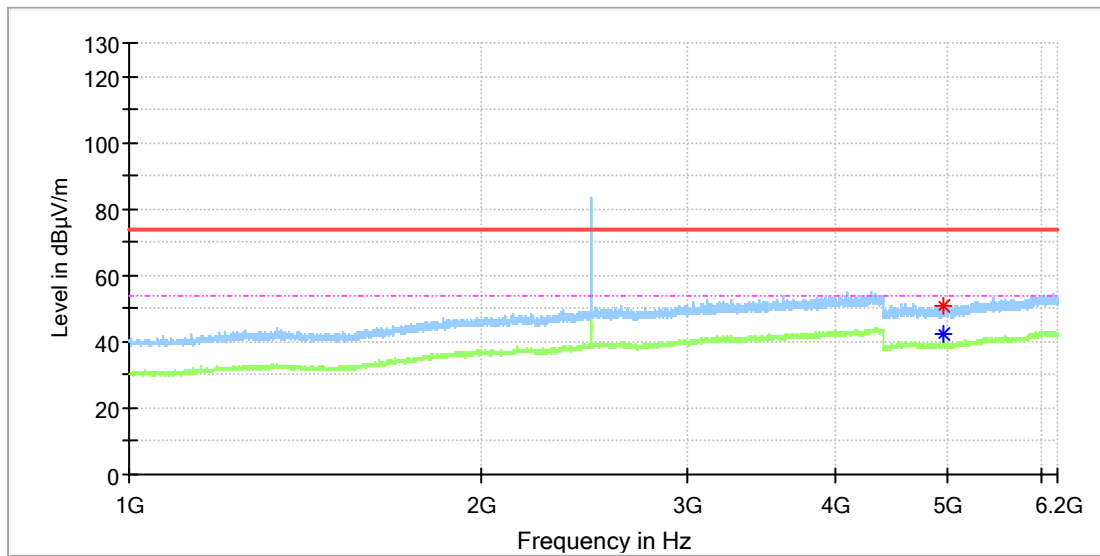

Critical_Freqs

Frequency (MHz)	MaxPeak (dBµV/m)	Average (dBµV/m)	Limit (dBµV/m)	Margin (dB)	Height (cm)	Pol	Azimuth (deg)	Corr. (dB/m)
4960.000000	50.87	---	74.00	23.13	150.0	H	28.0	11.8
4960.000000	---	42.46	54.00	11.54	150.0	H	28.0	11.8

EUT Information

EUT Name:	Bluetooth module
Model:	AC6951
Test Mode:	BR_DH5_High channel
Order No/Sample No:	168453215/A003605155-008
Test Voltage:::	DC 5V
Remark:	Temp 23 Humi:53%
Test Standard:	FCC 15.247
Tested By:	Kei Zhang
Reviewed By:	Terry Yin

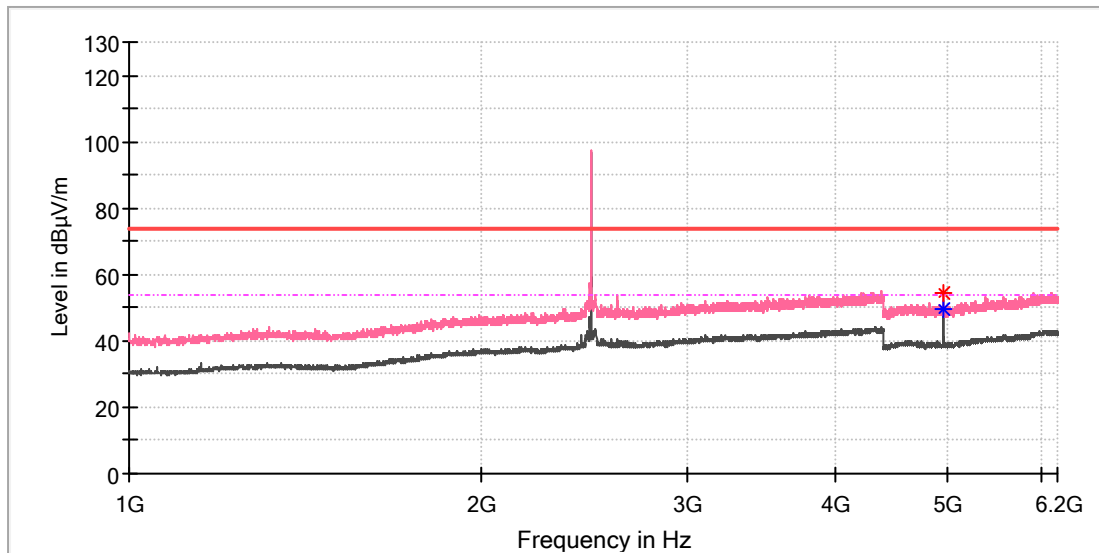

Critical Freqs

Frequency (MHz)	MaxPeak (dBµV/m)	Average (dBµV/m)	Limit (dBµV/m)	Margin (dB)	Height (cm)	Pol	Azimuth (deg)	Corr. (dB/m)
4960.000000	---	49.81	54.00	4.19	150.0	V	120.0	11.8
4960.000000	54.41	---	74.00	19.59	150.0	V	120.0	11.8

EUT Information

EUT Name:	Bluetooth module
Model:	AC6951
Test Mode:	BR_DH5_Low channel
Order No/Sample No:	168453215/A003605155-008
Test Voltage:::	DC 5V
Remark:	Temp 23 Humi:53%
Test Standard:	FCC 15.247
Tested By:	Kei Zhang
Reviewed By:	Terry Yin

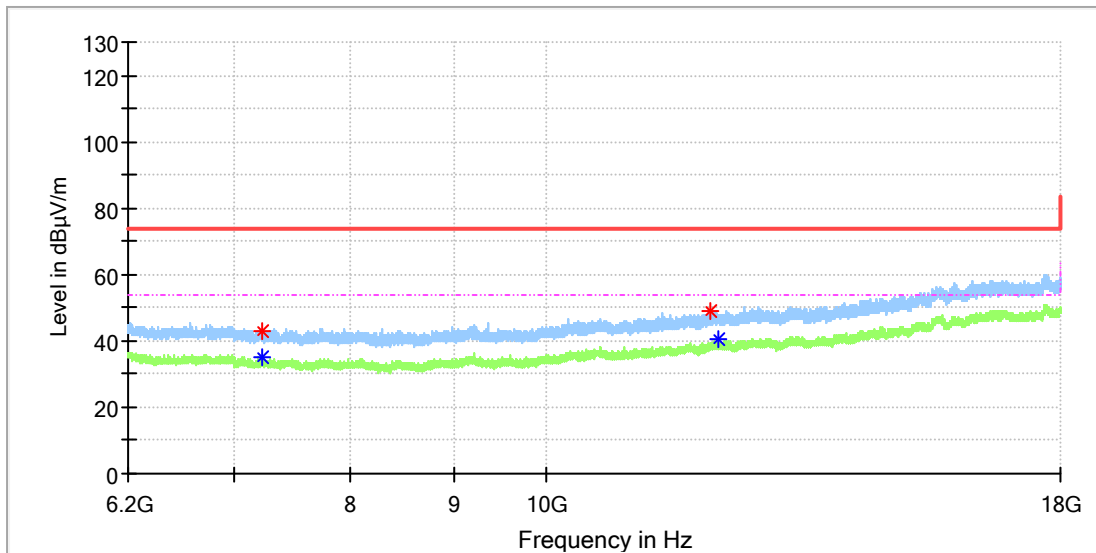

Critical Freqs

Frequency (MHz)	MaxPeak (dBµV/m)	Average (dBµV/m)	Limit (dBµV/m)	Margin (dB)	Height (cm)	Pol	Azimuth (deg)	Corr. (dB/m)
7227.091667	42.98	---	74.00	31.02	150.0	H	188.0	8.7
7229.550000	---	34.95	54.00	19.05	150.0	H	164.0	8.6
12066.075000	48.82	---	74.00	25.18	150.0	H	0.0	14.0
12159.983333	---	40.33	54.00	13.67	150.0	H	0.0	14.5

EUT Information

EUT Name:	Bluetooth module
Model:	AC6951
Test Mode:	BR_DH5_Low channel
Order No/Sample No:	168453215/A003605155-008
Test Voltage:::	DC 5V
Remark:	Temp 23 Humi:53%
Test Standard:	FCC 15.247
Tested By:	Kei Zhang
Reviewed By:	Terry Yin

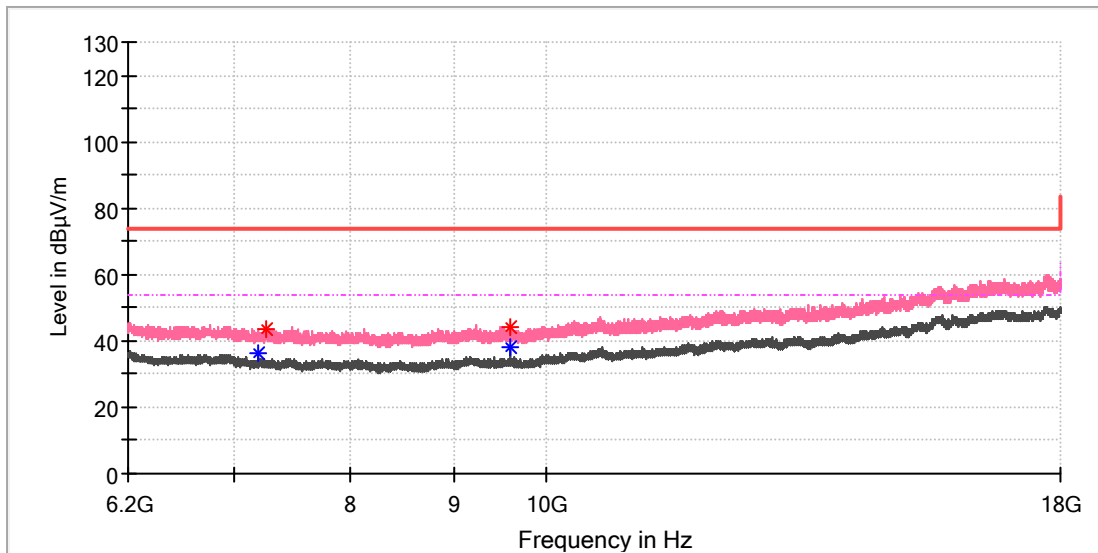

Critical Freqs

Frequency (MHz)	MaxPeak (dBµV/m)	Average (dBµV/m)	Limit (dBµV/m)	Margin (dB)	Height (cm)	Pol	Azimuth (deg)	Corr. (dB/m)
7200.050000	---	36.58	54.00	17.42	150.0	V	79.0	8.8
7252.166667	43.78	---	74.00	30.22	150.0	V	0.0	8.5
9601.841667	44.40	---	74.00	29.60	150.0	V	91.0	10.4
9601.841667	---	37.96	54.00	16.04	150.0	V	91.0	10.4

EUT Information

EUT Name:	Bluetooth module
Model:	AC6951
Test Mode:	BR_DH5_Mid channel
Order No/Sample No:	168453215/A003605155-008
Test Voltage:::	DC 5V
Remark:	Temp 23 Humi:53%
Test Standard:	FCC 15.247
Tested By:	Kei Zhang
Reviewed By:	Terry Yin

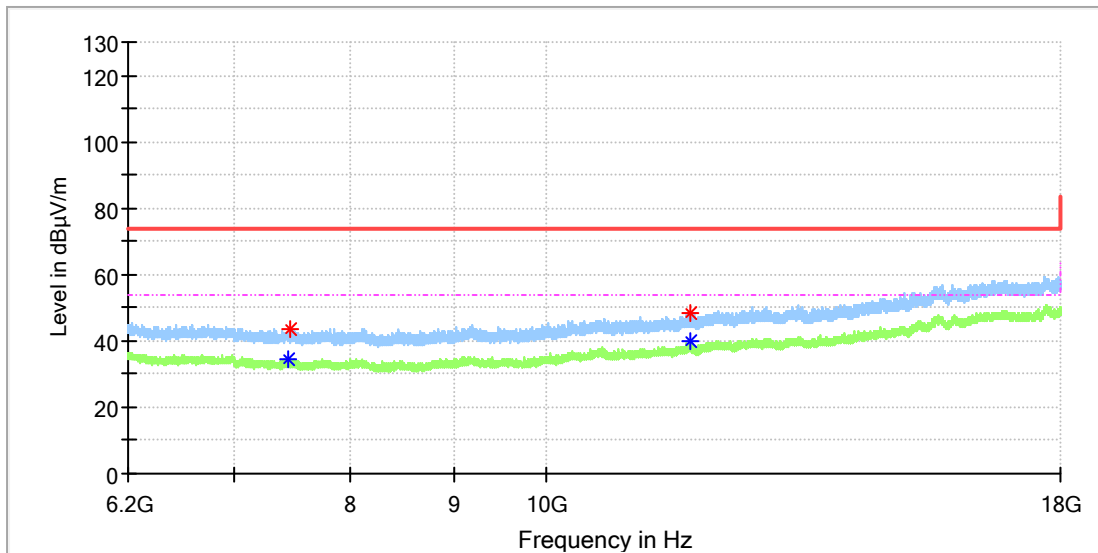

Critical Freqs

Frequency (MHz)	MaxPeak (dBµV/m)	Average (dBµV/m)	Limit (dBµV/m)	Margin (dB)	Height (cm)	Pol	Azimuth (deg)	Corr. (dB/m)
7437.033333	---	34.76	54.00	19.24	150.0	H	34.0	8.4
7460.141667	43.66	---	74.00	30.34	150.0	H	132.0	8.5
11793.200000	---	39.66	54.00	14.34	150.0	H	95.0	13.4
11799.591667	48.23	---	74.00	25.77	150.0	H	181.0	13.4

EUT Information

EUT Name:	Bluetooth module
Model:	AC6951
Test Mode:	BR_DH5_Mid channel
Order No/Sample No:	168453215/A003605155-008
Test Voltage::	DC 5V
Remark:	Temp 23 Humi:53%
Test Standard:	FCC 15.247
Tested By:	Kei Zhang
Reviewed By:	Terry Yin

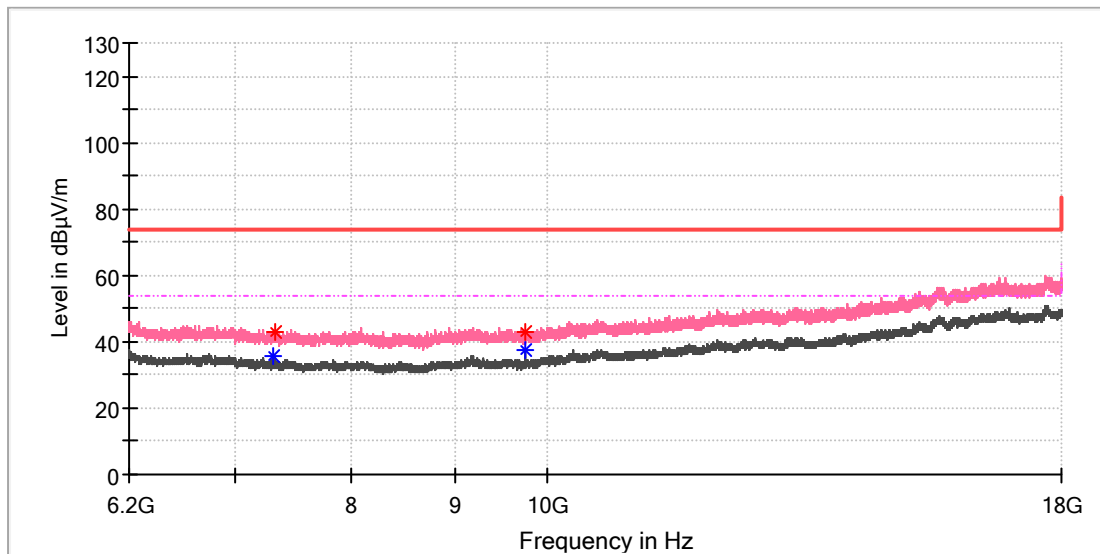

Critical_Freqs

Frequency (MHz)	MaxPeak (dBµV/m)	Average (dBµV/m)	Limit (dBµV/m)	Margin (dB)	Height (cm)	Pol	Azimuth (deg)	Corr. (dB/m)
7317.066667	---	35.41	54.00	18.59	150.0	V	58.0	8.2
7321.983333	43.11	---	74.00	30.89	150.0	V	335.0	8.2
9758.191667	43.21	---	74.00	30.79	150.0	V	180.0	10.4
9758.191667	---	37.58	54.00	16.42	150.0	V	180.0	10.4

EUT Information

EUT Name:	Bluetooth module
Model:	AC6951
Test Mode:	BR_DH5_High channel
Order No/Sample No:	168453215/A003605155-008
Test Voltage:::	DC 5V
Remark:	Temp 23 Humi:53%
Test Standard:	FCC 15.247
Tested By:	Kei Zhang
Reviewed By:	Terry Yin

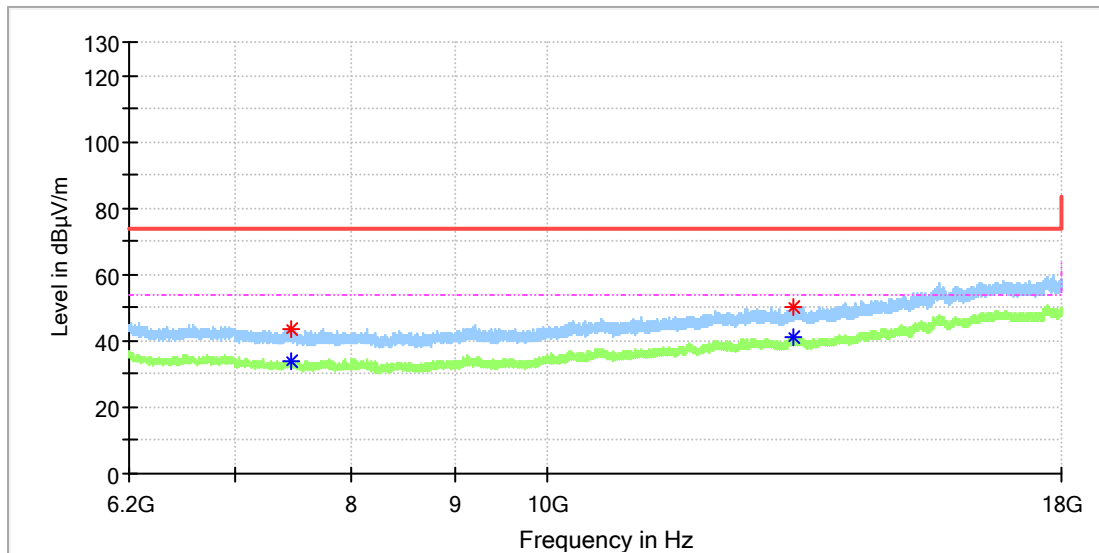

Critical Freqs

Frequency (MHz)	MaxPeak (dBµV/m)	Average (dBµV/m)	Limit (dBµV/m)	Margin (dB)	Height (cm)	Pol	Azimuth (deg)	Corr. (dB/m)
7457.683333	---	34.14	54.00	19.86	150.0	H	359.0	8.5
7464.075000	43.28	---	74.00	30.72	150.0	H	359.0	8.6
13242.633333	50.33	---	74.00	23.67	150.0	H	182.0	15.5
13254.433333	---	40.86	54.00	13.14	150.0	H	217.0	15.5

EUT Information

EUT Name:	Bluetooth module
Model:	AC6951
Test Mode:	BR_DH5_High channel
Order No/Sample No:	168453215/A003605155-008
Test Voltage:::	DC 5V
Remark:	Temp 23 Humi:53%
Test Standard:	FCC 15.247
Tested By:	Kei Zhang
Reviewed By:	Terry Yin

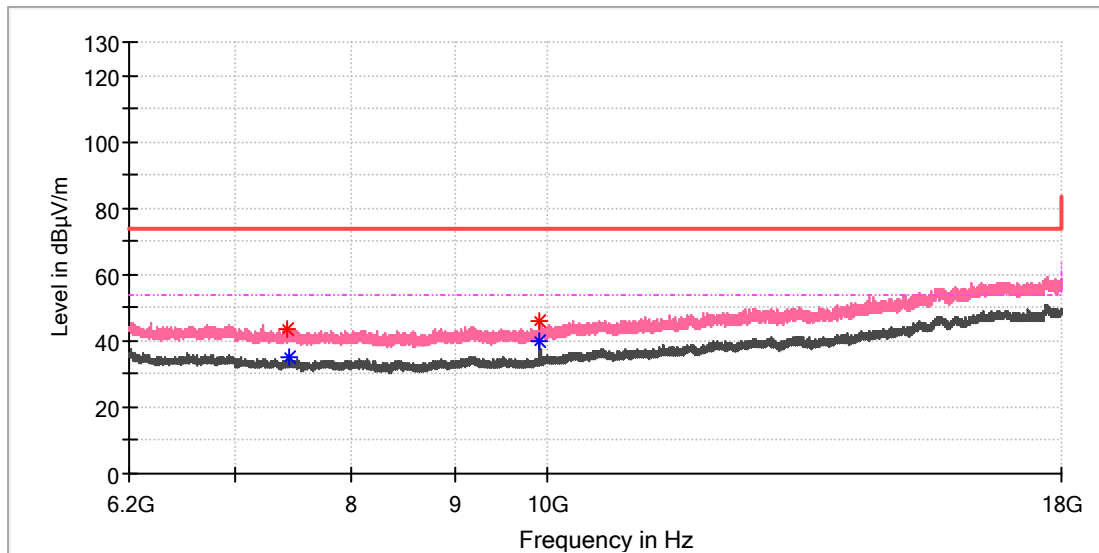

Critical Freqs

Frequency (MHz)	MaxPeak (dBµV/m)	Average (dBµV/m)	Limit (dBµV/m)	Margin (dB)	Height (cm)	Pol	Azimuth (deg)	Corr. (dB/m)
7435.066667	43.54	---	74.00	30.46	150.0	V	317.0	8.4
7439.983333	---	34.82	54.00	19.18	150.0	V	292.0	8.4
9914.050000	---	39.79	54.00	14.21	150.0	V	55.0	10.8
9918.966667	45.94	---	74.00	28.06	150.0	V	89.0	10.8

Appendix A.9: Test Results of Radiated Emissions in Restricted Bands

EUT Information

EUT Name:	Bluetooth module
Model:	AC6951
Test Mode:	BR_DH5_Low channel
Order No/Sample No:	168453215/A003605155-008
Test Voltage:::	DC 5V
Remark:	Temp 23 Humi:53%
Test Standard:	FCC 15.247
Tested By:	Kei Zhang
Reviewed By:	Terry Yin

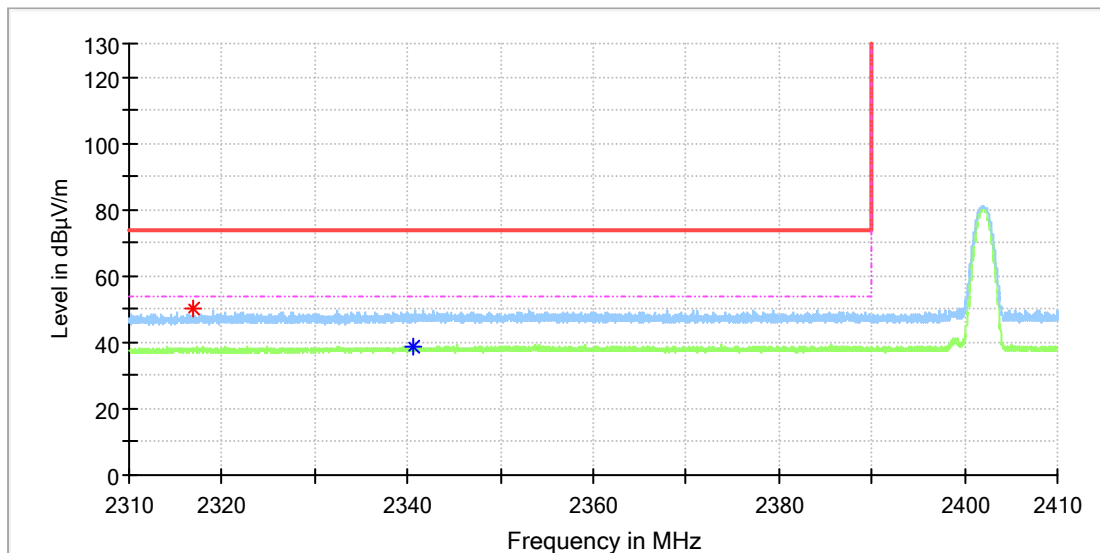

Critical Freqs

Frequency (MHz)	MaxPeak (dBµV/m)	Average (dBµV/m)	Limit (dBµV/m)	Margin (dB)	Height (cm)	Pol	Azimuth (deg)	Corr. (dB/m)
2316.955882	50.17	---	74.00	23.83	150.0	H	189.0	6.6
2340.602941	---	38.71	54.00	15.29	150.0	H	42.0	6.8

EUT Information

EUT Name:	Bluetooth module
Model:	AC6951
Test Mode:	BR_DH5_Low channel
Order No/Sample No:	168453215/A003605155-008
Test Voltage:::	DC 5V
Remark:	Temp 23 Humi:53%
Test Standard:	FCC 15.247
Tested By:	Kei Zhang
Reviewed By:	Terry Yin

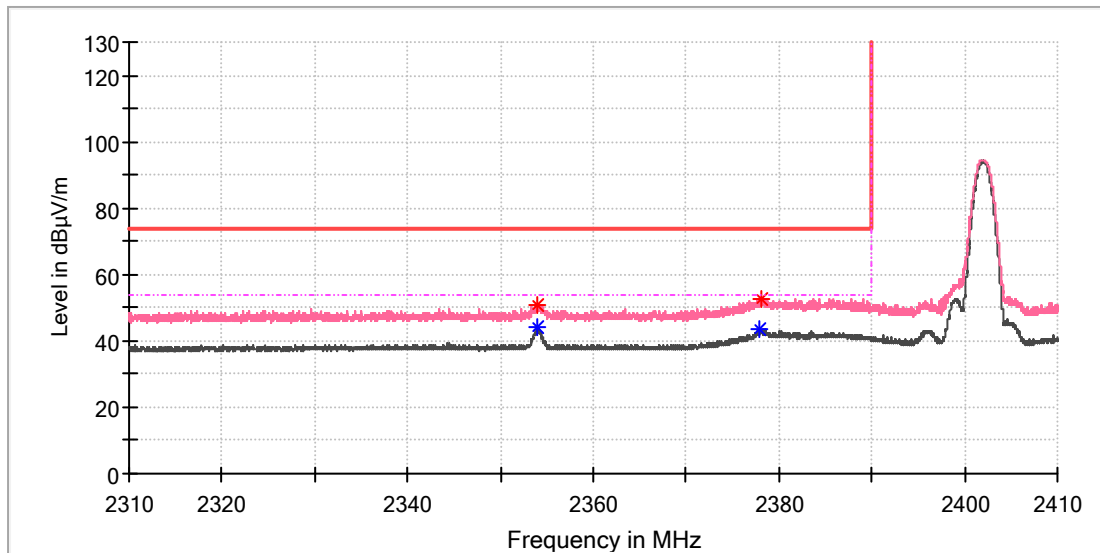

Critical Freqs

Frequency (MHz)	MaxPeak (dBµV/m)	Average (dBµV/m)	Limit (dBµV/m)	Margin (dB)	Height (cm)	Pol	Azimuth (deg)	Corr. (dB/m)
2353.941177	---	44.01	54.00	9.99	150.0	V	355.0	6.9
2354.029412	50.53	---	74.00	23.47	150.0	V	0.0	6.9
2377.941177	---	43.24	54.00	10.76	150.0	V	60.0	6.9
2378.073529	52.80	---	74.00	21.20	150.0	V	209.0	6.9

EUT Information

EUT Name:	Bluetooth module
Model:	AC6951
Test Mode:	BR_DH5_High channel
Order No/Sample No:	168453215/A003605155-008
Test Voltage:::	DC 5V
Remark:	Temp 23 Humi:53%
Test Standard:	FCC 15.247
Tested By:	Kei Zhang
Reviewed By:	Terry Yin

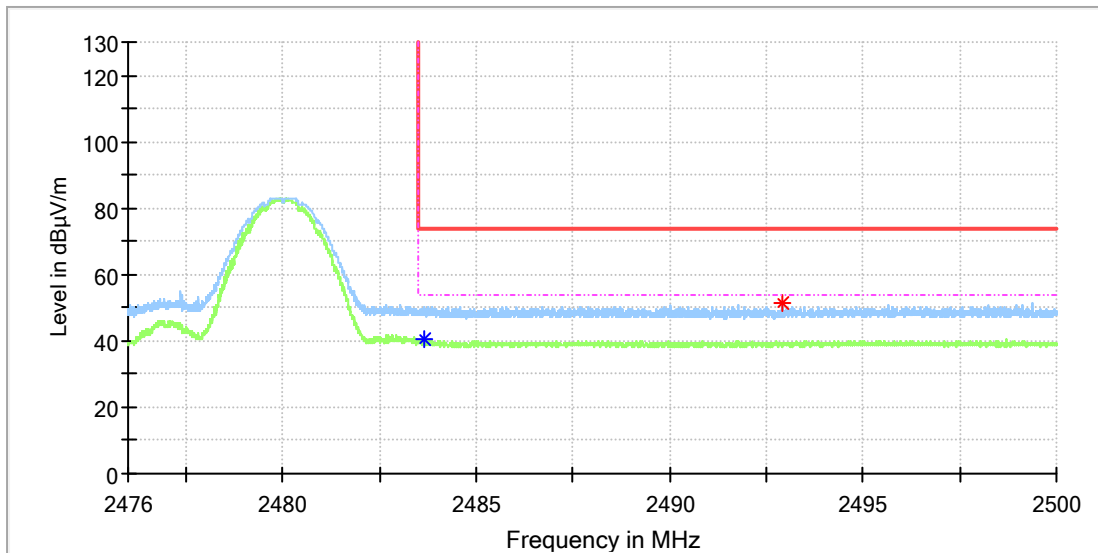

Critical Freqs

Frequency (MHz)	MaxPeak (dBµV/m)	Average (dBµV/m)	Limit (dBµV/m)	Margin (dB)	Height (cm)	Pol	Azimuth (deg)	Corr. (dB/m)
2483.662353	---	40.31	54.00	13.69	150.0	H	25.0	7.4
2492.920000	51.36	---	74.00	22.64	150.0	H	193.0	7.4

EUT Information

EUT Name:	Bluetooth module
Model:	AC6951
Test Mode:	BR_DH5_High channel
Order No/Sample No:	168453215/A003605155-008
Test Voltage:::	DC 5V
Remark:	Temp 23 Humi:53%
Test Standard:	FCC 15.247
Tested By:	Kei Zhang
Reviewed By:	Terry Yin

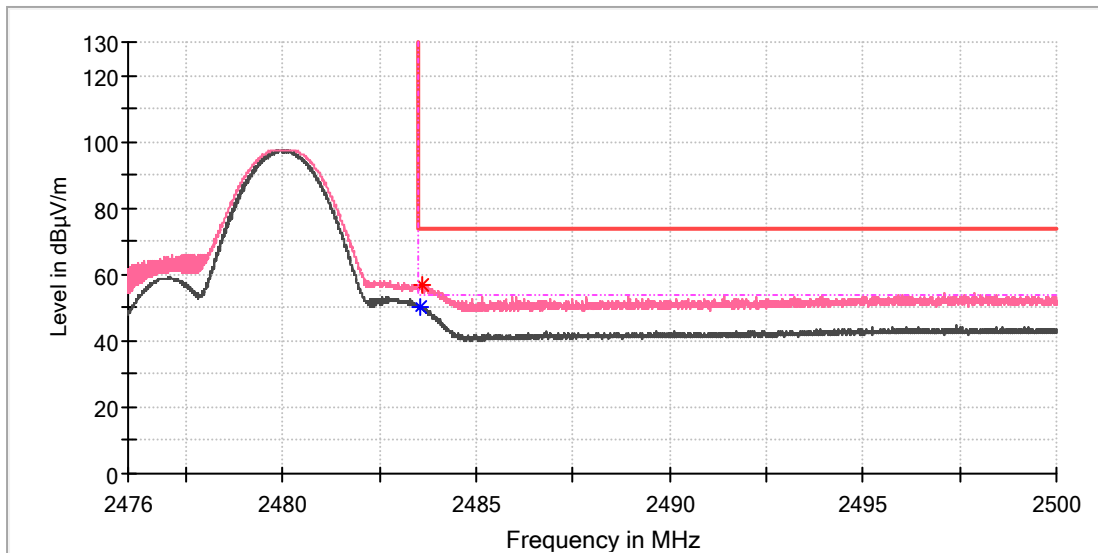

Critical Freqs

Frequency (MHz)	MaxPeak (dBµV/m)	Average (dBµV/m)	Limit (dBµV/m)	Margin (dB)	Height (cm)	Pol	Azimuth (deg)	Corr. (dB/m)
2483.560000	---	50.48	54.00	3.52	150.0	V	259.0	7.4
2483.577647	56.92	---	74.00	17.08	150.0	V	66.0	7.4

Appendix A.10: Test Results of Conducted Emissions

EUT Information

EUT Name	Bluetooth module
Model:	AC6951
Test Mode:	Bluetooth operating
Test Voltage:	AC 120V/60Hz
Test Standard:	FCC Part 15
Test By:/Review By:	Shower Dai / Gary Chen
Tem./Hum./Pressure:	24.9°C/51.8%/101kPa
Remark:	SR1

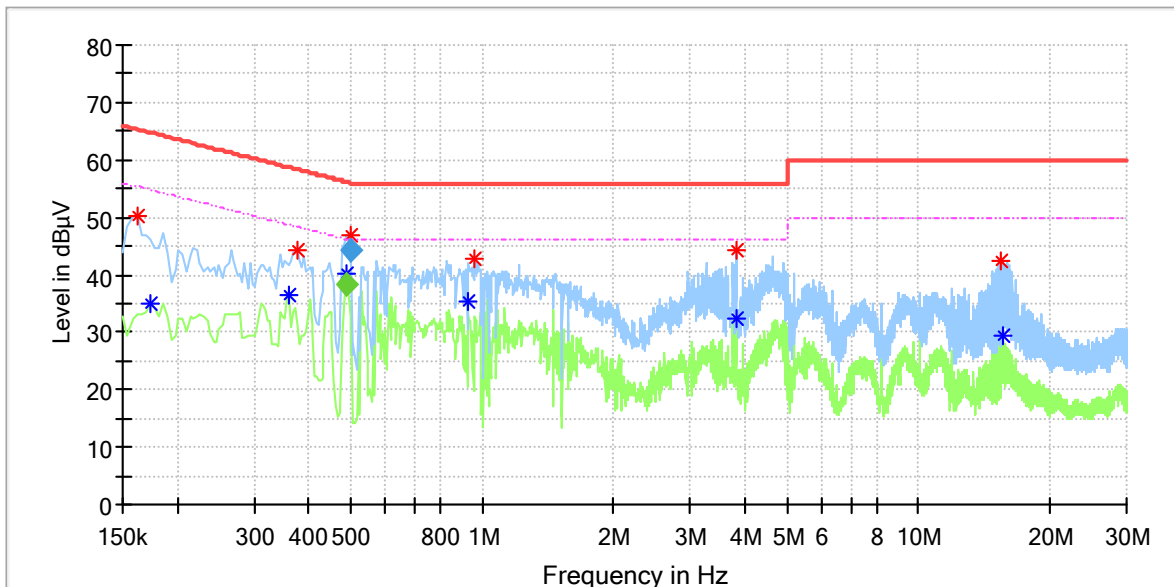

Critical Freqs

Frequency (MHz)	MaxPeak (dBµV)	Average (dBµV)	Limit (dBµV)	Margin (dB)	Line	Corr. (dB)
0.162000	50.37	---	65.36	14.99	L1	9.7
0.174000	---	34.98	54.77	19.78	L1	9.7
0.362000	---	36.47	48.68	12.22	L1	9.9
0.378000	44.45	---	58.32	13.87	L1	9.9
0.488500	---	40.32	46.24	5.92	L1	9.9
0.499500	46.93	---	56.24	9.31	L1	9.9
0.928000	---	35.45	46.00	10.55	L1	9.7
0.964000	42.70	---	56.00	13.30	L1	9.7
3.824000	---	32.54	46.00	13.46	L1	10.0
3.824000	44.39	---	56.00	11.61	L1	10.0
15.456000	42.46	---	60.00	17.54	L1	10.1
15.556000	---	29.23	50.00	20.77	L1	10.2

Final Result

Frequency (MHz)	QuasiPeak (dBµV)	Average (dBµV)	Limit (dBµV)	Margin (dB)	Meas. Time (ms)	Bandwidth (kHz)	Line	Corr. (dB)
0.488500	---	38.14	46.19	8.05	1000.0	9.000	L1	9.9
0.499500	44.43	---	56.01	11.58	1000.0	9.000	L1	9.9

EUT Information

EUT Name	Bluetooth module
Model:	AC6951
Test Mode:	Bluetooth operating
Test Voltage:	AC 120V/60Hz
Test Standard:	FCC Part 15
Test By:/Review By:	Shower Dai / Gary Chen
Tem./Hum./Pressure:	24.9°C/51.8%/101kPa
Remark:	SR1

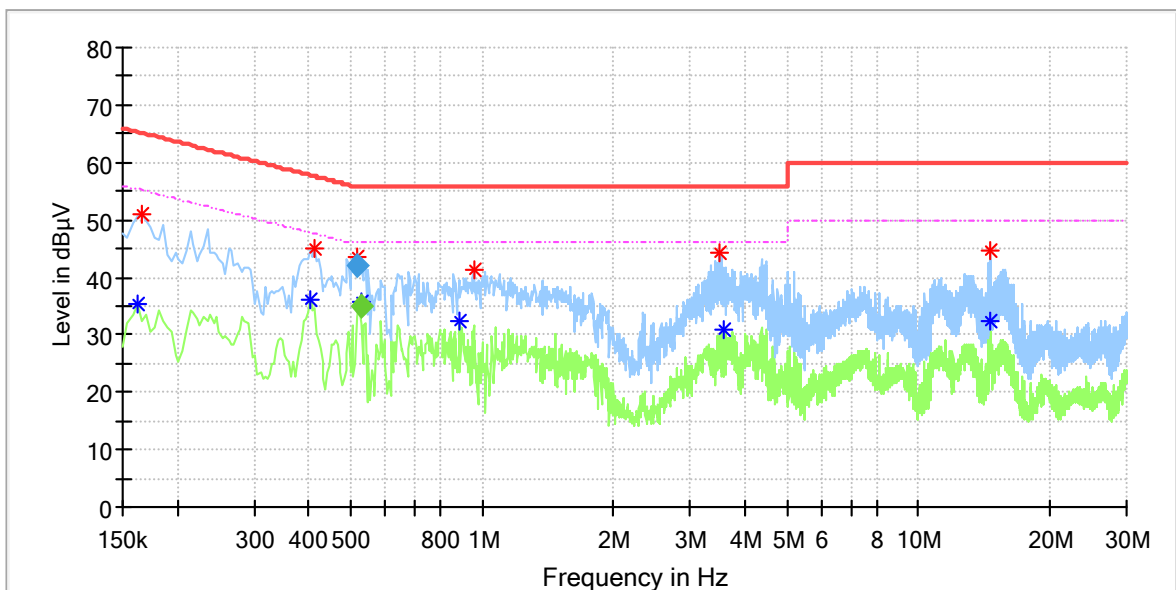

Critical Freqs

Frequency (MHz)	MaxPeak (dBµV)	Average (dBµV)	Limit (dBµV)	Margin (dB)	Line	Corr. (dB)
0.162000	---	35.47	55.36	19.89	N	9.8
0.166000	50.83	---	65.16	14.33	N	9.8
0.402000	---	35.94	47.81	11.88	N	9.7
0.414000	44.86	---	57.57	12.71	N	9.7
0.518500	43.58	---	56.00	12.42	N	9.7
0.530500	---	35.54	46.00	10.46	N	9.7
0.888000	---	32.28	46.00	13.72	N	9.7
0.956000	41.40	---	56.00	14.60	N	9.6
3.504000	44.35	---	56.00	11.65	N	10.0
3.592000	---	30.93	46.00	15.07	N	10.0
14.628000	---	32.32	50.00	17.68	N	10.1
14.628000	44.50	---	60.00	15.50	N	10.1

Final Result

Frequency (MHz)	QuasiPeak (dBµV)	Average (dBµV)	Limit (dBµV)	Margin (dB)	Meas. Time (ms)	Bandwidth (kHz)	Line	Corr. (dB)
0.518500	42.00	---	56.00	14.00	1000.0	9.000	N	9.7
0.530500	---	34.94	46.00	11.06	1000.0	9.000	N	9.7