

**Emission Test Report**  
**Standard: FCC Part 15 Subpart C / IC RSS-210**  
**Class II Permissive Change**

**Document Number : FCC 19-0267-0**

**Model Number: U58H004**  
measured with **IBM ThinkPad T40 Series, LCD 15 inch model**

**FCC ID: ANOU58H004**  
**IC: 349E-U58H004**

**April 2, 2004**

**Prepared :**  
**EMC R&D Staff Engineer**

**Takeshi Asano**

**Signature:**   
**IBM Japan, Ltd.**  
**EMC Engineering**  
**LAB-S59**

**1623-14, Shimotsuruma,**  
**Yamato-shi Kanagawa-ken 242, Japan**  
**Phone: +81-46-215-4779**  
**Fax: +81-46-273-7420**  
**E-Mail: asano@jp.ibm.com**

**Reviewed and Checked :**  
**EMC Advisory R&D Engineer**

**Toshiya Murota**

**Signature:**   
**IBM Japan, Ltd.**  
**EMC Engineering**  
**LAB-S59**

**1623-14, Shimotsuruma,**  
**Yamato-shi Kanagawa-ken 242, Japan**  
**Phone: +81-46-215-6574**  
**Fax: +81-46-273-7420**  
**E-Mail: murota@jp.ibm.com**

**Approved :**  
**Manager, EMC Engineering**  
**/ NVLAP signatory**

**Akihisa Sakurai**  
**Signature:**   
**IBM Japan, Ltd.**  
**EMC Engineering**  
**LAB-S59**

**1623-14, Shimotsuruma,**  
**Yamato-shi Kanagawa-ken 242, Japan**  
**Phone: +81-46-215-2613**  
**Fax: +81-46-273-7420**  
**E-Mail: akihisa@jp.ibm.com**

## MEASUREMENT / TECHNICAL REPORT – Part 15 Subpart C (Intentional Radiator)

**Model Number: U58H004 (IEEE802.11b Wireless LAN Adapter)  
with  
IBM ThinkPad T40 Series, LCD 15 inch model  
(Machine type : 2373, 2374, 2375, 2376, 2378, 2379)**

**FCC ID : ANOU58H004**

**April 2, 2004**

This report concerns: (check one) Original Grant     _____ Class I change     _____ Class II change <u>  ✓  </u>
Equipment type: <u>Wireless LAN device</u>
This report shall not be reproduced except in full, without the written permission of this test lab.
The measurement results contained in this report relate only to the item which was tested.
Measurement procedure used is ANSI C63.4-2000 unless otherwise specified.
Other test procedure: _____
The FCC has issued provisional acceptance of this test laboratory for Declaration of Conformity testing per letter dated 1997.
<b>APPLICANT ANTI-DRUG ABUSE CERTIFICATION:</b> By checking yes, the applicant certifies that, in the case of an individual applicant, he or she is not subject to a denial of federal benefits, that includes FCC benefits, pursuant to Section 5301 of the Anti-Drug Abuse of 1988, 21 U.S.C. 853(a), or, in the case of a non-individual applicant (e.g. corporation, partnership or other unincorporated association), no party to the application is subject to a denial of federal benefits, that includes FCC benefits, pursuant to that section. For the definition of a “party” for these purposes, see 47 CFR 1.2002(b).  <div style="text-align: center;"> <input checked="" type="radio"/> Yes    or    No                 </div>
“Report shall not be reproduced except in full, without the written approval of the laboratory” “the report must not be used by the client to claim product endorsement by NVLAP or any agency of the US government”
Prepared by: Takeshi Asano  <div style="text-align: right;">                     IBM Japan Corporation, Yamato EMC Engineering                      LAB-S59, 1623-14, Shimotsuruma, Yamato-shi Kanagawa-ken 242-8502, Japan                      Tel: +81-46-215-4779 Fax: +81-46-273-7420                 </div>

**- Index -**

**A. GENERAL INFORMATION.....5**

**A.1 TEST METHODOLOGY.....5**

**A.2 TEST FACILITY / NVLAP ACCREDITATION.....5**

**A.3 EUT DETAILS.....5**

**B. SUMMARY OF TEST RESULTS .....6**

**C. OPERATION MODE OF EUT.....7**

**D. JUSTIFICATION.....7**

**E. TEST INSTRUMENTS.....8**

**F. MEASUREMENT UNCERTAINTY.....9**

**G. TEMPERATURE AND HUMIDITY.....9**

**H. RELATED SUBMITTAL(S)/GRANT(S)/NOTES.....9**

**1. BANDWIDTH AT 6 DB BELOW..... 10**

**1.1 TEST PROCEDURE..... 10**

**1.2 TEST INSTRUMENTS AND MEASUREMENT SETUP ..... 10**

**1.3 MEASUREMENT RESULTS ..... 10**

**1.4 TRACE DATA OF 6DB BANDWIDTH ..... 11**

**2. OCCUPIED BANDWIDTH (20 DB BANDWIDTH)..... 17**

**2.1 TEST PROCEDURE..... 17**

**2.2 TEST INSTRUMENTS AND MEASUREMENT SETUP ..... 17**

**2.3 MEASUREMENT RESULTS ..... 17**

**2.4 TRACE DATA OF OCCUPIED BANDWIDTH ..... 18**

**3. CONDUCTED PEAK OUTPUT POWER..... 21**

**3.1 TEST PROCEDURE..... 21**

**3.2 MEASUREMENT RESULTS ..... 22**

**3.3 TRACE DATA OF CONDUCTED PEAK OUTPUT POWER ..... 23**

**4. OUT OF BAND EMISSIONS (CONDUCTED SPURIOUS)..... 26**

**4.1 TEST PROCEDURE..... 26**

**4.2 TEST INSTRUMENTS AND MEASUREMENT SETUP ..... 26**

**4.3 MEASUREMENT RESULTS ..... 26**

**4.4 TRACE DATA OF OUT OF BAND EMISSIONS ..... 27**

**5. PEAK POWER SPECTRAL DENSITY..... 30**

**5.1 TEST PROCEDURE..... 30**

**5.2 TEST INSTRUMENTS AND MEASUREMENT SETUP ..... 30**

**5.3 MEASUREMENT RESULTS ..... 30**

**5.4 TRACE DATA OF PEAK POWER SPECTRAL DENSITY ..... 31**

**6. AC WIRELINE CONDUCTED EMISSIONS (150KHZ – 30MHZ)..... 34**

**6.1 TEST PROCEDURE..... 34**

**6.2 TEST INSTRUMENTS AND MEASUREMENT SETUP ..... 34**

**6.3 POWERLINE VOLTAGE CALCULATION..... 35**

**6.4 MEASUREMENT RESULTS ..... 36**

**7. RESTRICTED BANDS RADIATIONS (30MHZ – 1GHZ) ..... 38**

- 7.1 TEST PROCEDURE.....38**
- 7.2 TEST INSTRUMENTS AND MEASUREMENT SETUP .....38**
- 7.3 FIELD STRENGTH CALCULATION.....40**
- 7.4 MEASUREMENT RESULTS .....41**

**8. RESTRICTED BANDS RADIATIONS (1GHZ – 25GHZ).....42**

- 8.1 TEST PROCEDURE.....42**
- 8.2 TEST INSTRUMENTS AND MEASUREMENT SETUP .....42**
- 8.3 FIELD STRENGTH CALCULATION.....44**
- 8.4 MEASUREMENT RESULTS .....45**
- 8.5 MEASUREMENT PLOTS OF ADJACENT RESTRICTED BAND .....47**

## A. General Information

APPLICANT	: IBM Japan, Ltd.
TEST SITE	: IBM Japan, Ltd., Yamato Semi-anechoic chamber #1
TEST SITE ADDRESS	: 1623 – 14 Shimotsuruma, Yamato-shi, Kanagawa 242-8502 Japan Tel: +81-46-215-4779, Fax: +81-46-273-7420
REGULATION	: FCC Part 15 Subpart C Industry Canada RSS-210 (Issue No.5)
MODEL NUMBER (Advertising Name)	: U58H004 (Cisco Aironet Wireless 802.11b)
FCC ID	: ANOU58H004
IC Certification Number	: 349E-U58H004
SERIAL NUMBER	: 00000001DH9
PHYSICAL CONDITION	: Preproduction
KIND OF EQUIPMENT	: DTS: IEEE802.11b Wireless LAN Mini-PCI card
TESTED DATE	: March 23, 24, 25 and 26, 2004

### A.1 Test Methodology

Both conducted and radiated testing were performed according to the procedures in ANSI C63.4-2000. Radiated testing was performed at an antenna to EUT distance of 3 meters.

### A.2 Test Facility / NVLAP Accreditation

The semi-anechoic chamber #1 used to correct the data are located in Yamato Laboratory, IBM Japan.

- This facility has been fully described in a report dated September 1998, submitted to the FCC office, and accepted in a letter, dated Nov. 2, 1998(31040/SIT).
- IBM Yamato EMC Engineering is recognized under the National Voluntary Laboratory Accreditation Program for satisfactory compliance with Criteria established in Title 15, Part 285 Code of Federal Regulations, (**NVLAP Lab code: 200198-0**)
- These facilities are accepted by **Industry Canada** as number **IC 4221** for chamber #1 (expiry date: January 25, 2005), and as number **IC 4221-1** for chamber #2 (expiry date: February 16, 2007).

### A.3 EUT details

Table A EUT details

Model and S/N	FCC ID IC Certification Number	Description
U58H004 (s/n 00000001DH9)	FCC ID: ANOU58H004 IC: 349E-U58H004	<b>Applying modular transmitter</b> Built_in type IEEE802.11b Wireless LAN Mini-PCI card without antenna
ThinkPad T40 Series M/T : 2373-PUU(15inch) (s/n ZZ-22134)	N/A	Host equipment IBM Notebook PC with built_in antenna CPU: Intel® Pentium® M Processor 735, 1.7GHz
P/N 02K6746	N/A	Universal AC adapter 72W, Unshielded power cord

## B. Summary of Test Results

Table-B presents the list of the measurement items for DTS (Digital Transmissions System) devices under FCC Part 15 Subpart C, and Spread Spectrum Direct Sequence Systems regarding Industry Canada RSS-210. The section numbers of upper portion are showing FCC number, and the other (lower) ones are for IC.

Table-B List of the measurements

Section(s)	Test Items : Transmit mode (TX):		Condition	Result
<a href="#">15.247(a)(2)</a> <a href="#">6.2.2(o)(b)</a>	Bandwidth at 6 dB below	FCC requirement	Conducted	Pass
- <a href="#">5.9.1</a>	Occupied BW (Bandwidth at 20 dB below)	IC requirement		Pass
<a href="#">15.247(c)</a> <a href="#">6.2.2(o)(e1)</a>	Out of Band Emissions	The radiated emission in any 100kHz of outband shall be at least 20dB below the highest inband spectral density.		Pass
<a href="#">15.247(b)(3)</a> <a href="#">6.2.2(o)(b)</a>	Transmitter peak output power	Shall not exceed 1.0 W.		Pass
<a href="#">15.247(d)</a> <a href="#">6.2.2(o)(b)</a>	Transmitter power spectral Density	Shall not be greater than 8 dBm in any 3kHz band.		Pass
<a href="#">15.207</a> <a href="#">6.2.2(o)(e3)</a> / <a href="#">6.6</a>	AC Wireline Conducted Emissions 150kHz – 30MHz	Class B: Freq.(MHz) QP(dBμV) Ave.(dBμV) 0.15 - 0.5 66 - 56 56 - 46 0.5 - 5 56 46 5 - 30 60 50		Pass
<a href="#">15.205 / 209</a> <a href="#">6.2.1</a> / <a href="#">6.2.2(o)(e3)</a> / <a href="#">6.3</a>	General Field Strength Limits (Restricted Bands and Radiated Emission Limits)	Shall not exceed the limits specified in FCC 15.209 or RSS-210 Table3.	Radiated (30MHz-1GHz)	Pass
			Radiated (1– 25GHz)	Pass

Test Items : Receive mode (RX):				
<a href="#">15.207</a> <a href="#">6.2.2(o)(e3)</a> / <a href="#">7.4</a>	AC Wireline Conducted Emissions 150kHz – 30MHz	Class B: Freq.(MHz) QP(dBμV) Ave.(dBμV) 0.15 - 0.5 66 - 56 56 - 46 0.5 - 5 56 46 5 - 30 60 50	Conducted	Pass
<a href="#">15.205 / 209</a> <a href="#">6.2.1</a> / <a href="#">6.2.2(o)(e3)</a> / <a href="#">7.3</a>	General Field Strength Limits (Restricted Bands and Radiated Emission Limits)	Shall not exceed the limits specified in FCC 15.209 or RSS-210 Table3.	Radiated (30MHz -1GHz)	Pass
			Radiated (1– 25GHz)	Pass

Other requirements				Result
<a href="#">15.247(b)(4)(i)</a> -	Antenna gain	Peak gain of the device : 1.24 dBi		N/A
- <a href="#">5.2</a>	Supply Voltage	Main power source: Universal AC adapter 72W Mini-PCI PC bus to applying card : DC 3.3V ± 0.3V		N/A
<a href="#">15.203</a> <a href="#">6.2.2(o)(e2)</a>	Unique antenna connector	The device employs an unique electronic connector so called <b>BIOS Lock</b> . Refer to “Confidential_BIOS-Lock” exhibit.		complies

### C. Operation Mode of EUT

All tests were performed using the “Venus MPI 350 Software”. Three kinds of modulation are used for transmission with appropriate bit rates:

Table C-1 Transmit mode (TX)

Operation Frequency [GHz]	Rated output power (conducted) [dBm]			Test performed*
	Bit rate 1/2Mbps	Bit rate 5.5Mbps	Bit rate 11Mbps	
2.412 (Ch. 1)	+20	+20	+20	X
2.417 (Ch. 2)	+20	+20	+20	
2.422 (Ch. 3)	+20	+20	+20	
2.427 (Ch. 4)	+20	+20	+20	
2.432 (Ch. 5)	+20	+20	+20	
2.437 (Ch. 6)	+20	+20	+20	X
2.442 (Ch. 7)	+20	+20	+20	
2.447 (Ch. 8)	+20	+20	+20	
2.452 (Ch. 9)	+20	+20	+20	
2.457 (Ch. 10)	+20	+20	+20	
2.462 (Ch. 11)	+20	+20	+20	X

\* Full testing with bit rate 11Mbps only

Table C-2 Receive mode (RX)

Operation Frequency [GHz]	Test performed
2.412 (Ch. 1)	
2.417 (Ch. 2)	
2.422 (Ch. 3)	
2.427 (Ch. 4)	
2.432 (Ch. 5)	
2.437 (Ch. 6)	X
2.442 (Ch. 7)	
2.447 (Ch. 8)	
2.452 (Ch. 9)	
2.457 (Ch. 10)	
2.462 (Ch. 11)	

### D. Justification

The EUT was investigated for both the main (left) and the auxiliary (right) antennas for each Tx mode. The worse case data taken in this report represents the measurement result of the left antenna that has comparatively higher gain in 2.4GHz as shown below.

Table-D Peak Antenna Gains of EUT

2.4GHz band	Left Antenna gain	1.24 dBi (peak)
	Right Antenna gain	0.38 dBi (peak)

## E. Test Instruments

Table-E List of Measuring Instruments

Description	Model	Serial Number	Calibration Date	Calibration Interval
Computer	IBM 6868-30J	97-901X3	N/A	N/A
Computer	IBM 6589-13J	97-15613	N/A	N/A
Spectrum Analyzer (100Hz-1.5GHz)	HP 85680B	2601A02634	09/09/03	1 year
Spectrum Analyzer (100Hz-1.5GHz)	HP 85680B	3019A05156	08/14/03	1 year
Spectrum Analyzer (100Hz-1.5GHz)	HP 85680B	2841A04254	08/25/03	1 year
Spectrum Analyzer Display	HP 85662A	2542A12308	09/09/03	1 year
Spectrum Analyzer Display	HP 85662A	3026A19366	08/14/03	1 year
Spectrum Analyzer Display	HP 85662A	2816A16831	08/25/03	1 year
Quasi-Peak Adapter	HP 85650A	2043A00062	09/09/03	1 year
Quasi-Peak Adapter	HP 85650A	2811A01433	08/14/03	1 year
Quasi-Peak Adapter	HP 85650A	2811A01156	08/25/03	1 year
Amplifier (100KHz - 1.3GHz) - for 30-200MHz - for 200-1000MHz	HP 8447F MITEQ AM-3A	2805A02919 898432	04/14/03 02/20/04	1 year 1 year
Amplifier (1 - 18GHz)	HP 8449B	3008A00582	06/11/03	1 year
Amplifier (18 - 25GHz)	Agilent 83051A	3950M00193	01/27/04	1 year
Spectrum Analyzer EMI Test Receiver	R&S ESI26	836119/003	05/01/03	1 year
Receiver (9kHz-30MHz)	R&S ESH3	891806/012	10/17/03	1 year
Receiver (20MHz-1.3GHz)	R&S ESVP	893202/018	02/10/04	1 year
Biconical Antenna (30-200MHz)	EMCO 3108	2536	04/23/03	1 year
Log-Periodic Antenna (200-1000MHz)	EMCO 3146	2849	04/23/03	1 year
Horn Antenna (1- 18GHz)	EMCO 3115	9903-5774	07/17/03	1 year
Horn Antenna (3.95- 5.85GHz)	EMCO 3160-5	1099	07/17/03	1 year
Horn Antenna (5.85- 8.20GHz)	EMCO 3160-6	9712-1044	07/17/03	1 year
Horn Antenna (18- 25GHz)	EMCO 3160-9	0004-1202	07/17/03	1 year
LISN	EMCO 3810/2NM	00022007	05/20/03	1 year
Power Meter	HP 437B	3043U03437	11/19/03	1 year
Power Sensor	HP 8481A	US41030582	11/19/03	1 year
Switch/control unit	HP 3488A	2719A17226 2719A17228	N/A N/A	N/A N/A
Plotter	HP 7550A	2631A33619	N/A	N/A
Coaxial cables (1 – 18GHz): - Horn Ant <=> RF Amp. - RF Amp.<=>Spectrum Analyzer	Length: 6 m 16m	- EM206SCO - GEM0101	03/27/03 03/27/03	1 year 1 year
Coaxial cables (18 – 25GHz): - Horn Ant <=> RF Amp. - RF Amp.<=>Spectrum Analyzer	3m 1m	- SF102-20167 - SF102-21105	03/27/03 03/27/03	1 year 1 year
N-Coax cables: - Bi-coni Ant <=> 10m Cable - 10m Cable <=> Shield Panel - Shield Panel <=> RF Amp	9 m 10 m 7 m	- EM103L01 - EM103L02 - EM103L03	04/14/03 04/14/03 04/14/03	1 year 1 year 1 year



- RF Amp <=> Power Splitter	0.5m	- EM103L04	04/14/03	1 year
- Log-peri Ant <=> 10m Cable	9 m	- EM103H01	04/14/03	1 year
- 10m Cable <=> Shield Panel	10 m	- EM103H02	04/14/03	1 year
- Shield Panel <=> RF Amp	7 m	- EM103H03	04/14/03	1 year
- RF Amp <=> Power Splitter	0.5m	- EM103H04	04/14/03	1 year
Coax cables:				
- Lisc-L <=> SW/Con.unit (SW100)	4 m	- EMIC-L	04/14/03	1 year
- Lisc-N <=> SW/Con.unit (SW101)	4 m	- EMIC-N	04/14/03	1 year
- SW/Con.unit <=> RCVR (Input)	1 m	- EMIC-R	04/14/03	1 year
- SW/Con.unit<=> Spe Ana.(Signal In)	1 m	- EMIC-S	04/14/03	1 year
- Power Splitter <=> SW/Con.unit (SW110)	1 m	- EM103L05	04/14/03	1 year
- Power Splitter <=> SW/Con.unit (SW300)	1 m	- EM103L06	04/14/03	1 year
- Power Splitter <=> SW/Con.unit (SW100)	1 m	- EM103H05	04/14/03	1 year
- Power Splitter <=> SW/Con.unit (SW301)	1 m	- EM103H06	04/14/03	1 year
- SW/Con.unit <=> Receiver (Input)	2 m	- EM1RCV	04/14/03	1 year
- SW/Con.unit <=> Spe Ana.(Signal In) for 30- 200MHz	2 m	- EM1SPL	04/14/03	1 year
- SW/Con.unit <=> Spe Ana.(Signal In) for 200-1000MHz	2 m	- EM1SPH	04/14/03	1 year

Notes.

- The above equipment calibration is traceable to National standards.
- HP: Hewlett Packard, R&S: Rohde & Schwarz

## F. Measurement Uncertainty

Uncertainties of the both, the Yamato EMI radiated test facilities (EMI chambers, #1 and #2) and the Yamato EMI conducted test facility are derived with the NIS 81 " Treatment of uncertainty in EMC measurements" 1994.

Estimated site uncertainty values are as follows.

- EMI chamber #1 : 4.39dB
- EMI chamber #2 : 4.40dB
- EMI conducted measurement system : 2.4dB

Detail should be referred to "Treatment of Uncertainty, Calculations and Policy" report, document number TCR 10-0015.

## G. Temperature and Humidity

The temperature is controlled within range of 17° to 28°.  
The relative humidity is controlled within range of 40% to 70% .

## H. Related Submittal(s)/Grant(s)/Notes

The host unit with full peripheral devices including the applying modular as an unintentional radiator is classified as a Digital Device under the FCC Part 15 Subpart B or the Industry Canada Class B Emission Compliance (ICES-003), and subject to DoC.

# 1. Bandwidth at 6 dB below

[ FCC 15.247(a)(2), RSS-210 6.2.2(o)(b) ]

## 1.1 Test Procedure

The bandwidth at 6 dB down from the highest inband spectral density was measured with a spectrum analyzer connected to the antenna terminal, while EUT was operating in transmission mode at the appropriate center frequency.

The spectrum analyzer was set to :

RBW=100kHz, VBW=100kHz\*1, Span=30MHz, Mode= Peak detector,

Sweep = suitable duration based on the EUT specification

\*1: To be adjusted accordingly based on the spectrum stability

## 1.2 Test Instruments and Measurement Setup

Table 1-1 : 6 dB Bandwidth Test Instruments

Description	Model	Serial Number
Spectrum Analyzer EMI Test Receiver	R&S ESI26	836119/003
Coax cables: - Spectrum Analyzer <=> EUT	Length : 110 cm Loss : 1.3 dB (for 2.4GHz)	

Notes: - R&S: Rohde & Schwarz

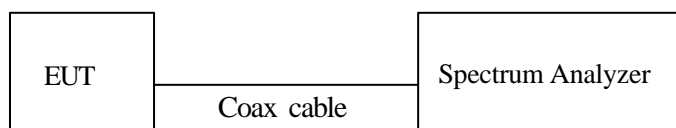

Figure 1: Measurement setup for 6dB bandwidth test

## 1.3 Measurement Results

Test Date: March 23, 2004

Table 1-2-1. 6dB bandwidth, TX mode 1Mbps

Center Frequency (MHz)	Trace number	Lower frequency (MHz)	Upper frequency (MHz)	Bandwidth at 6 dB below (MHz)	Limit (MHz)
2412 (ch. 1)	Plot 1-1	2406.98	2418.16	11.18	> 0.5
2437 (ch. 6)	Plot 1-2	2431.92	2443.16	11.24	
2462 (ch. 11)	Plot 1-3	2456.92	2468.16	11.24	

Table 1-2-2. 6dB bandwidth, TX mode 11Mbps

Center Frequency (MHz)	Trace number	Lower frequency (MHz)	Upper frequency (MHz)	Bandwidth at 6 dB below (MHz)	Limit (MHz)
2412 (ch. 1)	Plot 1-4	2407.82	2417.92	10.10	> 0.5
2437 (ch. 6)	Plot 1-5	2432.46	2442.92	10.46	
2462 (ch. 11)	Plot 1-6	2457.46	2467.56	10.10	

### 1.4 Trace Data of 6dB bandwidth

The plots are comparatively worse measurement cases in the previous [Table 1-2-1](#) and [Table 1-2-2](#).

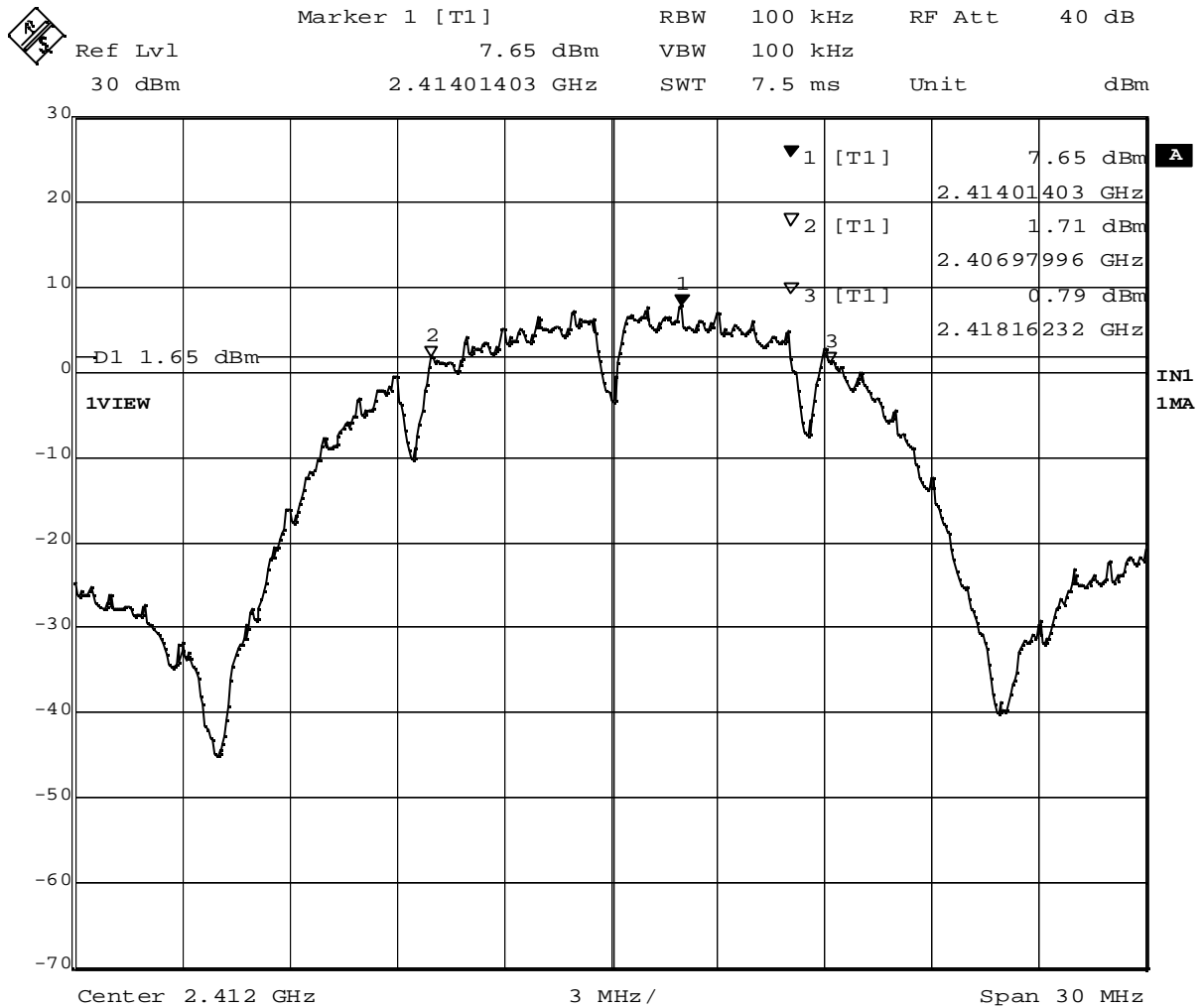

Date: 23.MAR.2004 21:53:42

Plot 1-1. 6dB BW at 2412MHz. (1Mbps)



Marker 1 [T1] RBW 100 kHz RF Att 40 dB  
 Ref Lvl 7.26 dBm VBW 100 kHz  
 30 dBm 2.43901403 GHz SWT 7.5 ms Unit dBm

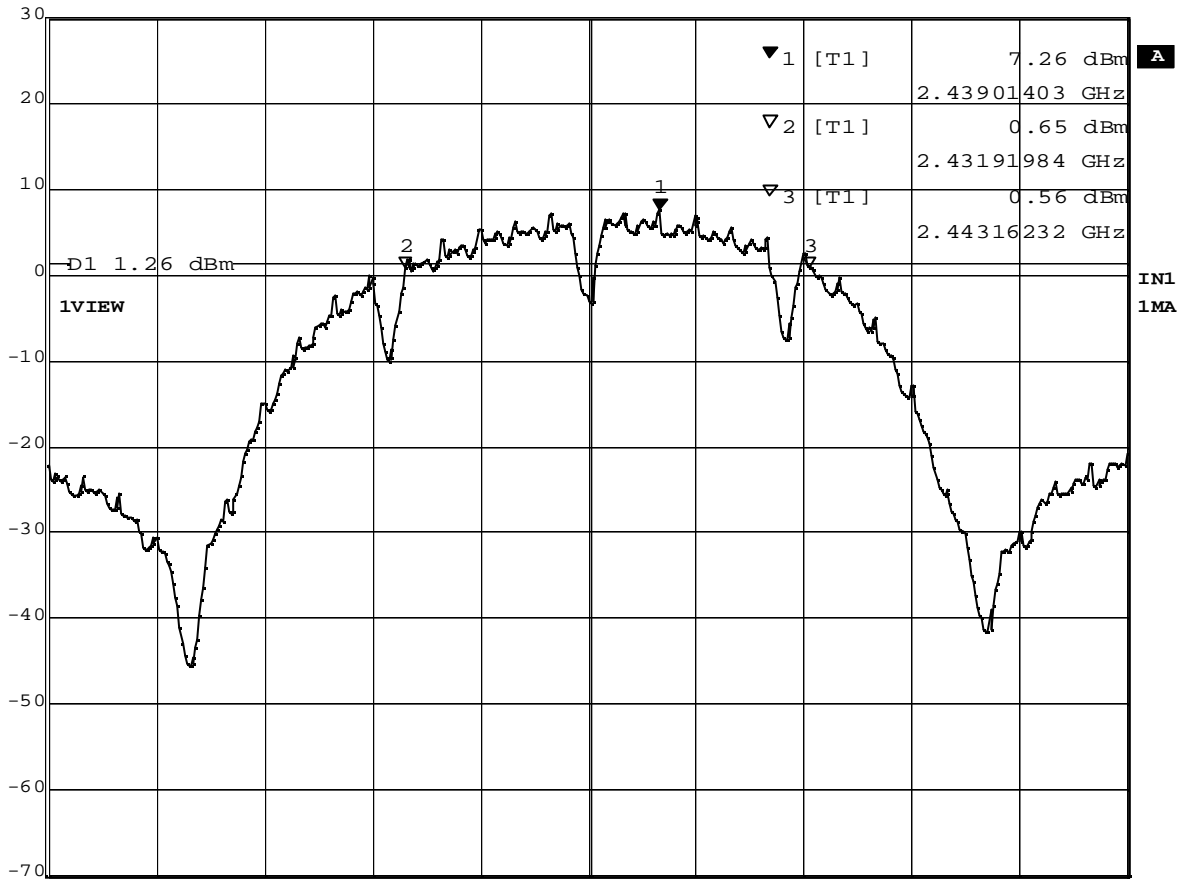

Center 2.437 GHz 3 MHz / Span 30 MHz

Date: 23.MAR.2004 21:57:06

Plot 1-2. 6dB BW at 2437MHz (1Mbps)

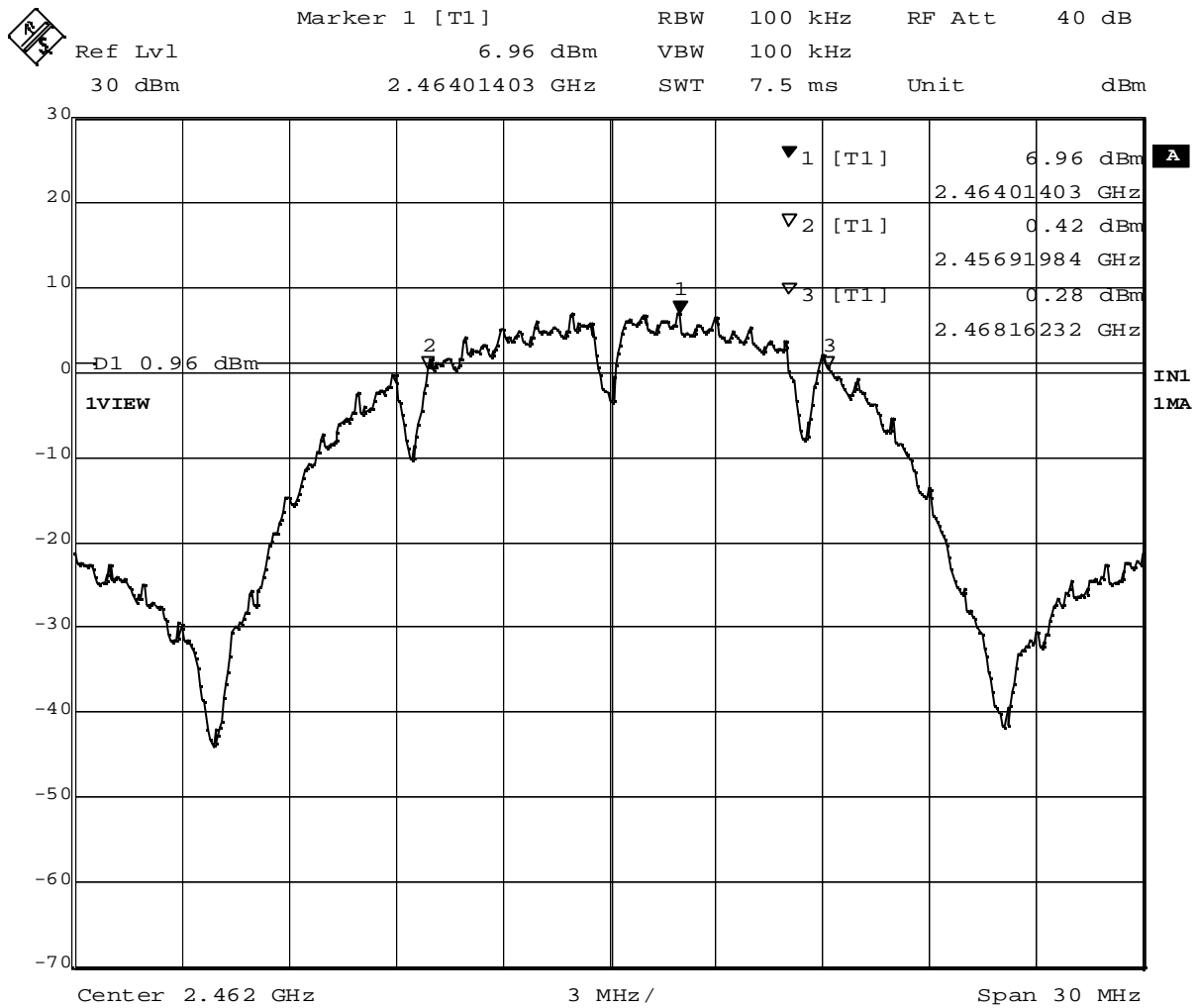

Date: 23.MAR.2004 22:01:00

Plot 1-3. 6dB BW at 2462MHz (1Mbps)



Marker 1 [T1] RBW 100 kHz RF Att 40 dB  
 Ref Lvl 7.94 dBm VBW 100 kHz  
 30 dBm 2.41395391 GHz SWT 7.5 ms Unit dBm

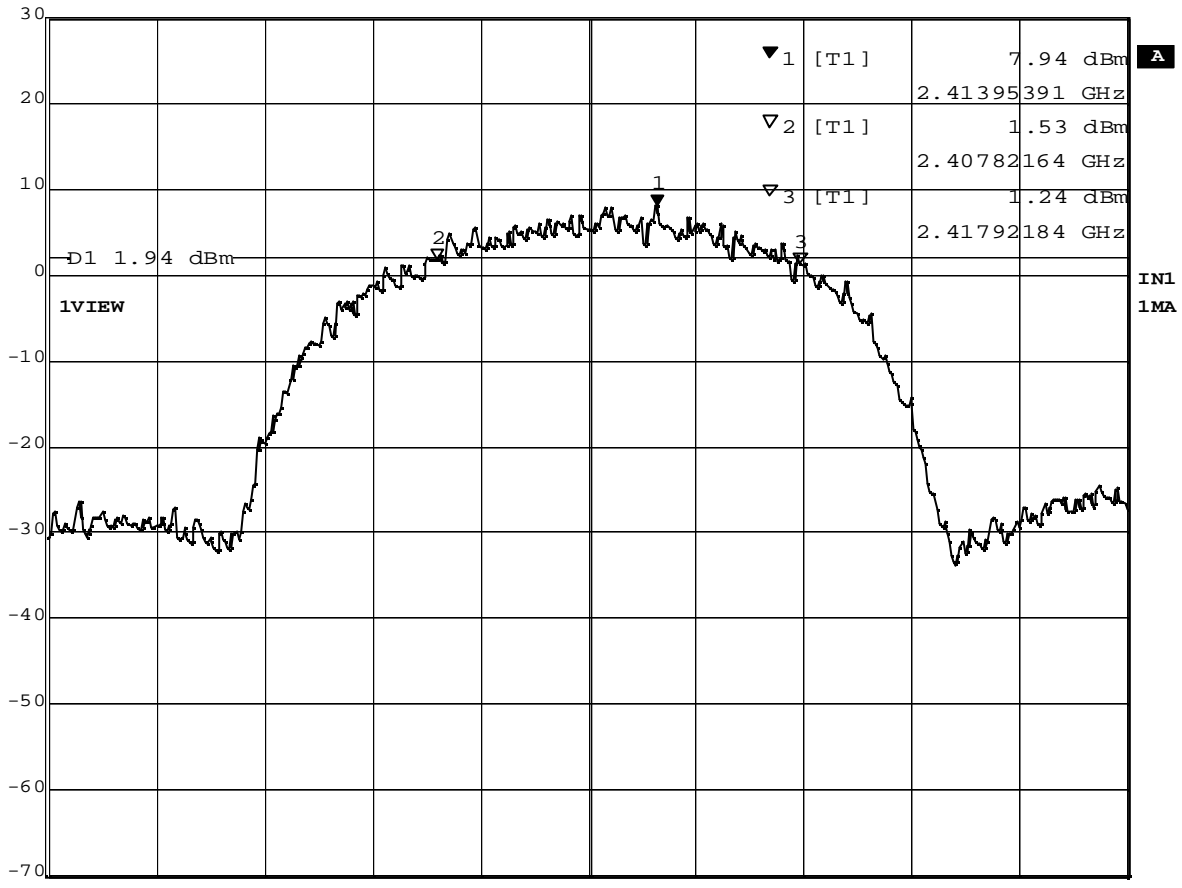

Center 2.412 GHz 3 MHz / Span 30 MHz

Date: 23.MAR.2004 17:52:16

Plot 1-4. 6dB BW at 2412MHz (11Mbps)



Marker 1 [T1] RBW 100 kHz RF Att 40 dB  
 Ref Lvl 8.31 dBm VBW 100 kHz  
 30 dBm 2.43889379 GHz SWT 7.5 ms Unit dBm

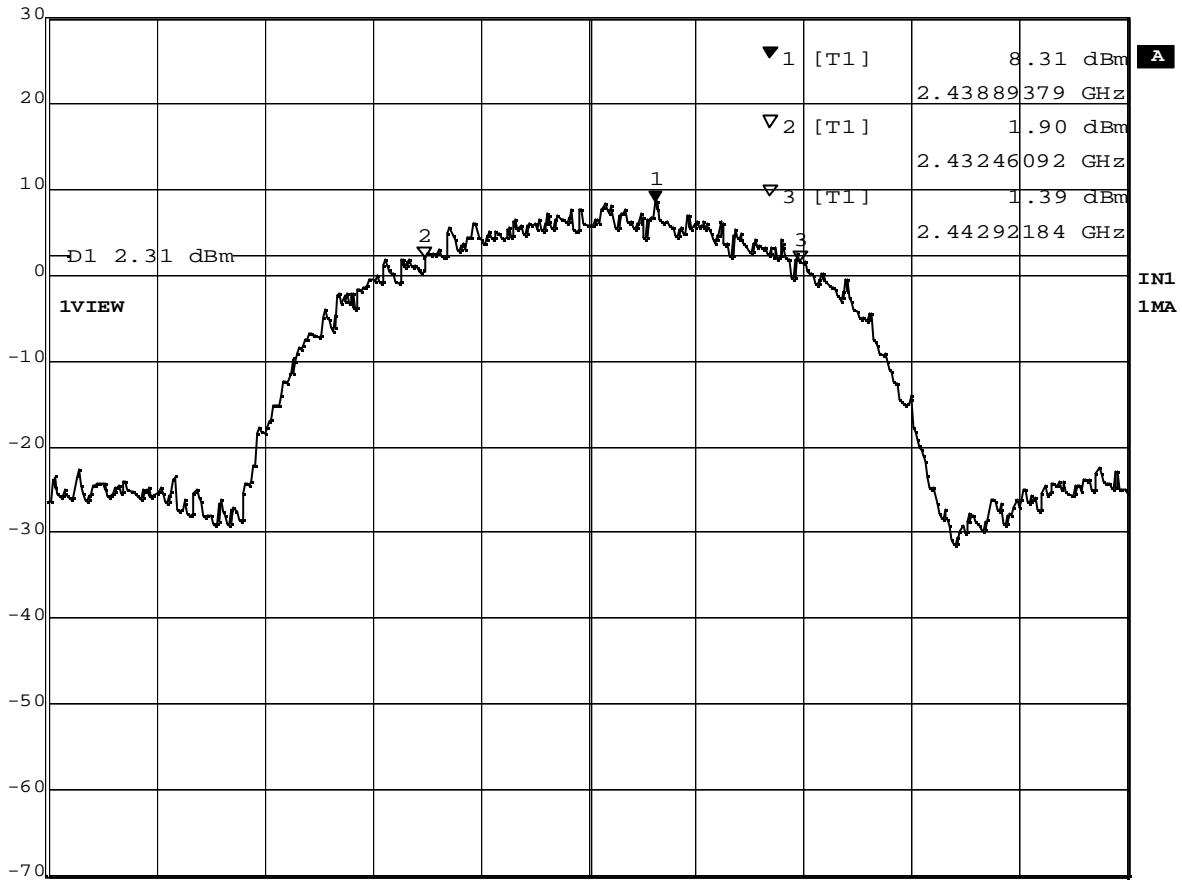

Center 2.437 GHz 3 MHz / Span 30 MHz

Date: 23.MAR.2004 21:55:34

Plot 1-5. 6dB BW at 2437MHz (11Mbps)

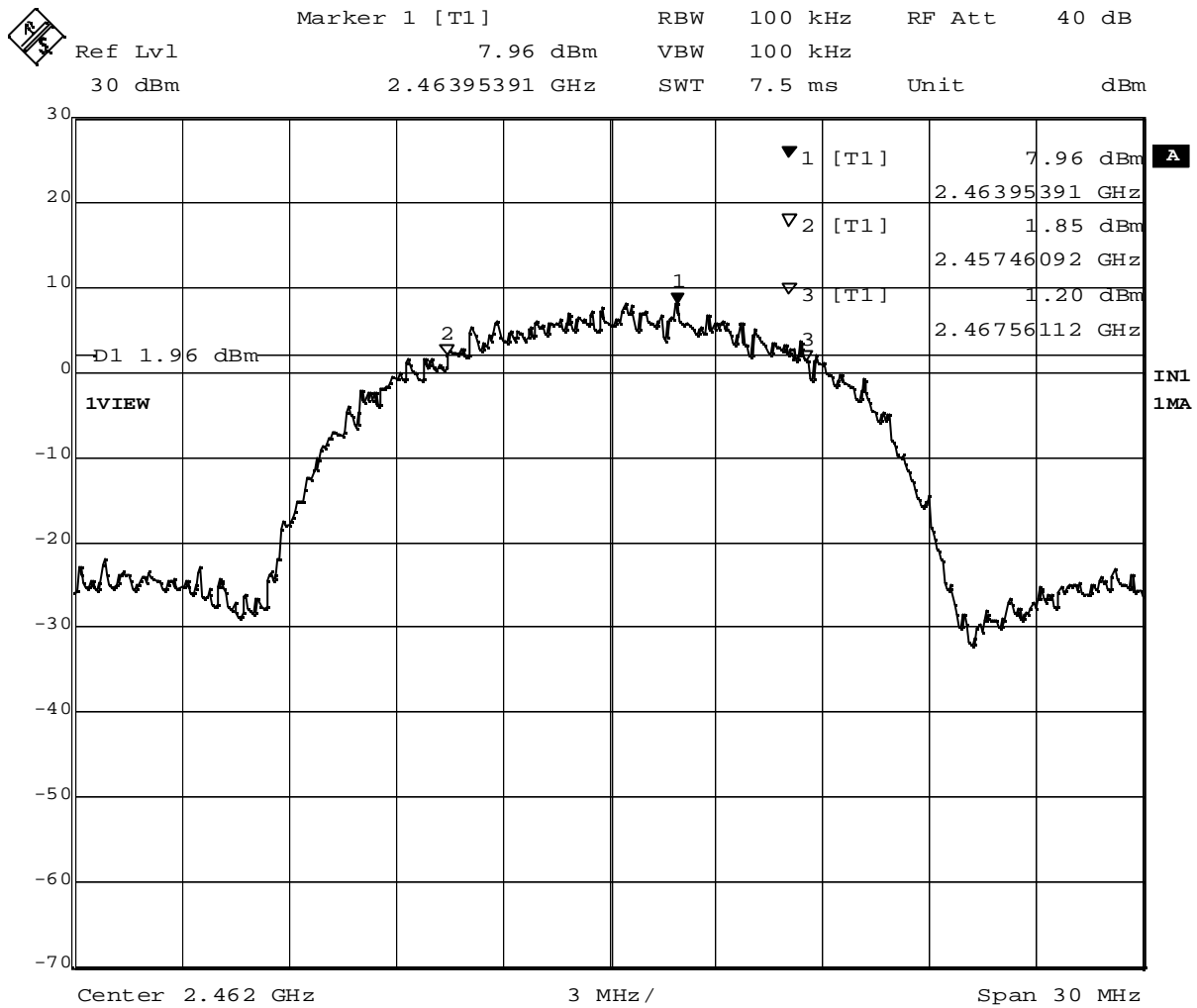

Plot 1-6. 6dB BW at 2462MHz (11Mbps)



## 2. Occupied Bandwidth (20 dB Bandwidth)

[ RSS-210 5.9.1 ]

### 2.1 Test Procedure

The bandwidth at 20 dB down from the highest inband spectral density was measured with a spectrum analyzer connected to the antenna terminal, while EUT was operating in transmission mode at the appropriate center frequency.

The spectrum analyzer was set to:

RBW=100kHz, VBW=100kHz\*1, Span=50MHz, Mode= Peak detector,

Sweep = suitable duration based on the EUT specification

\*1: To be adjusted accordingly based on the spectrum stability

### 2.2 Test Instruments and Measurement Setup

Same as the Chapter 1 (Table 1-1 & Figure 1).

### 2.3 Measurement Results

note) The transmission speed rate for the measurement was determined based on the results of previous 6 dB bandwidth measurement. The worse cases were selected representatively.

Test Date: March 23, 2004

Table 2-2-1. Occupied bandwidth, TX 11Mbps

Center Frequency (MHz)	Trace number	Lower frequency (MHz)	Upper frequency (MHz)	Bandwidth at 20 dB below (MHz)
2412 (ch. 1)	Plot 2-1	2403.65	2420.59	16.94
2437 (ch. 6)	Plot 2-2	2428.63	2445.54	16.91
2462 (ch. 11)	Plot 2-3	2453.63	2470.59	16.96

## 2.4 Trace Data of Occupied Bandwidth

The plots are comparatively worse measurement cases in the previous [Table 2-2-1](#).

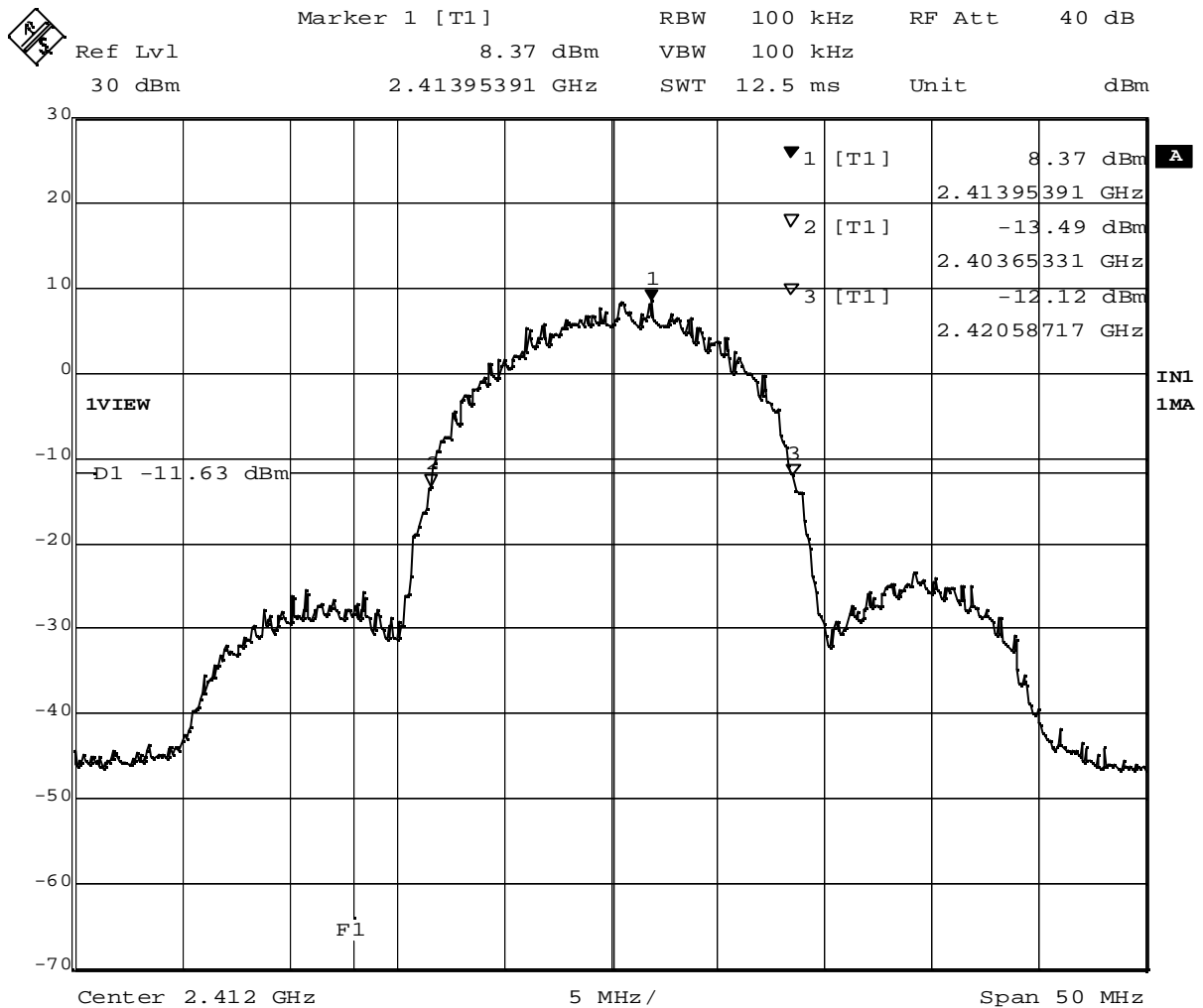

Date: 23.MAR.2004 22:18:48

Plot 2-1. 20dB BW at 2412MHz (11Mbps)



Marker 1 [T1]                      RBW    100 kHz            RF Att    40 dB  
 Ref Lvl                                    8.13 dBm            VBW    100 kHz  
 30 dBm                                    2.43895391 GHz      SWT    12.5 ms            Unit            dBm

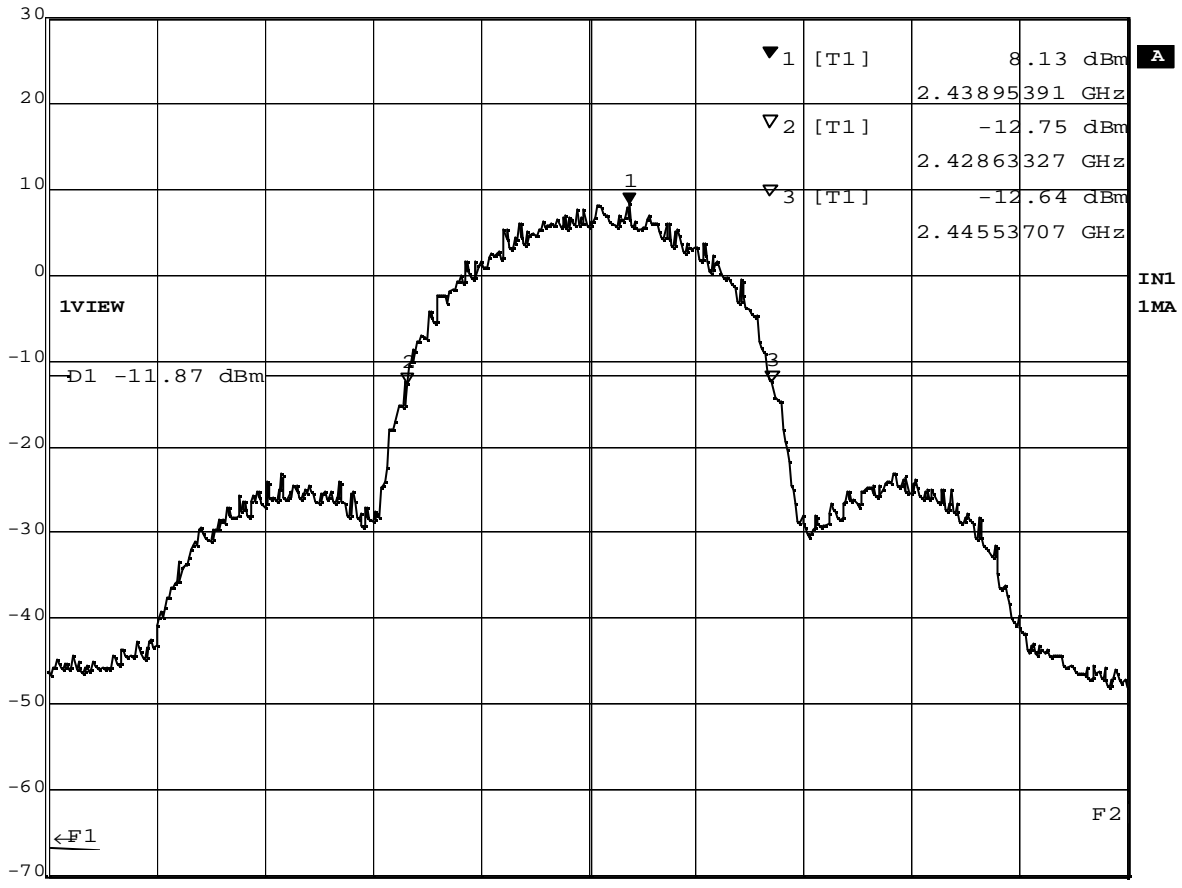

Center 2.437 GHz                      5 MHz /                      Span 50 MHz

Date: 23.MAR.2004 22:22:16

Plot 2-2. 20dB BW at 2437MHz (11Mbps)



Marker 1 [T1]                      RBW    100 kHz            RF Att    40 dB  
 Ref Lvl                                    7.87 dBm            VBW    100 kHz  
 30 dBm                                    2.46395391 GHz    SWT    12.5 ms            Unit            dBm

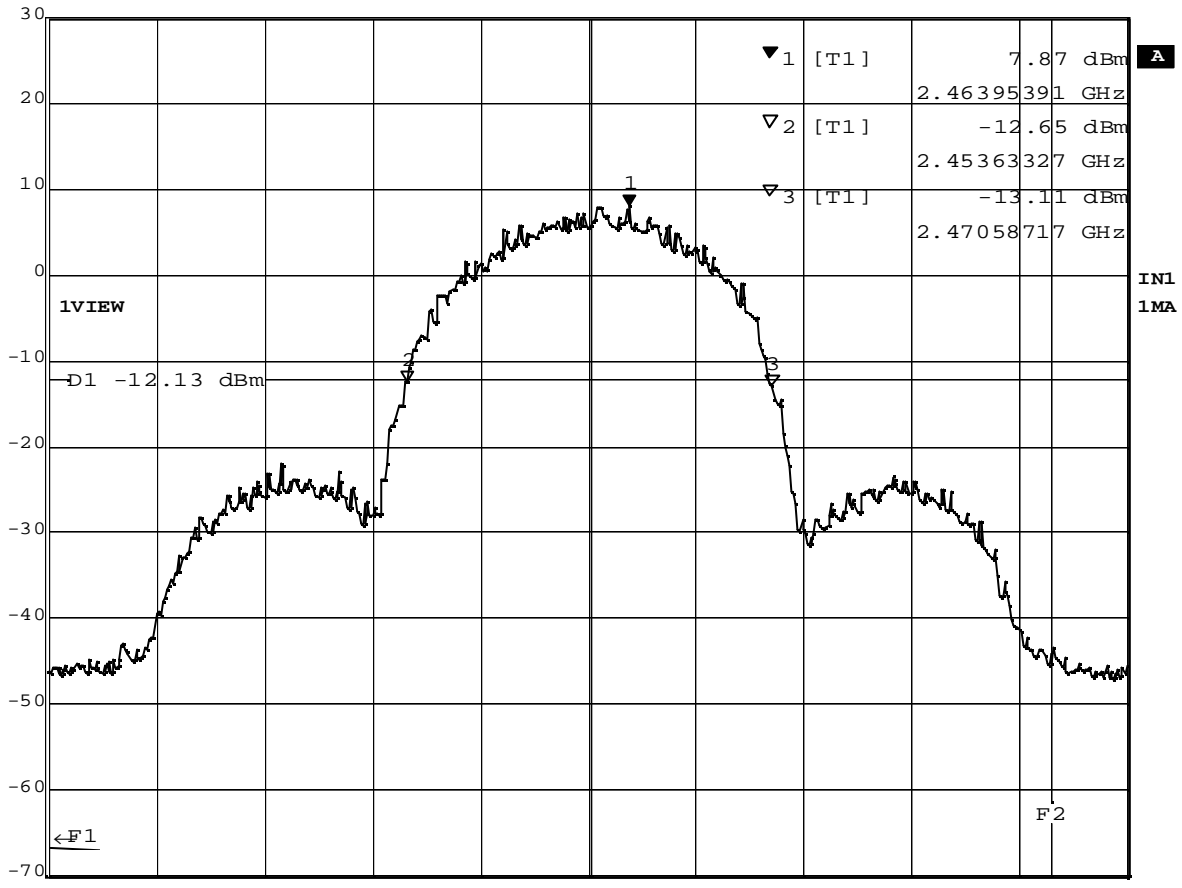

Center 2.462 GHz                      5 MHz /                      Span 50 MHz  
 Date:                      23.MAR.2004    22:25:00

Plot 2-3. 20dB BW at 2462MHz (11Mbps)

### 3. Conducted Peak Output Power [ FCC 15.247(b)(3), RSS-210 6.2.2(o)(b) ]

The test was performed with two kinds of measurement methods using power meter or spectrum analyzer.

#### 3.1 Test Procedure

##### 3.1.1 Power Meter measurement method

The test was performed for search of the highest power levels of each Tx mode.

- A transmitter antenna terminal of EUT was connected to the input of a RF power sensor.
- The measurement was performed while EUT was operating in continuous transmission mode at the appropriate center frequencies. i.e. the lowest, middle, and highest frequencies of each DSSS or OFDM mode.

Table 3-1 : Test Instruments of power meter method

Description	Model	Serial Number
Power Meter	HP 437B	3043U03437
Power Sensor	HP 8481A	US41030582
Coax cables: - Power Sensor <=> EUT	Length: 20 cm Loss: 0.7dB	

Notes: - HP: Hewlett Packard

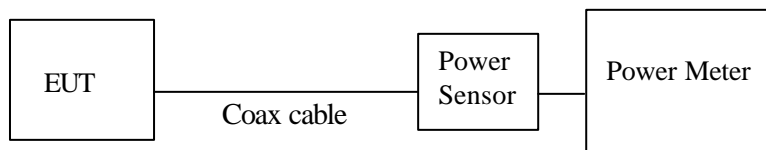

Figure 3-1: Measurement setup of power meter method

##### 3.1.2 Spectrum Analyzer measurement method

The spectrum analyzer was connected to the antenna terminal, while EUT was operating in continuous transmission mode (shown in the Chapter C) at the appropriate center frequencies.

The spectrum analyzer was set to :

VBW= 30kHz, RBW=1MHz,

Span=30-40MHz encompassing the entire 6 dB emission bandwidth of the transmission signal,

Mode= sample detector, Trigger= free run

The band power measurement function was used to measure the peak power of each transmission mode selected by the step 3.1.1. The analyzer computed the peak power by integrating the spectrum across the 6 dB emission bandwidth given by the previous chapter.

The test instruments and setup configuration are the same as the Table 1-1 and Figure 1.

### 3.2 Measurement Results

Test Date: March 23, 2004

Table 3-2-1. Power meter measurement results

Measured Frequency (MHz)	Bit rate (Mbps)	Power Meter Reading (dBm)	Cable Loss (dB)	Results (dBm)	Limit		Margin to limit (dB)
					FCC (dBm)	IC (dBm)	
2412	1 / 2	18.42	0.7	19.12 (81.7 mW)	30	30	10.88
2437		18.77	0.7	19.47 (88.5 mW)			10.53
2462		18.74	0.7	19.44 (87.9 mW)			10.56
2412	5 / 11	<b>18.64</b>	0.7	<b>19.34 (85.9 mW)</b>			10.66
2437		<b>19.09</b>	0.7	<b>19.79 (95.3 mW)</b>			10.21
2462		<b>19.03</b>	0.7	<b>19.73 (94.0 mW)</b>			10.27

Table 3-2-2. Spectrum analyzer measurement results

Measured Frequency (MHz)	Analyzer reading (dBm)	Trace number	Cable Loss (dB)	Results (dBm)	Limit		Margin to limit (dB)
					FCC (dBm)	IC (dBm)	
2412 (11Mbps)	18.07	Plot 3-1	1.3	19.37 ( 86.5mW )	30	30	10.63
2437 (11Mbps)	18.54	Plot 3-2	1.3	19.84 ( 96.4mW )			10.16
2462 (11Mbps)	18.47	Plot 3-3	1.3	19.77 ( 94.8mW )			10.23

### 3.3 Trace Data of Conducted Peak Output Power

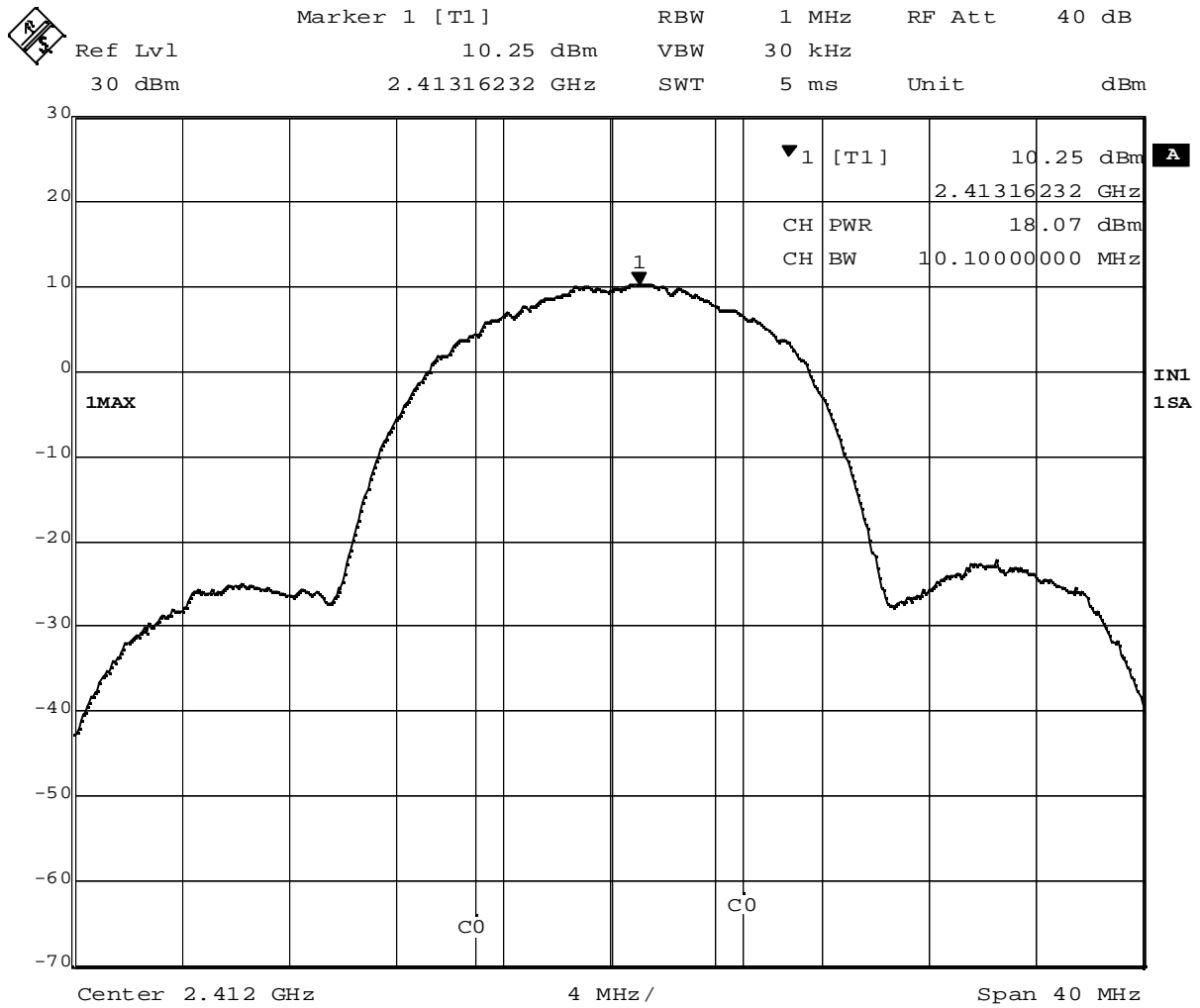

Date: 23.MAR.2004 22:40:55

Plot 3-1. Conducted Peak Output Power of 2412MHz (11Mbps)

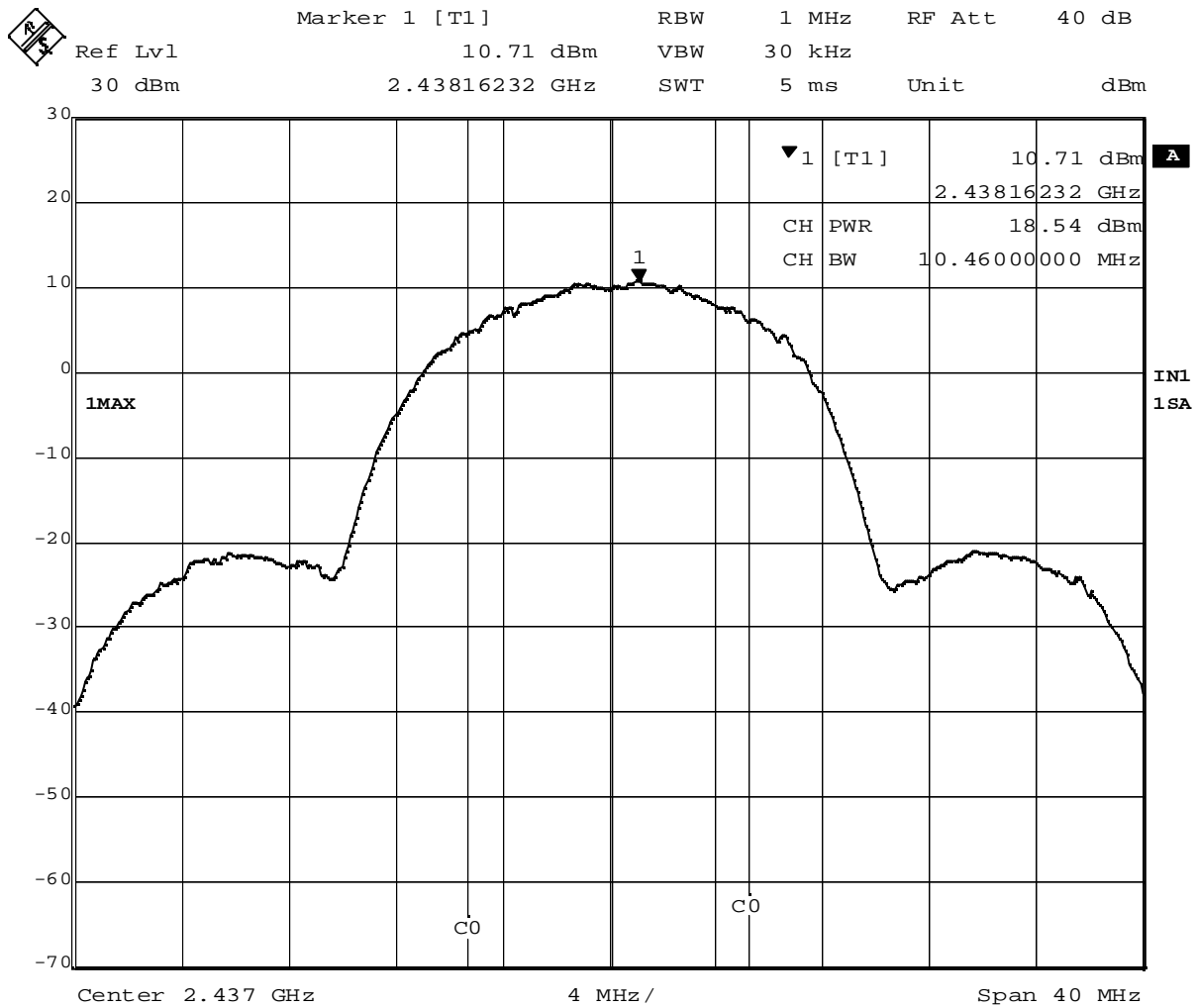

Date: 23.MAR.2004 22:37:24

Plot 3-2. Conducted Peak Output Power of 2437MHz (11Mbps)



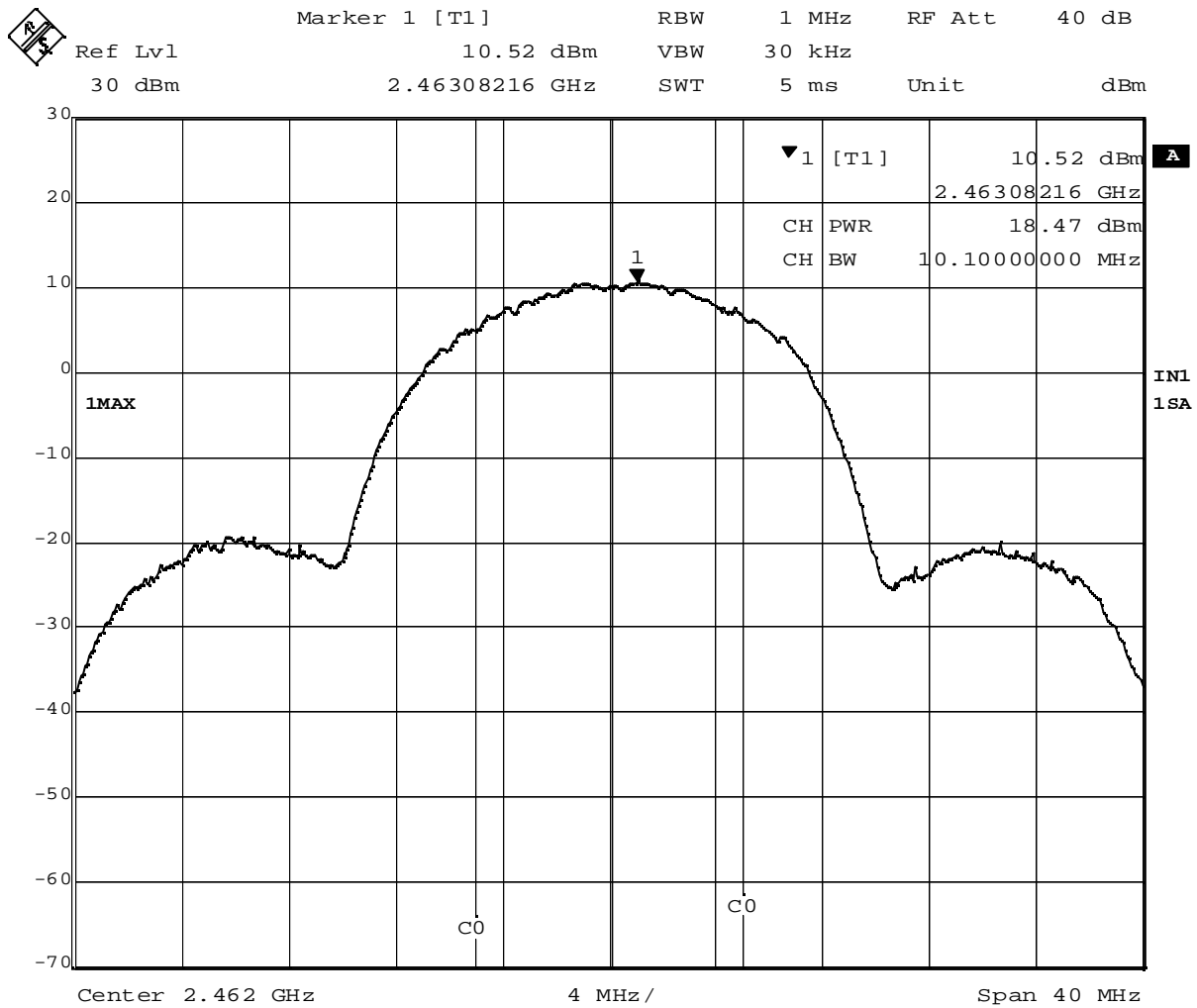

Plot 3-3. Conducted Peak Output Power of 2462MHz (11Mbps)

## 4. Out of Band Emissions (Conducted Spurious) [FCC 15.247(c), RSS-210 6.2.2(o)(e1)]

### 4.1 Test Procedure

The outband emissions in any 100kHz bandwidth was measured with a spectrum analyzer connected to the antenna terminal, while EUT was operating in transmission mode at the appropriate center frequency.

The spectrum analyzer was set to:

RBW = 100kHz, VBW = 100kHz\*1, Scanning frequency range = 30MHz~2GHz, 2GHz~3GHz, and 3GHz~25GHz, Mode= Peak detector, Sweep = suitable duration based on the EUT specification

\*1: To be adjusted accordingly based on the spectrum stability

### 4.2 Test Instruments and Measurement Setup

Same as the Chapter 1 (Table 1-1 & Figure 1).

### 4.3 Measurement Results

All conducted emission in any 100kHz bandwidth outside of the spread spectrum band was at least 20dB lower than the highest inband spectral density.

The measurement was performed with the worse cases of each transmission mode, that tend to have higher conducted peak power, based on the results of previous Chapter 3, “Conducted Peak Output Power” measurement.

Test Date: March 23, 2004: See the following plots.

Center Frequency (MHz)		Trace number *1
2412 (ch. 1)	11Mbps	Plot 4-1
2437 (ch. 6)		Plot 4-2
2462 (ch. 11)		Plot 4-3

\*1 : Each submittal plot includes the highest conducted spurious in the 10<sup>th</sup> harmonics frequency range of each measured Tx mode.

### 4.4 Trace Data of Out of Band Emissions

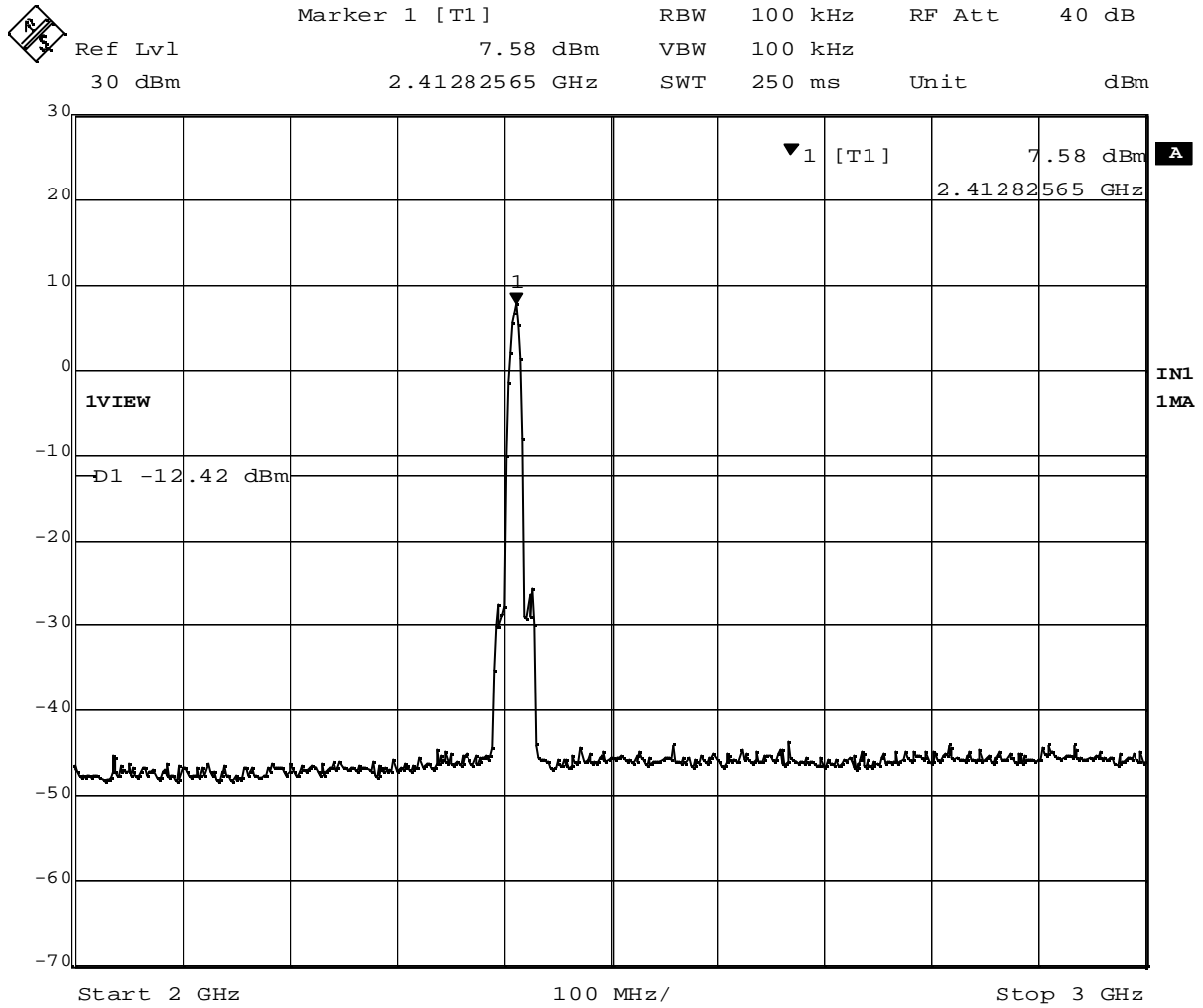

Date: 23.MAR.2004 22:43:57

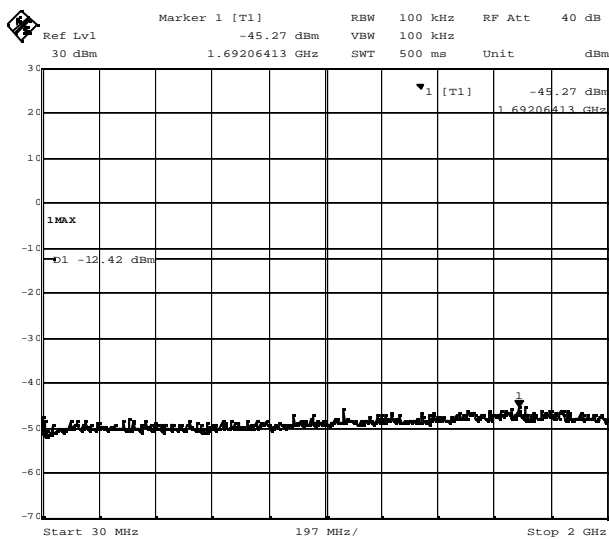

Date: 23.MAR.2004 22:44:49

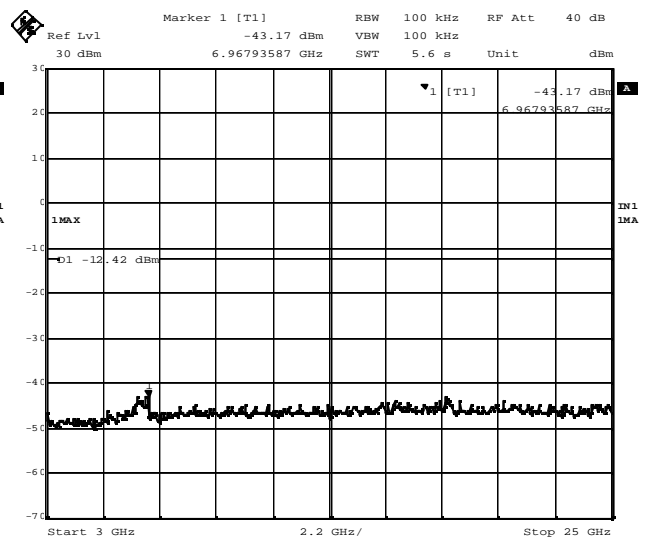

Date: 23.MAR.2004 22:45:27

Plot 4-1. Out of band emissions around 2412MHz (11Mbps)

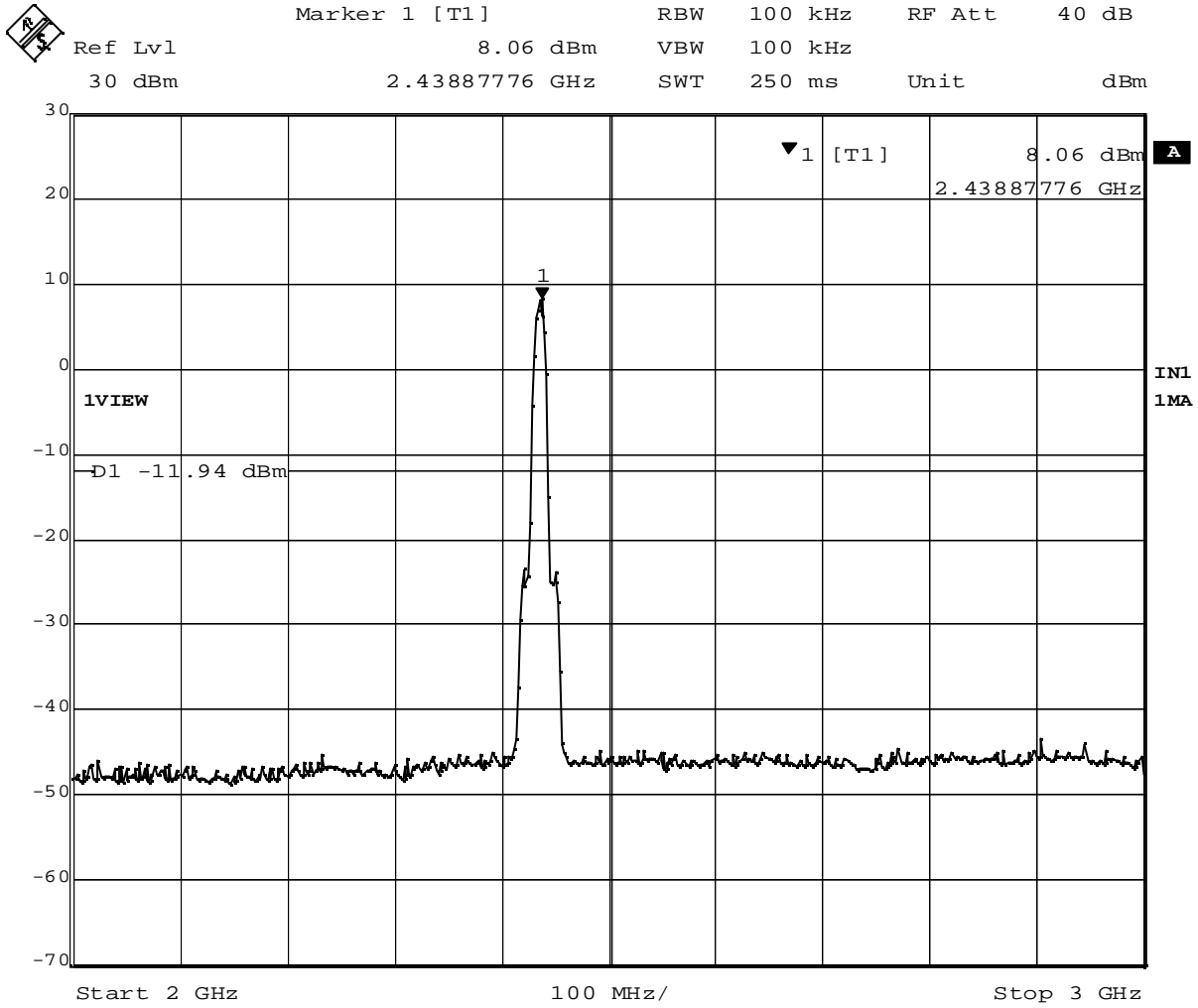

Date: 23.MAR.2004 22:46:43

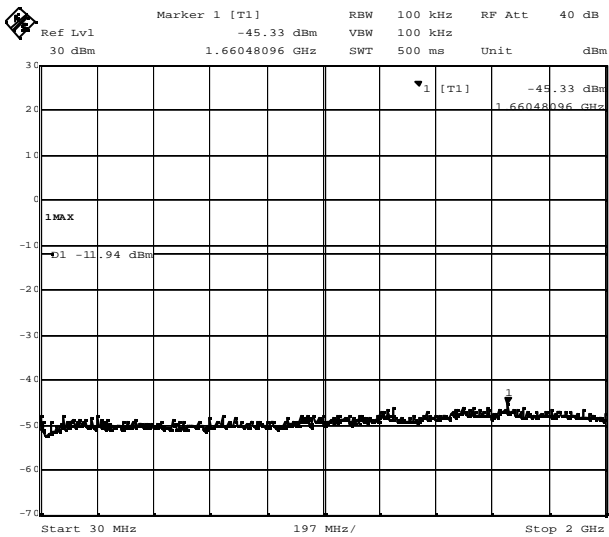

Date: 23.MAR.2004 22:47:29

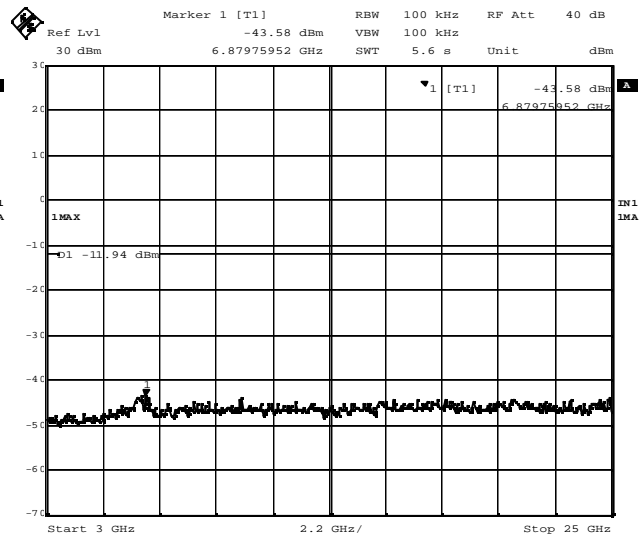

Date: 23.MAR.2004 22:48:06

Plot 4-2. Out of band emissions around 2437MHz (11Mbps)



Marker 1 [T1] RBW 100 kHz RF Att 40 dB  
 Ref Lvl 7.90 dBm VBW 100 kHz  
 30 dBm 2.46292585 GHz SWT 250 ms Unit dBm

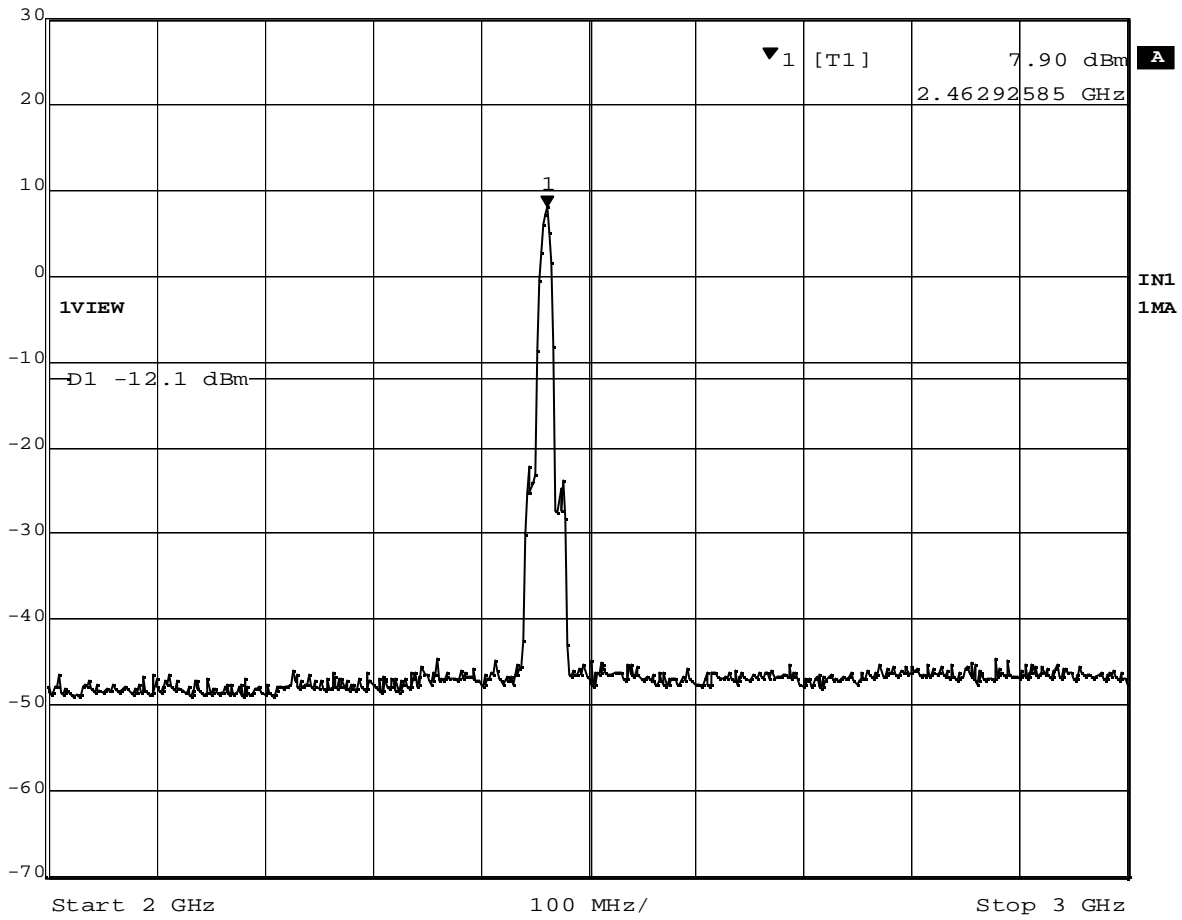

Date: 23.MAR.2004 22:48:58



Marker 1 [T1] RBW 100 kHz RF Att 40 dB  
 Ref Lvl -44.83 dBm VBW 100 kHz  
 30 dBm 1.65653307 GHz SWT 500 ms Unit dBm

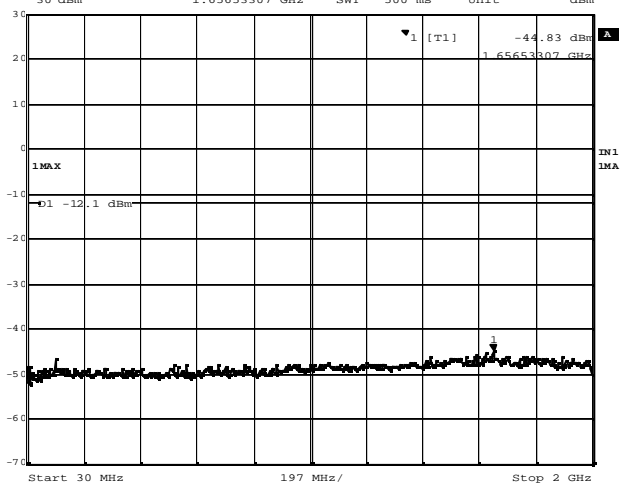

Date: 23.MAR.2004 22:49:42



Marker 1 [T1] RBW 100 kHz RF Att 40 dB  
 Ref Lvl -43.15 dBm VBW 100 kHz  
 30 dBm 6.92384770 GHz SWT 5.6 s Unit dBm

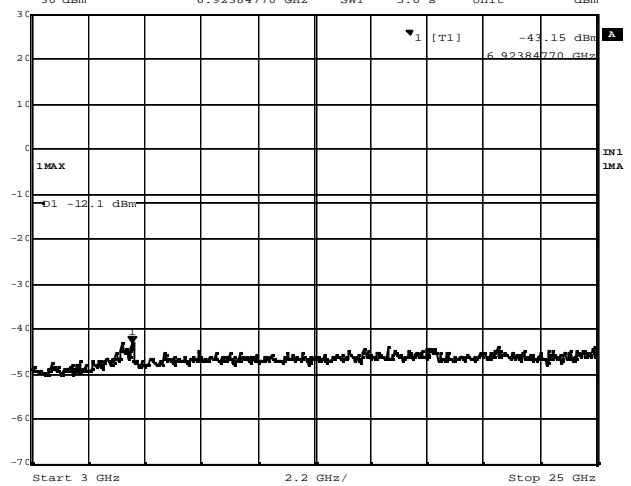

Date: 23.MAR.2004 22:50:19

Plot 4-3. Out of band emissions around 2462MHz (11Mbps)

## 5. Peak Power Spectral Density

[FCC 15.247(d), RSS-210 6.2.2(o)(b)]

### 5.1 Test Procedure

The power spectral density was measured with a spectrum analyzer connected to the antenna terminal, while EUT was operating in transmission mode at the appropriate center frequency.

The pre-scanning was performed with the spectrum analyzer to search and locate the center frequency at the peak emission of each transmission mode.

Then, the spectral analyzer was set to the emission peak found in the pre-scan and the peak power spectral density was measured with:

RBW = 3 kHz, VBW = 3 kHz, Span = 300 KHz, Mode= Peak detector, Sweep = 100 seconds

### 5.2 Test Instruments and Measurement Setup

Same as the Chapter 1 (Table 1-1 & Figure 1).

### 5.3 Measurement Results

The measurement was performed with the worse cases of each transmission mode, that tend to have higher conducted peak power, based on the results of previous Chapter 3, “Conducted Peak Output Power” measurement.

Test Date: March 23, 2004

Table 5-1. Peak Power Spectrum Density, TX mode

		Ch No.	Frequency (MHz)	Analyzer Reading (dBm)	Trace number	Cable loss (dB)	Result (dBm)	Limit (dBm)	Margin (dB)
DSSS	2.4GHz 11Mbps	1	2413.41	-5.35	Plot 5-1	1.3	- 4.1	8.0	12.1
		6	2438.41	-4.88	Plot 5-2	1.3	- 3.6	8.0	11.6
		11	2463.41	-5.03	Plot 5-3	1.3	- 3.7	8.0	11.7

## 5.4 Trace Data of Peak Power Spectral Density

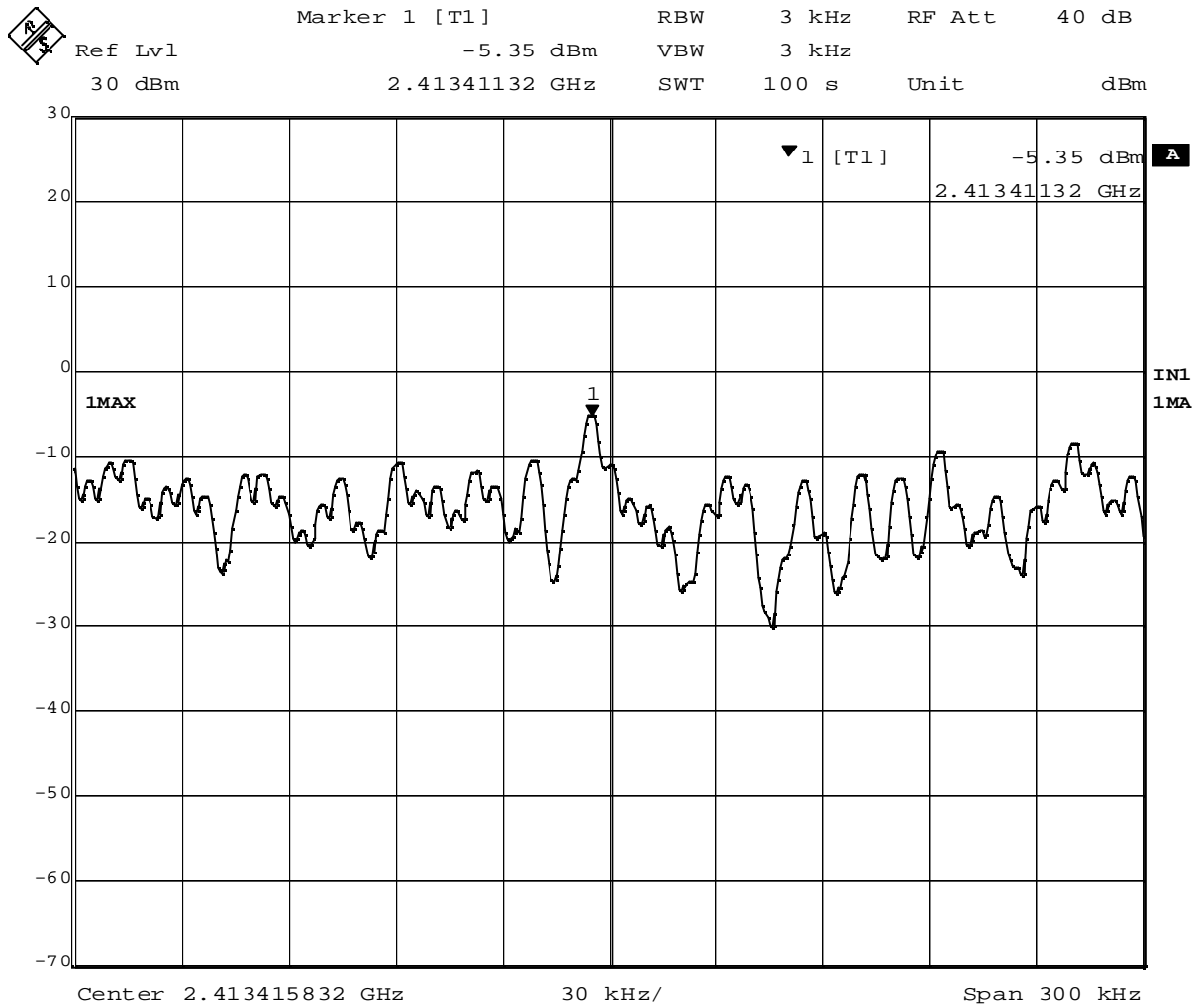

Date: 23.MAR.2004 23:01:18

Plot 5-1. Peak Power Spectral Density of 2412MHz (11Mbps)



Marker 1 [T1] RBW 3 kHz RF Att 40 dB  
Ref Lvl -4.88 dBm VBW 3 kHz  
30 dBm 2.43841072 GHz SWT 100 s Unit dBm

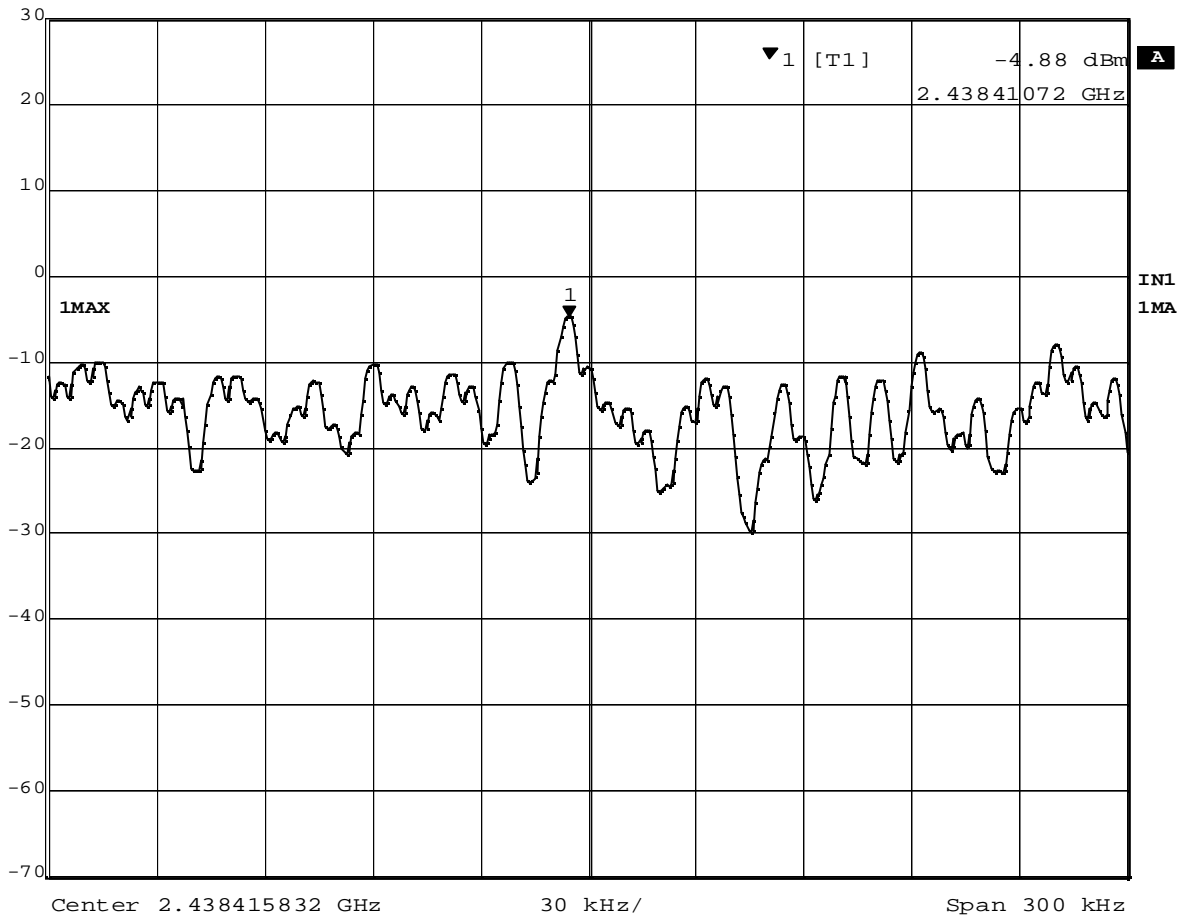

Date: 23.MAR.2004 23:04:54

Plot 5-2. Peak Power Spectral Density of 2437MHz (11Mbps)





Marker 1 [T1] RBW 3 kHz RF Att 40 dB  
Ref Lvl -5.03 dBm VBW 3 kHz  
30 dBm 2.46341072 GHz SWT 100 s Unit dBm

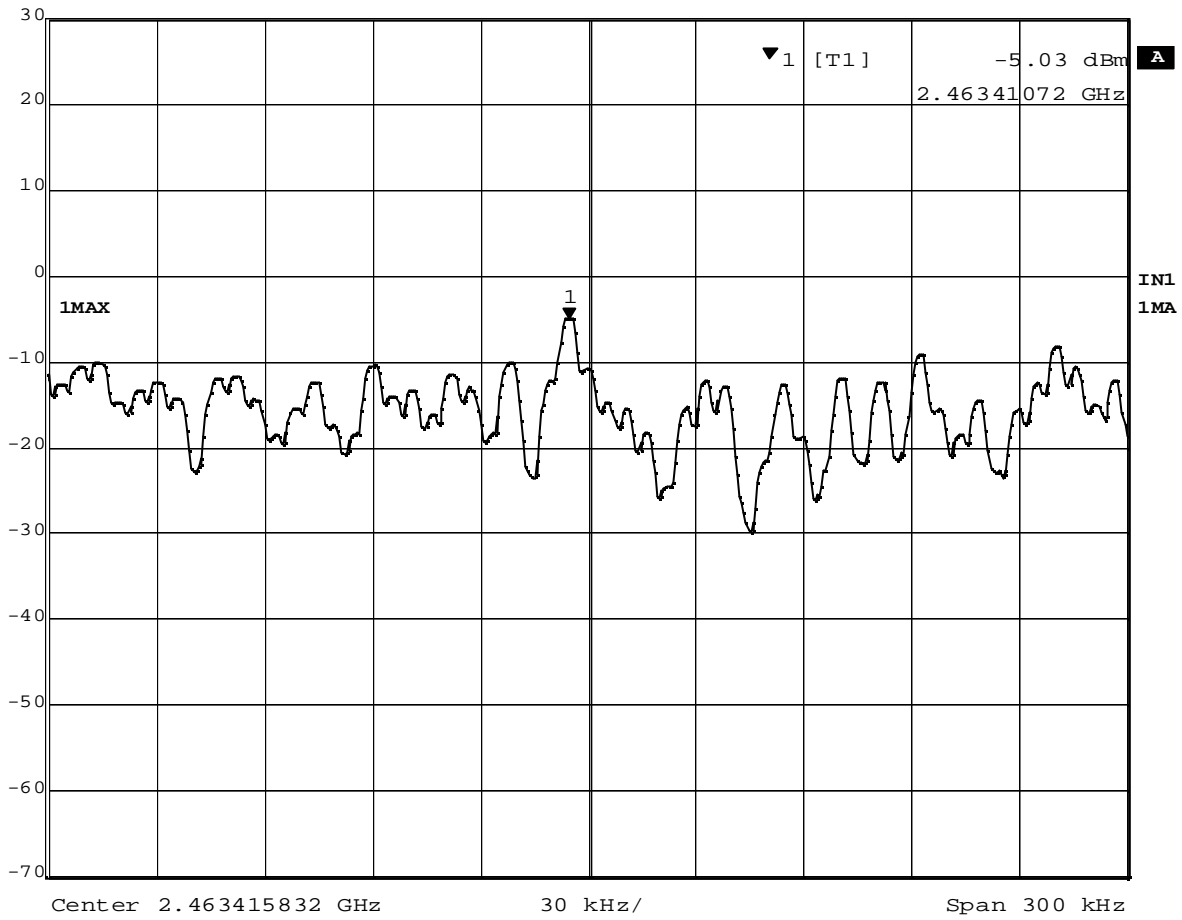

Date: 23.MAR.2004 23:08:14

Plot 5-3. Peak Power Spectral Density of 2462MHz (11Mbps)

## 6. AC WIRELINE CONDUCTED EMISSIONS (150KHz – 30MHz) [ FCC 15.207, RSS-210 6.6 / 7.4 ]

### 6.1 Test Procedure

The conducted emissions are measured in the IBM shielded room with a spectrum analyzer in peak hold. Emissions closest to the limit are measured in the quasi-peak mode (QP) with the tuned receiver using a bandwidth of 9KHz. The emissions are maximized further by cable manipulation. The highest emissions relative to the limit are listed.

### 6.2 Test Instruments and Measurement Setup

Table 6-1. Conducted Emission Test Instrumentation

Description	Model	Serial Number
Computer	IBM 6589-13J	97-15613
Spectrum Analyzer (100Hz-1.5GHz)	HP 85680B	2841A04254
Spectrum Analyzer Display	HP 85662A	2816A16831
Quasi-Peak Adapter	HP 85650A	2811A01156
Receiver (9kHz-30MHz)	R&S ESH3	891806/012
LISN	EMCO 3810/2NM	00022007
Switch/control unit	HP 3488A	2719A17228
Plotter	HP 7550A	2631A33619
Coax cables: - Lisen-L <=> SW/Con.unit (SW100) - Lisen-N <=> SW/Con.unit (SW101) - SW/Con.unit <=> RCVR (Input) - SW/Con.unit<=> Spe Ana.(Signal In)	Length: 4 m 4 m 1 m 1 m	- EMIC-L - EMIC-N - EMIC-R - EMIC-S

Notes: - HP: Hewlett Packard, R&S: Rohde & Schwarz

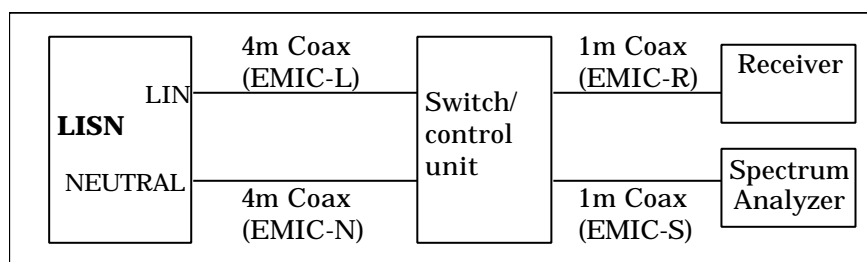

Figure 6. Cables for Conducted Emission Test

### 6.3 Powerline Voltage Calculation

The powerline voltage is calculated by adding insertion losses of LISN, Cable, Switch control unit and Pulse limiter to the measured reading. All factors are included in the reported data.

$$PV = R + CORR$$

where:

$$\begin{aligned} PV &= \text{Powerline Voltage (dB}\mu\text{V)} \\ R &= \text{Measured Receiver Input Amplitude (dB}\mu\text{V)} \\ CORR &= \text{Correction Factor (dB) = LL+CL+SWL+PLL} \\ LL &= \text{Insertion loss of LISN (dB)} \\ CL &= \text{Insertion loss of Cable (dB)} \\ SWL &= \text{Insertion loss of Switch control unit (dB)} \\ PLL &= \text{Insertion loss of Pulse Limiter (dB)} \end{aligned}$$

Given a Receiver input reading of 50.0 dB $\mu$ V, LISN loss of 0.6 dB, Cable loss of 0.1dB, Switch control unit loss of 0.1dB and Pulse limiter loss of 0.2dB. The Powerline Voltage of the measured emission is:

$$\begin{aligned} CORR &= 0.6 + 0.1 + 0.1 + 0.2 = 1.0 \text{ (dB)} \\ PV &= 50.0 + 1.0 = 51.0 \text{ (dB}\mu\text{V)} \end{aligned}$$

## 6.4 Measurement Results

The EUT was found to comply to the limits of FCC Part 15 Subpart C and RSS-210 with a margin of 11.6dB. The 6 highest emissions relative to the limits are reported.

Test Date: March 25, 2004

Table 6-2-1. Ch.1 (2412MHz) TX mode 11Mbps

Frequency (MHz)	QP			AV			CISPR22 QP Limit (dBµV)	CISPR22 AV Limit (dBµV)	Phase
	Measured Reading (dBµV)	Corr. Factor (dB)	Powerline Voltage (dBµV)	Measured Reading (dBµV)	Corr. Factor (dB)	Powerline Voltage (dBµV)			
0.2054	48.3	0.5	48.8	39.3	0.5	39.8	63.4	53.4	Line
0.2766	40.8	0.6	41.4	32.7	0.6	33.3	60.9	50.9	Line
0.3438	38.9	0.6	39.5	31.9	0.6	32.5	59.1	49.1	Line
0.4829	32.5	0.6	33.1	28.6	0.6	29.2	56.3	46.3	Line
0.5507	35.2	0.6	35.8	31.7	0.6	32.3	56.0	46.0	Line
0.6876	30.6	0.6	31.2	28.8	0.6	29.4	56.0	46.0	Line

Table 6-2-2. Ch.6 (2437MHz) TX mode 11Mbps

Frequency (MHz)	QP			AV			CISPR22 QP Limit (dBµV)	CISPR22 AV Limit (dBµV)	Phase
	Measured Reading (dBµV)	Corr. Factor (dB)	Powerline Voltage (dBµV)	Measured Reading (dBµV)	Corr. Factor (dB)	Powerline Voltage (dBµV)			
0.2052	46.5	0.5	47.0	37.6	0.5	38.1	63.4	53.4	Line
0.3425	39.2	0.6	39.8	33.8	0.6	34.4	59.1	49.1	Line
0.4795	33.4	0.6	34.0	31.0	0.6	31.6	56.3	46.3	Line
0.5510	35.8	0.6	36.4	33.0	0.6	33.6	56.0	46.0	Line
0.6876	31.4	0.6	32.0	29.8	0.6	30.4	56.0	46.0	Line
0.7597	29.5	0.6	30.1	26.9	0.6	27.5	56.0	46.0	Line

Table 6-2-3. Ch.11 (2462MHz) TX mode 11Mbps

Frequency (MHz)	QP			AV			CISPR22 QP Limit (dBµV)	CISPR22 AV Limit (dBµV)	Phase
	Measured Reading (dBµV)	Corr. Factor (dB)	Powerline Voltage (dBµV)	Measured Reading (dBµV)	Corr. Factor (dB)	Powerline Voltage (dBµV)			
0.2081	45.1	0.5	45.6	36.5	0.5	37.0	63.3	53.3	Line
0.3459	39.1	0.6	39.7	34.3	0.6	34.9	59.1	49.1	Line
0.4120	34.3	0.6	34.9	28.9	0.6	29.5	57.6	47.6	Neutral
0.4798	33.9	0.6	34.5	31.8	0.6	32.4	56.3	46.3	Line
0.5523	35.9	0.6	36.5	33.2	0.6	33.8	56.0	46.0	Line
0.6902	30.9	0.6	31.5	29.2	0.6	29.8	56.0	46.0	Line

Table 6-2-4. Ch. 6 (2437MHz) **RX** mode

Frequency (MHz)	QP			AV			CISPR22 QP Limit (dBµV)	CISPR22 AV Limit (dBµV)	Phase
	Measured Reading (dBµV)	Corr. Factor (dB)	Powerline Voltage (dBµV)	Measured Reading (dBµV)	Corr. Factor (dB)	Powerline Voltage (dBµV)			
0.2081	45.2	0.5	45.7	36.6	0.5	37.1	63.3	53.3	Line
0.3459	39.5	0.6	40.1	36.0	0.6	36.6	59.1	49.1	Line
0.4132	34.4	0.6	35.0	28.2	0.6	28.8	57.6	47.6	Neutral
0.4807	36.4	0.6	37.0	34.1	0.6	34.7	56.3	46.3	Line
0.5523	33.9	0.6	34.5	31.2	0.6	31.8	56.0	46.0	Line
0.7584	29.5	0.6	30.1	27.2	0.6	27.8	56.0	46.0	Line

## 7. RESTRICTED BANDS RADIATIONS (30MHz – 1GHz)

[ FCC 15.205 / 209, RSS-210 6.3 / 7.3]

### 7.1 Test Procedure

Preliminary radiated emissions are measured in the semi-anechoic chamber at a 3 meter distance on every azimuth in both horizontal and vertical polarity. The antennas are also scanned in height. The emissions are recorded with a spectrum analyzer in peak hold mode. The identified emissions are further maximized by a cable manipulation. Emissions closest to the limits are measured in the quasi-peak mode with the tuned receiver using a bandwidth of 120kHz. The highest emissions relative to the limit are listed.

### 7.2 Test Instruments and Measurement Setup

Table 7-1 Radiated Emission Test Instrumentation

Description	Model	Serial Number
Computer	IBM 6868-30J	97-901X3
Spectrum Analyzer (100Hz-1.5GHz) for 30-200MHz	HP 85680B	2601A02634
Spectrum Analyzer Display for 30-200MHz	HP 85662A	2542A12308
Quasi-Peak Adapter for 30-200MHz	HP 85650A	2043A00062
Spectrum Analyzer (100Hz-1.5GHz) for 200-1000MHz	HP 85680B	3019A05156
Spectrum Analyzer Display for 200-1000MHz	HP 85662A	3026A19366
Quasi-Peak Adapter for 200-1000MHz	HP 85650A	2811A01433
Amplifier (100KHz-1.3GHz)		
- for 30-200MHz	HP 8447F	2805A02919
- for 200-1000MHz	MITEQ AM-3A	898432
Biconical Antenna (30-200MHz)	EMCO 3108	2536
Log-Periodic Antenna (200-1000MHz)	EMCO 3146	2849
Receiver (20MHz-1.3GHz)	R&S ESVP	893202/018
Switch/control unit	HP 3488A	2719A17226
N-Coax cables:	Length:	
- Bi-coni Ant <=> 10m Cable	9 m	- EM103L01
- 10m Cable <=> Shield Panel	10 m	- EM103L02
- Shield Panel <=> RF Amp	7 m	- EM103L03
- RF Amp <=> Power Splitter	0.5m	- EM103L04
- Log-peri Ant <=> 10m Cable	9 m	- EM103H01
- 10m Cable <=> Shield Panel	10 m	- EM103H02
- Shield Panel <=> RF Amp	7 m	- EM103H03
- RF Amp <=> Power Splitter	0.5m	- EM103H04
Coax cables:		
- Power Splitter <=> SW/Con.unit (SW110)	1 m	- EM103L05
- Power Splitter <=> SW/Con.unit (SW300)	1 m	- EM103L06
- Power Splitter <=> SW/Con.unit (SW100)	1 m	- EM103H05
- Power Splitter <=> SW/Con.unit (SW301)	1 m	- EM103H06
- SW/Con.unit <=> Receiver (Input)	2 m	- EM1RCV
- SW/Con.unit <=> Spe Ana.(Signal In) for 30- 200MHz	2 m	- EM1SPL
- SW/Con.unit <=> Spe Ana.(Signal In) for 200-1000MHz	2 m	- EM1SPH

Notes:

- HP: Hewlett Packard, R&S: Rohde & Schwarz

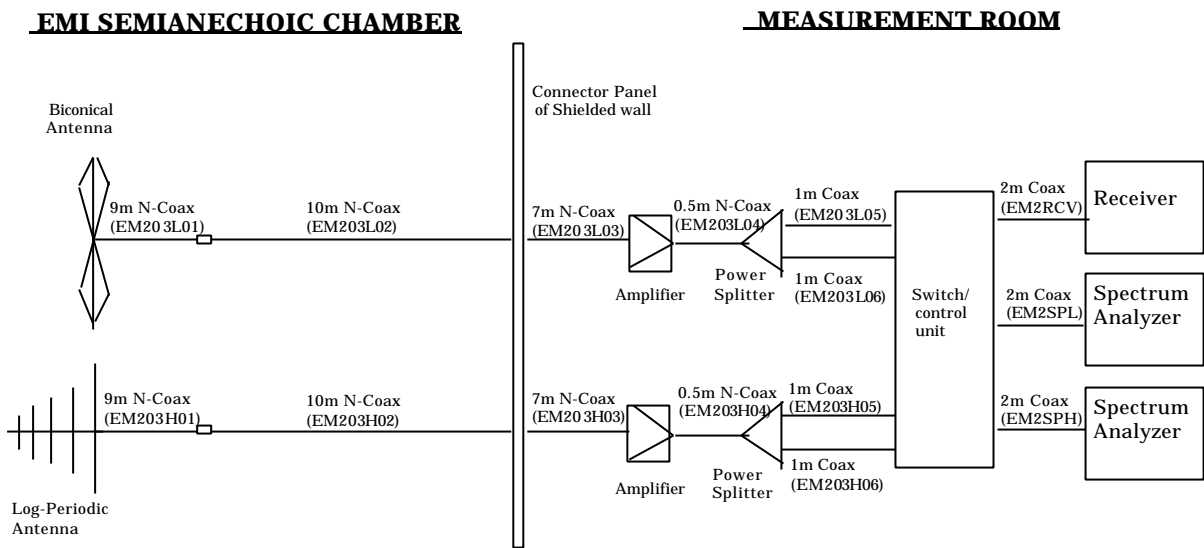

Figure 7 Cables for Radiated Emission Test

## 7.3 Field Strength Calculation

The field strength is calculated by adding the Antenna Factor and Cable Loss, and subtracting Amplifier Gain from the measured reading. In this test facility, the Antenna Factor, Cable Loss, and Amplifier Gains are loaded into the Rohde & Schwarz Receiver and the corrected field strength can be read directly on the receiver. All factors are included in the reported data.

$$FS = R + AF + CORR$$

where:

FS	=	Field Strength
R	=	Measured Receiver Input Amplitude
AF	=	Antenna Factor
CORR	=	Correction Factor = CL - AG
CL	=	Cable Loss
AG	=	Amplifier Gain

For example :

Given a Receiver input reading of 51.5dB $\mu$ V; Antenna Factor of 8.5dB/m; Cable Loss of 1.3dB; and an Amplifier Gain of 26dB. The Field Strength of the measured emission is:

$$FS = 51.5 + 8.5 + 1.3 - 26.0 = 35.3\text{dB}\mu\text{V/m}$$

Conversion between dB $\mu$ V/m (or dB $\mu$ V) and  $\mu$ V/m (or  $\mu$ V) are done as:

$$\text{Level}(\text{dB}\mu\text{V/m}) = 20 \times \text{Log}(\text{Level}(\mu\text{V/m}))$$

$$40\text{dB}\mu\text{V/m} = 100\mu\text{V/m}$$

$$48\text{dB}\mu\text{V/m} = 250\mu\text{V/m}$$



## 7.4 Measurement Results

The EUT was found to comply to the limits of FCC Part 15 Subpart C and RSS-210 with a margin of 8.3dB at 30MHz - 1000MHz band.

The 6 highest emissions relative to the limits are reported.

Test Date: March 26, 2004

Table 7-2-1. Ch.1 (2412MHz) **TX** mode 11Mbps

Frequency (MHz)	Polarity (H/V)	Measured (dBμV)	Antenna Factor (dB/m)	Corr. Factor (dB)	Field Strength (dBμV/m)	Limit (dBμV/m)	Field Strength (μV/m)	Limit (μV/m)
166.028	H	37.3	12.5	-16.3	33.5	43.5	47.3	150
196.607	H	32.2	13.6	-15.8	30.0	43.5	31.6	150
432.067	V	38.9	15.9	-22.1	32.7	46.0	43.2	200
498.229	V	37.4	17.7	-21.7	33.4	46.0	46.8	200
563.610	V	34.6	18.2	-20.4	32.4	46.0	41.7	200
629.994	H	34.7	19.1	-19.9	33.9	46.0	49.5	200

Table 7-2-2. Ch.6 (2437MHz) **TX** mode 11Mbps

Frequency (MHz)	Polarity (H/V)	Measured (dBμV)	Antenna Factor (dB/m)	Corr. Factor (dB)	Field Strength (dBμV/m)	Limit (dBμV/m)	Field Strength (μV/m)	Limit (μV/m)
166.153	H	37.0	12.5	-16.3	33.2	43.5	45.7	150
196.607	H	32.0	13.6	-15.8	29.8	43.5	30.9	150
432.068	V	39.5	15.9	-22.1	33.3	46.0	46.2	200
498.799	V	38.5	17.8	-21.5	34.8	46.0	55.0	200
563.610	V	35.1	18.2	-20.4	32.9	46.0	44.2	200
629.994	H	33.8	19.1	-19.9	33.0	46.0	44.7	200

Table 7-2-3. Ch.11 (2462MHz) **TX** mode 11Mbps

Frequency (MHz)	Polarity (H/V)	Measured (dBμV)	Antenna Factor (dB/m)	Corr. Factor (dB)	Field Strength (dBμV/m)	Limit (dBμV/m)	Field Strength (μV/m)	Limit (μV/m)
166.024	H	37.0	12.5	-16.3	33.2	43.5	45.7	150
432.069	V	40.3	15.9	-22.1	34.1	46.0	50.7	200
465.860	V	39.3	16.8	-22.3	33.8	46.0	49.0	200
497.110	V	41.4	17.7	-21.4	37.7	46.0	76.7	200
563.609	V	35.0	18.2	-20.4	32.8	46.0	43.7	200
629.994	H	33.8	19.1	-19.9	33.0	46.0	44.7	200

Table 7-2-4. Ch.6 (2437MHz) **RX** mode

Frequency (MHz)	Polarity (H/V)	Measured (dBμV)	Antenna Factor (dB/m)	Corr. Factor (dB)	Field Strength (dBμV/m)	Limit (dBμV/m)	Field Strength (μV/m)	Limit (μV/m)
166.314	H	38.2	12.4	-16.2	34.4	43.5	52.5	150
364.969	V	41.2	14.4	-22.7	32.9	46.0	44.2	200
432.067	V	39.9	15.9	-22.1	33.7	46.0	48.4	200
464.974	V	38.2	16.8	-22.0	33.0	46.0	44.7	200
497.835	V	39.5	17.7	-21.7	35.5	46.0	59.6	200
629.994	H	33.3	19.1	-19.9	32.5	46.0	42.2	200

## 8. RESTRICTED BANDS RADIATIONS (1GHz – 25GHz)

[ FCC 15.205 / 209, RSS-210 6.3 / 7.3]

### 8.1 Test Procedure

Radiated emissions were measured in the frequency range with 1 GHz to 25GHz in transmitting mode and 1 GHz to 12.5GHz in receiving mode. All tests were performed in the semi-anechoic chamber at a 3-meter distance (except for the frequency range with 18 GHz to 25 GHz where test distance was reduced to 1 meter) on both horizontal and vertical polarities. The antenna was also scanned in height. The emissions are recorded with a spectrum analyzer in peak hold mode. The identified emissions are further maximized as a function of cable manipulation, azimuth, and antenna height. The emissions closest to the limits are measured in the peak mode with the tuned spectrum analyzer using resolution bandwidth of 1MHz / video bandwidth of 1MHz, and the average setting mode with the tuned spectrum analyzer using resolution bandwidth of 1MHz / video bandwidth of 100Hz or 10Hz. The highest emissions relative to the limit are listed.

### 8.2 Test Instruments and Measurement Setup

Table 8 Radiated Emission Test Instrumentation (1GHz – 25GHz)

Description	Model	Serial Number
Spectrum Analyzer EMI Test Receiver	R&S ESI26	836119/003
Amplifier (1 – 18GHz)	HP 8449B	3008A00582
Amplifier (18 – 25GHz)	Agilent 83051A	3950M00193
Horn Antenna (1 - 18GHz)	EMCO 3115	9903-5774
Horn Antenna (3.95 – 5.85GHz)	EMCO 3160-5	1099
Horn Antenna (5.85 – 8.2GHz)	EMCO 3160-6	9712-1044
Horn Antenna (18 - 25GHz)	EMCO 3160-9	0004-1202
Coaxial cables:	Length:	
- Horn Ant <=> RF Amp. (1-18GHz)	6 m	- EM206SCO
- RF Amp.<=>Spectrum Analyzer (1-18GHz)	16 m	- GEM0101
- Horn Ant <=> RF Amp. (18-25GHz)	3m	- SF102-20167
- RF Amp.<=>Spectrum Analyzer (18-25GHz)	1m	- SF102-21105

Notes: - HP: Hewlett Packard, R&S: Rohde & Schwarz

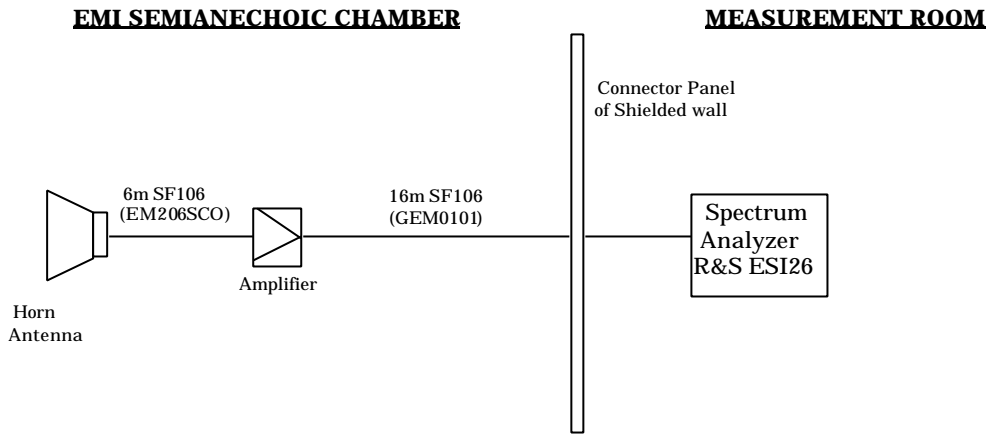

Figure 8-1. Cables for Radiated Emission Test (1 – 18 GHz)

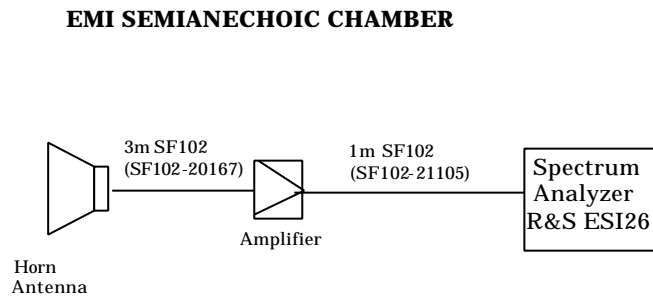

Figure 8-2. Cables for Radiated Emission Test (18 - 25GHz)

## 8.3 Field Strength Calculation

The field strength is calculated by adding the Antenna Factor and Cable Loss, and subtracting Amplifier Gain from the measured reading. All factors are included in the reported data.

$$FS = R + AF + CORR - FO$$

where:

FS = Field Strength

R = Measured Spectrum analyzer Input Amplitude

AF = Antenna Factor

CORR = Correction Factor = CL-AG

CL = Cable Loss

AG = Amplifier Gain

FO = Distance Falloff Factor

For example :

Given a Spectrum Analyzer input reading of 51.5 dB $\mu$ V; Antenna Factor of 8.5 dB/m; Cable Loss of 1.3 dB; Falloff Factor of 0 dB; and an Amplifier Gain of 26 dB. The Field Strength of the measured emission is:

$$FS = 51.5 + 8.5 + 1.3 - 26 - 0.0 = 35.6 \text{ dB}\mu\text{V/m}$$

Conversions between dB $\mu$ V/m (or dB $\mu$ V) and  $\mu$ V/m (or  $\mu$ V) are done as :

$$\text{Level(dB}\mu\text{V/m)} = 20 \times \text{Log} (\text{Level}(\mu\text{V/m}))$$

$$40 \text{ dB}\mu\text{V/m} = 100 \mu\text{V/m}$$

$$48 \text{ dB}\mu\text{V/m} = 250 \mu\text{V/m}$$

## 8.4 Measurement Results

The EUT was found to comply to the limits of FCC Part 15 Subpart C and RSS-210 with a margin of 3.3dB. The measurement was done for the frequency range of 1 GHz to 25 GHz in TX mode and 1 GHz to 12.5GHz in RX mode.

Test Date: March 24 and 26, 2004

\*Note: OB means “operation band” (2400-2483.5MHz); in this case limit is 1W (measured conducted with power meter)

Table 8-2-1. Ch.1 (2412MHz) **TX** mode 11Mbps

Frequency (GHz)	Polarity (H/V)	Measured (dBμV) ( <i>peak</i> )	Measured (dBμV) ( <i>average</i> )	Antenna Factor (dB/m)	Corr. Factor (dB)	Falloff Factor (dB)	Field Strength (dBμV/m) ( <i>peak</i> )	FCC Limit (dBμV/m) ( <i>peak</i> )	Field Strength (dBμV/m) ( <i>average</i> )	FCC Limit (dBμV/m) ( <i>average</i> )
Inband 2.413	H	114.2	106.4	28.3	-29.6	0.0	112.9	OB*	105.1	OB*
Adjacent RB 2.389	H	54.6	-	28.2	-29.6	0.0	53.2	74.0	-	54.0
2.390	H	56.3	45.3	28.2	-29.6	0.0	54.9	74.0	43.9	54.0
1.066	V	52.9	-	24.6	-32.0	0.0	45.5	74.0	-	54.0
1.129	V	49.4	-	24.5	-31.8	0.0	42.1	74.0	-	54.0
1.163	V	48.1	-	24.6	-31.7	0.0	41.0	74.0	-	54.0
1.198	V	48.7	-	25.2	-31.6	0.0	42.3	74.0	-	54.0
2.382	H	50.3	-	28.2	-29.6	0.0	48.9	74.0	-	54.0
2.386	H	54.0	-	28.2	-29.6	0.0	52.6	74.0	-	54.0
4.826	H	55.9	40.2	27.1	-27.2	0.0	55.8	74.0	40.1	54.0

Table 8-2-2. Ch.6 (2437MHz) **TX** mode 11Mbps

Frequency (GHz)	Polarity (H/V)	Measured (dBμV) ( <i>peak</i> )	Measured (dBμV) ( <i>average</i> )	Antenna Factor (dB/m)	Corr. Factor (dB)	Falloff Factor (dB)	Field Strength (dBμV/m) ( <i>peak</i> )	FCC Limit (dBμV/m) ( <i>peak</i> )	Field Strength (dBμV/m) ( <i>average</i> )	FCC Limit (dBμV/m) ( <i>average</i> )
Inband 2.438	H	114.7	106.9	28.4	-29.6	0.0	113.5	OB*	105.7	OB*
Adjacent RB 2.390	H	50.1	-	28.2	-29.6	0.0	48.7	74.0	-	54.0
2.484	H	49.8	-	28.4	-29.6	0.0	48.6	74.0	-	54.0
2.486	H	51.7	-	28.4	-29.6	0.0	50.5	74.0	-	54.0
1.066	V	53.3	-	24.6	-32.0	0.0	45.9	74.0	-	54.0
1.129	V	50.1	-	24.5	-31.8	0.0	42.8	74.0	-	54.0
1.163	V	48.1	-	24.6	-31.7	0.0	41.0	74.0	-	54.0
1.198	V	50.1	-	25.2	-31.6	0.0	43.7	74.0	-	54.0
2.364	V	49.8	-	28.1	-29.6	0.0	48.3	74.0	-	54.0
2.384	H	50.6	-	28.2	-29.6	0.0	49.2	74.0	-	54.0
4.876	H	55.2	39.8	27.0	-27.0	0.0	55.2	74.0	39.8	54.0
7.311	V	43.2	-	29.9	-24.9	0.0	48.2	74.0	-	54.0

Table 8-2-3. Ch.11 (2462MHz) **TX** mode 11Mbps

Frequency (GHz)	Polarity (H/V)	Measured (dBμV) ( <i>peak</i> )	Measured (dBμV) ( <i>average</i> )	Antenna Factor (dB/m)	Corr. Factor (dB)	Falloff Factor (dB)	Field Strength (dBμV/m) ( <i>peak</i> )	FCC Limit (dBμV/m) ( <i>peak</i> )	Field Strength (dBμV/m) ( <i>average</i> )	FCC Limit (dBμV/m) ( <i>average</i> )
Inband 2.463	H	115.1	107.2	28.4	-29.6	0.0	113.9	OB*	106.0	OB*
Adjacent RB 2.484	H	62.1	51.9	28.4	-29.6	0.0	60.9	74.0	50.7	54.0
2.485	H	61.2	47.0	28.4	-29.6	0.0	60.0	74.0	45.8	54.0
1.065	V	53.1	-	24.6	-32.0	0.0	45.7	74.0	-	54.0
1.132	V	49.4	-	24.6	-31.8	0.0	42.2	74.0	-	54.0
1.163	V	48.8	-	24.6	-31.7	0.0	41.7	74.0	-	54.0
1.334	V	48.4	-	25.2	-31.3	0.0	42.3	74.0	-	54.0
2.379	H	49.4	-	28.2	-29.6	0.0	48.0	74.0	-	54.0
2.389	H	49.6	-	28.2	-29.6	0.0	48.2	74.0	-	54.0
4.926	H	56.8	41.2	27.0	-27.0	0.0	56.8	74.0	41.2	54.0
7.390	V	42.1	-	29.8	-24.9	0.0	47.0	74.0	-	54.0

Table 8-2-4. Ch.6 (2437MHz) **RX** mode

Frequency (GHz)	Polarity (H/V)	Measured (dBμV) ( <i>peak</i> )	Measured (dBμV) ( <i>average</i> )	Antenna Factor (dB/m)	Corr. Factor (dB)	Falloff Factor (dB)	Field Strength (dBμV/m) ( <i>peak</i> )	FCC Limit (dBμV/m) ( <i>peak</i> )	Field Strength (dBμV/m) ( <i>average</i> )	FCC Limit (dBμV/m) ( <i>average</i> )
1.066	V	52.8	-	24.6	-32.0	0.0	45.4	74.0	-	54.0
1.132	V	51.8	-	24.6	-31.8	0.0	44.6	74.0	-	54.0
1.163	V	48.0	-	24.6	-31.7	0.0	40.9	74.0	-	54.0
1.327	V	52.8	-	25.6	-31.3	0.0	47.1	74.0	-	54.0

### 8.5 Measurement plots of adjacent restricted band

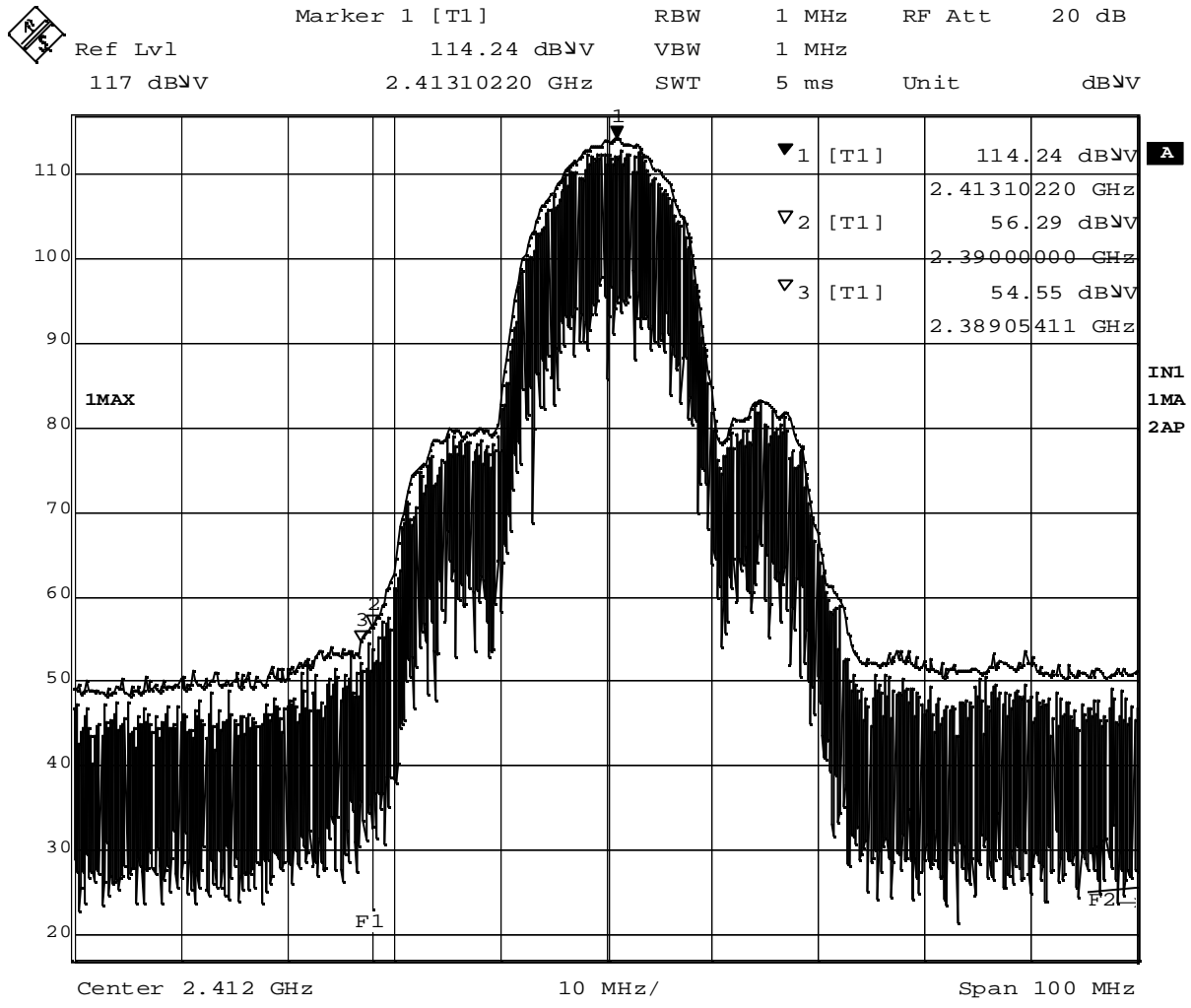

Plot 8-1 Ch.1 2412MHz TX, 11Mbps (Peak)



Ref Lvl	Marker 1 [T1]	RBW	1 MHz	RF Att	20 dB
117 dB $\mu$ V	106.37 dB $\mu$ V	VBW	10 Hz		
	2.41230060 GHz	SWT	25 s	Unit	dB $\mu$ V

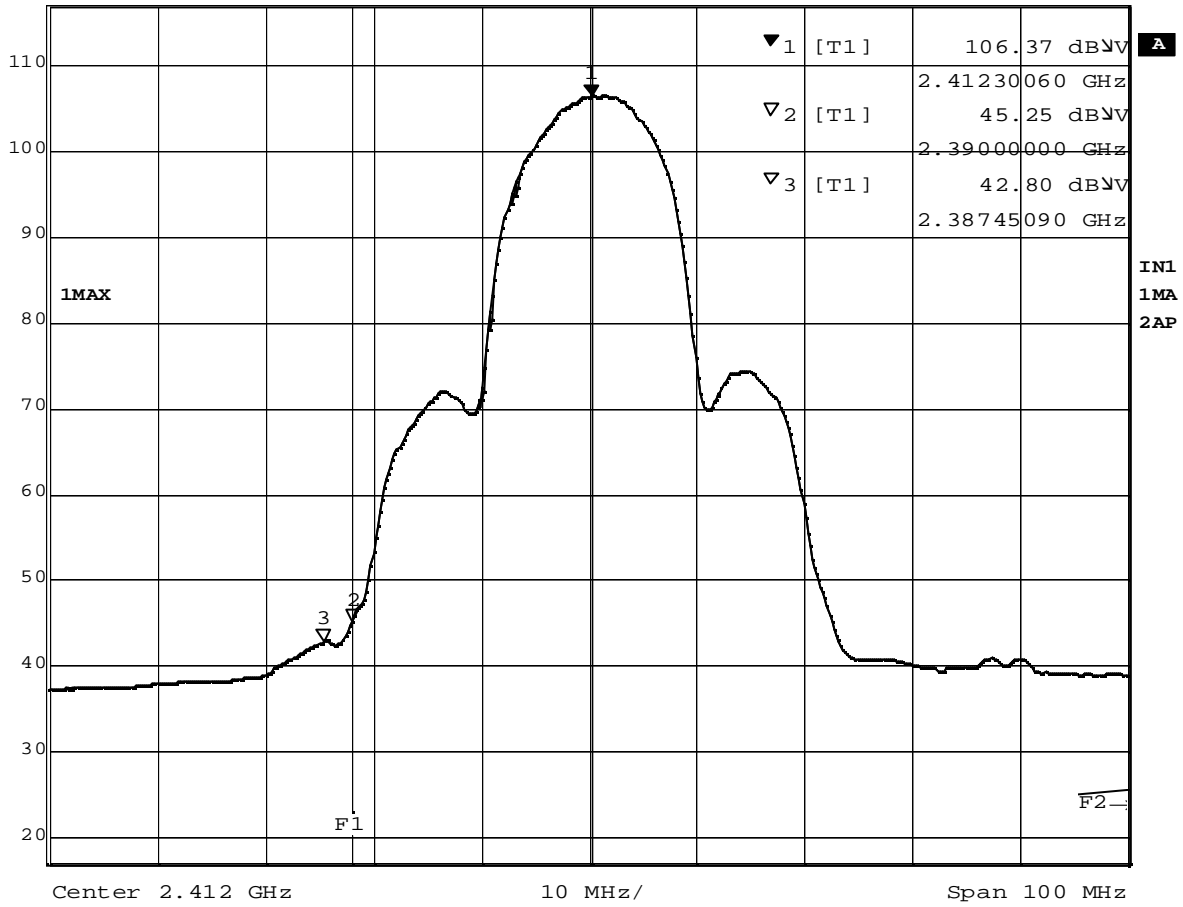

Date: 24.MAR.2004 09:36:29

Plot 8-2 Ch.1 2412MHz TX. 11Mbps (Average)





Marker 1 [T1] RBW 1 MHz RF Att 20 dB  
 Ref Lvl 115.07 dBμV VBW 1 MHz  
 117 dBμV 2.46310220 GHz SWT 5 ms Unit dBμV

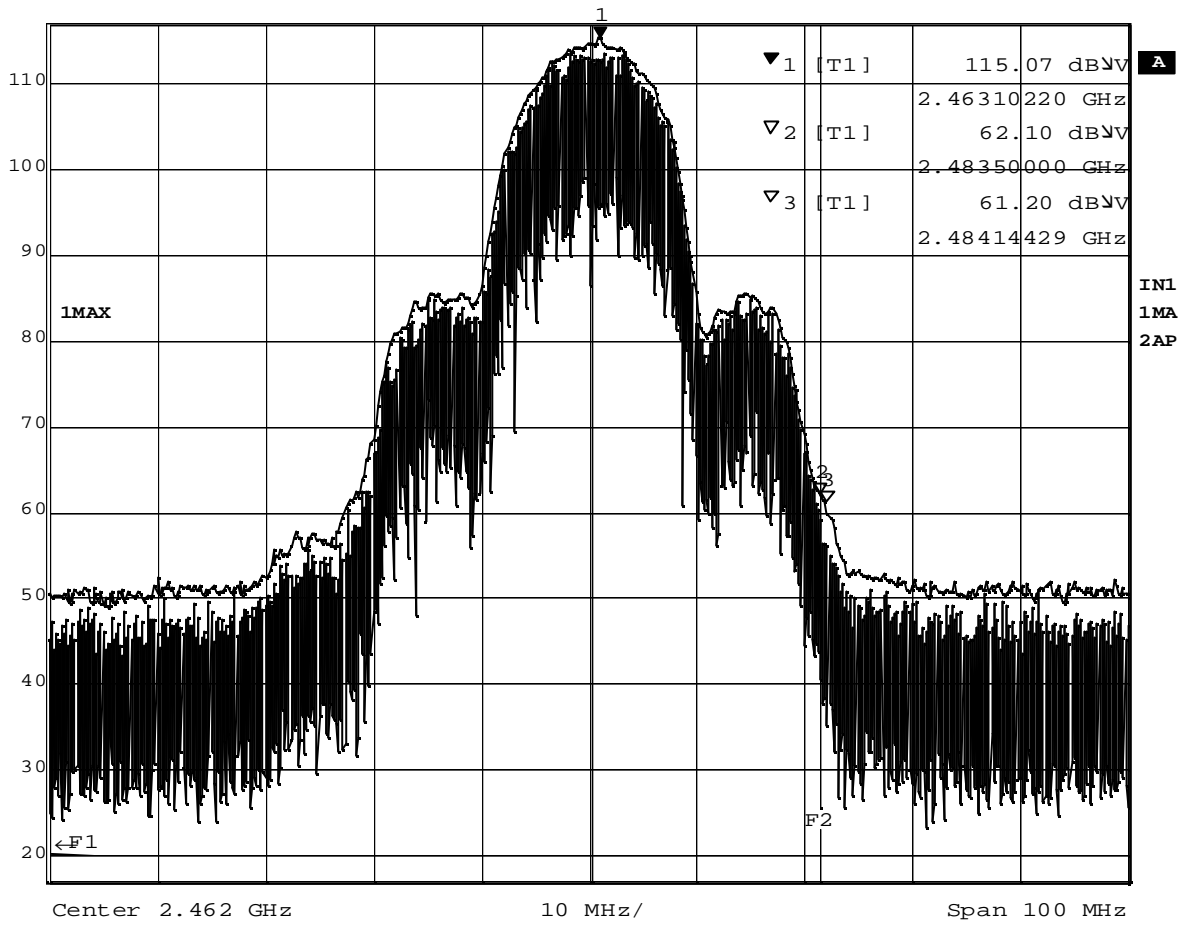

Date: 24.MAR.2004 09:41:38

Plot 8-3 Ch.11 2462MHz TX, 11Mbps (Peak)



Marker 1 [T1]	RBW	1 MHz	RF Att	20 dB
Ref Lvl	107.18 dBμV	VBW	10 Hz	
117 dBμV	2.46230060 GHz	SWT	25 s	Unit dBμV

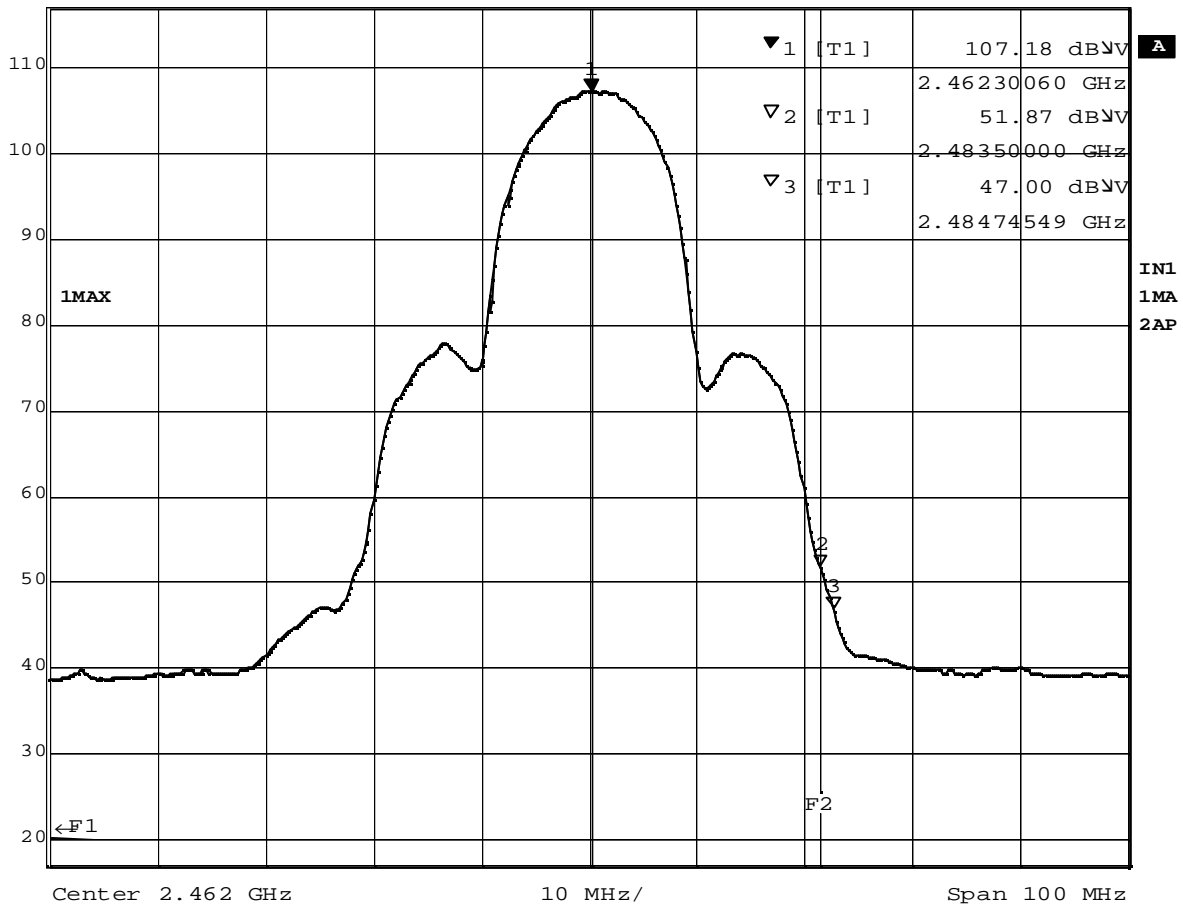

Date: 24.MAR.2004 09:41:10

Plot 8-4 Ch.11 2462MHz TX, 11Mbps (Average)