

Emission Test Report

Standard: FCC Part 15 Subpart C / IC RSS-210

Document Number : FCC 19-0195-0

**Product: IBM ThinkPad X30 Series
Multiple Transmitters model
(with IBM Bluetooth Daughter Card)**

FCC ID: ANOTK1TP10SHR

May 7, 2002

Prepared :
EMC Engineer

Takeshi Asano

Signature: 
IBM Japan, Ltd.
EMC Engineering
LAB-S59
1623-14, Shimotsuruma,
Yamato-shi Kanagawa-ken 242, Japan
Phone: +81-46-215-4779
Fax: +81-46-273-7420
E-Mail: asano@jp.ibm.com

Reviewed and Checked :
EMC Staff Engineer

Toshiya Murota

Signature: 
IBM Japan, Ltd.
EMC Engineering
LAB-S59
1623-14, Shimotsuruma,
Yamato-shi Kanagawa-ken 242, Japan
Phone: +81-46-215-6574
Fax: +81-46-273-7420
E-Mail: murota@jp.ibm.com

Approved :
Manager, EMC Engineering

Akihisa Sakurai

Signature: 
IBM Japan, Ltd.
EMC Engineering
LAB-S59
1623-14, Shimotsuruma,
Yamato-shi Kanagawa-ken 242, Japan
Phone: +81-46-215-2613
Fax: +81-46-273-7420
E-Mail: akihisa@jp.ibm.com

MEASUREMENT / TECHNICAL REPORT – Part 15 Subpart C (Intentional Radiator)

IBM ThinkPad X30 Series Multiple Transmitters model (with IBM Bluetooth Daughter Card)

FCC ID : ANOTK1TP10SHR

May 7, 2002

This report concerns: (check one) Original Grant <input checked="" type="checkbox"/> _____ Class I change <input type="checkbox"/> _____ Class II change <input type="checkbox"/> _____
Equipment type: <u>Wireless LAN device</u>
This report shall not be reproduced except in full, without the written permission of this test lab.
The measurement results contained in this report relate only to the item which was tested.
Measurement procedure used is ANSI C63.4-2000 unless otherwise specified.
Other test procedure: _____
The FCC has issued provisional acceptance of this test laboratory for Declaration of Conformity testing per letter dated 1997.
APPLICANT ANTI-DRUG ABUSE CERTIFICATION: By checking yes, the applicant certifies that, in the case of an individual applicant, he or she is not subject to a denial of federal benefits, that includes FCC benefits, pursuant to Section 5301 of the Anti-Drug Abuse of 1988, 21 U.S.C. 853(a), or, in the case of a non-individual applicant (e.g. corporation, partnership or other unincorporated association), no party to the application is subject to a denial of federal benefits, that includes FCC benefits, pursuant to that section. For the definition of a “party” for these purposes, see 47 CFR 1.2002(b). <div style="text-align: center;"> <input checked="" type="radio"/> Yes or <input type="radio"/> No </div>
“Report shall not be reproduced except in full, without the written approval of the laboratory” “the report must not be used by the client to claim product endorsement by NVLAP or any agency of the US government”
Prepared by: Takeshi Asano <div style="text-align: right;"> IBM Japan Corporation, Yamato EMC Engineering LAB-S59, 1623-14, Shimotsuruma, Yamato-shi Kanagawa-ken 242-8502, Japan Tel: +81-46-215-4779 Fax: +81-46-273-7420 </div>

- Index -

MEASUREMENT / TECHNICAL REPORT – PART 15 SUBPART C..... 3

A. GENERAL INFORMATION..... 3

A.1 TEST METHODOLOGY 3

A.2 TEST FACILITY / NVLAP ACCREDITATION 3

A.3 EUT DETAILS 3

B. SUMMARY OF TEST RESULTS..... 4

C. OPERATION MODE OF EUT..... 5

D. TEST INSTRUMENTS..... 6

E. MEASUREMENT UNCERTAINTY..... 7

F. RELATED SUBMITTAL(S)/GRANT(S)/NOTES 7

1. CARRIER FREQUENCY SEPARATION..... 8

1.1 TEST PROCEDURE..... 8

1.2 TEST INSTRUMENTS AND MEASUREMENT SETUP..... 8

1.3 MEASUREMENT RESULTS..... 8

1.4 TRACE DATA..... 9

2. NUMBER OF HOPPING FREQUENCIES..... 10

2.1 TEST PROCEDURE..... 10

2.2 TEST INSTRUMENTS AND MEASUREMENT SETUP..... 10

2.3 MEASUREMENT RESULTS..... 10

2.4 TRACE DATA..... 11

3. 20 DB BANDWIDTH..... 15

3.1 TEST PROCEDURE..... 15

3.2 TEST INSTRUMENTS AND MEASUREMENT SETUP..... 15

3.3 MEASUREMENT RESULTS..... 15

3.4 TRACE DATA..... 16

4. TIME OF OCCUPANCY (DWELL TIME) 21

4.1 TEST PROCEDURE..... 21

4.2 TEST INSTRUMENTS AND MEASUREMENT SETUP..... 21

4.3 MEASUREMENT RESULTS..... 21

4.4 TRACE DATA..... 22

5. PEAK OUTPUT POWER..... 28

5.1 TEST PROCEDURE..... 28

5.2 TEST INSTRUMENTS AND MEASUREMENT SETUP..... 28

5.3 MEASUREMENT RESULTS..... 28

5.4 TRACE DATA..... 29

6. BAND-EDGE (AT 20 DB BLOW)..... 34

6.1 TEST PROCEDURE..... 34

6.2 TEST INSTRUMENTS AND MEASUREMENT SETUP..... 34

6.3 MEASUREMENT RESULTS..... 34

6.4 TRACE DATA..... 35

7. OUT OF BAND EMISSIONS..... 38

7.1 TEST PROCEDURE..... 38

7.2 TEST INSTRUMENTS AND MEASUREMENT SETUP..... 38

7.3 MEASUREMENT RESULTS..... 38

7.4 TRACE DATA..... 39

8. TRANSMITTER POWER SPECTRAL DENSITY 42

8.1 TEST PROCEDURE..... 42

8.2 TEST INSTRUMENTS AND MEASUREMENT SETUP..... 42

8.3 MEASUREMENT RESULTS..... 42

8.4 TRACE DATA..... 43

9. AC WIRELINE CONDUCTED EMISSIONS (450 KHZ – 30 MHZ) 45

9.1 TEST PROCEDURE..... 45

9.2 TEST INSTRUMENTS AND MEASUREMENT SETUP..... 45

9.3 MEASUREMENT RESULTS..... 46

10. RESTRICTED BANDS RADIATIONS (30 MHZ – 1 GHZ) 48

10.1 TEST PROCEDURE..... 48

10.2 TEST INSTRUMENTS AND MEASUREMENT SETUP..... 48

10.3 FIELD STRENGTH CALCULATION..... 50

10.4 MEASUREMENT RESULTS..... 51

11. RESTRICTED BANDS RADIATIONS (1 GHZ – 25 GHZ) 53

11.1 TEST PROCEDURE..... 53

11.2 TEST INSTRUMENTS AND MEASUREMENT..... 53

11.3 FIELD STRENGTH CALCULATION..... 54

11.4 MEASUREMENT RESULTS..... 55

A. GENERAL INFORMATION

APPLICANT : IBM Japan Ltd.
 TEST SITE : IBM Japan, Ltd., Yamato Semi-anechoic chamber #2
 ADDRESS : 1623 – 14 Shimotsuruma, Yamato-shi, Kanagawa 242-8502 Japan
 Tel: +81-46-215-4779, Fax: +81-46-273-7420
 REGULATION : FCC Part 15 Subpart C
 Industry Canada RSS-210 (Issue No.5)
 MODEL NUMBER : 2672-4HU (ThinkPad X30 Series, Multiple Transmitters model)
 FCC ID : ANOTK1TP10SHR
 SERIAL NUMBER : ZZ-00245
 PHYSICAL CONDITION : Preproduction
 KIND OF EQUIPMENT : Personal computer with a built-in Bluetooth card
 TESTED DATE : April 9, 11, 18, 24 and 26, 2002

A.1 Test Methodology

Both conducted and radiated testing were performed according to the procedures in ANSI C63.4-2000. Radiated testing was performed at an antenna to EUT distance of 3 meters.

A.2 Test Facility / NVLAP Accreditation

The semi-anechoic chamber #2 used to correct the data are located in Yamato Laboratory, IBM Japan.

- This facility has been fully described in a report dated September 1998, submitted to the FCC office, and accepted in a letter, dated Nov. 2,1998(31040/SIT).
- This facility is accepted by **Industry Canada** in a letter dated March 19, 2001 as number **IC 349E** for chamber #2, and January 25, 2002 as number **IC 4221** for chamber #1.
- IBM Yamato EMC Engineering is recognized under the National Voluntary Laboratory Accreditation Program for satisfactory compliance with Criteria established in Title 15, Part 285 Code of Federal Regulations.(NVLAP Lab code: 200198-0)

A.3 EUT details

Table A EUT details

Model and S/N	FCC ID IC Cert. Number	Description
ThinkPad X30 Series M/T 2672-4HU (s/n ZZ-00245)	ANOTK1TP10SHR	IBM Notebook PC CPU: Intel® Mobile Pentium® III Processor-M, 1.20GHz
P/N 02K6808	N/A	Universal AC adapter 56W, Unshielded power cord

B. SUMMARY OF TEST RESULTS

Table-B presents the list of the measurement items for Spread Spectrum, Direct Sequence devices under FCC Part 15 Subpart C and Industry Canada RSS-210.

The section numbers of upper portion are showing FCC number, and the other (lower) ones are for IC.

Table-B List of the measurements

Section(s)	Test Items		Condition	Result
	Transmit mode (TX):			
15.247(a)(1) 6.2.2(o)(a1)	Carrier Frequency Separation	min. 25 kHz	Conducted	Pass
	Number of Hopping Frequencies	at least 75 hops		Pass
15.247(a)(1) 6.2.2(o)(a3)	20 dB Bandwidth	max. 1 MHz		Pass
	Dwell Time	0.4 seconds within a 30 second period per any frequency		Pass
15.247(f) 6.2.2 (o)(c2)	Hybrid Dwell Time	0.4 seconds within a 12.8 second (32 hops × 0.4sec) period		Pass
15.247(b)(1) 6.2.2(o)(a3)	Peak output power	Shall not exceed 1.0 W.		Pass
15.247(c) 5.9.1 6.2.2 (o) (e1)	Band-edge (or Occupied BW for IC)	$2400 \text{ MHz} \leq \chi \leq 2483.5 \text{ MHz}$		Pass
	Out of Band Emissions (Bandwidth at 20 dB blow)	The radiated emission to any 100 kHz of outband shall be at least 20 dB below the highest inband spectral density.		Pass
15.247(f) 6.2.2 (o)(c2)	Processing Gain for Hybrid System	N/A ^{*1}		N/A ^{*1}
	Transmitter power spectral density for Hybrid System	Shall not be greater than 8 dBm in any 3 kHz band.		Pass
15.207 6.6	AC Wireline Conducted emissions 450 kHz – 30 MHz	Class B: 250 μV	Pass	
15.205 / 209 6.2.1 / 6.3	General Field Strength Limits (Restricted Bands and Radiated Emission Limits)	Shall not exceed the limits specified in FCC 15.209, or RSS-210, Table 3.	Radiated (30M - 1GHz)	Pass
			Radiated (1G – 25GHz)	Pass
	Receive mode (RX):			
15.207 7.4	AC Wireline Conducted Emissions 450 kHz – 30 MHz	Class B: 250 μV	Conducted	Pass
15.209 7.3	General Field Strength Limits (Radiated Emission Limits)	Shall not exceed the limits specified in FCC 15.209, or RSS-210, Table 3.	Radiated (30M - 1GHz)	Pass
			Radiated (1G – 25GHz)	Pass

*1: The Processing Gain data was excluded from this application according to the FCC rule change on May/16/2002.

C. OPERATION MODE OF EUT

All tests were performed using the “BlueTest version 1.4” and “BlueChat version 2.2”.

Hopping channels

The applying wireless card is designed to the Bluetooth Standard. The lowest hopping frequency is 2402MHz, and the highest one 2480MHz. Total 79 hopping channels are used with each 1MHz of channel spacing.

Ch.	Operation Frequency [GHz]
1	2.402
2	2.403
3	2.404
4	2.405
5	2.406
6	2.407
7	2.408
8	2.409
9	2.410
10	2.411
11	2.412
12	2.413
13	2.414
14	2.415
15	2.416
16	2.417
17	2.418
18	2.419
19	2.420
20	2.421

Ch.	Operation Frequency [GHz]
21	2.422
22	2.423
23	2.424
24	2.425
25	2.426
26	2.427
27	2.428
28	2.429
29	2.430
30	2.431
31	2.432
32	2.433
33	2.434
34	2.435
35	2.436
36	2.437
37	2.438
38	2.439
39	2.440
40	2.441

Ch.	Operation Frequency [GHz]
41	2.442
42	2.443
43	2.444
44	2.445
45	2.446
46	2.447
47	2.448
48	2.449
49	2.450
50	2.451
51	2.452
52	2.453
53	2.454
54	2.455
55	2.456
56	2.457
57	2.458
58	2.459
59	2.460
60	2.461

Ch.	Operation Frequency [GHz]
61	2.462
62	2.463
63	2.464
64	2.465
65	2.466
66	2.467
67	2.468
68	2.469
69	2.470
70	2.471
71	2.472
72	2.473
73	2.474
74	2.475
75	2.476
76	2.477
77	2.478
78	2.479
79	2.480

Test Frequencies (Section 15.31m)

In line with the Section 15.31(m) of Public Notice DA 00-705 dated March/30/2000, some measurements are performed at the highest, middle, and lowest available channels with the hopping function disabled. (i.e. at **2402MHz, 2441MHz and 2480MHz**)

Unless otherwise specified the above condition, the test was performed while EUT had its hopping function enabled.

D. TEST INSTRUMENTS

Table-D List of Measuring Instruments

Description	Model	Serial Number	Calibration Date	Calibration Interval
Computer	IBM 5551-L	#4	N/A	N/A
Computer	IBM 6589-13J	97-15613	N/A	N/A
Spectrum Analyzer (100Hz-1.5GHz)	HP 85680B	2732A03651	02/19/02	1 year
Spectrum Analyzer (100Hz-1.5GHz)	HP 85680B	2841A04254	04/26/01	1 year
Spectrum Analyzer (100Hz-1.5GHz)	HP 85680B	2841A04242	10/18/01	1 year
Spectrum Analyzer Display	HP 85662A	2648A15255	02/19/02	1 year
Spectrum Analyzer Display	HP 85662A	2816A16831	04/26/01	1 year
Spectrum Analyzer Display	HP 85662A	2816A16827	10/18/01	1 year
Quasi-Peak Adapter	HP 85650A	2521A00968	02/15/02	1 year
Quasi-Peak Adapter	HP 85650A	2811A01156	04/26/01	1 year
Quasi-Peak Adapter	HP 85650A	2811A01126	10/18/01	1 year
Amplifier (100KHz - 1.3GHz) - for 30-200MHz - for 200-1000MHz	HP 8447D HP 8447D	2805A02919 2944A03506	04/16/01 04/16/01	1 year 1 year
Amplifier (1GHz - 26.5GHz)	HP 8449B	3008A00582	05/23/01	1 year
Spectrum Analyzer EMI Test Receiver	R&S ESI26	836119/003	07/04/01	1 year
Receiver (9kHz-30MHz)	R&S ESH3	891806/012	09/28/01	1 year
Receiver (20MHz-1.3GHz)	R&S ESVP	892111/030	05/21/01	1 year
Biconical Antenna (30-200MHz)	EMCO 3108	2241	05/11/01	1 year
Log-Periodic Antenna (200-1000MHz)	EMCO 3146	1584	05/10/01	1 year
Horn Antenna (1- 18GHz)	EMCO 3115	9903-5774	04/23/01	1 year
Horn Antenna (3.95- 5.85GHz)	EMCO 3160-5	1099	04/26/01	1 year
Horn Antenna (5.85- 8.20GHz)	EMCO 3160-6	9712-1044	04/26/01	1 year
Horn Antenna (18- 26.5GHz)	EMCO 3160-9	0004-1202	05/01/01	1 year
LISN	EMCO 3825/2	1426	09/01/01	1 year
Power Meter	HP 436A	2604A24192	09/06/01	1 year
Power Sensor	HP 8482A	2607A10987	09/07/01	1 year
Switch/control unit	HP 3488A	2719A17226 2719A17228	N/A N/A	N/A N/A
Plotter	HP 7550A	2631A33619	N/A	N/A
SF106 cables: - Horn Ant <=> RF Amp. - RF Amp.<=>Spectrum Analyzer	Length: 6 m 15m	- EM206SCO - EM215SCO	08/07/01 08/07/01	1 year 1 year
N-Coax cables: - Bi-coni Ant <=> 10m Cable - 10m Cable <=> Shield Panel - Shield Panel <=> RF Amp - RF Amp <=> Power Splitter - Log-peri Ant <=> 10m Cable	9 m 10 m 7 m 0.5m 9 m	- EM203L01 - EM203L02 - EM203L03 - EM203L04 - EM203H01	04/16/01 04/16/01 04/16/01 04/16/01 04/16/01	1 year 1 year 1 year 1 year 1 year

- 10m Cable <=> Shield Panel	10 m	- EM203H02	04/16/01	1 year
- Shield Panel <=> RF Amp	7 m	- EM203H03	04/16/01	1 year
- RF Amp <=> Power Splitter	0.5m	- EM203H04	04/16/01	1 year
Coax cables:				
- Lisn-L <=> SW/Con.unit (SW100)	4 m	- EMIC-L	04/16/01	1 year
- Lisn-N <=> SW/Con.unit (SW101)	4 m	- EMIC-N	04/16/01	1 year
- SW/Con.unit <=> RCVR (Input)	1 m	- EMIC-R	04/16/01	1 year
- SW/Con.unit<=> Spe Ana.(Signal In)	1 m	- EMIC-S	04/16/01	1 year
- Power Splitter <=> SW/Con.unit (SW110)	1 m	- EM203L05	04/16/01	1 year
- Power Splitter <=> SW/Con.unit (SW300)	1 m	- EM203L06	04/16/01	1 year
- Power Splitter <=> SW/Con.unit (SW100)	1 m	- EM203H05	04/16/01	1 year
- Power Splitter <=> SW/Con.unit (SW301)	1 m	- EM203H06	04/16/01	1 year
- SW/Con.unit <=> Receiver (Input)	2 m	- EM2RCV	04/16/01	1 year
- SW/Con.unit <=> Spe Ana.(Signal In) for 30- 200MHz	2 m	- EM2SPL	04/16/01	1 year
- SW/Con.unit <=> Spe Ana.(Signal In) for 200-1000MHz	2 m	- EM2SPH	04/16/01	1 year

Notes.

- The above equipment calibration is traceable to National standards.
- HP: Hewlett Packard, R&S: Rohde & Schwarz

E. MEASUREMENT UNCERTAINTY

Uncertainties of the both, the Yamato EMI radiated test facilities (EMI chambers, #1 and #2) and the Yamato EMI conducted test facility are derived with the NIS 81 " Treatment of uncertainty in EMC measurements" 1994.

Estimated site uncertainty values are as follows.

- EMI chamber #1 : 4.17dB
- EMI chamber #2 : 4.18dB
- EMI conducted measurement system : 2.4dB

Detail should be referred to "Treatment of Uncertainty, Calculations and Policy" report, document number TCR 10-0015.

F. Related Submittal(s)/Grant(s)/Notes

The host unit with full peripheral devices including the applying modular as an unintentional radiator is classified as a Digital Device under the FCC Part 15 Subpart B or the Industry Canada Class B Emission Compliance (ICES-003), and subject to SDoC.

1. Carrier Frequency Separation

1.1 Test Procedure

- The carrier frequency separation was measured with a spectrum analyzer connected to the antenna terminal, while EUT had its hopping function enabled.
- The spectrum analyzer was set to :
 - Span = 3 MHz (wide enough to capture the peaks of two adjacent channels),
 - Resolution Bandwidth (RBW) = 30 kHz (1% of the span or more),
 - Video Bandwidth (VBW) = 30 kHz (= RBW or more), Sweep = auto,
 - Detector function = peak, Trace = max hold
- After the trace being stable, the reading value between the peaks of the adjacent channels using the marker-delta function was recorded as the measurement results.

1.2 Test Instruments and Measurement Setup

Table 1-1 : Test Instruments

Description	Model	Serial Number
Spectrum Analyzer EMI Test Receiver	R&S ESI26	836119/003
Coax cables: - Spectrum Analyzer <=> EUT	Length: 120 cm Loss: 1.7 dB	

Notes: - R&S : Rohde & Schwarz

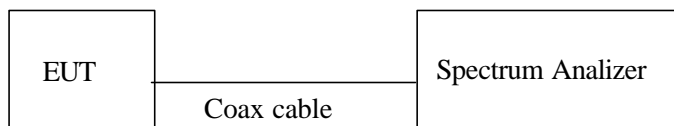

Figure 1: Measurement setup for the carrier frequency separation

1.3 Measurement Results

Test Date: April 26, 2002

Table 1-2. EUT: M/T 2672-4HU, s/n ZZ-00245, TX hopping mode

Frequency of marker #1 (MHz)	Frequency of marker #2 (MHz)	Carrier Frequency Separation (MHz)	Note
2440.08	2441.07	0.99	Min. 25 kHz

1.4 Trace Data

	Marker 1 [T1]	RBW	30 kHz	RF Att	40 dB
	Ref Lvl	0.29 dBm	VBW	30 kHz	
	25 dBm	2.44106914 GHz	SWT	8.5 ms	Unit dBm

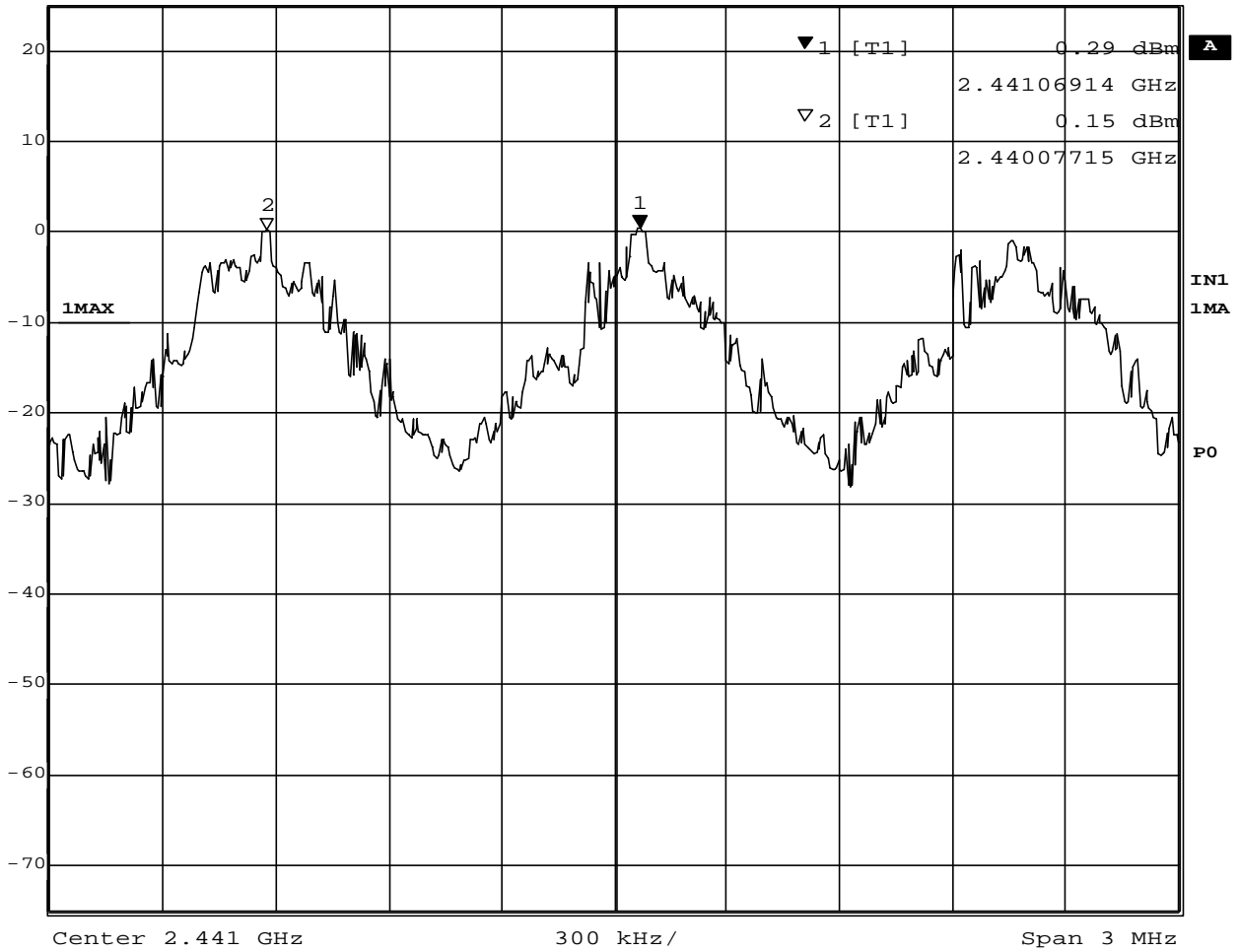

Date: 26.APR.2002 09:33:55

Carrier Frequency Separation

2. Number of Hopping Frequencies

2.1 Test Procedure

- The number of hopping frequencies was measured with a spectrum analyzer connected to the antenna terminal, while EUT had its hopping function enabled.
 - To get higher resolution, four frequency ranges within the 2400 - 2483.5 MHz FH band were examined.
 - The spectrum analyzer was set to :
 - Frequency range 1: Start = 2389.5 MHz, Stop = 2414.5 MHz
 - 2: Start = 2414.5 MHz, Stop = 2439.5 MHz
 - 3: Start = 2439.5 MHz, Stop = 2464.5 MHz
 - 4: Start = 2464.5 MHz, Stop = 2489.5 MHz
- RBW ≥ 1% of the span, VBW ≥ RBW, Sweep = auto, Detector function = peak,
Trace = max hold

2.2 Test Instruments and Measurement Setup

Same as the Chapter 1(Table 1-1 & Figure 1).

2.3 Measurement Results

Test Date: April 26, 2002

Table 2. EUT: M/T 2672-4HU, s/n ZZ-00245, TX hopping mode

Total number of Hopping Channels	Note
79	Min. 75 hops

2.4 Trace Data



Ref Lvl 25 dBm
RBW 300 kHz RF Att 40 dB
VBW 300 kHz
SWT 5 ms Unit dBm

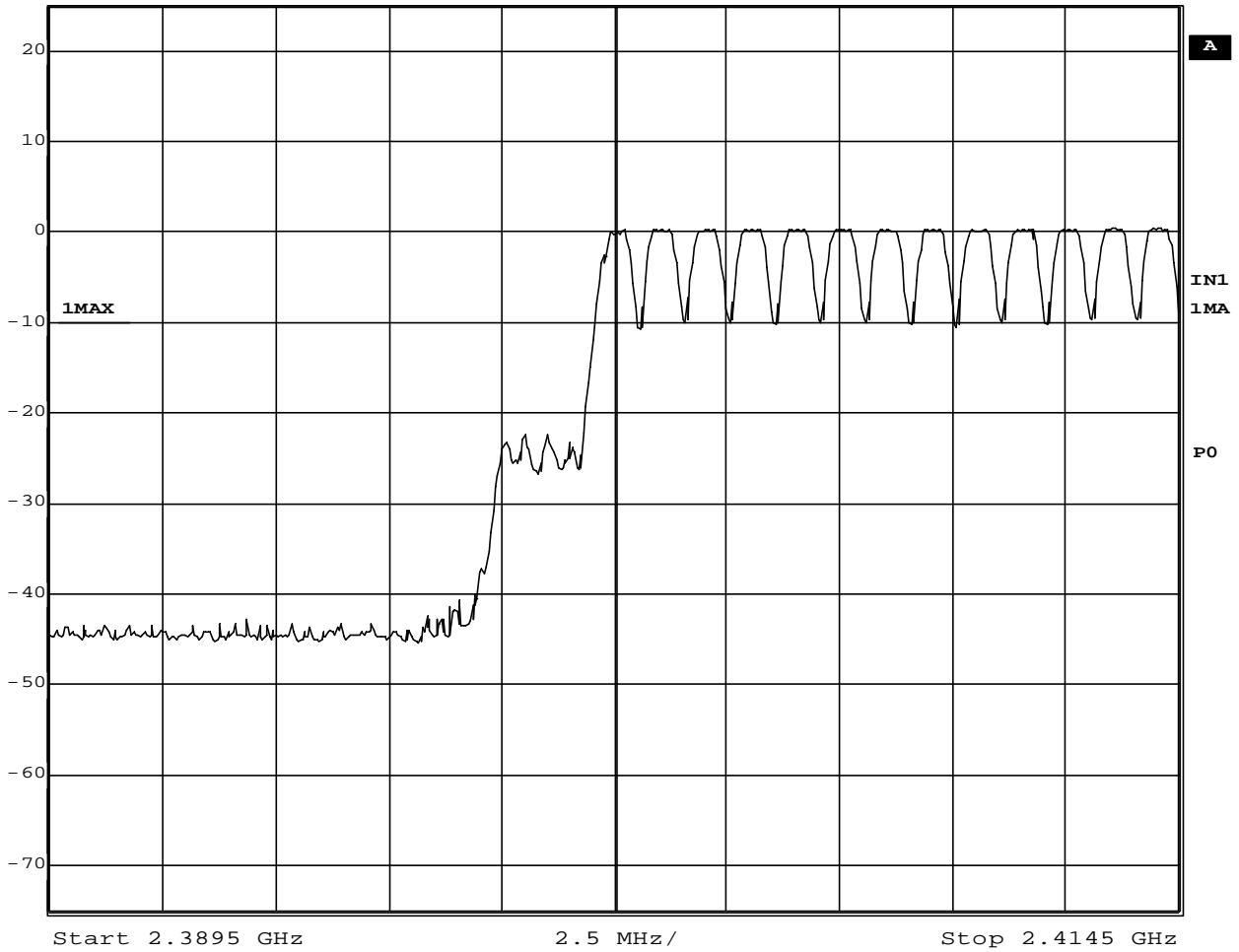

Date: 26.APR.2002 09:38:07

Number of Hopping Frequencies (range 1)



Ref Lvl
25 dBm

RBW 300 kHz RF Att 40 dB
VBW 300 kHz
SWT 5 ms Unit dBm

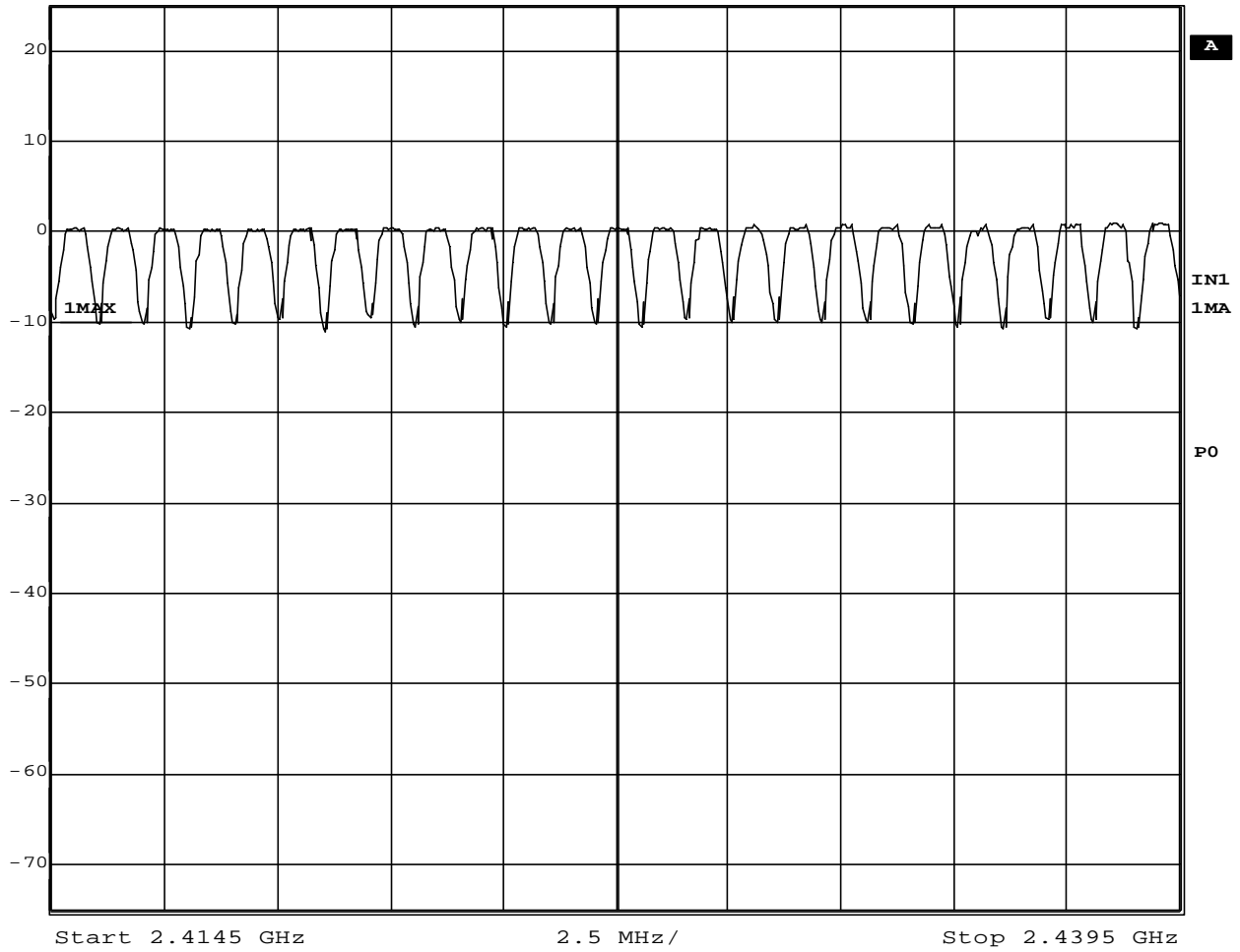

Date: 26.APR.2002 09:40:02

Number of Hopping Frequencies (range 2)



Ref Lvl	Marker 1 [T1]	RBW	300 kHz	RF Att	40 dB
25 dBm	-7.27 dBm	VBW	300 kHz		
	2.46450000 GHz	SWT	5 ms	Unit	dBm

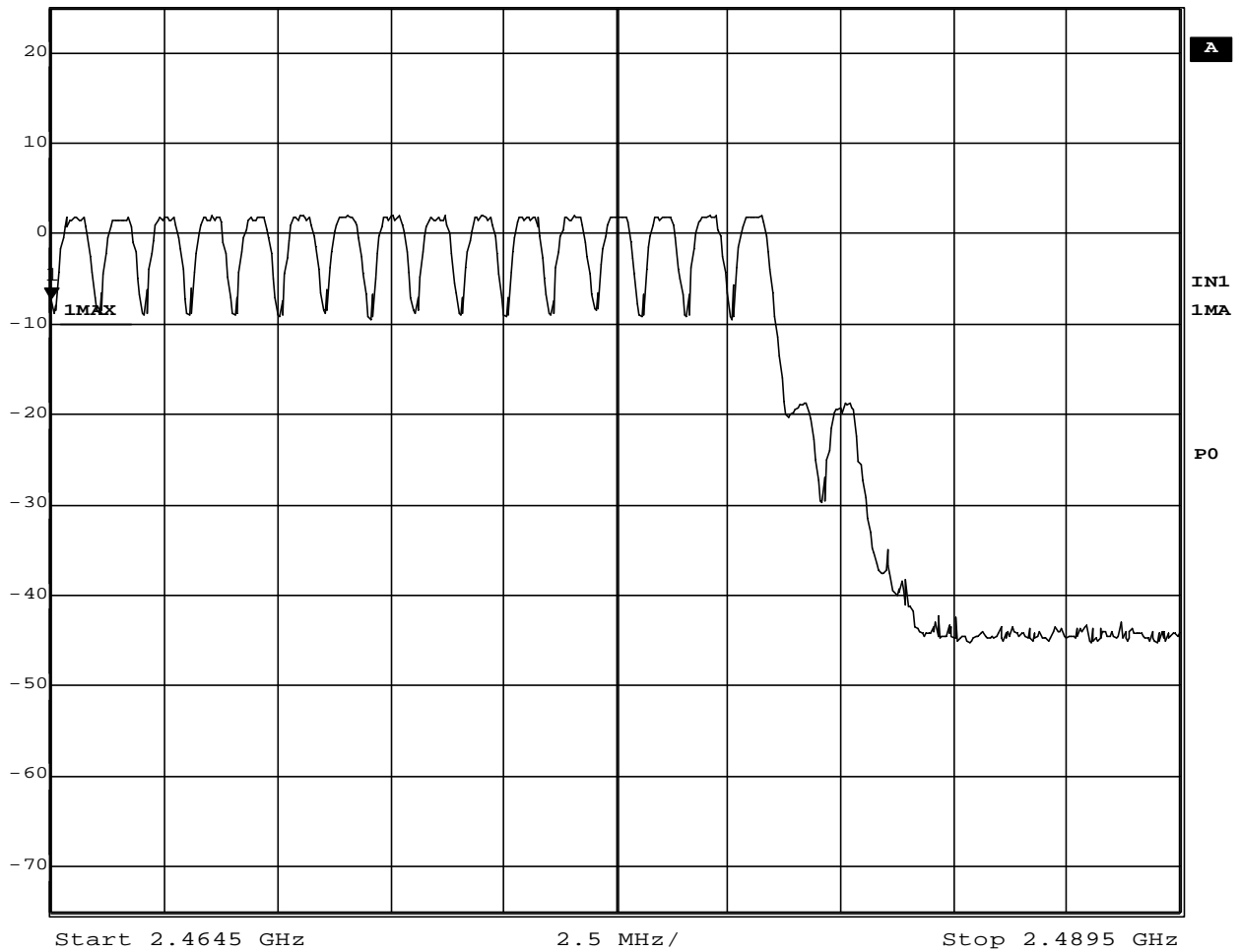

Date: 26.APR.2002 09:42:54

Number of Hopping Frequencies (range 4)

3. 20 dB Bandwidth

3.1 Test Procedure

- The bandwidth at 20 dB below the highest inband spectral density was measured with a spectrum analyzer connected to the antenna terminal, while EUT had its hopping function disabled at the highest, middle and the lowest available channels.
- The spectrum analyzer was set to :
 - Center frequency = the highest, middle and the lowest channels,
 - Span : approximately 2 or 3 times of the 20 dB bandwidth = 2 MHz
 - RBW : 1% of the 20 dB bandwidth or more = 10 kHz
 - VBW : equal to RBW or more = 30 kHz
 - Sweep = auto, Detector function = peak, Trace = max hold
- After the trace being stable. Use the marker-to-peak function to set the marker to the peak of the emission. Use the marker-delta function to measure 20 dB down one side of the emission. Reset the marker-delta function, and move the marker to the other side of the emission, until it is (as close as possible to) even with the reference marker level. The marker-delta reading at this point is the 20 dB bandwidth of the emission.

3.2 Test Instruments and Measurement Setup

Same as the Chapter 1(Table 1-1 & Figure 1).

3.3 Measurement Results

Test Date: April 26, 2002

Table 3. EUT: M/T 2672-4HU, s/n ZZ-00245

	Measured Bandwidth (MHz)	Limit
Tx at the lowest ch. (2402 MHz)*1	0.73	1 MHz
Tx at the middle ch.(2441 MHz)*1	0.73	
Tx at the highest ch.(2480 MHz)*1	0.72	
Inquiry	0.62	
Paging	0.66	

*1 : In line with Section 15.31(m) of Public Notice DA 00-705 dated March 30, 2000, the measurement was performed at the highest, middle and lowest available channels.

3.4 Trace Data

	Marker 1 [T1]	RBW	10 kHz	RF Att	40 dB
	Ref Lvl	-3.17 dBm	VBW	30 kHz	
	25 dBm	2.40205411 GHz	SWT	50 ms	Unit

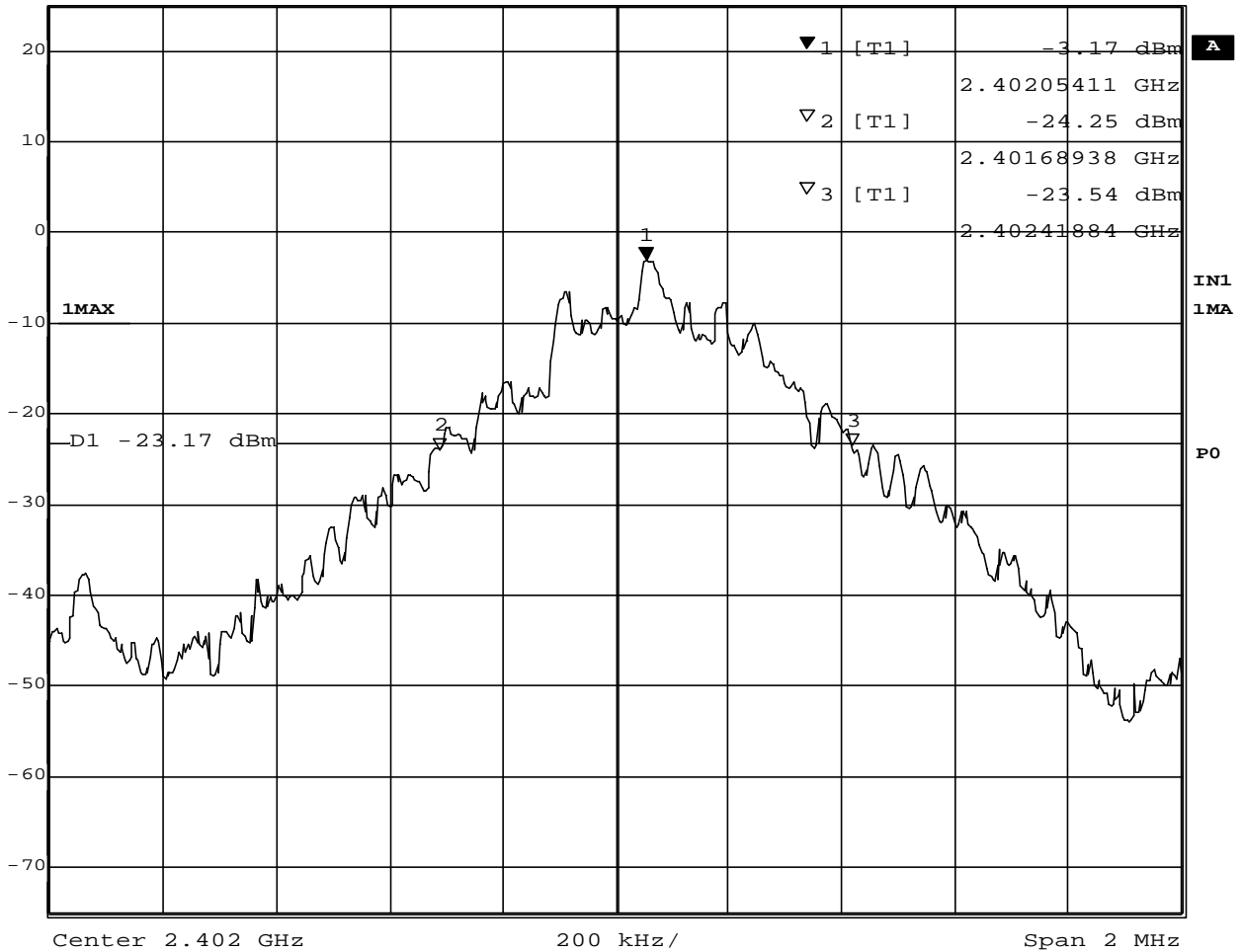

Date: 26.APR.2002 10:43:33

20 dB Bandwidth (TX on 2402MHz)



Marker 1 [T1]	RBW	10 kHz	RF Att	40 dB
Ref Lvl	-2.64 dBm	VBW	30 kHz	
25 dBm	2.44106212 GHz	SWT	50 ms	Unit dBm

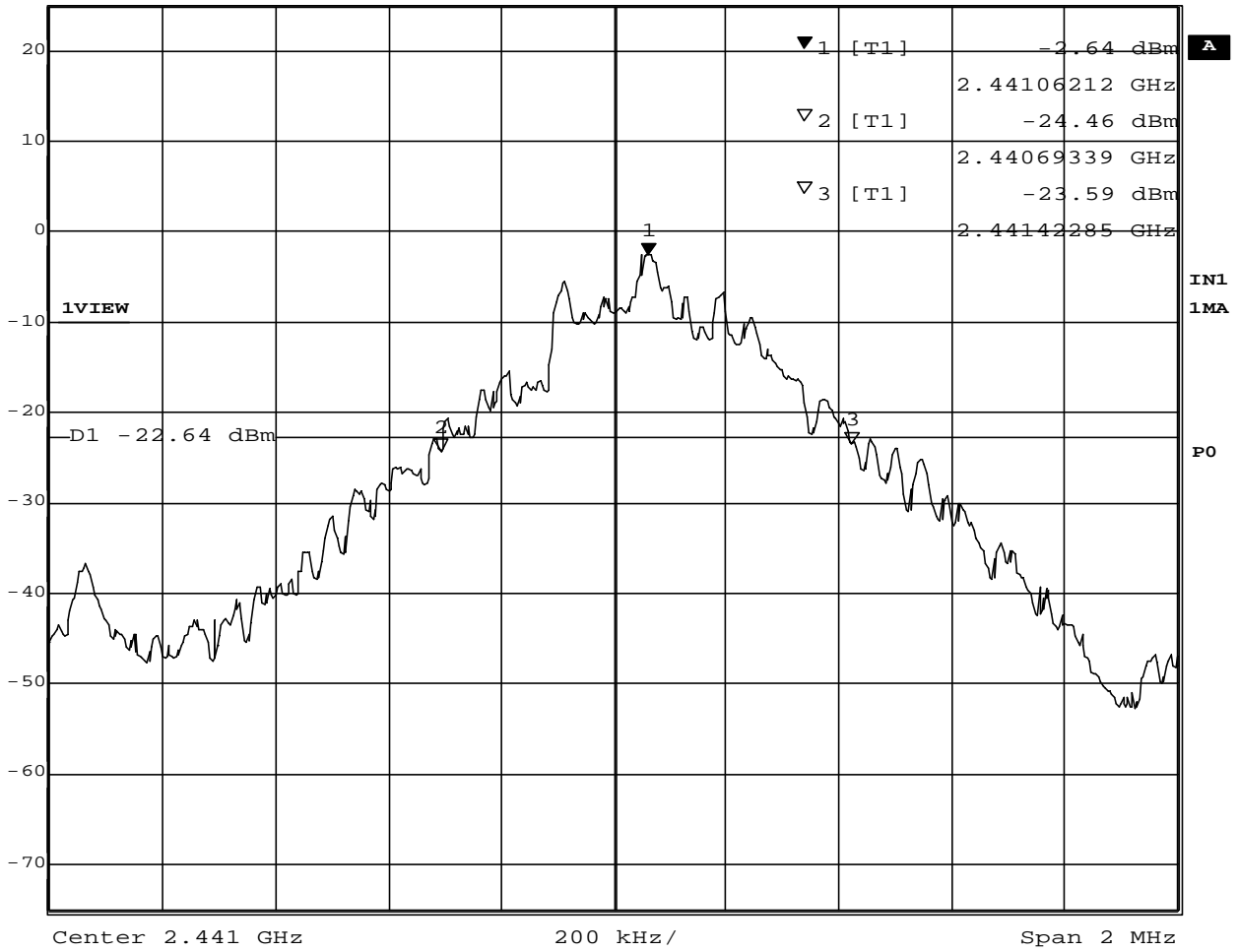

Date: 26.APR.2002 10:46:40

20 dB Bandwidth (TX on 2441MHz)



Ref Lvl	Marker 1 [T1]	RBW	10 kHz	RF Att	40 dB
25 dBm	-1.60 dBm	VBW	30 kHz		
	2.48005812 GHz	SWT	50 ms	Unit	dBm

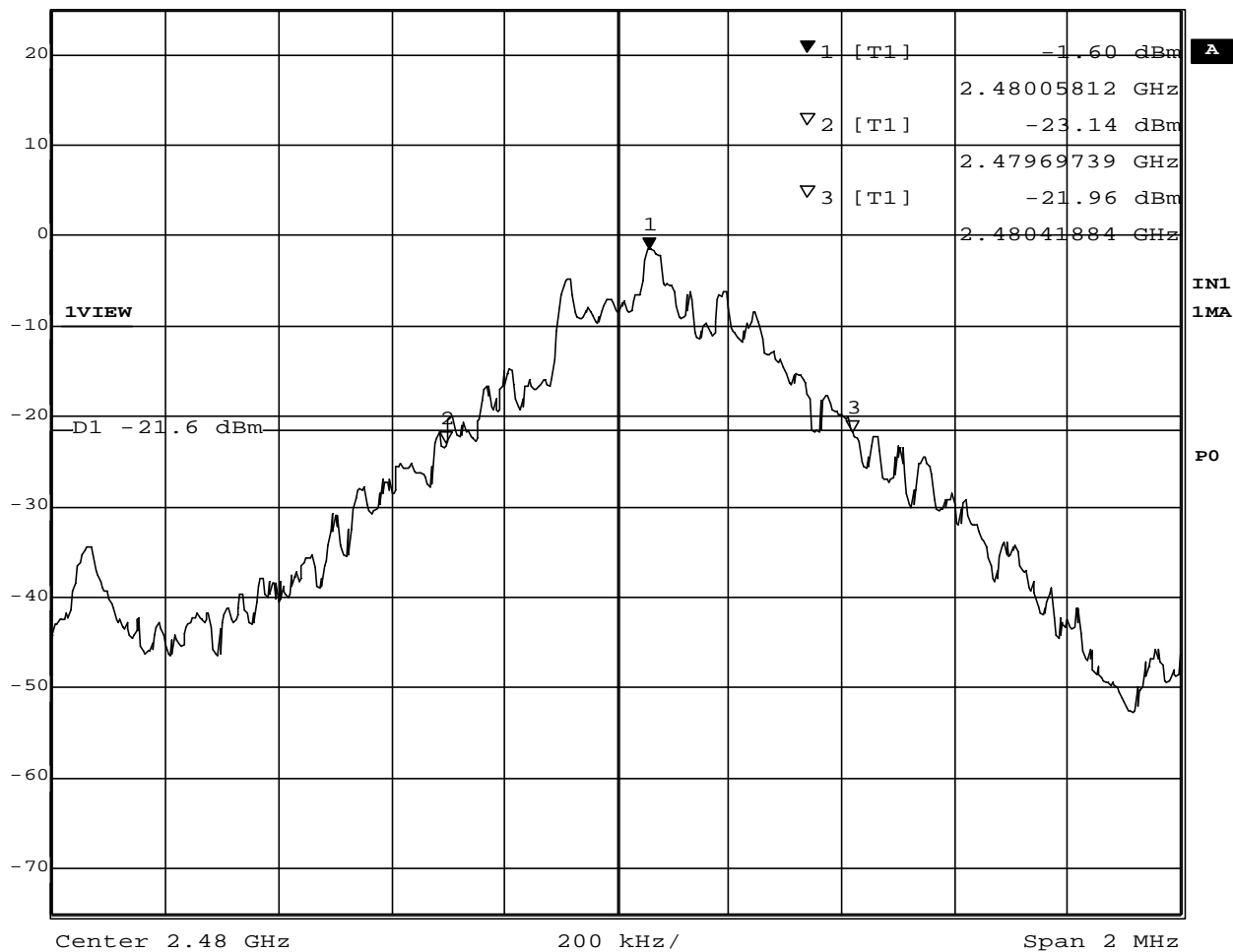

Date: 26.APR.2002 10:49:27

20 dB Bandwidth (TX on 2480MHz)



Ref Lvl	Marker 1 [T1]	RBW	10 kHz	RF Att	40 dB
25 dBm	-2.93 dBm	VBW	30 kHz		
	2.44107014 GHz	SWT	50 ms	Unit	dBm

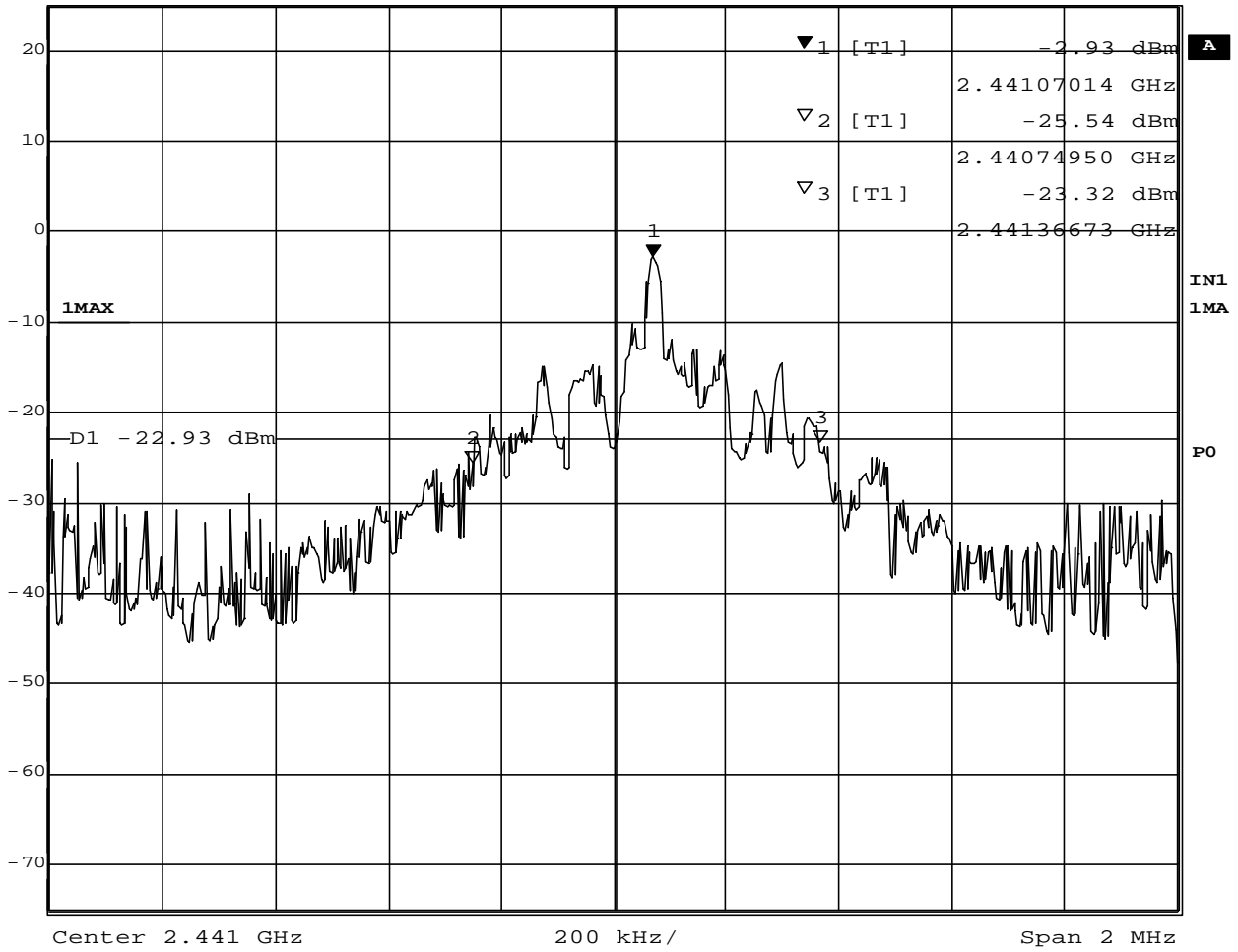

Date: 26.APR.2002 09:49:51

20 dB Bandwidth (Inquiry)



Ref Lvl	Marker 1 [T1]	RBW	10 kHz	RF Att	40 dB
25 dBm	-3.18 dBm	VBW	30 kHz		
	2.44209820 GHz	SWT	50 ms	Unit	dBm

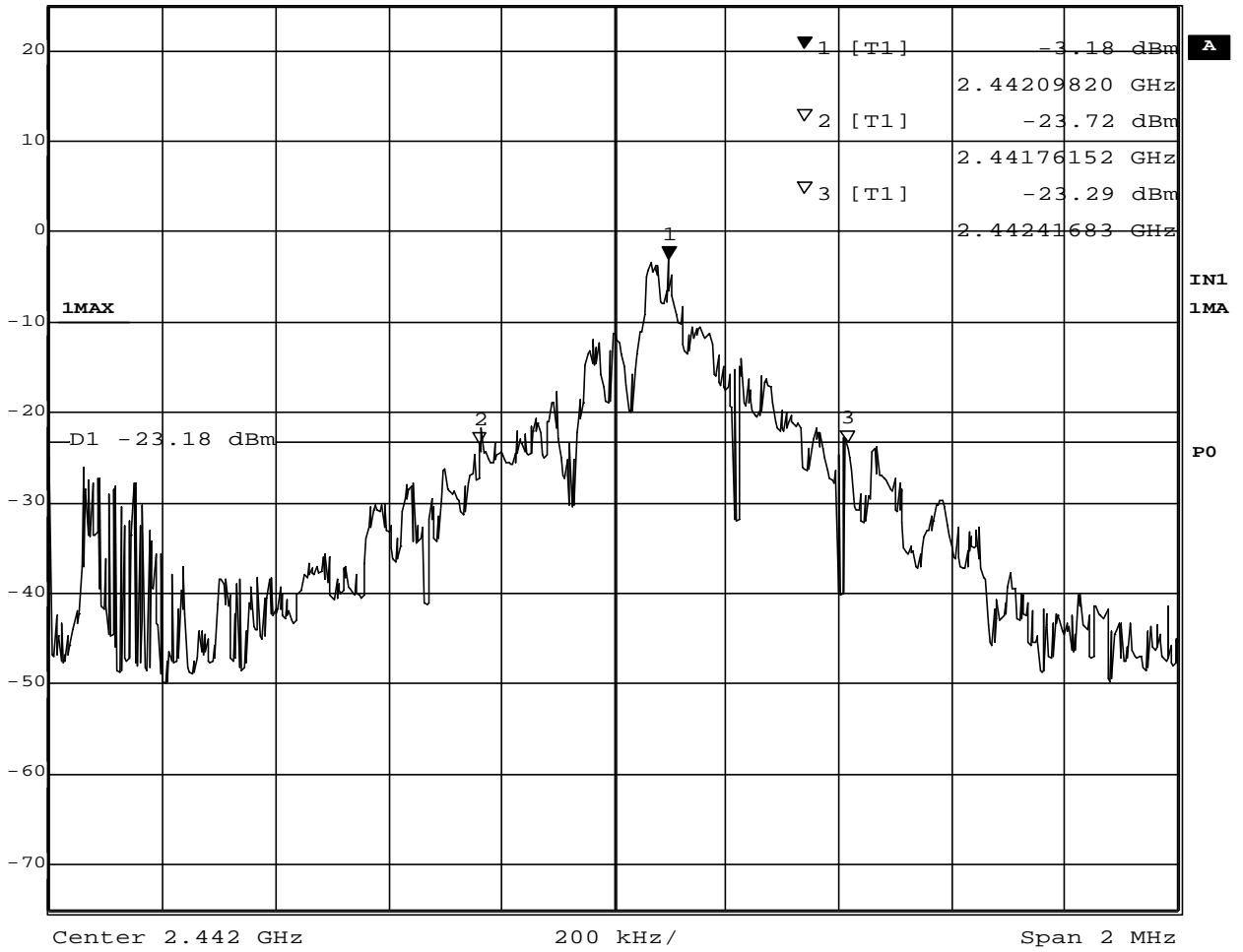

Date: 26.APR.2002 09:54:55

20 dB Bandwidth (Paging)

4. Time of Occupancy (Dwell Time)

4.1 Test Procedure

- The dwell time was measured with a spectrum analyzer connected to the antenna terminal, while EUT had its hopping function enabled.
- The spectrum analyzer was set to :
 - Center Frequency: 2441MHz (for Inquiry / Data Transmission), 2442MHz (for Paging)
 - RBW = 500 kHz, VBW = 500 kHz (= RBW or more), Span = zero,
 - Detector function = peak, Trace = max hold,
 - Sweep : Inquiry ; 300 μ s for Burst duration, 100 ms for Repetition rate
 - Paging ; 300 μ s for Burst duration, 100 ms for Repetition rate
 - Data transmission ; 1 ms for Burst duration, 500 ms for Repetition rate

4.2 Test Instruments and Measurement Setup

Same as the Chapter 1(Table 1-1 & Figure 1).

4.3 Measurement Results

Test Date: April 26, 2002

Table 4. EUT: M/T 2672-4HU, s/n ZZ-00245

Hopping phase	Burst duration in one hop (μ s) *1	Repetition rate on one channel *2	Dwell Time (mS) *1 \times *2	Limit
Inquiry	161.73	1280	207.01	less than 400 mS in 12.8 ^{*3} seconds period
Paging	162.93	640	104.28	
Data transmission	486.97	300	146.09	less than 400 mS in 30 seconds period

*1 : attached measurement plot

*2 : - (number of hops in measurement plot) \times 12800 ms / 100 ms for Inquiry/Paging
 - (number of hops in measurement plot) \times 30000 ms / 500 ms for Data transmission

*3 : 32 hops (Bluetooth Standard) \times 0.4sec

4.4 Trace Data

	Marker 1 [T1]	RBW	500 kHz	RF Att	40 dB
	Ref Lvl	-45.49 dBm	VBW	500 kHz	
	25 dBm	9.619238 μ s	SWT	300 μ s	Unit

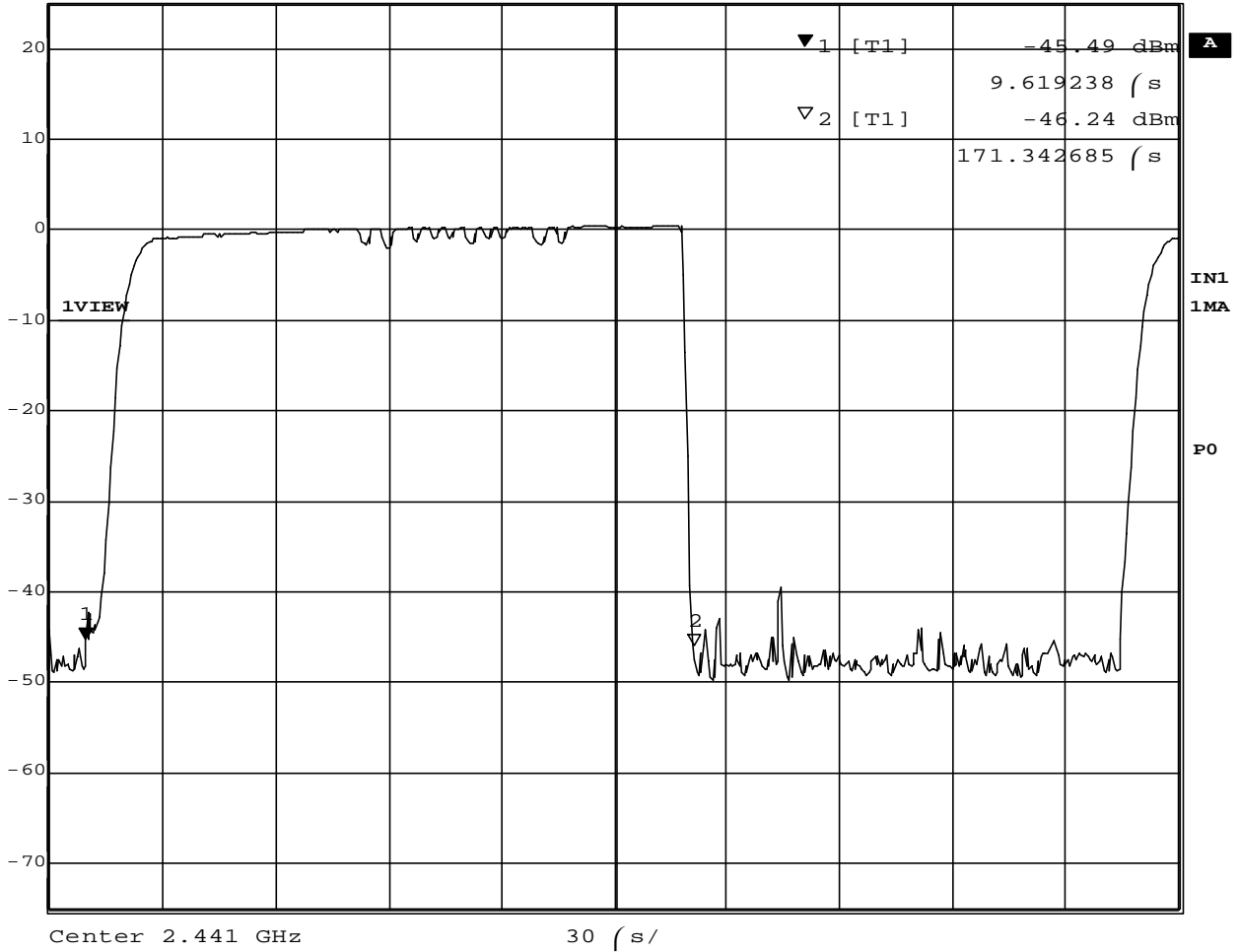

Date: 26.APR.2002 10:04:30

Time of Occupancy (Inquiry, Burst duration)



Ref Lvl
25 dBm

RBW	500 kHz	RF Att	40 dB
VBW	500 kHz		
SWT	100 ms	Unit	dBm

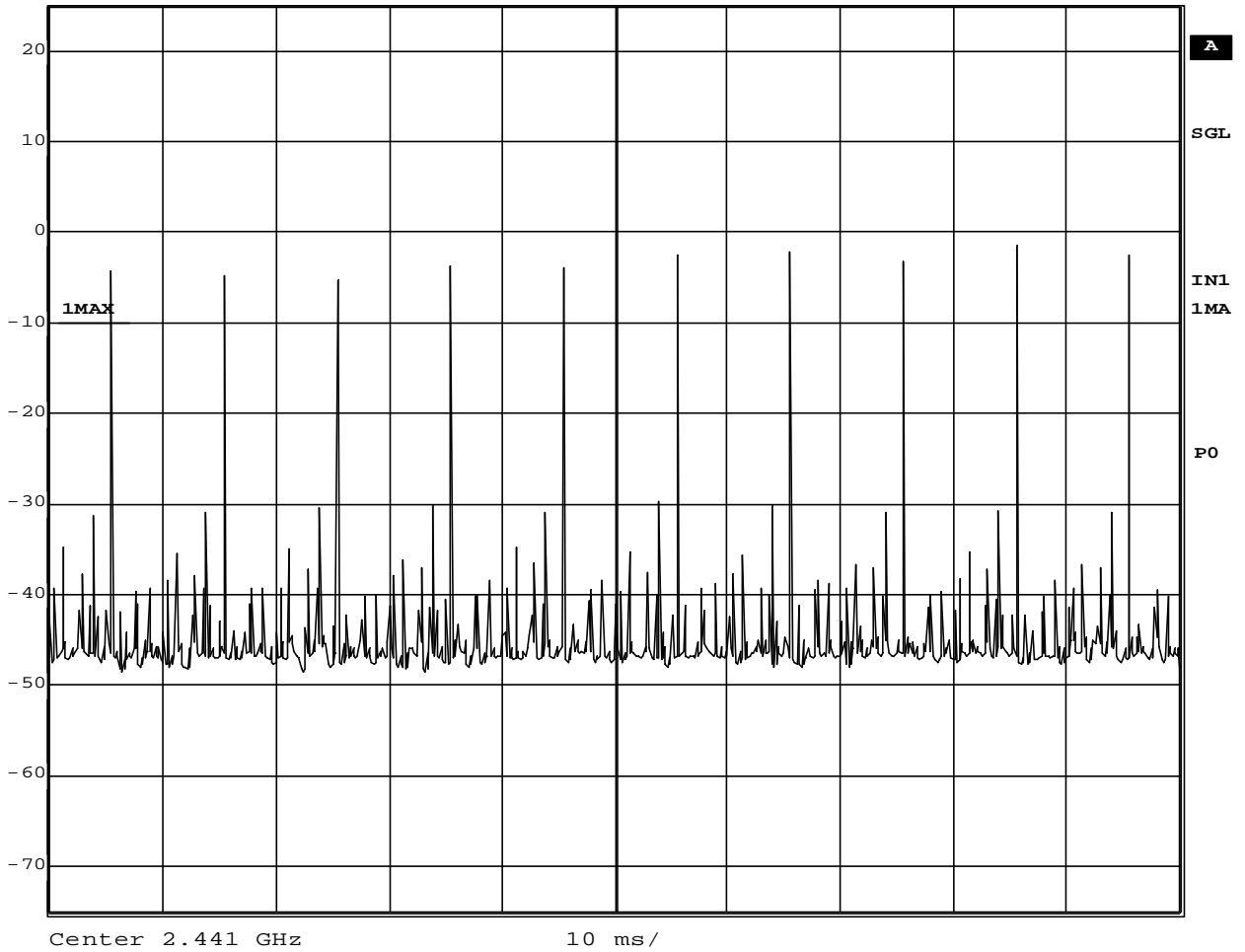

Date: 26.APR.2002 10:07:37

Time of Occupancy (Inquiry, Repetition rate)



Ref Lvl	Marker 1 [T1]	RBW	500 kHz	RF Att	40 dB
25 dBm	-44.95 dBm	VBW	500 kHz		
	116.633267 μ s	SWT	300 μ s	Unit	dBm

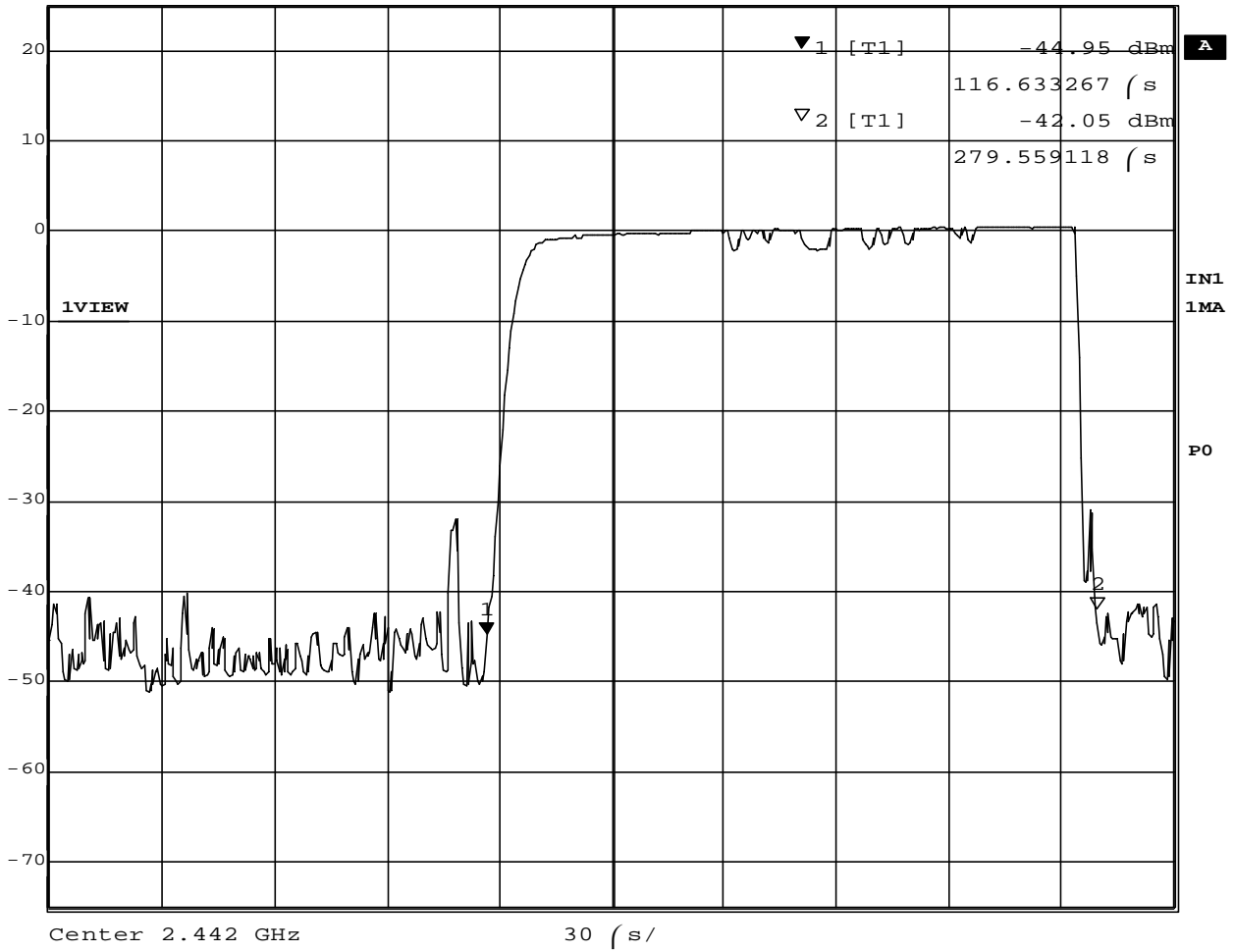

Date: 26.APR.2002 10:13:20

Time of Occupancy (Paging, Burst duration)



Ref Lvl
25 dBm

RBW 500 kHz RF Att 40 dB
VBW 500 kHz
SWT 100 ms Unit dBm

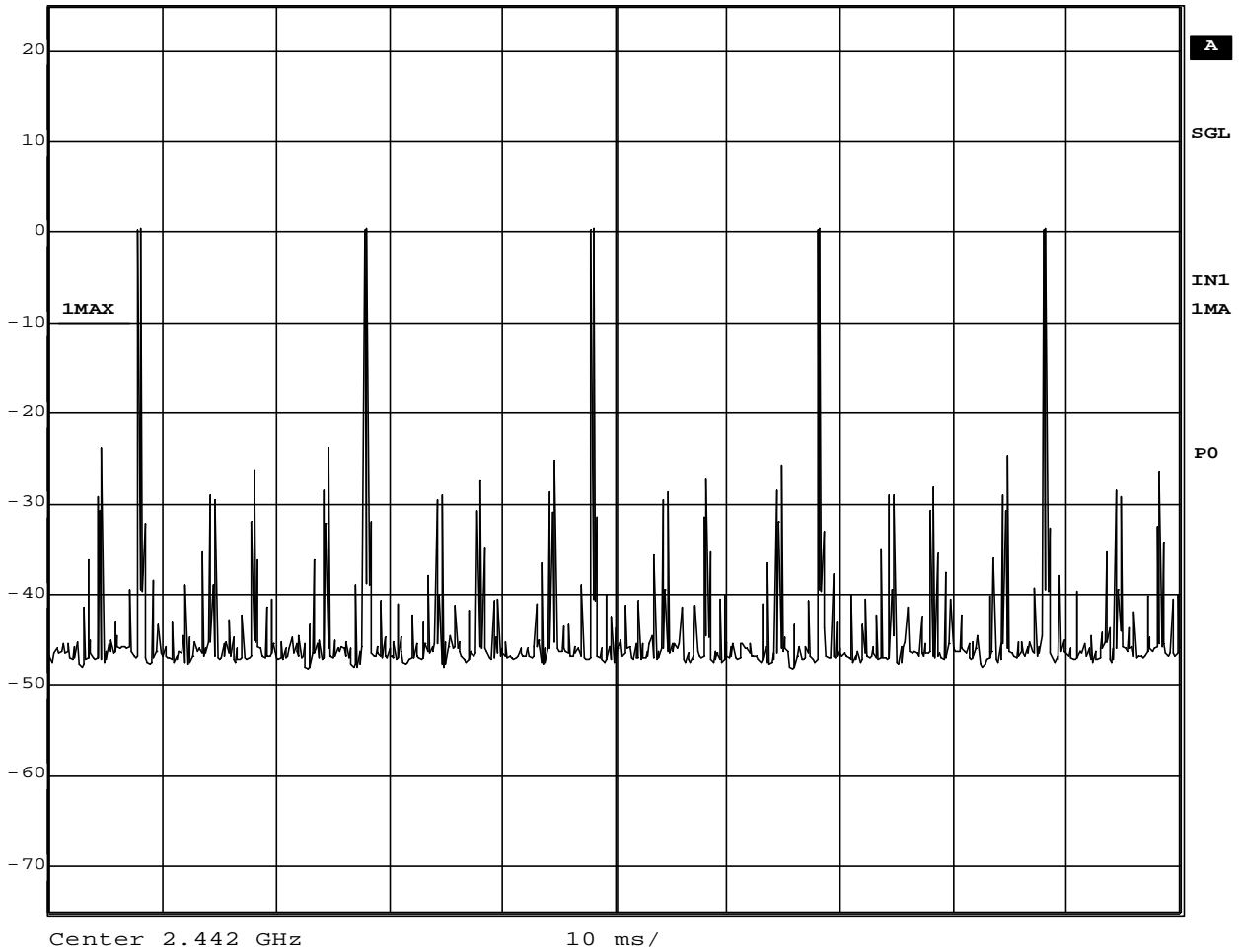

Date: 26.APR.2002 10:14:25

Time of Occupancy (Paging, Repetition rate)



Ref Lvl	Marker 1 [T1]	RBW	500 kHz	RF Att	40 dB
25 dBm	-47.39 dBm	VBW	500 kHz		
	272.545090 (s	SWT	1 ms	Unit	dBm

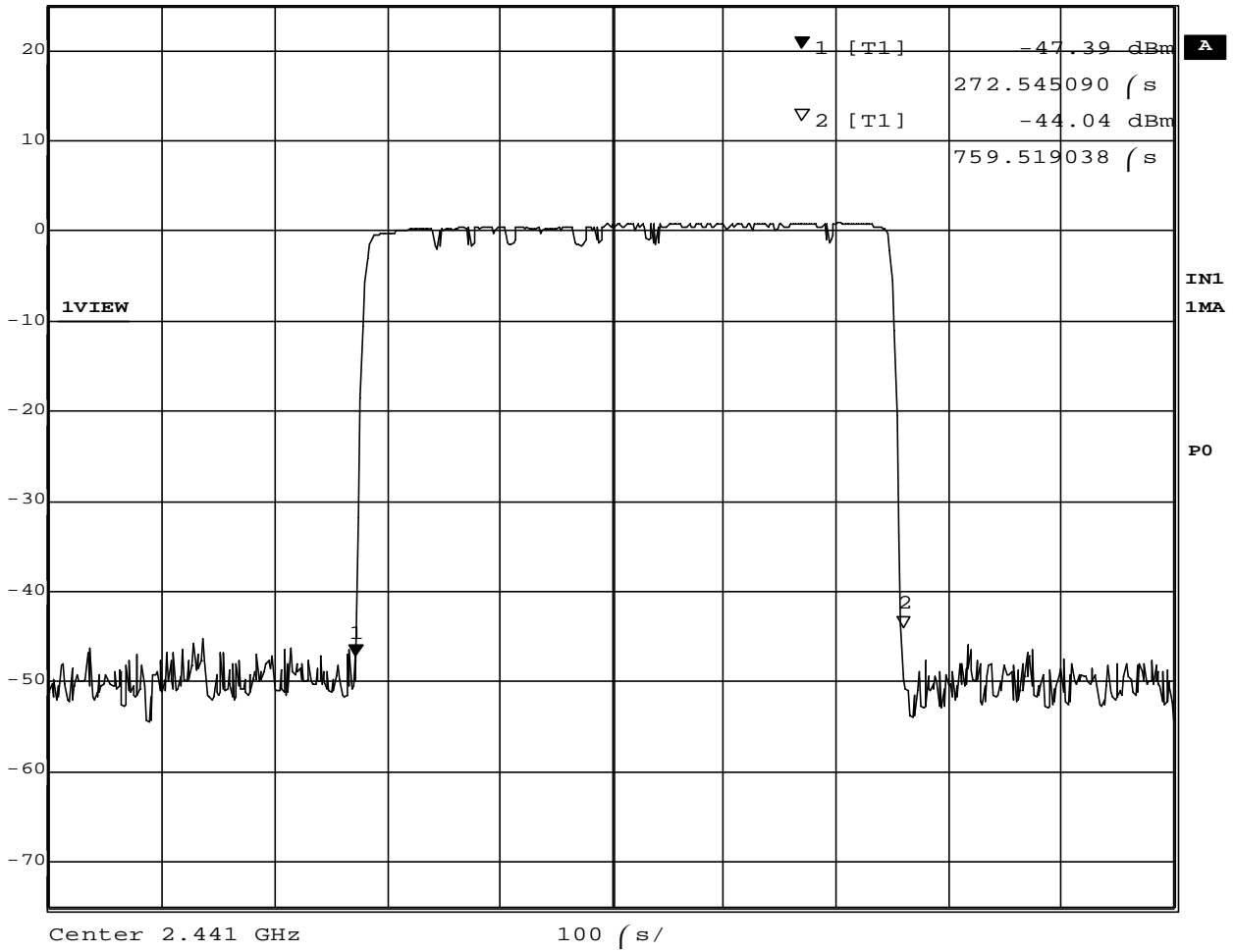

Date: 26.APR.2002 10:35:49

Time of Occupancy (Data transmission, Burst duration)



Ref Lvl
25 dBm

RBW 500 kHz RF Att 40 dB
VBW 500 kHz
SWT 500 ms Unit dBm

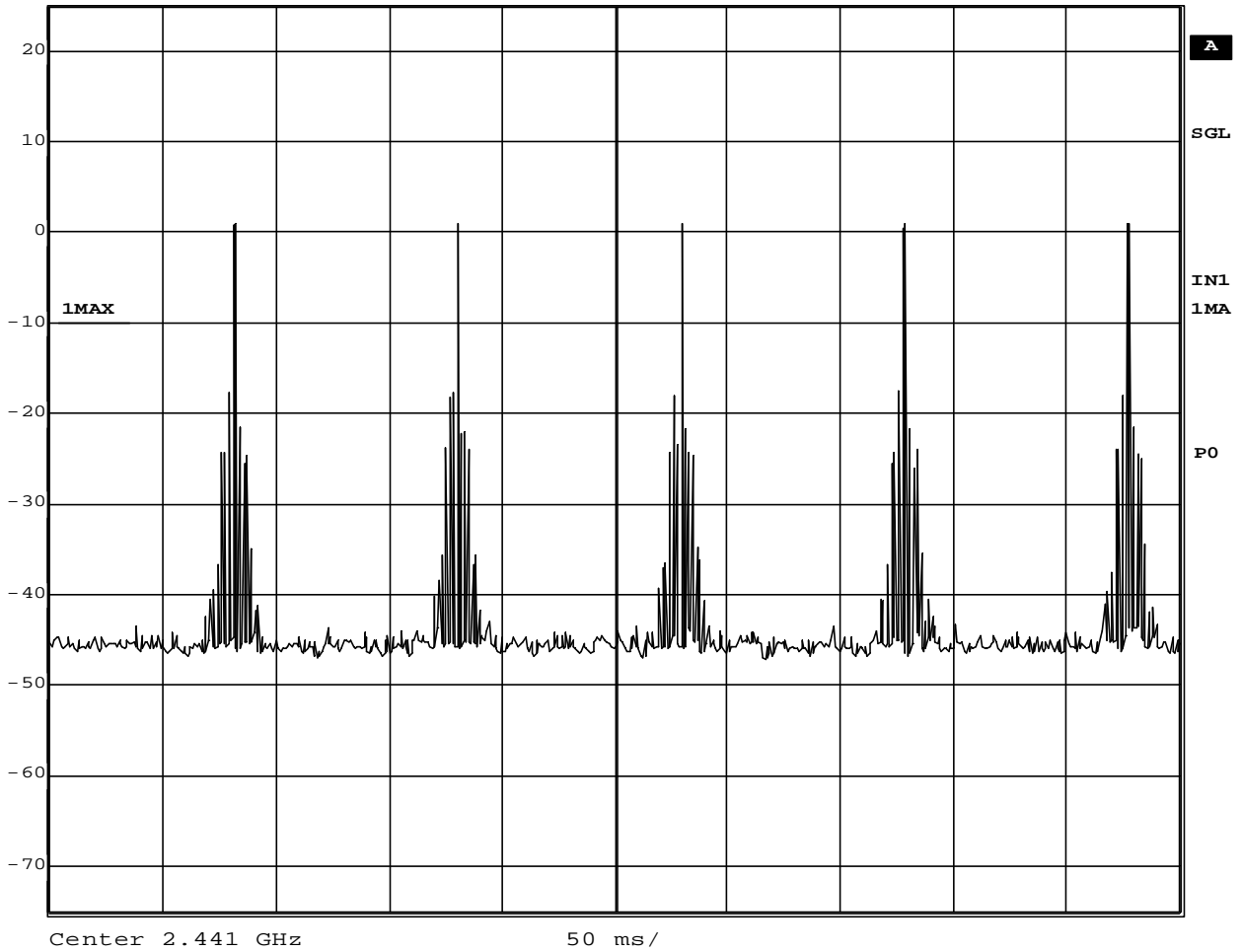

Date: 26.APR.2002 10:36:40

Time of Occupancy (Data transmission, Repetition rate)

5. Peak Output Power

5.1 Test Procedure

- The peak output power is measured with a spectrum analyzer connected to the antenna terminal, while EUT had its hopping function disabled at the highest, middle and the lowest available channels.
- The spectrum analyzer is set to :
 - Center frequency = the highest, middle and the lowest channels,
 - Span : approximately 5 times of the 20 dB bandwidth = 5 MHz (3 MHz for Inquiry/Paging)
 - RBW : greater than the 20 dB bandwidth of the emission being measured = 1 MHz
 - VBW : equal to RBW or more = 3 MHz
 - Sweep = auto, Detector function = peak, Trace = max hold
- Allow the trace to stabilize. Use the marker-to-peak function to set the marker to the peak of the emission. The indicated level is the peak output power.

5.2 Test Instruments and Measurement Setup

Same as the Chapter 1(Table 1-1 & Figure 1).

5.3 Measurement Results

Test Date: April 26, 2002

Table 5. EUT: M/T 2672-4HU, s/n ZZ-00245

Measured Frequency (MHz)	Analyzer Reading (dBm)	Cable Loss (dB)	Results		Limit [1W] (dBm)	Margin (dB)
			(dBm)	(W)		
2402 (ch. 1) *1	0.08	1.7	1.8	0.00151	30.0	28.2
2441 (ch. 40) *1	0.90	1.7	2.6	0.00182	30.0	27.4
2480 (ch. 79) *1	1.94	1.7	3.6	0.00229	30.0	26.4
Inquiry (ch. 40)	0.53	1.7	2.2	0.00166	30.0	27.8
Paging (ch. 41)	0.59	1.7	2.3	0.00170	30.0	27.7

*1 : In line with Section 15.31(m) of Public Notice DA 00-705 dated March 30, 2000, the measurement was performed at the highest, middle and lowest available channels.

5.4 Trace Data

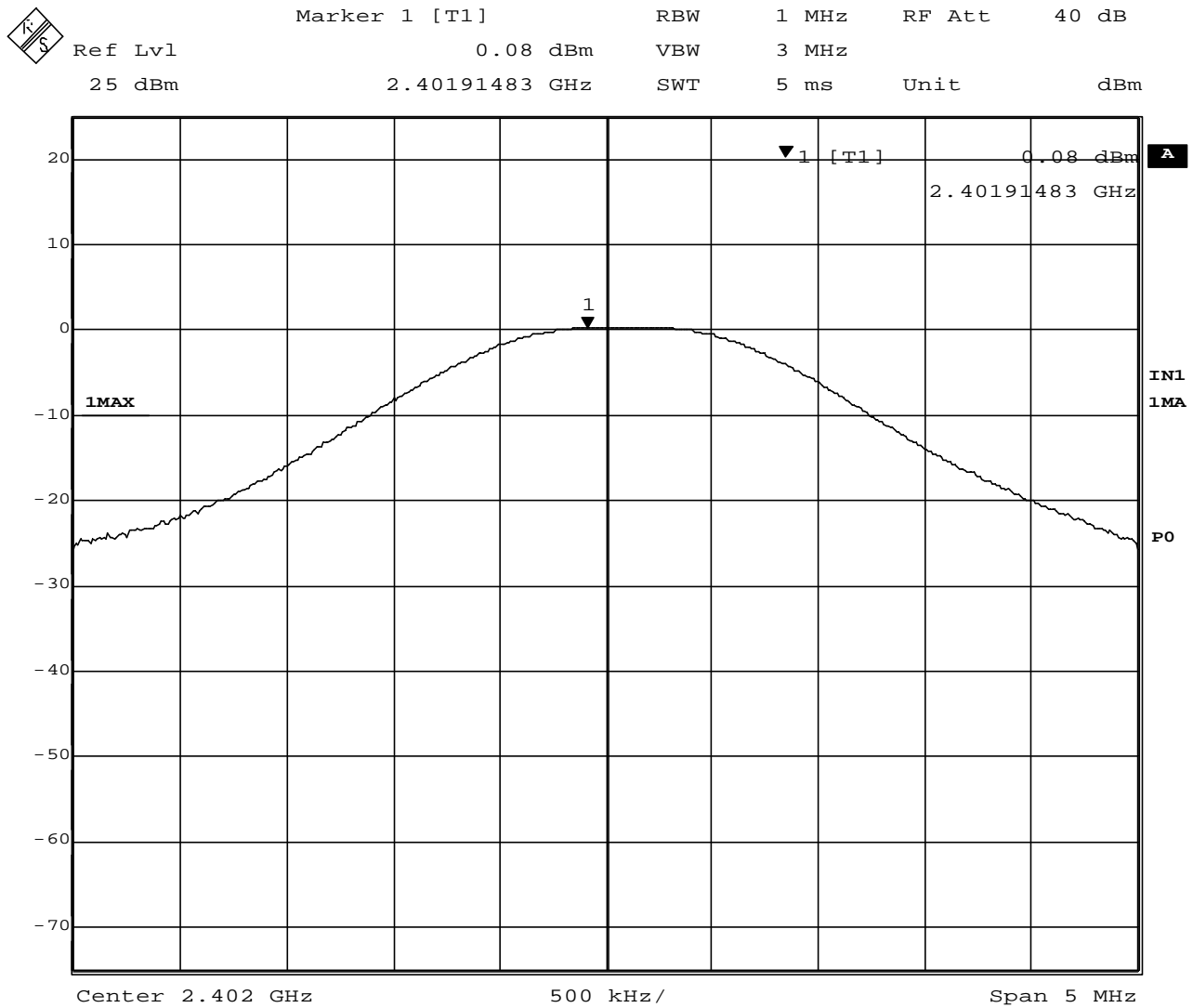

Date: 26.APR.2002 10:52:09

Peak Output Power (TX on 2402MHz)



Ref Lvl	Marker 1 [T1]	RBW	1 MHz	RF Att	40 dB
25 dBm	0.90 dBm	VBW	3 MHz		
	2.44122545 GHz	SWT	5 ms	Unit	dBm

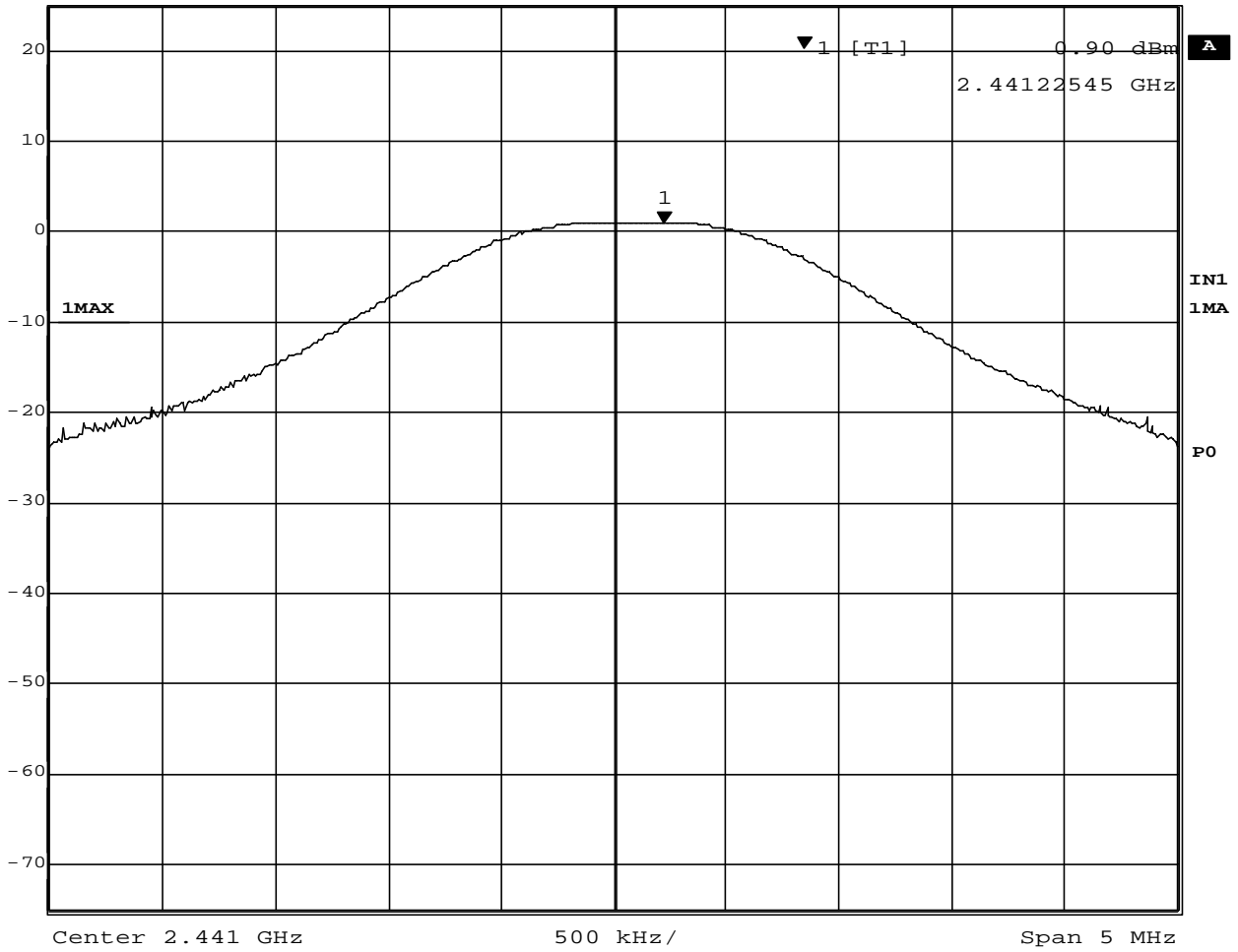

Date: 26.APR.2002 10:58:41

Peak Output Power (TX on 2441MHz)



Ref Lvl	Marker 1 [T1]	RBW	1 MHz	RF Att	40 dB
25 dBm	1.94 dBm	VBW	3 MHz		
	2.48004509 GHz	SWT	5 ms	Unit	dBm

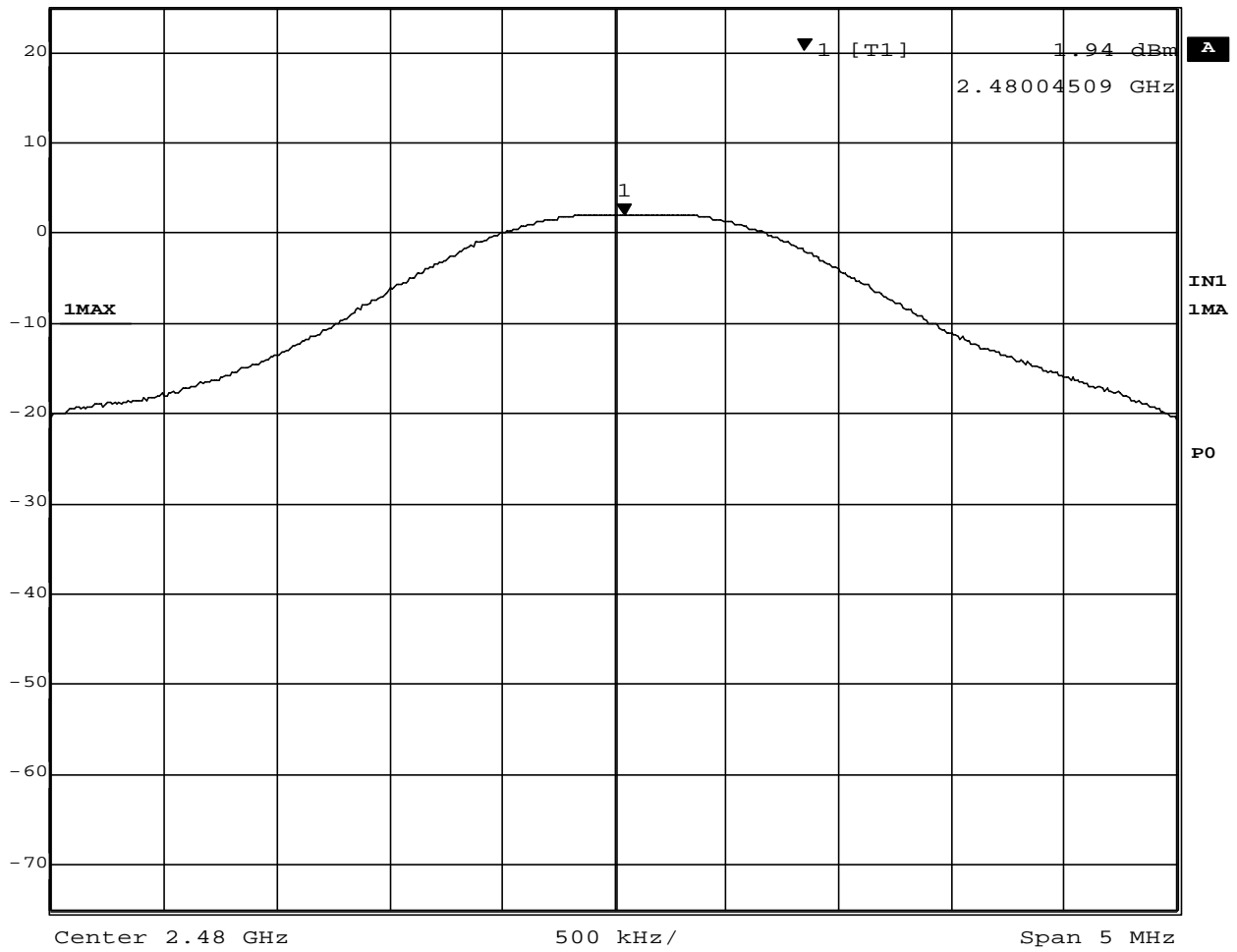

Date: 26.APR.2002 10:59:29

Peak Output Power (TX on 2480MHz)



Ref Lvl	Marker 1 [T1]	RBW	1 MHz	RF Att	40 dB
25 dBm	0.53 dBm	VBW	3 MHz		
	2.44087675 GHz	SWT	5 ms	Unit	dBm

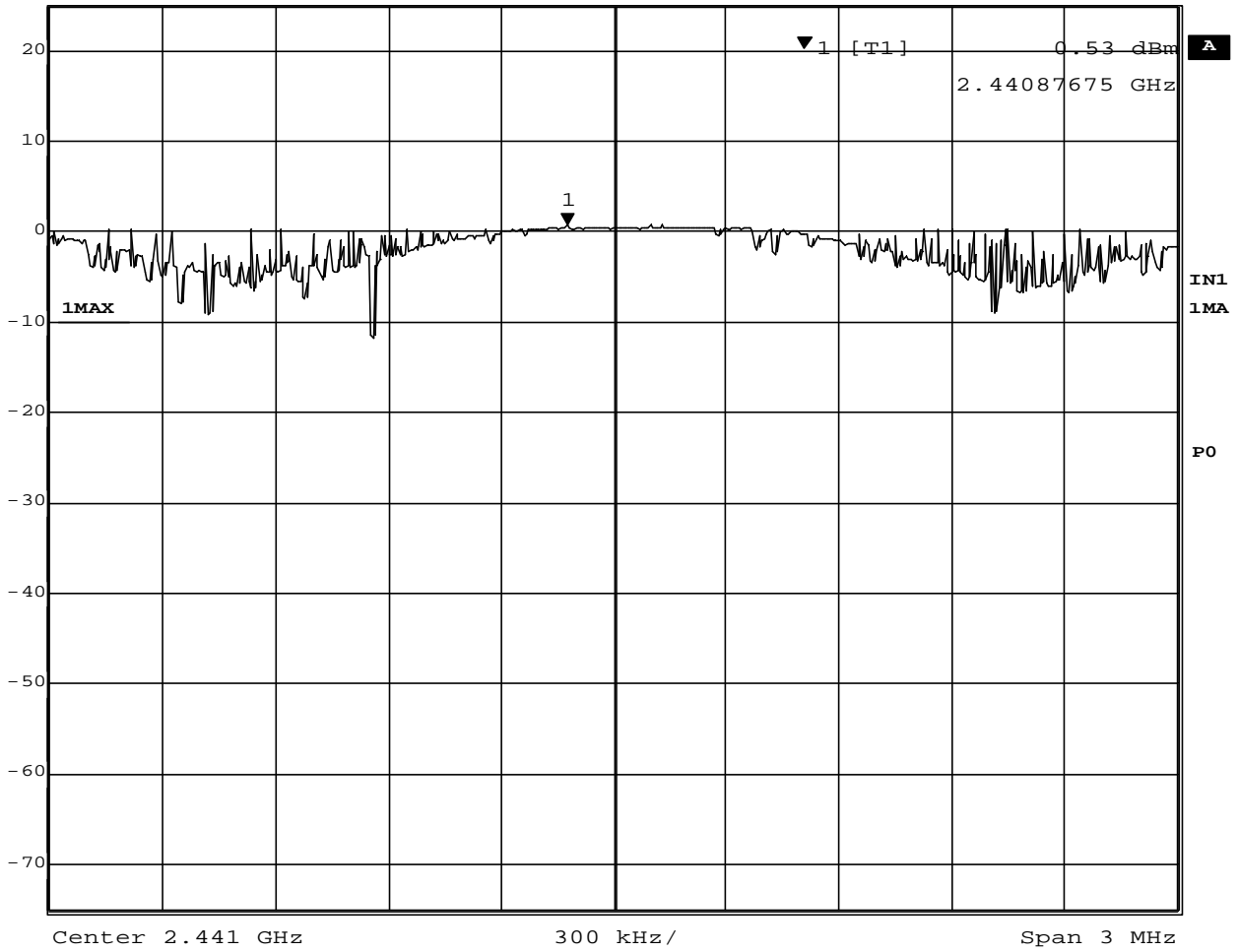

Date: 26.APR.2002 10:31:00

Peak Output Power (Inquiry)



Marker 1 [T1]	RBW	1 MHz	RF Att	40 dB
Ref Lvl	0.59 dBm	VBW	3 MHz	
25 dBm	2.44205110 GHz	SWT	5 ms	Unit dBm

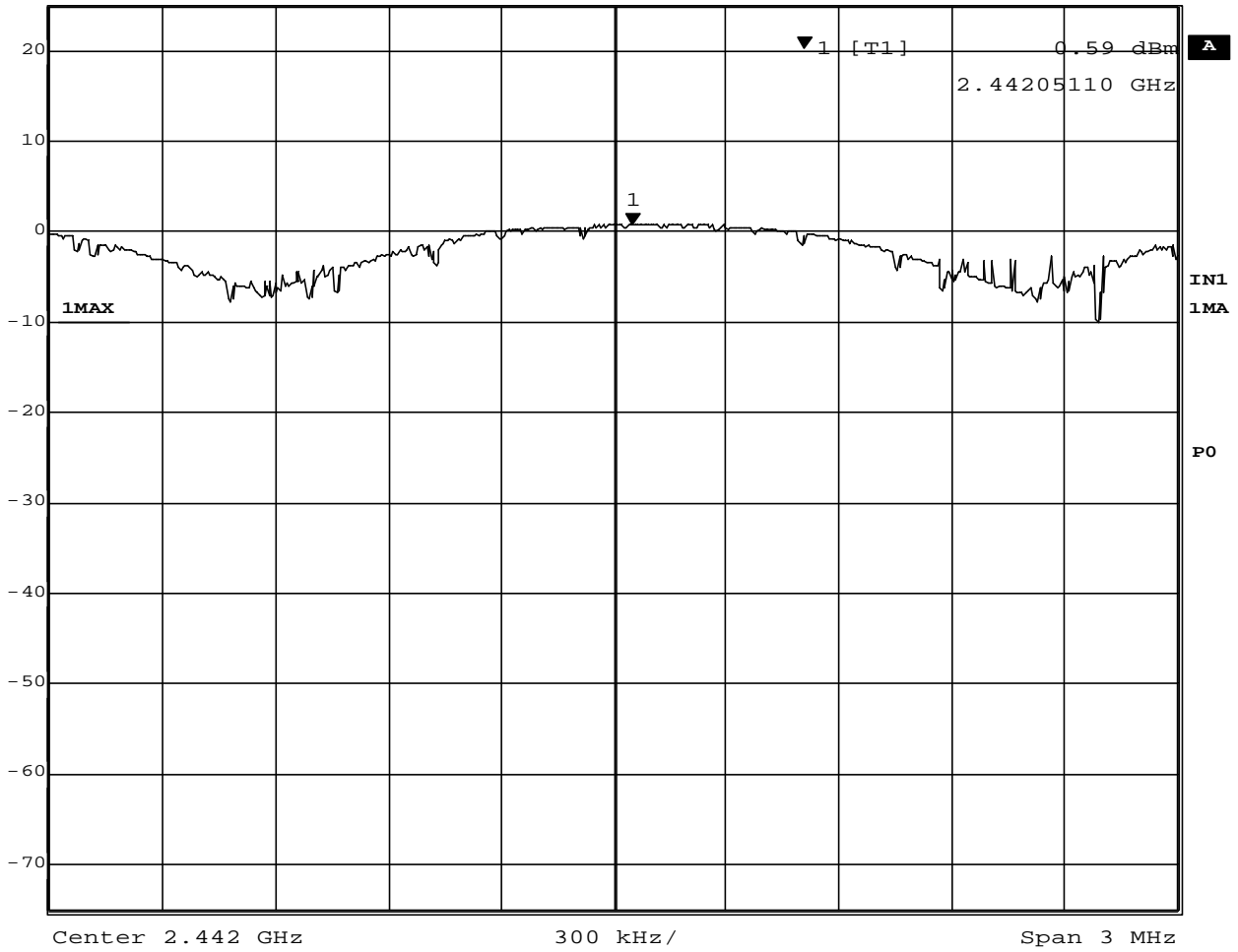

Date: 26.APR.2002 10:23:23

Peak Output Power (Paging)

6. Band-edge (at 20 dB blow)

6.1 Test Procedure

- The bandwidth at 20 dB down from the highest inband spectral density is measured with a spectrum analyzer connected to the antenna terminal, while EUT had its hopping function disabled at the highest, middle and the lowest available channels.
- The spectrum analyzer is set to :
 - Center frequency = the highest, middle and the lowest channels,
 - Span = 3 MHz
 - RBW : 1% of span or more = 30 kHz
 - VBW : equal to RBW or more = 30 kHz
 - Sweep = auto, Detector function = peak, Trace = max hold
- After the trace being stable. Use the marker-to-peak function to set the marker to the peak of the emission. Use the marker-delta function to measure 20 dB down both sides of the intentional emission.

6.2 Test Instruments and Measurement Setup

Same as the Chapter 1(Table 1-1 & Figure 1).

6.3 Measurement Results

Test Date: April 26, 2002

Table 6. EUT: M/T 2672-4HU, s/n ZZ-00245

Center Frequency (MHz)	Lower Frequency (MHz)	Upper Frequency (MHz)	20dB Occupied BW (MHz)	Margin to Lower limit (MHz)	Margin to Upper limit (MHz)
2402 (ch. 1)	2401.690	2402.472	0.782	1.690	
2441 (ch. 40)	2440.690	2441.442	0.752		
2480 (ch. 79)	2479.696	2480.442	0.746		3.058

Note) In line with Section 15.31(m) of Public Notice DA 00-705 dated March 30, 2000, the measurement was performed at the highest, middle and lowest available channels.

6.4 Trace Data

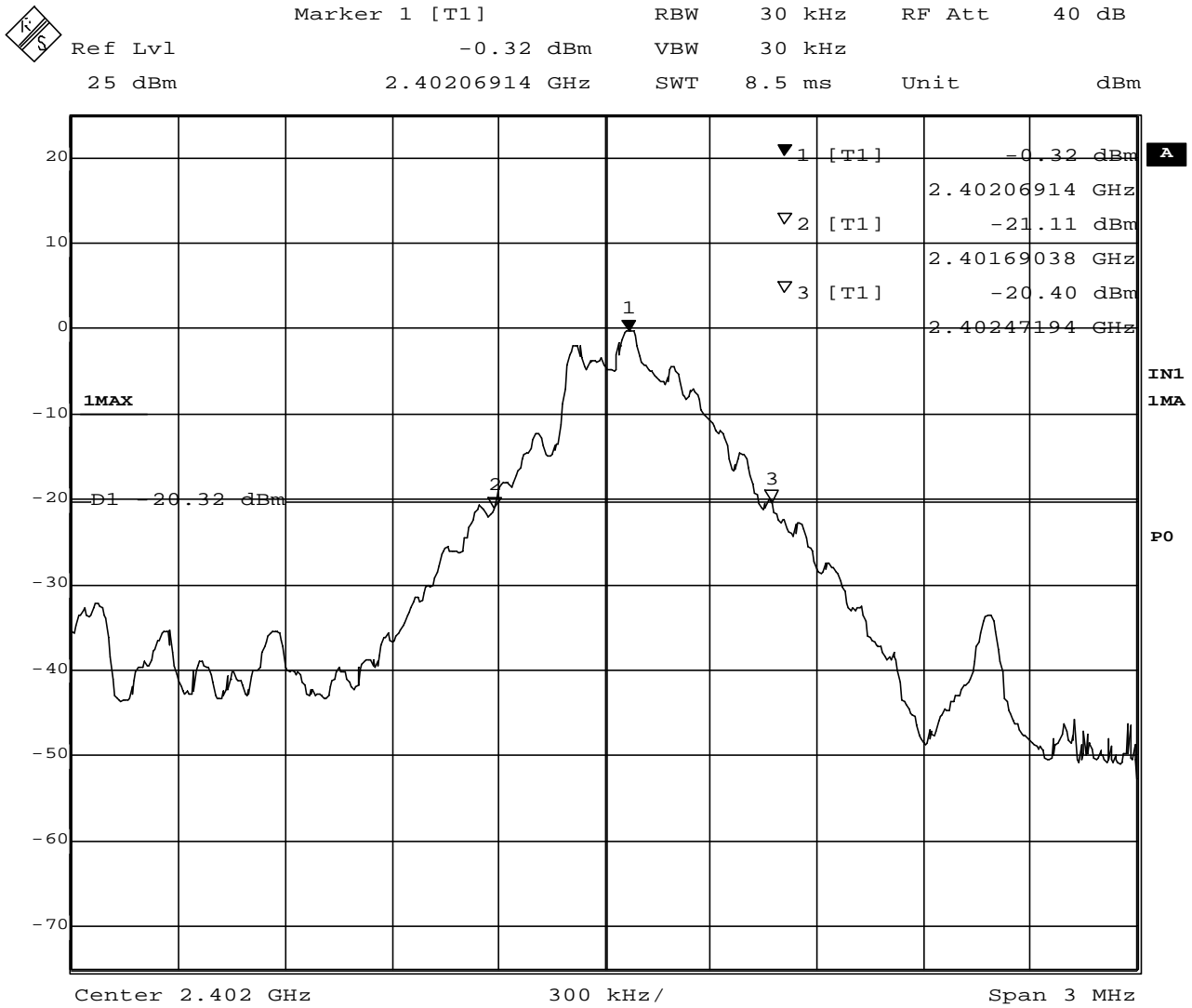

Date: 26.APR.2002 11:03:23

Band-edge (TX on 2402MHz)



Marker 1 [T1]	RBW	30 kHz	RF Att	40 dB
Ref Lvl	0.47 dBm	VBW	30 kHz	
25 dBm	2.44106914 GHz	SWT	8.5 ms	Unit dBm

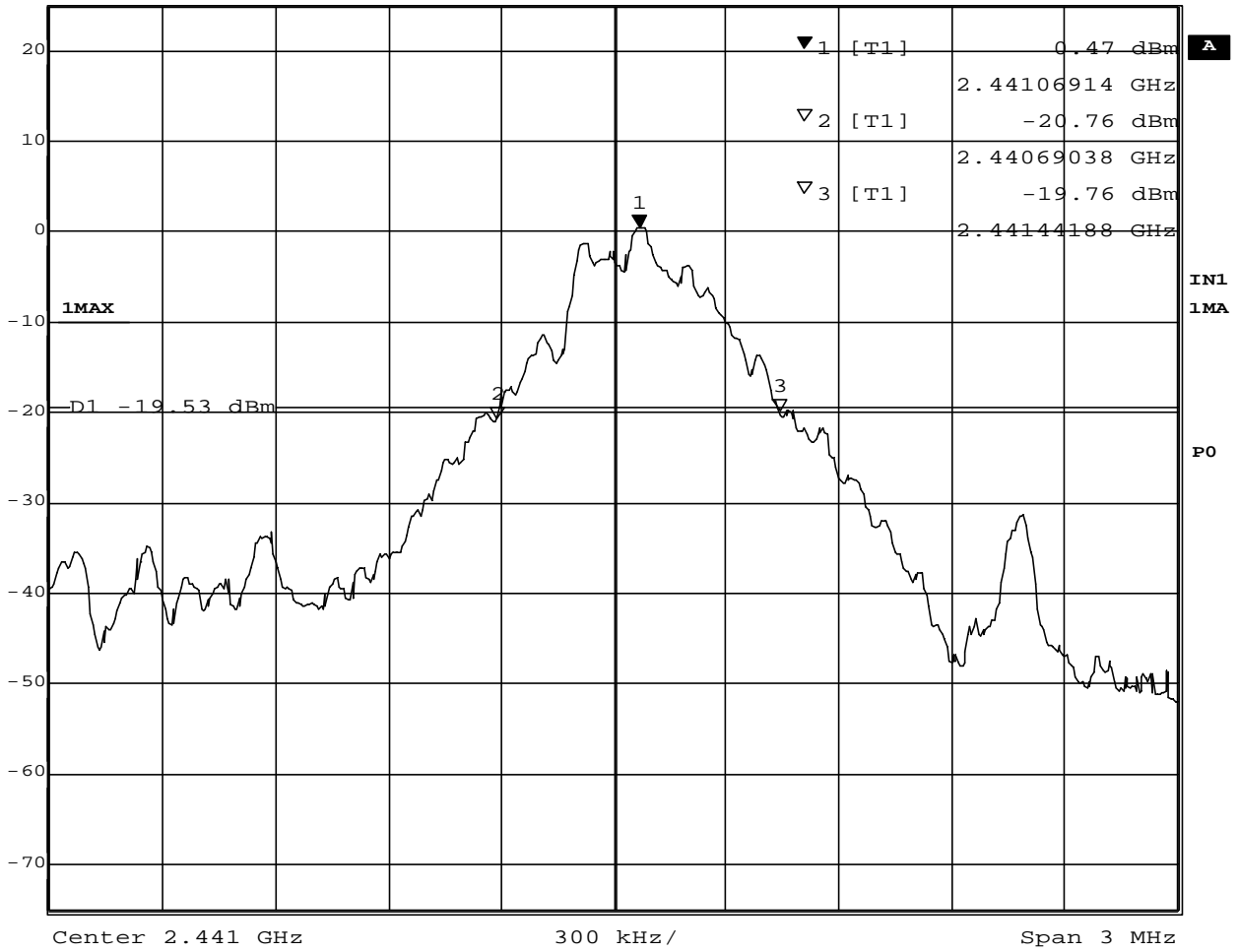

Date: 26.APR.2002 11:05:04

Band-edge (TX on 2441MHz)



Marker 1 [T1]	RBW	30 kHz	RF Att	40 dB
Ref Lvl	1.52 dBm	VBW	30 kHz	
25 dBm	2.48006914 GHz	SWT	8.5 ms	Unit dBm

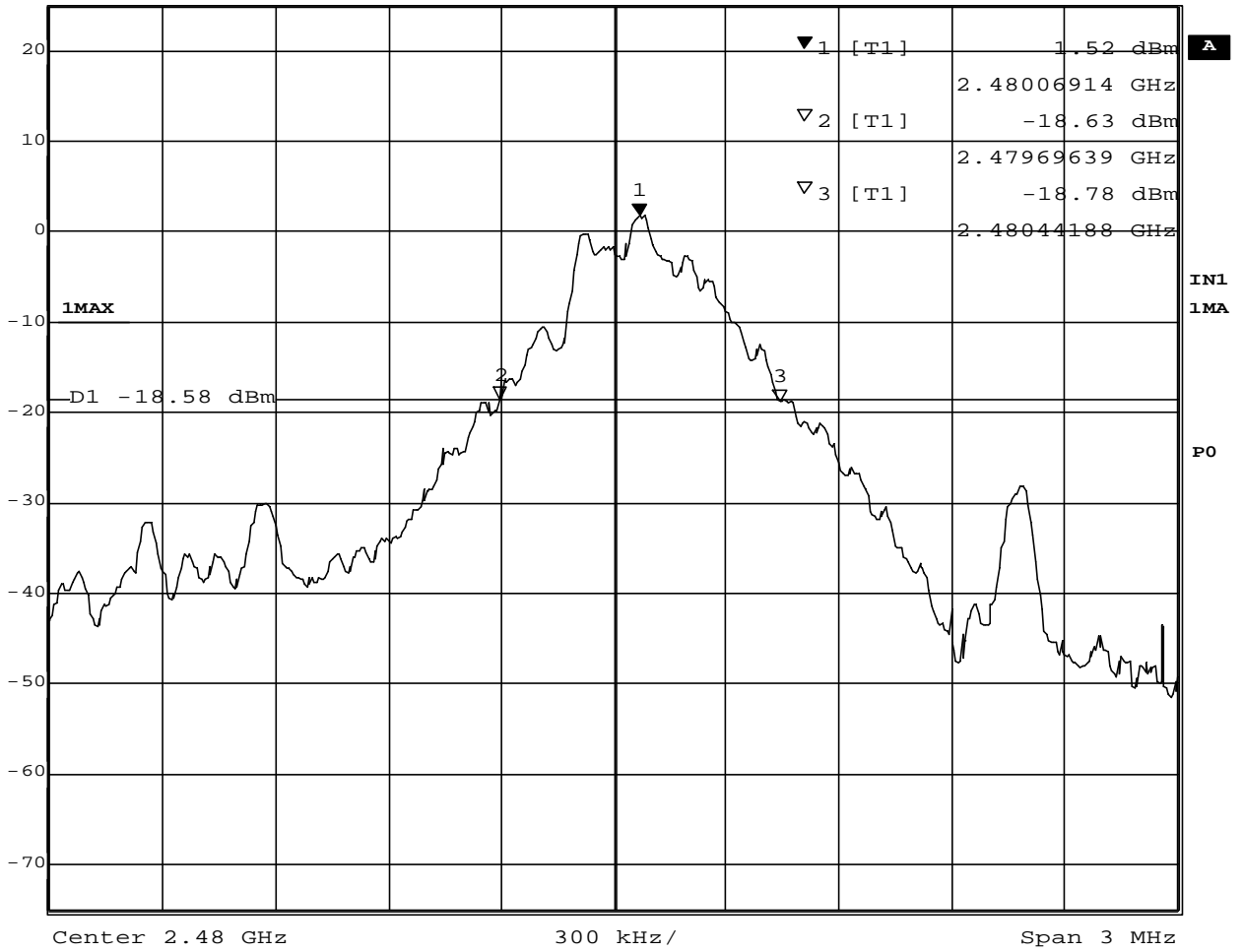

Date: 26.APR.2002 11:06:54

Band-edge (TX on 2480MHz)

7. Out of Band Emissions

7.1 Test Procedure

- The out of band emissions is measured with a spectrum analyzer connected to the antenna terminal, while EUT had its hopping function disabled at the highest, middle and the lowest available channels.
- The spectrum analyzer is set to :
 - Center frequency = the highest, middle and the lowest channels
 - Span : 100 MHz
 - RBW : 100 kHz
 - VBW : 100 kHz
 - Sweep = auto, Detector function = peak, Trace = max hold
- After the trace being stable. Use the marker-to-peak function to set the marker to the peak of the inband emission. Use the marker-delta function to measure 20 dB down the peak of the inband emission.

7.2 Test Instruments and Measurement Setup

Same as the Chapter 1(Table 1-1 & Figure 1).

7.3 Measurement Results

All conducted emission in any 100 kHz bandwidth outside of the spread spectrum band was at least 20dB lower than the highest inband spectral density. Therefore the applying equipment meets the requirement.

Test Date: April 26, 2002

7.4 Trace Data

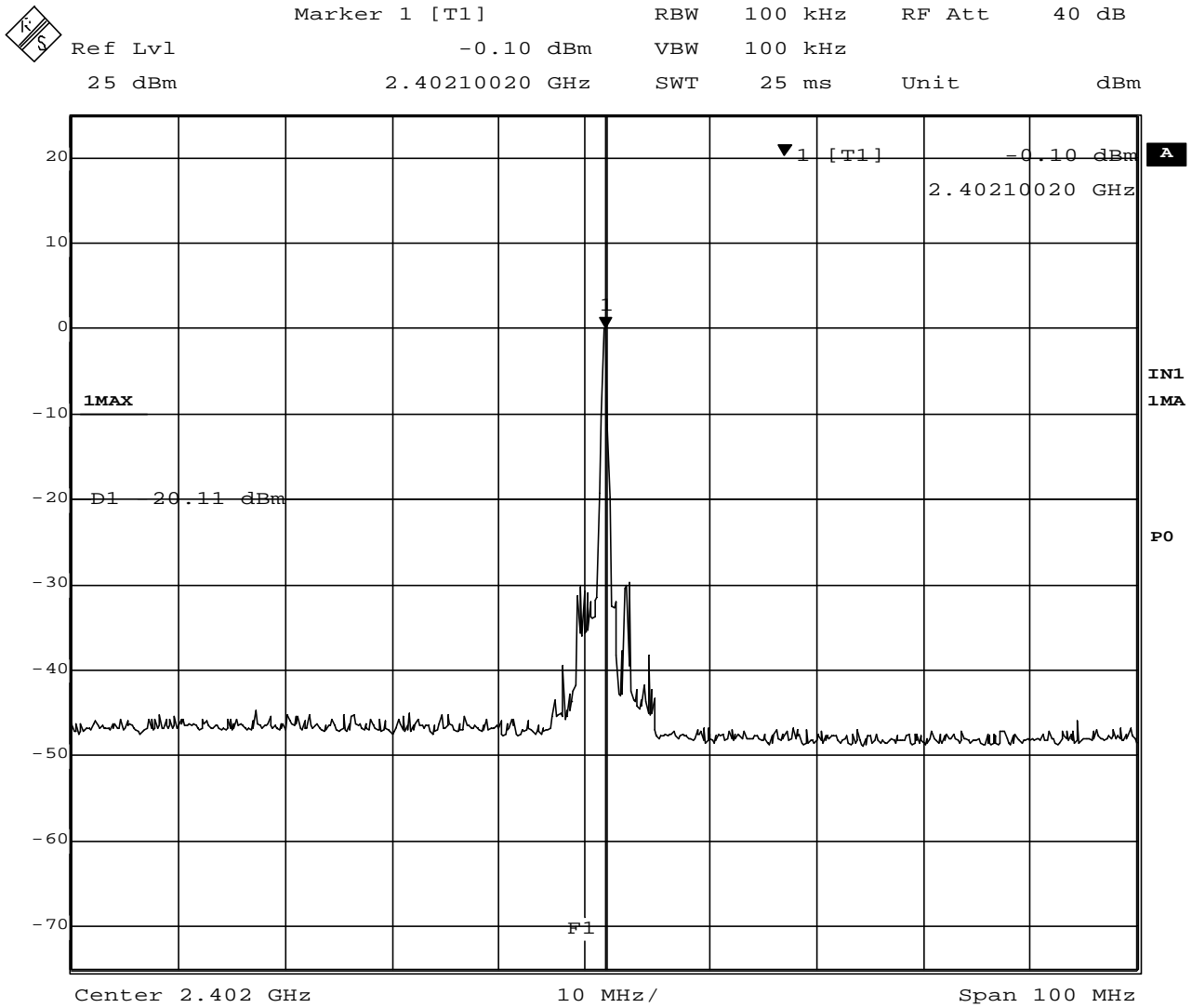

Date: 26. APR. 2002 11:09:47

Out of Band Emissions (TX on 2402MHz)



Ref Lvl	Marker 1 [T1]	RBW	100 kHz	RF Att	40 dB
25 dBm	0.72 dBm	VBW	100 kHz		
	2.44110020 GHz	SWT	25 ms	Unit	dBm

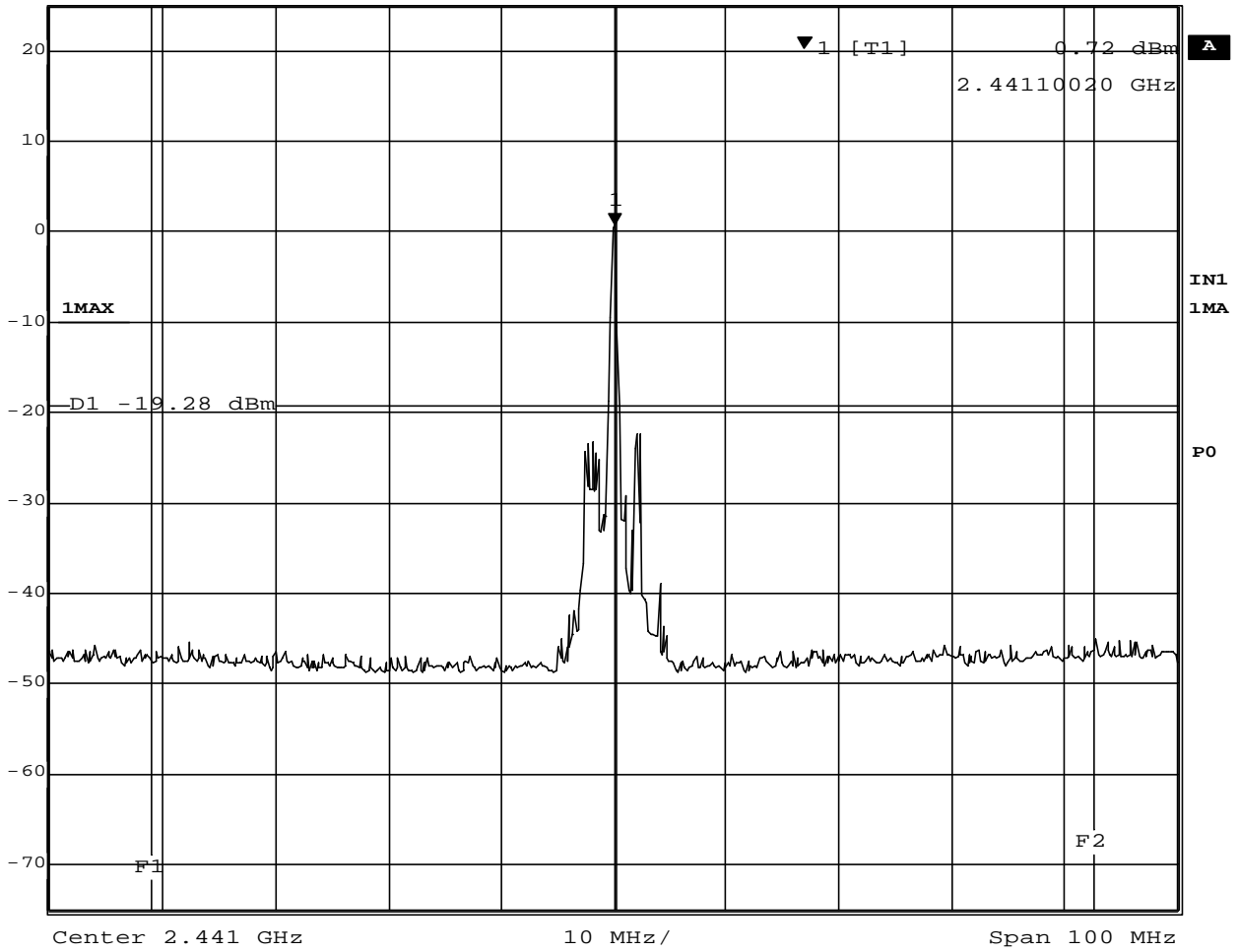

Date: 26.APR.2002 11:11:30

Out of Band Emissions (TX on 2441MHz)



Marker 1 [T1] RBW 100 kHz RF Att 40 dB
Ref Lvl 1.74 dBm VBW 100 kHz
25 dBm 2.48010020 GHz SWT 25 ms Unit dBm

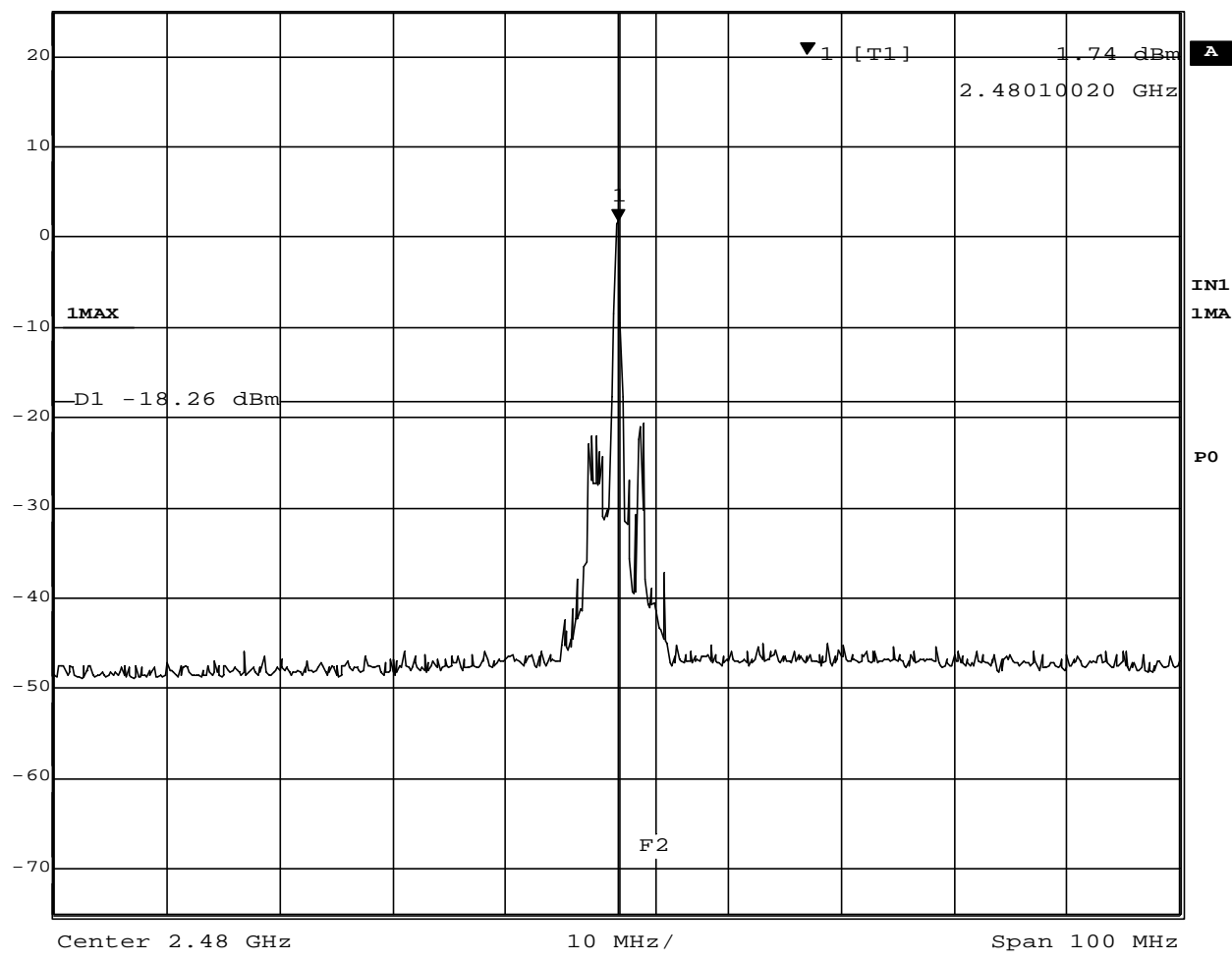

Date: 26.APR.2002 11:12:52

Out of Band Emissions (TX on 2480MHz)

8. Transmitter Power Spectral Density

8.1 Test Procedure

The peak power density is measured with a spectrum analyzer connected to the antenna terminal, while EUT had been operating in Inquiry and Paging mode.

The spectrum analyzer is set to:

Center Frequency = middle channel, RBW = 3 kHz, VBW = 3 kHz, Span = 2 MHz, Sweep = auto

8.2 Test Instruments and Measurement Setup

Same as the Chapter 1 (Table 1-1 & Figure 1).

8.3 Measurement Results

Test Date: April 26, 2002

Table 8. EUT: M/T 2672-4HU, s/n ZZ-00245

EUT Operation mode	Measured Frequency (MHz)	Spectrum Analyzer Reading (dBm)	Cable loss (dB)	Result (dBm)	Limit (dBm)	Margin (dB)
Inquiry	2441.07	- 8.4	1.7	- 6.7	8.0	14.7
Paging	2441.99	-12.6	1.7	-10.9	8.0	18.9

8.4 Trace Data

	Marker 1 [T1]	RBW	3 kHz	RF Att	40 dB
	Ref Lvl	-8.37 dBm	VBW	3 MHz	
	25 dBm	2.44107415 GHz	SWT	560 ms	Unit

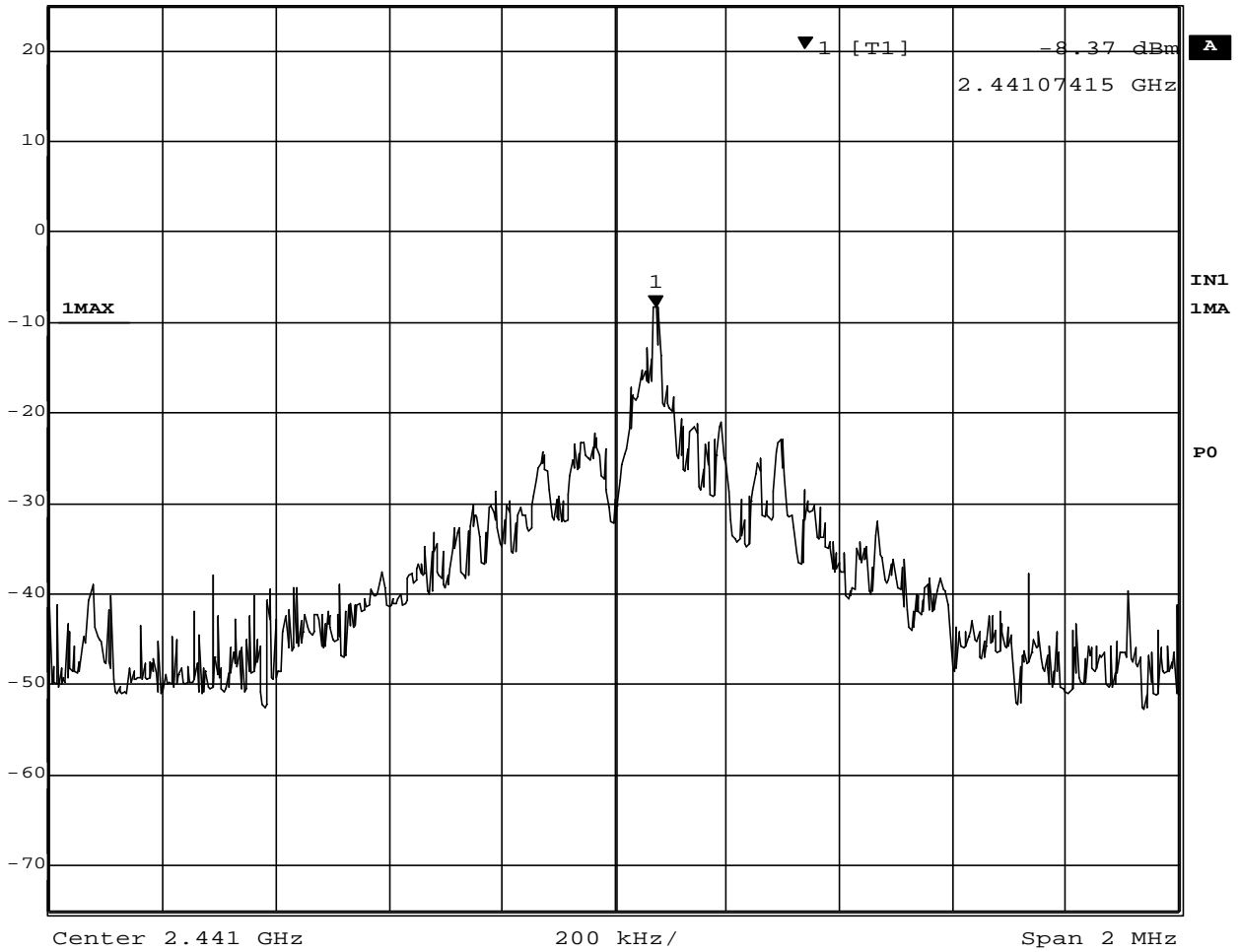

Date: 26.APR.2002 10:28:39

Transmitter Power Spectral Density (Inquiry)



Ref Lvl	Marker 1 [T1]	RBW	3 kHz	RF Att	40 dB
25 dBm	-12.63 dBm	VBW	3 MHz		
	2.44207816 GHz	SWT	560 ms	Unit	dBm

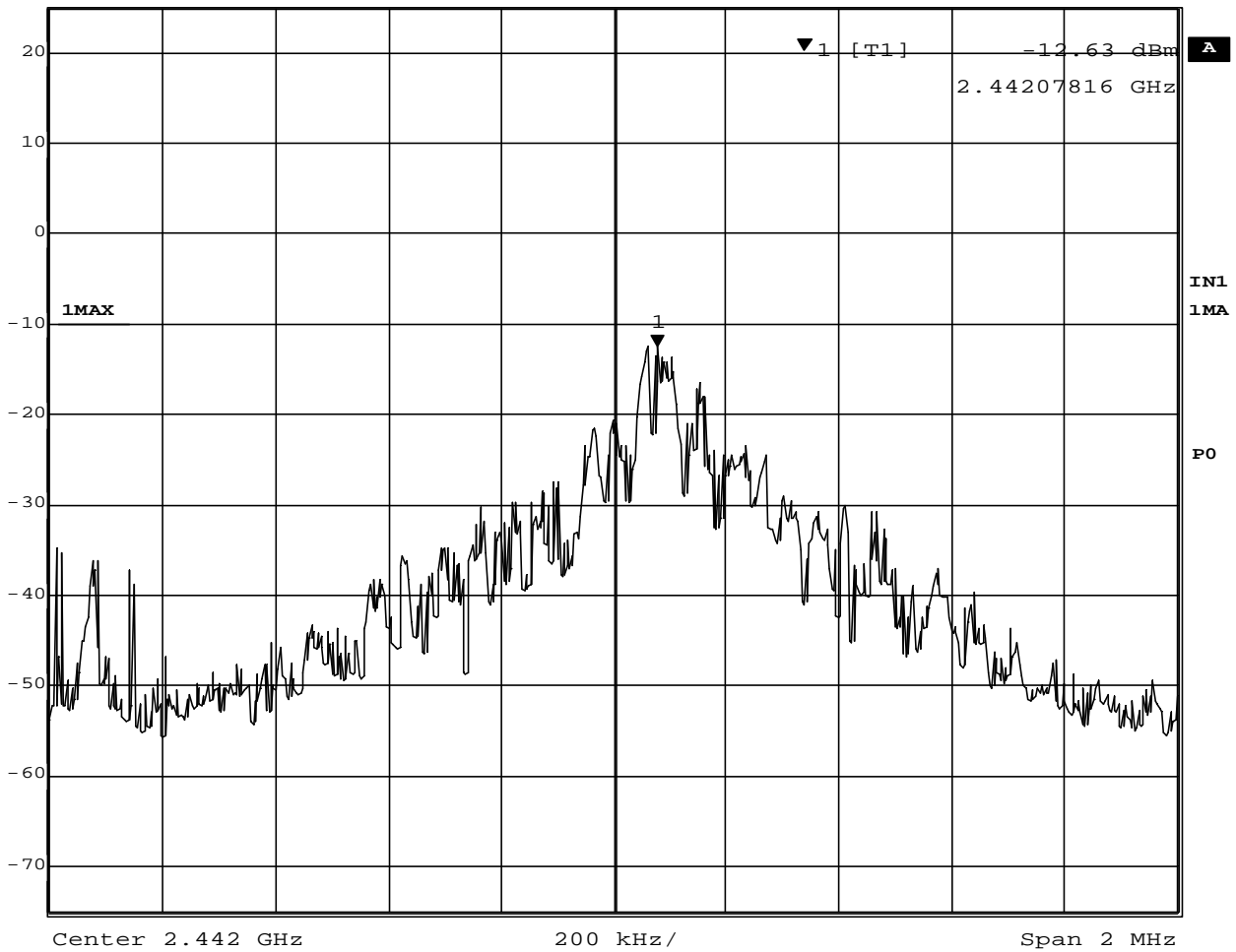

Date: 26.APR.2002 10:26:32

Transmitter Power Spectral Density (Paging)

9. AC WIRELINE CONDUCTED EMISSIONS (450 kHz – 30 MHz)

9.1 Test Procedure

The conducted emissions are measured in the IBM shielded room with a spectrum analyzer in peak hold. While the measurement, EUT had its hopping function disabled at the highest, middle and lowest available channels in line with Section 15.31(m) of Public Notice DA 00-705 dated March 30, 2000. Emissions closest to the limit are measured in the quasi-peak mode (QP) with the tuned receiver using a bandwidth of 9 kHz. The emissions are maximized further by cable manipulation and Exerciser operation. The highest emissions relative to the limit are listed.

9.2 Test Instruments and Measurement Setup

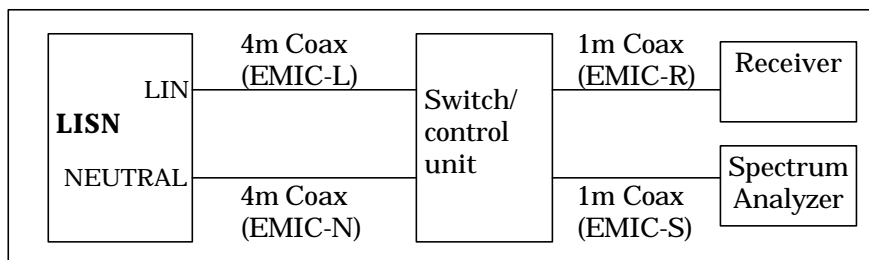

Figure 9. Cables for Conducted Emission Test

Table 9-1. Conducted Emission Test Instrumentation

Description	Model	Serial Number
Computer	IBM 6589-13J	97-15613
Spectrum Analyzer (100Hz-1.5GHz)	HP 85680B	2732A03651
Spectrum Analyzer Display	HP 85662A	2648A15255
Quasi-Peak Adapter	HP 85650A	2521A00968
Receiver (9kHz-30MHz)	R&S ESH3	891806/012
LISN	EMCO 3825/2	1426
Switch/control unit	HP 3488A	2719A17228
Plotter	HP 7550A	2631A33619
Coax cables:	Length:	
- Lisen-L <=> SW/Con.unit (SW100)	4 m	- EMIC-L
- Lisen-N <=> SW/Con.unit (SW101)	4 m	- EMIC-N
- SW/Con.unit <=> RCVR (Input)	1 m	- EMIC-R
- SW/Con.unit<=> Spe Ana.(Signal In)	1 m	- EMIC-S

Notes: - HP: Hewlett Packard, R&S: Rohde & Schwarz

9.3 Measurement Results

The EUT was found to comply to the limits of FCC Part 15 Subpart C and RSS-210 with a margin of 22.4dB. The 6 highest emissions relative to the limits are reported.

Test Date: April 11, 2002

1) EUT in transmission mode

Table 9-2-1. EUT: M/T 2672-4HU, s/n ZZ-00245, Ch.1(2402MHz)

Frequency (MHz)	QP Voltage (dB μ V)	QP Limit (dB μ V)	QP Voltage (μ V)	QP Limit (μ V)	Phase
0.4692	25.6	48	19.1	250	Neutral
0.5401	21.8	48	12.3	250	Neutral
0.6069	22.0	48	12.6	250	Neutral
1.3225	13.0	48	4.5	250	Line
8.8243	15.4	48	5.9	250	Line
22.5082	19.4	48	9.3	250	Line

Table 9-2-2. EUT: M/T 2672-4HU, s/n ZZ-00245 , Ch.40(2441MHz)

Frequency (MHz)	QP Voltage (dB μ V)	QP Limit (dB μ V)	QP Voltage (μ V)	QP Limit (μ V)	Phase
0.4701	25.6	48	19.1	250	Neutral
0.5381	22.1	48	12.7	250	Neutral
0.6826	16.3	48	6.5	250	Line
6.1337	20.0	48	10.0	250	Line
20.0178	18.0	48	7.9	250	Line
24.1332	20.8	48	11.0	250	Neutral

Table 9-2-3. EUT: M/T 2672-4HU, s/n ZZ-00245, Ch.79(2480MHz)

Frequency (MHz)	QP Voltage (dB μ V)	QP Limit (dB μ V)	QP Voltage (μ V)	QP Limit (μ V)	Phase
0.4657	18.1	48	8.0	250	Neutral
0.5145	18.4	48	8.3	250	Line
0.6010	17.5	48	7.5	250	Neutral
1.6826	17.0	48	7.1	250	Line
6.4742	20.6	48	10.7	250	Line
22.7881	21.2	48	11.5	250	Neutral

2) EUT in receiving mode

Table 9-2-4. EUT: M/T 2672-4HU, s/n ZZ-00245, RX mode

Frequency (MHz)	QP Voltage (dB μ V)	QP Limit (dB μ V)	QP Voltage (μ V)	QP Limit (μ V)	Phase
0.4694	24.8	48	17.4	250	Neutral
0.5368	20.9	48	11.1	250	Neutral
0.6050	22.8	48	13.8	250	Neutral
1.3296	12.7	48	4.3	250	Line
6.4661	19.1	48	9.0	250	Line
24.3256	20.2	48	10.2	250	Neutral

10. RESTRICTED BANDS RADIATIONS (30 MHz – 1 GHz)

10.1 Test Procedure

Preliminary radiated emissions are measured in the semi-anechoic chamber at a 3 meter distance on every azimuth in both horizontal and vertical polarity. The antennas are also scanned in height. The identified emissions are further maximized by a cable manipulation. Emissions closest to the limits are measured in the quasi-peak mode with the tuned receiver using a bandwidth of 120 kHz. The highest emissions relative to the limit are listed.

While the measurement, EUT had its hopping function disabled at the highest, middle and lowest available channels in line with Section 15.31(m) of Public Notice DA 00-705 dated March 30, 2000.

10.2 Test Instruments and Measurement Setup

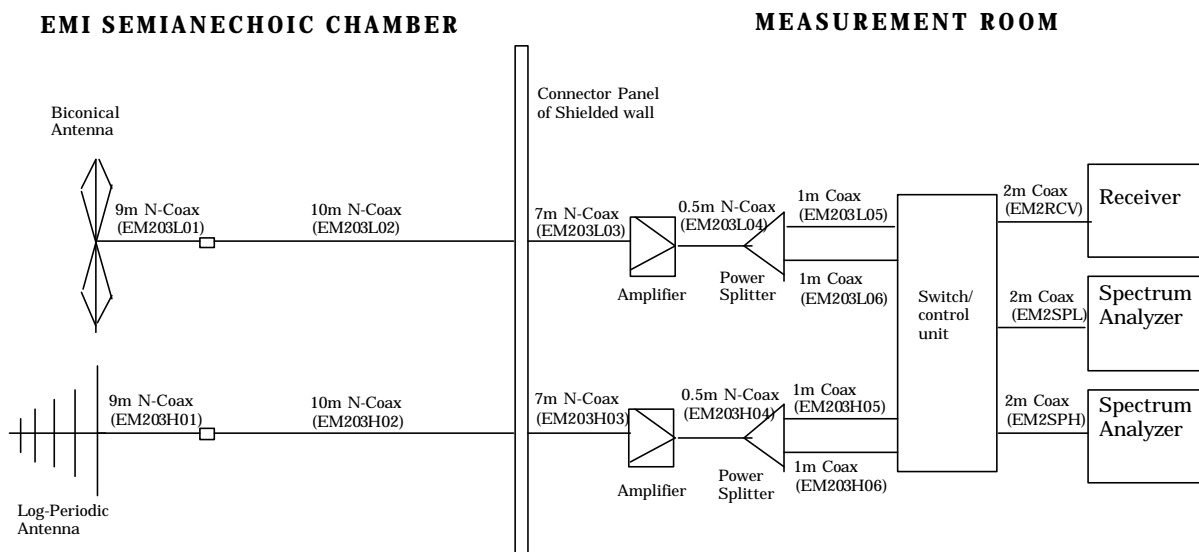

Figure 10 Cables for Radiated Emission Test

Table 10-1 Radiated Emission Test Instrumentation

Description	Model	Serial Number
Computer	IBM 5551-L	#4
Spectrum Analyzer (100Hz-1.5GHz) for 30-200MHz	HP 85680B	2841A04254
Spectrum Analyzer Display for 30-200MHz	HP 85662A	2816A16831
Quasi-Peak Adapter for 30-200MHz	HP 85650A	2811A01156
Spectrum Analyzer (100Hz-1.5GHz) for 200-1000MHz	HP 85680B	2841A04242
Spectrum Analyzer Display for 200-1000MHz	HP 85662A	2816A16827
Quasi-Peak Adapter for 200-1000MHz	HP 85650A	2811A01126
Amplifier (100KHz-1.3GHz)		
- for 30-200MHz	HP 8447D	2805A02919
- for 200-1000MHz	HP 8447D	2944A03506
Biconical Antenna (30-200MHz)	EMCO 3108	2241
Log-Periodic Antenna (200-1000MHz)	EMCO 3146	1584
Receiver (20MHz-1.3GHz)	R&S ESVP	892111/030
Switch/control unit	HP 3488A	2719A17226
N-Coax cables:	Length:	
- Bi-coni Ant <=> 10m Cable	9 m	- EM203L01
- 10m Cable <=> Shield Panel	10 m	- EM203L02
- Shield Panel <=> RF Amp	7 m	- EM203L03
- RF Amp <=> Power Splitter	0.5m	- EM203L04
- Log-peri Ant <=> 10m Cable	9 m	- EM203H01
- 10m Cable <=> Shield Panel	10 m	- EM203H02
- Shield Panel <=> RF Amp	7 m	- EM203H03
- RF Amp <=> Power Splitter	0.5m	- EM203H04
Coax cables:		
- Power Splitter <=> SW/Con.unit (SW110)	1 m	- EM203L05
- Power Splitter <=> SW/Con.unit (SW300)	1 m	- EM203L06
- Power Splitter <=> SW/Con.unit (SW100)	1 m	- EM203H05
- Power Splitter <=> SW/Con.unit (SW301)	1 m	- EM203H06
- SW/Con.unit <=> Receiver (Input)	2 m	- EM2RCV
- SW/Con.unit <=> Spe Ana.(Signal In) for 30- 200MHz	2 m	- EM2SPL
- SW/Con.unit <=> Spe Ana.(Signal In) for 200-1000MHz	2 m	- EM2SPH

Notes: HP: Hewlett Packard, R&S: Rohde & Schwarz

10.3 Field Strength Calculation

The field strength is calculated by adding the Antenna Factor and Cable Loss, and subtracting Amplifier Gain from the measured reading. In this test facility, the Antenna Factor, Cable Loss, and Amplifier Gains are loaded into the Rohde & Schwarz Receiver and the corrected field strength can be read directly on the receiver. All factors are included in the reported data.

$$FS = R + AF + CORR$$

where:

FS	=	Field Strength
R	=	Measured Receiver Input Amplitude
AF	=	Antenna Factor
CORR	=	Correction Factor = CL - AG
CL	=	Cable Loss
AG	=	Amplifier Gain

For example:

Given a Receiver input reading of 51.5dB μ V; Antenna Factor of 8.5dB/m; Cable Loss of 1.3dB; and an Amplifier Gain of 26dB. The Field Strength of the measured emission is:

$$FS = 51.5 + 8.5 + 1.3 - 26.0 = 35.3\text{dB}\mu\text{V/m}$$

Conversion between dB μ V/m (or dB μ V) and μ V/m (or μ V) are done as:

$$\text{Level(dB}\mu\text{V/m)} = 20 \times \text{Log(Level}(\mu\text{V/m))}$$

$$40\text{dB}\mu\text{V/m} = 100\mu\text{V/m}$$

$$48\text{dB}\mu\text{V/m} = 250\mu\text{V/m}$$

10.4 Measurement Results

The EUT was found to comply to the limits of FCC Part 15 Subpart C and RSS-210 with a margin of 4.0 dB at 30 – 1000 MHz band.

The 6 highest emissions relative to the limits are reported.

Test Date: April 9, 2002

1) EUT in transmission mode

Table 10-2-1. EUT: M/T 2672-4HU, s/n ZZ-00245, Ch.1 (2402MHz) TX mode

Frequency (MHz)	Polarity (H/V)	Measured (dB μ V)	Antenna Factor (dB/m)	Corr. Factor (dB)	Field Strength (dB μ V/m)	Limit (dB μ V/m)	Field Strength (μ V/m)	Limit (μ V/m)
439.999	V	34.9	15.8	-14.2	36.5	46.0	66.8	200
483.999	V	38.1	17.1	-14.5	40.7	46.0	108.4	200
571.998	V	37.8	18.1	-14.1	41.8	46.0	123.0	200
615.998	V	32.6	18.9	-13.7	37.8	46.0	77.6	200
664.113	V	34.6	20.1	-14.1	40.6	46.0	107.2	200
703.998	V	34.2	20.9	-13.9	41.2	46.0	114.8	200

Table 10-2-2. EUT: M/T 2672-4HU, s/n ZZ-00245, Ch.40 (2441MHz) TX mode

Frequency (MHz)	Polarity (H/V)	Measured (dB μ V)	Antenna Factor (dB/m)	Corr. Factor (dB)	Field Strength (dB μ V/m)	Limit (dB μ V/m)	Field Strength (μ V/m)	Limit (μ V/m)
351.999	H	35.5	14.0	-14.1	35.4	46.0	58.9	200
439.999	V	35.0	15.8	-14.2	36.6	46.0	67.6	200
483.998	V	37.9	17.1	-14.5	40.5	46.0	105.9	200
571.998	V	37.7	18.1	-14.1	41.7	46.0	121.6	200
664.113	V	34.7	20.1	-14.1	40.7	46.0	108.4	200
703.998	V	34.5	20.9	-13.9	41.5	46.0	118.9	200

Table 10-2-3. EUT: M/T 2672-4HU, s/n ZZ-00245, Ch.79 (2480MHz) TX mode

Frequency (MHz)	Polarity (H/V)	Measured (dB μ V)	Antenna Factor (dB/m)	Corr. Factor (dB)	Field Strength (dB μ V/m)	Limit (dB μ V/m)	Field Strength (μ V/m)	Limit (μ V/m)
240.042	H	38.8	10.8	-15.1	34.5	46.0	53.1	200
395.998	H	35.6	15.1	-14.4	36.3	46.0	65.3	200
483.999	V	37.7	17.1	-14.5	40.3	46.0	103.5	200
571.998	V	38.0	18.1	-14.1	42.0	46.0	125.9	200
663.891	V	34.4	20.1	-14.1	40.4	46.0	104.7	200
703.998	V	34.7	20.9	-13.9	41.7	46.0	121.6	200

2) EUT in receiving mode

Table 10-2-4. EUT: M/T 2672-4HU, s/n ZZ-00245, Ch.40 (2441MHz) RX mode

Frequency (MHz)	Polarity (H/V)	Measured (dBμV)	Antenna Factor (dB/m)	Corr. Factor (dB)	Field Strength (dBμV/m)	Limit (dBμV/m)	Field Strength (μV/m)	Limit (μV/m)
240.042	H	38.8	10.8	-15.1	34.5	46.0	53.1	200
439.998	V	35.0	15.8	-14.2	36.6	46.0	67.6	200
483.998	V	39.0	17.1	-14.5	41.6	46.0	120.2	200
571.998	V	38.0	18.1	-14.1	42.0	46.0	125.9	200
664.240	V	35.1	20.1	-14.1	41.1	46.0	113.5	200
703.998	V	33.7	20.9	-13.9	40.7	46.0	108.4	200

11. RESTRICTED BANDS RADIATIONS (1 GHz – 25 GHz)

11.1 Test Procedure

Radiated emissions were measured in the frequency range with 1 to 25 GHz in transmitting mode and 1 to 12.5 GHz in receiving mode. All tests were performed in the semi-anechoic chamber at a 3-meter distance (except for the frequency range with 18 to 25 GHz where test distance was reduced to 1 meter) on both horizontal and vertical polarities. The antenna was also scanned in height. The identified emissions are further maximized as a function of cable manipulation, azimuth, and antenna height. The emissions closest to the limits are measured in the peak mode with the tuned spectrum analyzer using a bandwidth of 1MHz and the average setting mode with the tuned spectrum analyzer using resolution bandwidth of 1 MHz / video bandwidth of 1 kHz or 100 Hz. The highest emissions relative to the limit are listed. While the measurement, EUT had its hopping function disabled at the highest, middle and lowest available channels in line with Section 15.31(m) of Public Notice DA 00-705 dated March 30, 2000.

11.2 Test Instruments and Measurement

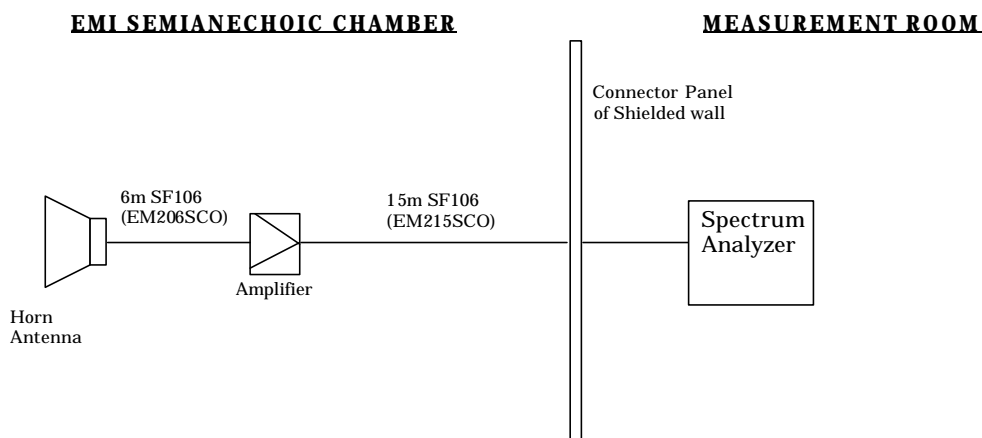

Figure 11 Cables for Radiated Emission Test

Table 11 Radiated Emission Test Instrumentation (1 – 25 GHz)

Description	Model	Serial Number
Spectrum Analyzer EMI Test Receiver	R&S ESI26	836119/003
Amplifier (1 - 26.5GHz)	HP 8449B	3008A00582
Horn Antenna (1- 18GHz)	EMCO 3115	9903-5774
Horn Antenna (3.95 – 5.85GHz)	EMCO 3160-5	1099
Horn Antenna (5.85 – 8.20GHz)	EMCO 3160-6	9712-1044
Horn Antenna (18- 26.5GHz)	EMCO 3160-9	0004-1202
SF106 cables: - Horn Ant <=> RF Amp. - RF Amp.<=>Spectrum Analyzer	Length: 6 m 15 m	- EM206SCO - EM215SCO

Notes: HP: Hewlett Packard, R&S: Rohde & Schwarz

11.3 Field Strength Calculation

The field strength is calculated by adding the Antenna Factor and Cable Loss, and subtracting Amplifier Gain from the measured reading. All factors are included in the reported data.

$$FS = R + AF + CORR - FO$$

where:

- FS = Field Strength
- R = Measured Spectrum analyzer Input Amplitude
- AF = Antenna Factor
- CORR = Correction Factor = CL-AG
- CL = Cable Loss
- AG = Amplifier Gain
- FO = Distance Falloff Factor

For example:
 Given a Spectrum Analyzer input reading of 51.5 dBμV; Antenna Factor of 8.5 dB/m; Cable Loss of 1.3 dB;
 Falloff Factor of 0 dB; and an Amplifier Gain of 26 dB. The Field Strength of the measured emission is:

$$FS = 51.5 + 8.5 + 1.3 - 26 - 0.0 = 35.6 \text{ dB}\mu\text{V/m}$$

Conversions between dBμV/m (or dBμV) and μV/m (or μV) are done as :

- Level(dBμV/m) = 20 X Log (Level(μV/m))
- 40 dBμV/m = 100 μV/m
- 48 dBμV/m = 250 μV/m

11.4 Measurement Results

The EUT was found to comply to the limits of FCC Part 15 Subpart C and RSS-210 with a margin of 2.8dB. The measurement was done for the frequency range of 1 to 25 GHz in TX mode and 1 to 12.5 GHz in RX mode.

Test Date: April 18 and 24, 2002

1) EUT in transmission mode

Table 11-2-1. EUT: M/T 2672-4HU, s/n ZZ-00245, Ch.1(2402MHz) TX mode

Frequency (GHz)	Polarity (H/V)	Measured (dB μ V) (<i>peak</i>)	Measured (dB μ V) (<i>average</i>)	Antenna Factor (dB/m)	Corr. Factor (dB)	Falloff Factor (dB)	Field Strength (dB μ V/m) (<i>peak</i>)	FCC Limit (dB μ V/m) (<i>peak</i>)	Field Strength (dB μ V/m) (<i>average</i>)	FCC Limit (dB μ V/m) (<i>average</i>)
1.063	V	55.6	-	24.2	-31.5	0.0	48.3	74.0	-	54.0
1.129	V	61.6	41.8	24.4	-31.3	0.0	54.7	74.0	34.9	54.0
1.196	V	67.8	54.5	24.6	-31.2	0.0	61.2	74.0	47.9	54.0
1.262	V	61.6	45.2	24.7	-30.9	0.0	55.4	74.0	39.0	54.0
1.728	V	50.1	-	26.2	-30.1	0.0	46.2	74.0	-	54.0
1.794	V	50.1	-	26.6	-29.9	0.0	46.8	74.0	-	54.0
1.862	V	50.5	-	26.8	-29.8	0.0	47.5	74.0	-	54.0
2.036	V	49.9	-	27.5	-29.5	0.0	47.9	74.0	-	54.0
2.389	V	48.6	-	28.2	-28.5	0.0	48.3	74.0	-	54.0
2.402	V	93.5	90.3	28.2	-28.4	0.0	93.3	OB*	90.1	OB*
4.138	V	38.4	-	27.4	-24.2	0.0	41.6	74.0	-	54.0
4.806	V	47.8	-	27.4	-23.8	0.0	51.4	74.0	-	54.0
7.207	V	65.9	42.4	30.0	-24.7	0.0	71.2	74.0	47.7	54.0

*Note: OB means "operation band" (2400-2483.5MHz); in this case limit is 1W (measured conducted with power meter).

Table 11-2-2. EUT: M/T 2672-4HU, s/n ZZ-00245, Ch.40(2441MHz) TX mode

Frequency (GHz)	Polarity (H/V)	Measured (dB μ V) (<i>peak</i>)	Measured (dB μ V) (<i>average</i>)	Antenna Factor (dB/m)	Corr. Factor (dB)	Falloff Factor (dB)	Field Strength (dB μ V/m) (<i>peak</i>)	FCC Limit (dB μ V/m) (<i>peak</i>)	Field Strength (dB μ V/m) (<i>average</i>)	FCC Limit (dB μ V/m) (<i>average</i>)
1.063	V	55.4	-	24.2	-31.5	0.0	48.1	74.0	-	54.0
1.154	V	59.1	-	24.5	-31.2	0.0	52.4	74.0	-	54.0
1.196	V	67.9	54.4	24.6	-31.2	0.0	61.3	74.0	47.8	54.0
1.262	V	60.5	45.3	24.7	-30.9	0.0	54.3	74.0	39.1	54.0
1.728	V	51.2	-	26.2	-30.1	0.0	47.3	74.0	-	54.0
1.819	V	48.7	-	26.6	-29.9	0.0	45.4	74.0	-	54.0
1.862	V	50.5	-	26.8	-29.8	0.0	47.5	74.0	-	54.0
2.035	V	50.2	-	27.5	-29.5	0.0	48.2	74.0	-	54.0
2.441	V	93.3	89.9	28.3	-28.4	0.0	93.2	OB*	89.8	OB*
4.132	V	40.3	-	27.4	-24.2	0.0	43.5	74.0	-	54.0
4.884	V	44.6	-	27.4	-23.7	0.0	48.3	74.0	-	54.0
7.324	V	63.2	35.4	29.8	-24.9	0.0	68.1	74.0	40.3	54.0

*Note: OB means "operation band" (2400-2483.5MHz); in this case limit is 1W (measured conducted with power meter).

Table 11-2-3. EUT: M/T 2672-4HU, s/n ZZ-00245, Ch.79(2480MHz) TX mode

Frequency (GHz)	Polarity (H/V)	Measured (dBμV) (<i>peak</i>)	Measured (dBμV) (<i>average</i>)	Antenna Factor (dB/m)	Corr. Factor (dB)	Falloff Factor (dB)	Field Strength (dBμV/m) (<i>peak</i>)	FCC Limit (dBμV/m) (<i>peak</i>)	Field Strength (dBμV/m) (<i>average</i>)	FCC Limit (dBμV/m) (<i>average</i>)
1.063	V	55.3	-	24.2	-31.5	0.0	48.0	74.0	-	54.0
1.129	V	59.2	-	24.4	-31.3	0.0	52.3	74.0	-	54.0
1.196	V	67.9	55.5	24.6	-31.2	0.0	61.3	74.0	48.9	54.0
1.262	V	61.0	45.5	24.7	-30.9	0.0	54.8	74.0	39.3	54.0
1.728	V	51.1	-	26.2	-30.1	0.0	47.2	74.0	-	54.0
1.793	V	49.3	-	26.6	-29.9	0.0	46.0	74.0	-	54.0
1.859	V	50.5	-	26.8	-29.8	0.0	47.5	74.0	-	54.0
2.037	V	49.4	-	27.5	-29.5	0.0	47.4	74.0	-	54.0
2.480	V	93.0	89.0	28.4	-28.2	0.0	93.2	OB*	89.2	OB*
2.484	V	58.6	49.4	28.4	-28.2	0.0	58.8	74.0	49.6	54.0
4.128	V	39.7	-	27.4	-24.2	0.0	42.9	74.0	-	54.0
4.962	V	41.1	-	27.4	-23.5	0.0	45.0	74.0	-	54.0
7.441	V	66.3	40.1	29.8	-25.1	0.0	71.0	74.0	44.8	54.0

*Note: OB means “operation band” (2400-2483.5MHz); in this case limit is 1W (measured conducted with power meter).

2) EUT in receiving mode

Table 11-2-4. EUT: M/T 2672-4HU, s/n ZZ-00245, RX mode

Frequency (GHz)	Polarity (H/V)	Measured (dBμV) (<i>peak</i>)	Measured (dBμV) (<i>average</i>)	Antenna Factor (dB/m)	Corr. Factor (dB)	Falloff Factor (dB)	Field Strength (dBμV/m) (<i>peak</i>)	FCC Limit (dBμV/m) (<i>peak</i>)	Field Strength (dBμV/m) (<i>average</i>)	FCC Limit (dBμV/m) (<i>average</i>)
1.140	V	62.5	44.4	24.4	-31.3	0.0	55.6	74.0	37.5	54.0
1.196	V	68.1	55.3	24.6	-31.2	0.0	61.5	74.0	48.7	54.0
1.262	V	62.3	45.6	24.7	-30.9	0.0	56.1	74.0	39.4	54.0
1.278	V	59.4	-	24.8	-30.9	0.0	53.3	74.0	-	54.0
1.728	V	50.8	-	26.2	-30.1	0.0	46.9	74.0	-	54.0
1.794	V	51.4	-	26.6	-29.9	0.0	48.1	74.0	-	54.0
1.862	V	50.8	-	26.8	-29.8	0.0	47.8	74.0	-	54.0
2.035	V	50.4	-	27.5	-29.5	0.0	48.4	74.0	-	54.0
4.124	V	39.1	-	27.4	-24.2	0.0	42.3	74.0	-	54.0