

Emission Test Report

Standard: FCC Part 15 Subpart C / IC RSS-210

Document Number : FCC 19-0198-0

**Product Name: ThinkPad R32 Series
Multiple Transmitters model
(with Cisco Aironet Wireless 802.11b)**

**FCC ID: ANODS1WSHR
IC: 349E-U58H004**

May 16, 2002

**Prepared :
EMC Engineer**

Shohei Fujio

Signature: 

**IBM/Japan, Ltd.
EMC Engineering
LAB-S59**

**1623-14, Shimotsuruma,
Yamato-shi Kanagawa-ken 242, Japan
Phone: +81-46-215-2589
Fax: +81-46-273-7420
E-Mail: asano@jp.ibm.com**

**Reviewed and Checked :
EMC Staff Engineer**

Toshiya Murota

Signature: 

**IBM Japan, Ltd.
EMC Engineering
LAB-S59**

**1623-14, Shimotsuruma,
Yamato-shi Kanagawa-ken 242, Japan
Phone: +81-46-215-6574
Fax: +81-46-273-7420
E-Mail: murota@jp.ibm.com**

**Approved :
Manager, EMC Engineering**

Akihisa Sakurai

Signature: 

**IBM Japan, Ltd.
EMC Engineering
LAB-S59**

**1623-14, Shimotsuruma,
Yamato-shi Kanagawa-ken 242, Japan
Phone: +81-46-215-2613
Fax: +81-46-273-7420
E-Mail: akihisa@jp.ibm.com**

**MEASUREMENT / TECHNICAL REPORT – Part 15 Subpart C
(Intentional Radiator)**

**IBM ThinkPad R32 Series
Multiple Transmitters model
(with Cisco Aironet Wireless 802.11b)**

FCC ID : ANODS1WSHR

May 16, 2002

<p>This report concerns: (check one)</p> <p>Original Grant <input checked="" type="checkbox"/> _____</p> <p>Class I change <input type="checkbox"/> _____</p> <p>Class II change <input type="checkbox"/> _____</p>
<p>Equipment type: <u>Wireless LAN device</u></p>
<p>This report shall not be reproduced except in full, without the written permission of this test lab.</p>
<p>The measurement results contained in this report relate only to the item which was tested.</p>
<p>Measurement procedure used is ANSI C63.4-2000 unless otherwise specified.</p>
<p>Other test procedure: _____</p>
<p>The FCC has issued provisional acceptance of this test laboratory for Declaration of Conformity testing per letter dated 1997.</p>
<p><i>APPLICANT ANTI-DRUG ABUSE CERTIFICATION:</i></p> <p>By checking yes, the applicant certifies that, in the case of an individual applicant, he or she is not subject to a denial of federal benefits, that includes FCC benefits, pursuant to Section 5301 of the Anti-Drug Abuse of 1988, 21 U.S.C. 853(a), or, in the case of a non-individual applicant (e.g. corporation, partnership or other unincorporated association), no party to the application is subject to a denial of federal benefits, that includes FCC benefits, pursuant to that section. For the definition of a “party” for these purposes, see 47 CFR 1.2002(b).</p> <p style="text-align: center;"><input checked="" type="radio"/> Yes or No</p>
<p>“Report shall not be reproduced except in full, without the written approval of the laboratory” “the report must not be used by the client to claim product endorsement by NVLAP or any agency of the US government”</p>
<p>Prepared by: Takeshi Asano</p> <p style="text-align: right;">IBM Japan Corporation, Yamato EMC Engineering LAB-S59, 1623-14, Shimotsuruma, Yamato-shi Kanagawa-ken 242-8502, Japan Tel: +81-46-215-4779 Fax: +81-46-273-7420</p>

- Index -

MEASUREMENT / TECHNICAL REPORT – PART 15 SUBPART C2

A. GENERAL INFORMATION.....3

A.1 TEST METHODOLOGY3

A.2 TEST FACILITY / NVLAP ACCREDITATION3

A.3 EUT DETAILS3

B. SUMMARY OF TEST RESULTS4

C. OPERATION MODE OF EUT.....5

D. TEST INSTRUMENTS.....6

E. JUSTIFICATION.....7

F. MEASUREMENT UNCERTAINTY.....7

G. RELATED SUBMITTAL(S)/GRANT(S)/NOTES7

1. BANDWIDTH AT 6 DB BELOW.....8

1.1 TEST PROCEDURE.....8

1.2 TEST INSTRUMENTS AND MEASUREMENT SETUP.....8

1.3 MEASUREMENT RESULTS.....8

1.4 TRACE DATA.....9

2. OCCUPIED BANDWIDTH / BAND-EDGE (AT 20 DB BELOW), AND OUT OF BAND EMISSIONS12

2.1 TEST PROCEDURE.....12

2.2 TEST INSTRUMENTS AND MEASUREMENT SETUP.....12

2.3 MEASUREMENT RESULTS OF OCCUPIED BANDWIDTH / BAND-EDGE.....12

2.4 MEASUREMENT RESULTS OF OUT OF BAND EMISSIONS12

2.5 TRACE DATA OF BAND-EDGE.....13

2.6 TRACE DATA OF OUT OF BAND EMISSIONS16

3. TRANSMITTER OUTPUT POWER.....19

3.1 TEST PROCEDURE.....19

3.2 MEASUREMENT RESULTS.....19

4. TRANSMITTER POWER SPECTRAL DENSITY21

4.1 TEST PROCEDURE.....21

4.2 TEST INSTRUMENTS AND MEASUREMENT SETUP.....21

4.3 MEASUREMENT RESULTS.....21

4.4 TRACE DATA.....22

5. AC WIRELINE CONDUCTED EMISSIONS (450KHZ – 30MHZ)25

5.1 TEST PROCEDURE.....25

5.2 TEST INSTRUMENTS AND MEASUREMENT SETUP.....25

5.3 MEASUREMENT RESULTS.....26

6. RESTRICTED BANDS RADIATIONS (30MHZ – 1GHZ)28

6.1 TEST PROCEDURE.....28

6.2 TEST INSTRUMENTS AND MEASUREMENT SETUP.....28

6.3 FIELD STRENGTH CALCULATION.....30

6.4 MEASUREMENT RESULTS.....31

7. RESTRICTED BANDS RADIATIONS (1GHZ – 25GHZ)33

7.1 TEST PROCEDURE.....33
7.2 TEST INSTRUMENTS AND MEASUREMENT SETUP.....33
7.3 FIELD STRENGTH CALCULATION.....34
7.4 MEASUREMENT RESULTS.....35

A. GENERAL INFORMATION

APPLICANT	: IBM Japan, Ltd.
TEST SITE	: IBM Japan Ltd., Yamato Semi-anechoic chamber #1
TEST SITE ADDRESS	: 1623 – 14 Shimotsuruma, Yamato-shi, Kanagawa 242-8502 Japan Tel: +81-46-215-4779, Fax: +81-46-273-7420
REGULATION	: FCC Part 15 Subpart C Industry Canada RSS-210 (Issue No.5)
MODEL NAME	: ThinkPad R32 Series, Multiple Transmissions model
FCC ID	: ANODS1WSHR
IC Certification Number	: 349E-U58H004
SERIAL NUMBER	: 00D059BC045E
PHYSICAL CONDITION	: Preproduction
KIND OF EQUIPMENT	: IEEE802.11b Wireless LAN Mini-PCI card (DSSS)
TESTED DATE	: May, 07, 08, 09 and 10, 2002

A.1 Test Methodology

Both conducted and radiated testing were performed according to the procedures in ANSI C63.4-2000. Radiated testing was performed at an antenna to EUT distance of 3 meters.

A.2 Test Facility / NVLAP Accreditation

The semi-anechoic chamber #2 used to correct the data are located in Yamato Laboratory, IBM Japan.

- This facility has been fully described in a report dated September 1998, submitted to the FCC office, and accepted in a letter, dated Nov. 2, 1998(31040/SIT).
- This facility is accepted by **Industry Canada** in a letter dated March 19, 2001 as number **IC 349E** for chamber #2, and January 25, 2002 as number **IC 4221** for chamber #1.
- IBM Yamato EMC Engineering is recognized under the National Voluntary Laboratory Accreditation Program for satisfactory compliance with Criteria established in Title 15, Part 285 Code of Federal Regulations.(NVLAP Lab code: 200198-0)

A.3 EUT details

Table A EUT details

Model and S/N	FCC ID	Description
Cisco Aironet Wireless 802.11b 00D059BC045E	N/A	Wireless LAN Mini-PCI card
ThinkPad R32 M/T 2358-CHU (s/n AA-GFWCD)	ANODS1WSHR	IBM Notebook PC CPU: Intel® Mobile Pentium® 4, clock 1.7GHz
P/N 02K6665	N/A	Universal AC adapter 72W, Unshielded power cord

B. SUMMARY OF TEST RESULTS

Table-B presents the list of the measurement items for Spread Spectrum, Direct Sequence devices under FCC Part 15 Subpart C and Industry Canada RSS-210.

The section numbers of upper portion are showing FCC number, and the other (lower) ones are for IC.

Table-B List of the measurements

Section(s)	Test Items		Condition	Result
	Transmit mode (TX):			
15.247(a)(2) 5.9.1	Bandwidth at 6 dB below		Conducted	Pass
15.247(c) 5.9.1 6.2.2 (o) (e1)	Occupied BW (or Band-edge) Out of Band Emissions (Bandwidth at 20 dB below)	The radiated emission in any 100kHz of outband shall be at least 20dB below the highest inband spectral density.	Conducted	Pass
15.247(b) 6.2.2 (o) (b)	Transmitter output power		Conducted	Pass
15.247(d) 6.2.2 (o) (b)	Transmitter power spectral Density		Conducted	Pass
15.247(e) 6.2.2 (o) (b)	Processing gain		/	
15.207 6.6	AC Wireline Conducted Emissions 450kHz – 30MHz	Class B: 250µV	Conducted	Pass
15.205 / 209 6.2.1 / 6.3	General Field Strength Limits (Restricted Bands and Radiated Emission Limits)	Shall not exceed the limits specified in FCC 15.209 or RSS-210 Table3.	Radiated (30MHz - 1GHz)	Pass
			Radiated (1– 25GHz)	Pass
Receive mode (RX):				
15.207 7.4	AC Wireline Conducted Emissions 450kHz – 30MHz	Class B: 250µV	Conducted	Pass
15.209 7.3	General Field Strength Limits (Radiated Emission Limits)	Shall not exceed the limits specified in RSS-210.	Radiated (30MHz - 1GHz)	Pass
			Radiated (1– 25GHz)	Pass

C. OPERATION MODE OF EUT

All tests were performed using the “PRISM Test Utility Program”, Version 3.0.24. Three kinds of modulation are used for transmission with appropriate bit rates:

Table C-1 Transmit mode (TX)

Operation Frequency [GHz]	Rated output power (conducted) [dBm]			Test performed*
	Bit rate 2Mbps	Bit rate 5.5Mbps	Bit rate 11Mbps	
2.412 (Ch. 1)	+15	+15	+15	X
2.417 (Ch. 2)	+15	+15	+15	
2.422 (Ch. 3)	+15	+15	+15	
2.427 (Ch. 4)	+15	+15	+15	
2.432 (Ch. 5)	+15	+15	+15	
2.437 (Ch. 6)	+15	+15	+15	X
2.442 (Ch. 7)	+15	+15	+15	
2.447 (Ch. 8)	+15	+15	+15	
2.452 (Ch. 9)	+15	+15	+15	
2.457 (Ch. 10)	+15	+15	+15	
2.462 (Ch. 11)	+15	+15	+15	X

* Full testing with bit rate 11Mbps only

Table C-2 Receive mode (RX)

Operation Frequency [GHz]	Test performed
2.412 (Ch. 1)	
2.417 (Ch. 2)	
2.422 (Ch. 3)	
2.427 (Ch. 4)	
2.432 (Ch. 5)	
2.437 (Ch. 6)	X
2.442 (Ch. 7)	
2.447 (Ch. 8)	
2.452 (Ch. 9)	
2.457 (Ch. 10)	
2.462 (Ch. 11)	

D. TEST INSTRUMENTS

Table-D List of Measuring Instruments

Description	Model	Serial Number	Calibration Date	Calibration Interval
Computer	IBM 5551-L	#4	N/A	N/A
Computer	IBM 6589-13J	97-15613	N/A	N/A
Spectrum Analyzer (100Hz-1.5GHz)	HP 85680B	3019A05155	02/15/02	1 year
Spectrum Analyzer (100Hz-1.5GHz)	HP 85680B	2601A02634	02/15/02	1 year
Spectrum Analyzer (100Hz-1.5GHz)	HP 85680B	2841A04242	10/18/01	1 year
Spectrum Analyzer Display	HP 85662A	3026A19353	02/15/02	1 year
Spectrum Analyzer Display	HP 85662A	2542A12308	02/15/02	1 year
Spectrum Analyzer Display	HP 85662A	2816A16827	10/18/01	1 year
Quasi-Peak Adapter	HP 85650A	3033A01449	02/15/02	1 year
Quasi-Peak Adapter	HP 85650A	2043A00062	02/15/02	1 year
Quasi-Peak Adapter	HP 85650A	2811A01126	10/18/01	1 year
Amplifier (100KHz - 1.3GHz) - for 30-200MHz - for 200-1000MHz	HP 8447D HP 8447D	2805A02919 2944A03506	04/15/02 04/15/02	1 year 1 year
Amplifier (1GHz - 26.5GHz)	HP 8449B	3008A00582	05/23/01	1 year
Spectrum Analyzer EMI Test Receiver	R&S ESI26	836119/003	07/04/01	1 year
Receiver (9kHz-30MHz)	R&S ESH3	891806/012	09/28/01	1 year
Receiver (20MHz-1.3GHz)	R&S ESVP	893202/018	02/09/02	1 year
Biconical Antenna (30-200MHz)	EMCO 3108	2531	05/24/01	1 year
Log-Periodic Antenna (200-1000MHz)	EMCO 3146	2849	05/06/02	1 year
Horn Antenna (1- 18GHz)	EMCO 3115	9903-5774	04/23/02	1 year
Horn Antenna (3.95- 5.85GHz)	EMCO 3160-5	1099	04/26/02	1 year
Horn Antenna (5.85- 8.20GHz)	EMCO 3160-6	9712-1044	04/26/02	1 year
Horn Antenna (18- 26.5GHz)	EMCO 3160-9	0004-1202	05/01/02	1 year
LISN	EMCO 3825/2	1426	09/01/01	1 year
Power Meter	HP 437B	3043U03437	09/06/01	1 year
Power Sensor	HP 8481A	US41030582	09/07/01	1 year
Switch/control unit	HP 3488A	2719A17229 2719A17228	N/A N/A	N/A N/A
Plotter	HP 7550A	2631A33619	N/A	N/A
SF106 cables: - Horn Ant <=> RF Amp. - RF Amp.<=>Spectrum Analyzer	Length: 6 m 15m	- EM206SCO - EM215SCO	08/07/01 08/07/01	1 year 1 year
N-Coax cables: - Bi-coni Ant <=> 10m Cable - 10m Cable <=> Shield Panel - Shield Panel <=> RF Amp - RF Amp <=> Power Splitter - Log-peri Ant <=> 5m Cable - 5m Cable <=> Shield Panel	6 m 10 m 7 m 0.5m 9 m 5m	- EM103L01 - EM103L02 - EM103L03 - EM103L04 - EM103H01 - EM103H02	04/15/02 04/15/02 04/15/02 04/15/02 04/15/02 04/15/02	1 year 1 year 1 year 1 year 1 year 1 year

- Shield Panel <=> RF Amp	7 m	- EM103H03	04/15/02	1 year
- RF Amp <=> Power Splitter	0.5m	- EM103H04	04/15/02	1 year
Coax cables:				
- Lism-L <=> SW/Con.unit (SW101)	4 m	- EMIC-L	04/15/02	1 year
- Lism-N <=> SW/Con.unit (SW303)	4 m	- EMIC-N	04/15/02	1 year
- SW/Con.unit <=> RCVR (Input)	2 m	- EMIC-R	04/15/02	1 year
- SW/Con.unit <=> Spe Ana.(Signal In)	1 m	- EMIC-S	04/15/02	1 year
- Power Splitter <=> SW/Con.unit (SW101)	1 m	- EM103L05	04/15/02	1 year
- Power Splitter <=> SW/Con.unit (SW303)	1 m	- EM103L06	04/15/02	1 year
- Power Splitter <=> SW/Con.unit (SW101)	1 m	- EM103H05	04/15/02	1 year
- Power Splitter <=> SW/Con.unit (SW303)	1 m	- EM103H06	04/15/02	1 year
- SW/Con.unit <=> Receiver (Input)	2 m	- EM2RCV	04/15/02	1 year
- SW/Con.unit <=> Spe Ana.(Signal In) for 30- 200MHz	2 m	- EM1SPL	04/15/02	1 year
- SW/Con.unit <=> Spe Ana.(Signal In) for 200-1000MHz	2 m	- EM1SPH	04/15/02	1 year

Notes.

- The above equipment calibration is traceable to National standards.
- HP: Hewlett Packard, R&S: Rohde & Schwarz

E. JUSTIFICATION

The EUT was investigated for both the main(left) and the auxiliary(hinge) antennas. The worse case data taken in this report represents the measurement results of the left antenna to have comparatively higher gain.

Left Antenna	Gain: 0.55 dBi (peak)	Conducted Power: 19.9 dBm (maximum)
Hinge Antenna	Gain:-0.94 dBi (peak)	Conducted Power: 19.6 dBm (maximum)

F. MEASUREMENT UNCERTAINTY

Uncertainties of the both, the Yamato EMI radiated test facilities (EMI chambers, #1 and #2) and the Yamato EMI conducted test facility are derived with the NIS 81 " Treatment of uncertainty in EMC measurements" 1994.

Estimated site uncertainty values are as follows.

- EMI chamber #1 : 4.17dB
- EMI chamber #2 : 4.18dB
- EMI conducted measurement system : 2.4dB

Detail should be referred to "Treatment of Uncertainty, Calculations and Policy" report, document number TCR 10-0015.

G. Related Submittal(s)/Grant(s)/Notes

The host unit with full peripheral devices including the applying modular as an unintentional radiator is classified as a Digital Device under the FCC Part 15 Subpart B or the Industry Canada Class B Emission Compliance (ICES-003), and subject to SDoC.

1. Bandwidth at 6 dB below

1.1 Test Procedure

The bandwidth at 6 dB down from the highest inband spectral density is measured with a spectrum analyzer connected to the antenna terminal, while EUT is operating in transmission mode at the appropriate center frequency.

The spectrum analyzer is set to :

RBW=100kHz, VBW=100kHz*1, Span=30MHz, Sweep=suitable duration based on the EUT specification

*1: To be adjusted accordingly based on the spectrum stability

1.2 Test Instruments and Measurement Setup

Table 1-1 : 6 dB Bandwidth Test Instruments

Description	Model	Serial Number
Spectrum Analyzer EMI Test Receiver	R&S ESI26	836119/003
Coax cables: - Spectrum Analyzer <=> EUT	Length: 120 cm Loss: 1.7 dB	

Notes: - R&S: Rohde & Schwarz

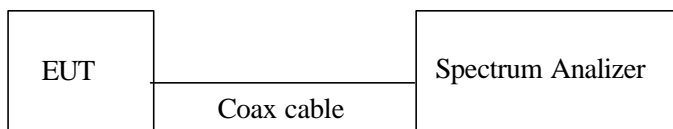

Figure 1: Measurement setup for 6dB bandwidth test

1.3 Measurement Results

Test Date: May 09, 2002

Table 1-2. EUT: M/T 2658-CGU, s/n AA-GFWCD , TX mode 11Mbps

Center Frequency (MHz)	Lower frequency (MHz)	Upper frequency (MHz)	Bandwidth at 6 dB below (MHz)
2412 (ch. 1)	2407.40	2417.92	10.52
2437 (ch. 6)	2432.40	2442.92	10.52
2462 (ch. 11)	2457.40	2467.92	10.52

1.4 Trace Data

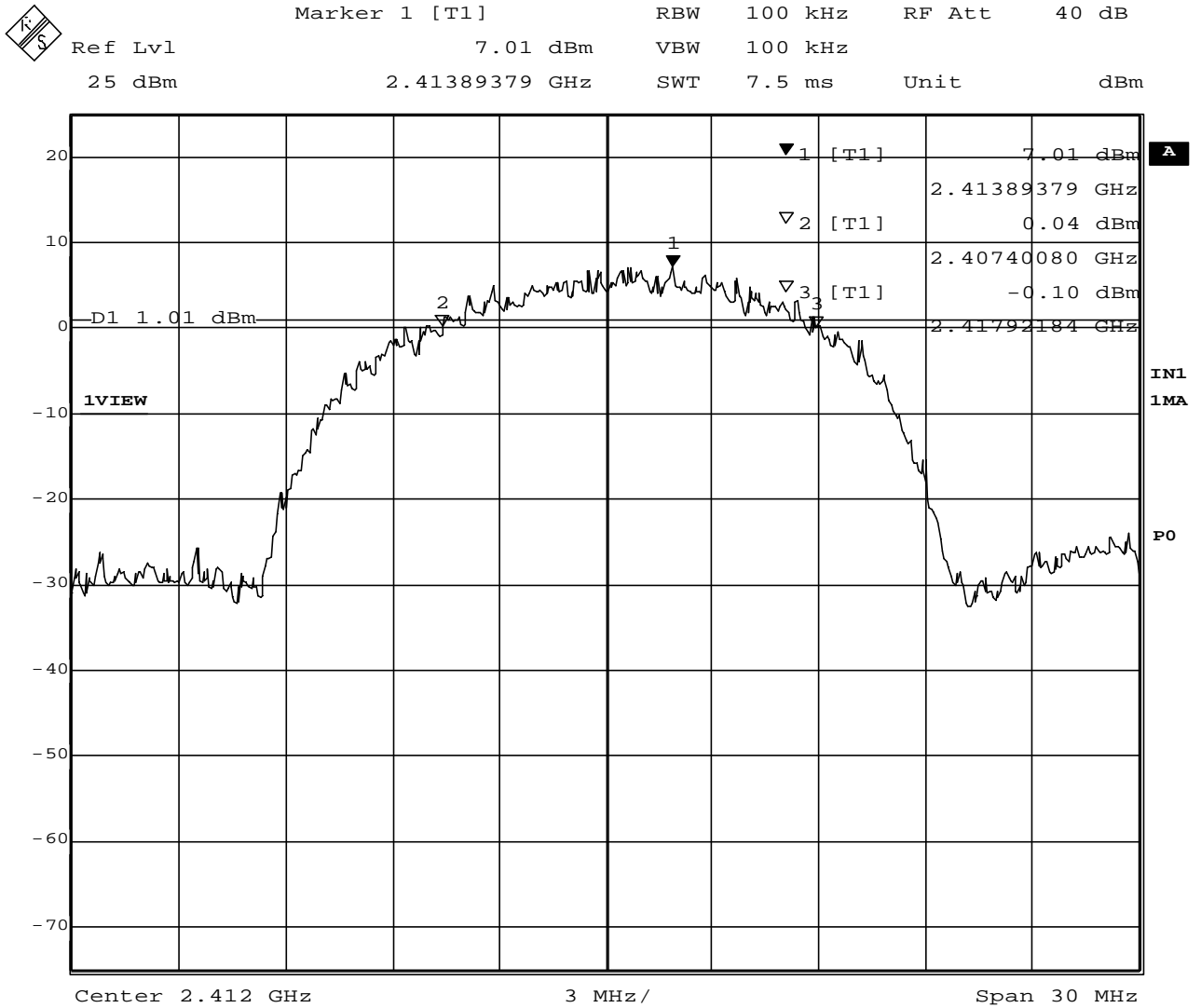

Date: 9.MAY.2002 14:49:45



Ref Lvl	Marker 1 [T1]	RBW	100 kHz	RF Att	40 dB
25 dBm	6.17 dBm	VBW	100 kHz		
	2.43889379 GHz	SWT	7.5 ms	Unit	dBm

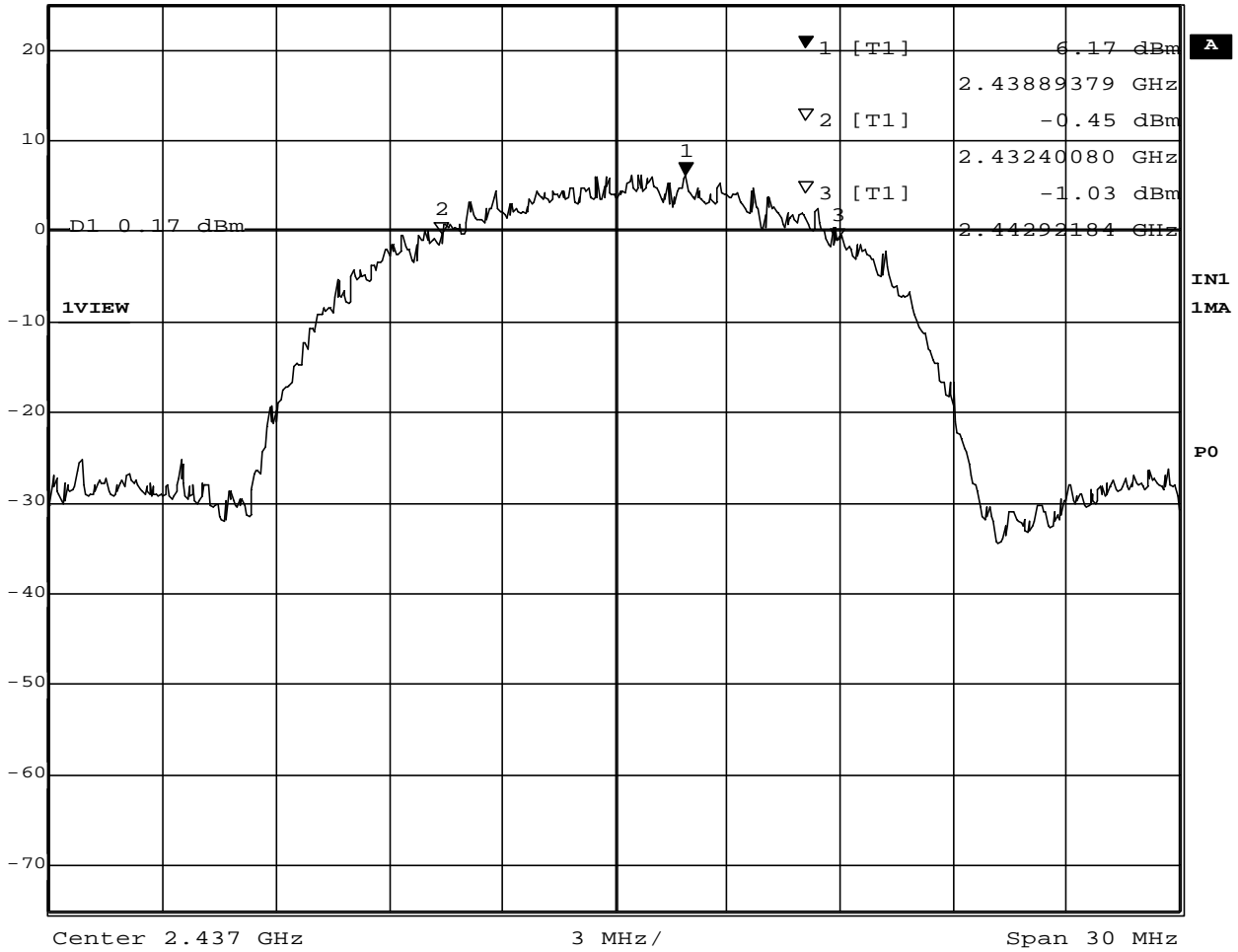

Date: 9.MAY.2002 14:45:32



Ref Lvl	Marker 1 [T1]	RBW	100 kHz	RF Att	40 dB
25 dBm	5.64 dBm	VBW	100 kHz		
	2.46389379 GHz	SWT	7.5 ms	Unit	dBm

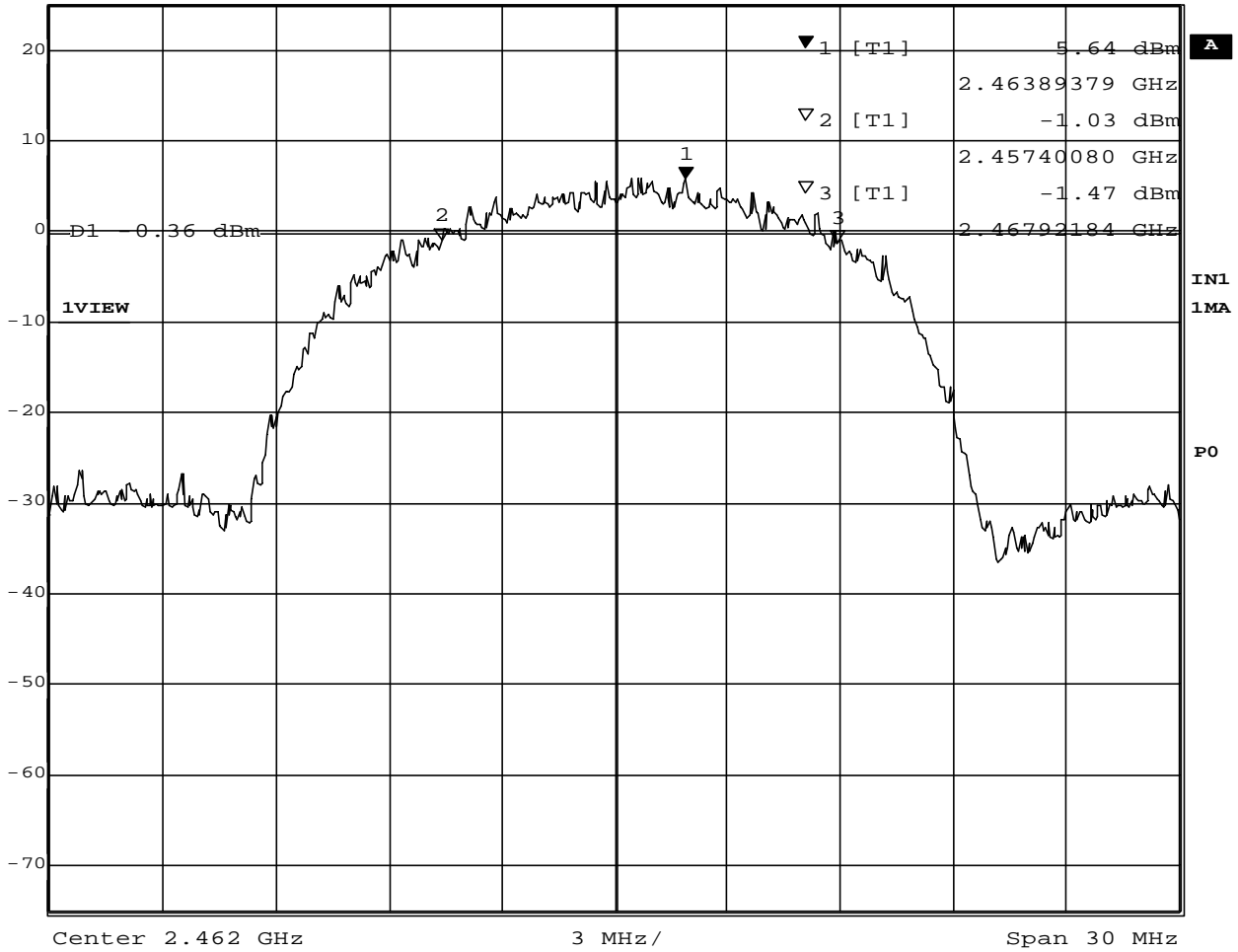

Date: 9.MAY.2002 15:00:23

2. Occupied Bandwidth / Band-edge (at 20 dB below), and Out of Band Emissions

2.1 Test Procedure

The bandwidth at 20 dB down from the highest inband spectral density is measured with a spectrum analyzer connected to the antenna terminal, while EUT is operating in transmission mode at the appropriate center frequency.

The spectrum analyzer is set to:

RBW=100kHz, VBW=100kHz*1, Span=30MHz, Sweep=suitable duration based on the EUT specification

*1: To be adjusted accordingly based on the spectrum stability

2.2 Test Instruments and Measurement Setup

Same as the Chapter 1(Table 1-1 & Figure 1).

2.3 Measurement Results of Occupied Bandwidth / Band-edge

Test Date: May 09, 2002

Table 2-1. EUT: M/T 2658-CHU, s/n AA-GFWCD , TX mode 11Mbps

Center Frequency (MHz)	Lower Frequency (MHz)	Upper Frequency (MHz)	Bandwidth at 20 dB below (MHz)	Margin to Lower limit (MHz)	Margin to Upper limit (MHz)
2412 (ch. 1)	2403.63	2420.56	16.93	3.63	
2437 (ch. 6)	2428.63	2445.57	16.94		
2462 (ch. 11)	2453.63	2470.576	16.95		12.92

2.4 Measurement Results of Out of Band Emissions

All conducted emission in any 100kHz bandwidth outside of the spread spectrum band was at least 20dB lower than the highest inband spectral density.

Test Date: May 09, 2002

2.5 Trace Data of Band-edge

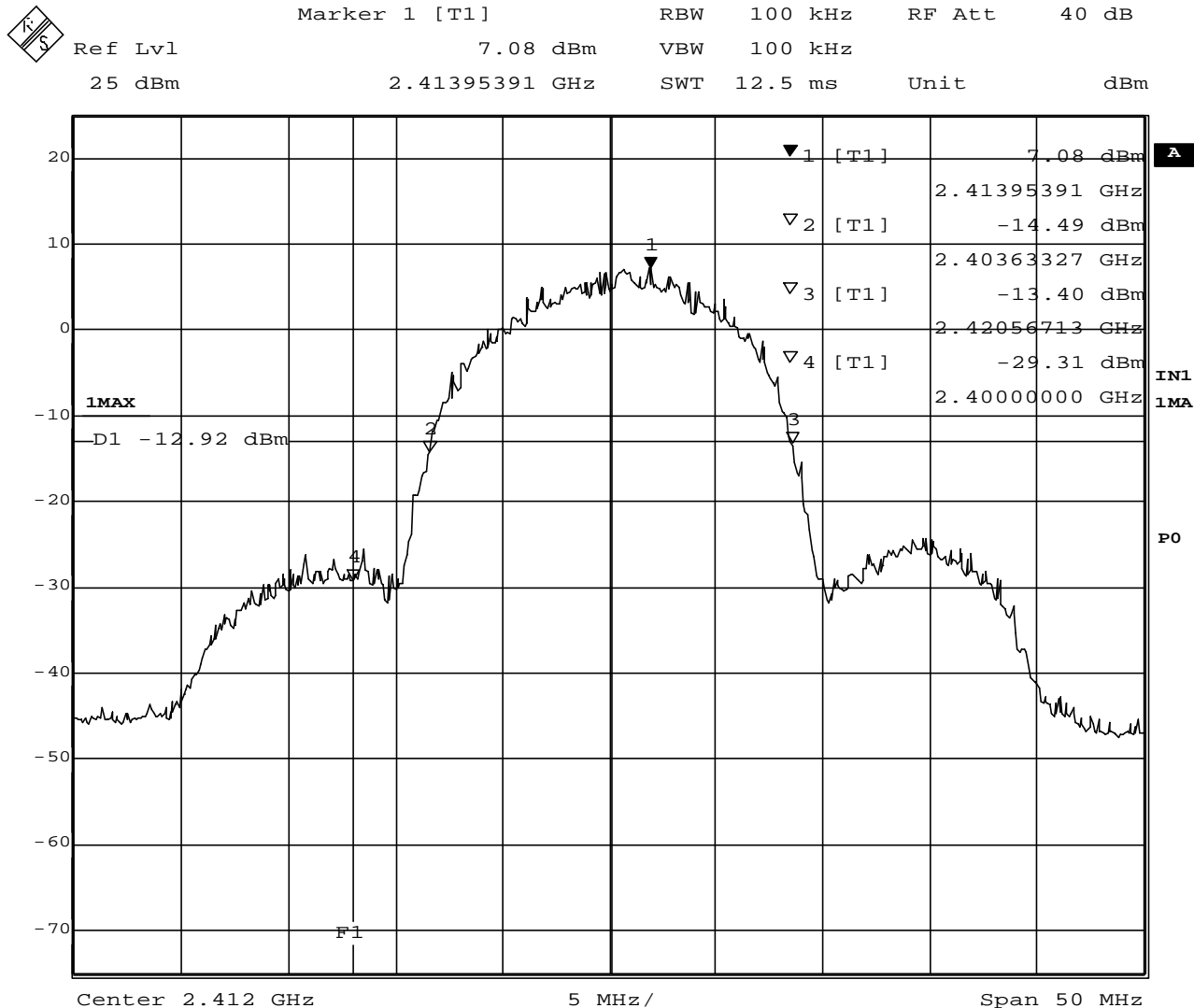

Date: 9.MAY.2002 14:27:06



Marker 1 [T1] RBW 100 kHz RF Att 40 dB
 Ref Lvl 6.24 dBm VBW 100 kHz
 25 dBm 2.43895391 GHz SWT 12.5 ms Unit dBm

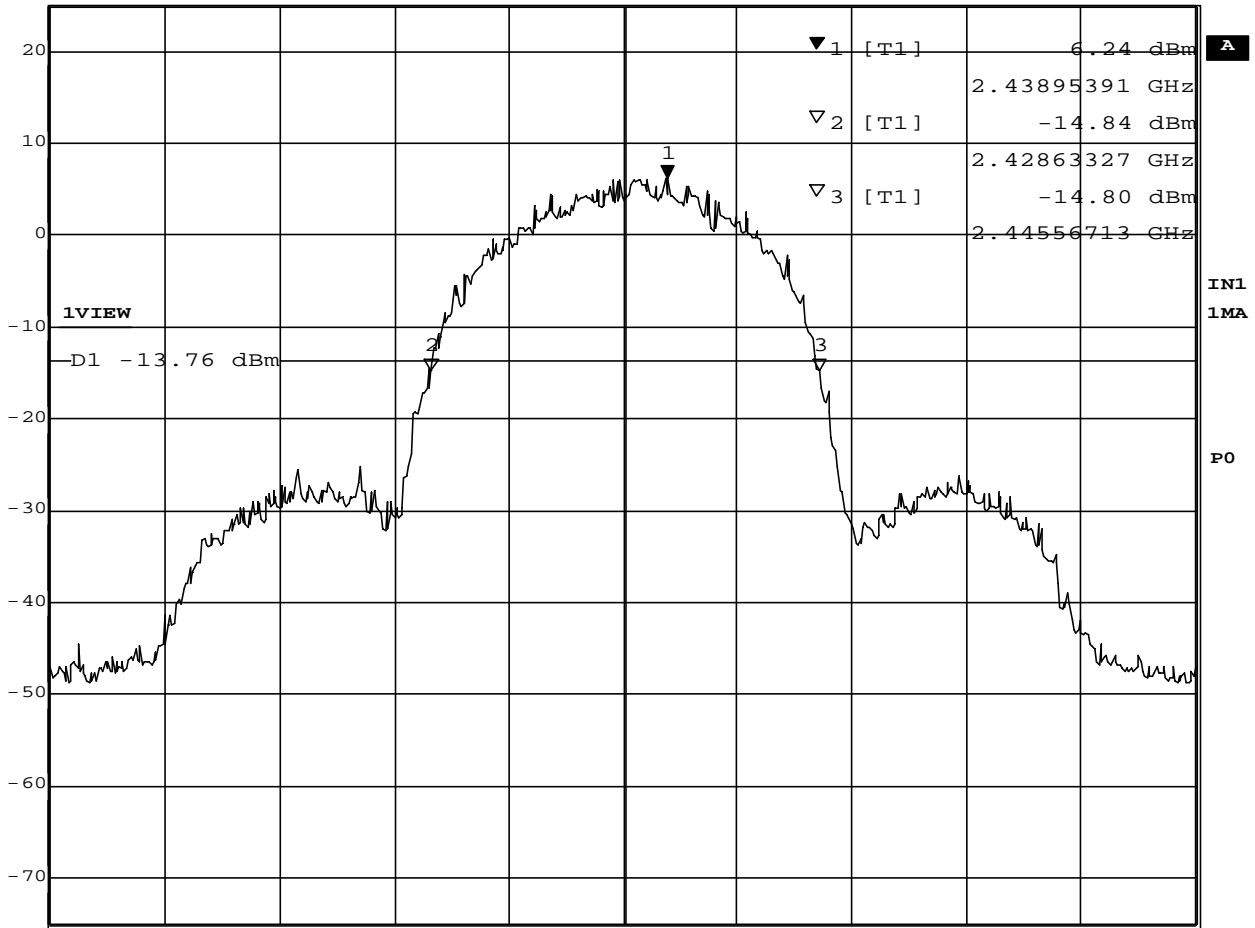

Center 2.437 GHz 5 MHz/ Span 50 MHz

Date: 9.MAY.2002 14:57:39



Marker 1 [T1]	RBW	100 kHz	RF Att	40 dB
Ref Lvl	5.76 dBm	VBW	100 kHz	
25 dBm	2.46395391 GHz	SWT	12.5 ms	Unit dBm

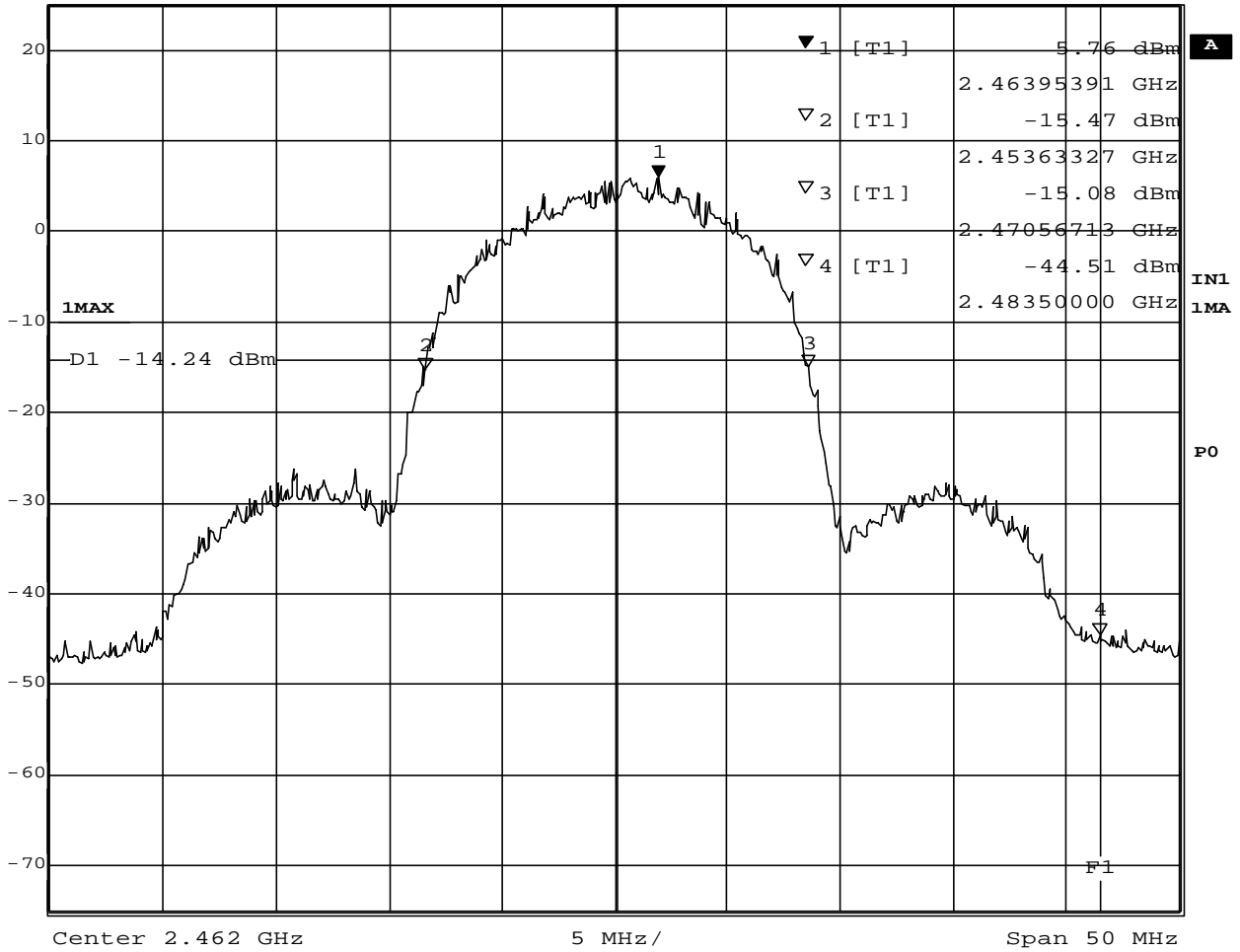

Date: 9.MAY.2002 14:22:43

2.6 Trace Data of Out of Band Emissions

	Marker 1 [T1]	RBW	100 kHz	RF Att	40 dB
	Ref Lvl	7.14 dBm	VBW	100 kHz	
	25 dBm	2.41390381 GHz	SWT	25 ms	Unit dBm

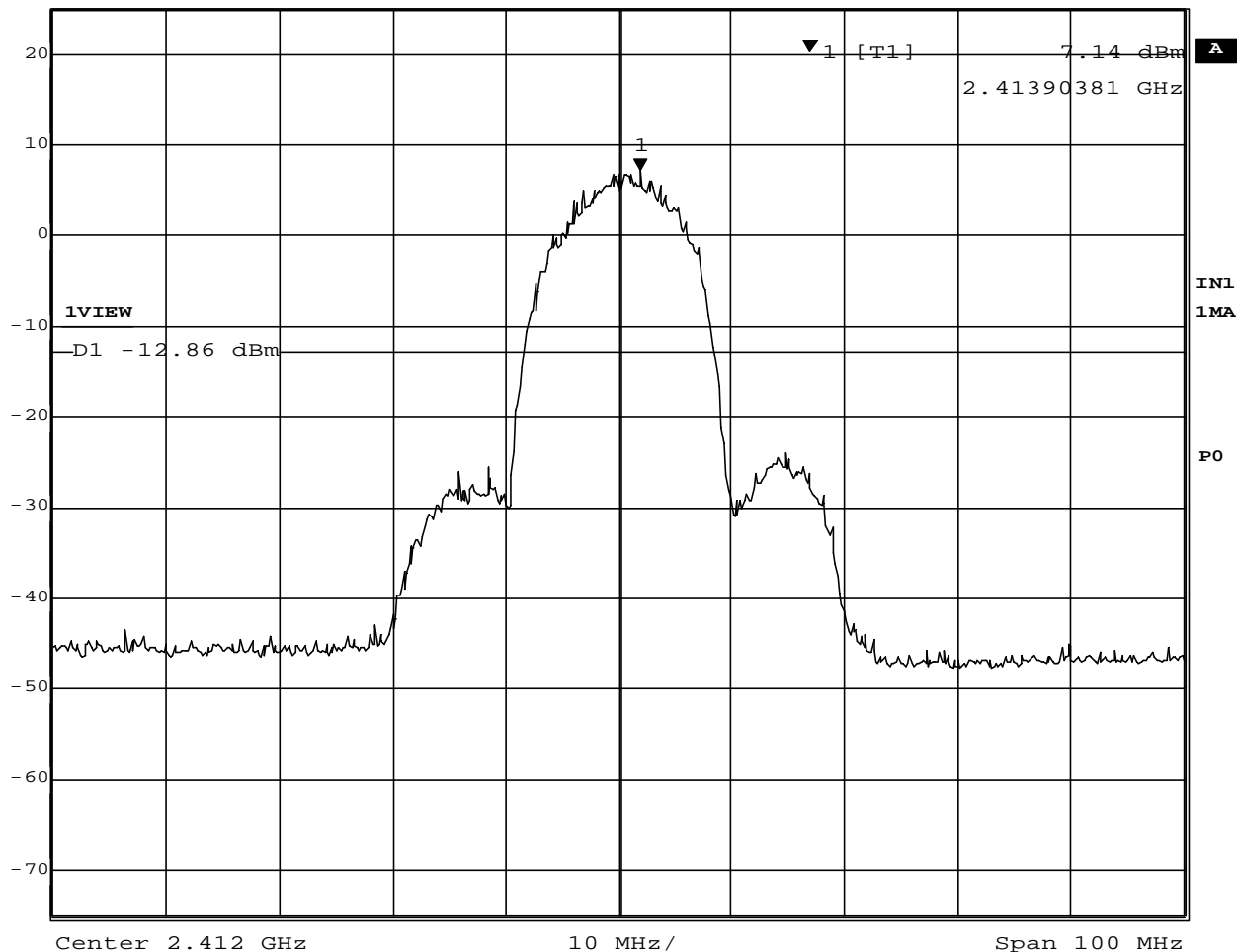

Date: 9.MAY.2002 14:35:37



Ref Lvl	Marker 1 [T1]	RBW	100 kHz	RF Att	40 dB
25 dBm	6.33 dBm	VBW	100 kHz		
	2.43890381 GHz	SWT	25 ms	Unit	dBm

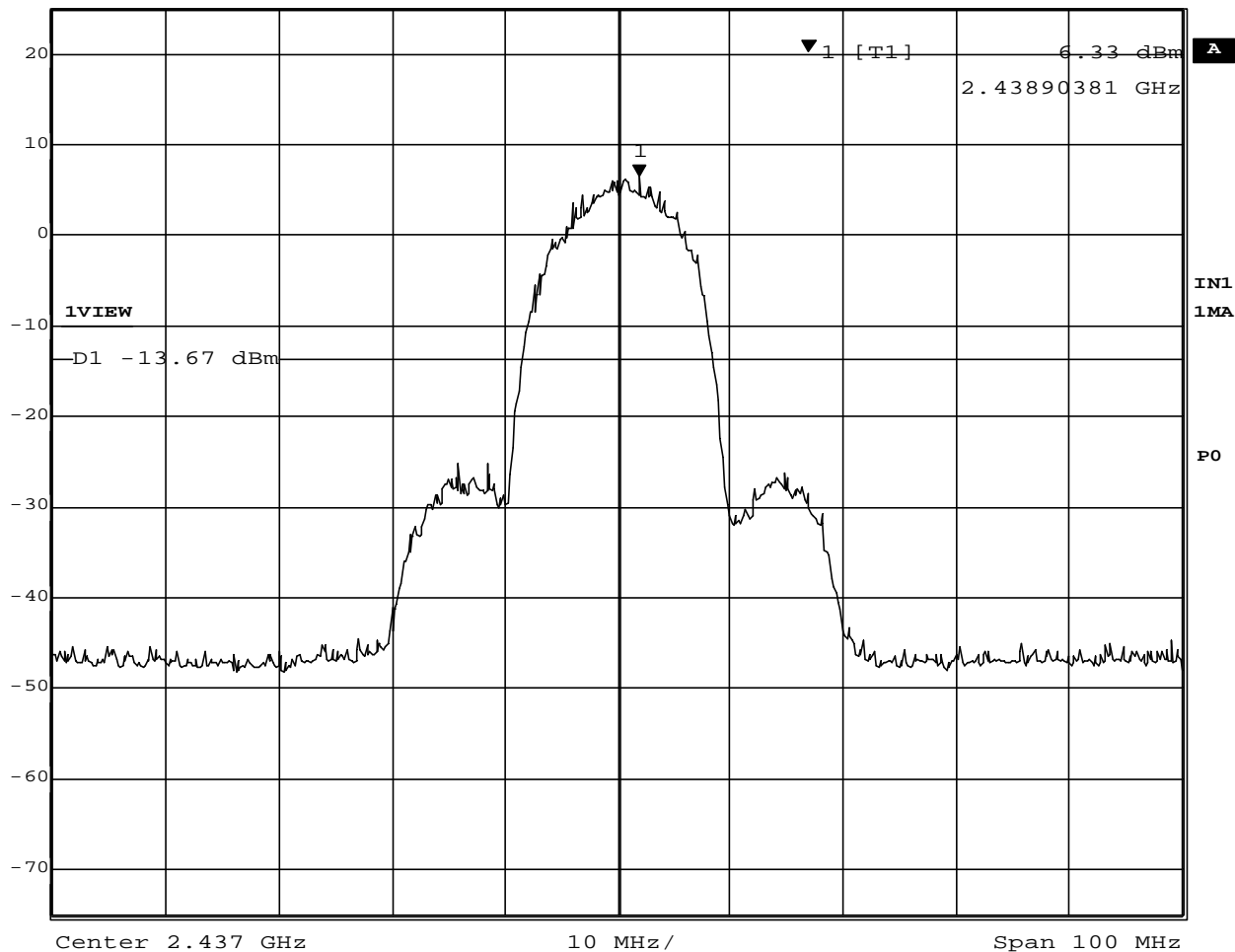

Date: 9.MAY.2002 14:37:07



Ref Lvl	Marker 1 [T1]	RBW	100 kHz	RF Att	40 dB
25 dBm	5.85 dBm	VBW	100 kHz		
	2.46390381 GHz	SWT	25 ms	Unit	dBm

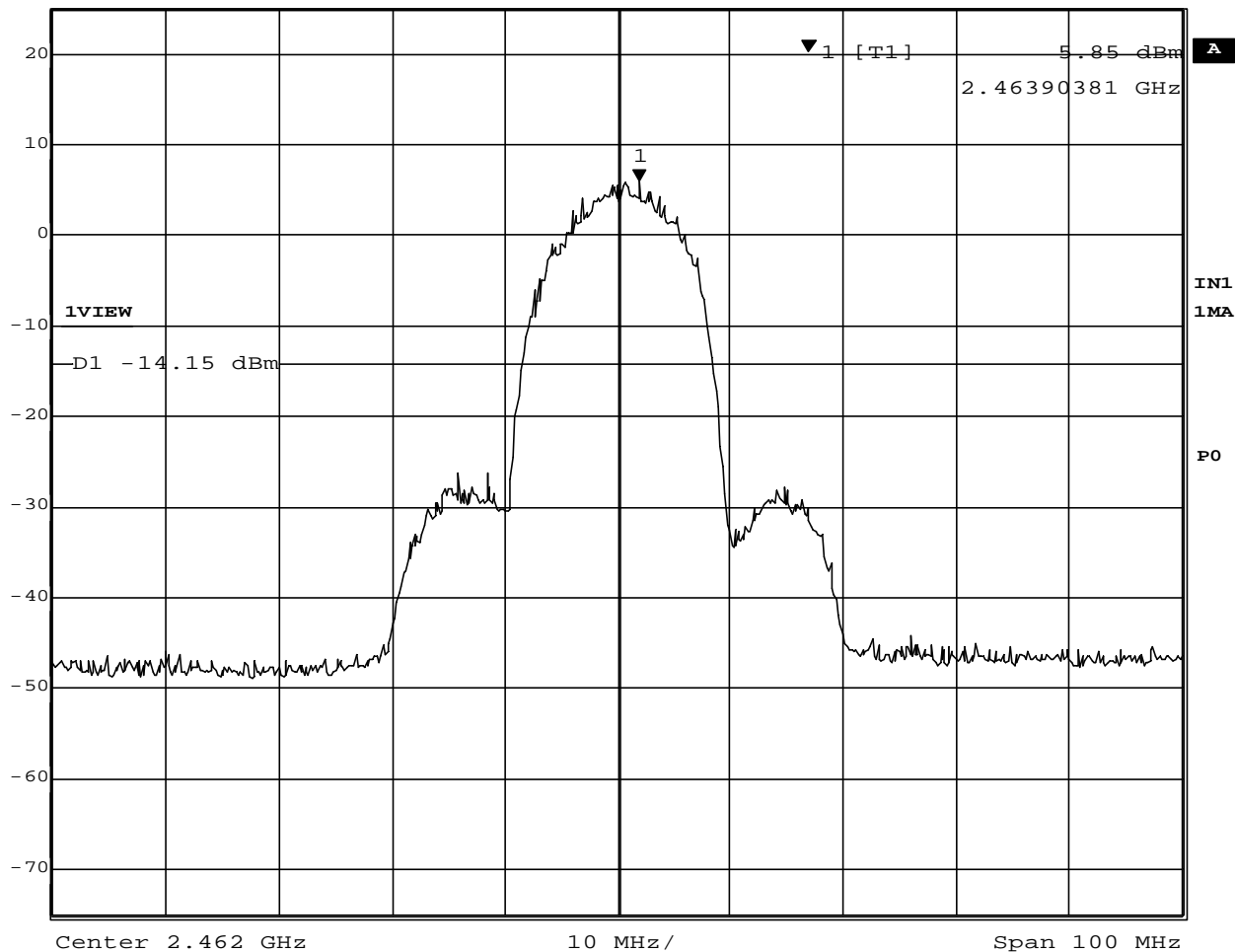

Date: 9.MAY.2002 14:38:28

3. Transmitter Output Power

3.1 Test Procedure

- A transmitter antenna terminal of EUT is connected to the input of a RF power sensor.
- Measurement is made while EUT is operating in transmission mode at the appropriate center frequency.

Table 3-1 : 6 dB Bandwidth Test Instruments

Description	Model	Serial Number
Power Meter	HP 437B	3043U03437
Power Sensor	Agilent 8481A	US41030582
Coax cables: - Power Sensor <=> EUT	Length: 30 cm Loss: 1.1dB	

Notes: - HP: Hewlett Packard

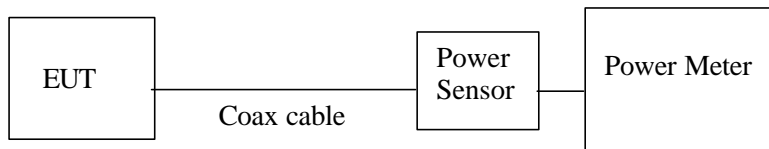

Figure 3: Measurement setup for RF output power

3.2 Measurement Results

Test Date: May 07, 2002

Table 3-2. EUT: M/T 2358-CHU, s/n AA-GFWCD, A0 port (left antenna), TX mode 11Mbps

Measured Frequency (MHz)	Power Meter Reading (dBm)	Cable Loss (dB)	Results		Limit [1W] (dBm)	Margin (dB)
			(dBm)	(W)		
2412 (ch. 1)	18.8	1.1	19.9	0.0977	30.0	10.1
2437 (ch. 6)	18.5	1.1	19.6	0.0912	30.0	10.4
2462 (ch. 11)	17.6	1.1	18.7	0.0741	30.0	11.3

Table 3-3. EUT: M/T 2358-CHU, s/n AA-GFWCD, A0 port (left antenna), TX mode 2Mbps

Measured Frequency (MHz)	Power Meter Reading (dBm)	Cable Loss (dB)	Results		Limit [1W] (dBm)	Margin (dB)
			(dBm)	(W)		
2412 (ch. 1)	18.7	1.1	19.8	0.0955	30.0	10.2
2437 (ch. 6)	18.1	1.1	19.2	0.0832	30.0	10.8
2462 (ch. 11)	17.4	1.1	18.5	0.0708	30.0	11.5

Table 3-3. EUT: M/T 2358-CHU, s/n AA-GFWCD, A1 port (hinge antenna), TX mode 11Mbps

Measured Frequency (MHz)	Power Meter Reading (dBm)	Cable Loss (dB)	Results		Limit [1W] (dBm)	Margin (dB)
			(dBm)	(W)		
2412 (ch. 1)	18.5	1.1	19.6	0.0912	30.0	10.4
2437 (ch. 6)	18.1	1.1	19.2	0.0832	30.0	10.8
2462 (ch. 11)	17.2	1.1	18.3	0.0832	30.0	11.7

Table 3-4. EUT: M/T 2358-CHU, s/n AA-GFWCD, A1 port (hinge antenna), TX mode 2Mbps

Measured Frequency (MHz)	Power Meter Reading (dBm)	Cable Loss (dB)	Results		Limit [1W] (dBm)	Margin (dB)
			(dBm)	(W)		
2412 (ch. 1)	18.5	1.1	19.6	0.0912	30.0	10.4
2437 (ch. 6)	17.9	1.1	19.0	0.0794	30.0	11.0
2462 (ch. 11)	17.2	1.1	18.3	0.0676	30.0	11.7

4. Transmitter Power Spectral Density

4.1 Test Procedure

The peak power density is measured with a spectrum analyzer connected to the antenna terminal, while EUT is operating in transmission mode at the appropriate center frequency.

The spectrum analyzer is set to:

RBW= 3kHz, VBW=100kHz, Span=10MHz, Sweep = 2.8 seconds

4.2 Test Instruments and Measurement Setup

Same as the Chapter 1(Table 1-1 & Figure 1).

4.3 Measurement Results

Test Date: May 09, 2002

Table 4-1. EUT: M/T 2358-CHU, s/n AA-GFWCD , TX mode 11Mbps

Ch No.	Frequency (MHz)	Spectrum Analyzer Reading (dBm)	Cable loss (dB)	Result (dBm)	Limit (dBm)	Margin (dB)
1	2413.39	-5.5	1.7	-3.8	8.0	11.8
6	2438.39	-6.1	1.7	-4.4	8.0	12.4
11	2463.39	-6.7	1.7	-5.0	8.0	13.0

4.4 Trace Data

 Marker 1 [T1] RBW 3 kHz RF Att 40 dB
Ref Lvl -5.49 dBm VBW 100 kHz
25 dBm 2.41339279 GHz SWT 2.8 s Unit dBm

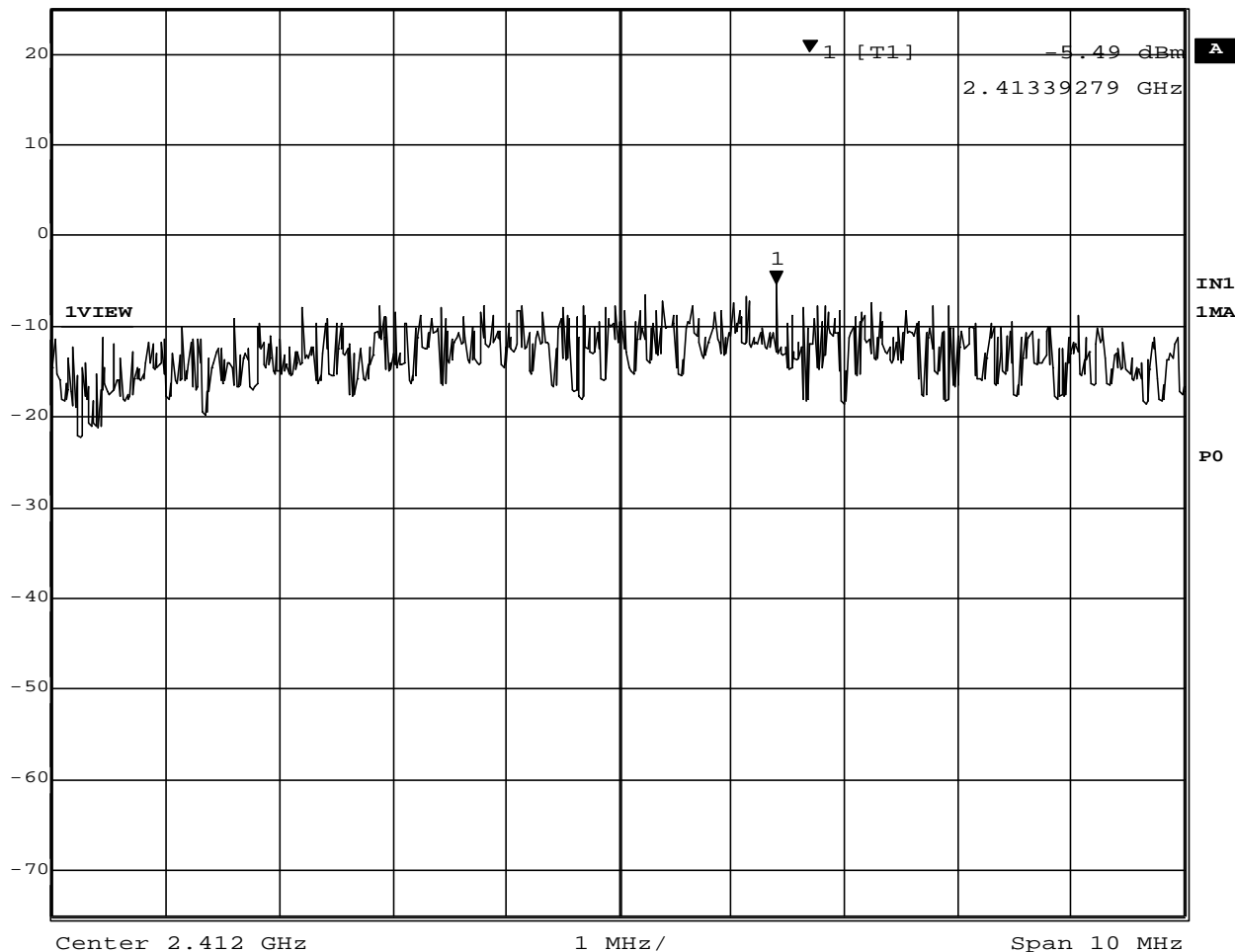

Date: 9.MAY.2002 15:10:00



Marker 1 [T1]	RBW	3 kHz	RF Att	40 dB
Ref Lvl	-6.13 dBm	VBW	100 kHz	
25 dBm	2.43839279 GHz	SWT	2.8 s	Unit dBm

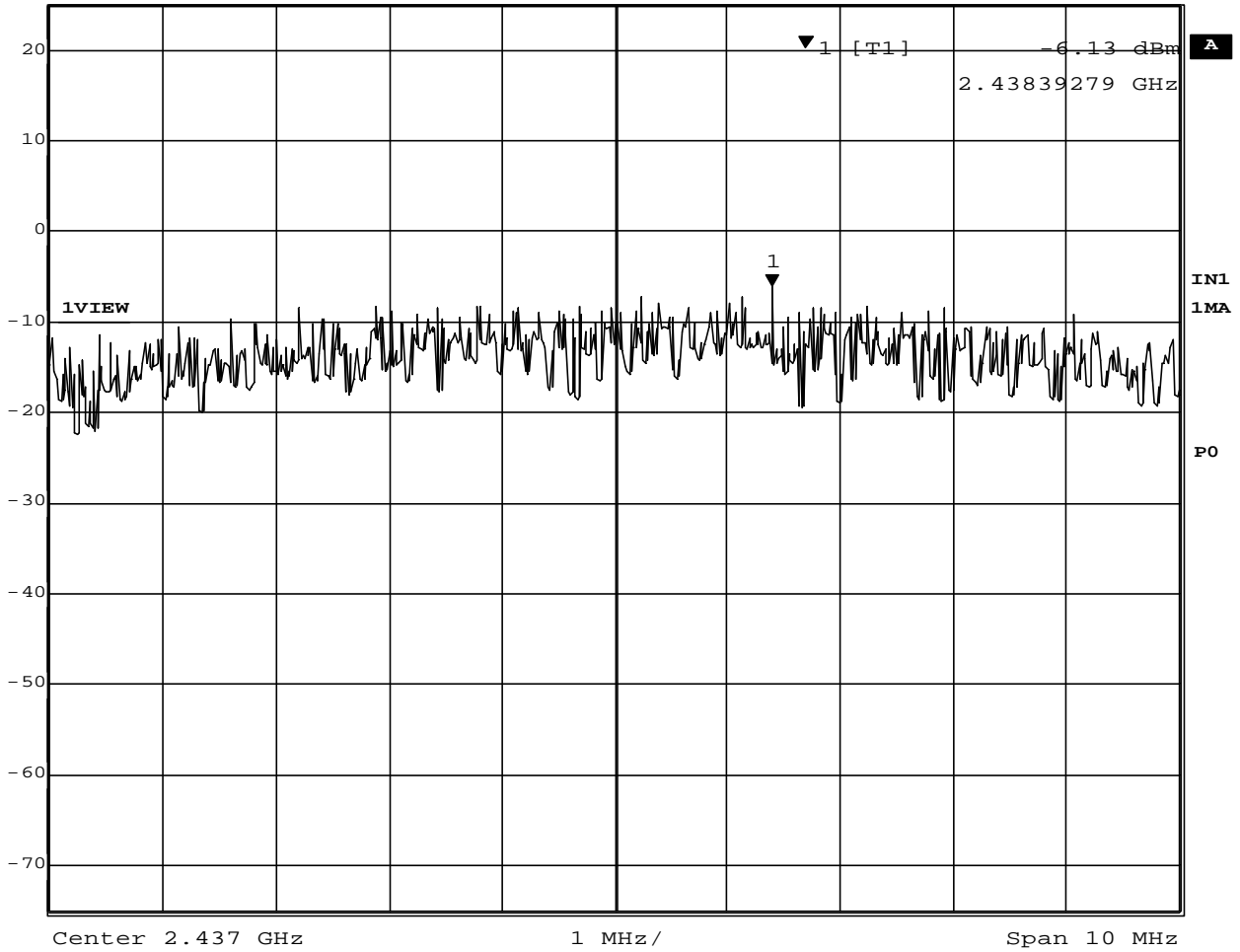

Date: 9.MAY.2002 15:07:16



Marker 1 [T1]	RBW	3 kHz	RF Att	40 dB
Ref Lvl	-6.68 dBm	VBW	100 kHz	
25 dBm	2.46339279 GHz	SWT	2.8 s	Unit dBm

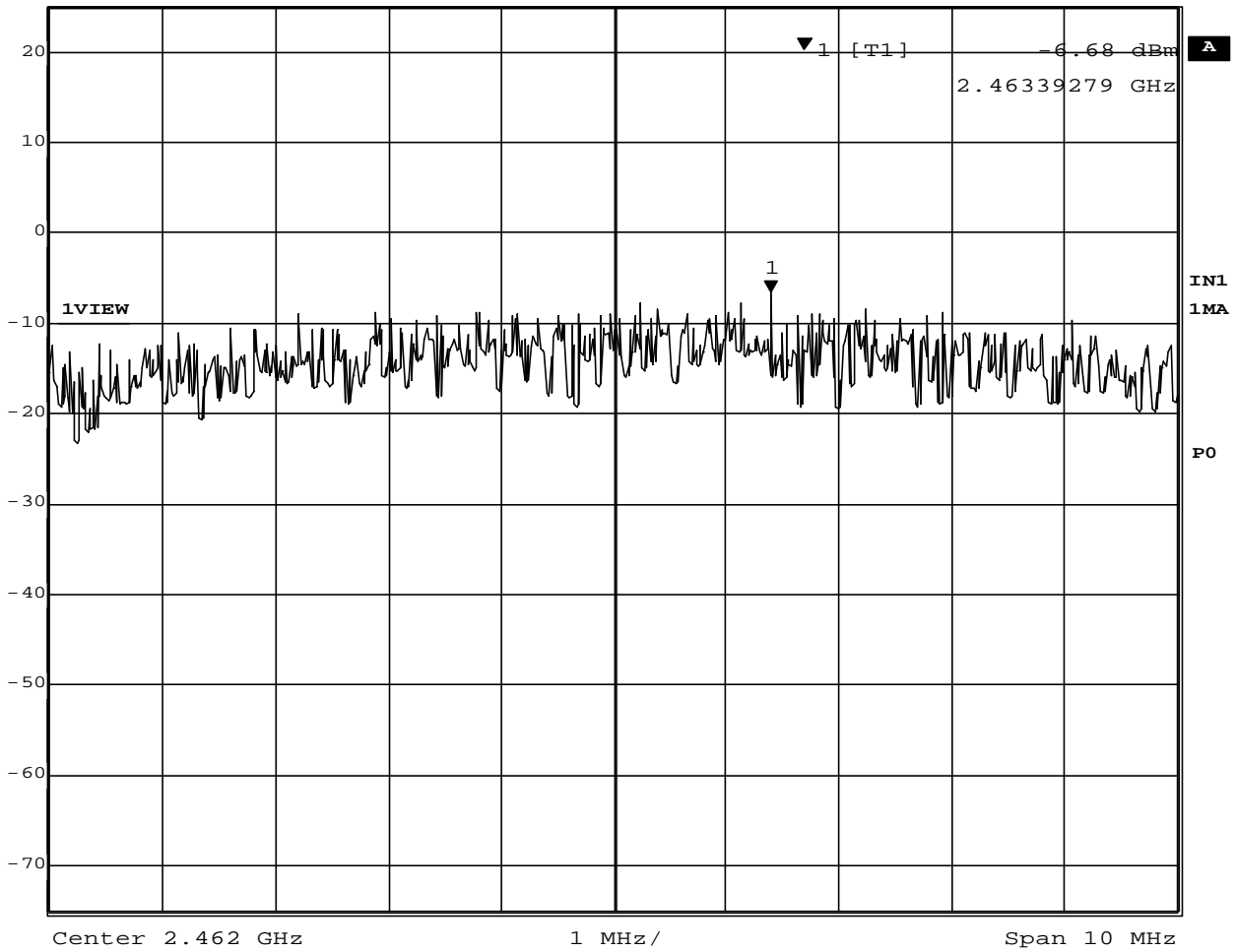

Date: 9.MAY.2002 15:08:20

5. AC WIRELINE CONDUCTED EMISSIONS (450KHz – 30MHz)

5.1 Test Procedure

The conducted emissions are measured in the IBM shielded room with a spectrum analyzer in peak hold. Emissions closest to the limit are measured in the quasi-peak mode (QP) with the tuned receiver using a bandwidth of 9KHz. The emissions are maximized further by cable manipulation. The highest emissions relative to the limit are listed.

5.2 Test Instruments and Measurement Setup

Table 5-1. Conducted Emission Test Instrumentation

Description	Model	Serial Number
Computer	IBM 6589-13J	97-15613
Spectrum Analyzer (100Hz-1.5GHz)	HP 8568B	2841A04242
Spectrum Analyzer Display	HP 8568B	2816A16827
Quasi-Peak Adapter	HP 85650A	2811A01126
Receiver (9kHz-30MHz)	R&S ESH3	891806/012
LISN	EMCO 3825/2	1426
Switch/control unit	HP 3488A	2719A17228
Plotter	HP 7550A	2631A33619
Coax cables: - Lisen-L <=> SW/Con.unit (SW100) - Lisen-N <=> SW/Con.unit (SW101) - SW/Con.unit <=> RCVR (Input) - SW/Con.unit<=> Spe Ana.(Signal In)	Length: 4 m 4 m 1 m 1 m	- EMIC-L - EMIC-N - EMIC-R - EMIC-S

Notes: - HP: Hewlett Packard, R&S: Rohde & Schwarz

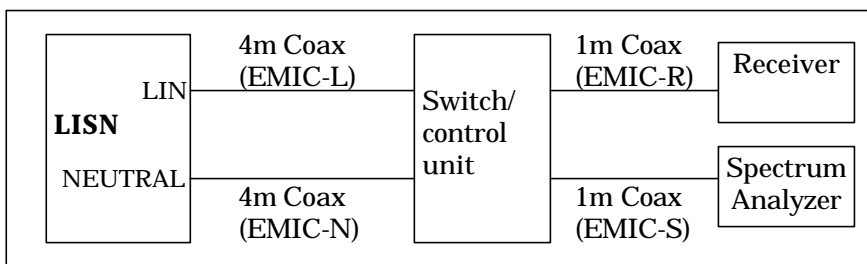

Figure 5. Cables for Conducted Emission Test

5.3 Measurement Results

The EUT was found to comply to the limits of FCC Part 15 Subpart C and RSS-210 with a margin of 3.4 dB. The 6 highest emissions relative to the limits are reported.

Test Date: May 10, 2002

1) EUT in transmission mode

Table 5-2-1. EUT: M/T 2358-CHU, s/n AA-GFWCD, Ch.1(2412MHz) TX mode 11Mbps

Frequency (MHz)	QP Voltage (dBμV)	QP Limit (dBμV)	QP Voltage (μV)	QP Limit (μV)	Phase
0.4938	31.8	48	38.9	250	LINE
0.5642	30.9	48	35.1	250	LINE
0.6309	29.6	48	30.2	251	LINE
0.7042	27.9	48	24.8	252	LINE
0.7739	28.0	48	25.1	253	LINE
0.9136	26.7	48	21.6	253	LINE

Table 5-2-2. EUT: M/T 2366-52U, s/n AA-GFWCD , Ch.6(2437MHz) TX mode 11Mbps

Frequency (MHz)	QP Voltage (dBμV)	QP Limit (dBμV)	QP Voltage (μV)	QP Limit (μV)	Phase
0.4932	32.5	48	42.2	250	LINE
0.5634	32.2	48	40.7	250	LINE
0.6306	25.8	48	19.5	251	NEUTRAL
0.7003	30.1	48	32.0	252	LINE
0.7737	27.0	48	22.4	253	LINE
0.9154	27.7	48	24.3	253	LINE

Table 5-2-3. EUT: M/T 2366-52U, s/n AA-GFWCD, Ch.11(2462MHz) TX mode 11Mbps

Frequency (MHz)	QP Voltage (dBμV)	QP Limit (dBμV)	QP Voltage (μV)	QP Limit (μV)	Phase
0.4897	34.0	48	50.1	250	LINE
0.5609	32.9	48	44.2	250	LINE
0.7048	31.0	48	35.5	251	LINE
0.9135	28.0	48	25.1	252	LINE
1.0561	24.3	48	16.4	253	LINE
1.3383	25.1	48	18.0	253	LINE

2) EUT in receiving mode

Table 5-2-4. EUT: M/T 2358-CHU, s/n AA-GFWCD, RX mode

Frequency (MHz)	QP Voltage (dB μ V)	QP Limit (dB μ V)	QP Voltage (μ V)	QP Limit (μ V)	Phase
0.4918	35.6	48	60.3	250	LINE
0.5623	31.9	48	39.4	250	LINE
0.6323	29.3	48	29.2	251	LINE
0.7010	31.0	48	35.5	252	LINE
0.9123	27.5	48	23.7	253	LINE
1.1259	26.6	48	21.4	253	LINE

6. RESTRICTED BANDS RADIATIONS (30MHz – 1GHz)

6.1 Test Procedure

Preliminary radiated emissions are measured in the semi-anechoic chamber at a 3 meter distance on every azimuth in both horizontal and vertical polarity. The antennas are also scanned in height. The emissions are recorded with a spectrum analyzer in peak hold mode. The identified emissions are further maximized by a cable manipulation. Emissions closest to the limits are measured in the quasi-peak mode with the tuned receiver using a bandwidth of 120kHz. The highest emissions relative to the limit are listed.

6.2 Test Instruments and Measurement Setup

Table 6-1 Radiated Emission Test Instrumentation

Description	Model	Serial Number
Computer	IBM 5551-L	#4
Spectrum Analyzer (100Hz-1.5GHz) for 30-200MHz	HP 85680B	3019A05155
Spectrum Analyzer Display for 30-200MHz	HP 85662A	3026A19353
Quasi-Peak Adapter for 30-200MHz	HP 85650A	3033A01449
Spectrum Analyzer (100Hz-1.5GHz) for 200-1000MHz	HP 85680B	2601A02634
Spectrum Analyzer Display for 200-1000MHz	HP 85662A	2542A12308
Quasi-Peak Adapter for 200-1000MHz	HP 85650A	2043A00062
Amplifier (100KHz-1.3GHz)		
- for 30-200MHz	HP 8447D	2805A02919
- for 200-1000MHz	HP 8447D	2944A03506
Biconical Antenna (30-200MHz)	EMCO 3108	2531
Log-Periodic Antenna (200-1000MHz)	EMCO 3146	2849
Receiver (20MHz-1.3GHz)	R&S ESVP	893202/018
Switch/control unit	HP 3488A	2719A17229
N-Coax cables:	Length:	
- Bi-coni Ant <=> 10m Cable	6 m	- EM103L01
- 10m Cable <=> Shield Panel	10 m	- EM103L02
- Shield Panel <=> RF Amp	7 m	- EM103L03
- RF Amp <=> Power Splitter	0.5m	- EM103L04
- Log-peri Ant <=> 5m Cable	9 m	- EM103H01
- 5m Cable <=> Shield Panel	5 m	- EM103H02
- Shield Panel <=> RF Amp	7 m	- EM103H03
- RF Amp <=> Power Splitter	0.5m	- EM103H04
Coax cables:		
- Power Splitter <=> SW/Con.unit (SW110)	1 m	- EM103L05
- Power Splitter <=> SW/Con.unit (SW300)	1 m	- EM103L06
- Power Splitter <=> SW/Con.unit (SW100)	1 m	- EM103H05
- Power Splitter <=> SW/Con.unit (SW301)	1 m	- EM103H06
- SW/Con.unit <=> Receiver (Input)	2 m	- EM1RCV
- SW/Con.unit <=> Spe Ana.(Signal In) for 30- 200MHz	2 m	- EM1SPL
- SW/Con.unit <=> Spe Ana.(Signal In) for 200-1000MHz	2 m	- EM1SPH

EMI SEMIANECHOIC CHAMBER

MEASUREMENT ROOM

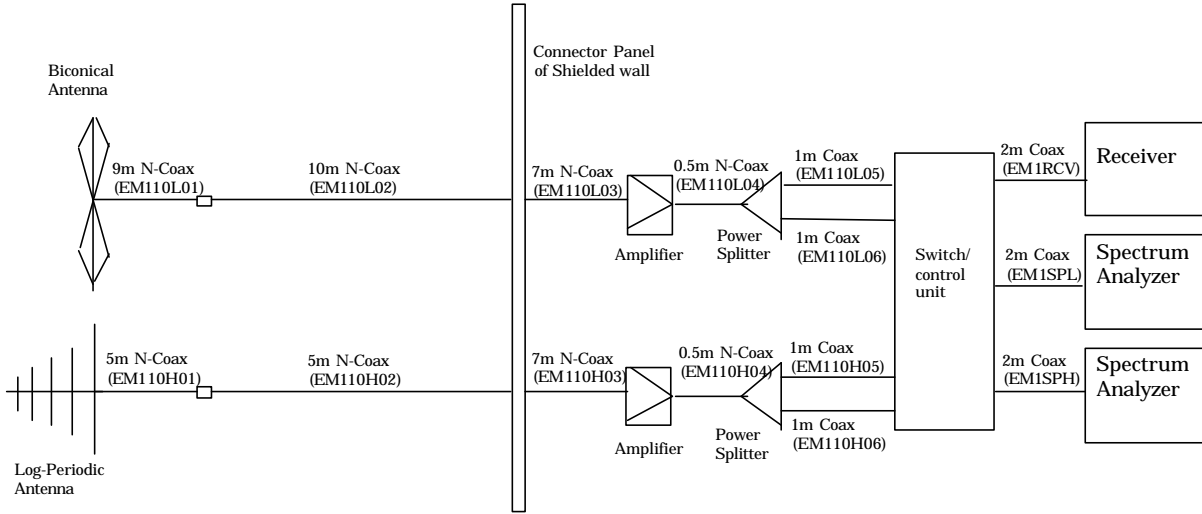

Notes:

- HP: Hewlett Packard, R&S: Rohde & Schwarz

Figure 6 Cables for Radiated Emission Test

6.3 Field Strength Calculation

The field strength is calculated by adding the Antenna Factor and Cable Loss, and subtracting Amplifier Gain from the measured reading. In this test facility, the Antenna Factor, Cable Loss, and Amplifier Gains are loaded into the Rohde & Schwarz Receiver and the corrected field strength can be read directly on the receiver. All factors are included in the reported data.

$$FS = R + AF + CORR$$

where:

- FS = Field Strength
- R = Measured Receiver Input Amplitude
- AF = Antenna Factor
- CORR = Correction Factor = CL - AG
- CL = Cable Loss
- AG = Amplifier Gain

For example:

Given a Receiver input reading of 51.5dBμV; Antenna Factor of 8.5dB/m; Cable Loss of 1.3dB; and an Amplifier Gain of 26dB. The Field Strength of the measured emission is:

$$FS = 51.5 + 8.5 + 1.3 - 26.0 = 35.3\text{dB}\mu\text{V/m}$$

Conversion between dBμV/m (or dBμV) and μV/m (or μV) are done as:

$$\text{Level}(\text{dB}\mu\text{V/m}) = 20 \times \text{Log}(\text{Level}(\mu\text{V/m}))$$

$$40\text{dB}\mu\text{V/m} = 100\mu\text{V/m}$$

$$48\text{dB}\mu\text{V/m} = 250\mu\text{V/m}$$

6.4 Measurement Results

The EUT was found to comply to the limits of FCC Part 15 Subpart C and RSS-210 with a margin of 2.4dB at 30MHz - 1000MHz band.

The 6 highest emissions relative to the limits are reported.

Test Date: May 08, 2002

1) EUT in transmission mode

Table 6-2-1. EUT: M/T 2358-CHU, s/n AA-GFWCD, Ch.1(2412MHz) TX mode 11Mbps

Frequency (MHz)	Polarity (H/V)	Measured (dB μ V)	Antenna Factor (dB/m)	Corr. Factor (dB)	Field Strength (dB μ V/m)	Limit (dB μ V/m)	Field Strength (μ V/m)	Limit (μ V/m)
159.753	H	36.9	12.8	-16.5	33.2	43.5	45.7	150
234.234	H	35.5	10.4	-14.5	31.4	46.0	37.2	200
283.495	V	44.0	13.0	-14.2	42.8	46.0	138.0	200
454.771	V	38.4	16.1	-13.8	40.7	46.0	108.4	200
902.083	V	25.6	22.7	-9.1	39.2	46.0	91.2	200
930.677	V	25.4	22.8	-9.1	39.1	46.0	90.2	200

Table 6-2-2. EUT: M/T 2358-CHU, s/n AA-GFWCD, Ch.6(2437MHz) TX mode 11Mbps

Frequency (MHz)	Polarity (H/V)	Measured (dB μ V)	Antenna Factor (dB/m)	Corr. Factor (dB)	Field Strength (dB μ V/m)	Limit (dB μ V/m)	Field Strength (μ V/m)	Limit (μ V/m)
159.753	H	37.0	12.8	-16.5	33.3	43.5	46.2	150
235.904	H	36.5	10.4	-14.4	32.5	46.0	42.2	200
283.495	V	44.4	13.0	-14.2	43.2	46.0	144.5	200
454.771	V	37.4	16.1	-13.8	39.7	46.0	96.6	200
930.784	V	18.0	22.8	-9.1	31.7	46.0	38.5	200
960.155	V	22.8	23.0	-9.1	36.7	46.0	68.4	200

Table 6-2-2. EUT: M/T 2358-CHU, s/n AA-GFWCD, Ch.11(24627MHz) TX mode 11Mbps

Frequency (MHz)	Polarity (H/V)	Measured (dB μ V)	Antenna Factor (dB/m)	Corr. Factor (dB)	Field Strength (dB μ V/m)	Limit (dB μ V/m)	Field Strength (μ V/m)	Limit (μ V/m)
159.753	H	37.0	12.8	-16.5	33.3	43.5	46.2	150
235.561	H	36.4	10.4	-14.4	32.4	46.0	41.7	200
283.495	V	44.8	13.0	-14.2	43.6	46.0	151.4	200
454.771	V	37.1	16.1	-13.8	39.4	46.0	93.3	200
902.040	V	21.9	22.7	-9.1	35.5	46.0	59.6	200
930.676	V	21.6	22.8	-9.1	35.3	46.0	58.2	200

2) EUT in receiving mode

Table 6-2-4. EUT: M/T 2358-CHU, s/n AA-GFWCD, RX mode

Frequency (MHz)	Polarity (H/V)	Measured (dBμV)	Antenna Factor (dB/m)	Corr. Factor (dB)	Field Strength (dBμV/m)	Limit (dBμV/m)	Field Strength (μV/m)	Limit (μV/m)
59.634	V	39.6	9.2	-18.1	30.7	40.0	34.3	100
159.753	H	37.0	12.8	-16.5	33.3	43.5	46.2	150
235.525	H	36.2	10.4	-14.4	32.2	46.0	40.7	200
283.495	V	44.6	13.0	-14.2	43.4	46.0	147.9	200
454.772	V	37.1	16.1	-13.8	39.4	46.0	93.3	200
842.064	V	18.1	21.9	-10.0	30.0	46.0	31.6	200

7. RESTRICTED BANDS RADIATIONS (1GHz – 25GHz)

7.1 Test Procedure

Radiated emissions were measured in the frequency range with 1 GHz to 25GHz in transmitting mode and 1 GHz to 12.5 GHz in receiving mode. All tests were performed in the semi-anechoic chamber at a 3-meter distance (except for the frequency range with 18 GHz to 25 GHz where test distance was reduced to 1 meter) on both horizontal and vertical polarities. The antenna was also scanned in height. The emissions are recorded with a spectrum analyzer in peak hold mode. The identified emissions are further maximized as a function of cable manipulation, azimuth, and antenna height. The emissions closest to the limits are measured in the peak mode with the tuned spectrum analyzer using a bandwidth of 1MHz and the average setting mode with the tuned spectrum analyzer using resolution bandwidth of 1MHz / video bandwidth of 1kHz. The highest emissions relative to the limit are listed.

7.2 Test Instruments and Measurement Setup

Table 7 Radiated Emission Test Instrumentation (1GHz – 25GHz)

Description	Model	Serial Number
Spectrum Analyzer EMI Test Receiver	R&S ESI26	836119/003
Amplifier (1-26.5GHz)	HP 8449B	3008A00582
Horn Antenna (1- 18GHz)	EMCO 3115	9903-5774
Horn Antenna (3.95 – 5.85GHz)	EMCO 3160-5	1099
Horn Antenna (5.85 – 8.20GHz)	EMCO 3160-6	9712-1044
Horn Antenna (18- 26.5GHz)	EMCO 3160-9	0004-1202
SF106 cables: - Horn Ant => RF Amp. - RF Amp.<=>Spectrum Analyzer	Length: 6 m 15 m	- EM206SCO - EM215SCO

Notes: - HP: Hewlett Packard, R&S: Rohde & Schwarz

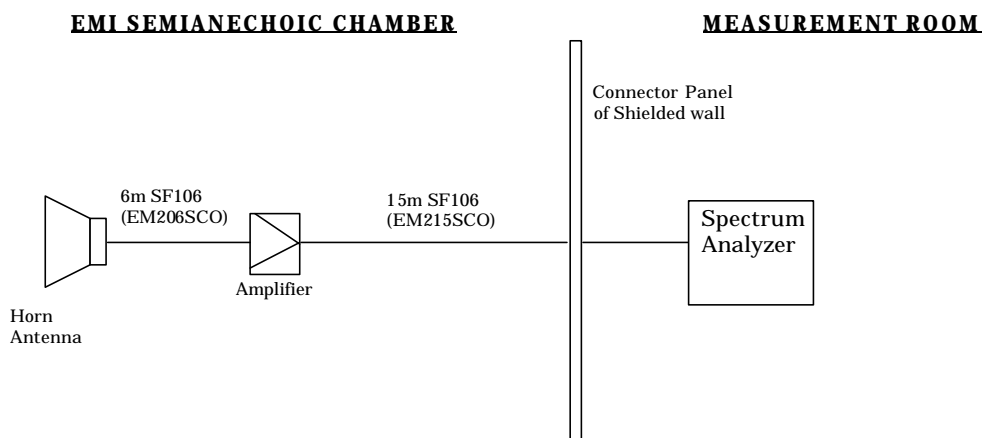

Figure 7 Cables for Radiated Emission Test

7.3 Field Strength Calculation

The field strength is calculated by adding the Antenna Factor and Cable Loss, and subtracting Amplifier Gain from the measured reading. All factors are included in the reported data.

$$FS = R + AF + CORR - FO$$

where:

FS = Field Strength

R = Measured Spectrum analyzer Input Amplitude

AF = Antenna Factor

CORR = Correction Factor = CL-AG

CL = Cable Loss

AG = Amplifier Gain

FO = Distance Falloff Factor

For example:

Given a Spectrum Analyzer input reading of 51.5 dB μ V; Antenna Factor of 8.5 dB/m; Cable Loss of 1.3 dB; Falloff Factor of 0 dB; and an Amplifier Gain of 26 dB. The Field Strength of the measured emission is:

$$FS = 51.5 + 8.5 + 1.3 - 26 - 0.0 = 35.6 \text{ dB}\mu\text{V/m}$$

Conversions between dB μ V/m (or dB μ V) and μ V/m (or μ V) are done as :

$$\begin{aligned} \text{Level(dB}\mu\text{V/m)} &= 20 \times \text{Log} (\text{Level}(\mu\text{V/m})) \\ 40 \text{ dB}\mu\text{V/m} &= 100 \mu\text{V/m} \\ 48 \text{ dB}\mu\text{V/m} &= 250 \mu\text{V/m} \end{aligned}$$

7.4 Measurement Results

The EUT was found to comply to the limits of FCC Part 15 Subpart C and RSS-210 with a margin of 3.1 dB. The measurement was done for the frequency range of 1 GHz to 25 GHz in TX mode and 1 GHz to 12.5GHz in RX mode.

Test Date: May 08, 2002

1) EUT in transmission mode

Table 7-2-1. EUT: M/T 2358-CHU, s/n AA-GFWCD, Ch.1(2412MHz) TX mode 11Mbps

Frequency (GHz)	Polarity (H/V)	Measured (dBμV/m) (<i>peak</i>)	Measured (dBμV/m) (<i>average</i>)	Antenna Factor (dB/m)	Corr Factor (dB)	Falloff Factor (dB)	Field Strength (dBμV/m) (<i>peak</i>)	FCC Limit (dBμV/m) (<i>peak</i>)	Field Strength (dBμV/m) (<i>average</i>)	FCC Limit (dBμV/m) (<i>average</i>)
1.773	H	58.1	46.4	26.5	-29.9	0.0	54.7	74.0	43.0	54.0
2.039	V	58.4	47.8	27.5	-29.5	0.0	56.4	74.0	45.8	54.0
2.398	V	76.4	70.3	28.2	-28.4	0.0	76.2	NRB*	70.1	NRB*
2.413	V	112.1	104.2	28.2	-28.4	0.0	111.9	OB*	104.0	OB*
4.828	V	49.8	38.1	33.0	-23.7	0.0	59.1	74.0	47.4	54.0
7.238	H	44.2	34.4	35.8	-24.6	0.0	55.4	NRB*	45.6	NRB*

*Note: OB means “operation band” (2400-2483.5MHz); in this case limit is 1W (measured conducted with power meter).
NRB means “non restricted band”.

Table 7-2-2. EUT: M/T 2358-CHU, s/n AA-GFWCD, Ch.6(2437MHz) TX mode 11Mbps

Frequency (GHz)	Polarity (H/V)	Measured (dBµV/m) <i>(peak)</i>	Measured (dBµV/m) <i>(average)</i>	Antenna Factor (dB/m)	Corr Factor (dB)	Falloff Factor (dB)	Field Strength (dBµV/m) <i>(peak)</i>	FCC Limit (dBµV/m) <i>(peak)</i>	Field Strength (dBµV/m) <i>(average)</i>	FCC Limit (dBµV/m) <i>(average)</i>
1.063	V	57.4	44.7	24.2	-31.5	0.0	50.1	74.0	37.4	54.0
2.064	V	57.2	48.0	27.5	-29.4	0.0	55.3	NRB*	46.1	NRB*
2.438	V	111.9	111.8	28.3	-28.4	0.0	111.8	OB*	111.7	OB*
4.876	V	51.5	41.1	33.1	-23.7	0.0	60.9	74.0	50.5	54.0
6.477	H	39.7	28.4	34.4	-23.6	0.0	50.5	74.0	39.2	54.0
7.313	H	41.5	31.8	36.0	-24.8	0.0	52.7	74.0	43.0	54.0

*Note: OB means “operation band” (2400-2483.5MHz); in this case limit is 1W (measured conducted with power meter).
NRB means “non restricted band”.

Table 7-2-3. EUT: M/T 2358-CHU, s/n AA-GFWCD, Ch.11(2462MHz) TX mode 11Mbps

Frequency (GHz)	Polarity (H/V)	Measured (dBµV/m) <i>(peak)</i>	Measured (dBµV/m) <i>(average)</i>	Antenna Factor (dB/m)	Corr Factor (dB)	Falloff Factor (dB)	Field Strength (dBµV/m) <i>(peak)</i>	FCC Limit (dBµV/m) <i>(peak)</i>	Field Strength (dBµV/m) <i>(average)</i>	FCC Limit (dBµV/m) <i>(average)</i>
1.063	V	57.7	44.4	24.2	-31.5	0.0	50.4	74.0	37.1	54.0
2.463	V	111.9	104.1	28.3	-28.3	0.0	111.9	OB*	104.1	OB*
2.484	V	59.2	48.5	28.4	-28.2	0.0	59.4	74.0	48.7	54.0
4.928	V	49.4	39.9	33.2	-23.6	0.0	59.0	74.0	49.5	54.0
6.477	V	40.6	28.4	34.4	-23.6	0.0	51.4	74.0	39.2	54.0
7.390	H	40.4	31.2	36.2	-25.0	0.0	51.6	74.0	42.4	54.0

*Note: OB means “operation band” (2400-2483.5MHz); in this case limit is 1W (measured conducted with power meter).
NRB means “non restricted band”.

2) EUT in receiving mode

Table 7-2-4. EUT: M/T 2358-CHU, s/n AA-GFWCD, RX mode

Frequency (GHz)	Polarity (H/V)	Measured (dBµV/m) <i>(peak)</i>	Measured (dBµV/m) <i>(average)</i>	Antenna Factor (dB/m)	Corr Factor (dB)	Falloff Factor (dB)	Field Strength (dBµV/m) <i>(peak)</i>	FCC Limit (dBµV/m) <i>(peak)</i>	Field Strength (dBµV/m) <i>(average)</i>	FCC Limit (dBµV/m) <i>(average)</i>
1.345	V	55.8	44.0	24.9	-30.8	0.0	49.9	74.0	38.1	54.0
1.275	V	54.8	43.8	24.8	-30.9	0.0	48.7	74.0	37.7	54.0
1.773	V	57.9	46.2	26.5	-29.9	0.0	54.5	74.0	42.8	54.0
3.731	V	58.1	46.3	31.8	-25.1	0.0	64.8	74.0	53.0	54.0
4.876	H	38.3	26.3	33.1	-23.7	0.0	47.7	74.0	35.7	54.0
7.390	H	37.0	25.6	36.2	-25.0	0.0	48.2	74.0	36.8	54.0