

Emission Test Report

Standard: FCC Part 15 Subpart C / IC RSS-210

Document Number : FCC 19-0182-0

Product: IBM ThinkPad T30 Series
Included IBM High Rate Wireless LAN Mini-PCI Adapter with Modem II

FCC ID: ANOCORN1TASUHOP
IC: xxxxxx-CORN1HOP

February 4, 2002

Prepared :
EMC Engineer

Takeshi Asano

Signature: 

IBM Japan, Ltd.
EMC Engineering
LAB-S59

1623-14, Shimotsuruma,
Yamato-shi Kanagawa-ken 242, Japan
Phone: +81-46-215-4779
Fax: +81-46-273-7420
E-Mail: asano@jp.ibm.com

Reviewed and Checked :
EMC Staff Engineer

Toshiya Murota

Signature: 

IBM Japan, Ltd.
EMC Engineering
LAB-S59

1623-14, Shimotsuruma,
Yamato-shi Kanagawa-ken 242, Japan
Phone: +81-46-215-6574
Fax: +81-46-273-7420
E-Mail: murota@jp.ibm.com

Approved :
Manager, EMC Engineering

Akihisa Sakurai

Signature: 

IBM Japan, Ltd.
EMC Engineering
LAB-S59

1623-14, Shimotsuruma,
Yamato-shi Kanagawa-ken 242, Japan
Phone: +81-46-215-2613
Fax: +81-46-273-7420
E-Mail: akihisa@jp.ibm.com

Annex A Summary of test results

Equipment model : ThinkPad T30 Series

Test report page
or reference

Transmitter tested to RSS-210 section <u>6.2.2(o)</u>	
Field strength _____ $\mu\text{V/m}$ at a distance of _____ metres	_____
or	
RF power <u>0.0501</u> watts	<u>19</u>
Peak – to – average ratio _____ dB or G CISPR	_____
Test conditions : G Radiated (sections 11 & 13)	_____
G At antenna (section 10)	_____
G DC input power (section 12)	_____
<hr/>	
Transmitter frequency <u>center freq. 2412MHz + 5MHz \times N (N=0 to 10ch)</u>	<u>5</u>
Designation of Emission (see section 5.9.2) <u>17M1G1D</u>	_____
Occupied Bandwidth (measured) <u>67.08MHz (17.08MHz/ch)</u>	<u>12</u>
Frequency tuning range : Min. _____ Max. _____	_____
Frequency stability _____	_____
<hr/>	
Transmitter spurious (worst case)	
Field strength <u>138</u> $\mu\text{V/m}$ (QP 42.8 dB $\mu\text{V/m}$) at a distance of <u>3</u> metres	<u>30</u>
Frequency <u>729 MHz (Horizontal)</u> Non restricted band is excluded.	_____
<hr/>	
Momentary operation? G Yes G <u>No</u>	_____
Holdover time after manual release : _____ seconds	_____
or	
Duration of transmission after automatic activation : _____ seconds	_____
<hr/>	
Transmitter/receiver AC wireline conducted emissions (worst case)	
Transmitter : RF level <u>39.8</u> microvolts, frequency <u>514.4kHz</u>	<u>25</u>
Receiver : RF level <u>26.6</u> microvolts, frequency <u>24.11MHz</u>	<u>26</u>
<hr/>	
Receiver spurious (worst case)	
Field strength <u>124.5</u> $\mu\text{V/m}$ (QP 41.9 dB $\mu\text{V/m}$) at a distance of <u>3</u> metres	<u>31</u>
RF power _____ nanowatts	_____
Frequency <u>729 MHz (Horizontal)</u>	_____

Attestation :

The radio device identified in this application has been subject to all the applicable test conditions specified in RSS-210 and all of the requirements of the Standard have been met.

except as noted, _____ pages attached.

EMC Engineer
Title

Takeshi Asano
Name (print)



Signature

February/ 4/ 2002
Date

- Index -

A. GENERAL INFORMATION.....3

A.1 TEST METHODOLOGY.....3

A.2 TEST FACILITY / NVLAP ACCREDITATION3

A.3 EUT DETAILS.....3

B. SUMMARY OF TEST RESULTS.....4

C. OPERATION MODE OF EUT.....5

D. TEST INSTRUMENTS.....6

E. MEASUREMENT UNCERTAINTY.....7

1. BANDWIDTH AT 6 DB BELOW.....8

1.1 TEST PROCEDURE.....8

1.2 TEST INSTRUMENTS AND MEASUREMENT SETUP.....8

1.3 MEASUREMENT RESULTS.....8

1.4 TRACE DATA.....9

2. OCCUPIED BANDWIDTH / BAND-EDGE (AT 20 DB BELOW), AND OUT OF BAND EMISSIONS.....12

2.1 TEST PROCEDURE.....12

2.2 TEST INSTRUMENTS AND MEASUREMENT SETUP.....12

2.3 MEASUREMENT RESULTS OF OCCUPIED BANDWIDTH / BAND-EDGE.....12

2.4 MEASUREMENT RESULTS OF OUT OF BAND EMISSIONS.....12

2.5 TRACE DATA OF BAND-EDGE.....13

2.6 TRACE DATA OF OUT OF BAND EMISSIONS.....16

3. TRANSMITTER OUTPUT POWER.....19

3.1 TEST PROCEDURE.....19

3.2 MEASUREMENT RESULTS.....19

4. TRANSMITTER POWER SPECTRAL DENSITY.....20

4.1 TEST PROCEDURE.....20

4.2 TEST INSTRUMENTS AND MEASUREMENT SETUP.....20

- 4.3 MEASUREMENT RESULTS.....20**
- 4.4 TRACE DATA.....21**
- 5. AC WIRELINE CONDUCTED EMISSIONS (450KHZ – 30MHZ).....24**

- 5.1 TEST PROCEDURE.....24**
- 5.2 TEST INSTRUMENTS AND MEASUREMENT SETUP.....24**
- 5.3 MEASUREMENT RESULTS.....25**
- 6. RESTRICTED BANDS RADIATIONS (30MHZ – 1GHZ).....27**
- 6.1 TEST PROCEDURE.....27**
- 6.2 TEST INSTRUMENTS AND MEASUREMENT SETUP.....27**
- 6.3 FIELD STRENGTH CALCULATION.....29**
- 6.4 MEASUREMENT RESULTS.....30**
- 7. RESTRICTED BANDS RADIATIONS (1GHZ – 25GHZ).....32**
- 7.1 TEST PROCEDURE.....32**
- 7.2 TEST INSTRUMENTS AND MEASUREMENT SETUP.....32**
- 7.3 FIELD STRENGTH CALCULATION.....33**
- 7.4 MEASUREMENT RESULTS.....34**

A. GENERAL INFORMATION

APPLICANT : IBM Japan Ltd.
 ADDRESS : 1623 – 14 Shimotsuruma, Yamato-shi, Kanagawa 242-8502 Japan
 Tel: +81-46-215-4779, Fax: +81-46-273-7420
 REGULATION : FCC Part 15 Subpart C
 Industry Canada RSS-210 (Issue No.4)
 MODEL NUMBER : 2366-52U (ThinkPad T30)
 FCC ID : ANOCORN1TASUHOP
 SERIAL NUMBER : ZZ-00163
 PHYSICAL CONDITION : Preproduction
 KIND OF EQUIPMENT : Personal computer with a built-in Wireless LAN card
 TESTED DATE : January 10, 11, 17 and February 1, 2002
 TEST SITE : IBM Yamato semi-anechoic chamber #2

A.1 Test Methodology

Both conducted and radiated testing were performed according to the procedures in ANSI C63.4-1992. Radiated testing was performed at an antenna to EUT distance of 3 meters.

A.2 Test Facility / NVLAP Accreditation

The semi-anechoic chamber #2 used to correct the data are located in Yamato Laboratory, IBM Japan.

- This facility has been fully described in a report dated September 1998, submitted to the FCC office, and accepted in a letter, dated Nov. 2,1998(31040/SIT).
- This facility is accepted by **Industry Canada** in a letter dated March 19, 2001 as number **IC 349E**.
- IBM Yamato EMC Engineering is recognized under the National Voluntary Laboratory Accreditation Program for satisfactory compliance with Criteria established in Title 15, Part 285 Code of Federal Regulations.(NVLAP Lab code: 200198-0)

A.3 EUT details

Table A EUT details

Model and S/N	FCC ID	Description	Cable Description
ThinkPad T30 M/T 2366-52U (s/n ZZ-00163)	ANOCORN1TASUHOP	IBM Notebook PC CPU: Intel® Mobile Pentium® 4 1.7GHz	
P/N 02K6665	N/A	Universal AC adapter 72W	Unshielded power cord

B. SUMMARY OF TEST RESULTS

Table-B presents the list of the measurement items for Spread Spectrum, Direct Sequence devices under FCC Part 15 Subpart C and Industry Canada RSS-210.

The section numbers of upper portion are showing FCC number, and the other (lower) ones are for IC.

Table-B List of the measurements

Section(s)	Test Items		Condition	Result
	Transmit mode (TX):			
15.247(a)(2) 5.9.1	Bandwidth at 6 dB below		Conducted	Pass
15.247(c) 5.9.1 6.2.2 (o) (e1)	Occupied BW (or Band-edge) Out of Band Emissions (Bandwidth at 20 dB below)	The radiated emission in any 100kHz of outband shall be at least 20dB below the highest inband spectral density.	Conducted	Pass
15.247(b) 6.2.2 (o) (b)	Transmitter output power	Shall not exceed 1.0 W.	Conducted	Pass
15.247(d) 6.2.2 (o) (b)	Transmitter power spectral Density	Shall not be greater than 8 dBm in any 3kHz band.	Conducted	Pass
15.247(e) 6.2.2 (o) (b)	Processing gain	10 dB	Conducted	Pass*
15.207 6.6	AC Wireline Conducted Emissions 450kHz – 30MHz	Class B: 250µV	Conducted	Pass
15.205 / 209 6.2.1 / 6.3	General Field Strength Limits (Restricted Bands and Radiated Emission Limits)	Shall not exceed the limits specified in FCC 15.209 or RSS-210 Table3.	Radiated (30MHz -1GHz)	Pass
			Radiated (1– 25GHz)	Pass
Receive mode (RX):				
15.207 7.4	AC Wireline Conducted Emissions 450kHz – 30MHz	Class B: 250µV	Conducted	Pass
15.209 7.3	General Field Strength Limits (Radiated Emission Limits)	Shall not exceed the limits specified in RSS-210.	Radiated (30MHz -1GHz)	Pass
			Radiated (1– 25GHz)	Pass

* See “Processing Gain Report” by Intel Corp.

C. OPERATION MODE OF EUT

All tests were performed using the “PRISM Test Utility Program”, Version 3.0.24. Three kinds of modulation are used for transmission with appropriate bit rates:

Table C-1 Transmit mode (TX)

Operation Frequency [GHz]	Rated output power (conducted) [dBm]			Test performed*
	Bit rate 2Mbps	Bit rate 5.5Mbps	Bit rate 11Mbps	
2.412 (Ch. 1)	+15	+15	+15	X
2.417 (Ch. 2)	+15	+15	+15	
2.422 (Ch. 3)	+15	+15	+15	
2.427 (Ch. 4)	+15	+15	+15	
2.432 (Ch. 5)	+15	+15	+15	
2.437 (Ch. 6)	+15	+15	+15	X
2.442 (Ch. 7)	+15	+15	+15	
2.447 (Ch. 8)	+15	+15	+15	
2.452 (Ch. 9)	+15	+15	+15	
2.457 (Ch. 10)	+15	+15	+15	
2.462 (Ch. 11)	+15	+15	+15	X

* Full testing with bit rate 11Mbps only

Table C-2 Receive mode (RX)

Operation Frequency [GHz]	Test performed
2.412 (Ch. 1)	
2.417 (Ch. 2)	
2.422 (Ch. 3)	
2.427 (Ch. 4)	
2.432 (Ch. 5)	
2.437 (Ch. 6)	X
2.442 (Ch. 7)	
2.447 (Ch. 8)	
2.452 (Ch. 9)	
2.457 (Ch. 10)	
2.462 (Ch. 11)	

D. TEST INSTRUMENTS

Table-D List of Measuring Instruments

Description	Model	Serial Number	Calibration Date	Calibration Interval
Computer	IBM 5551-L	#4	N/A	N/A
Computer	IBM 6589-13J	97-15613	N/A	N/A
Spectrum Analyzer (100Hz-1.5GHz)	HP 85680B	2732A03651	01/16/01	1 year
Spectrum Analyzer (100Hz-1.5GHz)	HP 85680B	3019A05155	02/07/01	1 year
Spectrum Analyzer (100Hz-1.5GHz)	HP 85680B	3019A05156	04/02/01	1 year
Spectrum Analyzer Display	HP 85662A	2648A15255	01/16/01	1 year
Spectrum Analyzer Display	HP 85662A	3026A19353	02/07/01	1 year
Spectrum Analyzer Display	HP 85662A	3026A19366	04/02/01	1 year
Quasi-Peak Adapter	HP 85650A	2521A00968	01/16/01	1 year
Quasi-Peak Adapter	HP 85650A	3033A01449	02/07/01	1 year
Quasi-Peak Adapter	HP 85650A	2811A01433	04/02/01	1 year
Amplifier (100KHz - 1.3GHz) - for 30-200MHz - for 200-1000MHz	HP 8447D HP 8447D	2805A02919 2944A03506	04/16/01 04/16/01	1 year 1 year
Amplifier (1GHz - 26.5GHz)	HP 8449B	3008A00582	05/23/01	1 year
Spectrum Analyzer EMI Test Receiver	R&S ESI26	836119/003	07/04/01	1 year
Receiver (9kHz-30MHz)	R&S ESH3	891806/012	09/01/01	1 year
Receiver (20MHz-1.3GHz)	R&S ESVP	893202/018	01/29/01	1 year
Biconical Antenna (30-200MHz)	EMCO 3108	2241	05/11/01	1 year
Log-Periodic Antenna (200-1000MHz)	EMCO 3146	1584	05/10/01	1 year
Horn Antenna (1- 18GHz)	EMCO 3115	9903-5774	04/23/01	1 year
Horn Antenna (3.95- 5.85GHz)	EMCO 3160-5	1099	04/26/01	1 year
Horn Antenna (5.85- 8.20GHz)	EMCO 3160-6	9712-1044	04/26/01	1 year
Horn Antenna (18- 26.5GHz)	EMCO 3160-9	0004-1202	05/01/01	1 year
LISN	EMCO 3825/2	1426	09/01/01	1 year
Power Meter	HP 436A	2604A24192	09/06/01	1 year
Power Sensor	HP 8482A	2607A10987	09/07/01	1 year
Switch/control unit	HP 3488A	2719A17226 2719A17228	N/A N/A	N/A N/A
Plotter	HP 7550A	2631A33619	N/A	N/A
SF106 cables: - Horn Ant <=> RF Amp. - RF Amp.<=>Spectrum Analyzer	Length: 6 m 15m	- EM206SCO - EM215SCO	08/07/01 08/07/01	1 year 1 year
N-Coax cables: - Bi-coni Ant <=> 10m Cable - 10m Cable <=> Shield Panel - Shield Panel <=> RF Amp - RF Amp <=> Power Splitter - Log-peri Ant <=> 10m Cable	9 m 10 m 7 m 0.5m 9 m	- EM203L01 - EM203L02 - EM203L03 - EM203L04 - EM203H01	04/16/01 04/16/01 04/16/01 04/16/01 04/16/01	1 year 1 year 1 year 1 year 1 year

- 10m Cable <=> Shield Panel	10 m	- EM203H02	04/16/01	1 year
- Shield Panel <=> RF Amp	7 m	- EM203H03	04/16/01	1 year
- RF Amp <=> Power Splitter	0.5m	- EM203H04	04/16/01	1 year
Coax cables:				
- Lisn-L <=> SW/Con.unit (SW100)	4 m	- EMIC-L	04/16/01	1 year
- Lisn-N <=> SW/Con.unit (SW101)	4 m	- EMIC-N	04/16/01	1 year
- SW/Con.unit <=> RCVR (Input)	1 m	- EMIC-R	04/16/01	1 year
- SW/Con.unit<=> Spe Ana.(Signal In)	1 m	- EMIC-S	04/16/01	1 year
- Power Splitter <=> SW/Con.unit (SW110)	1 m	- EM203L05	04/16/01	1 year
- Power Splitter <=> SW/Con.unit (SW300)	1 m	- EM203L06	04/16/01	1 year
- Power Splitter <=> SW/Con.unit (SW100)	1 m	- EM203H05	04/16/01	1 year
- Power Splitter <=> SW/Con.unit (SW301)	1 m	- EM203H06	04/16/01	1 year
- SW/Con.unit <=> Receiver (Input)	2 m	- EM2RCV	04/16/01	1 year
- SW/Con.unit <=> Spe Ana.(Signal In) for 30- 200MHz	2 m	- EM2SPL	04/16/01	1 year
- SW/Con.unit <=> Spe Ana.(Signal In) for 200-1000MHz	2 m	- EM2SPH	04/16/01	1 year

Notes.

- The above equipment calibration is traceable to National standards.
- HP: Hewlett Packard, R&S: Rohde & Schwarz

E. MEASUREMENT UNCERTAINTY

Uncertainties of the both, the Yamato EMI radiated test facilities (EMI chambers, #1 and #2) and the Yamato EMI conducted test facility are derived with the NIS 81 " Treatment of uncertainty in EMC measurements" 1994.

Estimated site uncertainty values are as follows.

- EMI chamber #1 : 4.17dB
- EMI chamber #2 : 4.18dB
- EMI conducted measurement system : 2.4dB

Detail should be referred to "Treatment of Uncertainty, Calculations and Policy" report, document number TCR 10-0015.

1. Bandwidth at 6 dB below

1.1 Test Procedure

The bandwidth at 6 dB down from the highest inband spectral density is measured with a spectrum analyzer connected to the antenna terminal, while EUT is operating in transmission mode at the appropriate center frequency.

The spectrum analyzer is set to :

RBW=100kHz, VBW=100kHz*1, Span=30MHz, Sweep=suitable duration based on the EUT specification

*1: To be adjusted accordingly based on the spectrum stability

1.2 Test Instruments and Measurement Setup

Table 1-1 : 6 dB Bandwidth Test Instruments

Description	Model	Serial Number
Spectrum Analyzer EMI Test Receiver	R&S ESI26	836119/003
Coax cables: - Spectrum Analyzer <=> EUT	Length: 120 cm Loss: 1.7 dB	

Notes: - R&S: Rohde & Schwarz

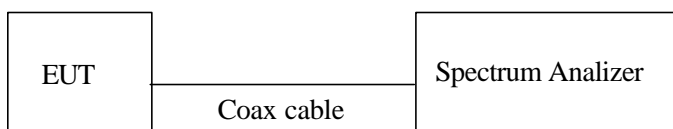

Figure 1: Measurement setup for 6dB bandwidth test

1.3 Measurement Results

Test Date: January 10, 2002

Table 1-2. EUT: M/T 2366-52U, s/n ZZ-00163 , TX mode 11Mbps

Center Frequency (MHz)	Lower frequency (MHz)	Upper frequency (MHz)	Bandwidth at 6 dB below (MHz)
2412 (ch. 1)	2406.26	2417.50	11.24
2437 (ch. 6)	2431.26	2442.50	11.24
2462 (ch. 11)	2456.26	2467.50	11.24

1.4 Trace Data



Ref Lvl	Marker 1 [T1]	RBW	100 kHz	RF Att	40 dB
25 dBm	4.53 dBm	VBW	100 kHz		
	2.41311222 GHz	SWT	7.5 ms	Unit	dBm

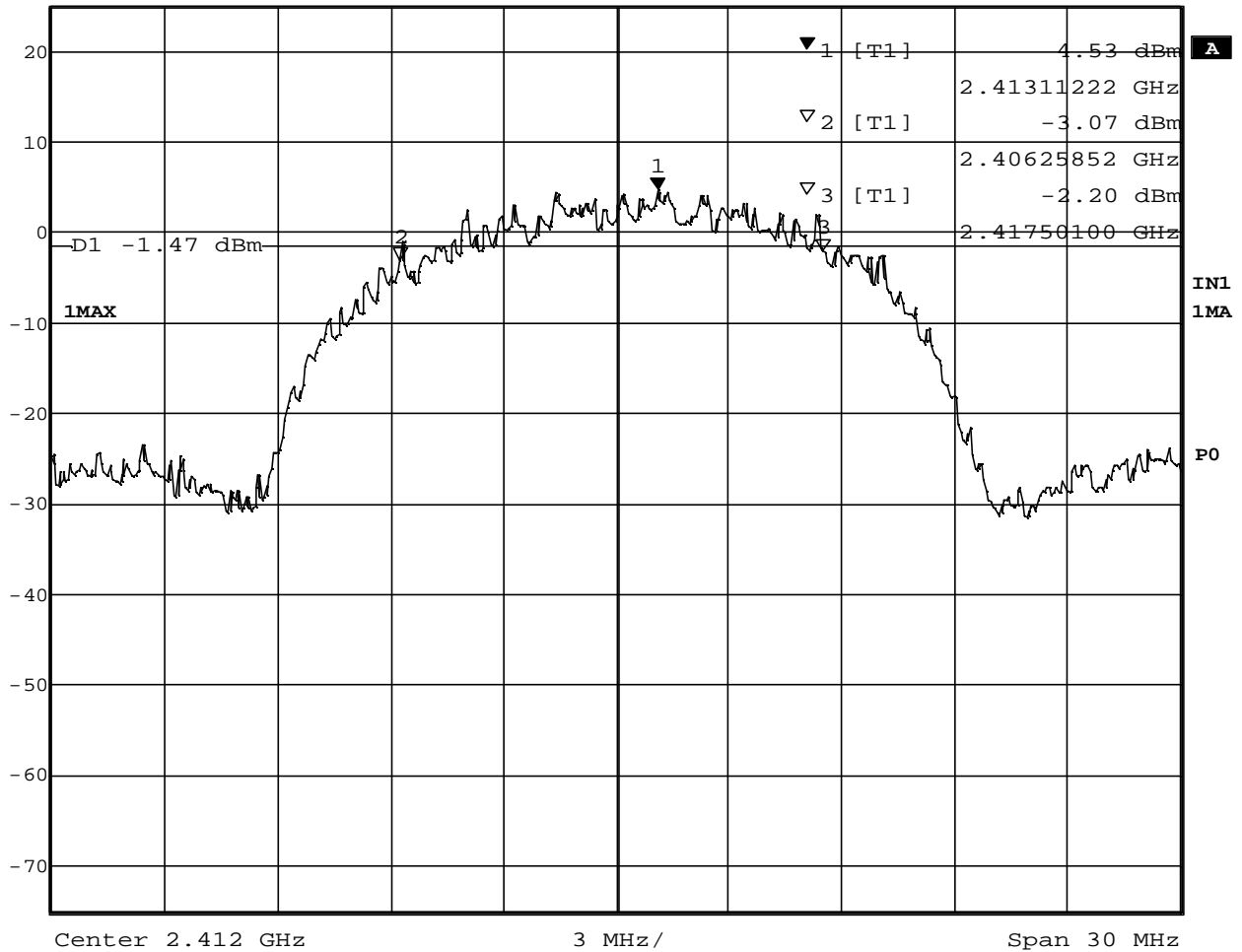

Date: 10.JAN.2002 13:04:53



Ref Lvl	25 dBm	Marker 1 [T1]	2.43811222 GHz	RBW	100 kHz	RF Att	40 dB
				VBW	100 kHz		
				SWT	7.5 ms	Unit	dBm

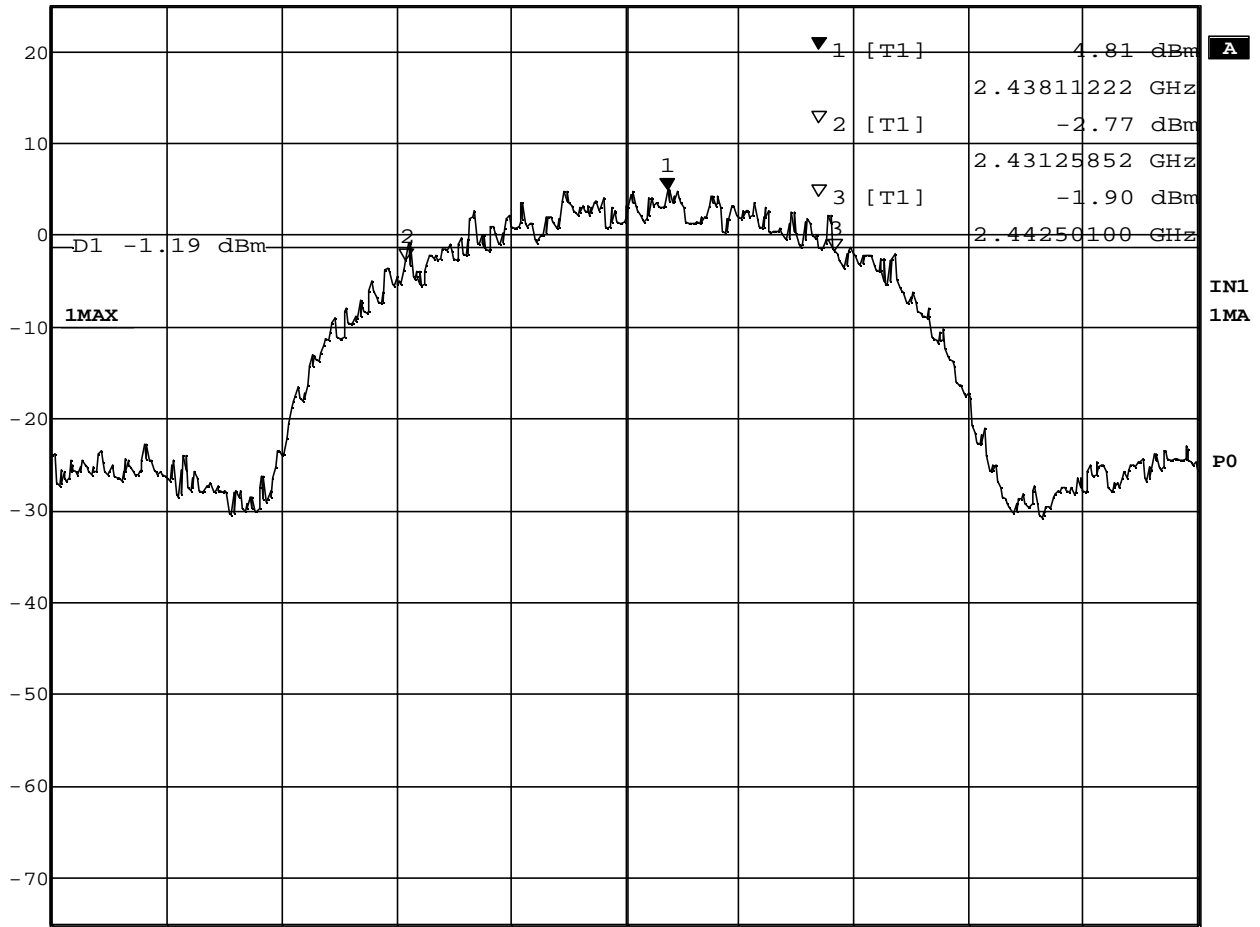

Center 2.437 GHz 3 MHz/ Span 30 MHz

Date: 10.JAN.2002 13:07:43



Marker 1 [T1] RBW 100 kHz RF Att 40 dB
 Ref Lvl 4.66 dBm VBW 100 kHz
 25 dBm 2.46311222 GHz SWT 7.5 ms Unit dBm

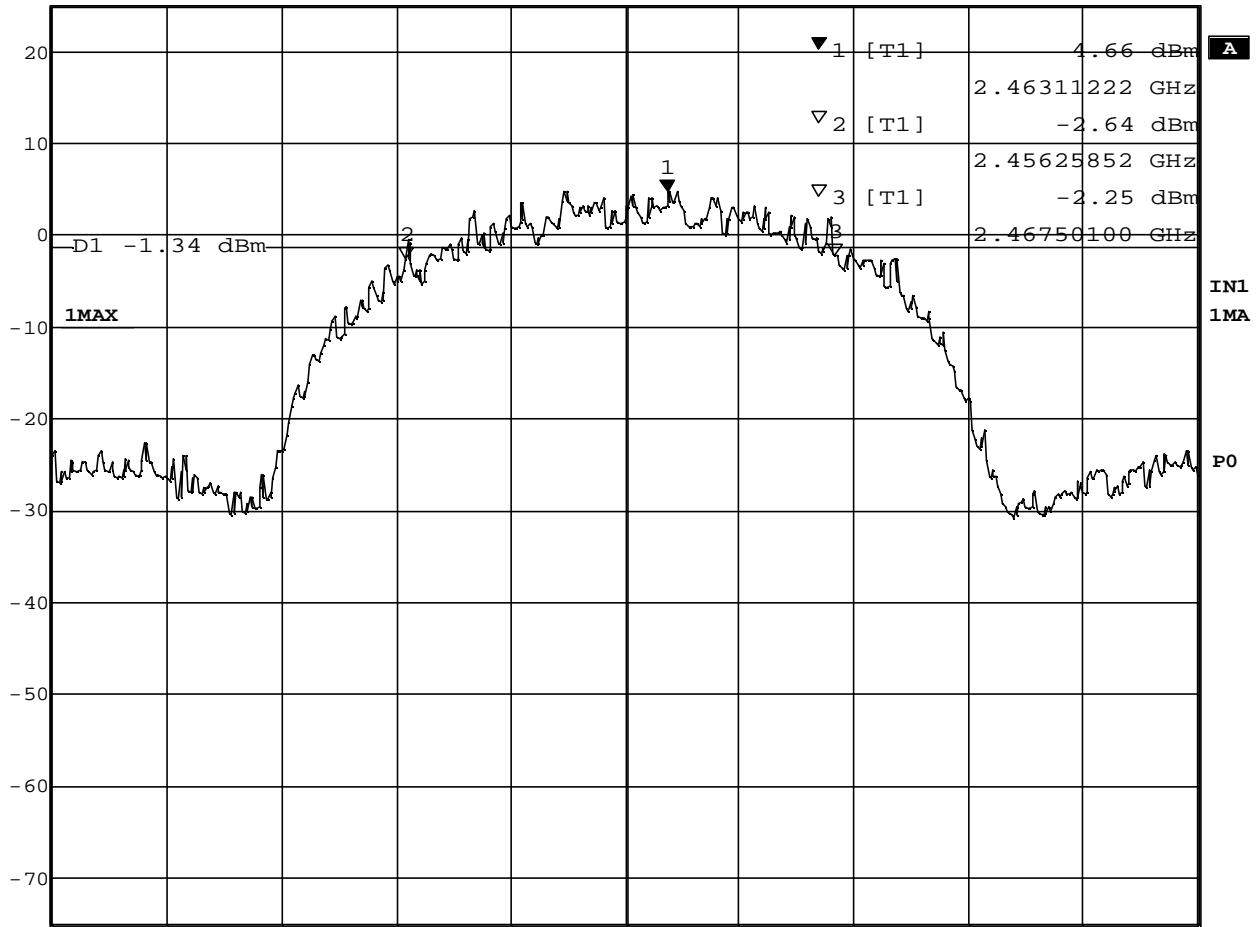

Center 2.462 GHz 3 MHz/ Span 30 MHz

Date: 10.JAN.2002 13:10:06

2. Occupied Bandwidth / Band-edge (at 20 dB below), and Out of Band Emissions

2.1 Test Procedure

The bandwidth at 20 dB down from the highest inband spectral density is measured with a spectrum analyzer connected to the antenna terminal, while EUT is operating in transmission mode at the appropriate center frequency.

The spectrum analyzer is set to:

RBW=100kHz, VBW=100kHz*1, Span=30MHz, Sweep=suitable duration based on the EUT specification

*1: To be adjusted accordingly based on the spectrum stability

2.2 Test Instruments and Measurement Setup

Same as the Chapter 1(Table 1-1 & Figure 1).

2.3 Measurement Results of Occupied Bandwidth / Band-edge

Test Date: January 10, 2002

Table 2-1. EUT: M/T 2366-52U, s/n ZZ-00163 , TX mode 11Mbps

Center Frequency (MHz)	Lower Frequency (MHz)	Upper Frequency (MHz)	Bandwidth at 20 dB below (MHz)	Margin to Lower limit (MHz)	Margin to Upper limit (MHz)
2412 (ch. 1)	2403.67	2420.75	17.08	3.67	
2437 (ch. 6)	2428.67	2445.75	17.08		
2462 (ch. 11)	2453.67	2470.75	17.08		12.75

2.4 Measurement Results of Out of Band Emissions

All conducted emission in any 100kHz bandwidth outside of the spread spectrum band was at least 20dB lower than the highest inband spectral density.

Test Date: January 10, 2002

2.5 Trace Data of Band-edge



Ref Lvl	Marker 1 [T1]	RBW	100 kHz	RF Att	40 dB
25 dBm	4.53 dBm	VBW	100 kHz		
	2.41311222 GHz	SWT	7.5 ms	Unit	dBm

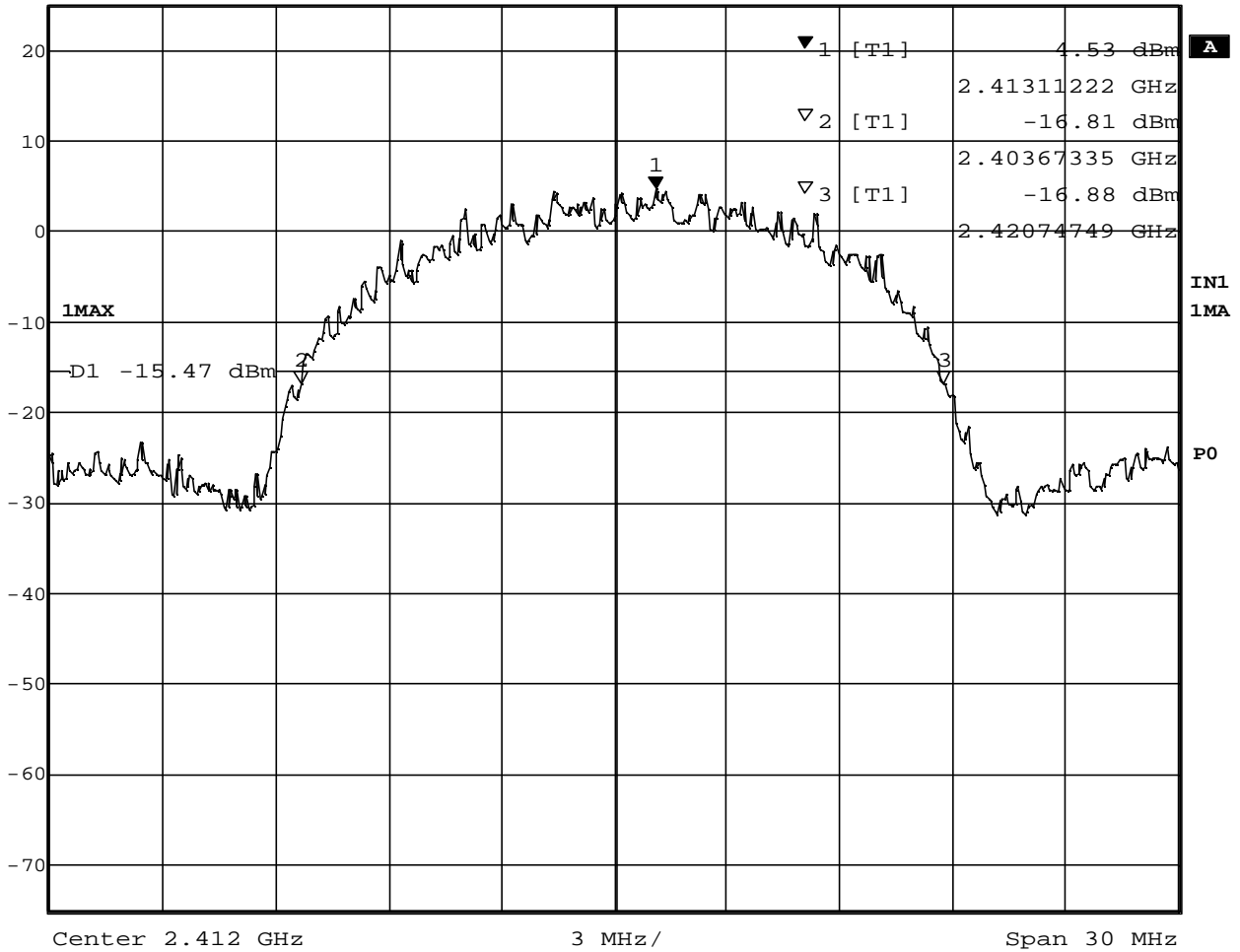

Date: 10.JAN.2002 13:06:20



Marker 1 [T1] RBW 100 kHz RF Att 40 dB
Ref Lvl 4.81 dBm VBW 100 kHz
25 dBm 2.43811222 GHz SWT 7.5 ms Unit dBm

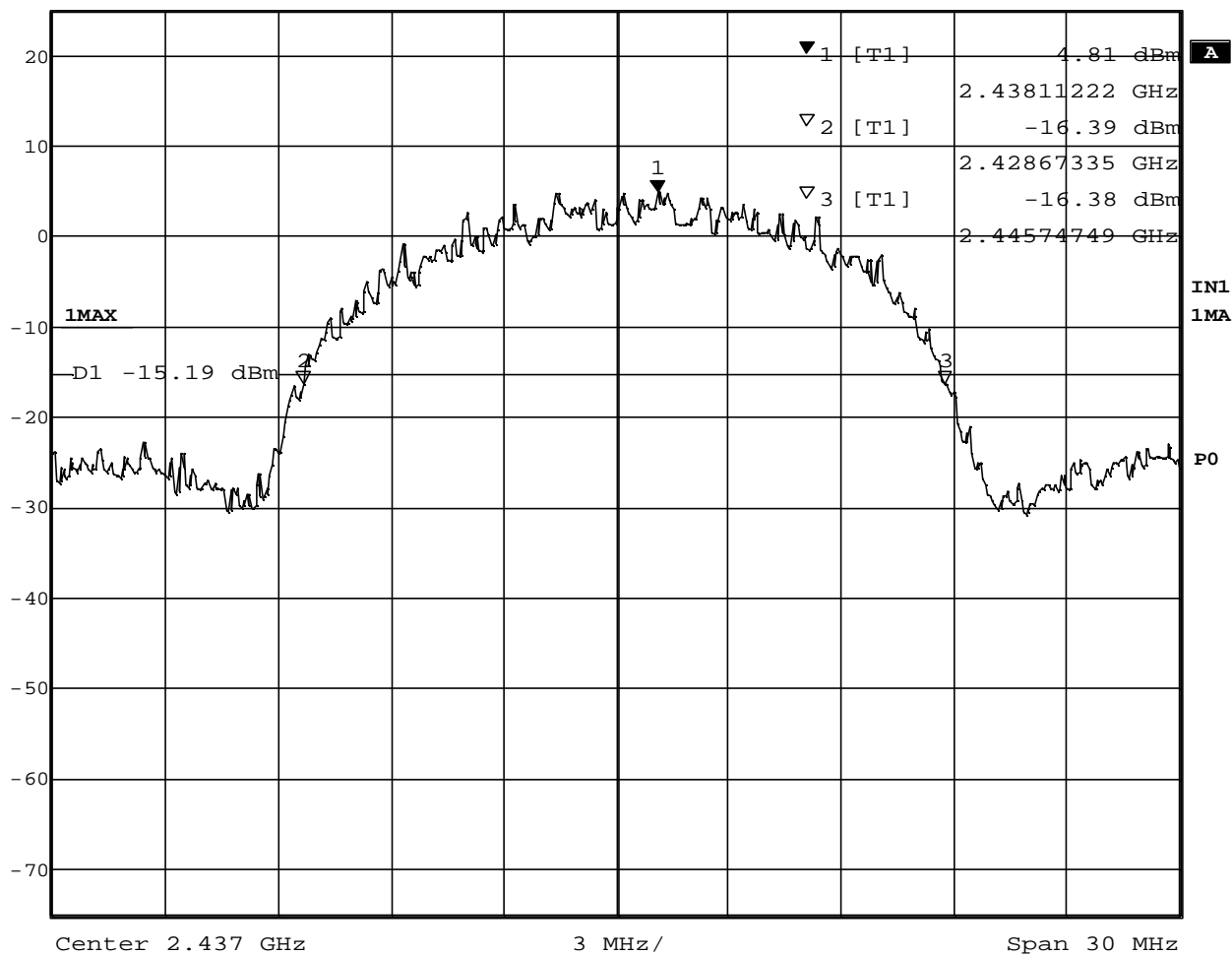

Date: 10.JAN.2002 13:08:53

2.6 Trace Data of Out of Band Emissions

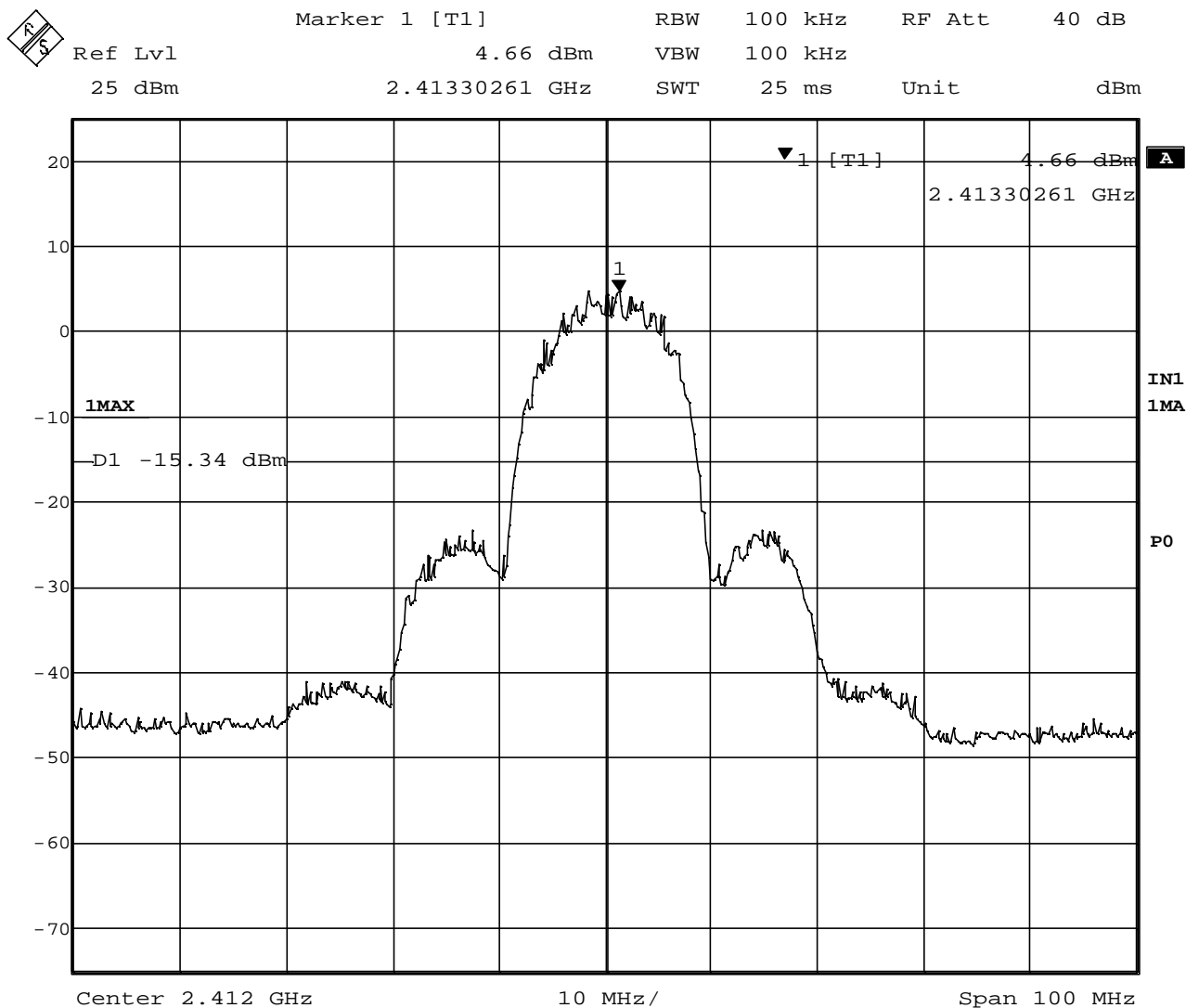

Date: 10.JAN.2002 13:13:03

3. Transmitter Output Power

3.1 Test Procedure

- A transmitter antenna terminal of EUT is connected to the input of a RF power sensor.
- Measurement is made while EUT is operating in transmission mode at the appropriate center frequency.

Table 3-1 : 6 dB Bandwidth Test Instruments

Description	Model	Serial Number
Power Meter	HP 436A	2604A24192
Power Sensor	HP 8482A	2607A10987
Coax cables: - Power Sensor <=> EUT	Length: 30 cm Loss: 1.1dB	

Notes: - HP: Hewlett Packard

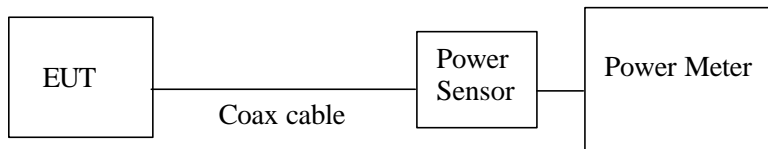

Figure 3: Measurement setup for RF output power

3.2 Measurement Results

Test Date: January 10, 2002

Table 3-2. EUT: M/T 2366-52U, s/n ZZ-00163, TX mode 11Mbps

Measured Frequency (MHz)	Power Meter Reading (dBm)	Cable Loss (dB)	Results		Limit [1W] (dBm)	Margin (dB)
			(dBm)	(W)		
2412 (ch. 1)	15.9	1.1	17.0	0.0501	30.0	13.0
2437 (ch. 6)	15.9	1.1	17.0	0.0501	30.0	13.0
2462 (ch. 11)	15.7	1.1	16.8	0.0479	30.0	13.2

Table 3-3. EUT: M/T 2366-52U, s/n ZZ-00163, TX mode 2Mbps

Measured Frequency (MHz)	Power Meter Reading (dBm)	Cable Loss (dB)	Results		Limit [1W] (dBm)	Margin (dB)
			(dBm)	(W)		
2412 (ch. 1)	15.8	1.1	16.9	0.0490	30.0	13.1
2437 (ch. 6)	15.8	1.1	16.9	0.0490	30.0	13.1
2462 (ch. 11)	15.6	1.1	16.7	0.0468	30.0	13.3

4. Transmitter Power Spectral Density

4.1 Test Procedure

The peak power density is measured with a spectrum analyzer connected to the antenna terminal, while EUT is operating in transmission mode at the appropriate center frequency.

The spectrum analyzer is set to:

RBW= 3kHz, VBW=100kHz, Span=10MHz, Sweep = 2.8 seconds

4.2 Test Instruments and Measurement Setup

Same as the Chapter 1(Table 1-1 & Figure 1).

4.3 Measurement Results

Test Date: January 10, 2002

Table 4-1. EUT: M/T 2366-52U, s/n ZZ-00163 , TX mode 11Mbps

Ch No.	Frequency (MHz)	Spectrum Analyzer Reading (dBm)	Cable loss (dB)	Result (dBm)	Limit (dBm)	Margin (dB)
1	2410.41	-8.0	1.7	-6.3	8.0	14.3
6	2435.41	-7.8	1.7	-6.1	8.0	14.1
11	2460.41	-7.9	1.7	-6.2	8.0	14.2

4.4 Trace Data



Ref Lvl	Marker 1 [T1]	RBW	3 kHz	RF Att	40 dB
25 dBm	-8.00 dBm	VBW	100 kHz		
	2.41040681 GHz	SWT	2.8 s	Unit	dBm

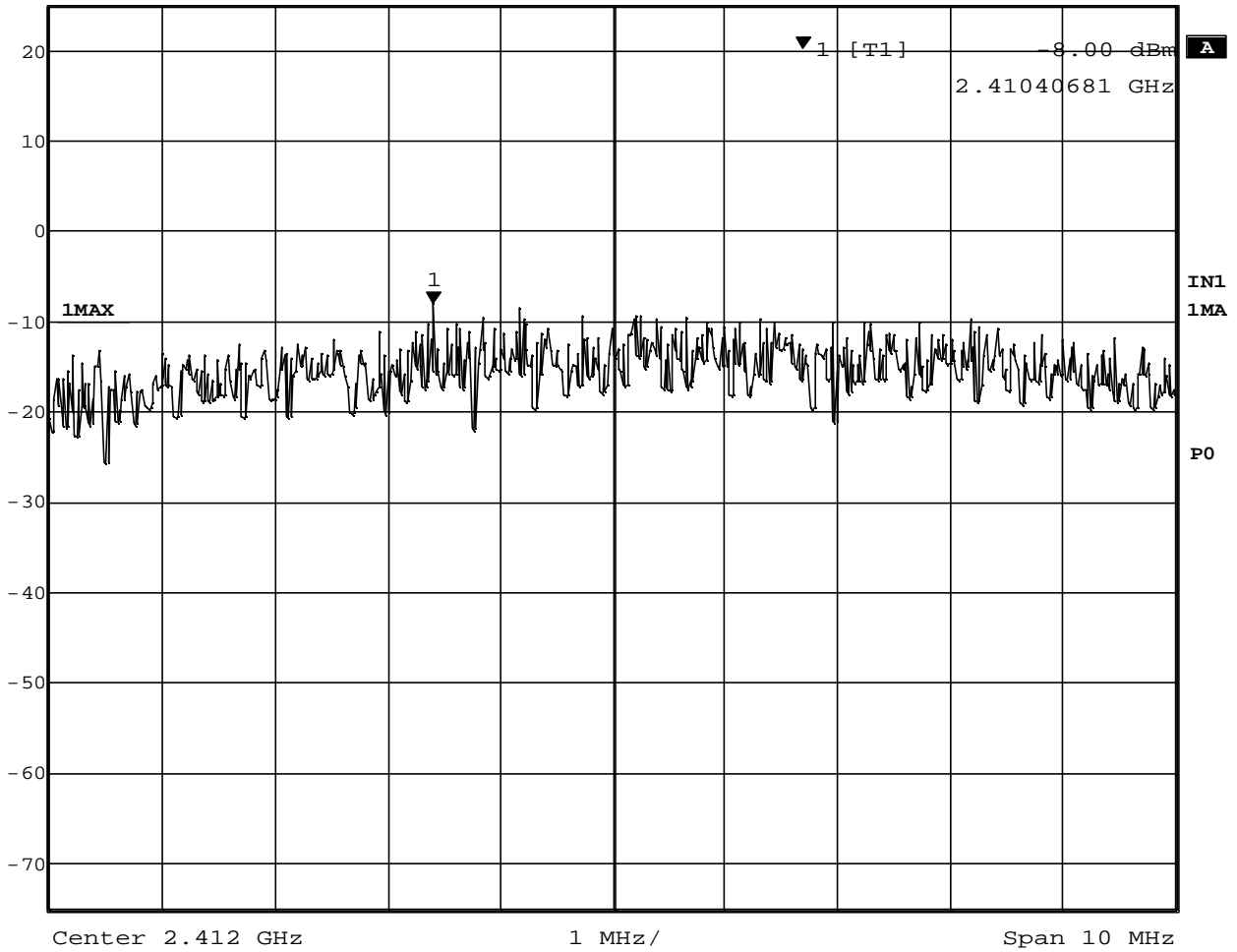

Date: 10.JAN.2002 13:17:21



Marker 1 [T1] RBW 3 kHz RF Att 40 dB
Ref Lvl -7.80 dBm VBW 100 kHz
25 dBm 2.43540681 GHz SWT 2.8 s Unit dBm

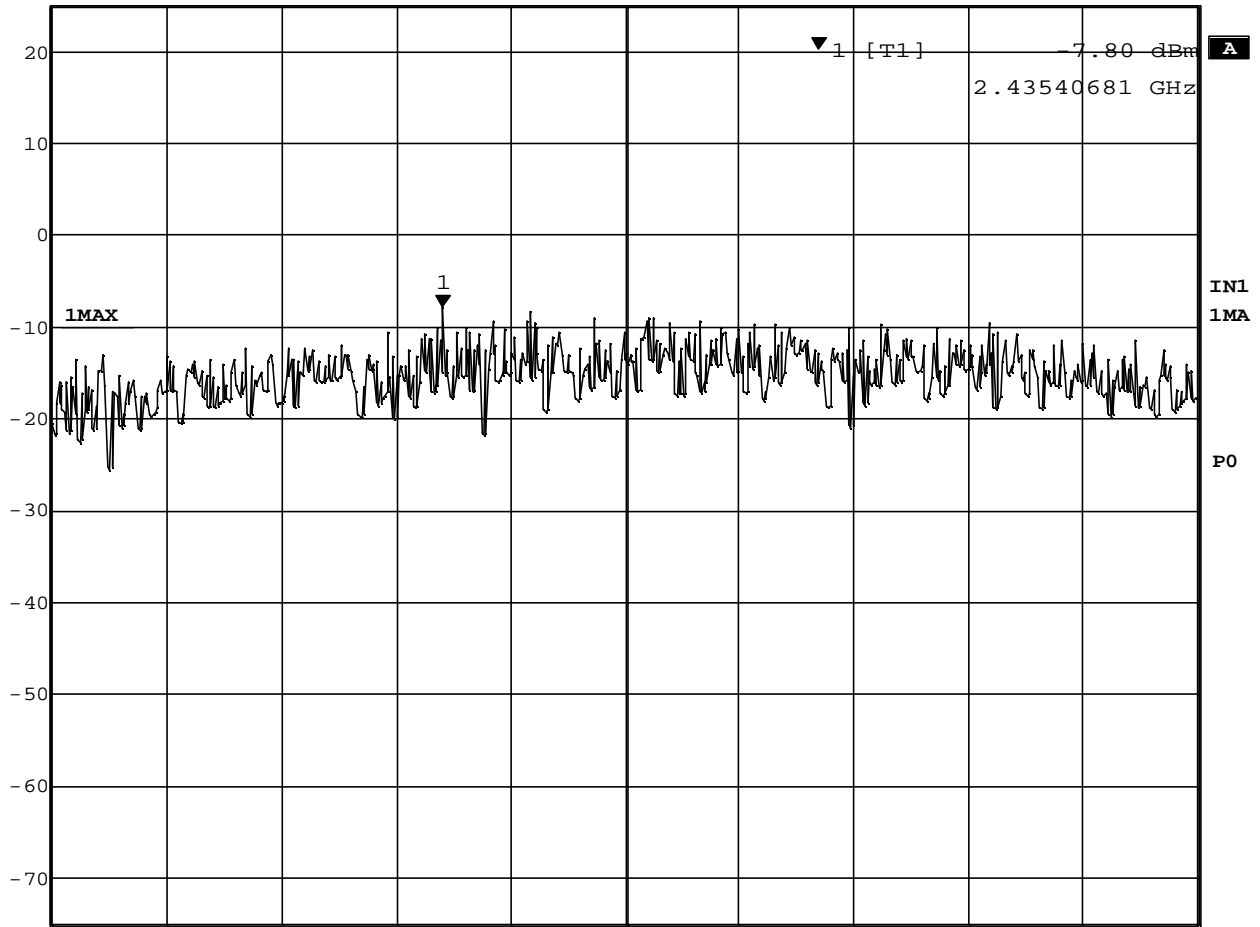

Center 2.437 GHz 1 MHz/ Span 10 MHz

Date: 10.JAN.2002 13:18:21



Marker 1 [T1] RBW 3 kHz RF Att 40 dB
Ref Lvl -7.88 dBm VBW 100 kHz
25 dBm 2.46040681 GHz SWT 2.8 s Unit dBm

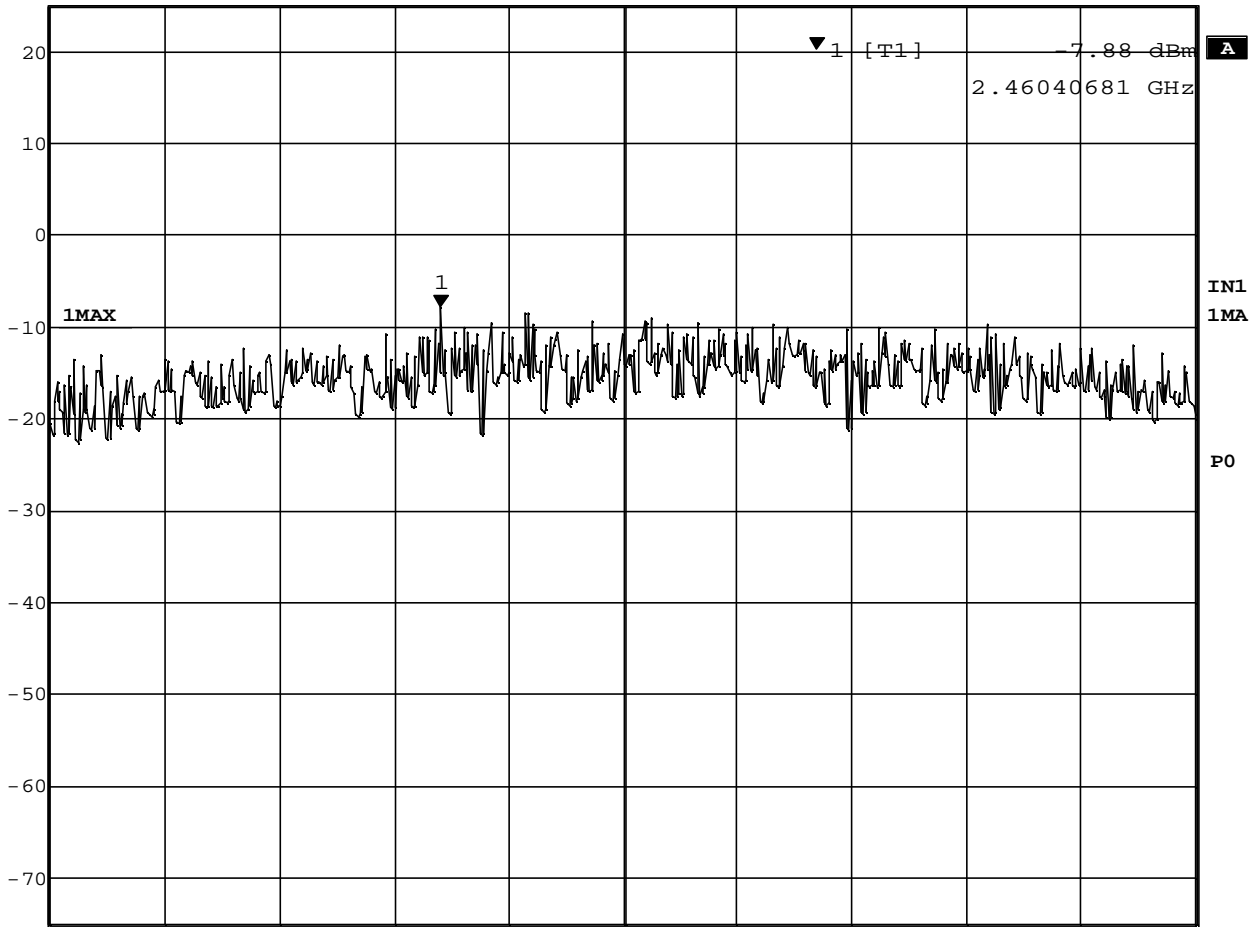

Center 2.462 GHz 1 MHz/ Span 10 MHz

Date: 10.JAN.2002 13:18:59

5. AC WIRELINE CONDUCTED EMISSIONS (450KHz – 30MHz)

5.1 Test Procedure

The conducted emissions are measured in the IBM shielded room with a spectrum analyzer in peak hold. Emissions closest to the limit are measured in the quasi-peak mode (QP) with the tuned receiver using a bandwidth of 9KHz. The emissions are maximized further by cable manipulation. The highest emissions relative to the limit are listed.

5.2 Test Instruments and Measurement Setup

Table 5-1. Conducted Emission Test Instrumentation

Description	Model	Serial Number
Computer	IBM 6589-13J	97-15613
Spectrum Analyzer (100Hz-1.5GHz)	HP 8568B	2732A03651
Spectrum Analyzer Display	HP 8568B	2648A15255
Quasi-Peak Adapter	HP 85650A	2521A00968
Receiver (9kHz-30MHz)	R&S ESH3	891806/012
LISN	EMCO 3825/2	1426
Switch/control unit	HP 3488A	2719A17228
Plotter	HP 7550A	2631A33619
Coax cables: - Liscn-L <=> SW/Con.unit (SW100) - Liscn-N <=> SW/Con.unit (SW101) - SW/Con.unit <=> RCVR (Input) - SW/Con.unit<=> Spe Ana.(Signal In)	Length: 4 m 4 m 1 m 1 m	- EMIC-L - EMIC-N - EMIC-R - EMIC-S

Notes: - HP: Hewlett Packard, R&S: Rohde & Schwarz

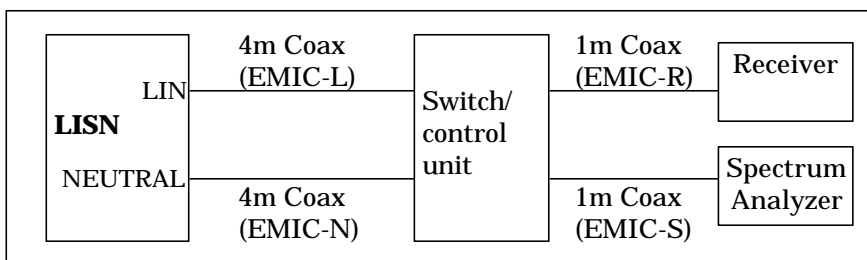

Figure 5. Cables for Conducted Emission Test

5.3 Measurement Results

The EUT was found to comply to the limits of FCC Part 15 Subpart C and RSS-210 with a margin of 16.0 dB. The 6 highest emissions relative to the limits are reported.

Test Date: January 11, 2002

1) EUT in transmission mode

Table 5-2-1. EUT: M/T 2366-52U, s/n ZZ-00163, Ch.1(2412MHz) TX mode 11Mbps

Frequency (MHz)	QP Voltage (dBμV)	QP Limit (dBμV)	QP Voltage (μV)	QP Limit (μV)	Phase
0.5145	26.9	48	22.1	250	LINE
0.5878	23.1	48	14.3	250	LINE
0.6381	23.6	48	15.1	250	LINE
0.8331	16.1	48	6.4	250	LINE
16.1287	24.9	48	17.6	250	NEUTRAL
22.9646	27.5	48	23.7	250	NEUTRAL

Table 5-2-2. EUT: M/T 2366-52U, s/n ZZ-00163 , Ch.6(2437MHz) TX mode 11Mbps

Frequency (MHz)	QP Voltage (dBμV)	QP Limit (dBμV)	QP Voltage (μV)	QP Limit (μV)	Phase
0.5144	32.0	48	39.8	250	LINE
0.5800	27.9	48	24.8	250	NEUTRAL
0.6465	27.8	48	24.5	250	LINE
0.7018	24.8	48	17.4	250	LINE
12.1355	27.8	48	24.5	250	NEUTRAL
22.3801	29.6	48	30.2	250	NEUTRAL

Table 5-2-3. EUT: M/T 2366-52U, s/n ZZ-00163, Ch.11(2462MHz) TX mode 11Mbps

Frequency (MHz)	QP Voltage (dBμV)	QP Limit (dBμV)	QP Voltage (μV)	QP Limit (μV)	Phase
0.5239	30.1	48	32.0	250	NEUTRAL
0.5860	25.8	48	19.5	250	NEUTRAL
0.6378	24.7	48	17.2	250	LINE
1.2785	20.3	48	10.4	250	NEUTRAL
23.7675	30.1	48	32.0	250	NEUTRAL
26.1466	26.1	48	20.2	250	LINE

2) EUT in receiving mode

Table 5-2-4. EUT: M/T 2366-52U, s/n ZZ-00163, RX mode

Frequency (MHz)	QP Voltage (dB μ V)	QP Limit (dB μ V)	QP Voltage (μ V)	QP Limit (μ V)	Phase
0.5160	28.4	48	26.3	250	LINE
0.5890	26.0	48	20.0	250	LINE
0.6386	24.5	48	16.8	250	LINE
0.7165	20.7	48	10.8	250	NEUTRAL
24.114	28.5	48	26.6	250	NEUTRAL
27.7321	23.4	48	14.8	250	LINE

6. RESTRICTED BANDS RADIATIONS (30MHz – 1GHz)

6.1 Test Procedure

Preliminary radiated emissions are measured in the semi-anechoic chamber at a 3 meter distance on every azimuth in both horizontal and vertical polarity. The antennas are also scanned in height. The emissions are recorded with a spectrum analyzer in peak hold mode. The identified emissions are further maximized by a cable manipulation. Emissions closest to the limits are measured in the quasi-peak mode with the tuned receiver using a bandwidth of 120kHz. The highest emissions relative to the limit are listed.

6.2 Test Instruments and Measurement Setup

Table 6-1 Radiated Emission Test Instrumentation

Description	Model	Serial Number
Computer	IBM 5551-L	#4
Spectrum Analyzer (100Hz-1.5GHz) for 30-200MHz	HP 85680B	3019A05155
Spectrum Analyzer Display for 30-200MHz	HP 85662A	3026A19353
Quasi-Peak Adapter for 30-200MHz	HP 85650A	3033A01449
Spectrum Analyzer (100Hz-1.5GHz) for 200-1000MHz	HP 85680B	3019A05156
Spectrum Analyzer Display for 200-1000MHz	HP 85662A	3026A19366
Quasi-Peak Adapter for 200-1000MHz	HP 85650A	2811A01433
Amplifier (100KHz-1.3GHz)		
- for 30-200MHz	HP 8447D	2805A02919
- for 200-1000MHz	HP 8447D	2944A03506
Biconical Antenna (30-200MHz)	EMCO 3108	2241
Log-Periodic Antenna (200-1000MHz)	EMCO 3146	1584
Receiver (20MHz-1.3GHz)	R&S ESVP	893202/018
Switch/control unit	HP 3488A	2719A17226
N-Coax cables:	Length:	
- Bi-coni Ant <=> 10m Cable	9 m	- EM203L01
- 10m Cable <=> Shield Panel	10 m	- EM203L02
- Shield Panel <=> RF Amp	7 m	- EM203L03
- RF Amp <=> Power Splitter	0.5m	- EM203L04
- Log-peri Ant <=> 10m Cable	9 m	- EM203H01
- 10m Cable <=> Shield Panel	10 m	- EM203H02
- Shield Panel <=> RF Amp	7 m	- EM203H03
- RF Amp <=> Power Splitter	0.5m	- EM203H04
Coax cables:		
- Power Splitter <=> SW/Con.unit (SW110)	1 m	- EM203L05
- Power Splitter <=> SW/Con.unit (SW300)	1 m	- EM203L06
- Power Splitter <=> SW/Con.unit (SW100)	1 m	- EM203H05
- Power Splitter <=> SW/Con.unit (SW301)	1 m	- EM203H06
- SW/Con.unit <=> Receiver (Input)	2 m	- EM2RCV

- SW/Con.unit <=> Spe Ana.(Signal In) for 30- 200MHz	2 m	- EM2SPL
- SW/Con.unit <=> Spe Ana.(Signal In) for 200-1000MHz	2 m	- EM2SPH

Notes:

- HP: Hewlett Packard, R&S: Rohde & Schwarz

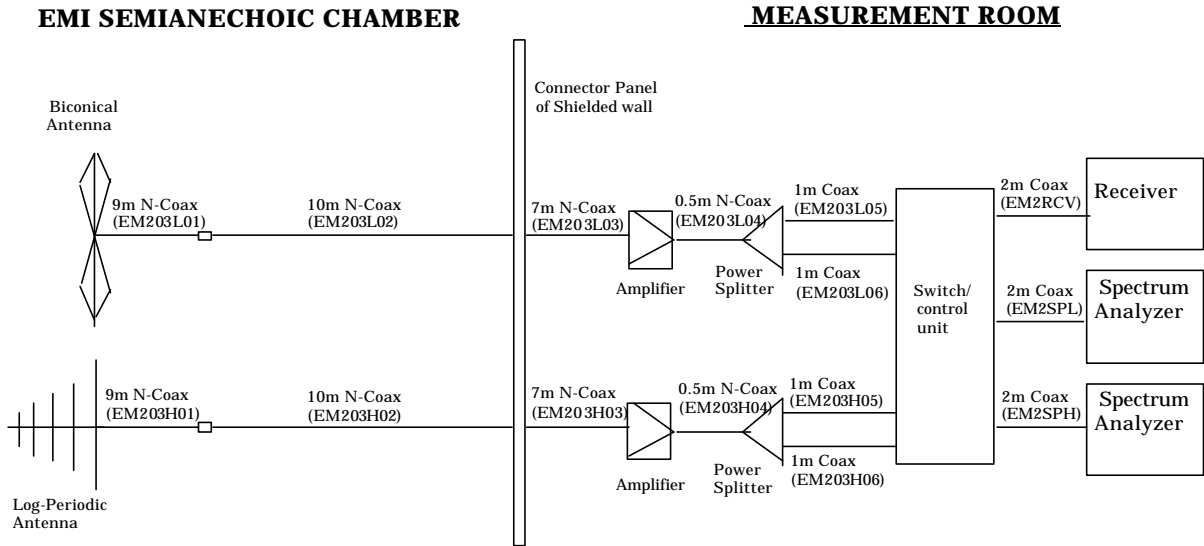

Figure 6 Cables for Radiated Emission Test

6.3 Field Strength Calculation

The field strength is calculated by adding the Antenna Factor and Cable Loss, and subtracting Amplifier Gain from the measured reading. In this test facility, the Antenna Factor, Cable Loss, and Amplifier Gains are loaded into the Rohde & Schwarz Receiver and the corrected field strength can be read directly on the receiver. All factors are included in the reported data.

$$FS = R + AF + CORR$$

where:

FS	=	Field Strength
R	=	Measured Receiver Input Amplitude
AF	=	Antenna Factor
CORR	=	Correction Factor = CL - AG
CL	=	Cable Loss
AG	=	Amplifier Gain

For example:

Given a Receiver input reading of 51.5dB μ V; Antenna Factor of 8.5dB/m; Cable Loss of 1.3dB; and an Amplifier Gain of 26dB. The Field Strength of the measured emission is:

$$FS = 51.5 + 8.5 + 1.3 - 26.0 = 35.3\text{dB}\mu\text{V/m}$$

Conversion between dB μ V/m (or dB μ V) and μ V/m (or μ V) are done as:

$$\text{Level(dB}\mu\text{V/m)} = 20 \times \text{Log(Level}(\mu\text{V/m))}$$

$$40\text{dB}\mu\text{V/m} = 100\mu\text{V/m}$$

$$48\text{dB}\mu\text{V/m} = 250\mu\text{V/m}$$

6.4 Measurement Results

The EUT was found to comply to the limits of FCC Part 15 Subpart C and RSS-210 with a margin of 3.2 dB at 30MHz - 1000MHz band.

The 6 highest emissions relative to the limits are reported.

Test Date: January 17, 2002

1) EUT in transmission mode

Table 6-2-1. EUT: M/T 2366-52U, s/n ZZ-00163, Ch.1(2412MHz) TX mode 11Mbps

Frequency (MHz)	Polarity (H/V)	Measured (dBμV)	Antenna Factor (dB/m)	Corr. Factor (dB)	Field Strength (dBμV/m)	Limit (dBμV/m)	Field Strength (μV/m)	Limit (μV/m)
172.008	H	35.9	13.0	-18.1	30.8	43.5	34.7	150
182.257	H	37.8	13.1	-17.8	33.1	43.5	45.2	150
191.003	H	35.7	13.4	-17.8	31.3	43.5	36.7	150
364.515	H	36.5	14.2	-14.4	36.3	46.0	65.3	200
729.029	V	34.6	20.6	-13.7	41.5	46.0	118.9	200
959.953	V	25.2	23.2	-11.5	36.9	46.0	70.0	200

Table 6-2-2. EUT: M/T 2366-52U, s/n ZZ-00163, Ch.6(2437MHz) TX mode 11Mbps

Frequency (MHz)	Polarity (H/V)	Measured (dBμV)	Antenna Factor (dB/m)	Corr. Factor (dB)	Field Strength (dBμV/m)	Limit (dBμV/m)	Field Strength (μV/m)	Limit (μV/m)
182.258	H	38.2	13.1	-17.8	33.5	43.5	47.3	150
189.023	H	35.3	13.4	-17.8	30.9	43.5	35.1	150
364.515	H	35.6	14.2	-14.4	35.4	46.0	58.9	200
729.030	V	34.9	20.6	-13.7	41.8	46.0	123.0	200
799.553	H	21.6	21.2	-12.8	30.0	46.0	31.6	200
842.038	V	26.3	21.9	-12.7	35.5	46.0	59.6	200

Table 6-2-3. EUT: M/T 2366-52U, s/n ZZ-00163, Ch.11(2462MHz) TX mode 11Mbps

Frequency (MHz)	Polarity (H/V)	Measured (dBμV)	Antenna Factor (dB/m)	Corr. Factor (dB)	Field Strength (dBμV/m)	Limit (dBμV/m)	Field Strength (μV/m)	Limit (μV/m)
191.438	H	35.4	13.4	-17.9	30.9	43.5	35.1	150
364.515	H	35.8	14.2	-14.4	35.6	46.0	60.3	200
729.030	H	35.9	20.6	-13.7	42.8	46.0	138.0	200
798.666	H	21.2	21.2	-13.0	29.4	46.0	29.5	200
842.038	V	26.3	21.9	-12.7	35.5	46.0	59.6	200
959.953	H	22.9	23.2	-11.5	34.6	46.0	53.7	200

2) EUT in receiving mode

Table 6-2-4. EUT: M/T 2366-52U, s/n ZZ-00163, RX mode

Frequency (MHz)	Polarity (H/V)	Measured (dBμV)	Antenna Factor (dB/m)	Corr. Factor (dB)	Field Strength (dBμV/m)	Limit (dBμV/m)	Field Strength (μV/m)	Limit (μV/m)
190.937	H	35.7	13.4	-17.8	31.3	43.5	36.7	150
364.515	H	35.8	14.2	-14.4	35.6	46.0	60.3	200
428.998	V	32.8	15.6	-14.5	33.9	46.0	49.5	200
729.029	H	35.0	20.6	-13.7	41.9	46.0	124.5	200
842.058	V	26.3	21.9	-12.7	35.5	46.0	59.6	200
959.953	V	24.9	23.2	-11.5	36.6	46.0	67.6	200

7. RESTRICTED BANDS RADIATIONS (1GHz – 25GHz)

7.1 Test Procedure

Radiated emissions were measured in the frequency range with 1 GHz to 25GHz in transmitting mode and 1 GHz to 12.5 GHz in receiving mode. All tests were performed in the semi-anechoic chamber at a 3-meter distance (except for the frequency range with 18 GHz to 25 GHz where test distance was reduced to 1 meter) on both horizontal and vertical polarities. The antenna was also scanned in height. The emissions are recorded with a spectrum analyzer in peak hold mode. The identified emissions are further maximized as a function of cable manipulation, azimuth, and antenna height. The emissions closest to the limits are measured in the peak mode with the tuned spectrum analyzer using a bandwidth of 1MHz and the average setting mode with the tuned spectrum analyzer using resolution bandwidth of 1MHz / video bandwidth of 1kHz. The highest emissions relative to the limit are listed.

7.2 Test Instruments and Measurement Setup

Table 7 Radiated Emission Test Instrumentation (1GHz – 25GHz)

Description	Model	Serial Number
Spectrum Analyzer EMI Test Receiver	R&S ESI26	836119/003
Amplifier (1-26.5GHz)	HP 8449B	3008A00582
Horn Antenna (1- 18GHz)	EMCO 3115	9903-5774
Horn Antenna (3.95 – 5.85GHz)	EMCO 3160-5	1099
Horn Antenna (5.85 – 8.20GHz)	EMCO 3160-6	9712-1044
Horn Antenna (18- 26.5GHz)	EMCO 3160-9	0004-1202
SF106 cables: - Horn Ant => RF Amp. - RF Amp.<=>Spectrum Analyzer	Length: 6 m 15 m	- EM206SCO - EM215SCO

Notes: - HP: Hewlett Packard, R&S: Rohde & Schwarz

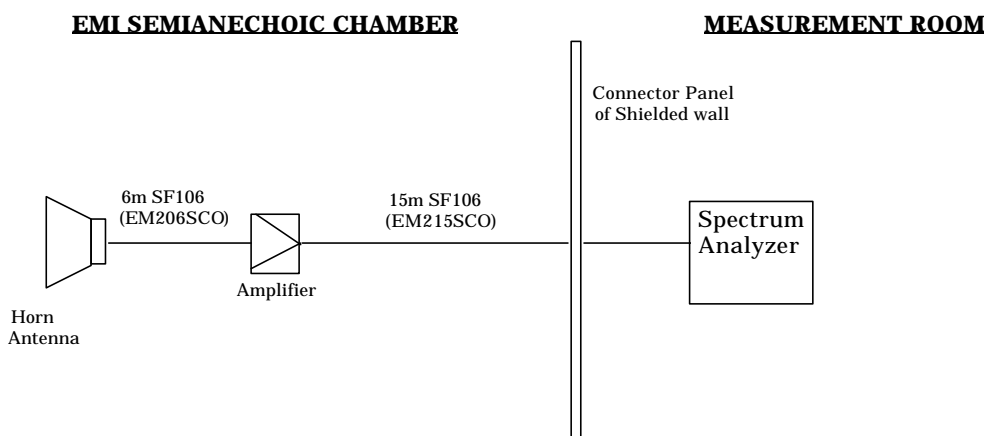

Figure 7 Cables for Radiated Emission Test

7.3 Field Strength Calculation

The field strength is calculated by adding the Antenna Factor and Cable Loss, and subtracting Amplifier Gain from the measured reading. All factors are included in the reported data.

$$FS = R + AF + CORR - FO$$

where:

- FS = Field Strength
- R = Measured Spectrum analyzer Input Amplitude
- AF = Antenna Factor
- CORR = Correction Factor = CL-AG
- CL = Cable Loss
- AG = Amplifier Gain
- FO = Distance Falloff Factor

For example:

Given a Spectrum Analyzer input reading of 51.5 dBμV; Antenna Factor of 8.5 dB/m; Cable Loss of 1.3 dB; Falloff Factor of 0 dB; and an Amplifier Gain of 26 dB. The Field Strength of the measured emission is:

$$FS = 51.5 + 8.5 + 1.3 - 26 - 0.0 = 35.6 \text{ dB}\mu\text{V/m}$$

Conversions between dBμV/m (or dBμV) and μV/m (or μV) are done as :

Level(dBμV/m)	=	20 × Log (Level(μV/m))
40 dBμV/m	=	100 μV/m
48 dBμV/m	=	250 μV/m

7.4 Measurement Results

The EUT was found to comply to the limits of FCC Part 15 Subpart C and RSS-210 with a margin of 9.8 dB. The measurement was done for the frequency range of 1 GHz to 25 GHz in TX mode and 1 GHz to 12.5GHz in RX mode.

Test Date: January 11 and February 1, 2002

1) EUT in transmission mode

Table 7-2-1. EUT: M/T 2366-52U, s/n ZZ-00163, Ch.1(2412MHz) TX mode 11Mbps

Frequency (GHz)	Polarity (H/V)	Measured (dBμV) (peak)	Measured (dBμV) (average)	Antenna Factor (dB/m)	Corr. Factor (dB)	Falloff Factor (dB)	Field Strength (dBμV/m) (peak)	FCC Limit (dBμV/m) (peak)	Field Strength (dBμV/m) (average)	FCC Limit (dBμV/m) (average)
1.092	V	49.4	-	24.3	-31.3	0.0	42.4	74.0	-	54.0
1.132	V	49.3	-	24.4	-31.3	0.0	42.4	74.0	-	54.0
1.199	V	48.2	-	24.6	-31.2	0.0	41.6	74.0	-	54.0
1.459	V	49.0	-	25.2	-30.6	0.0	43.6	74.0	-	54.0
2.037	V	52.1	47.7	27.5	-29.5	0.0	50.1	NRB*	45.7	NRB*
2.302	V	49.2	-	28	-28.7	0.0	48.5	74.0	-	54.0
2.324	V	49.4	-	28	-28.7	0.0	48.7	74.0	-	54.0
2.346	V	50.0	-	28.1	-28.6	0.0	49.5	74.0	-	54.0
2.389	H	51.8	-	28.2	-28.5	0.0	51.5	74.0	-	54.0
2.398	H	56.8	49.0	28.2	-28.4	0.0	56.6	NRB*	48.8	NRB*
2.413	H	101.8	97.0	28.2	-28.4	0.0	101.6	OB*	96.8	OB*
4.074	V	40.2	-	27.4	-24.3	0.0	43.3	74.0	-	54.0

*Note: OB means “operation band” (2400-2483.5MHz); in this case limit is 1W (measured conducted with power meter).
NRB means “non restricted band”.

Table 7-2-2. EUT: M/T 2366-52U, s/n ZZ-00163, Ch.6(2437MHz) TX mode 11Mbps

Frequency (GHz)	Polarity (H/V)	Measured (dBμV) (<i>peak</i>)	Measured (dBμV) (<i>average</i>)	Antenna Factor (dB/m)	Corr. Factor (dB)	Falloff Factor (dB)	Field Strength (dBμV/m) (<i>peak</i>)	FCC Limit (dBμV/m) (<i>peak</i>)	Field Strength (dBμV/m) (<i>average</i>)	FCC Limit (dBμV/m) (<i>average</i>)
1.092	V	49.3	-	24.3	-31.3	0.0	42.3	74.0	-	54.0
1.132	V	49.1	-	24.4	-31.3	0.0	42.2	74.0	-	54.0
1.199	V	49.5	-	24.6	-31.2	0.0	42.9	74.0	-	54.0
1.459	V	49.0	-	25.2	-30.6	0.0	43.6	74.0	-	54.0
2.063	H	52.5	48.6	27.5	-29.4	0.0	50.6	NRB*	46.7	NRB*
2.327	H	50.2	-	28	-28.7	0.0	49.5	74.0	-	54.0
2.350	H	49.3	-	28.1	-28.6	0.0	48.8	74.0	-	54.0
2.371	H	51.4	-	28.1	-28.6	0.0	50.9	74.0	-	54.0
2.438	H	101.2	97.1	28.3	-28.4	0.0	101.1	OB*	97.0	OB*
2.492	H	52.2	-	28.4	-28.2	0.0	52.4	54.0	-	54.0
4.124	V	40.0	-	27.4	-24.3	0.0	43.1	74.0	-	54.0

*Note: OB means “operation band” (2400-2483.5MHz); in this case limit is 1W (measured conducted with power meter).
NRB means “non restricted band”.

Table 7-2-3. EUT: M/T 2366-52U, s/n ZZ-00163, Ch.11(2462MHz) TX mode 11Mbps

Frequency (GHz)	Polarity (H/V)	Measured (dBμV) (<i>peak</i>)	Measured (dBμV) (<i>average</i>)	Antenna Factor (dB/m)	Corr. Factor (dB)	Falloff Factor (dB)	Field Strength (dBμV/m) (<i>peak</i>)	FCC Limit (dBμV/m) (<i>peak</i>)	Field Strength (dBμV/m) (<i>average</i>)	FCC Limit (dBμV/m) (<i>average</i>)
1.092	V	49.4	-	24.3	-31.3	0.0	42.4	74.0	-	54.0
1.132	V	50.3	-	24.4	-31.3	0.0	43.4	74.0	-	54.0
1.199	V	50.1	-	24.6	-31.2	0.0	43.5	74.0	-	54.0
1.459	V	49.5	-	25.2	-30.6	0.0	44.1	74.0	-	54.0
2.088	H	53.3	50.0	27.6	-29.3	0.0	51.6	NRB*	48.3	NRB*
2.330	H	50.6	-	28.1	-28.6	0.0	50.1	74.0	-	54.0
2.342	H	51.1	-	28.1	-28.6	0.0	50.6	74.0	-	54.0
2.353	H	50.7	-	28.1	-28.6	0.0	50.2	74.0	-	54.0
2.463	H	101.5	97.2	28.3	-28.3	0.0	101.5	OB*	97.2	OB*
2.484	H	53.3	42.0	28.4	-28.2	0.0	53.5	74.0	42.2	54.0
2.505	H	52.9	44.0	28.4	-28.2	0.0	53.1	74.0	44.2	54.0
4.174	V	39.0	-	27.4	-24.2	0.0	42.2	74.0	-	54.0

*Note: OB means “operation band” (2400-2483.5MHz); in this case limit is 1W (measured conducted with power meter).
NRB means “non restricted band”.

2) EUT in receiving mode

Table 7-2-4. EUT: M/T 2366-52U, s/n ZZ-00163, RX mode

Frequency (GHz)	Polarity (H/V)	Measured (dBμV) <i>(peak)</i>	Measured (dBμV) <i>(average)</i>	Antenna Factor (dB/m)	Corr. Factor (dB)	Falloff Factor (dB)	Field Strength (dBμV/m) <i>(peak)</i>	FCC Limit (dBμV/m) <i>(peak)</i>	Field Strength (dBμV/m) <i>(average)</i>	FCC Limit (dBμV/m) <i>(average)</i>
1.092	V	48.8	-	24.3	-31.5	0.0	41.6	74.0	-	54.0
1.132	V	49.4	-	24.4	-31.2	0.0	42.6	74.0	-	54.0
1.199	V	49.1	-	24.6	-31.2	0.0	42.5	74.0	-	54.0
1.459	V	48.9	-	25.2	-30.6	0.0	43.5	74.0	-	54.0
2.063	V	48.9	-	27.5	-29.4	0.0	47.0	74.0	-	54.0
4.124	V	40.9	-	27.4	-24.3	0.0	44.0	74.0	-	54.0