

Emission Test Report

Standard: FCC Part 15 Subpart C / IC RSS-210

Document Number : FCC 19-0182-0

Product: IBM ThinkPad T30 Series
Included IBM Bluetooth Daughter Card

FCC ID: ANOCORN1TASUHOP
IC: xxxxxx-CORN1HOP

January 29, 2002

Prepared :
EMC Engineer

Takeshi Asano

Signature:



IBM Japan, Ltd.
EMC Engineering
LAB-S59

1623-14, Shimotsuruma,
Yamato-shi Kanagawa-ken 242, Japan
Phone: +81-46-215-4779
Fax: +81-46-273-7420
E-Mail: asano@jp.ibm.com

Reviewed and Checked :
EMC Staff Engineer

Toshiya Murota

Signature:



IBM Japan, Ltd.
EMC Engineering
LAB-S59

1623-14, Shimotsuruma,
Yamato-shi Kanagawa-ken 242, Japan
Phone: +81-46-215-6574
Fax: +81-46-273-7420
E-Mail: murota@jp.ibm.com

Approved :
Manager, EMC Engineering

Akihisa Sakurai

Signature:



IBM Japan, Ltd.
EMC Engineering
LAB-S59

1623-14, Shimotsuruma,
Yamato-shi Kanagawa-ken 242, Japan
Phone: +81-46-215-2613
Fax: +81-46-273-7420
E-Mail: akihisa@jp.ibm.com

Annex A Summary of test results

Equipment model : ThinkPad T30 Series

Test report page
or reference

Transmitter tested to RSS-210 section <u>6.2.2(o)</u>	
Field strength _____ $\mu\text{V/m}$ at a distance of _____ metres	_____
or	
RF power <u>0.00245</u> watts	<u>29</u>
Peak – to – average ratio _____ dB or G CISPR	_____
Test conditions : G Radiated (sections 11 & 13)	_____
G At antenna (section 10)	_____
G DC input power (section 12)	_____
<hr/>	
Transmitter frequency <u>center freq. 2402MHz + 1MHz \times N (N=0 to 78ch)</u>	<u>6</u>
Designation of Emission (see section 5.9.2) <u>782KF1D</u>	_____
Occupied Bandwidth (measured) <u>78.75MHz (782KHz/ch)</u>	<u>35</u>
Frequency tuning range : Min. _____ Max. _____	_____
Frequency stability _____	_____
<hr/>	
Transmitter spurious (worst case)	
Field strength <u>97.7</u> $\mu\text{V/m}$ (QP 39.8 dB $\mu\text{V/m}$) at a distance of <u>3</u> metres	<u>52</u>
Frequency <u>189MHz (Horizontal)</u>	_____
<hr/>	
Momentary operation? G Yes G <input checked="" type="radio"/> No	_____
Holdover time after manual release : _____ seconds	_____
or	
Duration of transmission after automatic activation : _____ seconds	_____
<hr/>	
Transmitter/receiver AC wireline conducted emissions (worst case)	
Transmitter : RF level <u>41.7</u> microvolts, frequency <u>24.4MHz</u>	<u>47</u>
Receiver : RF level <u>22.1</u> microvolts, frequency <u>509.8kHz</u>	<u>48</u>
<hr/>	
Receiver spurious (worst case)	
Field strength <u>82</u> $\mu\text{V/m}$ (QP 38.3 dB $\mu\text{V/m}$) at a distance of <u>3</u> metres	<u>53</u>
RF power _____ nanowatts	_____
Frequency <u>187MHz (Horizontal)</u>	_____

Attestation :

The radio device identified in this application has been subject to all the applicable test conditions specified in RSS-210 and all of the requirements of the Standard have been met.

except as noted, _____ pages attached.

EMC Engineer
Title

Takeshi Asano
Name (print)



Signature

January/ 29/ 2002
Date

- Index -

A. GENERAL INFORMATION..... 4

A.1 TEST METHODOLOGY..... 4

A.2 TEST FACILITY / NVLAP ACCREDITATION 4

A.3 EUT DETAILS..... 4

B. SUMMARY OF TEST RESULTS..... 5

C. OPERATION MODE OF EUT..... 6

D. TEST INSTRUMENTS..... 7

E. MEASUREMENT UNCERTAINTY..... 8

1. CARRIER FREQUENCY SEPARATION..... 9

1.1 TEST PROCEDURE..... 9

1.2 TEST INSTRUMENTS AND MEASUREMENT SETUP..... 9

1.3 MEASUREMENT RESULTS..... 9

1.4 TRACE DATA..... 10

2. NUMBER OF HOPPING FREQUENCIES..... 11

2.1 TEST PROCEDURE..... 11

2.2 TEST INSTRUMENTS AND MEASUREMENT SETUP..... 11

2.3 MEASUREMENT RESULTS..... 11

2.4 TRACE DATA..... 12

3. 20 DB BANDWIDTH..... 16

3.1 TEST PROCEDURE..... 16

3.2 TEST INSTRUMENTS AND MEASUREMENT SETUP..... 16

3.3 MEASUREMENT RESULTS..... 16

3.4 TRACE DATA..... 17

4. TIME OF OCCUPANCY (DWELL TIME) 22

4.1 TEST PROCEDURE..... 22

4.2 TEST INSTRUMENTS AND MEASUREMENT SETUP..... 22

4.3 MEASUREMENT RESULTS..... 22

4.4 TRACE DATA.....23

5. PEAK OUTPUT POWER29

5.1 TEST PROCEDURE.....29

5.2 TEST INSTRUMENTS AND MEASUREMENT SETUP.....29

5.3 MEASUREMENT RESULTS.....29

5.4 TRACE DATA.....30

6. BAND-EDGE (AT 20 DB BLOW)35

6.1 TEST PROCEDURE.....35

6.2 TEST INSTRUMENTS AND MEASUREMENT SETUP.....35

6.3 MEASUREMENT RESULTS.....35

6.4 TRACE DATA.....36

7. OUT OF BAND EMISSIONS.....39

7.1 TEST PROCEDURE.....39

7.2 TEST INSTRUMENTS AND MEASUREMENT SETUP.....39

7.3 MEASUREMENT RESULTS.....39

7.4 TRACE DATA.....40

8. TRANSMITTER POWER SPECTRAL DENSITY43

8.1 TEST PROCEDURE.....43

8.2 TEST INSTRUMENTS AND MEASUREMENT SETUP.....43

8.3 MEASUREMENT RESULTS.....43

8.4 TRACE DATA.....44

9. AC WIRELINE CONDUCTED EMISSIONS (450 KHZ – 30 MHZ).....46

9.1 TEST PROCEDURE.....46

9.2 TEST INSTRUMENTS AND MEASUREMENT SETUP.....46

9.3 MEASUREMENT RESULTS.....47

10. RESTRICTED BANDS RADIATIONS (30 MHZ – 1 GHZ).....49

10.1 TEST PROCEDURE.....49

10.2 TEST INSTRUMENTS AND MEASUREMENT SETUP.....49

10.3 FIELD STRENGTH CALCULATION.....51

10.4 MEASUREMENT RESULTS.....52

11. RESTRICTED BANDS RADIATIONS (1 GHZ – 25 GHZ)

..... 54

11.1 TEST PROCEDURE	54
11.2 TEST INSTRUMENTS AND MEASUREMENT	54
11.3 FIELD STRENGTH CALCULATION	55
11.4 MEASUREMENT RESULTS	56

A. GENERAL INFORMATION

APPLICANT : IBM Japan Ltd.
 ADDRESS : 1623 – 14 Shimotsuruma, Yamato-shi, Kanagawa 242-8502 Japan
 Tel: +81-46-215-4779, Fax: +81-46-273-7420
 REGULATION : FCC Part 15 Subpart C
 Industry Canada RSS-210 (Issue No.4)
 MODEL NUMBER : 2366-52U (ThinkPad T30)
 FCC ID : ANOCORN1TASUHOP
 SERIAL NUMBER : ZZ-00163
 PHYSICAL CONDITION : Preproduction
 KIND OF EQUIPMENT : Personal computer with a built-in Bluetooth card
 TESTED DATE : January 7, 8, 9, 10 and 11, 2002
 TEST SITE : IBM Yamato semi-anechoic chamber #2

A.1 Test Methodology

Both conducted and radiated testing were performed according to the procedures in ANSI C63.4-1992. Radiated testing was performed at an antenna to EUT distance of 3 meters.

A.2 Test Facility / NVLAP Accreditation

The semi-anechoic chamber #2 used to correct the data are located in Yamato Laboratory, IBM Japan.

- This facility has been fully described in a report dated September 1998, submitted to the FCC office, and accepted in a letter, dated Nov. 2,1998(31040/SIT).
- This facility is accepted by **Industry Canada** in a letter dated March 19, 2001 as number **IC 349E**.
- IBM Yamato EMC Engineering is recognized under the National Voluntary Laboratory Accreditation Program for satisfactory compliance with Criteria established in Title 15, Part 285 Code of Federal Regulations.(NVLAP Lab code: 200198-0)

A.3 EUT details

Table A EUT details

Model and S/N	FCC ID	Description	Cable Description
ThinkPad T30 M/T 2366-52U (s/n ZZ-00163)	ANOCORN1TASUHOP	IBM Notebook PC CPU: Intel® Mobile Pentium® 4 1.7GHz	
P/N 02K6665	N/A	Universal AC adapter 72W	Unshielded power cord

B. SUMMARY OF TEST RESULTS

Table-B presents the list of the measurement items for Spread Spectrum, Direct Sequence devices under FCC Part 15 Subpart C and Industry Canada RSS-210.

The section numbers of upper portion are showing FCC number, and the other (lower) ones are for IC.

Table-B List of the measurements

Section(s)	Test Items		Condition	Result
	Transmit mode (TX):			
15.247(a)(1) 6.2.2(o)(a1)	Carrier Frequency Separation	min. 25 kHz	Conducted	Pass
	Number of Hopping Frequencies	at least 75 hops		Pass
15.247(a)(1) 6.2.2(o)(a3)	20 dB Bandwidth	max. 1 MHz		Pass
	Dwell Time	0.4 seconds within a 30 second period per any frequency		Pass
15.247(f) 6.2.2 (o)(c2)	Hybrid Dwell Time	0.4 seconds within a 12.8 second (32 hops × 0.4sec) period		Pass
15.247(b)(1) 6.2.2(o)(a3)	Peak output power	Shall not exceed 1.0 W.		Pass
15.247(c) 5.9.1 6.2.2 (o) (e1)	Band-edge (or Occupied BW for IC)	$2400 \text{ MHz} \leq \chi \leq 2483.5 \text{ MHz}$		Pass
	Out of Band Emissions (Bandwidth at 20 dB blow)	The radiated emission to any 100 kHz of outband shall be at least 20 dB below the highest inband spectral density.		Pass
15.247(f) 6.2.2 (o)(c2)	Processing Gain for Hybrid System	17 dB		Pass ^{*1}
	Transmitter power spectral density for Hybrid System	Shall not be greater than 8 dBm in any 3 kHz band.		Pass
15.207 6.6	AC Wireline Conducted emissions 450 kHz – 30 MHz	Class B: 250 μV		Pass
15.205 / 209 6.2.1 / 6.3	General Field Strength Limits (Restricted Bands and Radiated Emission Limits)	Shall not exceed the limits specified in FCC 15.209, or RSS-210, Table 3.	Radiated (30M -1GHz)	Pass
			Radiated (1G -25GHz)	Pass
	Receive mode (RX):			
15.207 7.4	AC Wireline Conducted Emissions 450 kHz – 30 MHz	Class B: 250 μV	Conducted	Pass
15.209 7.3	General Field Strength Limits (Radiated Emission Limits)	Shall not exceed the limits specified in FCC 15.209, or RSS-210, Table 3.	Radiated (30M -1GHz)	Pass
			Radiated (1G -25GHz)	Pass

*1: See TDK Systems Europe Ltd. report.

C. OPERATION MODE OF EUT

All tests were performed using the “BlueTest version 1.4” and “BlueChat version 2.2”.

Hopping channels

The applying wireless card is designed to the Bluetooth Standard. The lowest hopping frequency is 2402MHz, and the highest one 2480MHz. Total 79 hopping channels are used with each 1MHz of channel spacing.

Ch.	Operation Frequency [GHz]	Ch.	Operation Frequency [GHz]	Ch.	Operation Frequency [GHz]	Ch.	Operation Frequency [GHz]
1	2.402	21	2.422	41	2.442	61	2.462
2	2.403	22	2.423	42	2.443	62	2.463
3	2.404	23	2.424	43	2.444	63	2.464
4	2.405	24	2.425	44	2.445	64	2.465
5	2.406	25	2.426	45	2.446	65	2.466
6	2.407	26	2.427	46	2.447	66	2.467
7	2.408	27	2.428	47	2.448	67	2.468
8	2.409	28	2.429	48	2.449	68	2.469
9	2.410	29	2.430	49	2.450	69	2.470
10	2.411	30	2.431	50	2.451	70	2.471
11	2.412	31	2.432	51	2.452	71	2.472
12	2.413	32	2.433	52	2.453	72	2.473
13	2.414	33	2.434	53	2.454	73	2.474
14	2.415	34	2.435	54	2.455	74	2.475
15	2.416	35	2.436	55	2.456	75	2.476
16	2.417	36	2.437	56	2.457	76	2.477
17	2.418	37	2.438	57	2.458	77	2.478
18	2.419	38	2.439	58	2.459	78	2.479
19	2.420	39	2.440	59	2.460	79	2.480
20	2.421	40	2.441	60	2.461		

Test Frequencies (Section 15.31m)

In line with the Section 15.31(m) of Public Notice DA 00-705 dated March/30/2000, some measurements are performed at the highest, middle, and lowest available channels with the hopping function disabled. (i.e. at **2402MHz, 2441MHz and 2480MHz**)

Unless otherwise specified the above condition, the test was performed while EUT had its hopping function enabled.

D. TEST INSTRUMENTS

Table-D List of Measuring Instruments

Description	Model	Serial Number	Calibration Date	Calibration Interval
Computer	IBM 5551-L	#4	N/A	N/A
Computer	IBM 6589-13J	97-15613	N/A	N/A
Spectrum Analyzer (100Hz-1.5GHz)	HP 85680B	2732A03651	01/16/01	1 year
Spectrum Analyzer (100Hz-1.5GHz)	HP 85680B	3019A05155	02/07/01	1 year
Spectrum Analyzer (100Hz-1.5GHz)	HP 85680B	3019A05156	04/02/01	1 year
Spectrum Analyzer Display	HP 85662A	2648A15255	01/16/01	1 year
Spectrum Analyzer Display	HP 85662A	3026A19353	02/07/01	1 year
Spectrum Analyzer Display	HP 85662A	3026A19366	04/02/01	1 year
Quasi-Peak Adapter	HP 85650A	2521A00968	01/16/01	1 year
Quasi-Peak Adapter	HP 85650A	3033A01449	02/07/01	1 year
Quasi-Peak Adapter	HP 85650A	2811A01433	04/02/01	1 year
Amplifier (100KHz - 1.3GHz) - for 30-200MHz - for 200-1000MHz	HP 8447D HP 8447D	2805A02919 2944A03506	04/16/01 04/16/01	1 year 1 year
Amplifier (1GHz - 26.5GHz)	HP 8449B	3008A00582	05/23/01	1 year
Spectrum Analyzer EMI Test Receiver	R&S ESI26	836119/003	07/04/01	1 year
Receiver (9kHz-30MHz)	R&S ESH3	891806/012	09/01/01	1 year
Receiver (20MHz-1.3GHz)	R&S ESVP	893202/018	01/29/01	1 year
Biconical Antenna (30-200MHz)	EMCO 3108	2241	05/11/01	1 year
Log-Periodic Antenna (200-1000MHz)	EMCO 3146	1584	05/10/01	1 year
Horn Antenna (1- 18GHz)	EMCO 3115	9903-5774	04/23/01	1 year
Horn Antenna (3.95- 5.85GHz)	EMCO 3160-5	1099	04/26/01	1 year
Horn Antenna (5.85- 8.20GHz)	EMCO 3160-6	9712-1044	04/26/01	1 year
Horn Antenna (18- 26.5GHz)	EMCO 3160-9	0004-1202	05/01/01	1 year
LISN	EMCO 3825/2	1426	09/01/01	1 year
Power Meter	HP 436A	2604A24192	09/06/01	1 year
Power Sensor	HP 8482A	2607A10987	09/07/01	1 year
Switch/control unit	HP 3488A	2719A17226 2719A17228	N/A N/A	N/A N/A
Plotter	HP 7550A	2631A33619	N/A	N/A
SF106 cables: - Horn Ant <=> RF Amp. - RF Amp.<=>Spectrum Analyzer	Length: 6 m 15m	- EM206SCO - EM215SCO	08/07/01 08/07/01	1 year 1 year
N-Coax cables: - Bi-coni Ant <=> 10m Cable - 10m Cable <=> Shield Panel - Shield Panel <=> RF Amp - RF Amp <=> Power Splitter - Log-peri Ant <=> 10m Cable	9 m 10 m 7 m 0.5m 9 m	- EM203L01 - EM203L02 - EM203L03 - EM203L04 - EM203H01	04/16/01 04/16/01 04/16/01 04/16/01 04/16/01	1 year 1 year 1 year 1 year 1 year

- 10m Cable <=> Shield Panel	10 m	- EM203H02	04/16/01	1 year
- Shield Panel <=> RF Amp	7 m	- EM203H03	04/16/01	1 year
- RF Amp <=> Power Splitter	0.5m	- EM203H04	04/16/01	1 year
Coax cables:				
- Lisn-L <=> SW/Con.unit (SW100)	4 m	- EMIC-L	04/16/01	1 year
- Lisn-N <=> SW/Con.unit (SW101)	4 m	- EMIC-N	04/16/01	1 year
- SW/Con.unit <=> RCVR (Input)	1 m	- EMIC-R	04/16/01	1 year
- SW/Con.unit<=> Spe Ana.(Signal In)	1 m	- EMIC-S	04/16/01	1 year
- Power Splitter <=> SW/Con.unit (SW110)	1 m	- EM203L05	04/16/01	1 year
- Power Splitter <=> SW/Con.unit (SW300)	1 m	- EM203L06	04/16/01	1 year
- Power Splitter <=> SW/Con.unit (SW100)	1 m	- EM203H05	04/16/01	1 year
- Power Splitter <=> SW/Con.unit (SW301)	1 m	- EM203H06	04/16/01	1 year
- SW/Con.unit <=> Receiver (Input)	2 m	- EM2RCV	04/16/01	1 year
- SW/Con.unit <=> Spe Ana.(Signal In) for 30- 200MHz	2 m	- EM2SPL	04/16/01	1 year
- SW/Con.unit <=> Spe Ana.(Signal In) for 200-1000MHz	2 m	- EM2SPH	04/16/01	1 year

Notes.

- The above equipment calibration is traceable to National standards.
- HP: Hewlett Packard, R&S: Rohde & Schwarz

E. MEASUREMENT UNCERTAINTY

Uncertainties of the both, the Yamato EMI radiated test facilities (EMI chambers, #1 and #2) and the Yamato EMI conducted test facility are derived with the NIS 81 " Treatment of uncertainty in EMC measurements" 1994.

Estimated site uncertainty values are as follows.

- EMI chamber #1 : 4.17dB
- EMI chamber #2 : 4.18dB
- EMI conducted measurement system : 2.4dB

Detail should be referred to "Treatment of Uncertainty, Calculations and Policy" report, document number TCR 10-0015.

1. Carrier Frequency Separation

1.1 Test Procedure

- The carrier frequency separation was measured with a spectrum analyzer connected to the antenna terminal, while EUT had its hopping function enabled.
- The spectrum analyzer was set to :
 - Span = 3 MHz (wide enough to capture the peaks of two adjacent channels),
 - Resolution Bandwidth (RBW) = 30 kHz (1% of the span or more),
 - Video Bandwidth (VBW) = 30 kHz (= RBW or more), Sweep = auto,
 - Detector function = peak, Trace = max hold
- After the trace being stable, the reading value between the peaks of the adjacent channels using the marker-delta function was recorded as the measurement results.

1.2 Test Instruments and Measurement Setup

Table 1-1 : Test Instruments

Description	Model	Serial Number
Spectrum Analyzer EMI Test Receiver	R&S ESI26	836119/003
Coax cables: - Spectrum Analyzer <=> EUT	Length: 120 cm Loss: 1.7 dB	

Notes: - R&S : Rohde & Schwarz

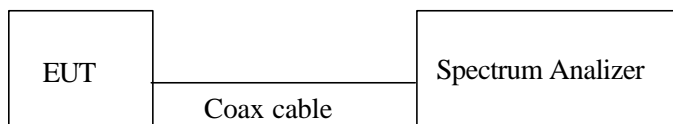

Figure 1: Measurement setup for the carrier frequency separation

1.3 Measurement Results

Test Date: January 9, 2002

Table 1-2. EUT: M/T 2366-52U, s/n ZZ-00163, TX hopping mode

Frequency of marker #1 (MHz)	Frequency of marker #2 (MHz)	Carrier Frequency Separation (MHz)	Note
2440.00	2441.00	1.00	Min. 25 kHz

1.4 Trace Data



Marker 1 [T1]	RBW	30 kHz	RF Att	40 dB
Ref Lvl	0.54 dBm	VBW	30 kHz	
25 dBm	2.44100301 GHz	SWT	8.5 ms	Unit dBm

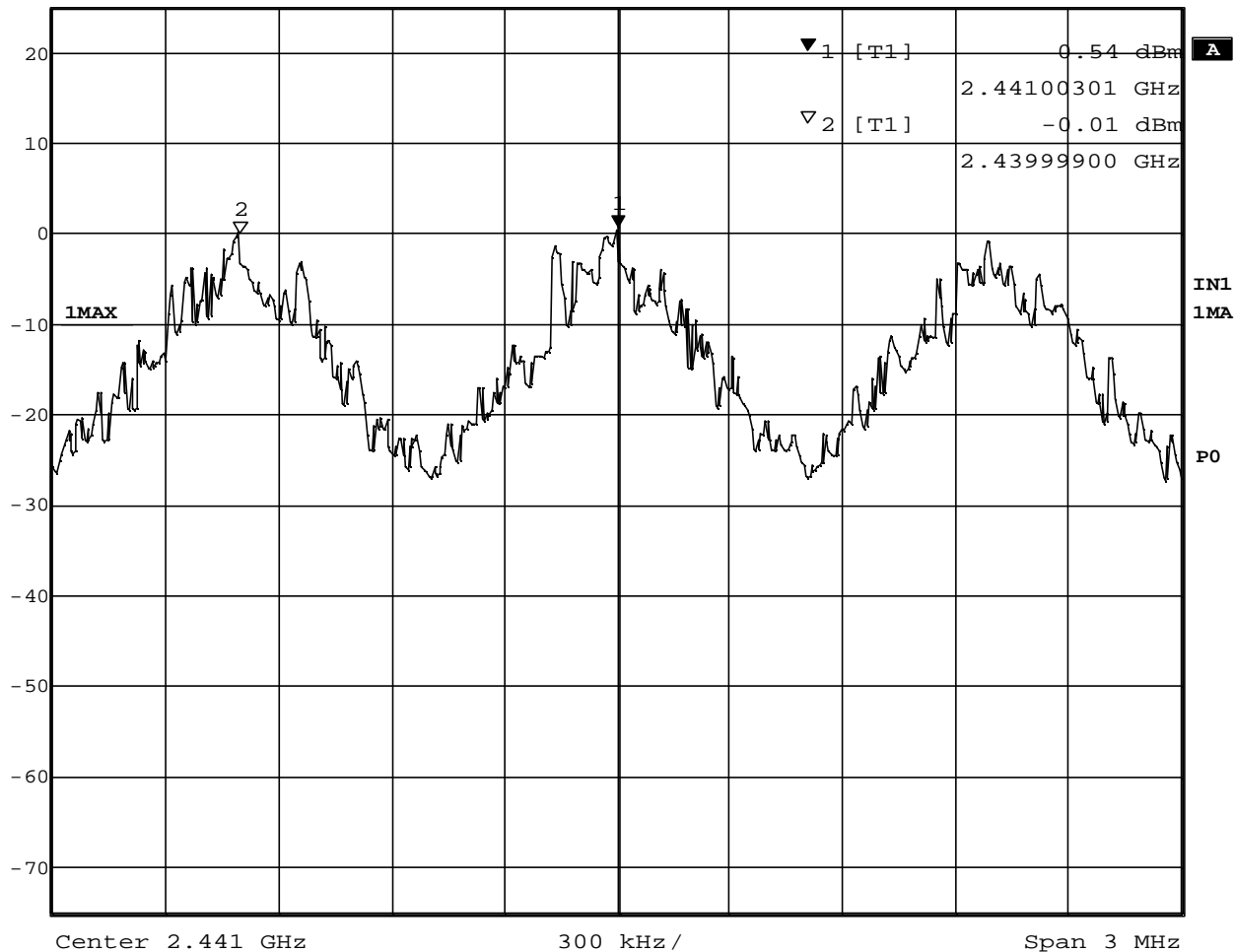

Date: 9. JAN. 2002 12:35:32

Carrier Frequency Separation

2. Number of Hopping Frequencies

2.1 Test Procedure

- The number of hopping frequencies was measured with a spectrum analyzer connected to the antenna terminal, while EUT had its hopping function enabled.
 - To get higher resolution, four frequency ranges within the 2400 - 2483.5 MHz FH band were examined.
 - The spectrum analyzer was set to :
 - Frequency range 1: Start = 2389.5 MHz, Stop = 2414.5 MHz
 - 2: Start = 2414.5 MHz, Stop = 2439.5 MHz
 - 3: Start = 2439.5 MHz, Stop = 2464.5 MHz
 - 4: Start = 2464.5 MHz, Stop = 2489.5 MHz
- RBW ≥ 1% of the span, VBW ≥ RBW, Sweep = auto, Detector function = peak,
Trace = max hold

2.2 Test Instruments and Measurement Setup

Same as the Chapter 1(Table 1-1 & Figure 1).

2.3 Measurement Results

Test Date: January 9, 2002

Table 2. EUT: M/T 2366-52U, s/n ZZ-00163, TX hopping mode

Total number of Hopping Channels	Note
79	Min. 75 hops

2.4 Trace Data

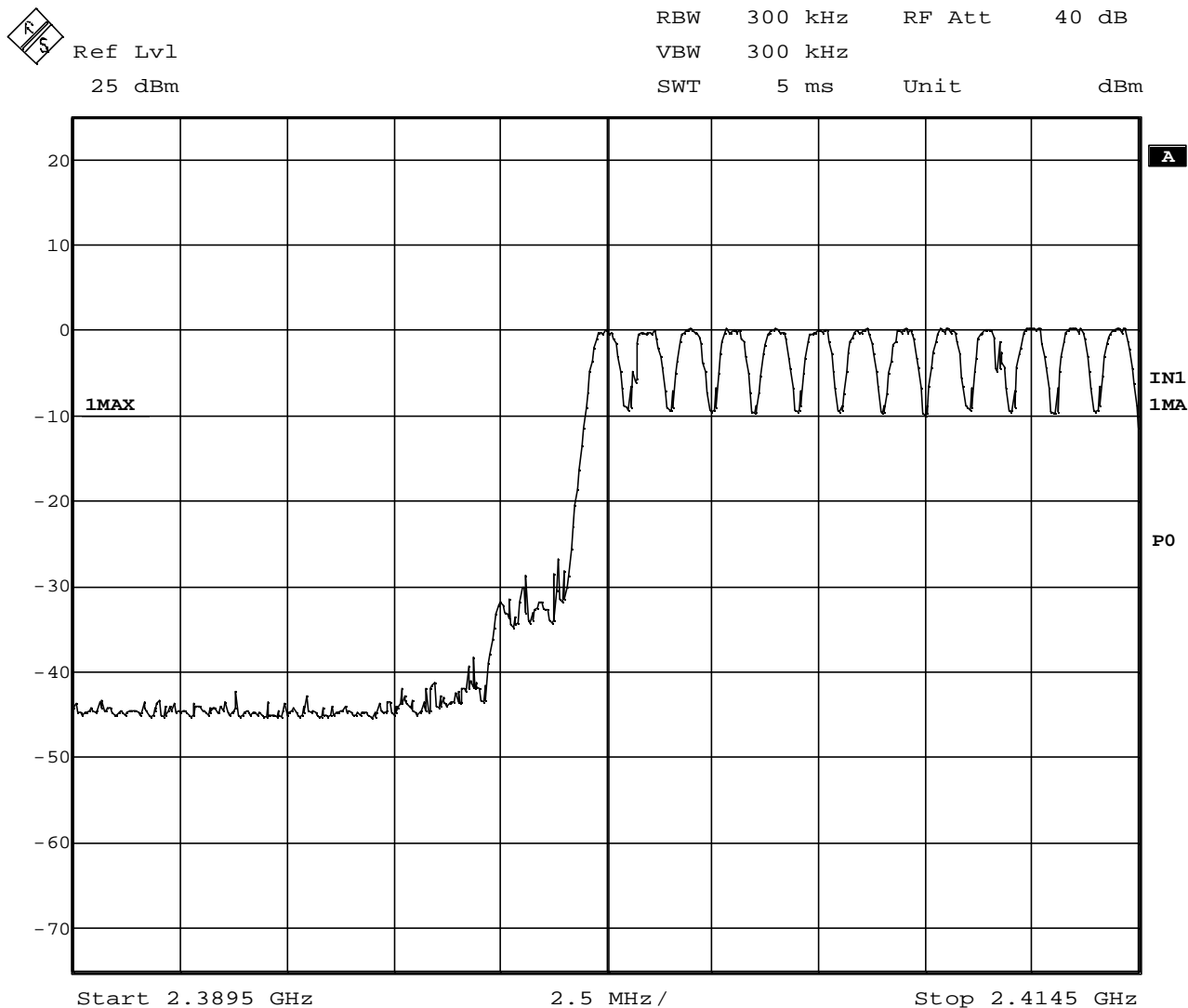

Date: 9.JAN.2002 12:37:49

Number of Hopping Frequencies (range 1)



Ref Lvl
25 dBm

RBW 300 kHz RF Att 40 dB
VBW 300 kHz
SWT 5 ms Unit dBm

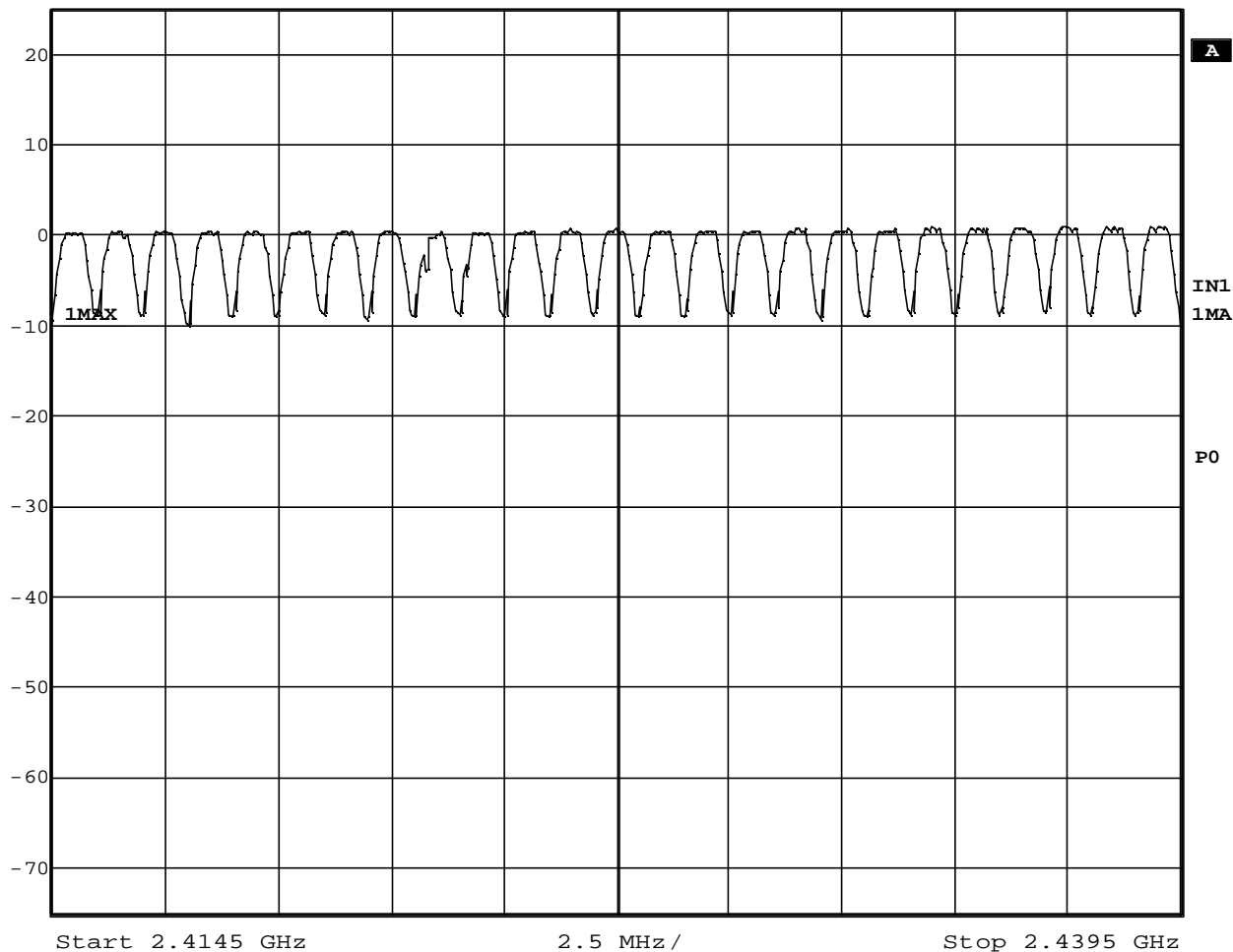

Date: 9.JAN.2002 12:39:35

Number of Hopping Frequencies (range 2)



Ref Lvl
25 dBm

RBW 300 kHz RF Att 40 dB
VBW 300 kHz
SWT 5 ms Unit dBm

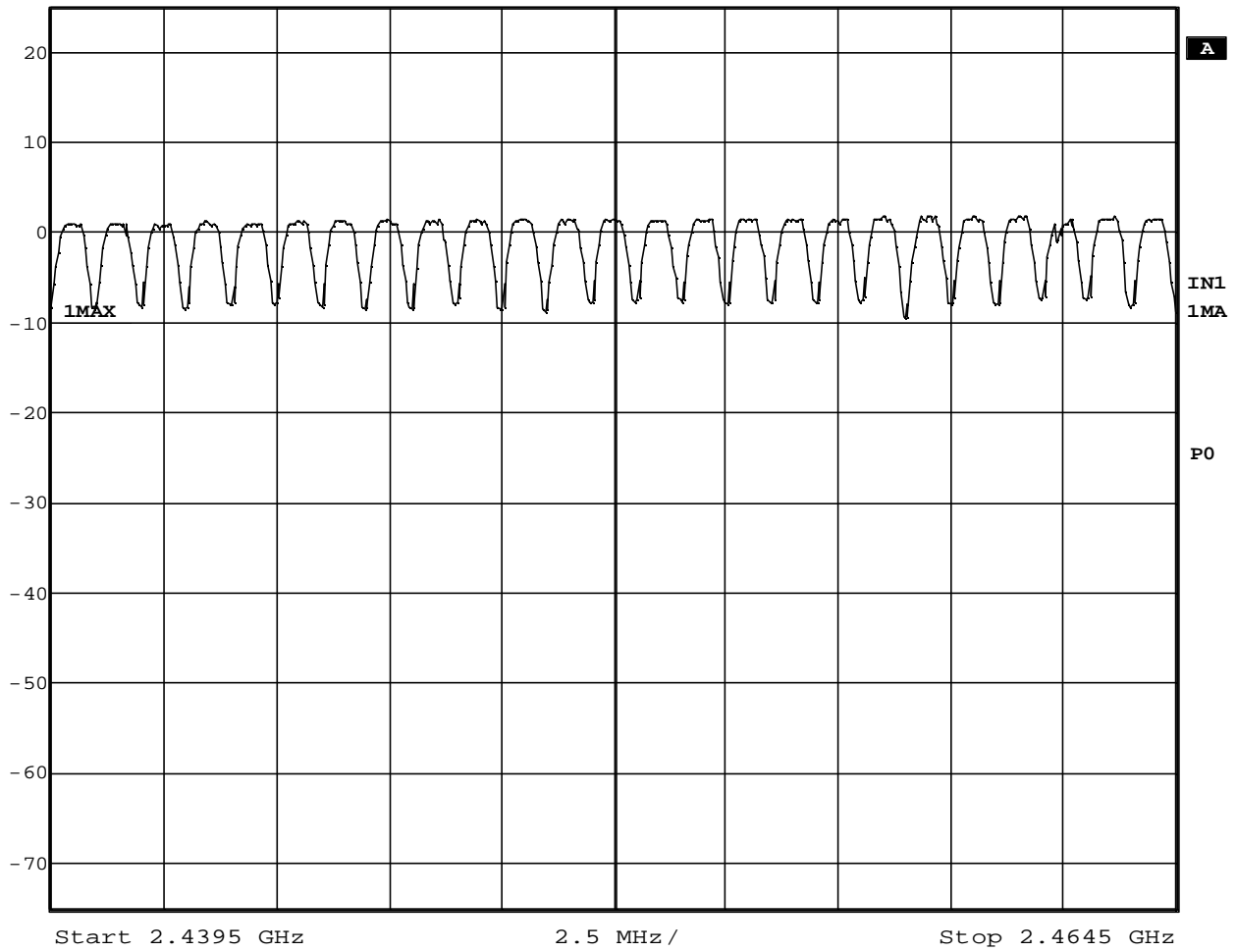

Date: 9.JAN.2002 12:41:35

Number of Hopping Frequencies (range 3)

3. 20 dB Bandwidth

3.1 Test Procedure

- The bandwidth at 20 dB below the highest inband spectral density was measured with a spectrum analyzer connected to the antenna terminal, while EUT had its hopping function disabled at the highest, middle and the lowest available channels.
- The spectrum analyzer was set to :
 - Center frequency = the highest, middle and the lowest channels,
 - Span : approximately 2 or 3 times of the 20 dB bandwidth = 2 MHz
 - RBW : 1% of the 20 dB bandwidth or more = 10 kHz
 - VBW : equal to RBW or more = 30 kHz
 - Sweep = auto, Detector function = peak, Trace = max hold
- After the trace being stable. Use the marker-to-peak function to set the marker to the peak of the emission. Use the marker-delta function to measure 20 dB down one side of the emission. Reset the marker-delta function, and move the marker to the other side of the emission, until it is (as close as possible to) even with the reference marker level. The marker-delta reading at this point is the 20 dB bandwidth of the emission.

3.2 Test Instruments and Measurement Setup

Same as the Chapter 1(Table 1-1 & Figure 1).

3.3 Measurement Results

Test Date: January 9, 2002

Table 3. EUT: M/T 2366-52U, s/n ZZ-00163

	Measured Bandwidth (MHz)	Limit
Tx at the lowest ch. (2402 MHz)*1	0.72	1 MHz
Tx at the middle ch.(2441 MHz)*1	0.73	
Tx at the highest ch.(2480 MHz)*1	0.73	
Inquiry	0.62	
Paging	0.61	

*1 : In line with Section 15.31(m) of Public Notice DA 00-705 dated March 30, 2000, the measurement was performed at the highest, middle and lowest available channels.

3.4 Trace Data

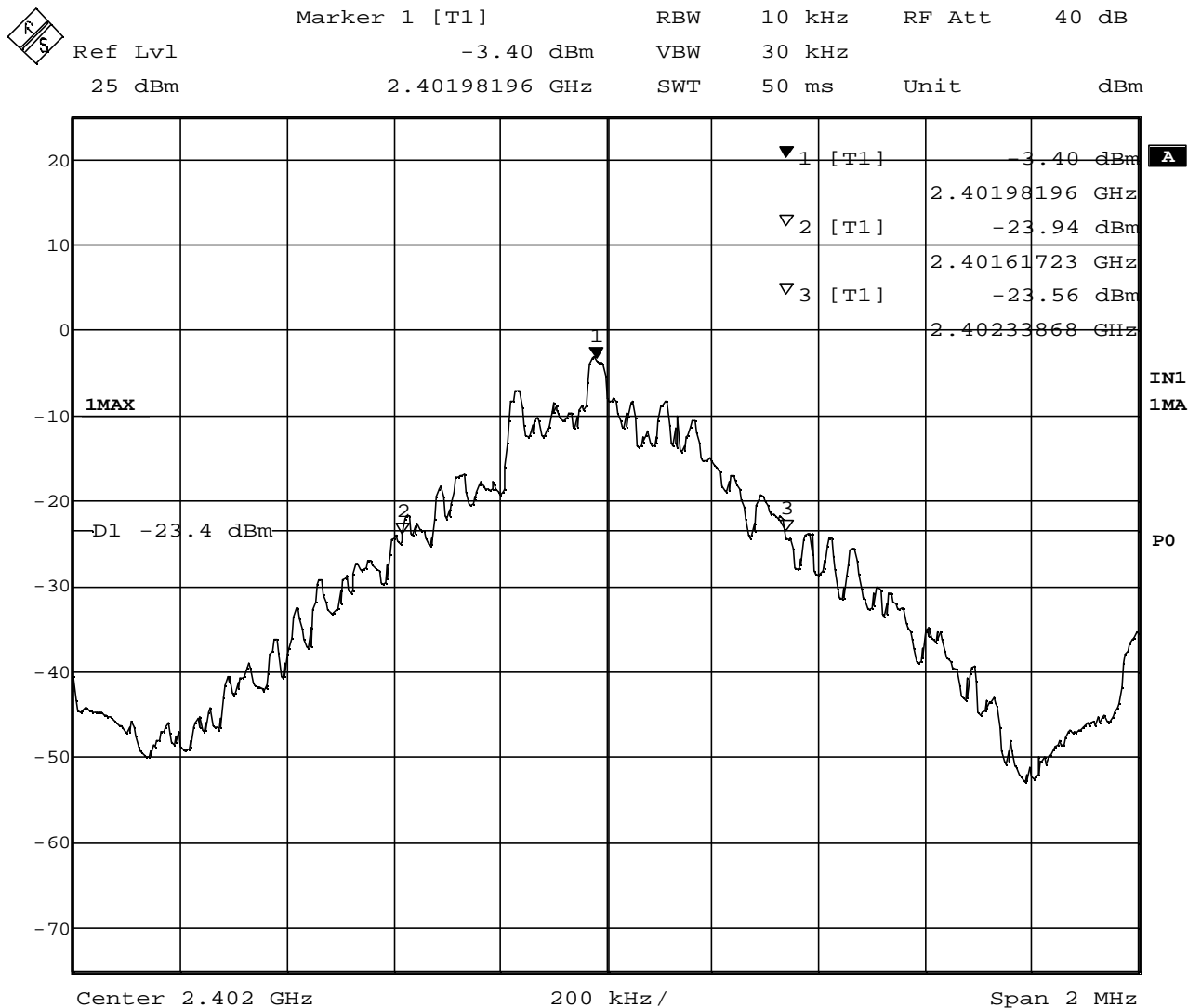

Date: 9.JAN.2002 12:46:44

20 dB Bandwidth (TX on 2402MHz)



Ref Lvl	Marker 1 [T1]	RBW	10 kHz	RF Att	40 dB
25 dBm	-2.23 dBm	VBW	30 kHz		
	2.44098196 GHz	SWT	50 ms	Unit	dBm

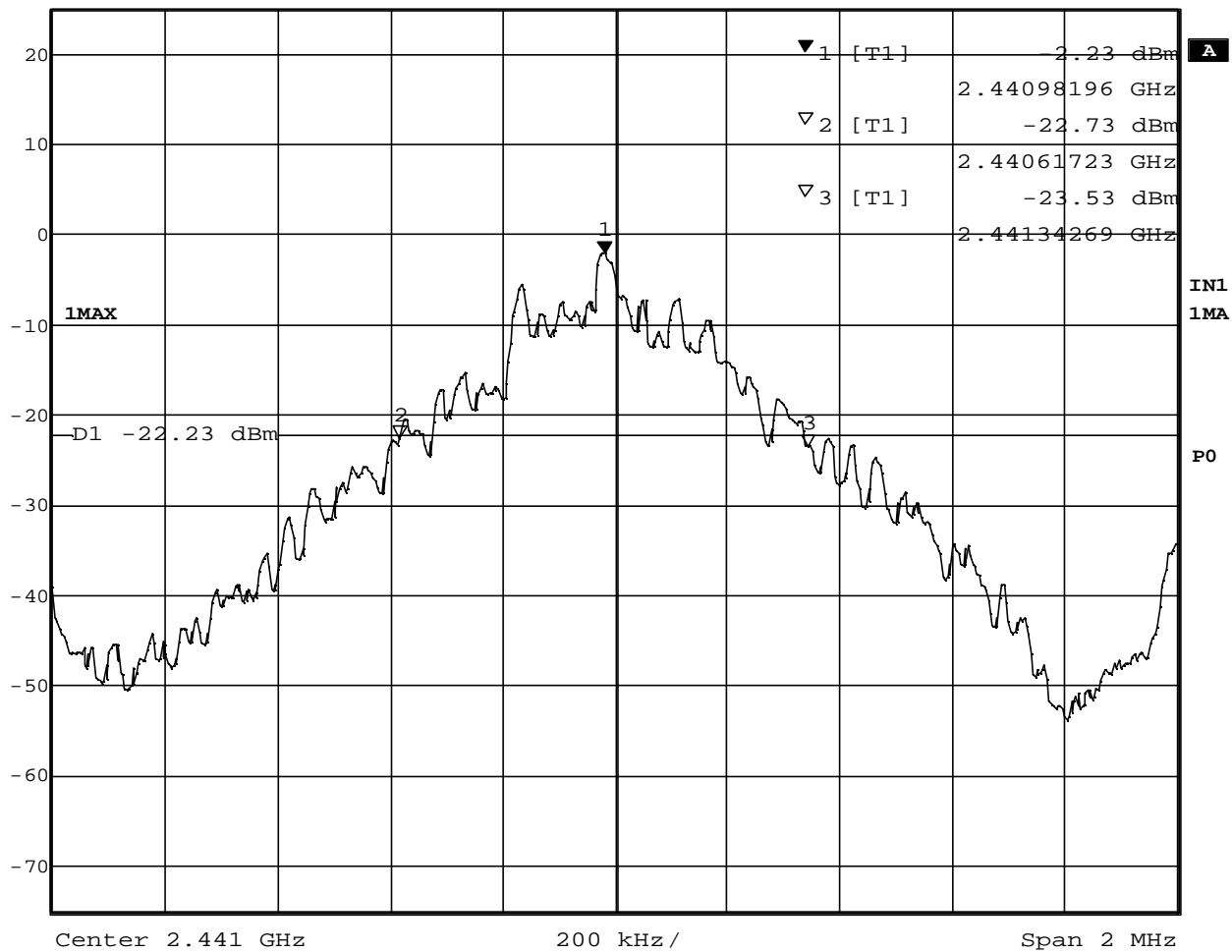

Date: 9. JAN. 2002 12:48:33

20 dB Bandwidth (TX on 2441MHz)



Ref Lvl	Marker 1 [T1]	RBW	10 kHz	RF Att	40 dB
25 dBm	-1.53 dBm	VBW	30 kHz		
	2.47998196 GHz	SWT	50 ms	Unit	dBm

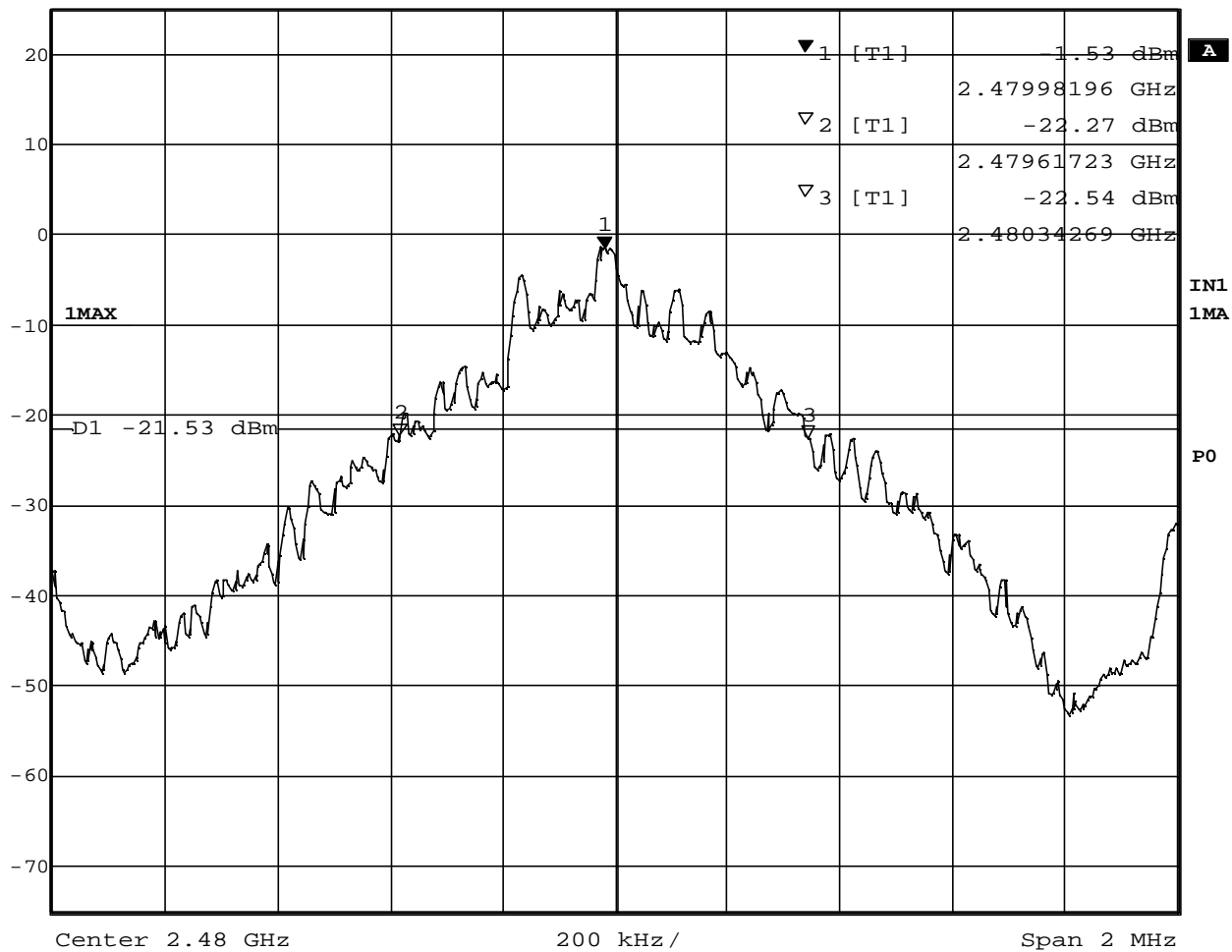

Date: 9.JAN.2002 12:50:01

20 dB Bandwidth (TX on 2480MHz)



Ref Lvl	Marker 1 [T1]	RBW	10 kHz	RF Att	40 dB
25 dBm	-6.15 dBm	VBW	30 kHz		
	2.44099800 GHz	SWT	50 ms	Unit	dBm

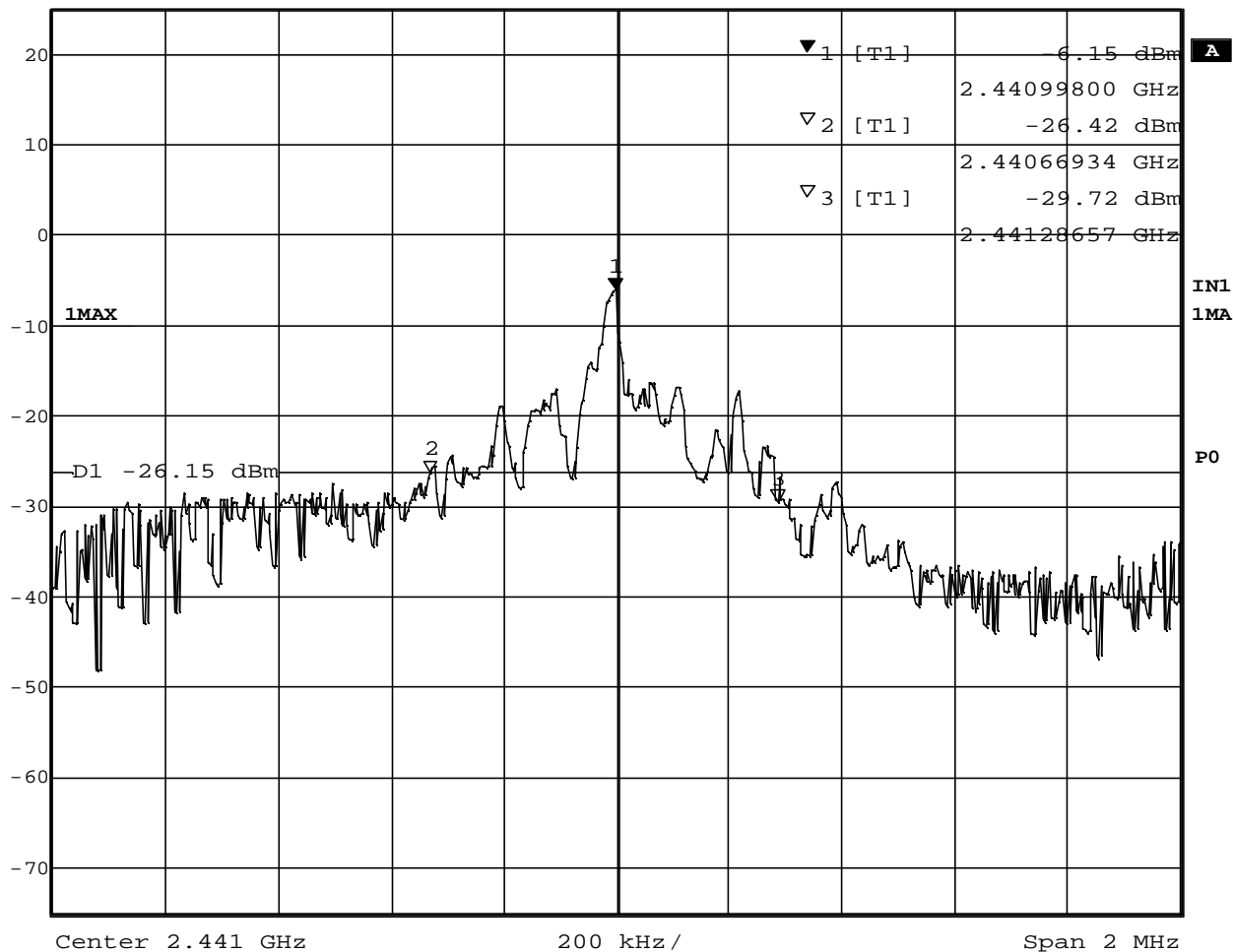

Date: 9.JAN.2002 12:54:11

20 dB Bandwidth (Inquiry)



	Marker 1 [T1]	RBW	10 kHz	RF Att	40 dB
Ref Lvl	-4.56 dBm	VBW	30 kHz		
25 dBm	2.44199399 GHz	SWT	50 ms	Unit	dBm

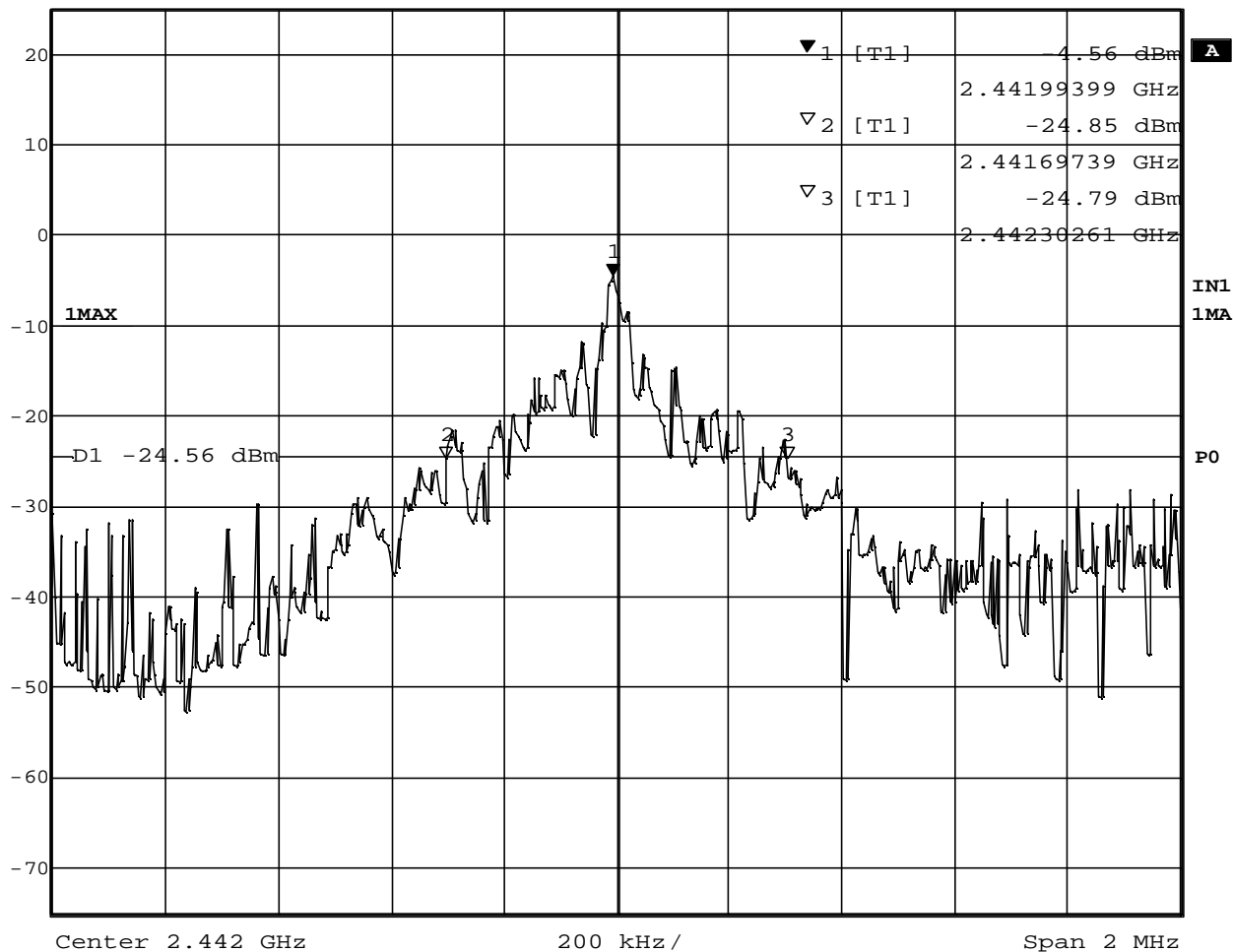

Date: 9.JAN.2002 20:16:05

20 dB Bandwidth (Paging)

4. Time of Occupancy (Dwell Time)

4.1 Test Procedure

- The dwell time was measured with a spectrum analyzer connected to the antenna terminal, while EUT had its hopping function enabled.
- The spectrum analyzer was set to :
 - Center Frequency: 2441MHz (for Inquiry / Data Transmission), 2442MHz (for Paging)
 - RBW = 500 kHz, VBW = 500 kHz (= RBW or more), Span = zero,
 - Detector function = peak, Trace = max hold,
 - Sweep : Inquiry ; 300 μ s for Burst duration, 100 ms for Repetition rate
 - Paging ; 300 μ s for Burst duration, 100 ms for Repetition rate
 - Data transmission ; 1 ms for Burst duration, 500 ms for Repetition rate

4.2 Test Instruments and Measurement Setup

Same as the Chapter 1(Table 1-1 & Figure 1).

4.3 Measurement Results

Test Date: January 10, 2002

Table 4. EUT: M/T 2366-52U, s/n ZZ-00163

Hopping phase	Burst duration in one hop (μ s) *1	Repetition rate on one channel *2	Dwell Time (mS) *1 \times *2	Limit
Inquiry	205.81	1280	263.4	less than 400 mS in 12.8* ³ seconds period
Paging	174.95	640	112.0	
Data transmission	492.99	300	147.9	less than 400 mS in 30 seconds period

*1 : attached measurement plot

*2 : - (number of hops in measurement plot) \times 12800 ms / 100 ms for Inquiry/Paging
 - (number of hops in measurement plot) \times 30000 ms / 500 ms for Data transmission

*3 : 32 hops (Bluetooth Standard) \times 0.4sec

4.4 Trace Data

	Marker 1 [T1]	RBW	500 kHz	RF Att	40 dB
	Ref Lvl	-46.03 dBm	VBW	500 kHz	
	25 dBm	23.847695 μ s	SWT	300 μ s	Unit

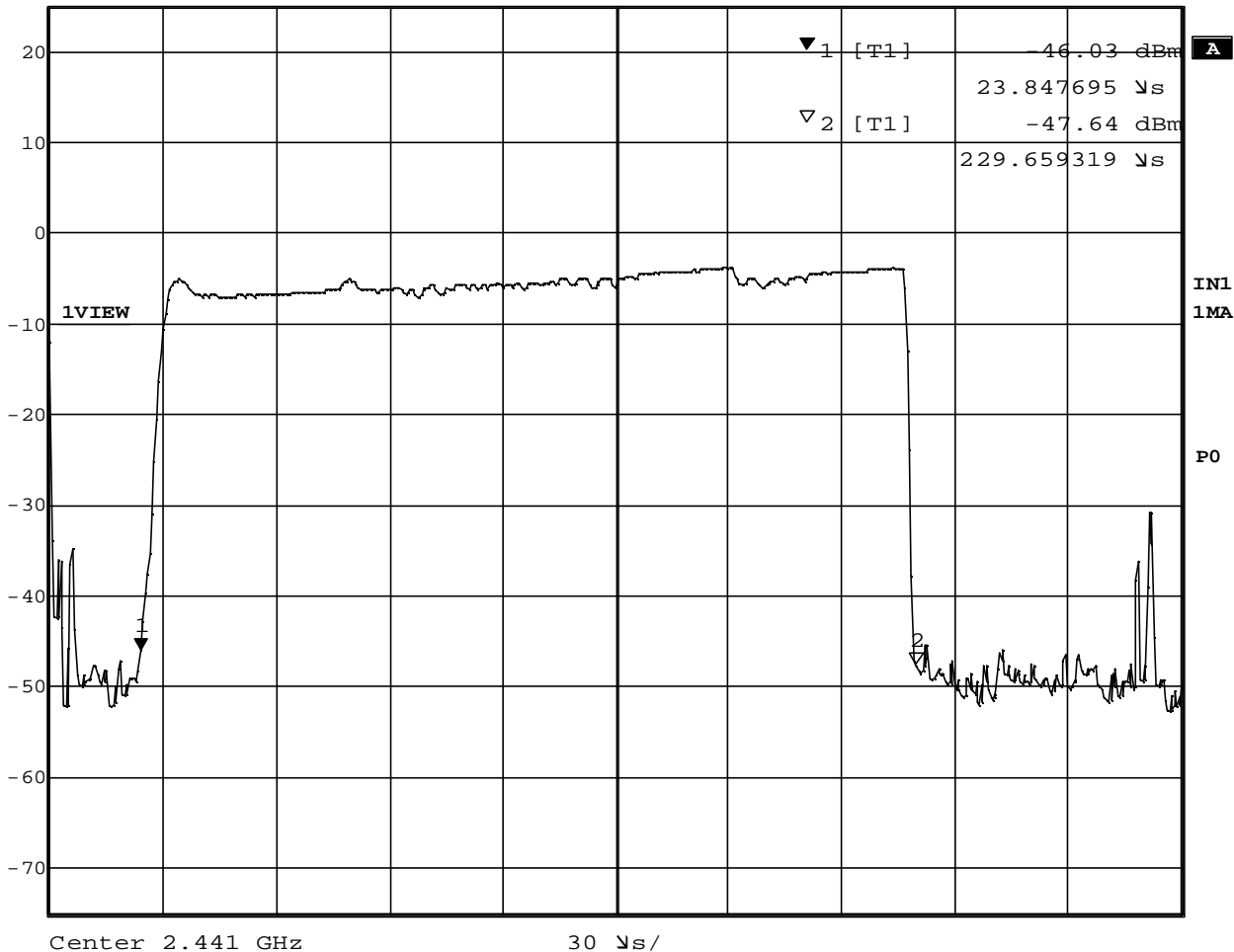

Date: 10.JAN.2002 08:29:30

Time of Occupancy (Inquiry, Burst duration)



Ref Lvl
25 dBm

RBW 500 kHz RF Att 40 dB
VBW 500 kHz
SWT 100 ms Unit dBm

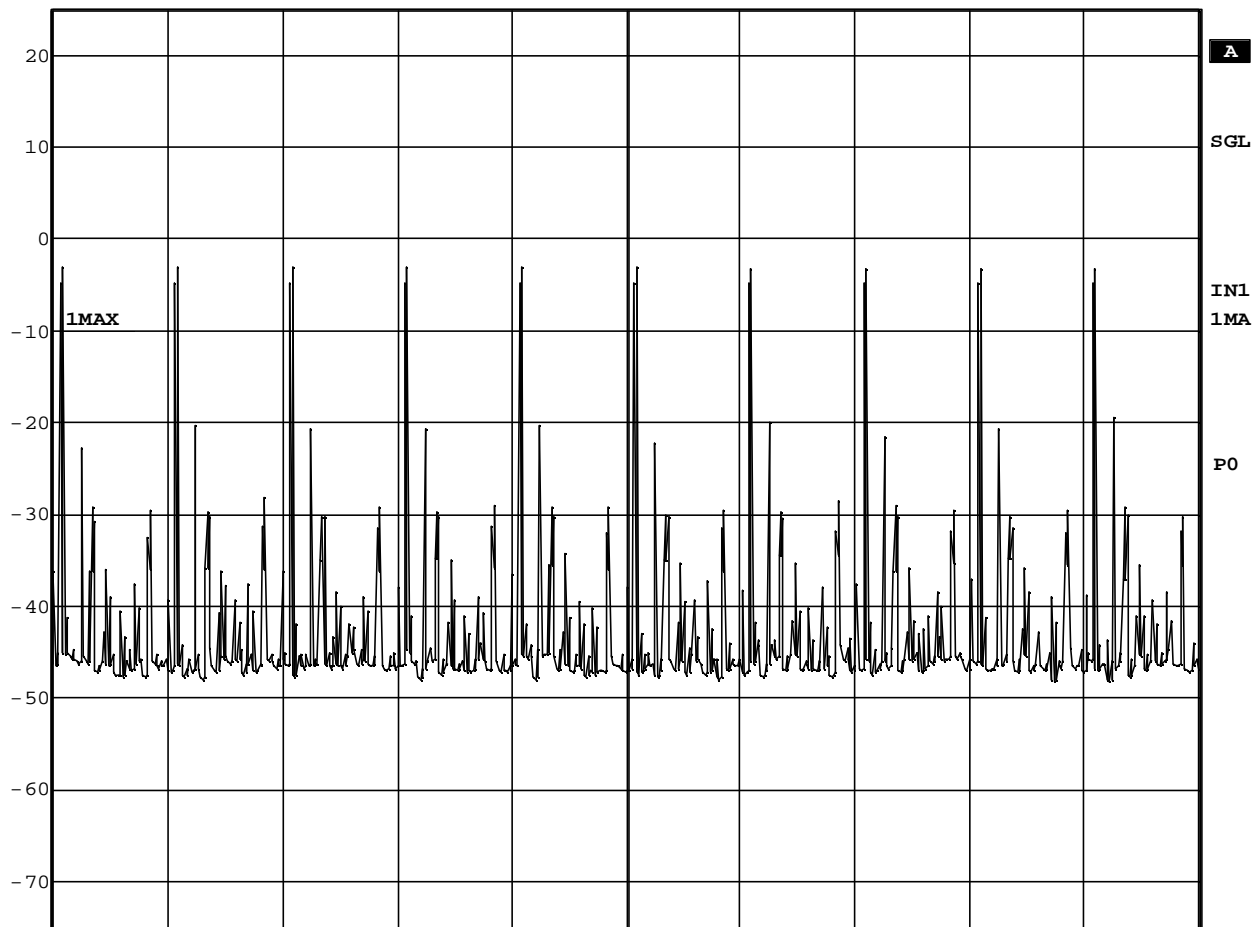

Center 2.441 GHz 10 ms/

Date: 10 . JAN . 2002 08 : 31 : 32

Time of Occupancy (Inquiry, Repetition rate)



	Marker 1 [T1]	RBW	500 kHz	RF Att	40 dB
Ref Lvl	-46.12 dBm	VBW	500 kHz		
25 dBm	104.609218 μ s	SWT	300 μ s	Unit	dBm

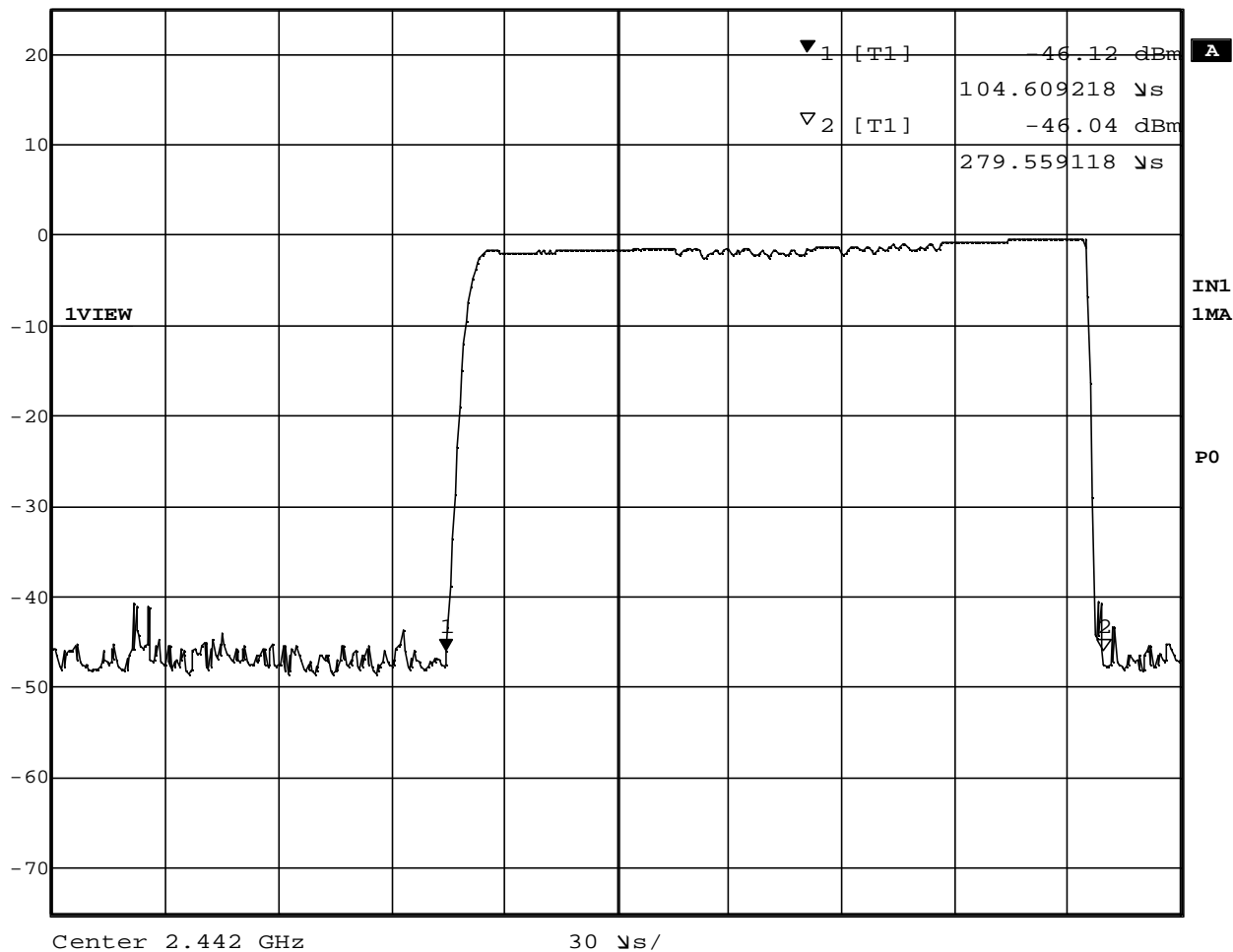

Date: 10.JAN.2002 08:33:53

Time of Occupancy (Paging, Burst duration)



Ref Lvl
25 dBm

RBW 500 kHz RF Att 40 dB
VBW 500 kHz
SWT 100 ms Unit dBm

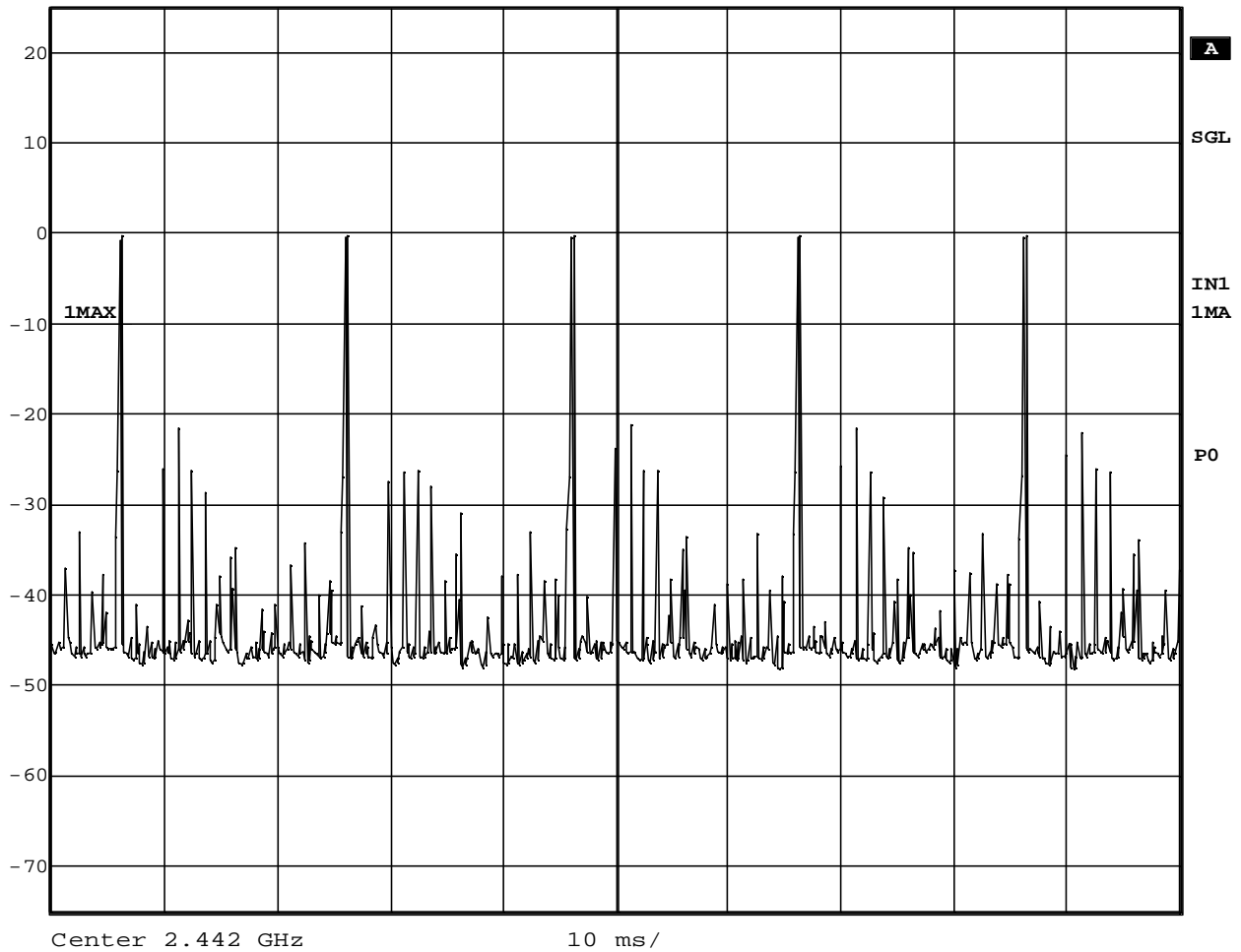

Date: 10 . JAN . 2002 08 : 35 : 26

Time of Occupancy (Paging, Repetition rate)



	Marker 1 [T1]	RBW	500 kHz	RF Att	40 dB
Ref Lvl	-45.61 dBm	VBW	500 kHz		
25 dBm	324.649299 μ s	SWT	1 ms	Unit	dBm

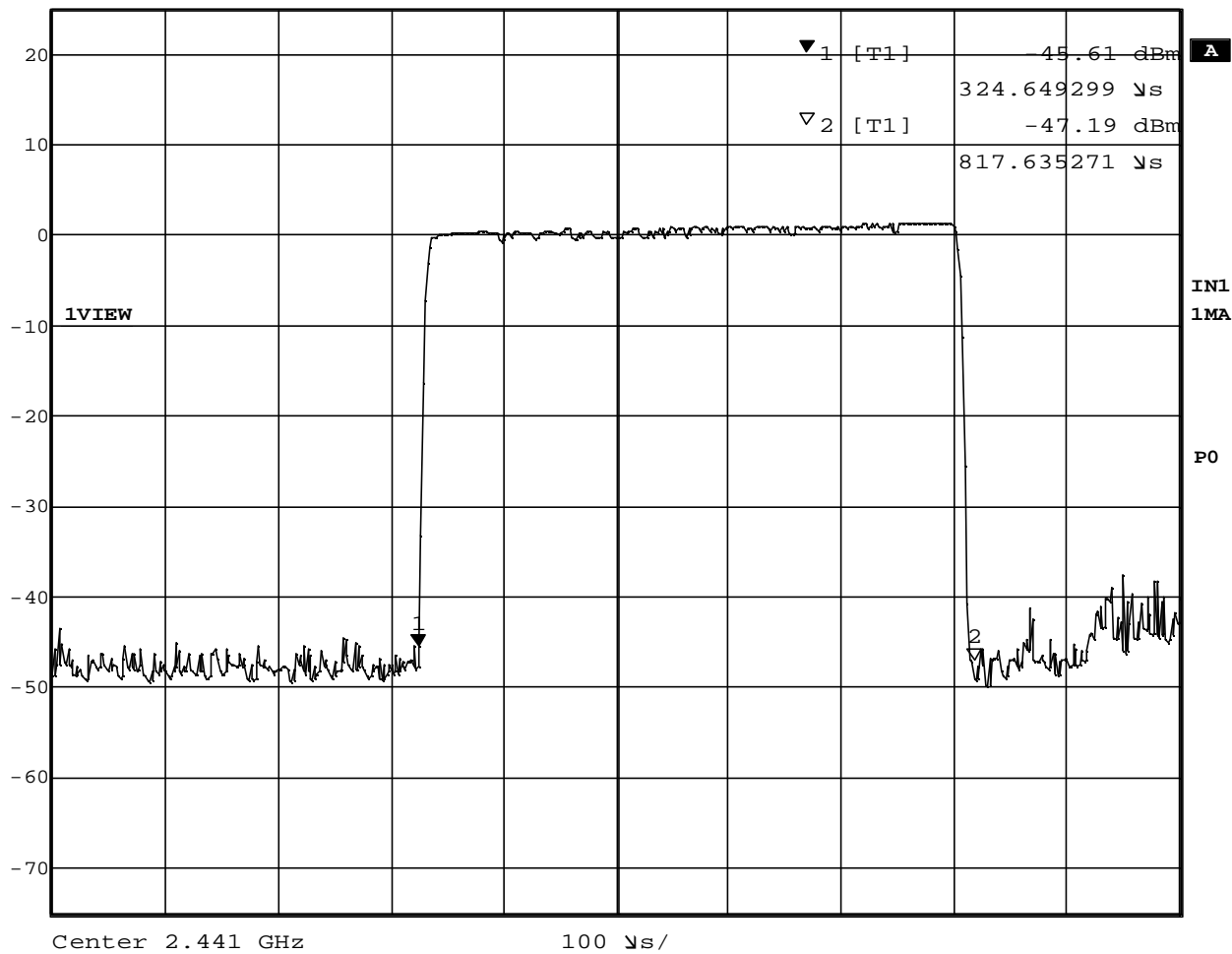

Date: 10.JAN.2002 08:57:52

Time of Occupancy (Data transmission, Burst duration)



Ref Lvl
25 dBm

RBW 500 kHz RF Att 40 dB
VBW 500 kHz
SWT 500 ms Unit dBm

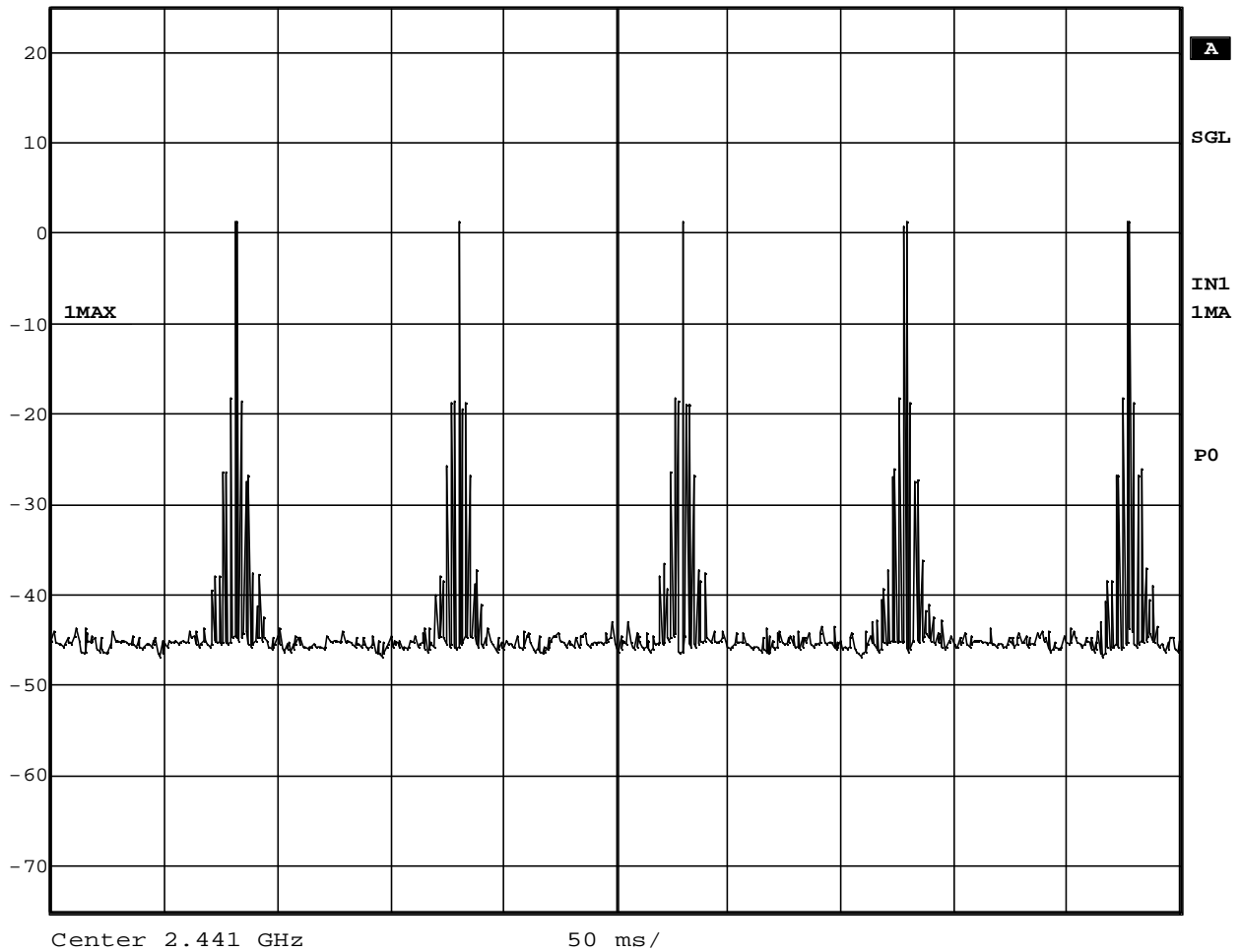

Date: 10.JAN.2002 08:59:00

Time of Occupancy (Data transmission, Repetition rate)

5. Peak Output Power

5.1 Test Procedure

- The peak output power is measured with a spectrum analyzer connected to the antenna terminal, while EUT had its hopping function disabled at the highest, middle and the lowest available channels.
- The spectrum analyzer is set to :
 - Center frequency = the highest, middle and the lowest channels,
 - Span : approximately 5 times of the 20 dB bandwidth = 5 MHz (3 MHz for Inquiry/Paging)
 - RBW : greater than the 20 dB bandwidth of the emission being measured = 1 MHz
 - VBW : equal to RBW or more = 3 MHz
 - Sweep = auto, Detector function = peak, Trace = max hold
- Allow the trace to stabilize. Use the marker-to-peak function to set the marker to the peak of the emission. The indicated level is the peak output power.

5.2 Test Instruments and Measurement Setup

Same as the Chapter 1(Table 1-1 & Figure 1).

5.3 Measurement Results

Test Date: January 9 and 10, 2002

Table 5. EUT: M/T 2366-52U, s/n ZZ-00163

Measured Frequency (MHz)	Analyzer Reading (dBm)	Cable Loss (dB)	Results		Limit [1W] (dBm)	Margin (dB)
			(dBm)	(W)		
2402 (ch. 1) *1	0.12	1.7	1.8	0.00152	30.0	28.2
2441 (ch. 40) *1	1.05	1.7	2.8	0.00188	30.0	27.2
2480 (ch. 79) *1	2.20	1.7	3.9	0.00245	30.0	26.1
Inquiry (ch. 40)	0.26	1.7	2.0	0.00157	30.0	28.0
Paging (ch. 41)	0.98	1.7	2.7	0.00185	30.0	27.3

*1 : In line with Section 15.31(m) of Public Notice DA 00-705 dated March 30, 2000, the measurement was performed at the highest, middle and lowest available channels.

5.4 Trace Data

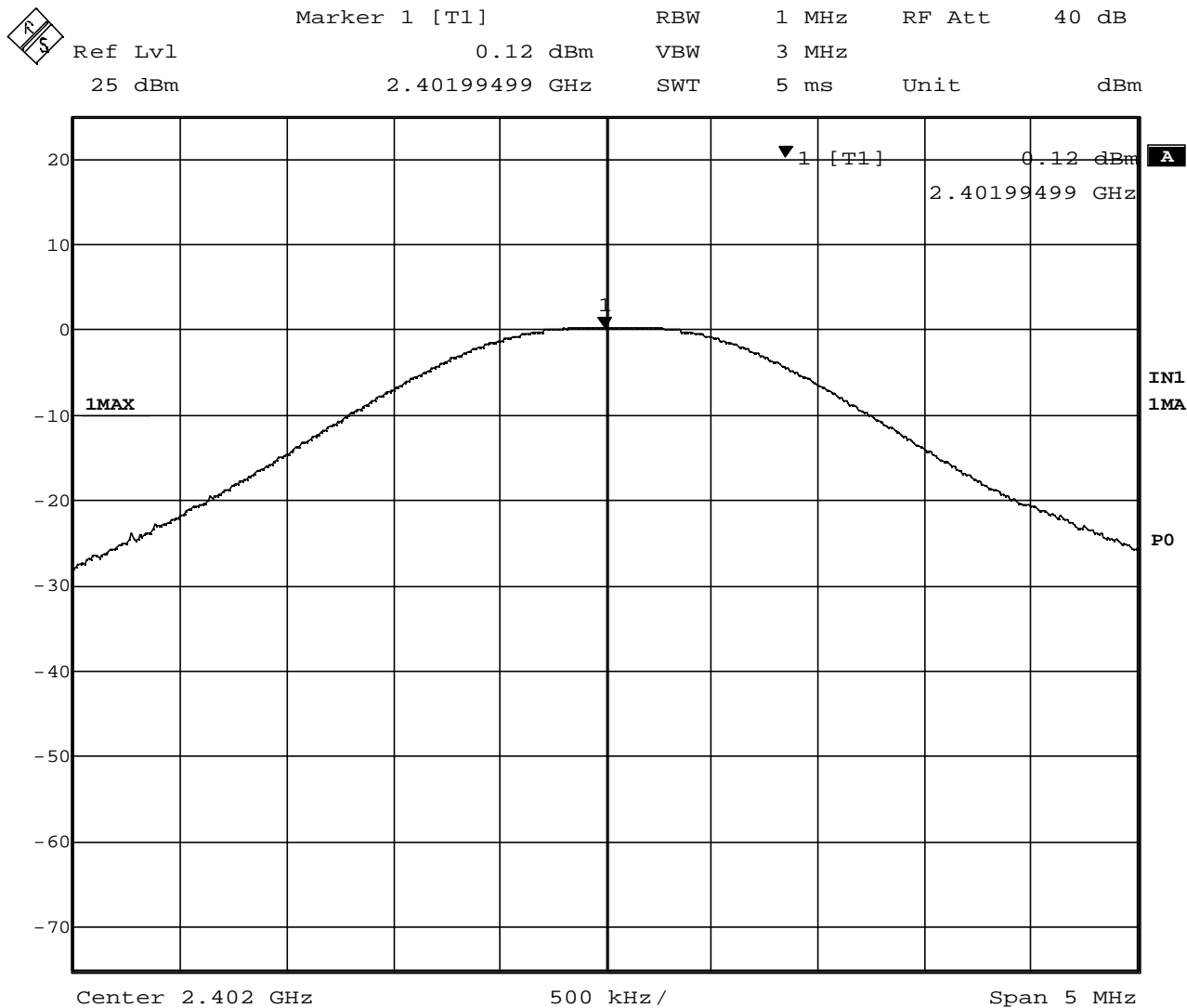

Date: 9.JAN.2002 12:06:18

Peak Output Power (TX on 2402MHz)



Ref Lvl	Marker 1 [T1]	RBW	1 MHz	RF Att	40 dB
25 dBm	1.05 dBm	VBW	3 MHz		
	2.44097495 GHz	SWT	5 ms	Unit	dBm

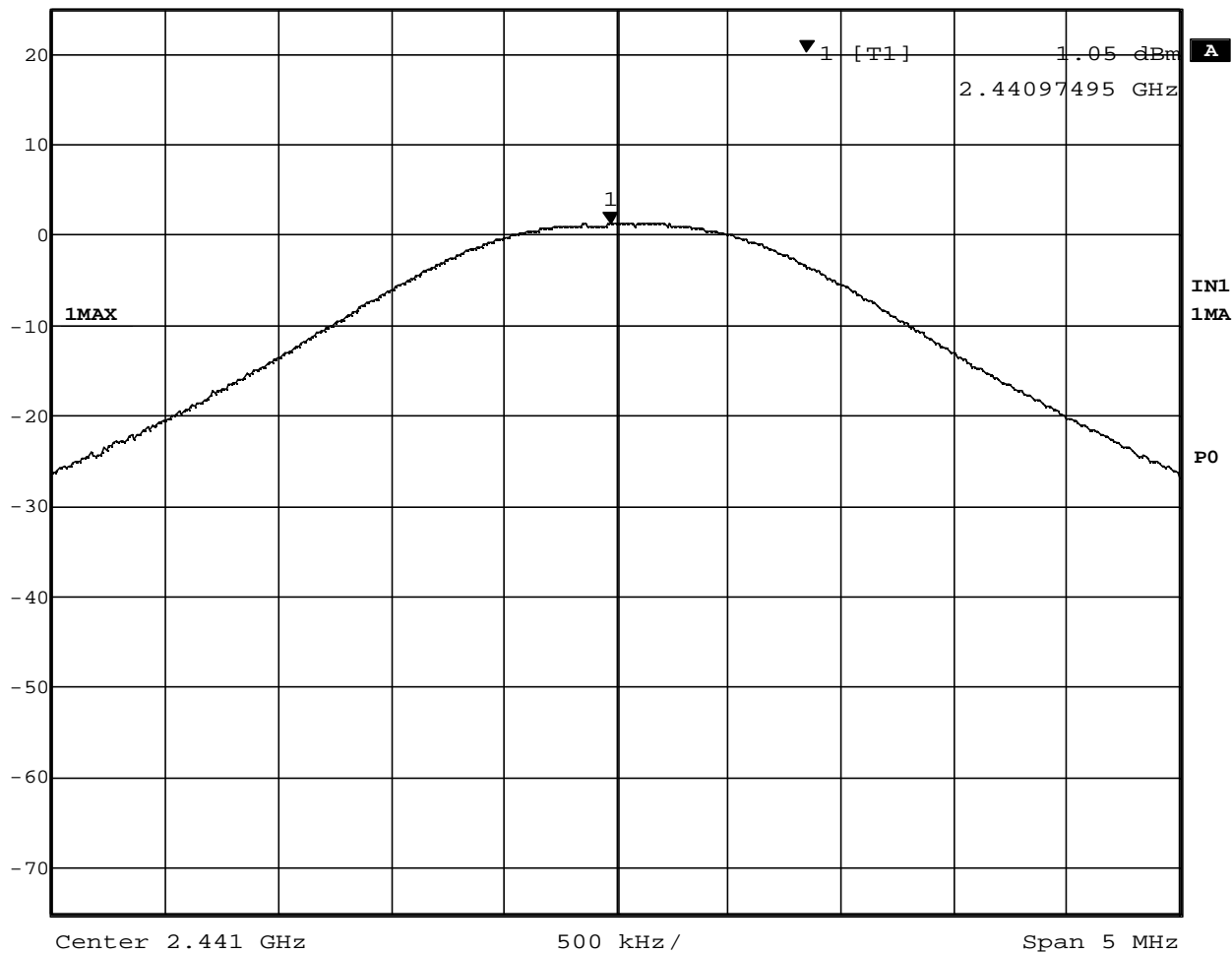

Date: 9.JAN.2002 12:07:03

Peak Output Power (TX on 2441MHz)



Ref Lvl	25 dBm	Marker 1 [T1]	2.20 dBm	RBW	1 MHz	RF Att	40 dB
			2.48000501 GHz	VBW	3 MHz		
				SWT	5 ms	Unit	dBm

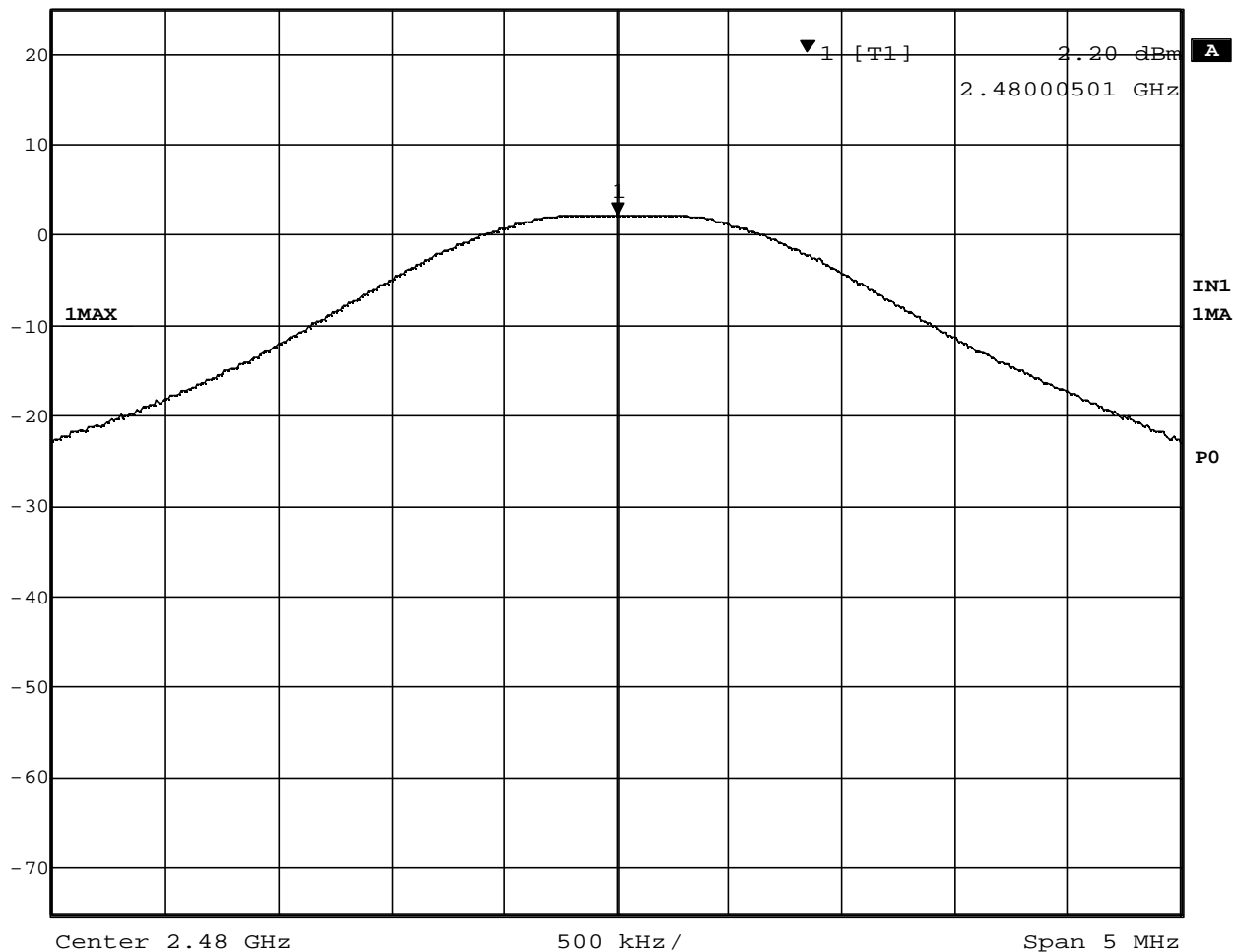

Date: 9.JAN.2002 12:08:08

Peak Output Power (TX on 2480MHz)



Ref Lvl	Marker 1 [T1]	RBW	1 MHz	RF Att	40 dB
25 dBm	0.26 dBm	VBW	3 MHz		
	2.44055210 GHz	SWT	5 ms	Unit	dBm

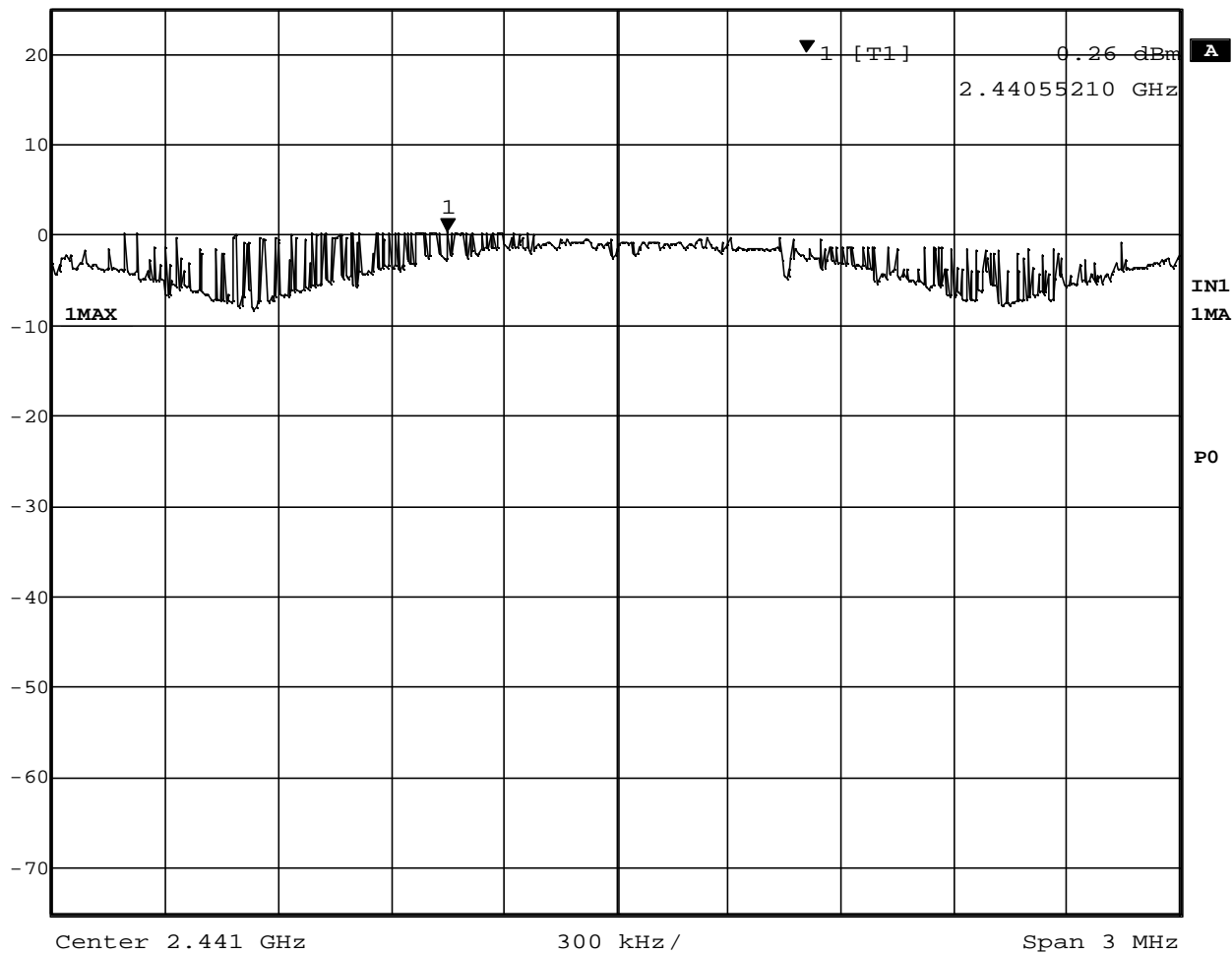

Date: 9.JAN.2002 12:21:38

Peak Output Power (Inquiry)



Ref Lvl	Marker 1 [T1]	RBW	1 MHz	RF Att	40 dB
25 dBm	0.98 dBm	VBW	3 MHz		
	2.44197295 GHz	SWT	5 ms	Unit	dBm

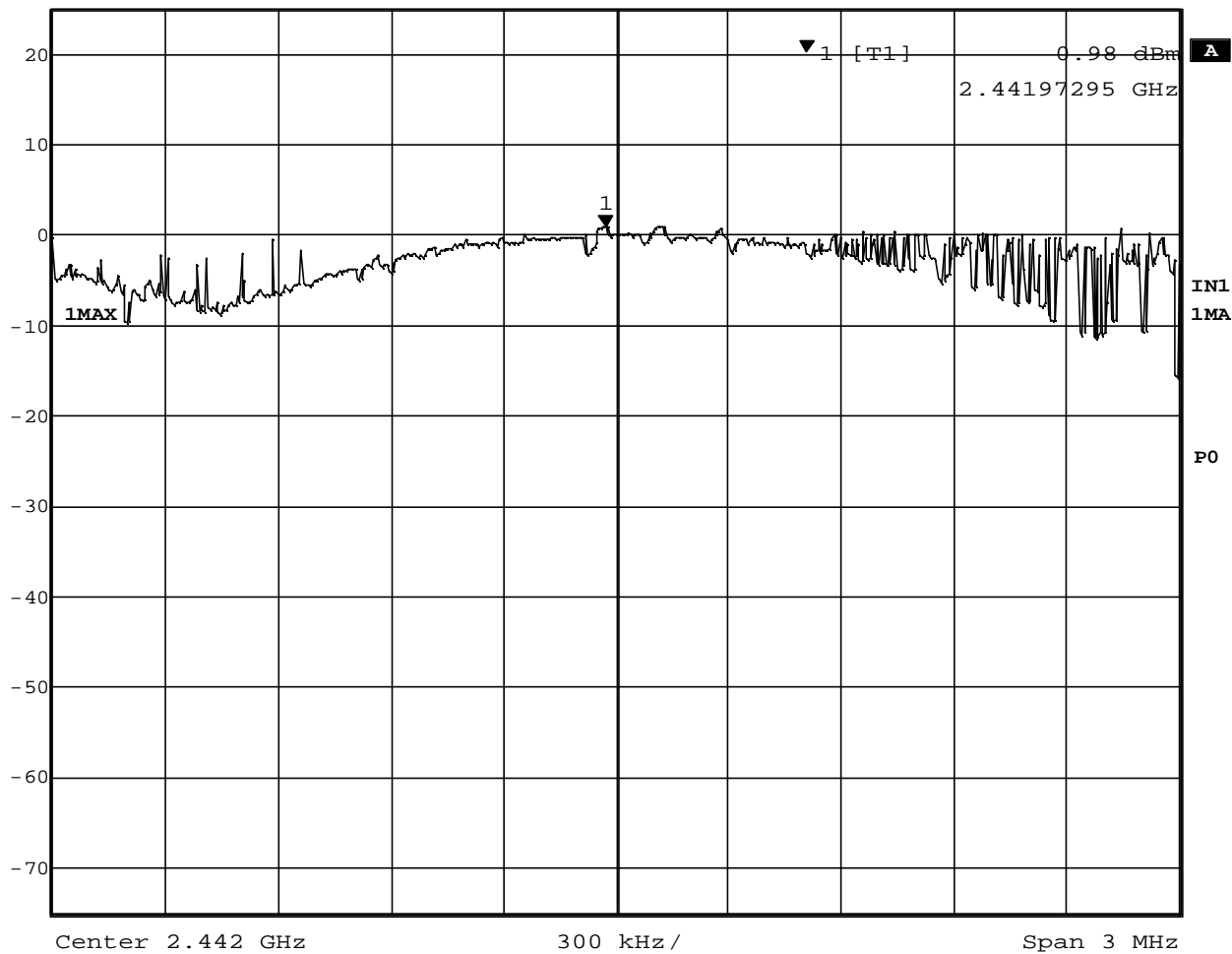

Date: 10.JAN.2002 08:38:40

Peak Output Power (Paging)

6. Band-edge (at 20 dB blow)

6.1 Test Procedure

- The bandwidth at 20 dB down from the highest inband spectral density is measured with a spectrum analyzer connected to the antenna terminal, while EUT had its hopping function disabled at the highest, middle and the lowest available channels.
- The spectrum analyzer is set to :
 - Center frequency = the highest, middle and the lowest channels,
 - Span = 3 MHz
 - RBW : 1% of span or more = 30 kHz
 - VBW : equal to RBW or more = 30 kHz
 - Sweep = auto, Detector function = peak, Trace = max hold
- After the trace being stable. Use the marker-to-peak function to set the marker to the peak of the emission. Use the marker-delta function to measure 20 dB down both sides of the intentional emission.

6.2 Test Instruments and Measurement Setup

Same as the Chapter 1(Table 1-1 & Figure 1).

6.3 Measurement Results

Test Date: January 10, 2002

Table 6. EUT: M/T 2366-52U, s/n ZZ-00163

Center Frequency (MHz)	Lower Frequency (MHz)	Upper Frequency (MHz)	20dB Occupied BW (MHz)	Margin to Lower limit (MHz)	Margin to Upper limit (MHz)
2402 (ch. 1)	2401.606	2402.388	0.782	1.606	
2441 (ch. 40)	2440.606	2441.358	0.752		
2480 (ch. 79)	2479.606	2480.352	0.746		3.148

Note) In line with Section 15.31(m) of Public Notice DA 00-705 dated March 30, 2000, the measurement was performed at the highest, middle and lowest available channels.

6.4 Trace Data

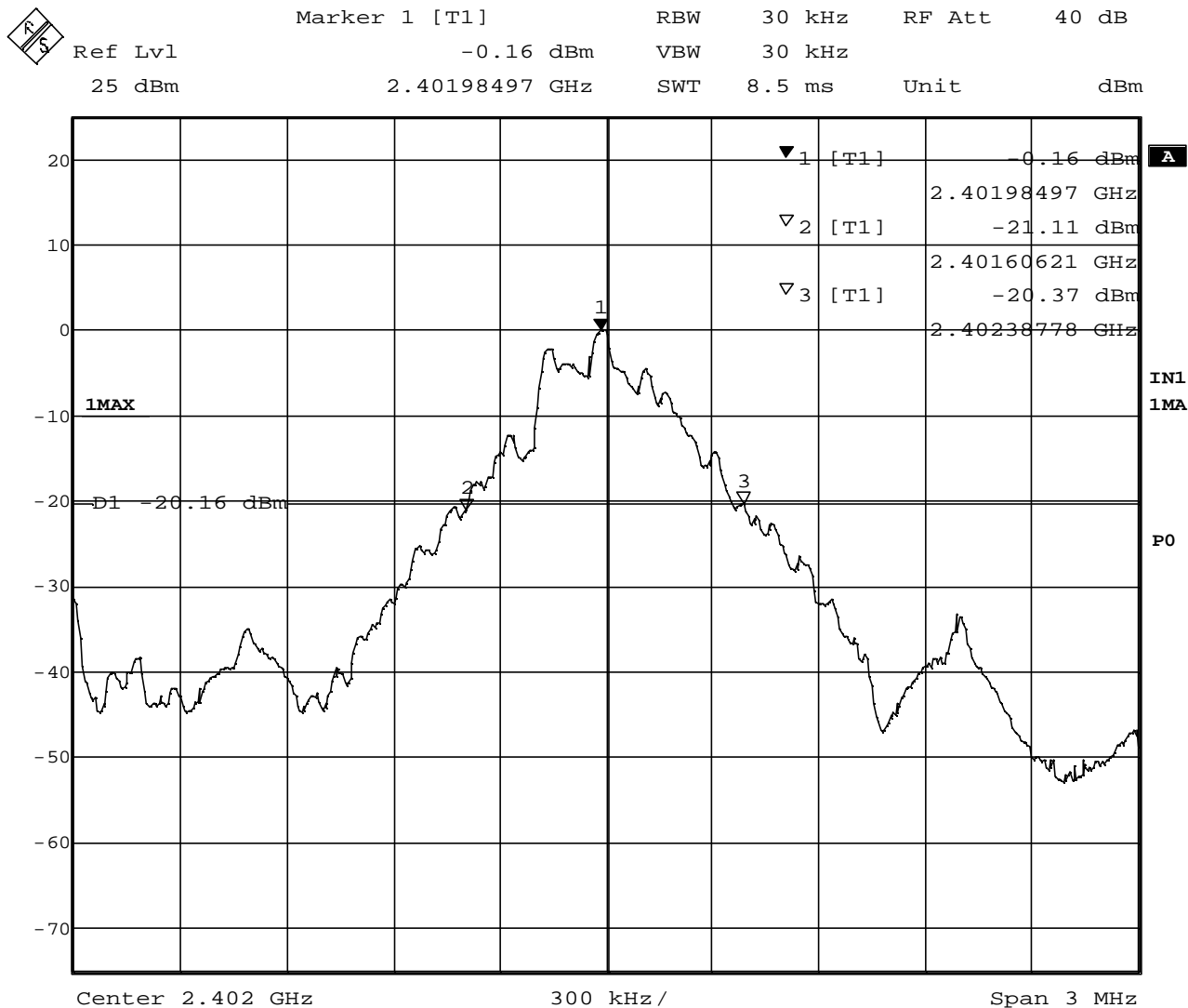

Date: 10.JAN.2002 09:02:55

Band-edge (TX on 2402MHz)



Ref Lvl	Marker 1 [T1]	RBW	30 kHz	RF Att	40 dB
25 dBm	0.91 dBm	VBW	30 kHz		
	2.44098497 GHz	SWT	8.5 ms	Unit	dBm

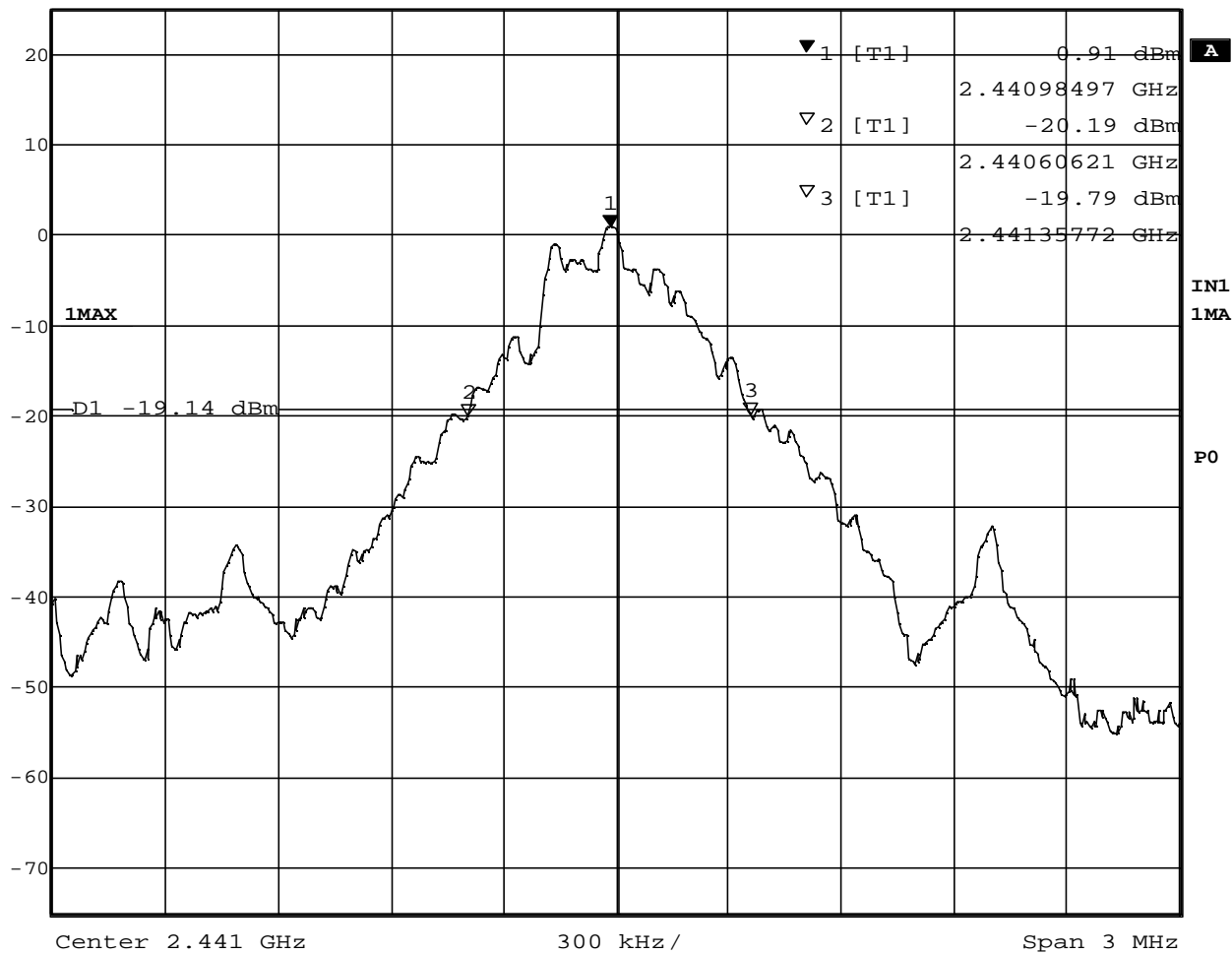

Date: 10.JAN.2002 09:04:24

Band-edge (TX on 2441MHz)



Marker 1 [T1] RBW 30 kHz RF Att 40 dB
 Ref Lvl 1.80 dBm VBW 30 kHz
 25 dBm 2.47999098 GHz SWT 8.5 ms Unit dBm

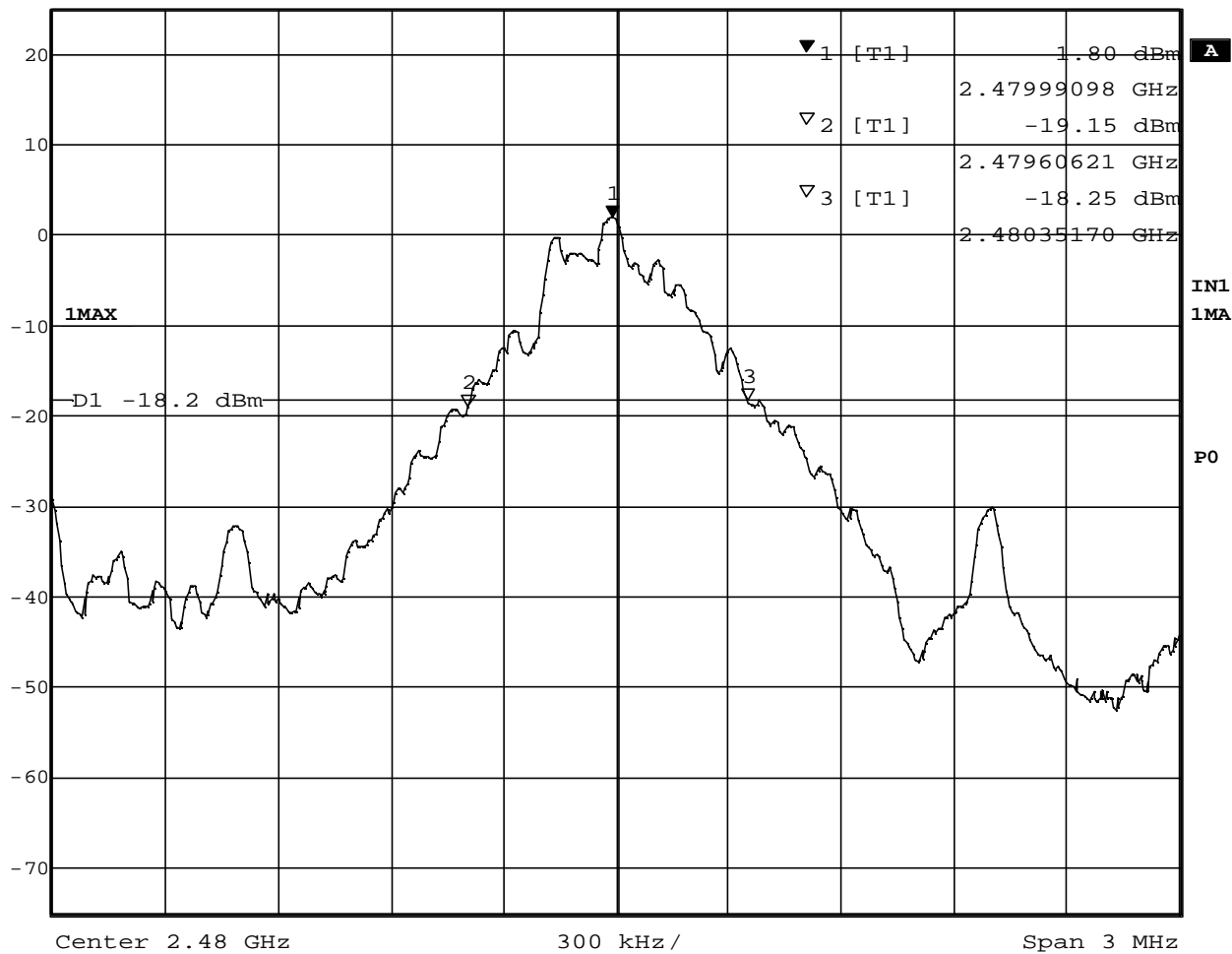

Date: 10.JAN.2002 09:06:18

Band-edge (TX on 2480MHz)

7. Out of Band Emissions

7.1 Test Procedure

- The out of band emissions is measured with a spectrum analyzer connected to the antenna terminal, while EUT had its hopping function disabled at the highest, middle and the lowest available channels.
- The spectrum analyzer is set to :
 - Center frequency = the highest, middle and the lowest channels
 - Span : 100 MHz
 - RBW : 100 kHz
 - VBW : 100 kHz
 - Sweep = auto, Detector function = peak, Trace = max hold
- After the trace being stable. Use the marker-to-peak function to set the marker to the peak of the inband emission. Use the marker-delta function to measure 20 dB down the peak of the inband emission.

7.2 Test Instruments and Measurement Setup

Same as the Chapter 1(Table 1-1 & Figure 1).

7.3 Measurement Results

All conducted emission in any 100 kHz bandwidth outside of the spread spectrum band was at least 20dB lower than the highest inband spectral density. Therefore the applying equipment meets the requirement.

Test Date: January 10, 2002

7.4 Trace Data

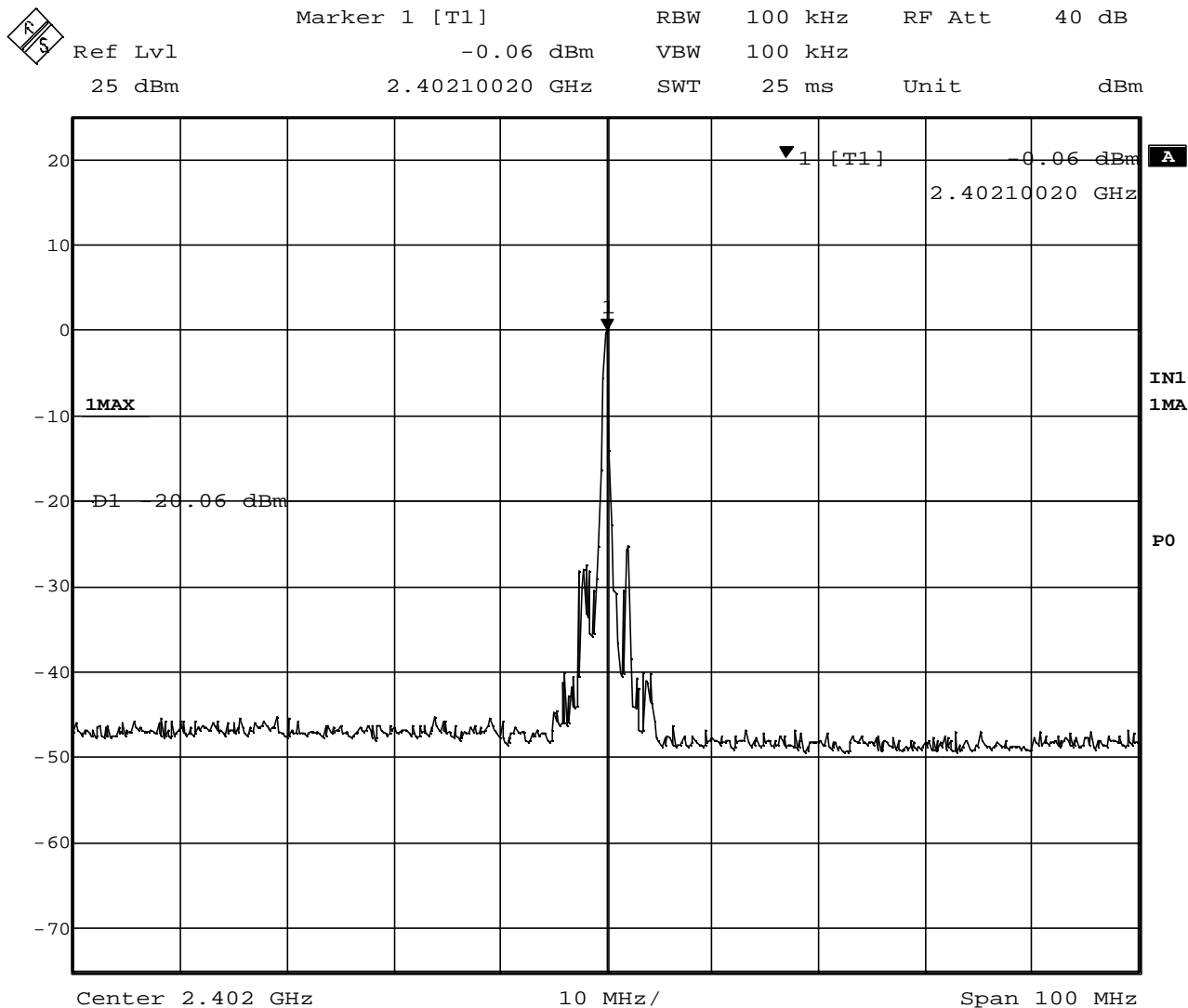

Date: 10.JAN.2002 09:09:03

Out of Band Emissions (TX on 2402MHz)



Marker 1 [T1]	RBW	100 kHz	RF Att	40 dB
Ref Lvl	1.02 dBm	VBW	100 kHz	
25 dBm	2.44110020 GHz	SWT	25 ms	Unit dBm

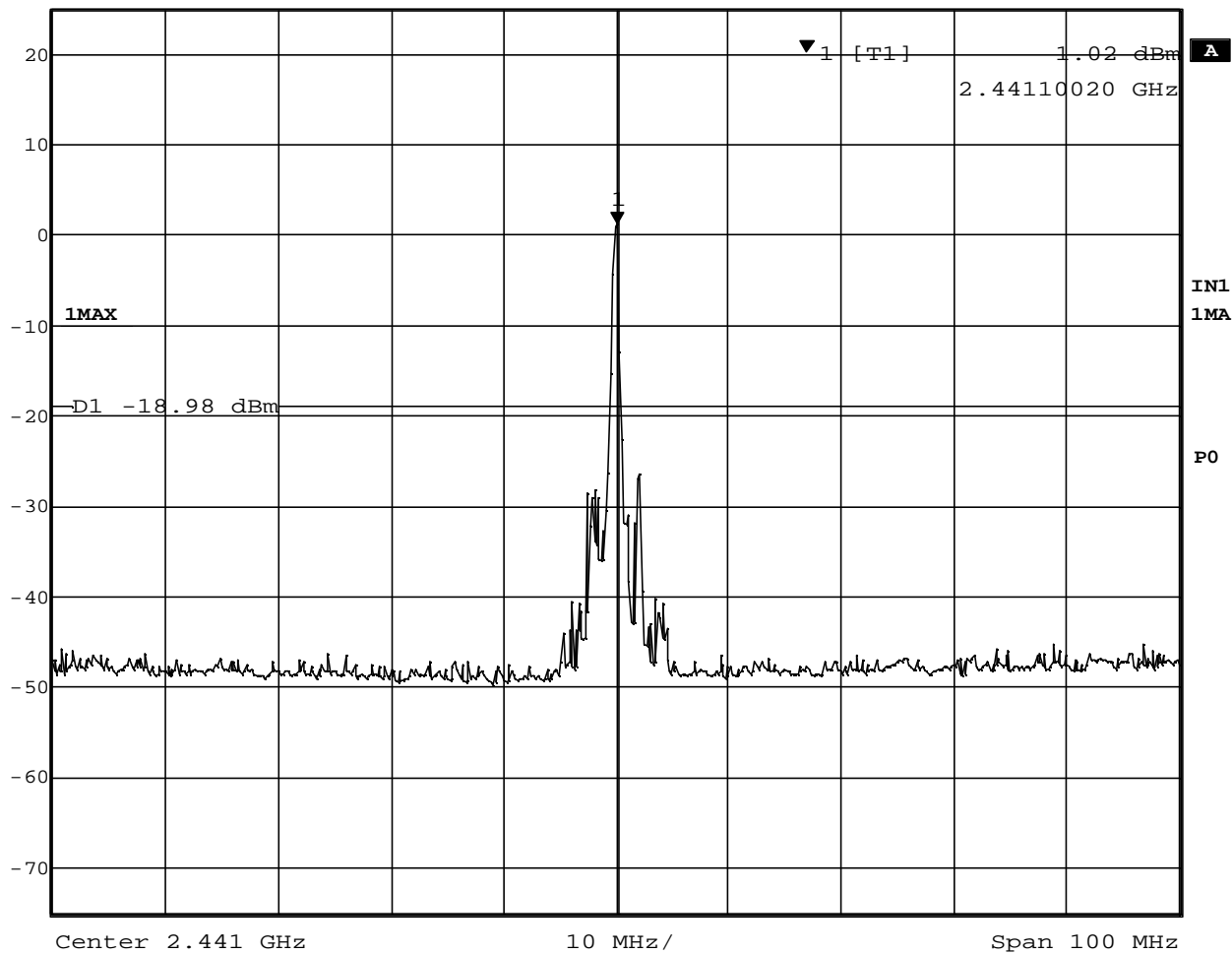

Date: 10.JAN.2002 09:11:52

Out of Band Emissions (TX on 2441MHz)



Marker 1 [T1] RBW 100 kHz RF Att 40 dB
Ref Lvl 1.91 dBm VBW 100 kHz
25 dBm 2.48010020 GHz SWT 25 ms Unit dBm

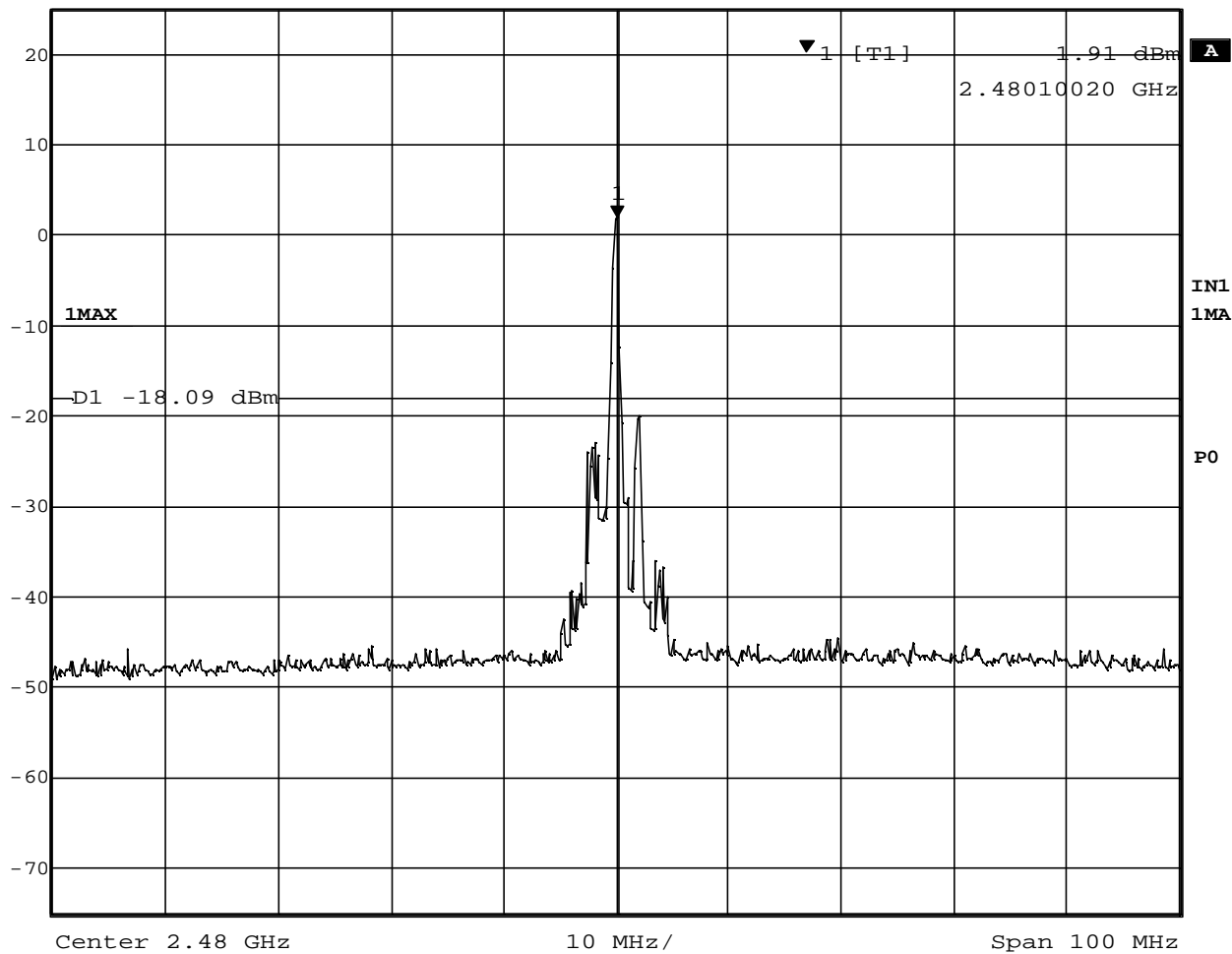

Date: 10.JAN.2002 09:11:02

Out of Band Emissions (TX on 2480MHz)

8. Transmitter Power Spectral Density

8.1 Test Procedure

The peak power density is measured with a spectrum analyzer connected to the antenna terminal, while EUT had been operating in Inquiry and Paging mode.

The spectrum analyzer is set to:

Center Frequency = middle channel, RBW = 3 kHz, VBW = 3 kHz, Span = 2 MHz, Sweep = auto

8.2 Test Instruments and Measurement Setup

Same as the Chapter 1(Table 1-1 & Figure 1).

8.3 Measurement Results

Test Date: January 10, 2002

Table 8. EUT: M/T 2366-52U, s/n ZZ-00163

EUT Operation mode	Measured Frequency (MHz)	Spectrum Analyzer Reading (dBm)	Cable loss (dB)	Result (dBm)	Limit (dBm)	Margin (dB)
Inquiry	2440.99	- 13.4	1.7	- 11.7	8.0	19.7
Paging	2441.99	- 8.0	1.7	- 6.3	8.0	14.3

8.4 Trace Data



Marker 1 [T1 NOI]	RBW	3 kHz	RF Att	40 dB
Ref Lvl	-53.23 dBm/Hz	VBW	3 kHz	
25 dBm	2.44098998 GHz	SWT	560 ms	Unit dBm

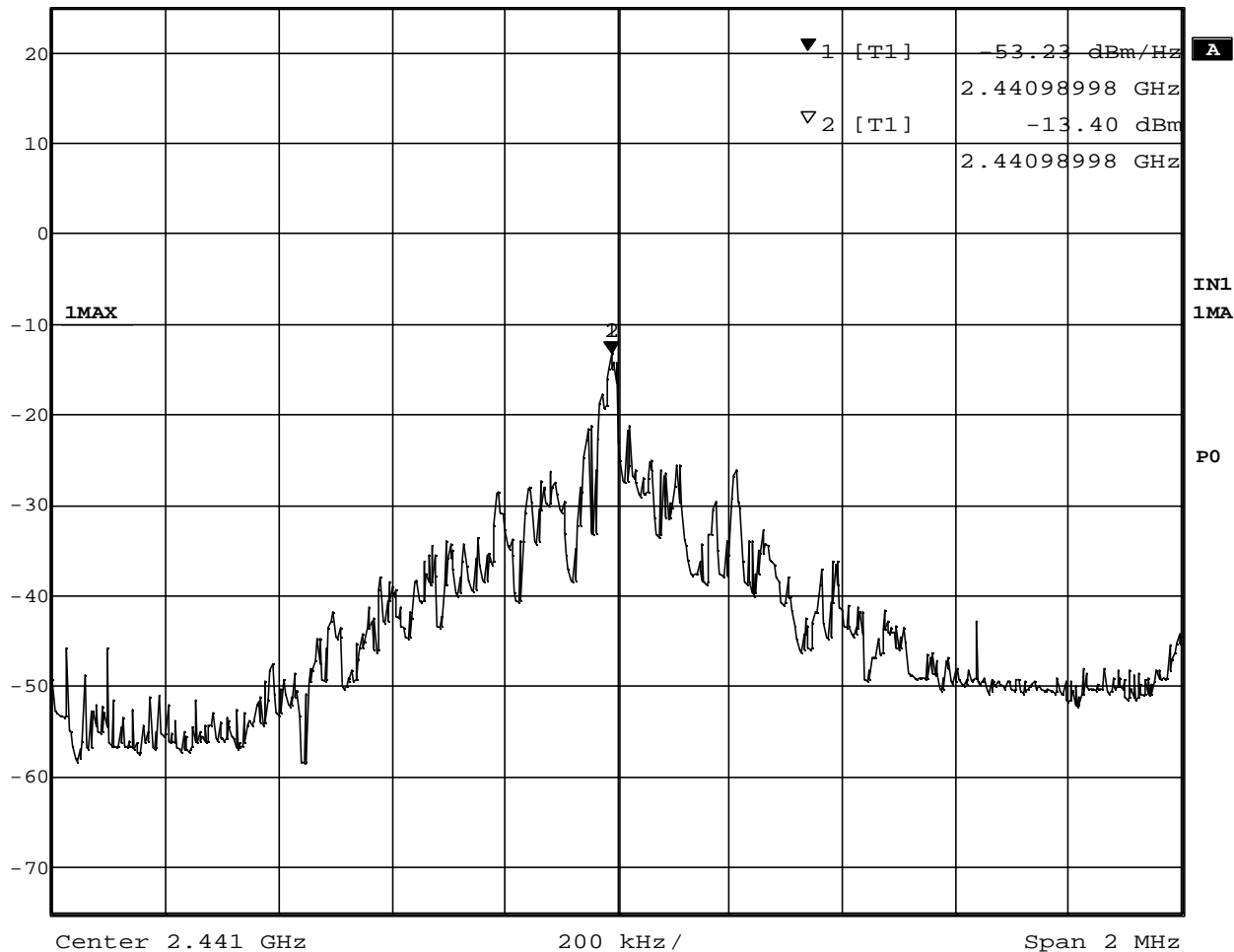

Date: 10 . JAN . 2002 08 : 49 : 32

Transmitter Power Spectral Density (Inquiry)



Marker 1 [T1 NOI] RBW 3 kHz RF Att 40 dB
Ref Lvl -50.30 dBm/Hz VBW 3 kHz
25 dBm 2.44198998 GHz SWT 560 ms Unit dBm

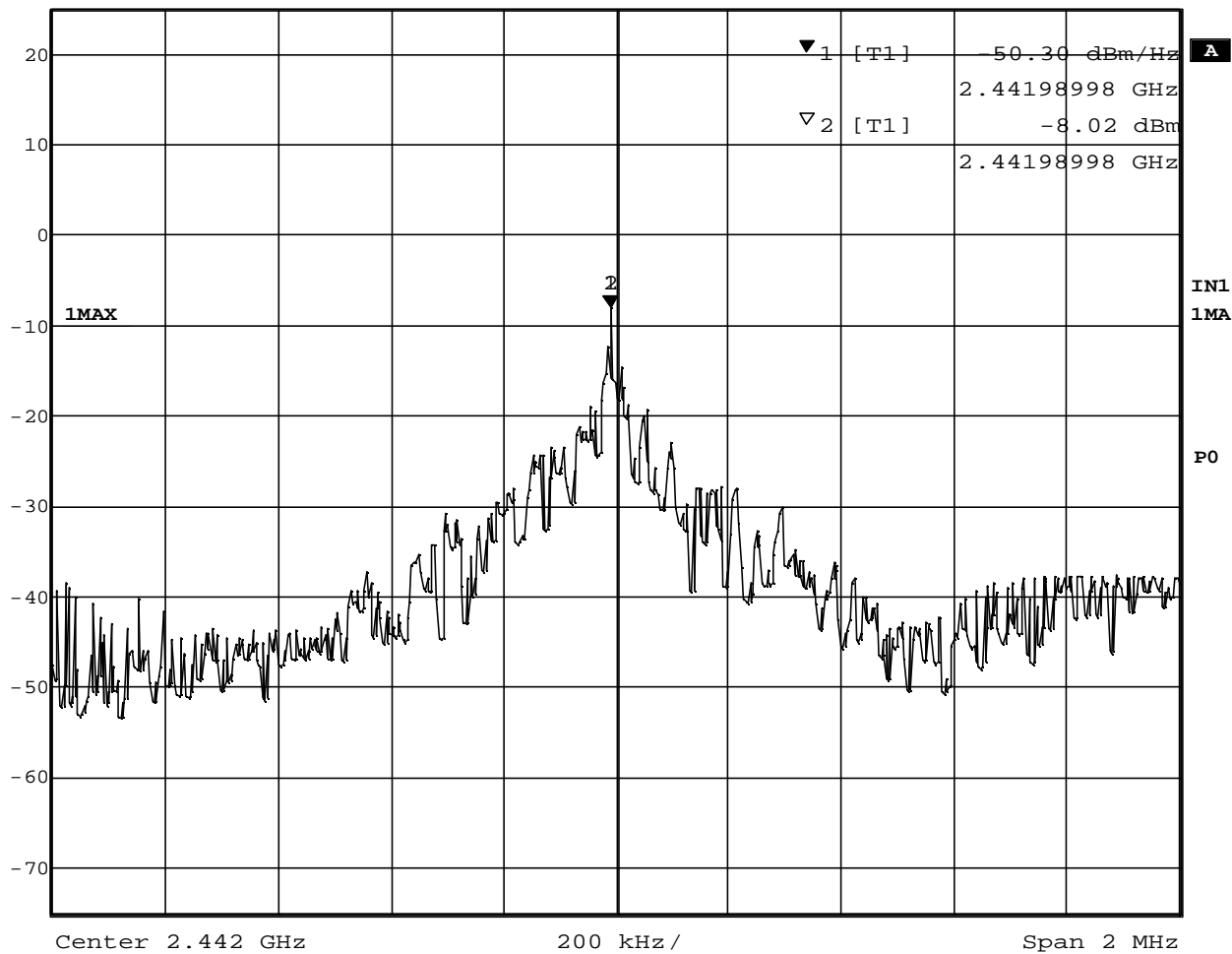

Date: 10 . JAN . 2002 08 : 47 : 28

Transmitter Power Spectral Density (Paging)

9. AC WIRELINE CONDUCTED EMISSIONS (450 kHz – 30 MHz)

9.1 Test Procedure

The conducted emissions are measured in the IBM shielded room with a spectrum analyzer in peak hold. While the measurement, EUT had its hopping function disabled at the highest, middle and lowest available channels in line with Section 15.31(m) of Public Notice DA 00-705 dated March 30, 2000. Emissions closest to the limit are measured in the quasi-peak mode (QP) with the tuned receiver using a bandwidth of 9 kHz. The emissions are maximized further by cable manipulation and Exerciser operation. The highest emissions relative to the limit are listed.

9.2 Test Instruments and Measurement Setup

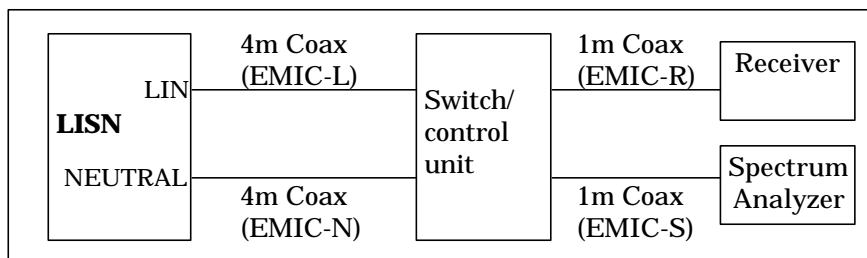

Figure 9. Cables for Conducted Emission Test

Table 9-1. Conducted Emission Test Instrumentation

Description	Model	Serial Number
Computer	IBM 6589-13J	97-15613
Spectrum Analyzer (100Hz-1.5GHz)	HP 85680B	2732A03651
Spectrum Analyzer Display	HP 85662A	2648A15255
Quasi-Peak Adapter	HP 85650A	2521A00968
Receiver (9kHz-30MHz)	R&S ESH3	891806/012
LISN	EMCO 3825/2	1426
Switch/control unit	HP 3488A	2719A17228
Plotter	HP 7550A	2631A33619
Coax cables:	Length:	
- Lisl-L <=> SW/Con.unit (SW100)	4 m	- EMIC-L
- Lisl-N <=> SW/Con.unit (SW101)	4 m	- EMIC-N
- SW/Con.unit <=> RCVR (Input)	1 m	- EMIC-R
- SW/Con.unit<=> Spe Ana.(Signal In)	1 m	- EMIC-S

Notes: - HP: Hewlett Packard, R&S: Rohde & Schwarz

9.3 Measurement Results

The EUT was found to comply to the limits of FCC Part 15 Subpart C and RSS-210 with a margin of 15.6 dB. The 6 highest emissions relative to the limits are reported.

Test Date: January 11, 2002

1) EUT in transmission mode

Table 9-2-1. EUT: M/T 2366-52U, s/n ZZ-00163, Ch.1(2402MHz)

Frequency (MHz)	QP Voltage (dB μ V)	QP Limit (dB μ V)	QP Voltage (μ V)	QP Limit (μ V)	Phase
0.5272	30.8	48	34.7	250	Neutral
0.7250	26.0	48	20.0	250	Neutral
0.7420	13.0	48	4.5	250	Line
0.9574	25.0	48	17.8	250	Neutral
22.7929	30.9	48	35.1	250	Neutral
24.3984	32.4	48	41.7	250	Neutral

Table 9-2-2. EUT: M/T 2366-52U, s/n ZZ-00163 , Ch.40(2441MHz)

Frequency (MHz)	QP Voltage (dB μ V)	QP Limit (dB μ V)	QP Voltage (μ V)	QP Limit (μ V)	Phase
0.5250	30.2	48	32.4	250	Neutral
0.6388	24.7	48	17.2	250	Neutral
0.8520	21.4	48	11.7	250	Neutral
1.3474	18.5	48	8.4	250	Neutral
23.6545	27.7	48	24.3	250	Neutral
24.8613	26.6	48	21.4	250	Neutral

Table 9-2-3. EUT: M/T 2366-52U, s/n ZZ-00163, Ch.79(2480MHz)

Frequency (MHz)	QP Voltage (dB μ V)	QP Limit (dB μ V)	QP Voltage (μ V)	QP Limit (μ V)	Phase
0.5235	29.5	48	29.9	250	Neutral
0.6381	23.6	48	15.1	250	Line
0.8184	12.6	48	4.3	250	Line
0.9035	21.1	48	11.4	250	Neutral
15.8337	24.2	48	16.2	250	Neutral
23.3402	29.8	48	30.9	250	Neutral

2) EUT in receiving mode

Table 9-2-4. EUT: M/T 2366-52U, s/n ZZ-00163, RX mode

Frequency (MHz)	QP Voltage (dB μ V)	QP Limit (dB μ V)	QP Voltage (μ V)	QP Limit (μ V)	Phase
0.5098	26.9	48	22.1	250	Line
0.5792	22.5	48	13.3	250	Line
0.6511	21.3	48	11.6	250	Neutral
0.9833	19.3	48	9.2	250	Neutral
23.6586	26.1	48	20.2	250	Neutral
26.0297	23.1	48	14.3	250	Line

10. RESTRICTED BANDS RADIATIONS (30 MHz – 1 GHz)

10.1 Test Procedure

Preliminary radiated emissions are measured in the semi-anechoic chamber at a 3 meter distance on every azimuth in both horizontal and vertical polarity. The antennas are also scanned in height. The identified emissions are further maximized by a cable manipulation. Emissions closest to the limits are measured in the quasi-peak mode with the tuned receiver using a bandwidth of 120 kHz. The highest emissions relative to the limit are listed.

While the measurement, EUT had its hopping function disabled at the highest, middle and lowest available channels in line with Section 15.31(m) of Public Notice DA 00-705 dated March 30, 2000.

10.2 Test Instruments and Measurement Setup

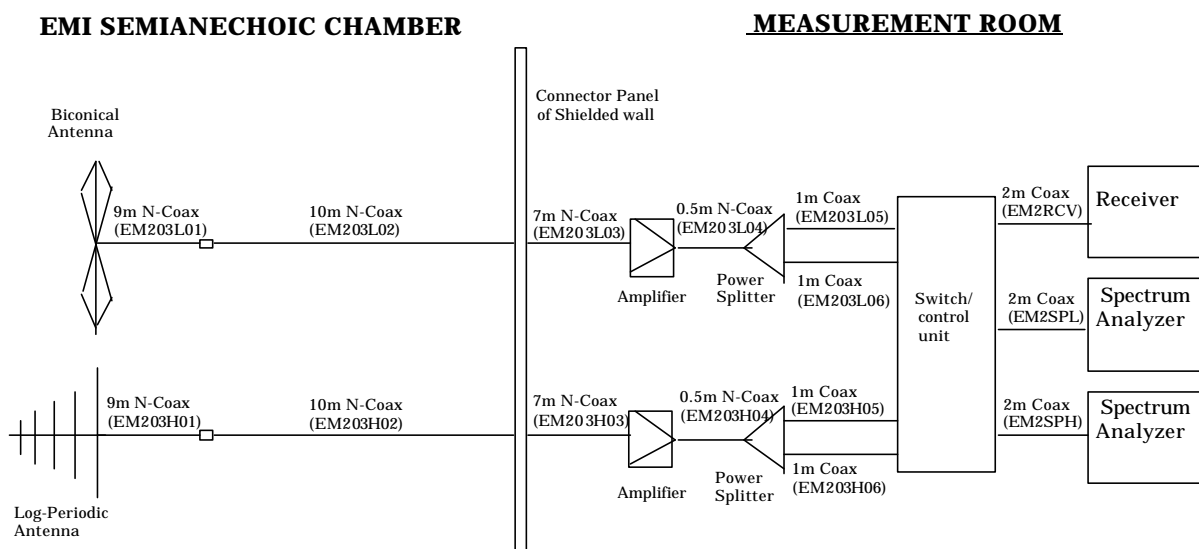

Figure 10 Cables for Radiated Emission Test

Table 10-1 Radiated Emission Test Instrumentation

Description	Model	Serial Number
Computer	IBM 5551-L	#4
Spectrum Analyzer (100Hz-1.5GHz) for 30-200MHz	HP 85680B	3019A05155
Spectrum Analyzer Display for 30-200MHz	HP 85662A	3026A19353
Quasi-Peak Adapter for 30-200MHz	HP 85650A	3033A01449
Spectrum Analyzer (100Hz-1.5GHz) for 200-1000MHz	HP 85680B	3019A05156
Spectrum Analyzer Display for 200-1000MHz	HP 85662A	3026A19366
Quasi-Peak Adapter for 200-1000MHz	HP 85650A	2811A01433
Amplifier (100KHz-1.3GHz)		
- for 30-200MHz	HP 8447D	2805A02919
- for 200-1000MHz	HP 8447D	2944A03506
Biconical Antenna (30-200MHz)	EMCO 3108	2241
Log-Periodic Antenna (200-1000MHz)	EMCO 3146	1584
Receiver (20MHz-1.3GHz)	R&S ESVP	893202/018
Switch/control unit	HP 3488A	2719A17226
N-Coax cables:	Length:	
- Bi-coni Ant <=> 10m Cable	9 m	- EM203L01
- 10m Cable <=> Shield Panel	10 m	- EM203L02
- Shield Panel <=> RF Amp	7 m	- EM203L03
- RF Amp <=> Power Splitter	0.5m	- EM203L04
- Log-peri Ant <=> 10m Cable	9 m	- EM203H01
- 10m Cable <=> Shield Panel	10 m	- EM203H02
- Shield Panel <=> RF Amp	7 m	- EM203H03
- RF Amp <=> Power Splitter	0.5m	- EM203H04
Coax cables:		
- Power Splitter <=> SW/Con.unit (SW110)	1 m	- EM203L05
- Power Splitter <=> SW/Con.unit (SW300)	1 m	- EM203L06
- Power Splitter <=> SW/Con.unit (SW100)	1 m	- EM203H05
- Power Splitter <=> SW/Con.unit (SW301)	1 m	- EM203H06
- SW/Con.unit <=> Receiver (Input)	2 m	- EM2RCV
- SW/Con.unit <=> Spe Ana.(Signal In) for 30- 200MHz	2 m	- EM2SPL
- SW/Con.unit <=> Spe Ana.(Signal In) for 200-1000MHz	2 m	- EM2SPH

Notes: HP: Hewlett Packard, R&S: Rohde & Schwarz

10.3 Field Strength Calculation

The field strength is calculated by adding the Antenna Factor and Cable Loss, and subtracting Amplifier Gain from the measured reading. In this test facility, the Antenna Factor, Cable Loss, and Amplifier Gains are loaded into the Rohde & Schwarz Receiver and the corrected field strength can be read directly on the receiver. All factors are included in the reported data.

$$FS = R + AF + CORR$$

where:

- FS = Field Strength
- R = Measured Receiver Input Amplitude
- AF = Antenna Factor
- CORR = Correction Factor = CL - AG
- CL = Cable Loss
- AG = Amplifier Gain

For example:

Given a Receiver input reading of 51.5dBμV; Antenna Factor of 8.5dB/m; Cable Loss of 1.3dB; and an Amplifier Gain of 26dB. The Field Strength of the measured emission is:

$$FS = 51.5 + 8.5 + 1.3 - 26.0 = 35.3\text{dB}\mu\text{V/m}$$

Conversion between dBμV/m (or dBμV) and μV/m (or μV) are done as:

$$\text{Level}(\text{dB}\mu\text{V/m}) = 20 \times \text{Log}(\text{Level}(\mu\text{V/m}))$$

$$40\text{dB}\mu\text{V/m} = 100\mu\text{V/m}$$

$$48\text{dB}\mu\text{V/m} = 250\mu\text{V/m}$$

10.4 Measurement Results

The EUT was found to comply to the limits of FCC Part 15 Subpart C and RSS-210 with a margin of 3.7 dB at 30 – 1000 MHz band.

The 6 highest emissions relative to the limits are reported.

Test Date: January 7, 2002

1) EUT in transmission mode

Table 10-2-1. EUT: M/T 2366-52U, s/n ZZ-00163, Ch.1 (2402MHz) TX mode

Frequency (MHz)	Polarity (H/V)	Measured (dB μ V)	Antenna Factor (dB/m)	Corr. Factor (dB)	Field Strength (dB μ V/m)	Limit (dB μ V/m)	Field Strength (μ V/m)	Limit (μ V/m)
187.507	H	41.4	13.3	-17.8	36.9	43.5	70.0	150
364.516	V	36.3	14.2	-14.4	36.1	46.0	63.8	200
395.996	V	34.6	15.1	-14.4	35.3	46.0	58.2	200
439.995	V	34.5	15.8	-14.2	36.1	46.0	63.8	200
671.968	V	25.7	20.4	-13.8	32.3	46.0	41.2	200
729.030	V	30.3	20.6	-13.7	37.2	46.0	72.4	200

Table 10-2-2. EUT: M/T 2366-52U, s/n ZZ-00163, Ch.40 (2441MHz) TX mode

Frequency (MHz)	Polarity (H/V)	Measured (dB μ V)	Antenna Factor (dB/m)	Corr. Factor (dB)	Field Strength (dB μ V/m)	Limit (dB μ V/m)	Field Strength (μ V/m)	Limit (μ V/m)
189.499	H	44.4	13.4	-18.0	39.8	43.5	97.7	150
395.996	V	34.8	15.1	-14.4	35.5	46.0	59.6	200
439.995	V	34.1	15.8	-14.2	35.7	46.0	61.0	200
729.029	V	34.8	20.6	-13.7	41.7	46.0	121.6	200
932.245	V	23.1	23	-11.2	34.9	46.0	55.6	200
959.954	V	23.9	23.2	-11.5	35.6	46.0	60.3	200

Table 10-2-3. EUT: M/T 2366-52U, s/n ZZ-00163, Ch.79 (2480MHz) TX mode

Frequency (MHz)	Polarity (H/V)	Measured (dB μ V)	Antenna Factor (dB/m)	Corr. Factor (dB)	Field Strength (dB μ V/m)	Limit (dB μ V/m)	Field Strength (μ V/m)	Limit (μ V/m)
190.829	H	41.1	13.4	-17.8	36.7	43.5	68.4	150
364.515	V	35.4	14.2	-14.4	35.2	46.0	57.5	200
395.996	V	33.6	15.1	-14.4	34.3	46.0	51.9	200
439.995	V	35.5	15.8	-14.2	37.1	46.0	71.6	200
671.968	V	26.5	20.4	-13.8	33.1	46.0	45.2	200
729.029	V	32.9	20.6	-13.7	39.8	46.0	97.7	200

2) EUT in receiving mode

Table 10-2-4. EUT: M/T 2366-52U, s/n ZZ-00163, Ch.40 (2441MHz) RX mode

Frequency (MHz)	Polarity (H/V)	Measured (dBμV)	Antenna Factor (dB/m)	Corr. Factor (dB)	Field Strength (dBμV/m)	Limit (dBμV/m)	Field Strength (μV/m)	Limit (μV/m)
187.677	H	42.8	13.3	-17.8	38.3	43.5	82.2	150
364.515	H	36.2	14.2	-14.4	36.0	46.0	63.1	200
439.995	V	35.7	15.8	-14.2	37.3	46.0	73.3	200
729.029	V	32.0	20.6	-13.7	38.9	46.0	88.1	200
932.279	V	23.7	23	-11.2	35.5	46.0	59.6	200
959.955	V	24.5	23.2	-11.5	36.2	46.0	64.6	200

11. RESTRICTED BANDS RADIATIONS (1 GHz – 25 GHz)

11.1 Test Procedure

Radiated emissions were measured in the frequency range with 1 to 25 GHz in transmitting mode and 1 to 12.5 GHz in receiving mode. All tests were performed in the semi-anechoic chamber at a 3-meter distance (except for the frequency range with 18 to 25 GHz where test distance was reduced to 1 meter) on both horizontal and vertical polarities. The antenna was also scanned in height. The identified emissions are further maximized as a function of cable manipulation, azimuth, and antenna height. The emissions closest to the limits are measured in the peak mode with the tuned spectrum analyzer using a bandwidth of 1MHz and the average setting mode with the tuned spectrum analyzer using resolution bandwidth of 1 MHz / video bandwidth of 1 kHz or 100 Hz. The highest emissions relative to the limit are listed. While the measurement, EUT had its hopping function disabled at the highest, middle and lowest available channels in line with Section 15.31(m) of Public Notice DA 00-705 dated March 30, 2000.

11.2 Test Instruments and Measurement

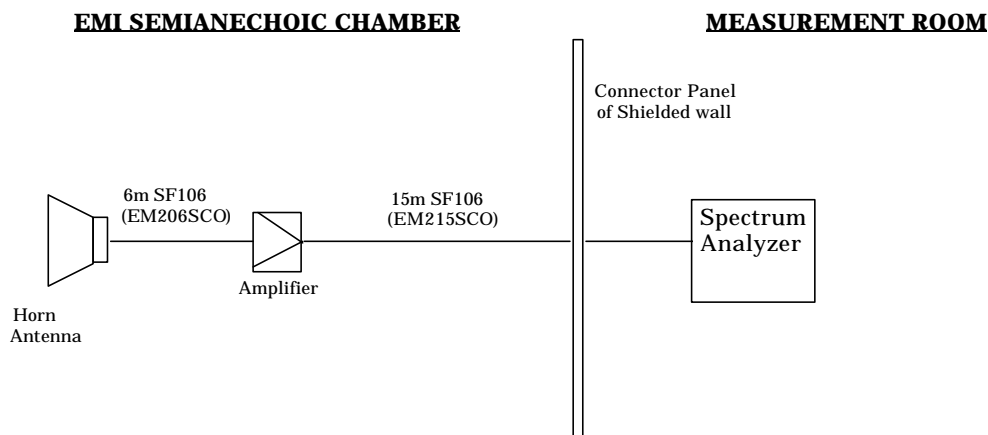

Figure 11 Cables for Radiated Emission Test

Table 11 Radiated Emission Test Instrumentation (1 – 25 GHz)

Description	Model	Serial Number
Spectrum Analyzer EMI Test Receiver	R&S ESI26	836119/003
Amplifier (1 - 26.5GHz)	HP 8449B	3008A00582
Horn Antenna (1- 18GHz)	EMCO 3115	9903-5774
Horn Antenna (3.95 – 5.85GHz)	EMCO 3160-5	1099
Horn Antenna (5.85 – 8.20GHz)	EMCO 3160-6	9712-1044
Horn Antenna (18- 26.5GHz)	EMCO 3160-9	0004-1202
SF106 cables: - Horn Ant <=> RF Amp. - RF Amp.<=>Spectrum Analyzer	Length: 6 m 15 m	- EM206SCO - EM215SCO

Notes: HP: Hewlett Packard, R&S: Rohde & Schwarz

11.3 Field Strength Calculation

The field strength is calculated by adding the Antenna Factor and Cable Loss, and subtracting Amplifier Gain from the measured reading. All factors are included in the reported data.

$$FS = R + AF + CORR - FO$$

where:

- FS = Field Strength
- R = Measured Spectrum analyzer Input Amplitude
- AF = Antenna Factor
- CORR = Correction Factor = CL-AG
- CL = Cable Loss
- AG = Amplifier Gain
- FO = Distance Falloff Factor

For example:
 Given a Spectrum Analyzer input reading of 51.5 dBμV; Antenna Factor of 8.5 dB/m; Cable Loss of 1.3 dB;
 Falloff Factor of 0 dB; and an Amplifier Gain of 26 dB. The Field Strength of the measured emission is:

$$FS = 51.5 + 8.5 + 1.3 - 26 - 0.0 = 35.6 \text{ dB}\mu\text{V/m}$$

Conversions between dBμV/m (or dBμV) and μV/m (or μV) are done as :

- Level(dBμV/m) = 20 X Log (Level(μV/m))
- 40 dBμV/m = 100 μV/m
- 48 dBμV/m = 250 μV/m

11.4 Measurement Results

The EUT was found to comply to the limits of FCC Part 15 Subpart C and RSS-210 with a margin of 3.9dB. The measurement was done for the frequency range of 1 to 25 GHz in TX mode and 1 to 12.5 GHz in RX mode.

Test Date: January 7 and 8, 2002

1) EUT in transmission mode

Table 11-2-1. EUT: M/T 2366-52U, s/n ZZ-00163, Ch.1(2402MHz) TX mode

Frequency (GHz)	Polarity (H/V)	Measured (dBμV) (peak)	Measured (dBμV) (average)	Antenna Factor (dB/m)	Corr. Factor (dB)	Falloff Factor (dB)	Field Strength (dBμV/m) (peak)	FCC Limit (dBμV/m) (peak)	Field Strength (dBμV/m) (average)	FCC Limit (dBμV/m) (average)
1.093	V	50.1	-	24.3	-31.3	0.0	43.1	74.0	-	54.0
1.132	V	50.7	-	24.4	-31.3	0.0	43.8	74.0	-	54.0
1.199	V	49.1	-	24.6	-31.2	0.0	42.5	74.0	-	54.0
1.459	V	48.2	-	25.2	-30.6	0.0	42.8	74.0	-	54.0
2.192	V	49.4	-	27.8	-29.0	0.0	48.2	74.0	-	54.0
2.384	V	49.2	-	28.2	-28.5	0.0	48.9	74.0	-	54.0
2.402	V	94.6	90.9	28.2	-28.4	0.0	94.4	OB*	90.7	OB*
4.385	V	46.6	-	27.2	-24.1	0.0	49.7	74.0	-	54.0
4.805	V	38.6	-	27.4	-23.8	0.0	42.2	74.0	-	54.0
7.206	V	46.8	-	30	-24.7	0.0	52.1	74.0	-	54.0

*Note: OB means “operation band” (2400-2483.5MHz); in this case limit is 1W (measured conducted with power meter).

Table 11-2-2. EUT: M/T 2366-52U, s/n ZZ-00163, Ch.40(2441MHz) TX mode

Frequency (GHz)	Polarity (H/V)	Measured (dBμV) (peak)	Measured (dBμV) (average)	Antenna Factor (dB/m)	Corr. Factor (dB)	Falloff Factor (dB)	Field Strength (dBμV/m) (peak)	FCC Limit (dBμV/m) (peak)	Field Strength (dBμV/m) (average)	FCC Limit (dBμV/m) (average)
1.093	V	50.3	-	24.3	-31.3	0.0	43.3	74.0	-	54.0
1.132	V	50.0	-	24.4	-31.3	0.0	43.1	74.0	-	54.0
1.199	V	49.8	-	24.6	-31.2	0.0	43.2	74.0	-	54.0
1.459	V	48.8	-	25.2	-30.6	0.0	43.4	74.0	-	54.0
2.192	V	49.1	-	27.8	-29.0	0.0	47.9	74.0	-	54.0
2.441	V	94.7	91.3	28.3	-28.4	0.0	94.6	OB*	91.2	OB*
4.385	V	47.3	-	27.2	-24.1	0.0	50.4	74.0	-	54.0
4.883	V	37.8	-	27.4	-23.7	0.0	41.5	74.0	-	54.0
7.323	V	42.8	-	29.8	-24.9	0.0	47.7	74.0	-	54.0

*Note: OB means “operation band” (2400-2483.5MHz); in this case limit is 1W (measured conducted with power meter).

Table 11-2-3. EUT: M/T 2366-52U, s/n ZZ-00163, Ch.79(2480MHz) TX mode

Frequency (GHz)	Polarity (H/V)	Measured (dBμV) (<i>peak</i>)	Measured (dBμV) (<i>average</i>)	Antenna Factor (dB/m)	Corr. Factor (dB)	Falloff Factor (dB)	Field Strength (dBμV/m) (<i>peak</i>)	FCC Limit (dBμV/m) (<i>peak</i>)	Field Strength (dBμV/m) (<i>average</i>)	FCC Limit (dBμV/m) (<i>average</i>)
1.093	V	50.4	-	24.3	-31.3	0.0	43.4	74.0	-	54.0
1.132	V	49.9	-	24.4	-31.3	0.0	43.0	74.0	-	54.0
1.199	V	48.7	-	24.6	-31.2	0.0	42.1	74.0	-	54.0
1.459	V	48.4	-	25.2	-30.6	0.0	43.0	74.0	-	54.0
2.192	V	49.5	-	27.8	-29.0	0.0	48.3	74.0	-	54.0
2.480	V	93.5	90.1	28.4	-28.2	0.0	93.7	OB*	90.3	OB*
2.484	V	57.7	49.9	28.4	-28.2	0.0	57.9	74.0	50.1	54.0
4.385	V	46.1	-	27.2	-24.1	0.0	49.2	74.0	-	54.0
4.957	V	38.0	-	27.4	-23.5	0.0	41.9	74.0	-	54.0
7.440	V	40.5	-	29.8	-25.1	0.0	45.2	74.0	-	54.0

*Note: OB means “operation band” (2400-2483.5MHz); in this case limit is 1W (measured conducted with power meter).

2) EUT in receiving mode

Table 11-2-4. EUT: M/T 2366-52U, s/n ZZ-00163, RX mode

Frequency (GHz)	Polarity (H/V)	Measured (dBμV) (<i>peak</i>)	Measured (dBμV) (<i>average</i>)	Antenna Factor (dB/m)	Corr. Factor (dB)	Falloff Factor (dB)	Field Strength (dBμV/m) (<i>peak</i>)	FCC Limit (dBμV/m) (<i>peak</i>)	Field Strength (dBμV/m) (<i>average</i>)	FCC Limit (dBμV/m) (<i>average</i>)
1.093	V	51.0	-	24.3	-31.3	0.0	44.0	74.0	-	54.0
1.132	V	50.0	-	24.4	-31.3	0.0	43.1	74.0	-	54.0
1.199	V	49.4	-	24.6	-31.2	0.0	42.8	74.0	-	54.0
1.459	V	49.2	-	25.2	-30.6	0.0	43.8	74.0	-	54.0
2.192	V	48.8	-	27.8	-29.0	0.0	47.6	74.0	-	54.0
4.385	V	44.6	-	27.2	-24.1	0.0	47.7	74.0	-	54.0