

Emission Test Report

Standard: FCC Part 15 Subpart C / IC RSS-210

Document Number : FCC 19-0165-0

Product: IBM ThinkPad R30
Included IBM ThinkPad 802.11b Wireless Lan Mini-PCI Adapter

FCC ID: ANOCH126P8056

June 18, 2001

Prepared :
EMC Engineer

Takeshi Asano



Signature: 
IBM Japan, Ltd.
EMC Engineering
LAB-S59
1623-14, Shimotsuruma,
Yamato-shi Kanagawa-ken 242, Japan
Phone: +81-46-215-4779
Fax: +81-46-273-7420
E-Mail: asano@jp.ibm.com

Reviewed and Checked :
EMC Staff Engineer

Toshiya Murota

Signature: 
IBM Japan, Ltd.
EMC Engineering
LAB-S59
1623-14, Shimotsuruma,
Yamato-shi Kanagawa-ken 242, Japan
Phone: +81-46-215-6574
Fax: +81-46-273-7420
E-Mail: murota@jp.ibm.com

Approved :
Manager, EMC Engineering

Signature: 
IBM Japan, Ltd.
EMC Engineering
LAB-S59
1623-14, Shimotsuruma,
Yamato-shi Kanagawa-ken 242, Japan
Phone: +81-46-215-2613
Fax: +81-46-273-7420
E-Mail: akihisa@jp.ibm.com

Emission Test Report

Standard: FCC Part 15 Subpart C / IC RSS-210

Document Number : FCC 19-0165-0

Product: IBM ThinkPad R30
Included IBM ThinkPad 802.11b Wireless Lan Mini-PCI Adapter

FCC ID: ANOCH126P8056

June 18, 2001

Prepared :
EMC Engineer

Takeshi Asano

Reviewed and Checked :
EMC Staff Engineer

Toshiya Murota

Signature: _____
IBM Japan, Ltd.
EMC Engineering
LAB-S59
1623-14, Shimotsuruma,
Yamato-shi Kanagawa-ken 242, Japan
Phone: +81-46-215-4779
Fax: +81-46-273-7420
E-Mail: asano@jp.ibm.com

Signature: _____
IBM Japan, Ltd.
EMC Engineering
LAB-S59
1623-14, Shimotsuruma,
Yamato-shi Kanagawa-ken 242, Japan
Phone: +81-46-215-6574
Fax: +81-46-273-7420
E-Mail: murota@jp.ibm.com

Approved :
Manager, EMC Engineering

Akihisa Sakurai

Signature: _____
IBM Japan, Ltd.
EMC Engineering
LAB-S59
1623-14, Shimotsuruma,
Yamato-shi Kanagawa-ken 242, Japan
Phone: +81-46-215-2613
Fax: +81-46-273-7420
E-Mail: akihisa@jp.ibm.com

- Index -

A. GENERAL INFORMATION 3

A.1 TEST METHODOLOGY..... 3

A.2 TEST FACILITY / NVLAP ACCREDITATION..... 3

A.3 EUT DETAILS 3

B. SUMMARY OF TEST RESULTS 4

C. OPERATION MODE OF EUT..... 5

D. TEST INSTRUMENTS 6

1. BANDWIDTH AT 6 DB BELOW..... 8

1.1 TEST PROCEDURE..... 8

1.2 TEST INSTRUMENTS AND MEASUREMENT SETUP..... 8

1.3 MEASUREMENT RESULTS 8

1.4 TRACE DATA 9

2. OCCUPIED BANDWIDTH / BAND-EDGE (AT 20 DB BELOW), AND OUT OF BAND EMISSIONS..... 12

2.1 TEST PROCEDURE..... 12

2.2 TEST INSTRUMENTS AND MEASUREMENT SETUP..... 12

2.3 MEASUREMENT RESULTS OF OCCUPIED BANDWIDTH / BAND-EDGE..... 12

2.4 MEASUREMENT RESULTS OF OUT OF BAND EMISSIONS 12

2.5 TRACE DATA OF BAND-EDGE..... 13

2.6 TRACE DATA OF OUT OF BAND EMISSIONS 16

3. TRANSMITTER OUTPUT POWER..... 19

3.1 TEST PROCEDURE..... 19

3.2 MEASUREMENT RESULTS 19

4. TRANSMITTER POWER SPECTRAL DENSITY 20

4.1 TEST PROCEDURE..... 20

4.2 TEST INSTRUMENTS AND MEASUREMENT SETUP..... 20

4.3 MEASUREMENT RESULTS 20

4.4 TRACE DATA 21

5. AC WIRELINE CONDUCTED EMISSIONS (450KHZ – 30MHZ) 24

5.1 TEST PROCEDURE..... 24

5.2 TEST INSTRUMENTS AND MEASUREMENT SETUP..... 24

5.3 MEASUREMENT RESULTS 25

6. RESTRICTED BANDS RADIATIONS (30MHZ – 1GHZ) 27

6.1 TEST PROCEDURE..... 27

6.2 TEST INSTRUMENTS AND MEASUREMENT SETUP..... 27

6.3 FIELD STRENGTH CALCULATION..... 29

6.4 MEASUREMENT RESULTS 30

7. RESTRICTED BANDS RADIATIONS (1GHZ – 25GHZ) 33

- 7.1 TEST PROCEDURE..... 33**
- 7.2 TEST INSTRUMENTS AND MEASUREMENT SETUP 33**
- 7.3 FIELD STRENGTH CALCULATION..... 34**
- 7.4 MEASUREMENT RESULTS 35**

A. GENERAL INFORMATION

APPLICANT : IBM Japan Ltd.
 ADDRESS : 1623 – 14 Shimotsuruma, Yamato-shi, Kanagawa 242-8502 Japan
 Tel: +81-46-215-4779, Fax: +81-46-273-7420
 REGULATION : FCC Part 15 Subpart C
 Industry Canada RSS-210 (Issue No.4)
 MODEL NUMBER : 2656-3Ax (ThinkPad R30, 13”TFT)
 2656-6Ax (ThinkPad R30, 14”TFT)
 FCC ID : ANOCH126P8056
 SERIAL NUMBER : AA-G70KZ (2656-3Ax, 13” TFT)
 AA-G70K8 (2656-6Ax, 14”, TFT)
 PHYSICAL CONDITION : Preproduction
 KIND OF EQUIPMENT : Personal computer with a built-in Wireless LAN card
 TESTED DATE : May 28, June 1, 5 and 12, 2001
 TEST SITE : IBM Yamato semi-anechoic chamber #2

A.1 Test Methodology

Both conducted and radiated testing were performed according to the procedures in ANSI C63.4-1992. Radiated testing was performed at an antenna to EUT distance of 3 meters.

A.2 Test Facility / NVLAP Accreditation

The semi-anechoic chamber #2 used to correct the data are located in Yamato Laboratory, IBM Japan.

- This facility has been fully described in a report dated September 1998, submitted to the FCC office, and accepted in a letter, dated Nov. 2,1998(31040/SIT).
- This facility is accepted by **Industry Canada** in a letter dated March 19, 2001 as number **IC 349E**.
- IBM Yamato EMC Engineering is recognized under the National Voluntary Laboratory Accreditation Program for satisfactory compliance with Criteria established in Title 15, Part 285 Code of Federal Regulations.(NVLAP Lab code: 200198-0)

A.3 EUT details

Table A EUT details

Model and S/N	FCC ID	Description	Cable Description
ThinkPad R30 M/T 2656-3Ax (s/n AA-G70KZ) M/T 2656-6Ax (s/n AA-G70K8)	ANOCH126P8056	IBM Notebook PC CPU: Intel Mobile Geyserville 900MHz LCD: 13” TFT XGA LCD: 14” TFT XGA	
P/N 02K6665	N/A	Universal AC adapter 72W	Unshielded power cord

B. SUMMARY OF TEST RESULTS

Table-B presents the list of the measurement items for Spread Spectrum, Direct Sequence devices under FCC Part 15 Subpart C and Industry Canada RSS-210.

The section numbers of upper portion are showing FCC number, and the other (lower) ones are for IC.

Table-B List of the measurements

Section(s)	Test Items		Condition	Result
	Transmit mode (TX):			
15.247(a)(2) 5.9.1	Bandwidth at 6 dB below		Conducted	Pass
15.247(c) 5.9.1 6.2.2 (o) (e1)	Occupied BW (or Band-edge) Out of Band Emissions (Bandwidth at 20 dB below)	The radiated emission in any 100KHz of outband shall be at least 20dB below the highest inband spectral density.	Conducted	Pass
15.247(b) 6.2.2 (o) (b)	Transmitter output power	Shall not exceed 1.0 W.	Conducted	Pass
15.247(d) 6.2.2 (o) (b)	Transmitter power spectral Density	Shall not be greater than 8 dBm in any 3KHz band.	Conducted	Pass
15.247(e) 6.2.2 (o) (b)	Processing gain	10 dB	Conducted	Pass*
15.207 6.6	AC Wireline Conducted Emissions 450kHz – 30MHz	Class B: 250uV	Conducted	Pass
15.205 / 209 6.2.1 / 6.3	General Field Strength Limits (Restricted Bands and Radiated Emission Limits)	Shall not exceed the limits specified in FCC 15.209 or RSS-210 Table3.	Radiated (30MHz - 1GHz)	Pass
			Radiated (1- 25GHz)	Pass
Receive mode (RX):				
15.207 7.4	AC Wireline Conducted Emissions 450kHz – 30MHz	Class B: 250uV	Conducted	Pass
15.209 7.3	General Field Strength Limits (Radiated Emission Limits)	Shall not exceed the limits specified in RSS-210.	Radiated (30MHz - 1GHz)	Pass
			Radiated (1- 25GHz)	Pass

* See “Processing Gain Report” by ActionTec

C. OPERATION MODE OF EUT

All tests were performed using the “PRISM Test Utility Program”, Version 3.0.24. Three kinds of modulation are used for transmission with appropriate bit rates:

Table C-1 Transmit mode (TX)

Operation Frequency [GHz]	Rated output power (conducted) [dBm]			Test performed*
	Bit rate 2Mbps	Bit rate 5.5Mbps	Bit rate 11Mbps	
2.412 (Ch. 1)	+15	+15	+15	X
2.417 (Ch. 2)	+15	+15	+15	
2.422 (Ch. 3)	+15	+15	+15	
2.427 (Ch. 4)	+15	+15	+15	
2.432 (Ch. 5)	+15	+15	+15	
2.437 (Ch. 6)	+15	+15	+15	X
2.442 (Ch. 7)	+15	+15	+15	
2.447 (Ch. 8)	+15	+15	+15	
2.452 (Ch. 9)	+15	+15	+15	
2.457 (Ch. 10)	+15	+15	+15	
2.462 (Ch. 11)	+15	+15	+15	X

* Full testing with bit rate 11Mbps only

Table C-2 Receive mode (RX)

Operation Frequency [GHz]	Test performed
2.412 (Ch. 1)	
2.417 (Ch. 2)	
2.422 (Ch. 3)	
2.427 (Ch. 4)	
2.432 (Ch. 5)	
2.437 (Ch. 6)	X
2.442 (Ch. 7)	
2.447 (Ch. 8)	
2.452 (Ch. 9)	
2.457 (Ch. 10)	
2.462 (Ch. 11)	

D. TEST INSTRUMENTS

Table-D List of Measuring Instruments

Description	Model	Serial Number	Calibration Date	Calibration Interval
Computer	IBM 5551-L	#4	N/A	N/A
Computer	IBM 6589-13J	97-15613	N/A	N/A
Spectrum Analyzer (100Hz-1.5GHz)	HP 85680B	2732A03651	01/16/01	1 year
Spectrum Analyzer (100Hz-1.5GHz)	HP 85680B	3019A05155	02/07/01	1 year
Spectrum Analyzer (100Hz-1.5GHz)	HP 85680B	3019A05156	04/02/01	1 year
Spectrum Analyzer Display	HP 85662A	2648A15255	01/16/01	1 year
Spectrum Analyzer Display	HP 85662A	3026A19353	02/07/01	1 year
Spectrum Analyzer Display	HP 85662A	3026A19366	04/02/01	1 year
Quasi-Peak Adapter	HP 85650A	2521A00968	01/16/01	1 year
Quasi-Peak Adapter	HP 85650A	3033A01449	02/07/01	1 year
Quasi-Peak Adapter	HP 85650A	2811A01433	04/02/01	1 year
Amplifier (100KHz - 1.3GHz) - for 30-200MHz - for 200-1000MHz	HP 8447D HP 8447D	2805A02919 2944A03506	04/16/01 04/16/01	1 year 1 year
Amplifier (1GHz - 26.5GHz)	HP 8449B	3008A00582	05/23/01	1 year
Spectrum Analyzer EMI Test Receiver	R&S ESI26	836119/003	07/12/00	1 year
Receiver (9kHz-30MHz)	R&S ESH3	891806/012	09/11/00	1 year
Receiver (20MHz-1.3GHz)	R&S ESVP	893202/018	01/29/01	1 year
Biconical Antenna (30-200MHz)	EMCO 3108	2400	06/09/00	1 year
Log-Periodic Antenna (200-1000MHz)	EMCO 3146	2150	06/06/00	1 year
Horn Antenna (1- 18GHz)	EMCO 3115	6121	04/16/01	1 year
Horn Antenna (3.95- 5.85GHz)	EMCO 3160-5	1102	01/23/01	1 year
Horn Antenna (5.85- 8.20GHz)	EMCO 3160-6	1067	01/09/01	1 year
Horn Antenna (18- 26.5GHz)	EMCO 3160-9	1202	04/16/01	1 year
LISN	EMCO 3825/2	1426	09/01/00	1 year
Signal Generator	HP E4432B	GB38450342	09/07/00	1 year
Power Meter	HP 436A	2604A24191	12/12/00	1 year
Power Sensor	HP 8482A	2607A11105	12/13/00	1 year
Switch/control unit	HP 3488A	2719A17226 2719A17228	N/A N/A	N/A N/A
Plotter	HP 7550A	2631A33619	N/A	N/A
SF106 cables: - Horn Ant <=> RF Amp. - RF Amp.<=>Spectrum Analyzer	Length: 6 m 15m	- EM206SCO - EM215SCO	08/10/00 08/10/00	1 year 1 year

N-Coax cables:				
- Bi-coni Ant <=> 10m Cable	9 m	- EM203L01	04/16/01	1 year
- 10m Cable <=> Shield Panel	10 m	- EM203L02	04/16/01	1 year
- Shield Panel <=> RF Amp	7 m	- EM203L03	04/16/01	1 year
- RF Amp <=> Power Splitter	0.5m	- EM203L04	04/16/01	1 year
- Log-peri Ant <=> 10m Cable	9 m	- EM203H01	04/16/01	1 year
- 10m Cable <=> Shield Panel	10 m	- EM203H02	04/16/01	1 year
- Shield Panel <=> RF Amp	7 m	- EM203H03	04/16/01	1 year
- RF Amp <=> Power Splitter	0.5m	- EM203H04	04/16/01	1 year
Coax cables:				
- Lism-L <=> SW/Con.unit (SW100)	4 m	- EMIC-L	04/16/01	1 year
- Lism-N <=> SW/Con.unit (SW101)	4 m	- EMIC-N	04/16/01	1 year
- SW/Con.unit <=> RCVR (Input)	1 m	- EMIC-R	04/16/01	1 year
- SW/Con.unit <=> Spe Ana.(Signal In)	1 m	- EMIC-S	04/16/01	1 year
- Power Splitter <=> SW/Con.unit (SW110)	1 m	- EM203L05	04/16/01	1 year
- Power Splitter <=> SW/Con.unit (SW300)	1 m	- EM203L06	04/16/01	1 year
- Power Splitter <=> SW/Con.unit (SW100)	1 m	- EM203H05	04/16/01	1 year
- Power Splitter <=> SW/Con.unit (SW301)	1 m	- EM203H06	04/16/01	1 year
- SW/Con.unit <=> Receiver (Input)	2 m	- EM2RCV	04/16/01	1 year
- SW/Con.unit <=> Spe Ana.(Signal In) for 30- 200MHz	2 m	- EM2SPL	04/16/01	1 year
- SW/Con.unit <=> Spe Ana.(Signal In) for 200-1000MHz	2 m	- EM2SPH	04/16/01	1 year

Notes.

- The above equipment calibration is traceable to National standards.
- HP: Hewlett Packard, R&S: Rohde & Schwarz

1. Bandwidth at 6 dB below

1.1 Test Procedure

The bandwidth at 6 dB down from the highest inband spectral density is measured with a spectrum analyzer connected to the antenna terminal, while EUT is operating in transmission mode at the appropriate center frequency.

The spectrum analyzer is set to :

RBW=100KHz, VBW=100KHz*1, Span=30MHz, Sweep=suitable duration based on the EUT specification

*1: To be adjusted accordingly based on the spectrum stability

1.2 Test Instruments and Measurement Setup

Table 1-1: 6 dB Bandwidth Test Instruments

Description	Model	Serial Number
Spectrum Analyzer EMI Test Receiver	R&S ESI26	836119/003
Coax cables: - Spectrum Analyzer <=> EUT	Length: 120 cm Loss: 1.7 dB	

Notes: - R&S: Rohde & Schwarz

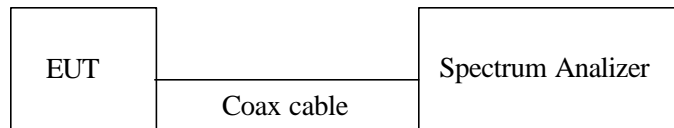

Figure 1: Measurement setup for 6dB bandwidth test

1.3 Measurement Results

Test Date: June 12, 2001

Table 1-2. EUT: M/T 2656-3Ax, s/n AA-G70KZ , TX mode 11Mbps

Center Frequency (MHz)	Lower frequency (MHz)	Upper frequency (MHz)	Bandwidth at 6 dB below (MHz)
2412 (ch. 1)	2407.46	2417.56	10.10
2437 (ch. 6)	2432.46	2442.56	10.10
2462 (ch. 11)	2457.40	2467.56	10.16

1.4 Trace Data



Ref Lvl	Marker 1 [T1]	RBW	100 kHz	RF Att	40 dB
30 dBm	1.79 dBm	VBW	100 kHz		
	2.41251102 GHz	SWT	7.5 ms	Unit	dBm

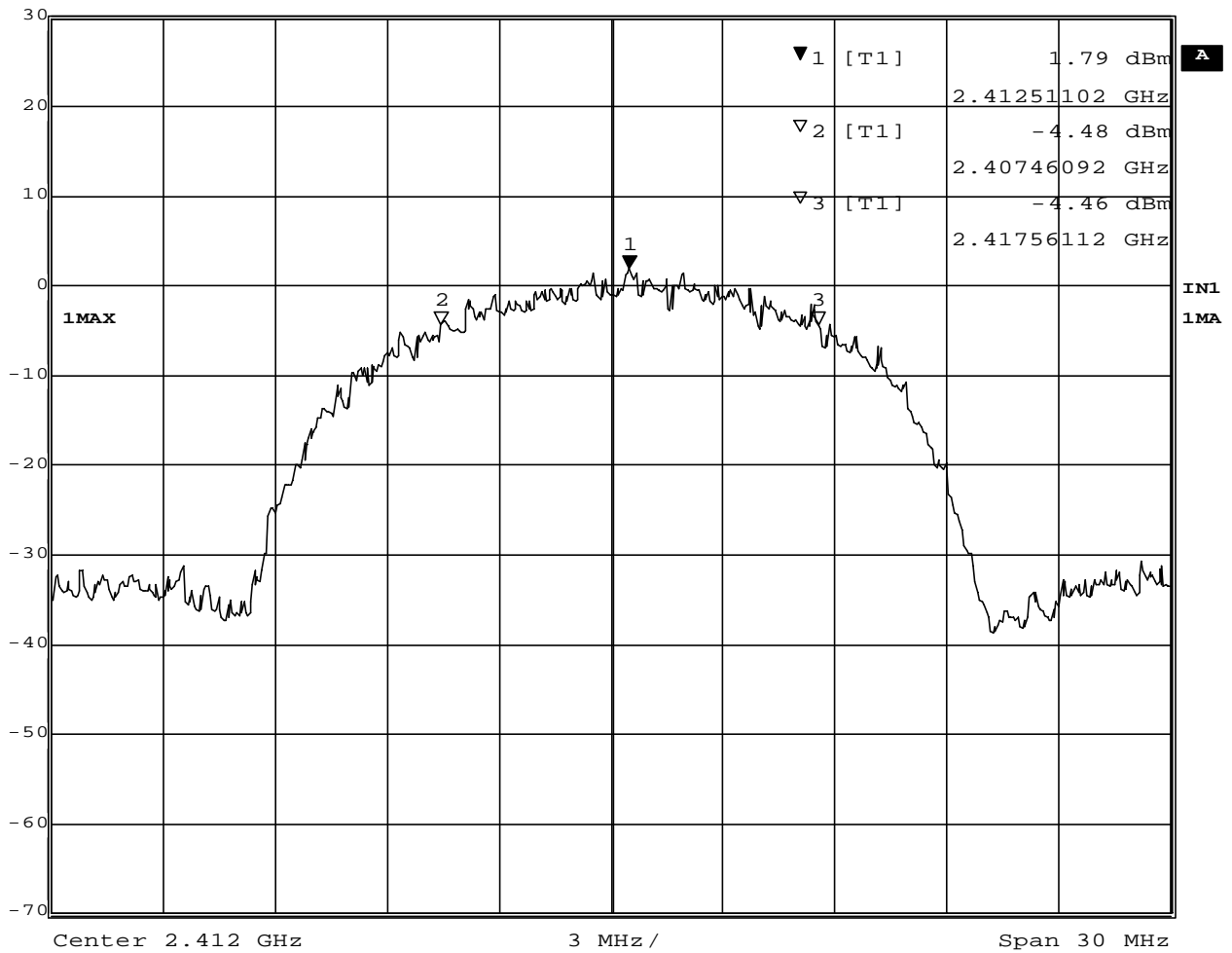

Date: 12.JUN.2001 19:46:39



Marker 1 [T1] RBW 100 kHz RF Att 40 dB
 Ref Lvl 1.79 dBm VBW 100 kHz
 30 dBm 2.43751102 GHz SWT 7.5 ms Unit dBm

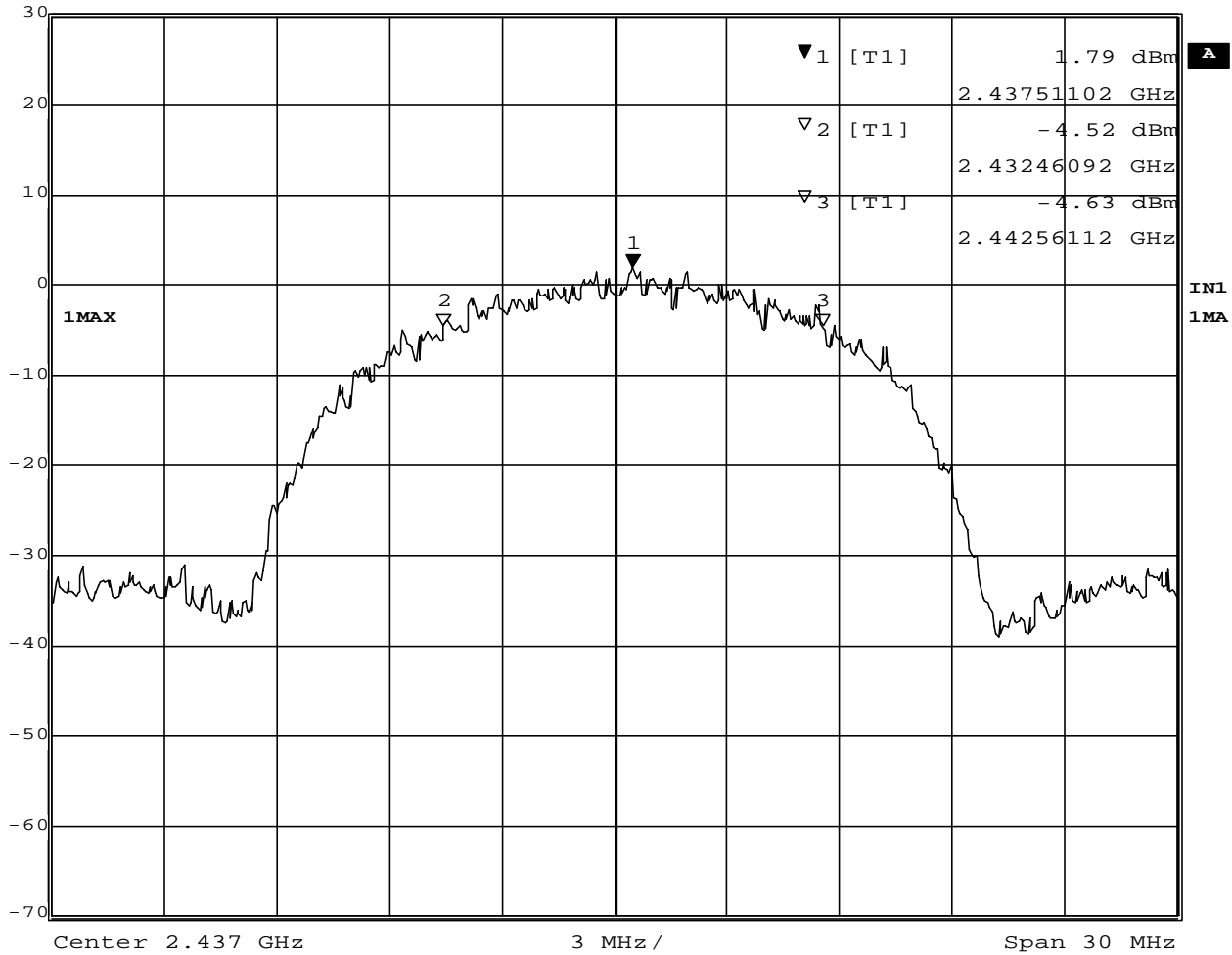

Date: 12.JUN.2001 19:49:22



Marker 1 [T1] RBW 100 kHz RF Att 40 dB
 Ref Lvl 1.74 dBm VBW 100 kHz
 30 dBm 2.46251102 GHz SWT 7.5 ms Unit dBm

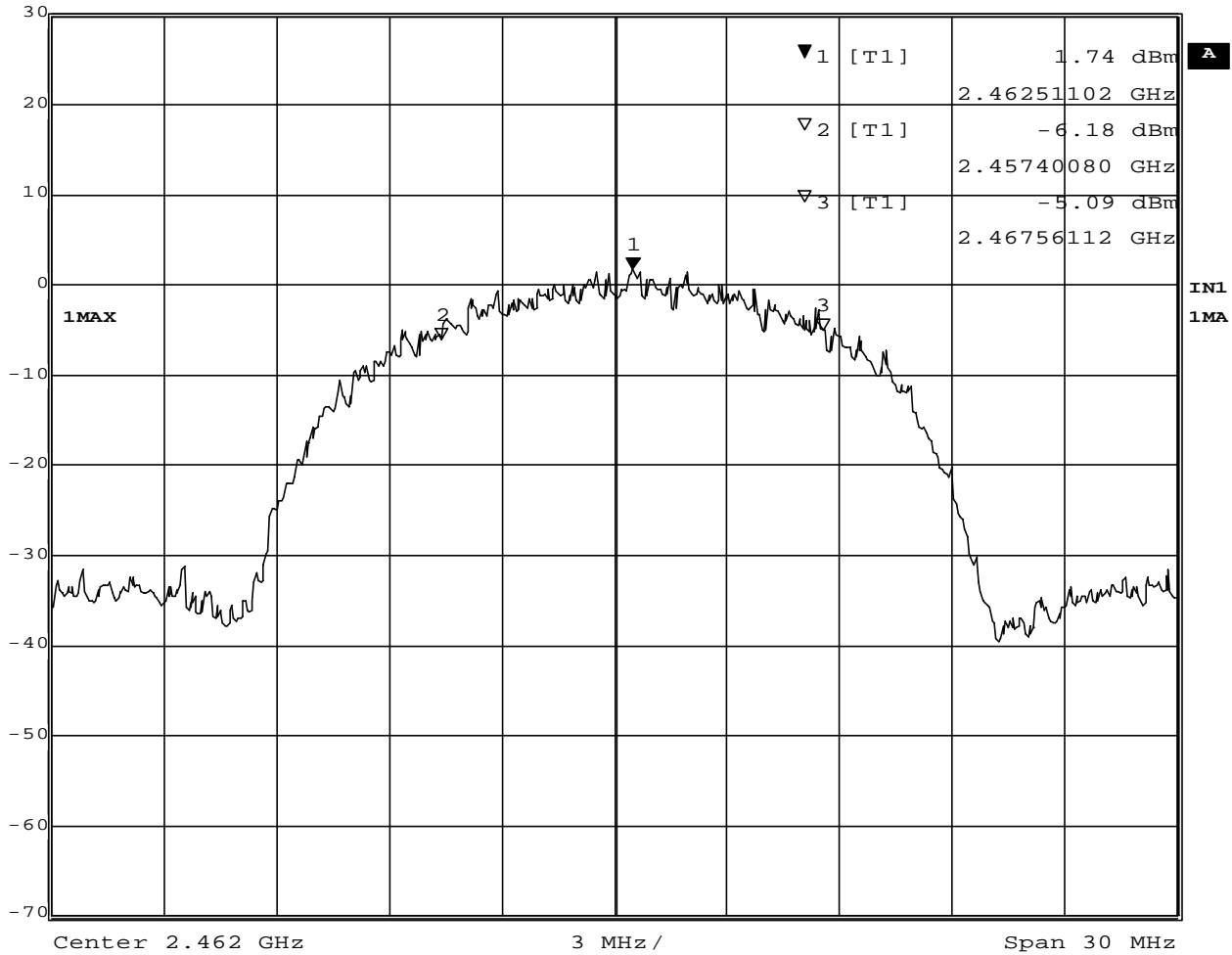

Date: 12.JUN.2001 19:43:21

2. Occupied Bandwidth / Band-edge (at 20 dB below), and Out of Band Emissions

2.1 Test Procedure

The bandwidth at 20 dB down from the highest inband spectral density is measured with a spectrum analyzer connected to the antenna terminal, while EUT is operating in transmission mode at the appropriate center frequency.

The spectrum analyzer is set to :

RBW=100KHz, VBW=100KHz*1, Span=30MHz, Sweep=suitable duration based on the EUT specification

*1: To be adjusted accordingly based on the spectrum stability

2.2 Test Instruments and Measurement Setup

Same as the Chapter 1(Table 1-1 & Figure 1).

2.3 Measurement Results of Occupied Bandwidth / Band-edge

Test Date: June 12, 2001

Table 2-1. EUT: M/T 2656-3Ax, s/n AA-G70KZ , TX mode 11Mbps

Center Frequency (MHz)	Lower Frequency (MHz)	Upper Frequency (MHz)	Bandwidth at 20 dB below (MHz)	Margin to Lower limit (MHz)	Margin to Upper limit (MHz)
2412 (ch. 1)	2403.73	2420.69	16.96	3.73	
2437 (ch. 6)	2428.73	2445.69	16.96		
2462 (ch. 11)	2453.73	2470.57	16.84		12.93

2.4 Measurement Results of Out of Band Emissions

All conducted emission in any 100kHz bandwidth outside of the spread spectrum band was at least 20dB lower than the highest inband spectral density.

Test Date: June 12, 2001

2.5 Trace Data of Band-edge



Ref Lvl	Marker 1 [T1]	RBW	100 kHz	RF Att	40 dB
30 dBm	1.79 dBm	VBW	100 kHz		
	2.41251102 GHz	SWT	7.5 ms	Unit	dBm

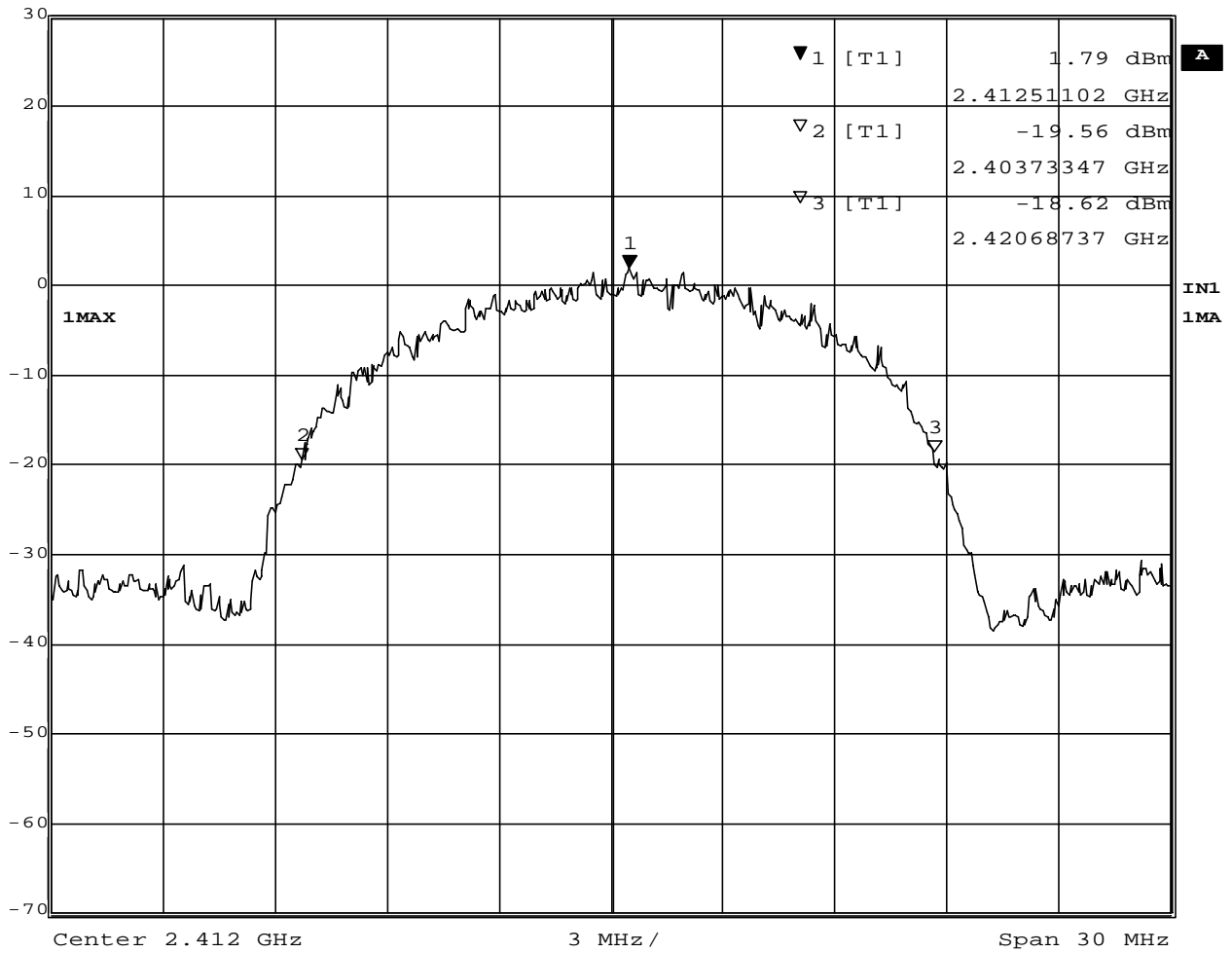

Date: 12.JUN.2001 19:47:32



Marker 1 [T1] RBW 100 kHz RF Att 40 dB
 Ref Lvl 1.79 dBm VBW 100 kHz
 30 dBm 2.43751102 GHz SWT 7.5 ms Unit dBm

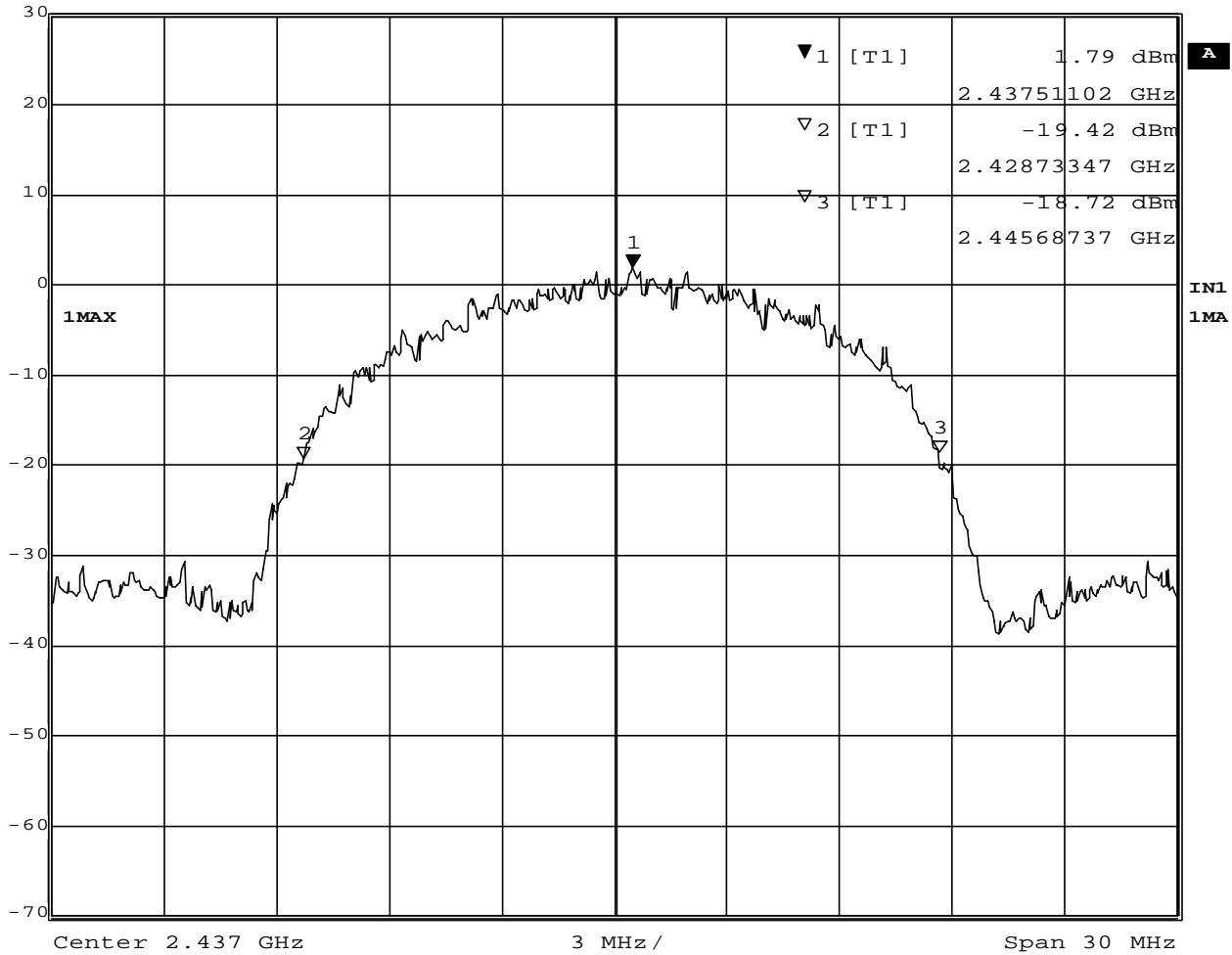

Date: 12.JUN.2001 19:50:45



Marker 1 [T1] RBW 100 kHz RF Att 40 dB
 Ref Lvl 1.74 dBm VBW 100 kHz
 30 dBm 2.46251102 GHz SWT 7.5 ms Unit dBm

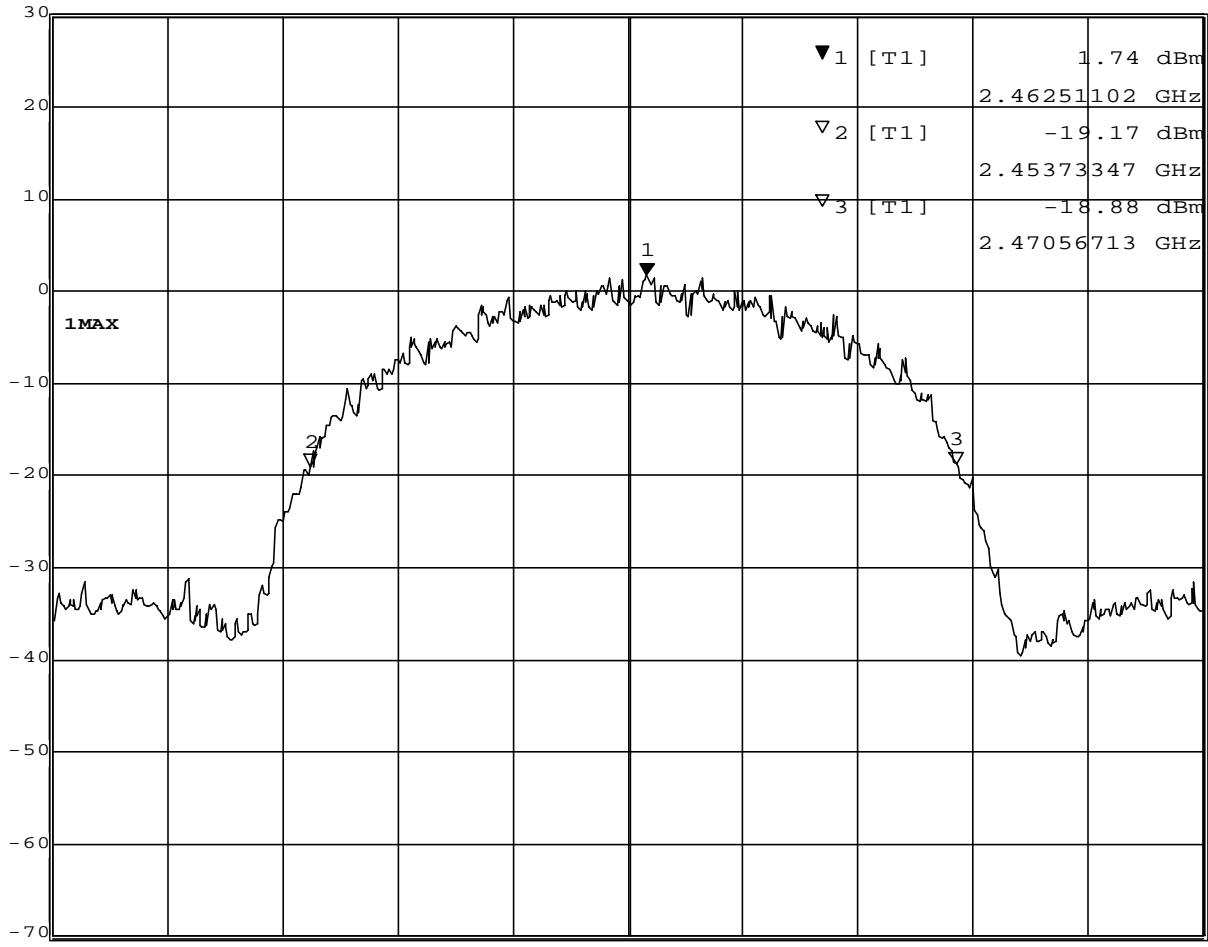

Center 2.462 GHz 3 MHz / Span 30 MHz

Date: 12.JUN.2001 19:44:42

2.6 Trace Data of Out of Band Emissions

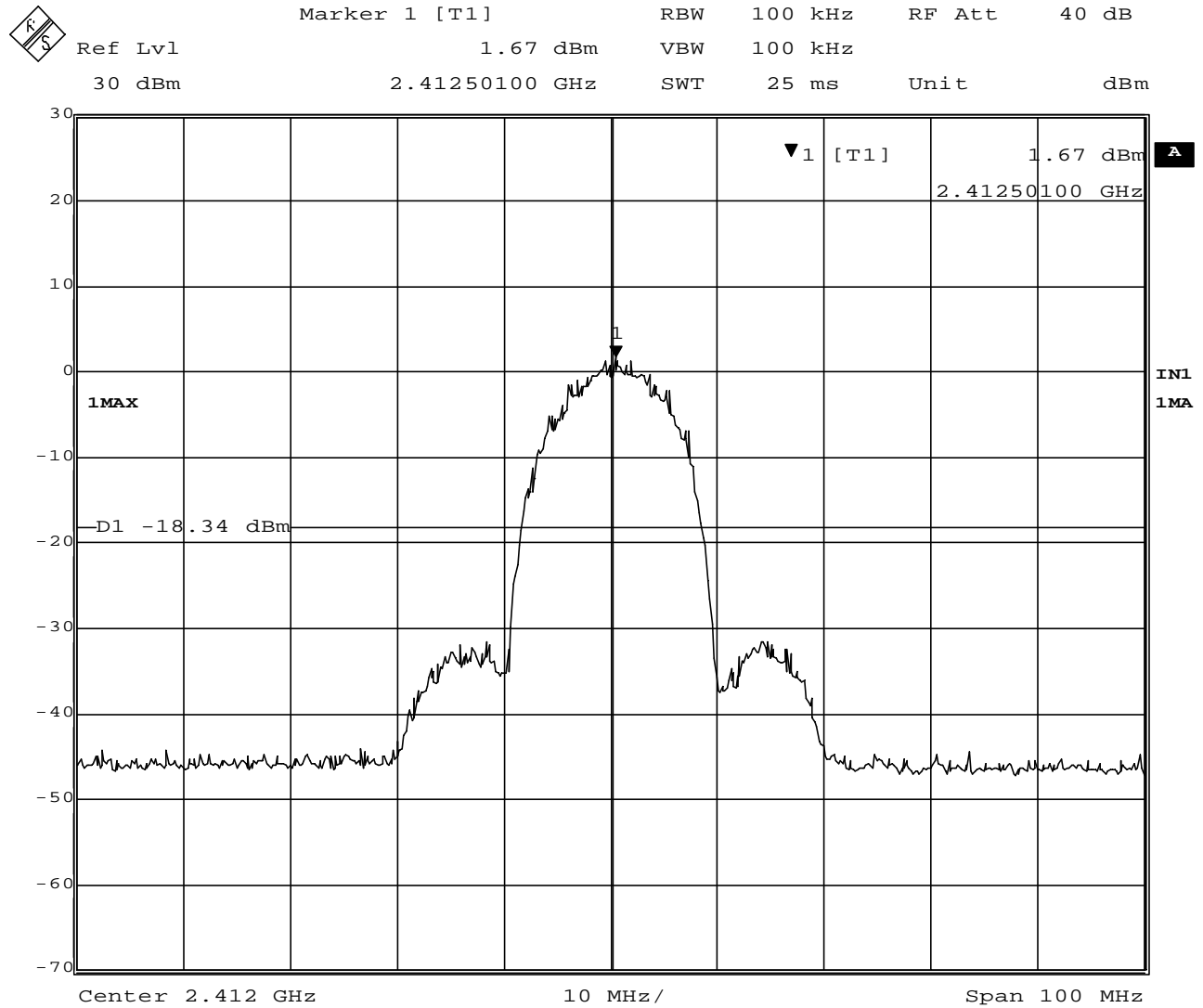

Date: 12.JUN.2001 19:52:37



	Marker 1 [T1]	RBW	100 kHz	RF Att	40 dB
Ref Lvl	1.69 dBm	VBW	100 kHz		
30 dBm	2.43750100 GHz	SWT	25 ms	Unit	dBm

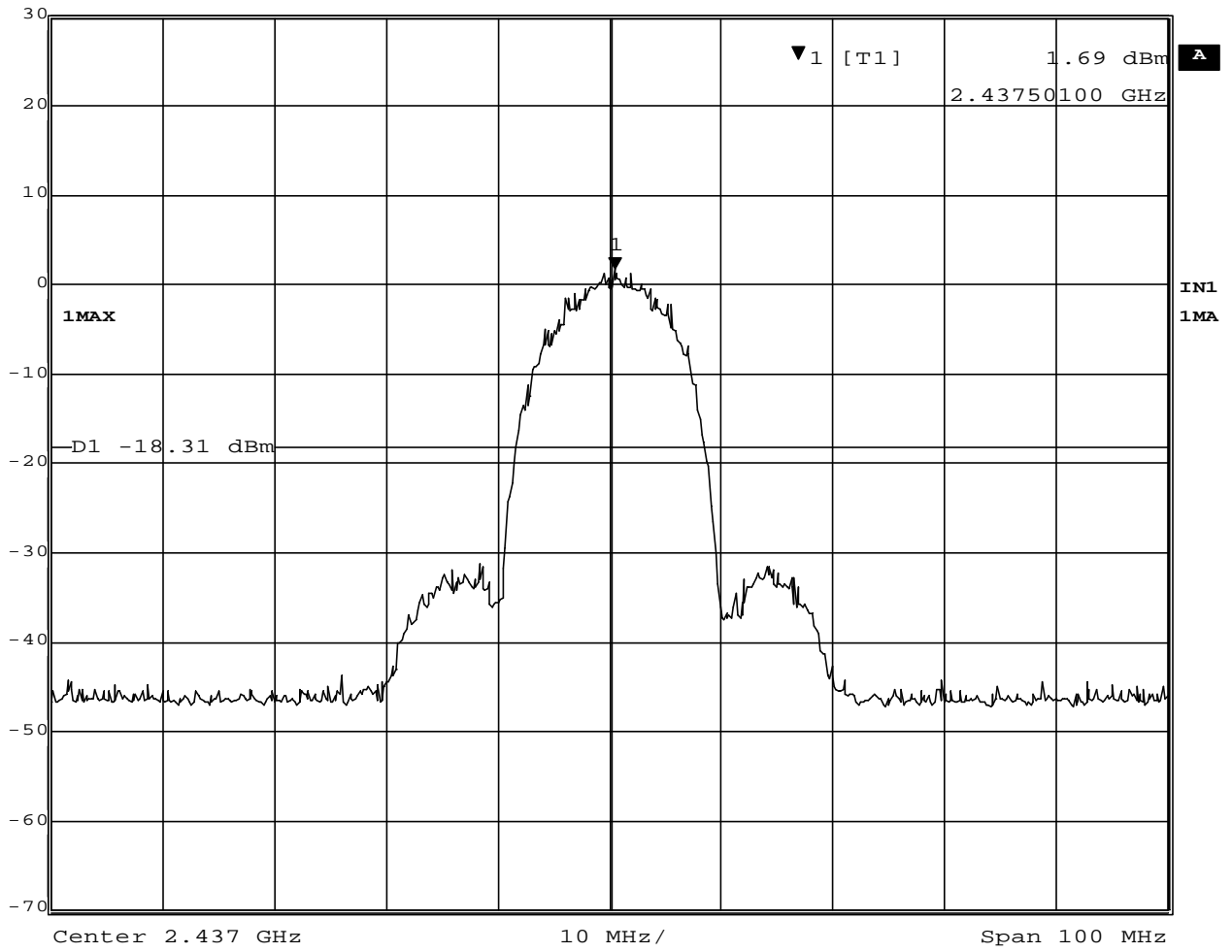

Date: 12.JUN.2001 19:53:26



Marker 1 [T1] RBW 100 kHz RF Att 40 dB
Ref Lvl 1.09 dBm VBW 100 kHz
30 dBm 2.46250100 GHz SWT 25 ms Unit dBm

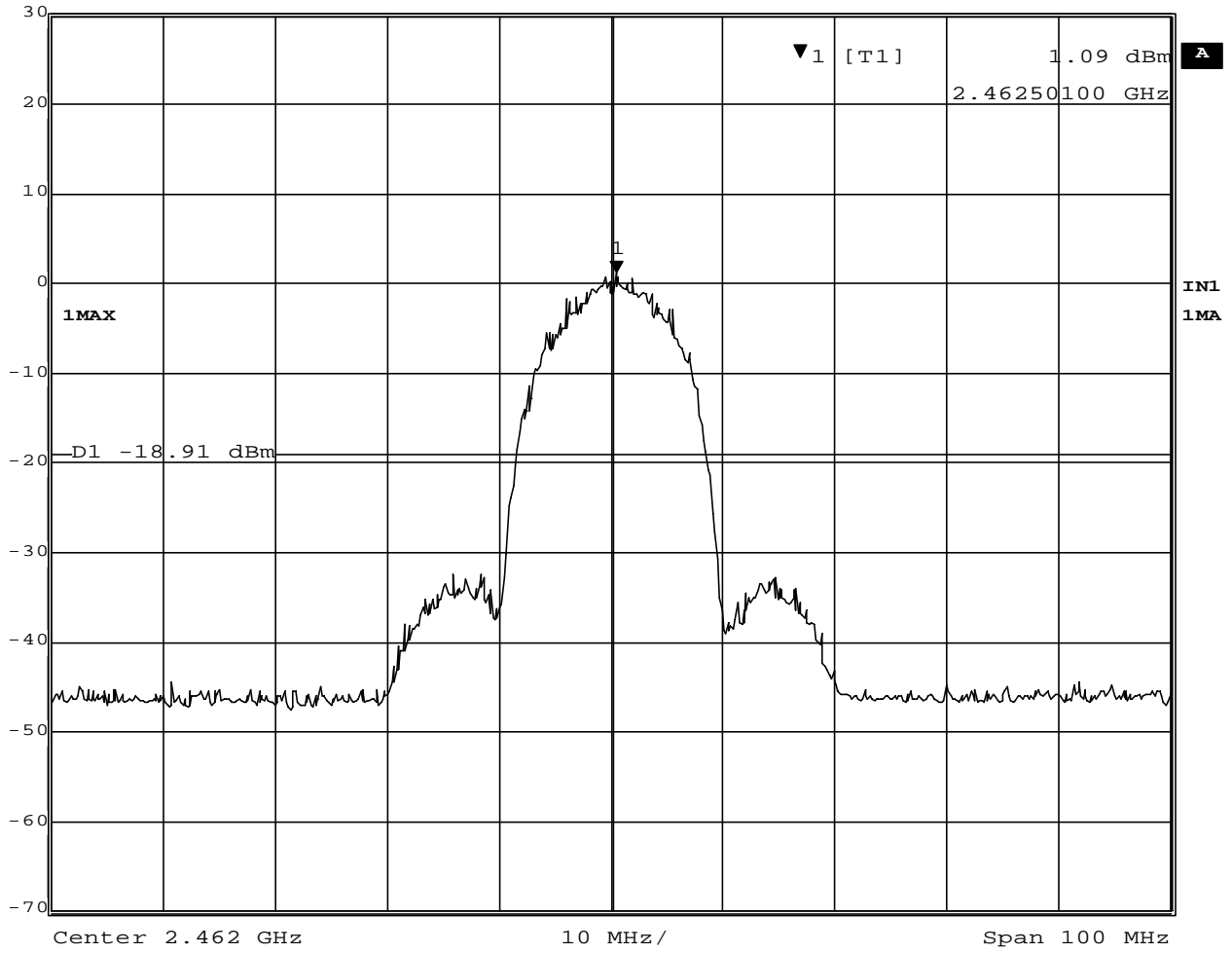

Date: 12.JUN.2001 19:54:23

3. Transmitter Output Power

3.1 Test Procedure

- A transmitter antenna terminal of EUT is connected to the input of a RF power sensor.
- Measurement is made while EUT is operating in transmission mode at the appropriate center frequency.

Table 3-1: 6 dB Bandwidth Test Instruments

Description	Model	Serial Number
Power Meter	HP 436A	2604A24191
Power Sensor	HP 8482A	2607A11105
Coax cables: - Power Sensor <=> EUT	Length: 30 cm Loss: 1.1dB	

Notes: - HP: Hewlett Packard

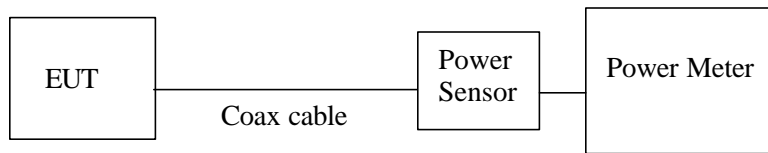

Figure 3: Measurement setup for RF output power

3.2 Measurement Results

Test Date: June 12, 2001

Table 3-2. EUT: M/T 2656-3Ax, s/n AA-G70KZ, TX mode 11Mbps

Measured Frequency (MHz)	Power Meter Reading (dBm)	Cable Loss (dB)	Results		Limit [1W] (dBm)	Margin (dB)
			(dBm)	(W)		
2412 (ch. 1)	13.2	1.1	14.3	0.0269	30.0	15.7
2437 (ch. 6)	13.1	1.1	14.2	0.0263	30.0	15.8
2462 (ch. 11)	12.6	1.1	13.7	0.0234	30.0	16.3

Table 3-3. EUT: M/T 2656-3Ax, s/n AA-G70KZ, TX mode 2Mbps

Measured Frequency (MHz)	Power Meter Reading (dBm)	Cable Loss (dB)	Results		Limit [1W] (dBm)	Margin (dB)
			(dBm)	(W)		
2412 (ch. 1)	13.2	1.1	14.3	0.0269	30.0	15.7
2437 (ch. 6)	13.0	1.1	14.1	0.0257	30.0	15.9
2462 (ch. 11)	12.5	1.1	13.6	0.0229	30.0	16.4

4. Transmitter Power Spectral Density

4.1 Test Procedure

The peak power density is measured with a spectrum analyzer connected to the antenna terminal, while EUT is operating in transmission mode at the appropriate center frequency.

The spectrum analyzer is set to:

RBW= 3KHz, VBW=100KHz, Span=10MHz, Sweep = 2.8 seconds

4.2 Test Instruments and Measurement Setup

Same as the Chapter 1(Table 1-1 & Figure 1).

4.3 Measurement Results

Test Date: June 12, 2001

Table 4-1. EUT: M/T 2656-3Ax, s/n AA-G70KZ , TX mode 11Mbps

Ch No.	Frequency (MHz)	Spectrum Analyzer Reading (dBm)	Cable loss (dB)	Result (dBm)	Limit (dBm)	Margin (dB)
1	2413.43	-10.8	1.7	-9.1	8.0	17.1
6	2437.67	-10.9	1.7	-9.2	8.0	17.2
11	2462.67	-11.5	1.7	-9.8	8.0	17.8

4.4 Trace Data



	Marker 1 [T1]	RBW	3 kHz	RF Att	40 dB
Ref Lvl	-10.83 dBm	VBW	100 kHz		
30 dBm	2.41343287 GHz	SWT	2.8 s	Unit	dBm

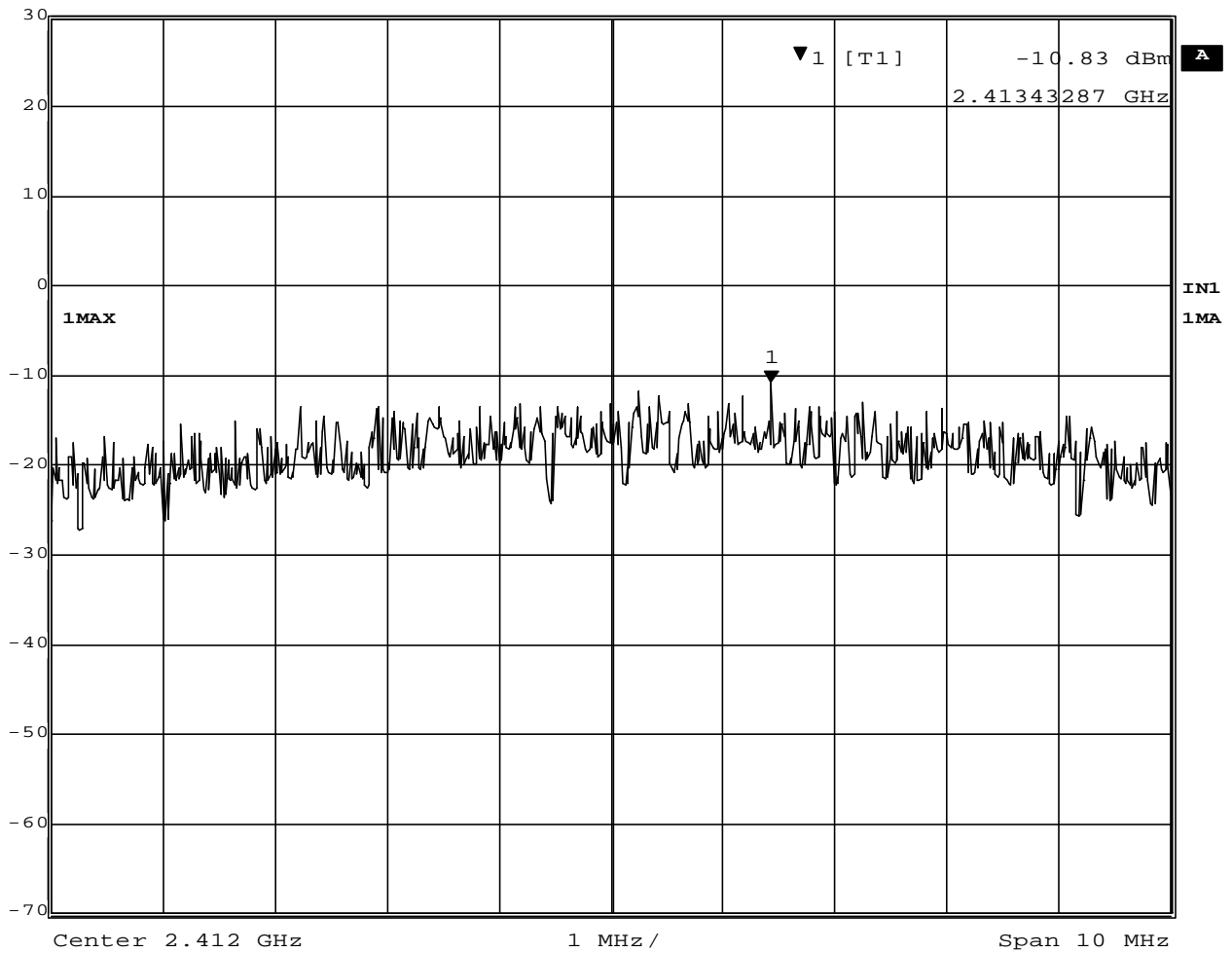

Date: 12.JUN.2001 19:56:21



Marker 1 [T1] RBW 3 kHz RF Att 40 dB
Ref Lvl -10.87 dBm VBW 100 kHz
30 dBm 2.43843287 GHz SWT 2.8 s Unit dBm

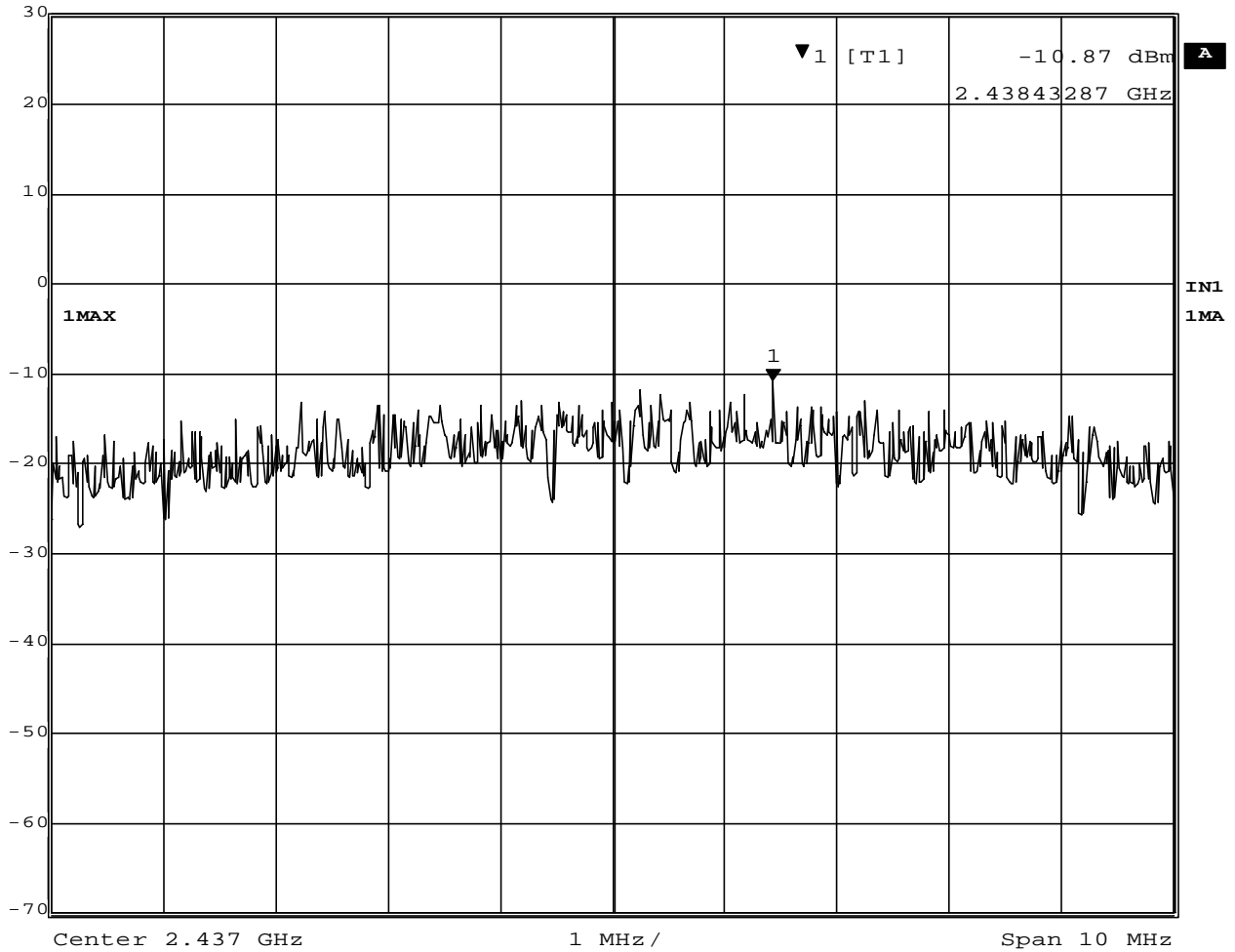

Date: 12.JUN.2001 19:57:27



Ref Lvl	30 dBm	Marker 1 [T1]	2.46343287 GHz	RBW	3 kHz	RF Att	40 dB	VBW	100 kHz	SWT	2.8 s	Unit	dBm
---------	--------	---------------	----------------	-----	-------	--------	-------	-----	---------	-----	-------	------	-----

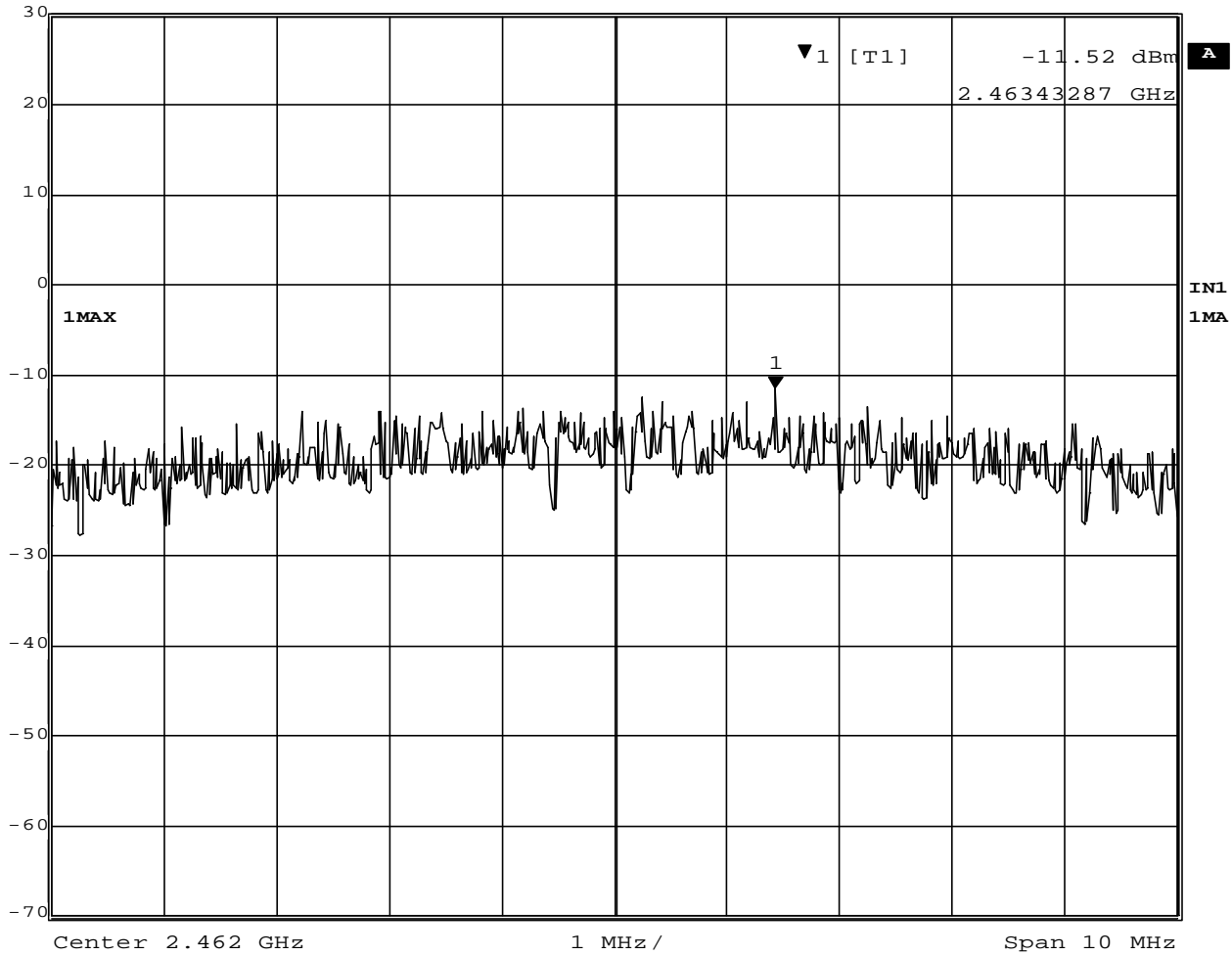

Date: 12.JUN.2001 19:58:10

5. AC WIRELINE CONDUCTED EMISSIONS (450KHz – 30MHz)

5.1 Test Procedure

The conducted emissions are measured in the IBM shielded room with a spectrum analyzer in peak hold. Emissions closest to the limit are measured in the quasi-peak mode (QP) with the tuned receiver using a bandwidth of 9KHz. The emissions are maximized further by cable manipulation. The highest emissions relative to the limit are listed.

5.2 Test Instruments and Measurement Setup

Table 5-1. Conducted Emission Test Instrumentation

Description	Model	Serial Number
Computer	IBM 6589-13J	97-15613
Spectrum Analyzer (100Hz-1.5GHz)	HP 8568B	2732A03651
Spectrum Analyzer Display	HP 8568B	2648A15255
Quasi-Peak Adapter	HP 85650A	2521A00968
Receiver (9kHz-30MHz)	R&S ESH3	891806/012
LISN	EMCO 3825/2	1426
Switch/control unit	HP 3488A	2719A17228
Plotter	HP 7550A	2631A33619
Coax cables: - Lisen-L <=> SW/Con.unit (SW100) - Lisen-N <=> SW/Con.unit (SW101) - SW/Con.unit <=> RCVR (Input) - SW/Con.unit<=> Spe Ana.(Signal In)	Length: 4 m 4 m 1 m 1 m	- EMIC-L - EMIC-N - EMIC-R - EMIC-S

Notes: - HP: Hewlett Packard, R&S: Rohde & Schwarz

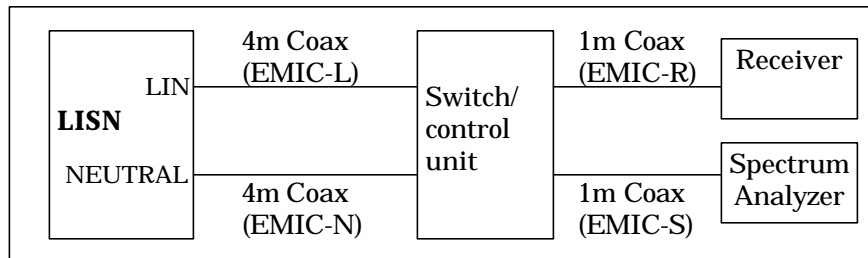

Figure 5. Cables for Conducted Emission Test

5.3 Measurement Results

The EUT was found to comply to the limits of FCC Part 15 Subpart C and RSS-210 with a margin of 8.2 dB. The 6 highest emissions relative to the limits are reported.

Test Date: June 5, 2001

1) EUT in transmission mode

Table 5-2-1. EUT: M/T 2656-3Ax, s/n AA-G70KZ, Ch.1(2412MHz) TX mode 11Mbps

Frequency (MHz)	QP Voltage (dB μ V)	QP Limit (dB μ V)	QP Voltage (μ V)	QP Limit (μ V)	Phase
0.5367	38.1	48	80.4	250	Line
0.5954	35.7	48	61.0	250	Line
0.6601	29.5	48	29.9	250	Line
0.7404	29.4	48	29.5	250	Line
0.9898	28	48	25.1	250	Line
1.0733	25.8	48	19.5	250	Line

Table 5-2-2. EUT: M/T 2656-3Ax, s/n AA-G70KZ , Ch.6(2437MHz) TX mode 11Mbps

Frequency (MHz)	QP Voltage (dB μ V)	QP Limit (dB μ V)	QP Voltage (μ V)	QP Limit (μ V)	Phase
0.5358	39.5	48	94.4	250	Line
0.5917	35.8	48	61.7	250	Line
0.6508	31.2	48	36.3	250	Line
0.7399	30.1	48	32.0	250	Line
1.4489	23.5	48	15.0	250	Line
23.2543	25.6	48	19.1	250	Line

Table 5-2-3. EUT: M/T 2656-3Ax, s/n AA-G70KZ, Ch.11(2462MHz) TX mode 11Mbps

Frequency (MHz)	QP Voltage (dB μ V)	QP Limit (dB μ V)	QP Voltage (μ V)	QP Limit (μ V)	Phase
0.5361	39.8	48	97.7	250	Line
0.5871	37.5	48	75.0	250	Line
0.6679	30.5	48	33.5	250	Line
0.7372	31	48	35.5	250	Line
0.9767	28.1	48	25.4	250	Line
22.9833	24.8	48	17.4	250	Line

2) EUT in receiving mode

Table 5-2-4. EUT: M/T 2656-3Ax, s/n AA-G70KZ, RX mode

Frequency (MHz)	QP Voltage (dB μ V)	QP Limit (dB μ V)	QP Voltage (μ V)	QP Limit (μ V)	Phase
0.5356	39.5	48	94.4	250	Line
0.5872	38.1	48	80.4	250	Line
0.6606	30.4	48	33.1	250	Line
0.7353	30.7	48	34.3	250	Line
0.9883	27.4	48	23.4	250	Line
22.2568	23.7	48	15.3	250	Line

6. RESTRICTED BANDS RADIATIONS (30MHz – 1GHz)

6.1 Test Procedure

Preliminary radiated emissions are measured in the semi-anechoic chamber at a 3 meter distance on every azimuth in both horizontal and vertical polarity. The antennas are also scanned in height. The emissions are recorded with a spectrum analyzer in peak hold mode. The identified emissions are further maximized by a cable manipulation. Emissions closest to the limits are measured in the quasi-peak mode with the tuned receiver using a bandwidth of 120kHz. The highest emissions relative to the limit are listed.

6.2 Test Instruments and Measurement Setup

Table 6-1 Radiated Emission Test Instrumentation

Description	Model	Serial Number
Computer	IBM 5551-L	#4
Spectrum Analyzer (100Hz-1.5GHz) for 30-200MHz	HP 85680B	3019A05155
Spectrum Analyzer Display for 30-200MHz	HP 85662A	3026A19353
Quasi-Peak Adapter for 30-200MHz	HP 85650A	3033A01449
Spectrum Analyzer (100Hz-1.5GHz) for 200-1000MHz	HP 85680B	3019A05156
Spectrum Analyzer Display for 200-1000MHz	HP 85662A	3026A19366
Quasi-Peak Adapter for 200-1000MHz	HP 85650A	2811A01433
Amplifier (100KHz-1.3GHz)		
- for 30-200MHz	HP 8447D	2805A02919
- for 200-1000MHz	HP 8447D	2944A03506
Biconical Antenna (30-200MHz)	EMCO 3108	2400
Log-Periodic Antenna (200-1000MHz)	EMCO 3146	2150
Receiver (20MHz-1.3GHz)	R&S ESVP	893202/018
Switch/control unit	HP 3488A	2719A17226
N-Coax cables:	Length:	
- Bi-coni Ant <=> 10m Cable	9 m	- EM203L01
- 10m Cable <=> Shield Panel	10 m	- EM203L02
- Shield Panel <=> RF Amp	7 m	- EM203L03
- RF Amp <=> Power Splitter	0.5m	- EM203L04
- Log-peri Ant <=> 10m Cable	9 m	- EM203H01
- 10m Cable <=> Shield Panel	10 m	- EM203H02
- Shield Panel <=> RF Amp	7 m	- EM203H03
- RF Amp <=> Power Splitter	0.5m	- EM203H04
Coax cables:		
- Power Splitter <=> SW/Con.unit (SW110)	1 m	- EM203L05

- Power Splitter <=> SW/Con.unit (SW300)	1 m	- EM203L06
- Power Splitter <=> SW/Con.unit (SW100)	1 m	- EM203H05
- Power Splitter <=> SW/Con.unit (SW301)	1 m	- EM203H06
- SW/Con.unit <=> Receiver (Input)	2 m	- EM2RCV
- SW/Con.unit <=> Spe Ana.(Signal In) for 30- 200MHz	2 m	- EM2SPL
- SW/Con.unit <=> Spe Ana.(Signal In) for 200-1000MHz	2 m	- EM2SPH

Notes:

- HP: Hewlett Packard, R&S: Rohde & Schwarz

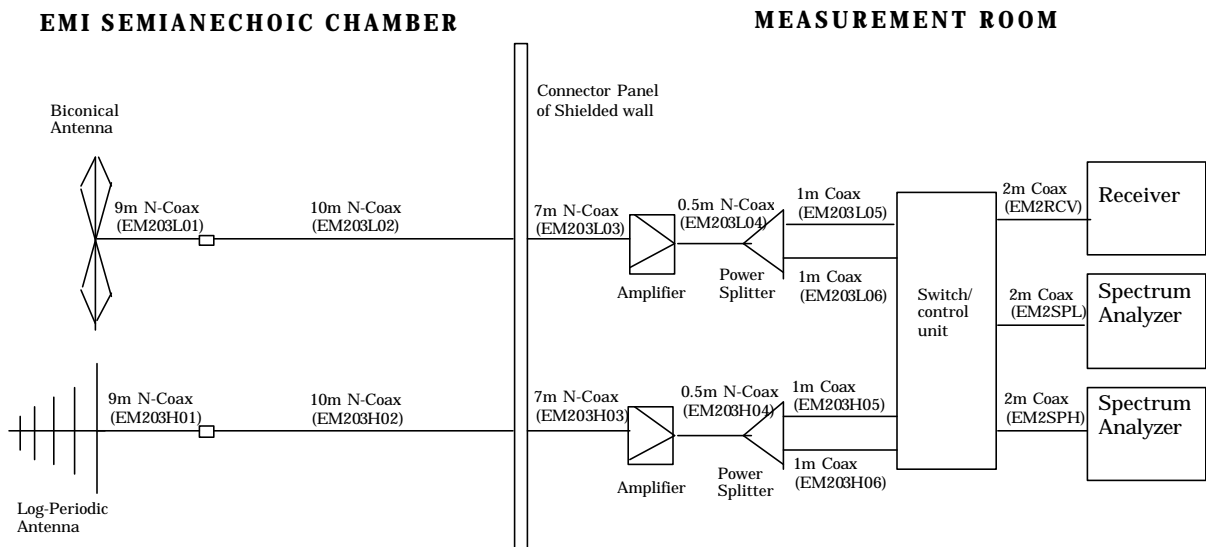

Figure 6 Cables for Radiated Emission Test

6.3 Field Strength Calculation

The field strength is calculated by adding the Antenna Factor and Cable Loss, and subtracting Amplifier Gain from the measured reading. In this test facility, the Antenna Factor, Cable Loss, and Amplifier Gains are loaded into the Rohde & Schwarz Receiver and the corrected field strength can be read directly on the receiver. All factors are included in the reported data.

$$FS = R + AF + CORR$$

where:

FS	=	Field Strength
R	=	Measured Receiver Input Amplitude
AF	=	Antenna Factor
CORR	=	Correction Factor = CL - AG
CL	=	Cable Loss
AG	=	Amplifier Gain

For example:

Given a Receiver input reading of 51.5dB μ V; Antenna Factor of 8.5dB/m; Cable Loss of 1.3dB; and an Amplifier Gain of 26dB. The Field Strength of the measured emission is:

$$FS = 51.5 + 8.5 + 1.3 - 26.0 = 35.3\text{dB}\mu\text{V/m}$$

Conversion between dB μ V/m (or dB μ V) and μ V/m (or μ V) are done as:

$$\text{Level}(\text{dB}\mu\text{V/m}) = 20 \times \text{Log}(\text{Level}(\mu\text{V/m}))$$

$$40\text{dB}\mu\text{V/m} = 100\mu\text{V/m}$$

$$48\text{dB}\mu\text{V/m} = 250\mu\text{V/m}$$

6.4 Measurement Results

The EUT was found to comply to the limits of FCC Part 15 Subpart C and RSS-210 with a margin of 1.2 dB at 30MHz - 1000MHz band.

The 6 highest emissions relative to the limits are reported.

Test Date: May 29, 2001

1) EUT in transmission mode

- EUT: M/T 2656-3Ax (13" TFT model)

Table 6-2-1. EUT: M/T 2656-3Ax, s/n AA-G70KZ, Ch.1(2412MHz) TX mode 11Mbps

Frequency (MHz)	Polarity (H/V)	Measured (dB μ V)	Antenna Factor (dB/m)	Corr. Factor (dB)	Field Strength (dB μ V/m)	Limit (dB μ V/m)	Field Strength (μ V/m)	Limit (μ V/m)
395.998	V	37.0	15.2	-14.8	37.4	46.0	74.1	200
432.057	V	34.8	15.8	-14.7	35.9	46.0	62.4	200
450.999	V	33.3	16.5	-15.0	34.8	46.0	55.0	200
497.016	V	35.2	17.5	-14.9	37.8	46.0	77.6	200
898.789	V	33.6	22.6	-11.9	44.3	46.0	164.1	200
914.541	V	26.2	22.8	-11.6	37.4	46.0	74.1	200

Table 6-2-2. EUT: M/T 2656-3Ax, s/n AA-G70KZ, Ch.6(2437MHz) TX mode 11Mbps

Frequency (MHz)	Polarity (H/V)	Measured (dB μ V)	Antenna Factor (dB/m)	Corr. Factor (dB)	Field Strength (dB μ V/m)	Limit (dB μ V/m)	Field Strength (μ V/m)	Limit (μ V/m)
395.999	V	37.0	15.2	-14.8	37.4	46.0	74.1	200
432.056	V	34.7	15.8	-14.7	35.8	46.0	61.7	200
450.998	V	33.2	16.5	-15.0	34.7	46.0	54.3	200
497.247	V	34.2	17.5	-14.9	36.8	46.0	69.2	200
898.815	V	34.1	22.6	-11.9	44.8	46.0	173.8	200
914.542	V	26.0	22.8	-11.6	37.2	46.0	72.4	200

Table 6-2-3. EUT: M/T 2656-3Ax, s/n AA-G70KZ, Ch.11(2462MHz) TX mode 11Mbps

Frequency (MHz)	Polarity (H/V)	Measured (dB μ V)	Antenna Factor (dB/m)	Corr. Factor (dB)	Field Strength (dB μ V/m)	Limit (dB μ V/m)	Field Strength (μ V/m)	Limit (μ V/m)
395.999	V	36.5	15.2	-14.8	36.9	46.0	70.0	200
428.999	V	34.9	15.7	-15.0	35.6	46.0	60.3	200
450.999	V	32.9	16.5	-15.0	34.4	46.0	52.5	200
496.985	V	36.0	17.5	-14.9	38.6	46.0	85.1	200
898.835	V	31.9	22.6	-11.9	42.6	46.0	134.9	200
914.542	V	26.1	22.8	-11.6	37.3	46.0	73.3	200

- EUT: M/T 2656-6Ax (14" TFT model)

Table 6-3-1. EUT: M/T 2656-6Ax, s/n AA-G70K8, Ch.1(2412MHz) TX mode 11Mbps

Frequency (MHz)	Polarity (H/V)	Measured (dB μ V)	Antenna Factor (dB/m)	Corr. Factor (dB)	Field Strength (dB μ V/m)	Limit (dB μ V/m)	Field Strength (μ V/m)	Limit (μ V/m)
391.946	V	38.7	15.1	-14.7	39.1	46.0	90.2	200
395.996	V	39.4	15.2	-14.8	39.8	46.0	97.7	200
497.010	V	35.4	17.5	-14.9	38.0	46.0	79.4	200
695.745	V	32.2	20.7	-13.8	39.1	46.0	90.2	200
881.877	V	29.1	22.7	-12.6	39.2	46.0	91.2	200
898.744	V	32.6	22.6	-11.9	43.3	46.0	146.2	200

Table 6-3-2. EUT: M/T 2656-6Ax, s/n AA-G70K8, Ch.6(2437MHz) TX mode 11Mbps

Frequency (MHz)	Polarity (H/V)	Measured (dB μ V)	Antenna Factor (dB/m)	Corr. Factor (dB)	Field Strength (dB μ V/m)	Limit (dB μ V/m)	Field Strength (μ V/m)	Limit (μ V/m)
391.945	V	38.7	15.1	-14.7	39.1	46.0	90.2	200
395.996	V	40.5	15.2	-14.8	40.9	46.0	110.9	200
695.739	V	32.7	20.7	-13.8	39.6	46.0	95.5	200
751.229	H	31.2	20.8	-13.6	38.4	46.0	83.2	200
881.877	V	28.5	22.7	-12.6	38.6	46.0	85.1	200
898.789	V	31.6	22.6	-11.9	42.3	46.0	130.3	200

Table 6-3-3. EUT: M/T 2656-6Ax, s/n AA-G70K8, Ch.11(2462MHz) TX mode 11Mbps

Frequency (MHz)	Polarity (H/V)	Measured (dB μ V)	Antenna Factor (dB/m)	Corr. Factor (dB)	Field Strength (dB μ V/m)	Limit (dB μ V/m)	Field Strength (μ V/m)	Limit (μ V/m)
391.946	V	38.9	15.1	-14.7	39.3	46.0	92.3	200
395.996	V	39.6	15.2	-14.8	40.0	46.0	100.0	200
695.734	V	31.9	20.7	-13.8	38.8	46.0	87.1	200
751.228	H	31.6	20.8	-13.6	38.8	46.0	87.1	200
816.553	H	31.5	21.4	-13.0	39.9	46.0	98.9	200
898.465	V	33.0	22.6	-11.9	43.7	46.0	153.1	200

2) EUT in receiving mode

● EUT: M/T 2656-3Ax (13" TFT model)

Table 6-2-4. EUT: M/T 2656-3Ax, s/n AA-G70KZ, RX mode

Frequency (MHz)	Polarity (H/V)	Measured (dB μ V)	Antenna Factor (dB/m)	Corr. Factor (dB)	Field Strength (dB μ V/m)	Limit (dB μ V/m)	Field Strength (μ V/m)	Limit (μ V/m)
395.998	V	37.8	15.2	-14.8	38.2	46.0	81.3	200
440.000	V	37.1	16	-14.7	38.4	46.0	83.2	200
450.998	V	32.8	16.5	-15.0	34.3	46.0	51.9	200
497.385	V	34.2	17.5	-14.9	36.8	46.0	69.2	200
898.818	V	32.7	22.6	-11.9	43.4	46.0	147.9	200
912.121	V	23.4	22.8	-11.5	34.7	46.0	54.3	200

● EUT: M/T 2656-6Ax (14" TFT model)

Table 6-3-4. EUT: M/T 2656-6Ax, s/n AA-G70K8, RX mode

Frequency (MHz)	Polarity (H/V)	Measured (dB μ V)	Antenna Factor (dB/m)	Corr. Factor (dB)	Field Strength (dB μ V/m)	Limit (dB μ V/m)	Field Strength (μ V/m)	Limit (μ V/m)
391.945	V	39.1	15.1	-14.7	39.5	46.0	94.4	200
395.997	V	38.9	15.2	-14.8	39.3	46.0	92.3	200
751.228	H	31.3	20.8	-13.6	38.5	46.0	84.1	200
816.552	H	31.2	21.4	-13.0	39.6	46.0	95.5	200
881.877	V	28.1	22.7	-12.6	38.2	46.0	81.3	200
898.535	V	32.8	22.6	-11.9	43.5	46.0	149.6	200

7. RESTRICTED BANDS RADIATIONS (1GHz – 25GHz)

7.1 Test Procedure

Radiated emissions were measured in the frequency range with 1 GHz to 25GHz in transmitting mode and 1 GHz to 12.5 GHz in receiving mode. All tests were performed in the semi-anechoic chamber at a 3-meter distance (except for the frequency range with 18 GHz to 25 GHz where test distance was reduced to 1 meter) on both horizontal and vertical polarities. The antenna was also scanned in height. The emissions are recorded with a spectrum analyzer in peak hold mode. The identified emissions are further maximized as a function of cable manipulation, azimuth, and antenna height. The emissions closest to the limits are measured in the peak mode with the tuned spectrum analyzer using a bandwidth of 1MHz and the average setting mode with the tuned spectrum analyzer using resolution bandwidth of 1MHz / video bandwidth of 1kHz. The highest emissions relative to the limit are listed.

7.2 Test Instruments and Measurement Setup

Table 7 Radiated Emission Test Instrumentation (1GHz – 25GHz)

Description	Model	Serial Number
Spectrum Analyzer EMI Test Receiver	R&S ESI26	836119/003
Amplifier (1-26.5GHz)	HP 8449B	3008A00582
Horn Antenna (1- 18GHz)	EMCO 3115	6121
Horn Antenna (3.95 – 5.85GHz)	EMCO 3160-5	1102
Horn Antenna (5.85 – 8.20GHz)	EMCO 3160-6	1067
Horn Antenna (18- 26.5GHz)	EMCO 3160-9	1202
SF106 cables: - Horn Ant <=> RF Amp. - RF Amp.<=>Spectrum Analyzer	Length: 6 m 15 m	- EM206SCO - EM215SCO

Notes: - HP: Hewlett Packard, R&S: Rohde & Schwarz

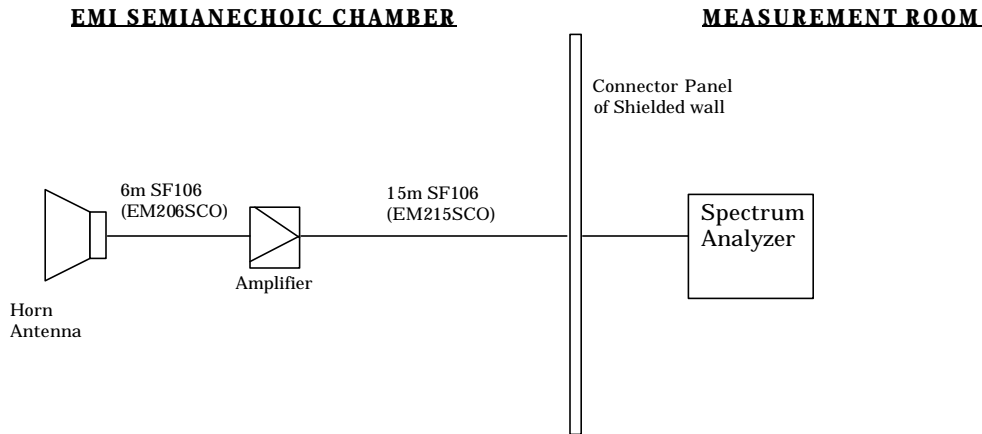

Figure 7 Cables for Radiated Emission Test

7.3 Field Strength Calculation

The field strength is calculated by adding the Antenna Factor and Cable Loss, and subtracting Amplifier Gain from the measured reading. All factors are included in the reported data.

$$FS = R + AF + CORR - FO$$

where:

FS = Field Strength

R = Measured Spectrum analyzer Input Amplitude

AF = Antenna Factor

CORR = Correction Factor = CL-AG

CL = Cable Loss

AG = Amplifier Gain

FO = Distance Falloff Factor

For example:

Given a Spectrum Analyzer input reading of 51.5 dBμV; Antenna Factor of 8.5 dB/m; Cable Loss of 1.3 dB; Falloff Factor of 0 dB; and an Amplifier Gain of 26 dB. The Field Strength of the measured emission is:

$$FS = 51.5 + 8.5 + 1.3 - 26 - 0.0 = 35.6 \text{ dB}\mu\text{V/m}$$

Conversions between dBμV/m (or dBμV) and μV/m (or μV) are done as :

$$\text{Level(dB}\mu\text{V/m)} = 20 \times \text{Log} (\text{Level}(\mu\text{V/m}))$$

$$40 \text{ dB}\mu\text{V/m} = 100 \mu\text{V/m}$$

$$48 \text{ dB}\mu\text{V/m} = 250 \mu\text{V/m}$$

7.4 Measurement Results

The EUT was found to comply to the limits of FCC Part 15 Subpart C and RSS-210 with a margin of 5.9 dB. The measurement was done for the frequency range of 1 GHz to 25 GHz in TX mode and 1 GHz to 12.5GHz in RX mode.

Test Date: June 1, 2001

1) EUT in transmission mode

- EUT: M/T 2656-3Ax (13" TFT model)

Table 7-2-1. EUT: M/T 2656-3Ax, s/n AA-G70KZ, Ch.1(2412MHz) TX mode 11Mbps

Frequency (GHz)	Polarity (H/V)	Measured (dB μ V) (<i>peak</i>)	Measured (dB μ V) (<i>average</i>)	Antenna Factor (dB/m)	Corr. Factor (dB)	Falloff Factor (dB)	Field Strength (dB μ V/m) (<i>peak</i>)	FCC Limit (dB μ V/m) (<i>peak</i>)	Field Strength (dB μ V/m) (<i>average</i>)	FCC Limit (dB μ V/m) (<i>average</i>)
1.097	V	59.6	-	25.1	-31.3	0.0	53.4	74.0	-	54.0
1.195	V	56.5	-	25.1	-31.1	0.0	50.5	74.0	-	54.0
1.294	V	58.4	-	25.1	-30.9	0.0	52.6	74.0	-	54.0
1.499	V	53.7	-	25.1	-30.5	0.0	48.3	74.0	-	54.0
2.038	V	62.9	61.9	27.6	-29.5	0.0	61.0	NRB*	60.0	NRB*
2.389	V	56.0	45.5	28.6	-28.6	0.0	56.0	74.0	45.5	54.0
2.399	V	76.4	68.0	28.6	-28.4	0.0	76.6	NRB*	68.2	NRB*
2.413	V	109.5	101.6	28.7	-28.4	0.0	109.8	OB*	101.9	OB*
4.075	V	47.3	-	27.2	-24.4	0.0	50.1	74.0	-	54.0
4.824	V	39.9	-	27.3	-23.8	0.0	43.4	74.0	-	54.0

*Note: OB means "operation band" (2400-2483.5MHz); in this case limit is 1W (measured conducted with power meter).

NRB means "non restricted band": in this case limit is 20dB below maximum in-band-power equivalent to 109.8 dB μ V/m (peak) and 101.9 dB μ V/m (average).

Table 7-2-2. EUT: M/T 2656-3Ax, s/n AA-G70KZ, Ch.6(2437MHz) TX mode 11Mbps

Frequency (GHz)	Polarity (H/V)	Measured (dB μ V) (<i>peak</i>)	Measured (dB μ V) (<i>average</i>)	Antenna Factor (dB/m)	Corr. Factor (dB)	Falloff Factor (dB)	Field Strength (dB μ V/m) (<i>peak</i>)	FCC Limit (dB μ V/m) (<i>peak</i>)	Field Strength (dB μ V/m) (<i>average</i>)	FCC Limit (dB μ V/m) (<i>average</i>)
1.098	V	59.4	-	25.1	-31.3	0.0	53.2	74.0	-	54.0
1.195	V	53.6	-	25.1	-31.1	0.0	47.6	74.0	-	54.0
1.296	V	57.0	-	25.1	-30.9	0.0	51.2	74.0	-	54.0
1.498	V	54.0	-	25.1	-30.5	0.0	48.6	74.0	-	54.0
2.063	V	61.6	60.1	27.7	-29.3	0.0	60.0	NRB*	58.5	NRB*
2.389	V	52.7	-	28.6	-28.6	0.0	52.7	74.0	-	54.0
2.438	V	109.3	101.6	28.7	-28.4	0.0	109.6	OB*	101.9	OB*
2.486	V	50.5	-	28.8	-28.2	0.0	51.1	74.0	-	54.0
4.125	V	45.8	-	27.2	-24.3	0.0	48.7	74.0	-	54.0
4.874	V	39.8	-	27.3	-23.7	0.0	43.4	74.0	-	54.0

*Note: OB means “operation band” (2400-2483.5MHz); in this case limit is 1W (measured conducted with power meter).

NRB means “non restricted band”: in this case limit is 20dB below maximum in-band-power equivalent to 109.6 dB μ V/m (peak) and 101.9 dB μ V/m (average).

Table 7-2-3. EUT: M/T 2656-3Ax, s/n AA-G70KZ, Ch.11(2462MHz) TX mode 11Mbps

Frequency (GHz)	Polarity (H/V)	Measured (dB μ V) (<i>peak</i>)	Measured (dB μ V) (<i>average</i>)	Antenna Factor (dB/m)	Corr. Factor (dB)	Falloff Factor (dB)	Field Strength (dB μ V/m) (<i>peak</i>)	FCC Limit (dB μ V/m) (<i>peak</i>)	Field Strength (dB μ V/m) (<i>average</i>)	FCC Limit (dB μ V/m) (<i>average</i>)
1.097	V	59.6	-	25.1	-31.3	0.0	53.4	74.0	-	54.0
1.194	V	55.0	-	25.1	-31.1	0.0	49.0	74.0	-	54.0
1.296	V	58.6	-	25.1	-30.9	0.0	52.8	74.0	-	54.0
1.498	V	53.7	-	25.1	-30.5	0.0	48.3	74.0	-	54.0
2.088	V	63.0	62.0	27.7	-29.3	0.0	61.4	NRB*	60.4	NRB*
2.463	V	107.8	100.9	28.8	-28.4	0.0	108.2	OB*	101.3	OB*
2.484	V	53.5	43.4	28.8	-28.2	0.0	54.1	74.0	44.0	54.0
4.176	V	44.8	-	27.2	-24.3	0.0	47.7	74.0	-	54.0
4.924	V	40.9	-	27.3	-23.8	0.0	44.4	74.0	-	54.0

*Note: OB means “operation band” (2400-2483.5MHz); in this case limit is 1W (measured conducted with power meter).

NRB means “non restricted band”: in this case limit is 20dB below maximum in-band-power equivalent to 108.2 dB μ V/m (peak) and 101.3 dB μ V/m (average).

● EUT: M/T 2656-6Ax (14" TFT model)

Table 7-3-1. EUT: M/T 2656-6Ax, s/n AA-G70K8, Ch.1(2412MHz) TX mode 11Mbps

Frequency (GHz)	Polarity (H/V)	Measured (dB μ V) (<i>peak</i>)	Measured (dB μ V) (<i>average</i>)	Antenna Factor (dB/m)	Corr. Factor (dB)	Falloff Factor (dB)	Field Strength (dB μ V/m) (<i>peak</i>)	FCC Limit (dB μ V/m) (<i>peak</i>)	Field Strength (dB μ V/m) (<i>average</i>)	FCC Limit (dB μ V/m) (<i>average</i>)
1.097	V	62.1	46.0	25.1	-31.3	0.0	55.9	74.0	39.8	54.0
1.195	V	54.3	-	25.1	-31.1	0.0	48.3	74.0	-	54.0
1.293	V	55.8	-	25.1	-30.9	0.0	50.0	74.0	-	54.0
1.397	V	53.9	-	25.1	-30.6	0.0	48.4	74.0	-	54.0
1.731	V	49.8	-	26.3	-30.0	0.0	46.1	74.0	-	54.0
1.790	V	56.3	-	26.6	-29.9	0.0	53.0	74.0	-	54.0
1.895	V	51.9	-	27.1	-29.8	0.0	49.2	74.0	-	54.0
2.038	V	55.8	54.3	27.6	-29.5	0.0	53.9	NRB*	52.4	NRB*
2.388	V	58.9	47.8	28.6	-28.6	0.0	58.9	74.0	47.8	54.0
2.398	V	78.5	69.3	28.6	-28.4	0.0	78.7	NRB*	69.5	NRB*
2.413	V	107.7	100.1	28.7	-28.4	0.0	108.0	OB*	100.4	OB*
4.075	V	50.9	-	27.2	-24.4	0.0	53.7	74.0	-	54.0
4.824	V	40.1	-	27.3	-23.8	0.0	43.6	74.0	-	54.0

*Note: OB means "operation band" (2400-2483.5MHz); in this case limit is 1W (measured conducted with power meter).

NRB means "non restricted band": in this case limit is 20dB below maximum in-band-power equivalent to 108.0 dB μ V/m (peak) and 100.4 dB μ V/m (average).

Table 7-3-2. EUT: M/T 2656-6Ax, s/n AA-G70K8, Ch.6(2437MHz) TX mode 11Mbps

Frequency (GHz)	Polarity (H/V)	Measured (dB μ V) (<i>peak</i>)	Measured (dB μ V) (<i>average</i>)	Antenna Factor (dB/m)	Corr. Factor (dB)	Falloff Factor (dB)	Field Strength (dB μ V/m) (<i>peak</i>)	FCC Limit (dB μ V/m) (<i>peak</i>)	Field Strength (dB μ V/m) (<i>average</i>)	FCC Limit (dB μ V/m) (<i>average</i>)
1.098	V	62.1	45.7	25.1	-31.3	0.0	55.9	74.0	39.5	54.0
1.195	V	53.3	-	25.1	-31.1	0.0	47.3	74.0	-	54.0
1.297	V	55.1	-	25.1	-30.9	0.0	49.3	74.0	-	54.0
1.397	V	53.7	-	25.1	-30.6	0.0	48.2	74.0	-	54.0
1.731	V	53.4	-	26.3	-30.0	0.0	49.7	74.0	-	54.0
1.790	V	54.8	-	26.6	-29.9	0.0	51.5	74.0	-	54.0
1.895	V	52.4	-	27.1	-29.8	0.0	49.7	74.0	-	54.0
2.063	V	56.1	53.6	27.7	-29.3	0.0	54.5	NRB*	52.0	NRB*
2.388	V	51.5	39.1	28.6	-28.6	0.0	51.5	74.0	-	54.0
2.438	V	107.6	100.1	28.7	-28.4	0.0	107.9	OB*	100.4	OB*
2.484	V	50.2	38.9	28.8	-28.2	0.0	50.8	74.0	-	54.0
4.125	V	47.2	-	27.2	-24.3	0.0	50.1	74.0	-	54.0
4.874	V	38.7	-	27.3	-23.7	0.0	42.3	74.0	-	54.0

*Note: OB means “operation band” (2400-2483.5MHz); in this case limit is 1W (measured conducted with power meter).

NRB means “non restricted band”: in this case limit is 20dB below maximum in-band-power equivalent to 107.9 dB μ V/m (peak) and 100.4 dB μ V/m (average).

Table 7-3-3. EUT: M/T 2656-6Ax, s/n AA-G70K8, Ch.11(2462MHz) TX mode 11Mbps

Frequency (GHz)	Polarity (H/V)	Measured (dB μ V) (<i>peak</i>)	Measured (dB μ V) (<i>average</i>)	Antenna Factor (dB/m)	Corr. Factor (dB)	Falloff Factor (dB)	Field Strength (dB μ V/m) (<i>peak</i>)	FCC Limit (dB μ V/m) (<i>peak</i>)	Field Strength (dB μ V/m) (<i>average</i>)	FCC Limit (dB μ V/m) (<i>average</i>)
1.097	V	62.0	45.9	25.1	-31.3	0.0	55.8	74.0	39.7	54.0
1.195	V	52.2	-	25.1	-31.1	0.0	46.2	74.0	-	54.0
1.296	V	54.7	-	25.1	-30.9	0.0	48.9	74.0	-	54.0
1.397	V	52.1	-	25.1	-30.6	0.0	46.6	74.0	-	54.0
1.730	V	49.9	-	26.3	-30.0	0.0	46.2	74.0	-	54.0
1.790	V	54.7	-	26.6	-29.9	0.0	51.4	74.0	-	54.0
1.894	V	53.8	-	27.1	-29.8	0.0	51.1	74.0	-	54.0
2.088	V	56.4	53.9	27.7	-29.3	0.0	54.8	NRB*	52.3	NRB*
2.463	V	108.8	101.1	28.8	-28.4	0.0	109.2	OB*	101.5	OB*
2.484	V	58.1	47.5	28.8	-28.2	0.0	58.7	74.0	48.1	54.0
4.176	V	46.1	-	27.2	-24.3	0.0	49.0	74.0	-	54.0
4.924	V	38.9	-	27.3	-23.8	0.0	42.4	74.0	-	54.0

*Note: OB means “operation band” (2400-2483.5MHz); in this case limit is 1W (measured conducted with power meter).

NRB means “non restricted band”: in this case limit is 20dB below maximum in-band-power equivalent to 109.2 dB μ V/m (peak) and 101.5 dB μ V/m (average).

2) EUT in receiving mode

● EUT: M/T 2656-3Ax (13" TFT model)

Table 7-2-4. EUT: M/T 2656-3Ax, s/n AA-G70KZ, RX mode

Frequency (GHz)	Polarity (H/V)	Measured (dB μ V) <i>(peak)</i>	Measured (dB μ V) <i>(average)</i>	Antenna Factor (dB/m)	Corr. Factor (dB)	Falloff Factor (dB)	Field Strength (dB μ V/m) <i>(peak)</i>	FCC Limit (dB μ V/m) <i>(peak)</i>	Field Strength (dB μ V/m) <i>(average)</i>	FCC Limit (dB μ V/m) <i>(average)</i>
1.097	V	59.8	-	25.1	-31.3	0.0	53.6	74.0	-	54.0
1.194	V	56.6	-	25.1	-31.1	0.0	50.6	74.0	-	54.0
1.296	V	58.6	-	25.1	-30.9	0.0	52.8	74.0	-	54.0
1.498	V	53.9	-	25.1	-30.5	0.0	48.5	74.0	-	54.0
2.063	V	52.5	-	27.7	-29.3	0.0	50.9	74.0	-	54.0
4.125	V	45.9	-	27.2	-24.3	0.0	48.8	74.0	-	54.0

● EUT: M/T 2656-6Ax (14" TFT model)

Table 7-3-4. EUT: M/T 2656-6Ax, s/n AA-G70K8, RX mode

Frequency (GHz)	Polarity (H/V)	Measured (dB μ V) <i>(peak)</i>	Measured (dB μ V) <i>(average)</i>	Antenna Factor (dB/m)	Corr. Factor (dB)	Falloff Factor (dB)	Field Strength (dB μ V/m) <i>(peak)</i>	FCC Limit (dB μ V/m) <i>(peak)</i>	Field Strength (dB μ V/m) <i>(average)</i>	FCC Limit (dB μ V/m) <i>(average)</i>
1.097	V	61.9	45.4	25.1	-31.3	0.0	55.7	74.0	39.2	54.0
1.194	V	54.7	-	25.1	-31.1	0.0	48.7	74.0	-	54.0
1.296	V	55.3	-	25.1	-30.9	0.0	49.5	74.0	-	54.0
1.397	V	52.4	-	25.1	-30.6	0.0	46.9	74.0	-	54.0
1.730	V	49.2	-	26.3	-30.0	0.0	45.5	74.0	-	54.0
1.790	V	55.9	-	26.6	-29.9	0.0	52.6	74.0	-	54.0
1.894	V	52.8	-	27.1	-29.8	0.0	50.1	74.0	-	54.0
2.063	V	51.1	-	27.7	-29.3	0.0	49.5	74.0	-	54.0
4.125	V	44.8	-	27.2	-24.3	0.0	47.7	74.0	-	54.0