



# PCTEST ENGINEERING LABORATORY, INC.

6660 – B Dobbin Road · Columbia, MD 21045 · USA

Telephone 410.290.6652 / Fax 410.290.6654

<http://www.pctestlab.com> (email: [randy@pctestlab.com](mailto:randy@pctestlab.com))

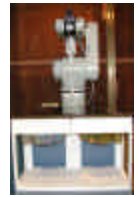

## CERTIFICATE OF COMPLIANCE (SAR EVALUATION)

### Class II Change (FCC/ RSS-102)

**APPLICANT NAME & ADDRESS:**

IBM Corporation  
New Orchard Rd,  
Armonk, NY 10504

**DATE & LOCATION OF TESTING:**

Dates of Tests: January 17-24, 2005  
Test Report S/N: SAR.0501050003-R1.ANO  
Test Site: PCTEST Lab, Columbia, MD USA  
IC Lab File No.: IC 2451

<b>FCC ID:</b>	<b>ANO20040600BTL</b>
<b>IC CERTIFICATION NUMBER:</b>	<b>349E-AR5BMB44</b>
<b>APPLICANT NAME:</b>	<b>IBM CORPORATION</b>

<b>EUT Type:</b>	IBM Laptop PC ThinkPad X41 Tablet Series Model: 1866/ 1867/ 1868/ 1869 w/ 802.11a/b/g WLAN Adapter
<b>Tx Frequency:</b>	2412 – 2462 MHz (DSSS/OFDM) 5180 – 5320 MHz / 5745 – 5825 MHz (OFDM)
<b>Max. RF Output Power:</b>	0.297W Peak Conducted (2.4 GHz DSSS/OFDM) 0.304W Peak Conducted (5.8 GHz OFDM) 0.029W Peak Conducted (5.2 GHz OFDM) 0.060W dBm Peak Conducted (5.3 GHz OFDM)
<b>Max. SAR Measurement:</b>	0.289 W/kg 802.11b Body SAR; 0.285 W/kg 802.11g Body SAR; 0.697 W/kg 802.11a Body SAR; 0.633 W/kg 802.11a Body SAR
<b>Trade Name/Model(s):</b>	<b>AR5BMB-44</b>
<b>FCC Rule Part(s):</b>	§2.1093; FCC/OET Bulletin 65 Supplement C [July 2001]
<b>Industry Canada Rule(s):</b>	RSS-102 (SAR), Safety Code 6 Health Canada
<b>Application Type:</b>	Certification
<b>Test Device Serial No.:</b>	Identical Prototype [S/N: 4]
<b>Original Grant Date:</b>	June 26, 2004

This wireless portable device has been shown to be capable of compliance for localized specific absorption rate (SAR) for uncontrolled environment/general population exposure limits specified in ANSI/IEEE Std. C95.1-1992 and had been tested in accordance with the measurement procedures specified in FCC/OET Bulletin 65 Supplement C (2001), IEEE 1528 - 2003 and Industry Canada RSS-102.

I attest to the accuracy of data. All measurements reported herein were performed by me or were made under my supervision and are correct to the best of my knowledge and belief. I assume full responsibility for the completeness of these measurements and vouch for the qualifications of all persons taking them.

*PCTEST certifies that no party to this application has been denied the FCC benefits pursuant to Section 5301 of the Anti-Drug Abuse Act of 1988, 21 U.S.C. 862.*



Alfred Cirwithian  
Vice President Engineering



PCTEST SAR & RSS-102 TEST REPORT	FCC/ IC Measurement Report			Reviewed by: Quality Manager
	SAR Filename: SAR.0501050003-R1.ANO	Test Dates: Jan. 17-24, 2005	EUT Type: IBM Laptop PC ThinkPad X41 Tablet Series Model: 1866/1867/1868/1869 w/ 802.11b/g WLAN Adapter	

# TABLE OF CONTENTS

1.	INTRODUCTION / SAR DEFINITION .....	3
2.	SAR MEASUREMENT SETUP .....	4
3.	DASY4 E-FIELD PROBE SYSTEM .....	5
4.	Probe Calibration Process .....	6
5.	PHANTOM & EQUIVALENT TISSUES.....	7
6.	TEST SYSTEM SPECIFICATIONS.....	8
7.	DOSIMETRIC ASSESSMENT & PHANTOM SPECS.....	9
8.	ANSI/IEEE C95.1 - 1992 RF EXPOSURE LIMITS.....	10
9.	MEASUREMENT UNCERTAINTIES .....	11
10.	SAR TEST DATA SUMMARY.....	12
11.	SAR TEST EQUIPMENT .....	13
12.	CONCLUSION .....	14
13.	REFERENCES.....	15
EXHIBIT A. SYSTEM VERIFICATION.....		16
EXHIBIT A. SAR DATA SUMMARY .....		17-28
ATTACHEMNT A. SAR TEST DATA .....		29
ATTACHMENT B. SAR TEST SETUP PHOTOGRAPHS .....		30
ATTACHMENT C. DIPOLE VALIDATION.....		31
ATTACHMENT D. PROBE CALIBRATION .....		32

PCTEST SAR & RSS-102 TEST REPORT	 <b>FCC/ IC Measurement Report</b> 			Reviewed by: Quality Manager	
SAR Filename: SAR.0501050003-R1.ANO	Test Dates: Jan. 17-24, 2005	EUT Type: IBM Laptop PC ThinkPad X41 Tablet Series Model: 1866/1867/1868/1869 w/ 802.11b/g WLAN Adapter	FCC ID: ANO20040600BTL	IC ID: 349E-AR5BMB44	Page 2 of 32

# 1. INTRODUCTION / SAR DEFINITION

The FCC has adopted the guidelines for evaluating the environmental effects of radiofrequency radiation in ET Docket 93-62 on Aug. 6, 1996 to protect the public and workers from the potential hazards of RF emissions due to FCC-regulated portable devices.[1]

The safety limits used for the environmental evaluation measurements are based on the criteria published by the American National Standards Institute (ANSI) for localized specific absorption rate (SAR) in *IEEE/ANSI C95.1-1992 Standard for Safety Levels with Respect to Human Exposure to Radio Frequency Electromagnetic Fields, 3 kHz to 300 GHz*. (c) 1992 by the Institute of Electrical and Electronics Engineers, Inc., New York, New York 10017.[2] The measurement procedure described in *IEEE/ANSI C95.3-1992 Recommended Practice for the Measurement of Potentially Hazardous Electromagnetic Fields - RF and Microwave*[3] is used for guidance in measuring SAR due to the RF radiation exposure from the Equipment Under Test (EUT). These criteria for SAR evaluation are similar to those recommended by the National Council on Radiation Protection and Measurements (NCRP) in *Biological Effects and Exposure Criteria for Radiofrequency Electromagnetic Fields*, NCRP Report No. 86 (c) NCRP, 1986, Bethesda, MD 20814.[6] SAR is a measure of the rate of energy absorption due to exposure to an RF transmitting source. SAR values have been related to threshold levels for potential biological hazards.

## SAR Definition

Specific Absorption Rate (SAR) is defined as the time derivative (rate) of the incremental energy ( $dU$ ) absorbed by (dissipated in) an incremental mass ( $dm$ ) contained in a volume element ( $dV$ ) of a given density ( $\rho$ ). It is also defined as the rate of RF energy absorption per unit mass at a point in an absorbing body (see Fig. 1.1).

$$SAR = \frac{d}{dt} \left( \frac{dU}{dm} \right) = \frac{d}{dt} \left( \frac{dU}{\rho dV} \right)$$

Figure 1.1  
SAR Mathematical Equation

SAR is expressed in units of Watts per Kilogram (W/kg).

$$SAR = \frac{\sigma E^2}{\rho}$$

where:

- $\sigma$  = conductivity of the tissue-simulant material (S/m)
- $\rho$  = mass density of the tissue-simulant material (kg/m<sup>3</sup>)
- $E$  = Total RMS electric field strength (V/m)

NOTE: The primary factors that control rate of energy absorption were found to be the wavelength of the incident field in relations to the dimensions and geometry of the irradiated organism, the orientation of the organism in relation to the polarity of field vectors, the presence of reflecting surfaces, and whether conductive contact is made by the organism with a ground plane.[6]

PCTEST SAR & RSS-102 TEST REPORT	FCC/ IC Measurement Report			Reviewed by: Quality Manager
SAR Filename: SAR.0501050003-R1.ANO	Test Dates: Jan. 17-24, 2005	EUT Type: IBM Laptop PC ThinkPad X41 Tablet Series Model: 1866/1867/1868/1869 w/ 802.11b/g WLAN Adapter	FCC ID: ANO20040600BTL	IC ID: 349E-AR5BMB44
				Page 3 of 32

## 2. SAR MEASUREMENT SETUP

### Robotic System

Measurements are performed using the DASY4 automated dosimetric assessment system. The DASY4 is made by Schmid & Partner Engineering AG (SPEAG) in Zurich, Switzerland and consists of high precision robotics system (Staubli), robot controller, Pentium III computer, near-field probe, probe alignment sensor, and the generic twin phantom containing the brain equivalent material. The robot is a six-axis industrial robot performing precise movements to position the probe to the location (points) of maximum electromagnetic field (EMF) (see Fig. 2.1).

### System Hardware

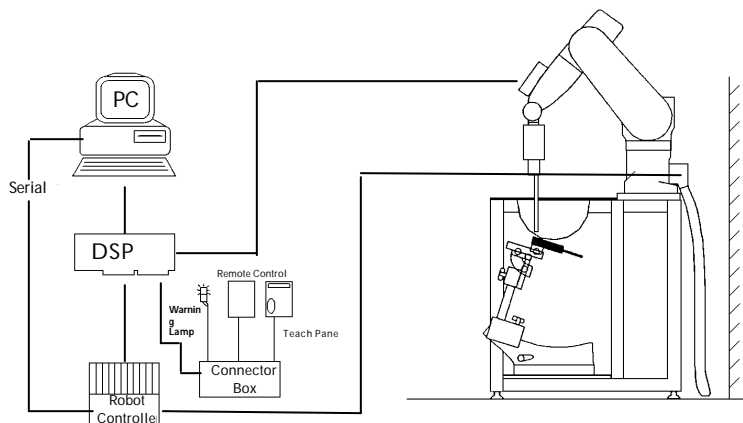

A cell controller system contains the power supply, robot controller, teach pendant (Joystick), and a remote control used to drive the robot motors. The PC consists of the Gateway Pentium 4 2.53 GHz computer with Windows XP system and SAR Measurement Software DASY4, A/D interface card, monitor, mouse, and keyboard. The Staubli Robot is connected to the cell controller to allow software manipulation of the robot. A data acquisition electronic (DAE) circuit that performs the signal amplification, signal multiplexing, AD-conversion, offset measurements, mechanical surface detection, collision detection, etc. is connected to the Electro-optical coupler (EOC). The EOC performs the conversion from the optical into digital electric signal of the DAE and transfers data to the PC plug-in card.



**Figure 2.1 SAR Measurement System Setup**

### System Electronics

The DAE4 consists of a highly sensitive electrometer-grade preamplifier with auto-zeroing, a channel and gain-switching multiplexer, a fast 16 bit AD-converter and a command decoder and control logic unit. Transmission to the PC-card is accomplished through an optical downlink for data and status information and an optical uplink for commands and clock lines. The mechanical probe mounting device includes two different sensor systems for frontal and sidewise probe contacts. They are also used for mechanical surface detection and probe collision detection. The robot uses its own controller with a built in VME-bus computer. The system is described in detail in [7].

PCTEST SAR & RSS-102 TEST REPORT			<b>FCC/ IC Measurement Report</b>			Reviewed by: Quality Manager
	SAR Filename: SAR.0501050003-R1.ANO	Test Dates: Jan. 17-24, 2005	EUT Type: IBM Laptop PC ThinkPad X41 Tablet Series Model: 1866/1867/1868/1869 w/ 802.11b/g WLAN Adapter	FCC ID: ANO20040600BTL		

# 3. DASY4 E-FIELD PROBE SYSTEM

## Probe Measurement System



Figure 3.1 DAE System

The SAR measurements were conducted with the dosimetric probe EX3DV4, designed in the classical triangular configuration [7] (see Fig. 3.2) and optimized for dosimetric evaluation. The probe is constructed using the thick film technique; with printed resistive lines on ceramic substrates. The probe is equipped with an optical multifiber line ending at the front of the probe tip (see Fig. 3.3). It is connected to the EOC box on the robot arm and provides an automatic detection of the phantom surface. Half of the fibers are connected to a pulsed infrared transmitter, the other half to a synchronized receiver. As the probe approaches the surface, the reflection from the surface produces a coupling from the transmitting to the receiving fibers. This reflection increases first during the approach, reaches maximum and then decreases. If the probe is flatly touching the surface, the coupling is zero. The distance of the coupling maximum to the surface is independent of the surface reflectivity and largely independent of the surface to probe angle. The DASY4 software reads the reflection during a software approach and looks for the maximum using a 2<sup>nd</sup> order fitting (see Fig.3.1). The approach is stopped at reaching the maximum.

## Probe Specifications

- Calibration: In air from 10 MHz to 6 GHz  
In brain and muscle simulating tissue at  
Frequencies of 150 MHz, 450 MHz, 835 MHz,  
900 MHz, 1900MHz, 2450MHz, 5300MHz,  
& 5800MHz
- Frequency: 10 MHz to > 6 GHz; Linearity:  $\pm 0.2$  dB  
(30 MHz to 6 GHz)
- Directivity:  $\pm 0.2$  dB in HSL (rotation around probe axis)  
 $\pm 0.4$  dB in HSL (rotation normal probe axis)
- Dynamic: 5 :W/g to > 100 mW/g;
- Range: Linearity:  $\pm 0.2$  dB
- Dimensions: Overall length: 330 mm  
Tip length: 16 mm  
Body diameter: 12 mm  
Tip diameter: 3 mm  
Distance from probe tip to dipole centers: 2 mm
- Application: General dosimetry up to 6 GHz  
Compliance tests of mobile phones  
Fast automatic scanning in arbitrary phantoms

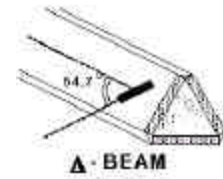



Figure 3.1 Triangular Probe Configuration



Figure 3.2 Probe Thick-Film Technique

PCTEST SAR & RSS-102 TEST REPORT	FCC/ IC Measurement Report			 Reviewed by: Quality Manager
	 SAR Filename: SAR.0501050003-R1.ANO	Test Dates: Jan. 17-24, 2005	EUT Type: IBM Laptop PC ThinkPad X41 Tablet Series Model: 1866/1867/1868/1869 w/ 802.11b/g WLAN Adapter	

# 4. Probe Calibration Process

## Dosimetric Assessment Procedure

Each probe is calibrated according to a dosimetric assessment procedure described in [8] with accuracy better than +/- 10%. The spherical isotropy was evaluated with the procedure described in [9] and found to be better than +/-0.25dB. The sensitivity parameters (NormX, NormY, NormZ), the diode compression parameter (DCP) and the conversion factor (ConvF) of the probe is tested.

## Free Space Assessment

The free space E-field from amplified probe outputs is determined in a test chamber. This is performed in a TEM cell for frequencies below 1 GHz (see Fig. 4.1), and in a waveguide above 1 GHz for free space. For the free space calibration, the probe is placed in the volumetric center of the cavity at the proper orientation with the field. The probe is then rotated 360 degrees.

## Temperature Assessment \*

E-field temperature correlation calibration is performed in a flat phantom filled with the appropriate simulated brain tissue. The measured free space E-field in the medium correlates to temperature rise in a dielectric medium. For temperature correlation calibration a RF transparent thermistor-based temperature probe is used in conjunction with the E-field probe (see Fig. 4.2).

$$SAR = C \frac{\Delta T}{\Delta t}$$

where:

- $\Delta t$  = exposure time (30 seconds),
- $C$  = heat capacity of tissue (brain or muscle),
- $\Delta T$  = temperature increase due to RF exposure.

SAR is proportional to  $\Delta T / \Delta t$ , the initial rate of tissue heating, before thermal diffusion takes place. Now it's possible to quantify the electric field in the simulated tissue by equating the thermally derived SAR to the E- field;

$$SAR = \frac{|E|^2 \cdot s}{r}$$

where:

- $s$  = simulated tissue conductivity,
- $r$  = Tissue density (1.25 g/cm<sup>3</sup> for brain tissue)

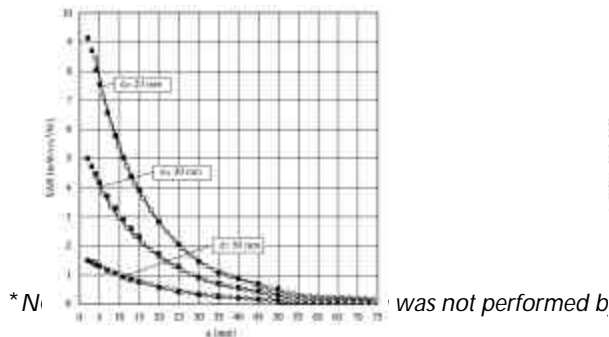

Figure 4.1 E-Field and Temperature measurements at 900MHz [7]

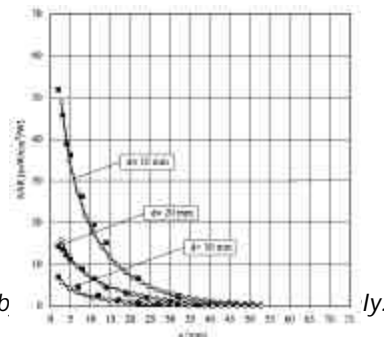



Figure 4.2 E-Field and temperature measurements at 1.9GHz [7]

PCTEST SAR & RSS-102 TEST REPORT			FCC/ IC Measurement Report			Reviewed by: Quality Manager
	SAR Filename: SAR.0501050003-R1.ANO	Test Dates: Jan. 17-24, 2005	EUT Type: IBM Laptop PC ThinkPad X41 Tablet Series Model: 1866/1867/1868/1869 w/ 802.11b/g WLAN Adapter	FCC ID: ANO20040600BTL		



# 5. PHANTOM & EQUIVALENT TISSUES

## SAM Phantom

The SAM Twin Phantom V4.0 is constructed of a fiberglass shell integrated in a wooden table. The shape of the shell is based on data from an anatomical study designed to determine the maximum exposure in at least 90% of all users [11][12]. It enables the dosimetric evaluation of left and right hand phone usage as well as body mounted usage at the flat phantom region. A cover prevents the evaporation of the liquid. Reference markings on the Phantom allow the complete setup of all predefined phantom positions and measurement grids by manually teaching three points in the robot. (see Fig. 5.1)



**Figure 5.1 SAM Twin Phantom**

## Brain & Muscle Simulating Mixture Characterization

The brain and muscle mixtures consist of a viscous gel using hydroxyethylcellulose (HEC) gelling agent and saline solution (see Table 6.1). Preservation with a bactericide is added and visual inspection is made to make sure air bubbles are not trapped during the mixing process. The mixture is calibrated to obtain proper dielectric constant (permittivity) and conductivity of the desired tissue. The head tissue dielectric parameters recommended by the IEEE SCC-34/SC-2 have been incorporated in the following table. Other head and body tissue parameters that have not been specified in 1528 are derived from the tissue dielectric parameters computed from the 4-Cole-Cole equations. The mixture characterizations used for the brain and muscle tissue simulating liquids are according to the data by C. Gabriel and G. Hartsgrove [13].(see Fig. 5.2)

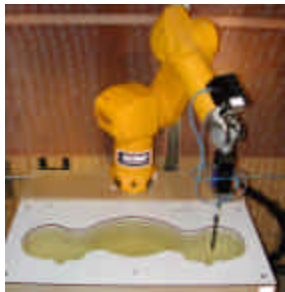

**Figure 5.2 Simulated Tissue**

**Table 5.1 Composition of the Brain & Muscle Tissue Equivalent Matter**

INGREDIENTS		SIMULATING TISSUE			
		2450MHz Brain	2450MHz Muscle	5800MHz Brain	5800MHz Muscle
Mixture Percentage					
WATER		62.70	73.2	Propriety Recipe	Propriety Recipe
DGBE		0.000	26.7	Propriety Recipe	Propriety Recipe
SUGAR		0.000	0.000	Propriety Recipe	Propriety Recipe
SALT		0.5	0.04	Propriety Recipe	Propriety Recipe
BACTERIACIDE		0.000	0.000	Propriety Recipe	Propriety Recipe
HEC		0.000	0.000	Propriety Recipe	Propriety Recipe
Dielectric Constant	Target	40.3	52.7	35.84	48.2
Conductivity (S/m)	Target	1.88	1.95	5.28	6.000



## Device Holder for Transmitters

In combination with the SAM Twin Phantom V4.0, the Mounting Device (see Fig. 5.2) enables the rotation of the mounted transmitter in spherical coordinates whereby the rotation point is the ear opening. The devices can be easily, accurately, and repeatably be positioned according to the FCC specifications. The device holder can be locked at different phantom locations (left head, right head, flat phantom).

\* Note: A simulating human hand is not used due to the complex anatomical and geometrical structure of the hand that may produce infinite number of configurations [12]. To produce the worst-case condition (the hand absorbs antenna output power), the hand is omitted during the tests.



**Figure 5.2 Mounting Device**

PCTEST SAR & RSS-102 TEST REPORT	FCC/ IC Measurement Report				Reviewed by: Quality Manager
					
SAR Filename: SAR.0501050003-R1.ANO	Test Dates: Jan. 17-24, 2005	EUT Type: IBM Laptop PC ThinkPad X41 Tablet Series Model: 1866/1867/1868/1869 w/ 802.11b/g WLAN Adapter	FCC ID: ANO20040600BTL	IC ID: 349E-AR5BMB44	Page 7 of 32

# 6. TEST SYSTEM SPECIFICATIONS

## Automated Test System Specifications

### Positioner

**Robot:** Staubli Unimation Corp. Robot Model: RX60L  
**Repeatability:** 0.02 mm  
**No. of axis:** 6



**Figure 6.1 DASY4 Test System**

### Data Acquisition Electronic (DAE) System

#### Cell Controller

**Processor:** Pentium 4  
**Clock Speed:** 2.53 GHz  
**Operating System:** Windows XP Professional

#### Data Converter

**Features:** Signal Amplifier, multiplexer, A/D converter, & control logic  
**Software:** DASY4 software  
**Connecting Lines:** Optical downlink for data and status info.  
 Optical uplink for commands and clock

### PC Interface Card



**Function:** 24 bit (64 MHz) DSP for real time processing  
 Link to DAE4  
 16 bit A/D converter for surface detection system  
 serial link to robot  
 direct emergency stop output for robot

### E-Field Probes

**Model:** EX3DV4 S/N: 3550  
**Construction:** Triangular core  
**Frequency:** 10 MHz to 6 GHz  
**Linearity:** ± 0.2 dB (30 MHz to 6 GHz)

### Phantom

**Phantom:** SAM Twin Phantom (V4.0)  
**Shell Material:** VIVAC Composite  
**Thickness:** 2.0 ± 0.2 mm

PCTEST SAR & RSS-102 TEST REPORT	FCC/ IC Measurement Report			Reviewed by: Quality Manager	
					
SAR Filename: SAR.0501050003-R1.ANO	Test Dates: Jan. 17-24, 2005	EUT Type: IBM Laptop PC ThinkPad X41 Tablet Series Model: 1866/1867/1868/1869 w/ 802.11b/g WLAN Adapter	FCC ID: ANO20040600BTL	IC ID: 349E-AR5BMB44	Page 8 of 32



# 7. DOSIMETRIC ASSESSMENT & PHANTOM SPECS

## Measurement Procedure

The evaluation was performed using the following procedure:

1. The SAR measurement was taken at a selected spatial reference point to monitor power variations during testing. This fixed location point was measured and used as a reference value.
2. The SAR distribution at the exposed side of the head was measured at a distance of 3.9mm from the inner surface of the shell. The area covered the entire dimension of the head and the horizontal grid spacing was 15mm x 15mm.
3. Based on the area scan data, the area of the maximum absorption was determined by spline interpolation. Around this point, a volume of 32mm x 32mm x 34mm (fine resolution volume scan, zoom scan) was assessed by measuring 7 x 7 x 7 points. On this basis of this data set, the spatial peak SAR value was evaluated with the following procedure (see Fig. 7.1):
  - a. The data at the surface was extrapolated, since the center of the dipoles is 2.7mm away from the tip of the probe and the distance between the surface and the lowest measuring point is 1.2mm. The extrapolation was based on a least square algorithm [15]. A polynomial of the fourth order was calculated through the points in z-axes. This polynomial was then used to evaluate the points between the surface and the probe tip.
  - b. The maximum interpolated value was searched with a straight-forward algorithm. Around this maximum the SAR values averaged over the spatial volumes (1g or 10g) were computed using the 3D-Spline interpolation algorithm. The 3D-spline is composed of three one-dimensional splines with the "Not a knot" condition (in x, y, and z directions) [15][16]. The volume was integrated with the trapezoidal algorithm. One thousand points (10 x 10 x 10) were interpolated to calculate the average.
  - c. All neighboring volumes were evaluated until no neighboring volume with a higher average value was found.
4. The SAR reference value, at the same location as procedure #1, was re-measured. If the value changed by more than 5%, the evaluation is repeated.



Figure 7.1 Sample SAR Area Scan



**Deviation from measurement procedure - None**

## Specific Anthropomorphic Mannequin (SAM) Specifications

The phantom for handset SAR assessment testing is a low-loss dielectric shell, with shape and dimensions derived from the anthropometric data of the 90<sup>th</sup> percentile adult male head dimensions as tabulated by the US Army. The SAM Twin Phantom shell is bisected along the mid-sagittal plane into right and left halves (see Fig. 7.2). The perimeter sidewalls of each phantom halves are extended to allow filling with liquid to a depth that is sufficient to minimized reflections from the upper surface. The liquid depth is maintained at a minimum depth of 15cm to minimize reflections from the upper surface.



Figure 7.2 SAM Twin Phantom shell

PCTEST SAR & RSS-102 TEST REPORT	FCC/ IC Measurement Report			 Reviewed by: Quality Manager
		EUT Type: IBM Laptop PC ThinkPad X41 Tablet Series Model: 1866/1867/1868/1869 w/ 802.11b/g WLAN Adapter	FCC ID: ANO20040600BTL	
SAR Filename: SAR.0501050003-R1.ANO	Test Dates: Jan. 17-24, 2005			Page 9 of 32

## 8. ANSI/IEEE C95.1 - 1992 RF EXPOSURE LIMITS

### Uncontrolled Environment

UNCONTROLLED ENVIRONMENTS are defined as locations where there is the exposure of individuals who have no knowledge or control of their exposure. The general population/uncontrolled exposure limits are applicable to situations in which the general public may be exposed or in which persons who are exposed as a consequence of their employment may not be made fully aware of the potential for exposure or cannot exercise control over their exposure. Members of the general public would come under this category when exposure is not employment-related; for example, in the case of a wireless transmitter that exposes persons in its vicinity.

### Controlled Environment

CONTROLLED ENVIRONMENTS are defined as locations where there is exposure that may be incurred by persons who are aware of the potential for exposure, (i.e. as a result of employment or occupation). In general, occupational/controlled exposure limits are applicable to situations in which persons are exposed as a consequence of their employment, who have been made fully aware of the potential for exposure and can exercise control over their exposure. This exposure category is also applicable when the exposure is of a transient nature due to incidental passage through a location where the exposure levels may be higher than the general population/uncontrolled limits, but the exposed person is fully aware of the potential for exposure and can exercise control over his or her exposure by leaving the area or by some other appropriate means.



**Table 10.1. Safety Limits for Partial Body Exposure [2]**

	HUMAN EXPOSURE LIMITS	
	UNCONTROLLED ENVIRONMENT General Population (W/kg) or (mW/g)	CONTROLLED ENVIRONMENT General Population (W/kg) or (mW/g)
SPATIAL PEAK SAR 1 Brain	1.60	8.00
SPATIAL AVERAGE SAR 2 Whole Body	0.08	0.40
SPATIAL PEAK SAR 3 Hands, Feet, Ankles, Wrists	4.00	20.00

1 The Spatial Peak value of the SAR averaged over any 1 gram of tissue (defined as a tissue volume in the shape of a cube) and over the appropriate averaging time.

2 The Spatial Average value of the SAR averaged over the whole body.



3 The Spatial Peak value of the SAR averaged over any 10 grams of tissue (defined as a tissue volume in the shape of a cube) and over the appropriate averaging time.

PCTEST SAR & RSS-102 TEST REPORT	FCC/ IC Measurement Report			 Reviewed by: Quality Manager
	 SAR Filename: SAR.0501050003-R1.ANO	Test Dates: Jan. 17-24, 2005	EUT Type: IBM Laptop PC ThinkPad X41 Tablet Series Model: 1866/1867/1868/1869 w/ 802.11b/g WLAN Adapter	
Page 10 of 32				

## 9. MEASUREMENT UNCERTAINTIES

a	b	c	d	e= f(d,k)	f	g	h = cx/f/e	i = cx/g/e	k
Uncertainty Component	Sec.	Tol. (± %)	Prob. Dist.	Div.	$c_i$ (1 - g)	$c_i$ (10 - g)	1 - g $u_i$ (± %)	10 - g $u_i$ (± %)	$v_i$
<b>Measurement System</b>									
Probe Calibration	E1.1	4.8	N	1	1	1	4.8	4.8	∞
Axial Isotropy	E1.2	4.7	R	$\sqrt{3}$	0.7	0.7	1.9	1.9	∞
Hemishperical Isotropy	E1.2	9.6	R	$\sqrt{3}$	0.7	0.7	3.9	3.9	∞
Boundary Effect	E1.3	1.0	R	$\sqrt{3}$	1	1	0.6	0.6	∞
Linearity	E1.4	4.7	R	$\sqrt{3}$	1	1	2.7	2.7	∞
System Detection Limits	E1.5	1.0	R	$\sqrt{3}$	1	1	0.6	0.6	∞
Readout Electronics	E1.6	1.0	N	1	1	1	1.0	1.0	∞
Response Time	E1.7	0.8	R	$\sqrt{3}$	1	1	0.5	0.5	∞
Integration Time	E1.8	2.6	R	$\sqrt{3}$	1	1	1.5	1.5	∞
RF Ambient Conditions	E5.1	3.0	R	$\sqrt{3}$	1	1	1.7	1.7	∞
Probe Positioner Mechanical Tolerance	E5.2	0.4	R	$\sqrt{3}$	1	1	0.2	0.2	∞
Probe Positioning w/ respect to Phantom	E5.3	2.9	R	$\sqrt{3}$	1	1	1.7	1.7	∞
Extrapolation, Interpolation & Integration Algorithms for Max. SAR Evaluation	E4.2	1.0	R	$\sqrt{3}$	1	1	0.6	0.6	∞
<b>Test Sample Related</b>									
Test Sample Positioning	E3.2.1	2.9	N	1	1	1	2.9	2.9	145
Device Holder Uncertainty	E3.1.1	3.6	N	1	1	1	3.6	3.6	5
Output Power Variation - SAR drift measurement	5.6.2	5.0	R	$\sqrt{3}$	1	1	2.9	2.9	∞
<b>Phantom &amp; Tissue Parameters</b>									
Phantom Uncertainty (Shape & Thickness tolerances)	E2.1	4.0	R	$\sqrt{3}$	1	1	2.3	2.3	∞
Liquid Conductivity - deviation from target values	E2.2	5.0	R	$\sqrt{3}$	0.64	0.43	1.8	1.2	∞
Liquid Conductivity - measurement uncertainty	E2.2	2.5	N	1	0.64	0.43	1.6	1.1	∞
Liquid Permittivity - deviation from target values	E2.2	5.0	R	$\sqrt{3}$	0.6	0.5	1.7	1.4	∞
Liquid Permittivity - measurement uncertainty	E2.2	2.5	N	1	0.6	0.5	1.5	1.2	∞
<b>Combined Standard Uncertainty (k=1)</b>							10.3	10.0	
<b>Expanded Uncertainty (k=2)</b> (95% CONFIDENCE LEVEL)							20.6	20.1	

The above measurement uncertainties are according to IEEE Std. 1528 - 2003.

PCTEST SAR & RSS-102 TEST REPORT	<b>FCC/ IC Measurement Report</b>				Reviewed by: Quality Manager
					
SAR Filename: SAR.0501050003-R1.ANO	Test Dates: Jan. 17-24, 2005	EUT Type: IBM Laptop PC ThinkPad X41 Tablet Series Model: 1866/1867/1868/1869 w/ 802.11b/g WLAN Adapter	FCC ID: ANO20040600BTL	IC ID: 349E-AR5BMB44	Page 11 of 32

## 10. SAR TEST DATA SUMMARY



See Measurement Result Data Pages

### Procedures Used To Establish Test Signal

The device was placed into continuous transmit mode in WLAN mode, using software test codes. Such test signals offer a consistent means for testing SAR and are recommended for evaluating SAR [4].

### Device Test Conditions

The device was powered through the battery. In order to verify that the device was tested at full power, conducted output power measurements were performed before the evaluation at the maximum power set on the base station simulator to confirm the output power. If a power deviation of more than 5% occurred, the test was repeated.

PCTEST SAR & RSS-102 TEST REPORT	 <b>FCC/ IC Measurement Report</b> 			Reviewed by: Quality Manager	
SAR Filename: SAR.0501050003-R1.ANO	Test Dates: Jan. 17-24, 2005	EUT Type: IBM Laptop PC ThinkPad X41 Tablet Series Model: 1866/1867/1868/1869 w/ 802.11b/g WLAN Adapter	FCC ID: ANO20040600BTL	IC ID: 349E-AR5BMB44	Page 12 of 32

# 11. SAR TEST EQUIPMENT



## Equipment Calibration

Table 13.1 Test Equipment Calibration

EQUIPMENT SPECIFICATIONS			
Type	Calibration Date	Serial Number	
Staubli Robot RX60L	February 2005	599131-01	
Staubli Robot Controller	February 2005	PCT592	
Staubli Teach Pendant (Joystick)	February 2005	3323-00161	
Micron Computer	February 2005	PCT577	
SPEAG EDC3	February 2005	321	
SPEAG DAE4	September 2005	637	
SPEAG E-Field Probe EX3DV4	October 2005	3550	
SPEAG Dummy Probe	February 2005	PCT583	
SPEAG SAM Twin Phantom V4.0	February 2005	PCT666	
SPEAG Light Alignment Sensor	February 2005	205	
PCTEST Validation Dipole D300V2	September 2005	PCT301	
SPEAG Validation Dipole D835V2	January 2005	PCT512	
SPEAG Validation Dipole D1900V2	January 2005	PCT613	
Brain Equivalent Matter (300MHz)	January 2005	PCTBEM601	
Brain Equivalent Matter (835MHz)	January 2005	PCTBEM101	
Brain Equivalent Matter (1900MHz)	January 2005	PCTBEM301	
Muscle Equivalent Matter (300MHz)	January 2005	PCTMEM701	
Muscle Equivalent Matter (835MHz)	January 2005	PCTMEM201	
Muscle Equivalent Matter (1900MHz)	January 2005	PCTMEM401	
Microwave Amp. Model: 5S1G4, (800MHz - 4.2GHz)	January 2005	22332	
Gigatronics 8651A Power Meter	January 2005	1835299	
HP-8648D (9kHz ~ 4GHz) Signal Generator	January 2005	PCT530	
Amplifier Research 5S1G4 Power Amp	January 2005	PCT540	
HP-8753E (30kHz ~ 3GHz) Network Analyzer	January 2005	PCT552	
HP85070B Dielectric Probe Kit	January 2005	PCT501	
Ambient Noise/Reflection, etc.	<12mW/kg/<3%of SAR	January 2005	Anechoic Room PCT01

**NOTE:**

Dipole Validation measurement was performed by PCTEST Lab before each test. The brain simulating material is calibrated by PCTEST using the dielectric probe system and network analyzer to determine the conductivity and permittivity (dielectric constant) of the brain-equivalent material.



PCTEST SAR & RSS-102 TEST REPORT	 FCC/ IC Measurement Report					Reviewed by: Quality Manager
	SAR Filename: SAR.0501050003-R1.ANO	Test Dates: Jan. 17-24, 2005	EUT Type: IBM Laptop PC ThinkPad X41 Tablet Series Model: 1866/1867/1868/1869 w/ 802.11b/g WLAN Adapter	FCC ID: ANO20040600BTL	IC ID: 349E-AR5BMB44	Page 13 of 32

## 12. CONCLUSION

### Measurement Conclusion

The SAR measurement indicates that the EUT complies with the RF radiation exposure limits of the FCC and Industry Canada. These measurements are taken to simulate the RF effects exposure under worst-case conditions. Precise laboratory measures were taken to assure repeatability of the tests. The tested device complies with the requirements in respect to all parameters subject to the test. The test results and statements relate only to the item(s) tested.



Please note that the absorption and distribution of electromagnetic energy in the body are very complex phenomena that depend on the mass, shape, and size of the body, the orientation of the body with respect to the field vectors, and the electrical properties of both the body and the environment. Other variables that may play a substantial role in possible biological effects are those that characterize the environment (e.g. ambient temperature, air velocity, relative humidity, and body insulation) and those that characterize the individual (e.g. age, gender, activity level, debilitation, or disease). Because innumerable factors may interact to determine the specific biological outcome of an exposure to electromagnetic fields, any protection guide shall consider maximal amplification of biological effects as a result of field-body interactions, environmental conditions, and physiological variables.[3]

PCTEST SAR & RSS-102 TEST REPORT	 <b>FCC/ IC Measurement Report</b> 			Reviewed by: Quality Manager	
SAR Filename: SAR.0501050003-R1.ANO	Test Dates: Jan. 17-24, 2005	EUT Type: IBM Laptop PC ThinkPad X41 Tablet Series Model: 1866/1867/1868/1869 w/ 802.11b/g WLAN Adapter	FCC ID: ANO20040600BTL	IC ID: 349E-AR5BMB44	Page 14 of 32



## 13. REFERENCES

- [1] Federal Communications Commission, ET Docket 93-62, Guidelines for Evaluating the Environmental Effects of Radiofrequency Radiation, Aug. 1996.
- [2] ANSI/IEEE C95.1 - 1991, *American National Standard safety levels with respect to human exposure to radio frequency electromagnetic fields, 300kHz to 100GHz*, New York: IEEE, Aug. 1992.
- [3] ANSI/IEEE C95.3 - 1991, *IEEE Recommended Practice for the Measurement of Potentially Hazardous Electromagnetic Fields - RF and Microwave*, New York: IEEE, 1992.
- [4] Federal Communications Commission, OET Bulletin 65 (Edition 97-01), Supplement C (Edition 01-01), *Evaluating Compliance with FCC Guidelines for Human Exposure to Radiofrequency Electromagnetic Fields*, July 2001.
- [5] IEEE Standards Coordinating Committee 34 – IEEE 1528-2003), *Recommended Practice for Determining the Peak Spatial-Average Specific Absorption Rate (SAR) in the Human Body Due to Wireless Communications Devices*.
- [6] NCRP, National Council on Radiation Protection and Measurements, *Biological Effects and Exposure Criteria for RadioFrequency Electromagnetic Fields*, NCRP Report No. 86, 1986. Reprinted Feb. 1995.
- [7] V. Hombach, K. Meier, M. Burkhardt, E. Kuhn, N. Kuster, *The Dependence of EM Energy Absorption upon Human Head Modeling at 900 MHz*, IEEE Transaction on Microwave Theory and Techniques, vol. 44 no. 10, Oct. 1996, pp. 1865-1873.
- [8] N. Kuster and Q. Balzano, *Energy absorption mechanism by biological bodies in the near field of dipole antennas above 300MHz*, IEEE Transaction on Vehicular Technology, vol. 41, no. 1, Feb. 1992, pp. 17-23.
- [9] G. Hartsgrove, A. Kraszewski, A. Surowiec, *Simulated Biological Materials for Electromagnetic Radiation Absorption Studies*, University of Ottawa, Bioelectromagnetics, Canada: 1987, pp. 29-36.
- [10] Q. Balzano, O. Garay, T. Manning Jr., *Electromagnetic Energy Exposure of Simulated Users of Portable Cellular Telephones*, IEEE Transactions on Vehicular Technology, vol. 44, no.3, Aug. 1995.
- [11] W.H. Press, S.A. Teukolsky, W.T. Vetterling, and B.P. Flannery, *Numerical Recipes in C*, The Art of Scientific Computing, Second edition, Cambridge University Press, 1992.
- [12] Federal Communications Commission, OET Bulletin 65, Evaluating Compliance with FCC Guidelines for Human Exposure to Radiofrequency Electromagnetic Fields. Supplement C, Dec. 1997.
- [13] CENELEC CLC/SC111B, European Prestandard (prENV 50166-2), Human Exposure to Electromagnetic Fields High-frequency: 10kHz-300GHz, Jan. 1995.

PCTEST SAR & RSS-102 TEST REPORT	<b>FCC/ IC Measurement Report</b>				Reviewed by: Quality Manager
					
SAR Filename: SAR.0501050003-R1.ANO	Test Dates: Jan. 17-24, 2005	EUT Type: IBM Laptop PC ThinkPad X41 Tablet Series Model: 1866/1867/1868/1869 w/ 802.11b/g WLAN Adapter	FCC ID: ANO20040600BTL	IC ID: 349E-AR5BMB44	Page 15 of 32

# EXHIBIT A. SYSTEM VERIFICATION

## Tissue Verification

Table A.1 Simulated Tissue Verification

MEASURED TISSUE PARAMETERS										
	2450 MHz Muscle		2450 MHz Brain		5300 MHz Muscle		5800 MHz Muscle		5800 MHz Brain	
	Target	Measured	Target	Measured	Target	Measured	Target	Measured	Target	Measured
Dielectric Constant: $\epsilon$	52.70	53.12	39.20	38.53	48.90	48.06	48.20	48.21	35.30	35.53
Conductivity: $\sigma$	1.950	1.91	1.80	1.83	5.420	5.41	6.000	5.94	5.27	5.40

## Test System Validation

Prior to assessment, the system is verified to the  $\pm 10\%$  of the specifications at 2450 and 5800 MHz by using the system validation kits. (Graphic Plots Attached)

Table A.2 System Validation

System Validation TARGET & MEASURED							
Date:	Amb. Temp (°C)	Liquid Temp(°C)	Input Power (W)	Tissue	Targeted SAR <sub>1g</sub> (mW/g)	Measured SAR <sub>1g</sub> (mW/g)	Deviation (%)
01/20/05	23.3	20.8	0.100	2450 MHz Brain	5.24	5.070	-3.20
01/21/05	22.8	20.6				4.780	-8.70
01/24/05	22.9	20.7				5.160	-1.50
01/17/05	22.6	20.4	0.025	5800 MHz Brain	2.250	2.130	-5.30
01/18/05	22.5	20.2				2.080	-7.50
01/19/05	23.5	20.6				2.280	+1.30
01/20/05	236	20.5				2.200	-2.20

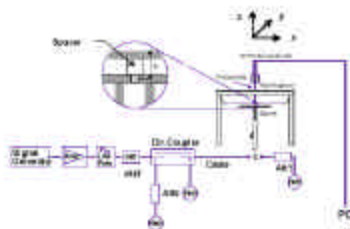

Figure A.0 Dipole Validation Test Setup

PCTEST SAR & RSS-102 TEST REPORT	FCC/ IC Measurement Report				Reviewed by: Quality Manager
SAR Filename: SAR.0501050003-R1.ANO	Test Dates: Jan. 17-24, 2005	EUT Type: IBM Laptop PC ThinkPad X41 Tablet Series Model: 1866/1867/1868/1869 w/ 802.11b/g WLAN Adapter	FCC ID: ANO20040600BTL	IC ID: 349E-AR5BMB44	Page 16 of 32

# EXHIBIT A. SAR DATA SUMMARY

Mixture Type: 2450MHz Muscle

<b>A.1 MEASUREMENT RESULTS (IEEE 802.11b, Laptop, LCD Flip)</b>										
FREQUENCY		Modulation	POWER *		Data Rate (Mbps)	Antenna	Separation Distance (cm) ‡	Test Position	Bluetooth	SAR (W/kg)
			Start	End						
MHz	Ch.									
2437	6	DSSS	16.90	16.8	1	Main	0.0 cm	Laptop	OFF	0.028
2437	6	DSSS	16.90	16.97	1	Main	0.0 cm	Laptop	ON	0.028
2437	6	DSSS	17.40	17.54	1	Aux	0.0 cm	Laptop	OFF	0.011
2437	6	DSSS	17.40	17.51	1	Aux	0.0 cm	Laptop	ON	0.011
<b>ANSI / IEEE C95.1 1992 - SAFETY LIMIT Spatial Peak Uncontrolled Exposure/General Population</b>							<b>Body 1.6 W/kg (mW/g) averaged over 1 gram</b>			

**NOTES:**

1. The test data reported are the worst-case SAR value with the lap held position set in a typical configuration. Test procedures used are according to FCC/OET Bulletin 65, Supp.C [July 2001].
2. All modes of operation were investigated, and worst-case results are reported.
3. SAR Measurement System
 

<input checked="" type="checkbox"/> DASY4	<input type="checkbox"/> IDX
---	------------------------------
- Phantom Configuration
 

<input type="checkbox"/> Left Head	<input checked="" type="checkbox"/> Flat Phantom	<input type="checkbox"/> Right Head
------------------------------------	--	-------------------------------------
4. SAR Configuration
 

<input type="checkbox"/> Head	<input checked="" type="checkbox"/> Body	<input type="checkbox"/> Hand
-------------------------------	--	-------------------------------
5. Test Signal Call Mode
 

<input checked="" type="checkbox"/> Software	<input type="checkbox"/> Base Station Simulator
--	---
6. Tissue parameters and temperatures are listed on the SAR plots.
7. Liquid tissue depth is 15.1 cm. ± 0.1
8. \* Average power measurements

Alfred

---

**Alfred Cirwithian**  
Vice President Engineering

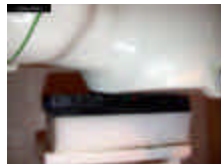

Figure A.1.1 Body SAR Test Setup  
-- Laptop, LCD Flip --  
(Main Antenna)

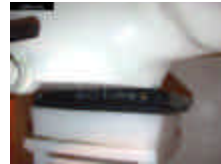

Figure A.1.2 Body SAR Test Setup  
-- Laptop, LCD Flip --  
(Aux Antenna)

# EXHIBIT A. SAR DATA SUMMARY (Continued)

Mixture Type: 2450MHz Muscle

<b>A.2 MEASUREMENT RESULTS (IEEE 802.11b, Bystander, LCD Flip)</b>										
FREQUENCY		Modulation	POWER*		Data Rate (Mbps)	Antenna	Bluetooth	Separation Distance (cm) ‡‡	Position	SAR (W/kg)
MHz	Ch.		Start	End						
2437	6	DSSS	16.90	16.80	1	Main	OFF	1.0 cm	Bystander	0.289
2437	6	DSSS	16.90	16.84	2	Main	OFF	1.0 cm	Bystander	0.286
2437	6	DSSS	16.92	16.79	5.5	Main	OFF	1.0 cm	Bystander	0.285
2437	6	DSSS	16.92	16.82	11	Main	OFF	1.0 cm	Bystander	0.281
2437	6	DSSS	16.90	16.91	1	Main	ON	1.0 cm	Bystander	0.278
2437	6	DSSS	17.40	17.37	1	Aux	OFF	1.5 cm	Bystander	0.111
2437	6	DSSS	17.40	17.62	1	Aux	ON	1.5 cm	Bystander	0.109
<b>ANSI / IEEE C95.1 1992 - SAFETY LIMIT</b>							<b>Body</b>			
<b>Spatial Peak</b>							<b>1.6 W/kg (mW/g)</b>			
<b>Uncontrolled Exposure/General Population</b>							averaged over 1 gram			

**NOTES:**

1. The test data reported are the worst-case SAR value with the lap held position set in a typical configuration. Test procedures used are according to FCC/OET Bulletin 65, Supp.C [July 2001].
2. All modes of operation were investigated, and worst-case results are reported.
3. SAR Measurement System  DASY4  IDX  
Phantom Configuration  Left Head  Flat Phantom  Right Head
4. SAR Configuration  Head  Body  Hand
5. Test Signal Call Mode  Software  Base Station Simulator
6. Tissue parameters and temperatures are listed on the SAR plots.
7. Liquid tissue depth is 15.1 cm. ± 0.1
8. 1.0cm spacing was used to determine worst case data rate in order to increase accuracy.
9. \* Average power measurements



**Alfred Cirwilhian**  
Vice President Engineering

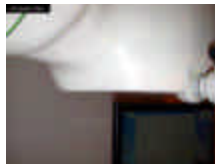

**Figure A.2.1** Body SAR Test Setup -- Bystander Position, LCD Flip -- (Main Antenna)

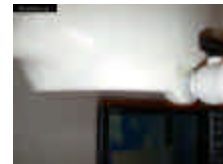

**Figure A.2.2** Body SAR Test Setup -- Bystander Position, LCD Flip -- (Aux Antenna)

PCTEST SAR & RSS-102 TEST REPORT	<b>FCC/ IC Measurement Report</b>				Reviewed by: Quality Manager
SAR Filename: SAR.0501050003-R1.ANO	Test Dates: Jan. 17-24, 2005	EUT Type: IBM Laptop PC ThinkPad X41 Tablet Series Model: 1866/1867/1868/1869 w/ 802.11b/g WLAN Adapter	FCC ID: ANO20040600BTL	IC ID: 349E-AR5BMB44	Page 18 of 32

# EXHIBIT A. SAR DATA SUMMARY

Mixture Type: 2450MHz Muscle

<b>A.3 MEASUREMENT RESULTS (IEEE 802.11b, Tablet, LCD Flip)</b>										
FREQUENCY		Modulation	POWER*		Data Rate (Mbps)	Antenna	Separation Distance (cm) <sup>##</sup>	Test Position	Bluetooth	SAR (W/kg)
			Start	End						
MHz	Ch.									
2437	6	DSSS	16.90	17.13	1	Main	0.0 cm	Right Side	ON	0.034
2437	6	DSSS	16.90	16.78	1	Main	0.0 cm	Bottom Side	ON	0.072
2437	6	DSSS	16.90	17.12	1	Main	0.0 cm	Left Side	ON	0.127
2437	6	DSSS	17.40	17.59	1	Aux	0.0 cm	Top Side	ON	0.015
2437	6	DSSS	17.40	17.44	1	Aux	0.0 cm	Bottom Side	ON	0.074
2437	6	DSSS	17.40	17.60	1	Aux	0.0 cm	Left Side	ON	0.035
<b>ANSI / IEEE C95.1 1992 - SAFETY LIMIT</b>							<b>Body</b>			
<b>Spatial Peak</b>							<b>1.6 W/kg (mW/g)</b>			
<b>Uncontrolled Exposure/General Population</b>							averaged over 1 gram			

**NOTES:**

1. The test data reported are the worst-case SAR value with the lap held position set in a typical configuration. Test procedures used are according to FCC/OET Bulletin 65, Supp.C [July 2001].
2. All modes of operation were investigated, and worst-case results are reported.
3. SAR Measurement System  DASY4  IDX  
 Phantom Configuration  Left Head  Flat Phantom  Right Head
4. SAR Configuration  Head  Body  Hand
5. Test Signal Call Mode  Software  Base Station Simulator
6. Tissue parameters and temperatures are listed on the SAR plots.
7. Liquid tissue depth is 15.1 cm. ± 0.1
8. \* Average power measurements



**Alfred Cirwithian**  
Vice President Engineering



Figure A.3.2 Body SAR Test Setup -- Tablet, LCD Flip -- (Top Side)



Figure A.3.3 Body SAR Test Setup -- Tablet, LCD Flip -- (Bottom Side)



Figure A.3.4 Body SAR Test Setup -- Tablet, LCD Flip -- (Right Side)



Figure A.3.5 Body SAR Test Setup3 -- Tablet, LCD Flip -- (Left Side)

<b>PCTEST SAR &amp; RSS-102 TEST REPORT</b>	<b>FCC/ IC Measurement Report</b>				Reviewed by: Quality Manager
SAR Filename: SAR.0501050003-R1.ANO	Test Dates: Jan. 17-24, 2005	EUT Type: IBM Laptop PC ThinkPad X41 Tablet Series Model: 1866/1867/1868/1869 w/ 802.11b/g WLAN Adapter	FCC ID: ANO20040600BTL	IC ID: 349E-AR5BMB44	Page 19 of 32

# EXHIBIT A. SAR DATA SUMMARY

Mixture Type: 2450MHz Muscle

<b>A.4 MEASUREMENT RESULTS (IEEE 802.11g, Laptop, LCD Flip)</b>										
FREQUENCY		Modulation	POWER		Data Rate (Mbps)	Antenna	Separation Distance (cm) ‡‡	Test Position	Bluetooth	SAR (W/kg)
			Start	End						
MHz	Ch.									
2437	6	OFDM	16.92	16.90	24	Main	0.0 cm	Laptop	OFF	0.029
2437	6	OFDM	16.92	17.12	24	Main	0.0 cm	Laptop	ON	0.030
2437	6	OFDM	16.94	17.08	24	Aux	0.0 cm	Laptop	OFF	0.031
2437	6	OFDM	16.94	17.14	24	Aux	0.0 cm	Laptop	ON	0.029
<b>ANSI / IEEE C95.1 1992 - SAFETY LIMIT Spatial Peak Uncontrolled Exposure/General Population</b>							<b>Body 1.6 W/kg (mW/g) averaged over 1 gram</b>			

**NOTES:**

1. The test data reported are the worst-case SAR value with the lap held position set in a typical configuration. Test procedures used are according to FCC/OET Bulletin 65, Supp.C [July 2001].
2. All modes of operation were investigated, and worst-case results are reported.
3. SAR Measurement System                    DASY4                    IDX  
Phantom Configuration                    Left Head                    Flat Phantom                    Right Head
4. SAR Configuration                    Head                    Body                    Hand
5. Test Signal Call Mode                    Software                    Base Station Simulator
6. Tissue parameters and temperatures are listed on the SAR plots.
7. Liquid tissue depth is 15.1 cm. ± 0.1
8. \* Average power measurements



**Alfred Cirvithian**  
Vice President Engineering

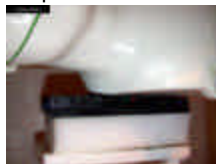

Figure A.4.1 Body SAR Test Setup -- Laptop Position, LCD Flip -- (Main Antenna)

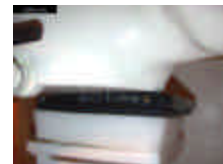

Figure A.4.2 Body SAR Test Setup -- Laptop Position, LCD Flip -- (Aux Antenna)

<b>PCTEST SAR &amp; RSS-102 TEST REPORT</b>	<b>FCC/ IC Measurement Report</b>				Reviewed by: Quality Manager
SAR Filename: SAR.0501050003-R1.ANO	Test Dates: Jan. 17-24, 2005	EUT Type: IBM Laptop PC ThinkPad X41 Tablet Series Model: 1866/1867/1868/1869 w/ 802.11b/g WLAN Adapter	FCC ID: ANO20040600BTL	IC ID: 349E-AR5BMB44	Page 20 of 32



# EXHIBIT A. SAR DATA SUMMARY (Continued)

Mixture Type: 2450MHz Muscle

<b>A.5 MEASUREMENT RESULTS (IEEE 802.11g, Bystander, LCD Open)</b>										
FREQUENCY		Modulation	POWER*		Data Rate (Mbps)	Antenna	Bluetooth	Separation Distance (cm) ‡	Position	SAR (W/kg)
MHz	Ch.		Start	End						
2437	6	OFDM	16.90	17.05	6	Main	OFF	1.0 cm	Bystander	0.238
2437	6	OFDM	17.06	17.21	9	Main	OFF	1.0 cm	Bystander	0.284
2437	6	OFDM	17.02	17.25	12	Main	OFF	1.0 cm	Bystander	0.282
2437	6	OFDM	16.98	17.20	18	Main	OFF	1.0 cm	Bystander	0.282
2437	6	OFDM	16.92	17.05	24	Main	OFF	1.0 cm	Bystander	0.283
2437	6	OFDM	15.92	16.06	36	Main	OFF	1.0 cm	Bystander	0.285
2437	6	OFDM	14.42	14.62	48	Main	OFF	1.0 cm	Bystander	0.220
2437	6	OFDM	13.29	13.50	54	Main	OFF	1.0 cm	Bystander	0.153
2437	6	OFDM	16.92	16.76	24	Main	ON	1.0 cm	Bystander	0.120
2437	6	OFDM	16.94	17.14	24	Aux	OFF	1.5 cm	Bystander	0.261
2437	6	OFDM	16.94	16.95	24	Aux	ON	1.5 cm	Bystander	0.122
<b>ANSI / IEEE C95.1 1992 - SAFETY LIMIT</b>							<b>Body</b>			
Spatial Peak							1.6 W/kg (mW/g)			
Uncontrolled Exposure/General Population							averaged over 1 gram			

**NOTES:**

1. The test data reported are the worst-case SAR value with the lap held position set in a typical configuration. Test procedures used are according to FCC/OET Bulletin 65, Supp.C [July 2001].
2. All modes of operation were investigated, and worst-case results are reported.
3. SAR Measurement System                     DASY4                     IDX  
Phantom Configuration                     Left Head                     Flat Phantom                     Right Head
4. SAR Configuration                     Head                     Body                     Hand
5. Test Signal Call Mode                     Software                     Base Station Simulator
6. Tissue parameters and temperatures are listed on the SAR plots.
7. Liquid tissue depth is 15.1 cm. ± 0.1
8. \* Average power measurements

Alfred

---

**Alfred Cirwithian**  
Vice President Engineering

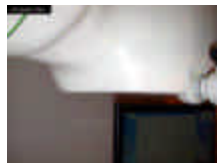

**Figure A.5.1 Body SAR Test Setup  
-- Bystander Position, LCD Open --  
(Main Antenna)**

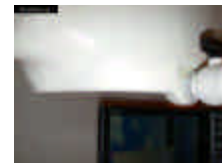

**Figure A.5.2 Body SAR Test Setup  
-- Bystander Position, LCD Open --  
(Aux Antenna)**

<b>PCTEST SAR &amp; RSS-102 TEST REPORT</b>	<b>FCC/ IC Measurement Report</b>				Reviewed by: Quality Manager
SAR Filename: SAR.0501050003-R1.ANO	Test Dates: Jan. 17-24, 2005	EUT Type: IBM Laptop PC ThinkPad X41 Tablet Series Model: 1866/1867/1868/1869 w/ 802.11b/g WLAN Adapter	FCC ID: ANO20040600BTL	IC ID: 349E-AR5BMB44	Page 21 of 32

# EXHIBIT A. SAR DATA SUMMARY (Continued)

Mixture Type: 2450MHz Muscle

A.6 MEASUREMENT RESULTS (IEEE 802.11g, Tablet, LCD Flip)										
FREQUENCY		Modulation	POWER*		Data Rate (Mbps)	Antenna	Bluetooth	Separation Distance (cm) ‡‡	Position	SAR (W/kg)
MHz	Ch.		Start	End						
2437	6	OFDM	16.92	17.14	24	Main	ON	0.0 cm	Right Side	0.025
2437	6	OFDM	16.92	16.87	24	Main	ON	0.0 cm	Bottom Side	0.078
2437	6	OFDM	16.92	17.07	24	Main	ON	0.0 cm	Left Side	0.129
2437	6	OFDM	16.94	17.09	24	Aux	ON	0.0 cm	Top Side	0.032
2437	6	OFDM	16.94	16.95	24	Aux	ON	0.0 cm	Bottom Side	0.066
2437	6	OFDM	16.94	17.17	24	Aux	ON	0.0 cm	Left Side	0.035
<b>ANSI / IEEE C95.1 1992 - SAFETY LIMIT</b>										
<b>Spatial Peak</b>										
<b>Uncontrolled Exposure/General Population</b>							<b>Body</b>			
							<b>1.6 W/kg (mW/g)</b>			
							averaged over 1 gram			

**NOTES:**

1. The test data reported are the worst-case SAR value with the lap held position set in a typical configuration. Test procedures used are according to FCC/OET Bulletin 65, Supp.C [July 2001].
2. All modes of operation were investigated, and worst-case results are reported.
3. SAR Measurement System
 

<input checked="" type="checkbox"/> DASY4	<input type="checkbox"/> IDX
Phantom Configuration	<input type="checkbox"/> Left Head <input checked="" type="checkbox"/> Flat Phantom <input type="checkbox"/> Right Head
4. SAR Configuration
 

<input type="checkbox"/> Head	<input checked="" type="checkbox"/> Body	<input type="checkbox"/> Hand
-------------------------------	--	-------------------------------
5. Test Signal Call Mode
 

<input checked="" type="checkbox"/> Software	<input type="checkbox"/> Base Station Simulator
--	---
6. Tissue parameters and temperatures are listed on the SAR plots.
7. Liquid tissue depth is 15.1 cm. ± 0.1
8. \* Average power measurements

Alfred

---

**Alfred Cirwithian**  
Vice President Engineering

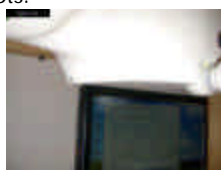

**Figure A.6.1 Body SAR Test Setup**  
-- Tablet Position, LCD Open --  
(Top Side)



**Figure A.6.2 Body SAR Test Setup**  
-- Tablet Position, LCD Open --  
(Bottom Side)

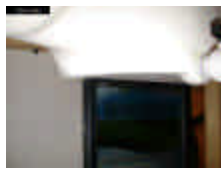

**Figure A.6.3 Body SAR Test Setup**  
-- Tablet Position, LCD Open --  
(Right Side)



**Figure A.6.4 Body SAR Test Setup**  
-- Tablet Position, LCD Open --  
(Left Side)

<b>PCTEST SAR &amp; RSS-102 TEST REPORT</b>	<b>FCC/ IC Measurement Report</b>			Reviewed by: Quality Manager
SAR Filename: SAR.0501050003-R1.ANO	Test Dates: Jan. 17-24, 2005	EUT Type: IBM Laptop PC ThinkPad X41 Tablet Series Model: 1866/1867/1868/1869 w/ 802.11b/g WLAN Adapter	FCC ID: ANO20040600BTL	IC ID: 349E-AR5BMB44
				Page 22 of 32

# EXHIBIT A. SAR DATA SUMMARY (Continued)

Mixture Type: 5300MHz Muscle

<b>A.7 MEASUREMENT RESULTS ( IEEE 802.11a, Laptop, LCD Flip)</b>										
FREQUENCY		Modulation	POWER*		Data Rate (Mbps)	Antenna	Bluetooth	Separation Distance (cm) ‡‡	Position	SAR (W/kg)
MHz	Ch.		Start	End						
5260	52	OFDM	17.71	17.88	18	Main	OFF	0.0 cm	Laptop	0.082
5260	52	OFDM	17.71	17.81	18	Main	ON	0.0 cm	Laptop	0.094
5260	52	OFDM	17.80	18.00	18	Aux	OFF	0.0 cm	Laptop	0.031
5260	52	OFDM	17.80	17.97	18	Aux	ON	0.0 cm	Laptop	0.028
<b>ANSI / IEEE C95.1 1992 - SAFETY LIMIT Spatial Peak Uncontrolled Exposure/General Population</b>							<b>Body 1.6 W/kg (mW/g) averaged over 1 gram</b>			

**NOTES:**

1. The test data reported are the worst-case SAR value with the lap held position set in a typical configuration. Test procedures used are according to FCC/OET Bulletin 65, Supp.C [July 2001].
2. All modes of operation were investigated, and worst-case results are reported.
3. SAR Measurement System  DASY4  IDX  
Phantom Configuration  Left Head  Flat Phantom  Right Head
4. SAR Configuration  Head  Body  Hand
5. Test Signal Call Mode  Software  Base Station Simulator
6. Tissue parameters and temperatures are listed on the SAR plots.
7. Liquid tissue depth is 15.1 cm. ± 0.1
8. \* Average power measurements

  
 Alfred Cirwithian  
 Vice President Engineering

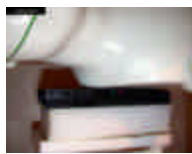

Figure A.7.1 Body SAR Test Setup  
-- Laptop Position, LCD Flip --  
(Main Antenna)

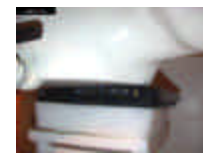

Figure A.7.2 Body SAR Test Setup  
-- Laptop Position, LCD Flip --  
(Aux Antenna)

# EXHIBIT A. SAR DATA SUMMARY (Continued)

Mixture Type: 5300MHz Muscle

<b>A.8 MEASUREMENT RESULTS (IEEE 802.11a, Bystander, LCD Open)</b>										
FREQUENCY		Modulation	POWER*		Data Rate (Mbps)	Antenna	Bluetooth	Separation Distance (cm) ‡	Position	SAR (W/kg)
MHz	Ch.		Start	End						
5260	52	OFDM	17.74	17.57	6	Main	OFF	1.0 cm	Bystander	0.655
5260	52	OFDM	17.75	17.57	9	Main	OFF	1.0 cm	Bystander	0.658
5260	52	OFDM	17.74	17.65	12	Main	OFF	1.0 cm	Bystander	0.664
5260	52	OFDM	17.71	17.69	18	Main	OFF	1.0 cm	Bystander	0.673
5260	52	OFDM	17.72	17.51	24	Main	OFF	1.0 cm	Bystander	0.669
5260	52	OFDM	17.66	17.49	36	Main	OFF	1.0 cm	Bystander	0.567
5260	52	OFDM	14.60	14.54	48	Main	OFF	1.0 cm	Bystander	0.331
5260	52	OFDM	13.92	14.01	54	Main	OFF	1.0 cm	Bystander	0.284
5260	52	OFDM	17.71	17.86	18	Main	ON	1.0 cm	Bystander	0.697
5260	52	OFDM	17.80	17.95	18	Aux	OFF	1.5 cm	Bystander	0.388
5260	52	OFDM	17.80	17.59	18	Aux	ON	1.5 cm	Bystander	0.392
<b>ANSI / IEEE C95.1 1992 - SAFETY LIMIT</b>							<b>Body</b>			
Spatial Peak							1.6 W/kg (mW/g)			
Uncontrolled Exposure/General Population							averaged over 1 gram			

**NOTES:**

1. The test data reported are the worst-case SAR value with the lap held position set in a typical configuration. Test procedures used are according to FCC/OET Bulletin 65, Supp.C [July 2001].
2. All modes of operation were investigated, and worst-case results are reported.
3. SAR Measurement System  DASY4  IDX  
Phantom Configuration  Left Head  Flat Phantom  Right Head
4. SAR Configuration  Head  Body  Hand
5. Test Signal Call Mode  Software  Base Station Simulator
6. Tissue parameters and temperatures are listed on the SAR plots.
7. Liquid tissue depth is 15.1 cm. ± 0.1
8. \* Average power measurements

  
**Alfred Cirwithian**  
 Vice President Engineering

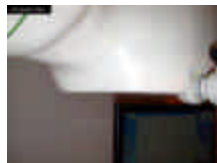

Figure A.8.1 Body SAR Test Setup  
 -- Bystander Position, LCD Open --  
 (Main Antenna)

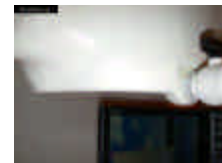

Figure A.8.2 Body SAR Test Setup  
 -- Bystander Position, LCD Open --  
 (Aux Antenna)

<b>PCTEST SAR &amp; RSS-102 TEST REPORT</b>	<b>FCC/ IC Measurement Report</b>				Reviewed by: Quality Manager
SAR Filename: SAR.0501050003-R1.ANO	Test Dates: Jan. 17-24, 2005	EUT Type: IBM Laptop PC ThinkPad X41 Tablet Series Model: 1866/1867/1868/1869 w/ 802.11b/g WLAN Adapter	FCC ID: ANO20040600BTL	IC ID: 349E-AR5BMB44	Page 24 of 32

# EXHIBIT A. SAR DATA SUMMARY (Continued)

Mixture Type: 5300MHz Muscle

A.9 MEASUREMENT RESULTS (IEEE 802.11a, Tablet, LCD Flip)										
FREQUENCY		Modulation	POWER*		Data Rate (Mbps)	Antenna	Bluetooth	Separation Distance (cm) ‡‡	Position	SAR (W/kg)
MHz	Ch.		Start	End						
5260	52	OFDM	17.71	17.88	18	Main	ON	0.0 cm	Right Side	0.019
5260	52	OFDM	17.71	17.84	18	Main	ON	0.0 cm	Bottom Side	0.039
5260	52	OFDM	17.71	17.94	18	Main	ON	0.0 cm	Left Side	0.347
5260	52	OFDM	17.80	18.01	18	Aux	ON	0.0 cm	Top Side	0.057
5260	52	OFDM	17.80	18.00	18	Aux	ON	0.0 cm	Bottom Side	0.023
5260	52	OFDM	17.80	17.92	18	Aux	ON	0.0 cm	Left Side	0.297
<b>ANSI / IEEE C95.1 1992 - SAFETY LIMIT Spatial Peak Uncontrolled Exposure/General Population</b>							<b>Body 1.6 W/kg (mW/g) averaged over 1 gram</b>			

**NOTES:**

1. The test data reported are the worst-case SAR value with the lap held position set in a typical configuration. Test procedures used are according to FCC/OET Bulletin 65, Supp.C [July 2001].
2. All modes of operation were investigated, and worst-case results are reported.
3. SAR Measurement System  DASY4  IDX  
Phantom Configuration  Left Head  Flat Phantom  Right Head
4. SAR Configuration  Head  Body  Hand
5. Test Signal Call Mode  Software  Base Station Simulator
6. Tissue parameters and temperatures are listed on the SAR plots.
7. Liquid tissue depth is 15.1 cm. ± 0.1
8. \* Average power measurements

  
Alfred Cirwithian  
Vice President Engineering

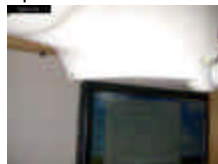

Figure A.9.1 Body SAR Test Setup -- Tablet Position, LCD Flip -- (Top Side)



Figure A.9.2 Body SAR Test Setup -- Tablet Position, LCD Flip -- (Bottom Side)

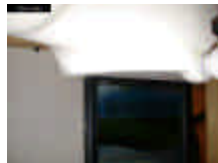

Figure A.9.3 Body SAR Test Setup -- Tablet Position, LCD Flip -- (Right Side)



Figure A.9.4 Body SAR Test Setup -- Tablet Position, LCD Flip -- (Left Side)

PCTEST SAR & RSS-102 TEST REPORT	FCC/ IC Measurement Report			Reviewed by: Quality Manager
SAR Filename: SAR.0501050003-R1.ANO	Test Dates: Jan. 17-24, 2005	EUT Type: IBM Laptop PC ThinkPad X41 Tablet Series Model: 1866/1867/1868/1869 w/ 802.11b/g WLAN Adapter	FCC ID: ANO20040600BTL	IC ID: 349E-AR5BMB44
				Page 25 of 32

# EXHIBIT A. SAR DATA SUMMARY (Continued)

Mixture Type: 5800MHz Muscle

<b>A.10 MEASUREMENT RESULTS ( IEEE 802.11a, Laptop, LCD Flip)</b>										
FREQUENCY		Modulation	POWER*		Data Rate (Mbps)	Antenna	Bluetooth	Separation Distance (cm) ‡‡	Position	SAR (W/kg)
MHz	Ch.		Start	End						
5785	157	OFDM	16.93	17.11	18	Main	OFF	0.0 cm	Laptop	0.112
5785	157	OFDM	16.93	17.12	18	Main	ON	0.0 cm	Laptop	0.114
5785	157	OFDM	17.05	17.23	18	Aux	OFF	0.0 cm	Laptop	0.053
5785	157	OFDM	17.05	17.20	18	Aux	ON	0.0 cm	Laptop	0.052
<b>ANSI / IEEE C95.1 1992 - SAFETY LIMIT Spatial Peak Uncontrolled Exposure/General Population</b>							<b>Body 1.6 W/kg (mW/g) averaged over 1 gram</b>			

**NOTES:**

1. The test data reported are the worst-case SAR value with the lap held position set in a typical configuration. Test procedures used are according to FCC/OET Bulletin 65, Supp.C [July 2001].
2. All modes of operation were investigated, and worst-case results are reported.
3. SAR Measurement System                    DASY4                    IDX  
Phantom Configuration                    Left Head                    Flat Phantom                    Right Head
4. SAR Configuration                    Head                    Body                    Hand
5. Test Signal Call Mode                    Software                    Base Station Simulator
6. Tissue parameters and temperatures are listed on the SAR plots.
7. Liquid tissue depth is 15.1 cm. ± 0.1
8. \* Average power measurements

  
 Alfred Cirwithian  
 Vice President Engineering

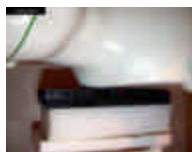

Figure A.10.1 Body SAR Test Setup  
-- Laptop Position, LCD Flip --  
(Main Antenna)



Figure A.10.2 Body SAR Test Setup  
-- Laptop Position, LCD Flip --  
(Aux Antenna)

PCTEST SAR & RSS-102 TEST REPORT	<b>FCC/ IC Measurement Report</b>				Reviewed by: Quality Manager
SAR Filename: SAR.0501050003-R1.ANO	Test Dates: Jan. 17-24, 2005	EUT Type: IBM Laptop PC ThinkPad X41 Tablet Series Model: 1866/1867/1868/1869 w/ 802.11b/g WLAN Adapter	FCC ID: ANO20040600BTL	IC ID: 349E-AR5BMB44	Page 26 of 32



# EXHIBIT A. SAR DATA SUMMARY (Continued)

Mixture Type: 5800MHz Muscle

<b>A.11 MEASUREMENT RESULTS (IEEE 802.11a, Bystander, LCD Open)</b>										
FREQUENCY		Modulation	POWER*		Data Rate (Mbps)	Antenna	Bluetooth	Separation Distance (cm) ‡	Position	SAR (W/kg)
MHz	Ch.		Start	End						
5785	157	OFDM	16.93	17.05	18	Main	OFF	1.5 cm	Bystander	0.633
5785	157	OFDM	16.93	17.05	18	Main	ON	1.5 cm	Bystander	0.632
5785	157	OFDM	17.05	17.26	18	Aux	OFF	1.5 cm	Bystander	0.509
5785	157	OFDM	17.05	17.25	18	Aux	ON	1.5 cm	Bystander	0.495
ANSI / IEEE C95.1 1992 - SAFETY LIMIT Spatial Peak Uncontrolled Exposure/General Population							Body 1.6 W/kg (mW/g) averaged over 1 gram			

**NOTES:**

1. The test data reported are the worst-case SAR value with the lap held position set in a typical configuration. Test procedures used are according to FCC/OET Bulletin 65, Supp.C [July 2001].
2. All modes of operation were investigated, and worst-case results are reported.
3. SAR Measurement System                    DASY4                    IDX  
Phantom Configuration                    Left Head                    Flat Phantom                    Right Head
4. SAR Configuration                    Head                    Body                    Hand
5. Test Signal Call Mode                    Software                    Base Station Simulator
6. Tissue parameters and temperatures are listed on the SAR plots.
7. Liquid tissue depth is 15.1 cm. ± 0.1
8. \* Average power measurements



**Alfred Cirwilhian**  
Vice President Engineering

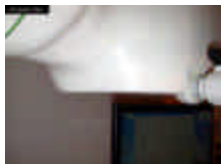

**Figure A.11.1 Body SAR Test Setup  
-- Bystander Position, LCD Open --  
(Main Antenna)**

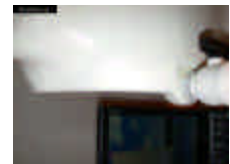

**Figure A.11.2 Body SAR Test Setup  
-- Bystander Position, LCD Open --  
(Aux Antenna)**

# EXHIBIT A. SAR DATA SUMMARY (Continued)

Mixture Type: 5800MHz Muscle

A.12 MEASUREMENT RESULTS (IEEE 802.11a, Tablet, LCD Flip)										
FREQUENCY		Modulation	POWER*		Data Rate (Mbps)	Antenna	Bluetooth	Separation Distance (cm) ‡	Position	SAR (W/kg)
MHz	Ch.		Start	End						
5785	157	OFDM	16.93	17.10	18	Main	ON	0.0 cm	Right Side	0.062
5785	157	OFDM	16.93	17.02	18	Main	ON	0.0 cm	Bottom Side	0.104
5785	157	OFDM	16.93	17.17	18	Main	ON	0.0 cm	Left Side	0.359
5785	157	OFDM	17.05	17.24	18	Aux	ON	0.0 cm	Top Side	0.128
5785	157	OFDM	17.05	17.21	18	Aux	ON	0.0 cm	Bottom Side	0.105
5785	157	OFDM	17.05	17.26	18	Aux	ON	0.0 cm	Left Side	0.372
<b>ANSI / IEEE C95.1 1992 - SAFETY LIMIT</b>										
<b>Spatial Peak</b>										
<b>Uncontrolled Exposure/General Population</b>							<b>Body</b> <b>1.6 W/kg (mW/g)</b> averaged over 1 gram			

**NOTES:**

1. The test data reported are the worst-case SAR value with the lap held position set in a typical configuration. Test procedures used are according to FCC/OET Bulletin 65, Supp.C [July 2001].
2. All modes of operation were investigated, and worst-case results are reported.
3. SAR Measurement System  DASY4  IDX  
Phantom Configuration  Left Head  Flat Phantom  Right Head
4. SAR Configuration  Head  Body  Hand
5. Test Signal Call Mode  Software  Base Station Simulator
6. Tissue parameters and temperatures are listed on the SAR plots.
7. Liquid tissue depth is 15.1 cm. ± 0.1
8. \* Average power measurements

Alfred

---

**Alfred Cirwithian**  
Vice President Engineering

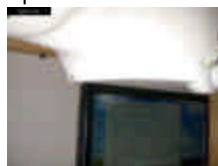

**Figure A.12.1 Body SAR Test Setup -- Tablet Position, LCD Flip -- (Top Side)**



**Figure A.12.2 Body SAR Test Setup -- Tablet Position, LCD Flip -- (Bottom Side)**

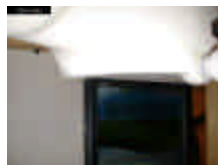



**Figure A.12.3 Body SAR Test Setup -- Tablet Position, LCD Flip -- (Right Side)**



**Figure A.12.4 Body SAR Test Setup -- Tablet Position, LCD Flip -- (Left Side)**

<b>PCTEST SAR &amp; RSS-102 TEST REPORT</b>	<b>FCC/ IC Measurement Report</b>				Reviewed by: Quality Manager
SAR Filename: SAR.0501050003-R1.ANO	Test Dates: Jan. 17-24, 2005	EUT Type: IBM Laptop PC ThinkPad X41 Tablet Series Model: 1866/1867/1868/1869 w/ 802.11b/g WLAN Adapter	FCC ID: ANO20040600BTL	IC ID: 349E-AR5BMB44	Page 28 of 32

## ATTACHMENT A – SAR TEST DATA

PCTEST SAR & RSS-102 TEST REPORT	 <b>FCC/ IC Measurement Report</b> 			Reviewed by: Quality Manager	
SAR Filename: SAR.0501050003-R1.ANO	Test Dates: Jan. 17-24, 2005	EUT Type: IBM Laptop PC ThinkPad X41 Tablet Series Model: 1866/1867/1868/1869 w/ 802.11b/g WLAN Adapter	FCC ID: ANO20040600BTL	IC ID: 349E-AR5BMB44	Page 29 of 32

# PCTEST ENGINEERING LABORATORY, INC.

**DUT: AR5BMB-44; Type: IBM 802.11a/b/g WLAN Adapter; Serial: #4**

Communication System: IEEE 802.11b; Frequency: 2437 MHz; Duty Cycle: 1:1

Medium: 2450 Muscle ( $\sigma = 1.90$  mho/m,  $\epsilon_r = 53.31$ ,  $\rho = 1000$  kg/m<sup>3</sup>)

Phantom section: Flat Section; Space: 0.0 cm

Test Date: 01-21-2005; Ambient Temp: 22.5°C; Tissue Temp: 20.4°C

Probe: EX3DV4 - SN3550; ConvF(6.27, 6.27, 6.27); Calibrated: 10/26/2004

Sensor-Surface: 3mm (Mechanical Surface Detection)

Electronics: DAE4 Sn637; Calibrated: 9/22/2004

Phantom: SAM 12b; Type: SAM 4.0; Serial: TP:1197

Measurement SW: DASY4, V4.4 Build 3; Postprocessing SW: SEMCAD, V1.8 Build 130

**Laptop Position, LCD Flip, ch.06, 1Mbps, Main antenna, Bluetooth on**

**Area Scan (8x11x1):** Measurement grid: dx=15mm, dy=15mm

**Zoom Scan (5x5x7)/Cube 0:** Measurement grid: dx=8mm, dy=8mm, dz=5mm

Reference Value = 3.87 V/m

Peak SAR (extrapolated) = 0.057 W/kg

**SAR(1 g) = 0.028 mW/g; SAR(10 g) = 0.018 mW/g**

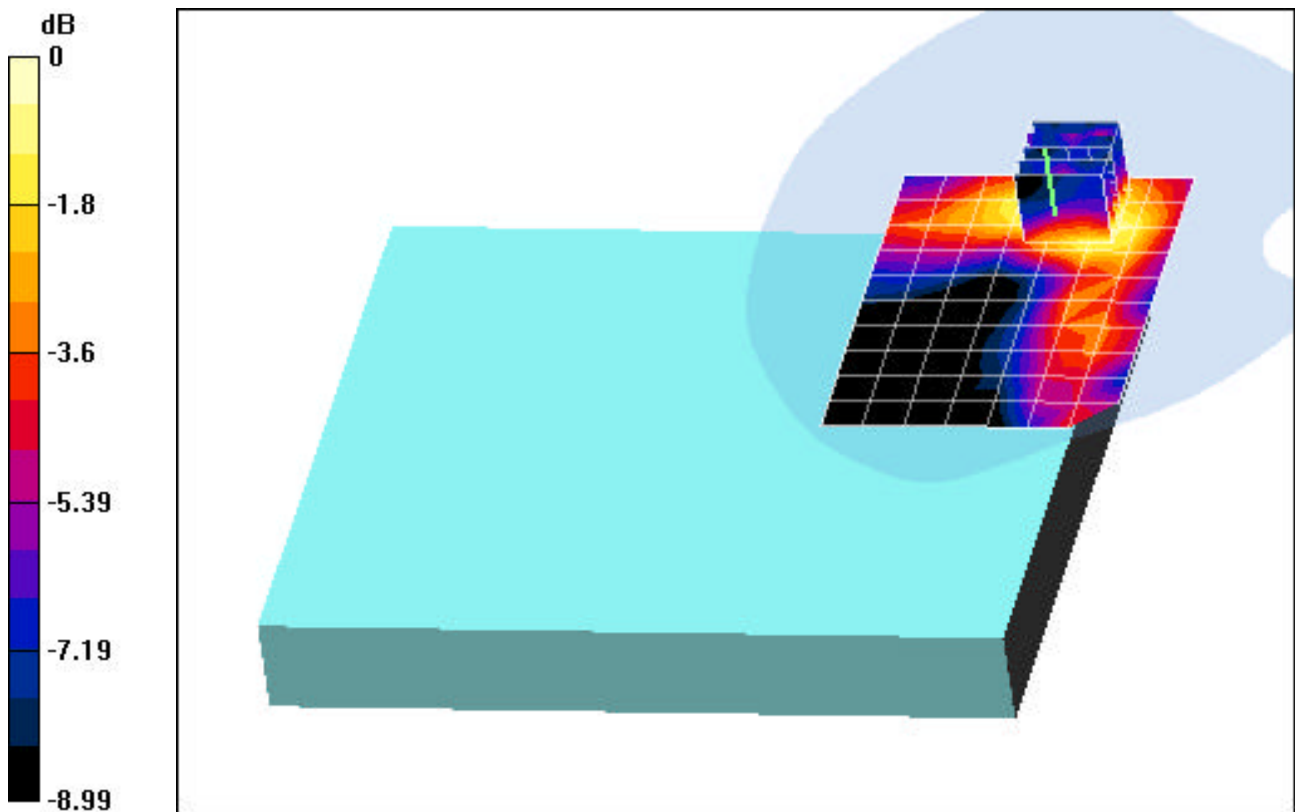

0 dB = 0.034mW/g

# PCTEST ENGINEERING LABORATORY, INC.

**DUT: AR5BMB-44; Type: IBM 802.11a/b/g WLAN Adapter; Serial: #4**

Communication System: IEEE 802.11b; Frequency: 2437 MHz; Duty Cycle: 1:1

Medium: 2450 Muscle ( $\sigma = 1.90$  mho/m,  $\epsilon_r = 53.31$ ,  $\rho = 1000$  kg/m<sup>3</sup>)

Phantom section: Flat Section; Space: 1.0 cm

Test Date: 01-21-2005; Ambient Temp: 22.5°C; Tissue Temp: 20.4°C

Probe: EX3DV4 - SN3550; ConvF(6.27, 6.27, 6.27); Calibrated: 10/26/2004

Sensor-Surface: 3mm (Mechanical Surface Detection)

Electronics: DAE4 Sn637; Calibrated: 9/22/2004

Phantom: SAM 12b; Type: SAM 4.0; Serial: TP:1197

Measurement SW: DASY4, V4.4 Build 3; Postprocessing SW: SEMCAD, V1.8 Build 130

**Bystander position, LCD Open, ch.06, 1Mbps, Main antenna, Bluetooth off**

**Area Scan (7x11x1):** Measurement grid: dx=15mm, dy=15mm

**Zoom Scan (5x5x7)/Cube 0:** Measurement grid: dx=8mm, dy=8mm, dz=5mm

Reference Value = 8.52 V/m

Peak SAR (extrapolated) = 0.566 W/kg

**SAR(1 g) = 0.289 mW/g; SAR(10 g) = 0.146 mW/g**

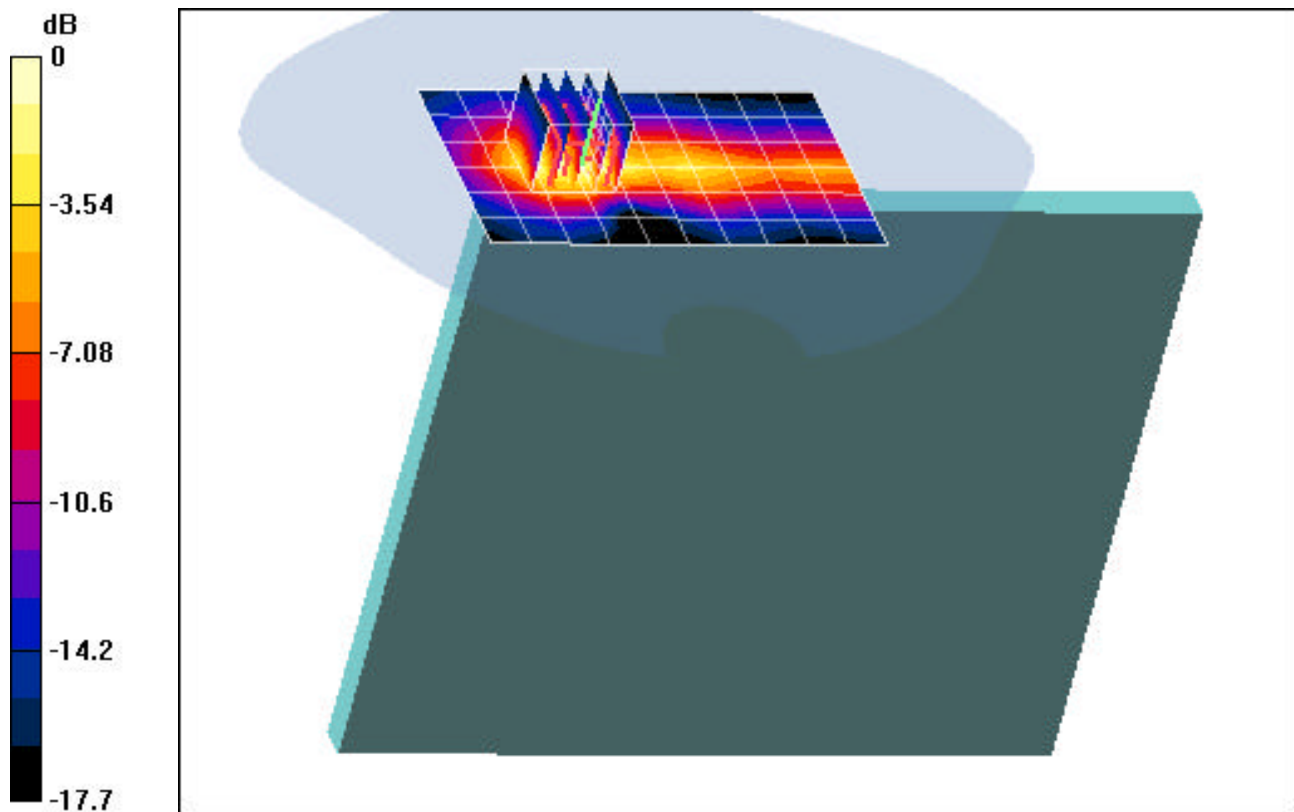

0 dB = 0.359mW/g

# PCTEST ENGINEERING LABORATORY, INC.

**DUT: AR5BMB-44; Type: IBM 802.11a/b/g WLAN Adapter; Serial: #4**

Communication System: IEEE 802.11b; Frequency: 2437 MHz; Duty Cycle: 1:1

Medium: 2450 Muscle ( $\sigma = 1.90$  mho/m,  $\epsilon_r = 53.31$ ,  $\rho = 1000$  kg/m<sup>3</sup>)

Phantom section: Flat Section; Space: 0.0 cm

Test Date: 01-21-2005; Ambient Temp: 22.5°C; Tissue Temp: 20.4°C

Probe: EX3DV4 - SN3550; ConvF(6.27, 6.27, 6.27); Calibrated: 10/26/2004

Sensor-Surface: 3mm (Mechanical Surface Detection)

Electronics: DAE4 Sn637; Calibrated: 9/22/2004

Phantom: SAM 12b; Type: SAM 4.0; Serial: TP:1197

Measurement SW: DASY4, V4.4 Build 3; Postprocessing SW: SEMCAD, V1.8 Build 130

**Tablet position, Left side, LCD Flip, ch.06, 1Mbps, Main antenna, Bluetooth on**

**Area Scan (5x19x1):** Measurement grid: dx=15mm, dy=15mm

**Zoom Scan (5x5x7)/Cube 0:** Measurement grid: dx=8mm, dy=8mm, dz=5mm

Reference Value = 1.94 V/m

Peak SAR (extrapolated) = 0.306 W/kg

**SAR(1 g) = 0.127 mW/g; SAR(10 g) = 0.056 mW/g**

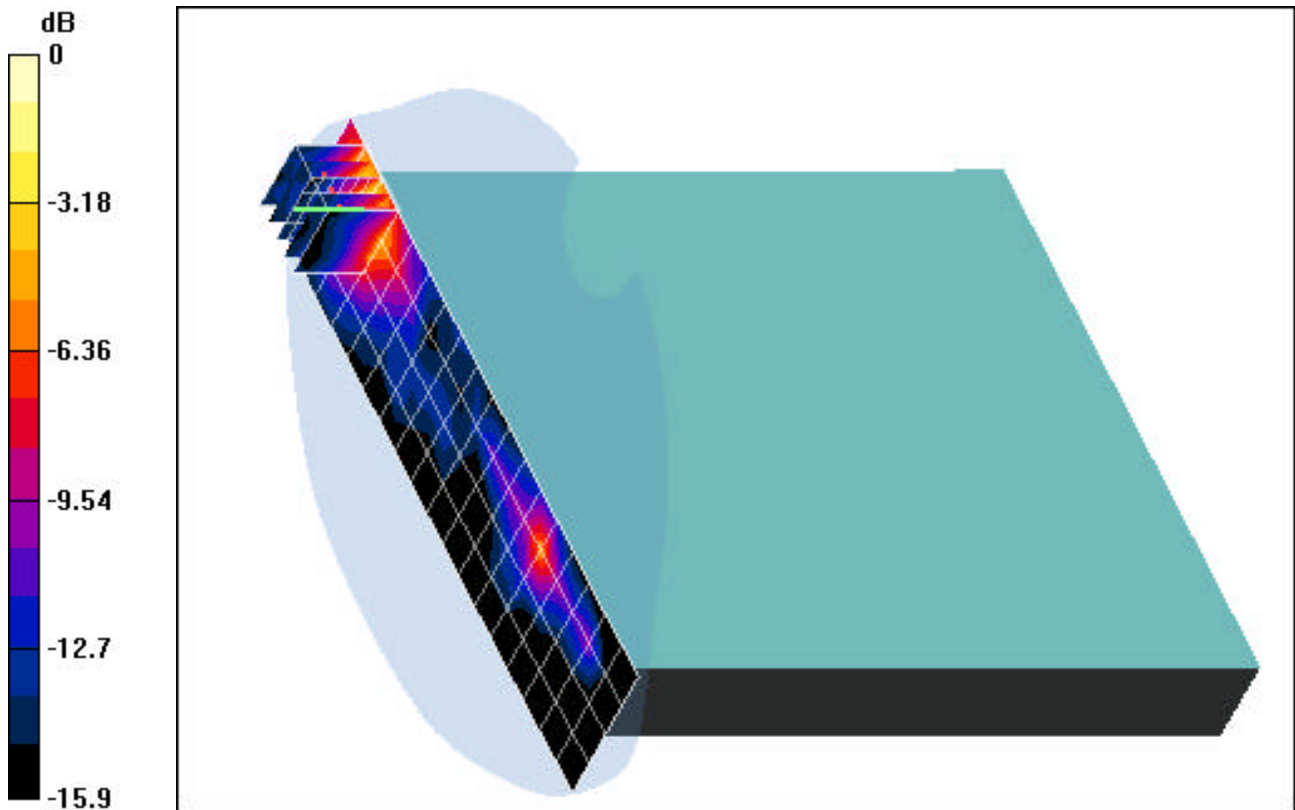

0 dB = 0.183mW/g



# PCTEST ENGINEERING LABORATORY, INC.

**DUT: AR5BMB-44; Type: IBM 802.11a/b/g WLAN Adapter; Serial: #4**

Communication System: IEEE 802.11g; Frequency: 2437 MHz; Duty Cycle: 1:1

Medium: 2450 Muscle ( $\sigma = 1.90$  mho/m,  $\epsilon_r = 53.31$ ,  $\rho = 1000$  kg/m<sup>3</sup>)

Phantom section: Flat Section; Space: 0.0 cm

Test Date: 01-21-2005; Ambient Temp: 22.5°C; Tissue Temp: 20.4°C

Probe: EX3DV4 - SN3550; ConvF(6.27, 6.27, 6.27); Calibrated: 10/26/2004

Sensor-Surface: 3mm (Mechanical Surface Detection)

Electronics: DAE4 Sn637; Calibrated: 9/22/2004

Phantom: SAM 12b; Type: SAM 4.0; Serial: TP:1197

Measurement SW: DASY4, V4.4 Build 3; Postprocessing SW: SEMCAD, V1.8 Build 130

**Laptop Position, LCD Flip, ch.06, 24Mbps, Aux antenna, Bluetooth off**

**Area Scan (7x11x1):** Measurement grid: dx=15mm, dy=15mm

**Zoom Scan (5x5x7)/Cube 0:** Measurement grid: dx=8mm, dy=8mm, dz=5mm

Reference Value = 2.73 V/m

Peak SAR (extrapolated) = 0.059 W/kg

**SAR(1 g) = 0.031 mW/g; SAR(10 g) = 0.017 mW/g**

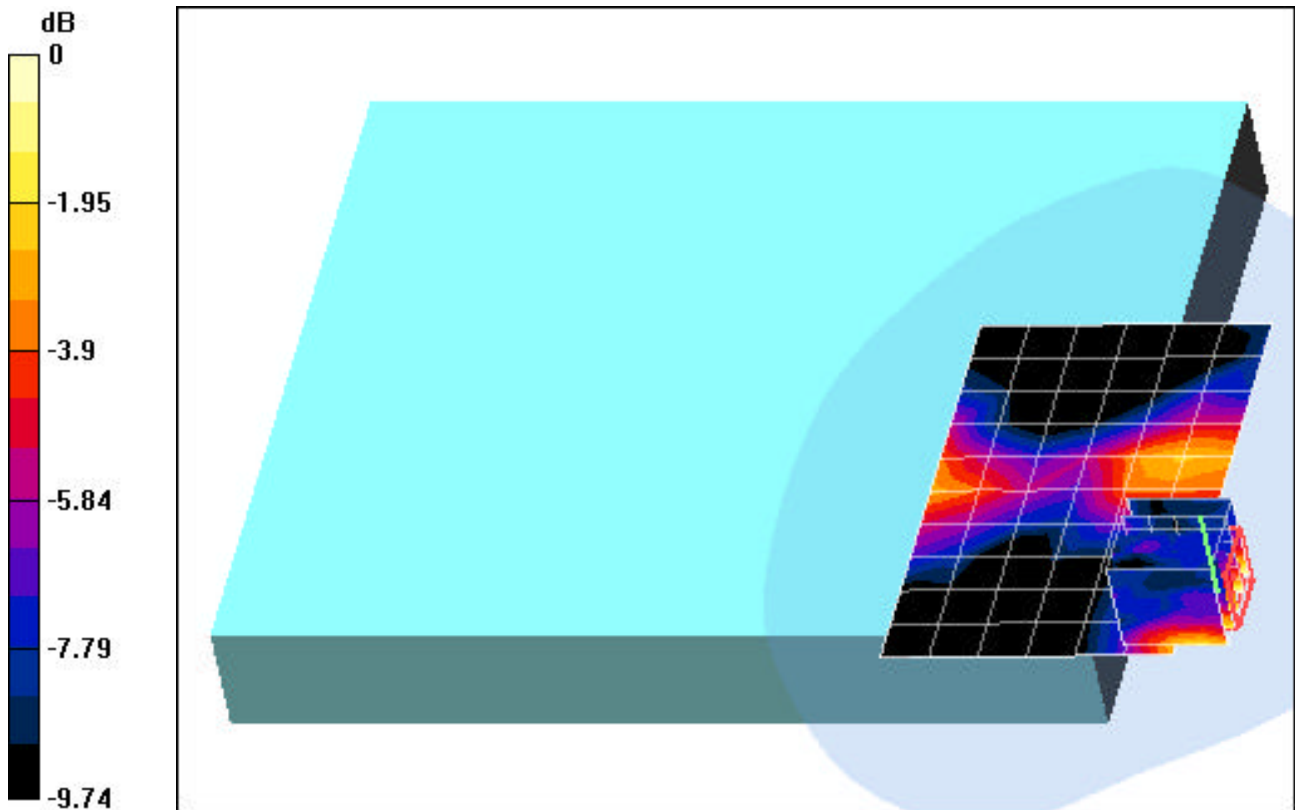

0 dB = 0.038mW/g

# PCTEST ENGINEERING LABORATORY, INC.

**DUT: AR5BMB-44; Type: IBM 802.11a/b/g WLAN Adapter; Serial: #4**

Communication System: IEEE 802.11g; Frequency: 2437 MHz; Duty Cycle: 1:1

Medium: 2450 Muscle ( $\sigma = 1.90$  mho/m,  $\epsilon_r = 53.31$ ,  $\rho = 1000$  kg/m<sup>3</sup>)

Phantom section: Flat Section; Space: 1.0 cm

Test Date: 01-20-2005; Ambient Temp: 23.4°C; Tissue Temp: 20.4°C

Probe: EX3DV4 - SN3550; ConvF(6.27, 6.27, 6.27); Calibrated: 10/26/2004

Sensor-Surface: 3mm (Mechanical Surface Detection)

Electronics: DAE4 Sn637; Calibrated: 9/22/2004

Phantom: SAM 12b; Type: SAM 4.0; Serial: TP:1197

Measurement SW: DASY4, V4.4 Build 3; Postprocessing SW: SEMCAD, V1.8 Build 130

**Bystander position, LCD Open, ch.06, 24Mbps, Main antenna, Bluetooth off**

**Area Scan (7x11x1):** Measurement grid: dx=15mm, dy=15mm

**Zoom Scan (5x5x7)/Cube 0:** Measurement grid: dx=8mm, dy=8mm, dz=5mm

Reference Value = 7.93 V/m

Peak SAR (extrapolated) = 0.564 W/kg

**SAR(1 g) = 0.285 mW/g; SAR(10 g) = 0.145 mW/g**

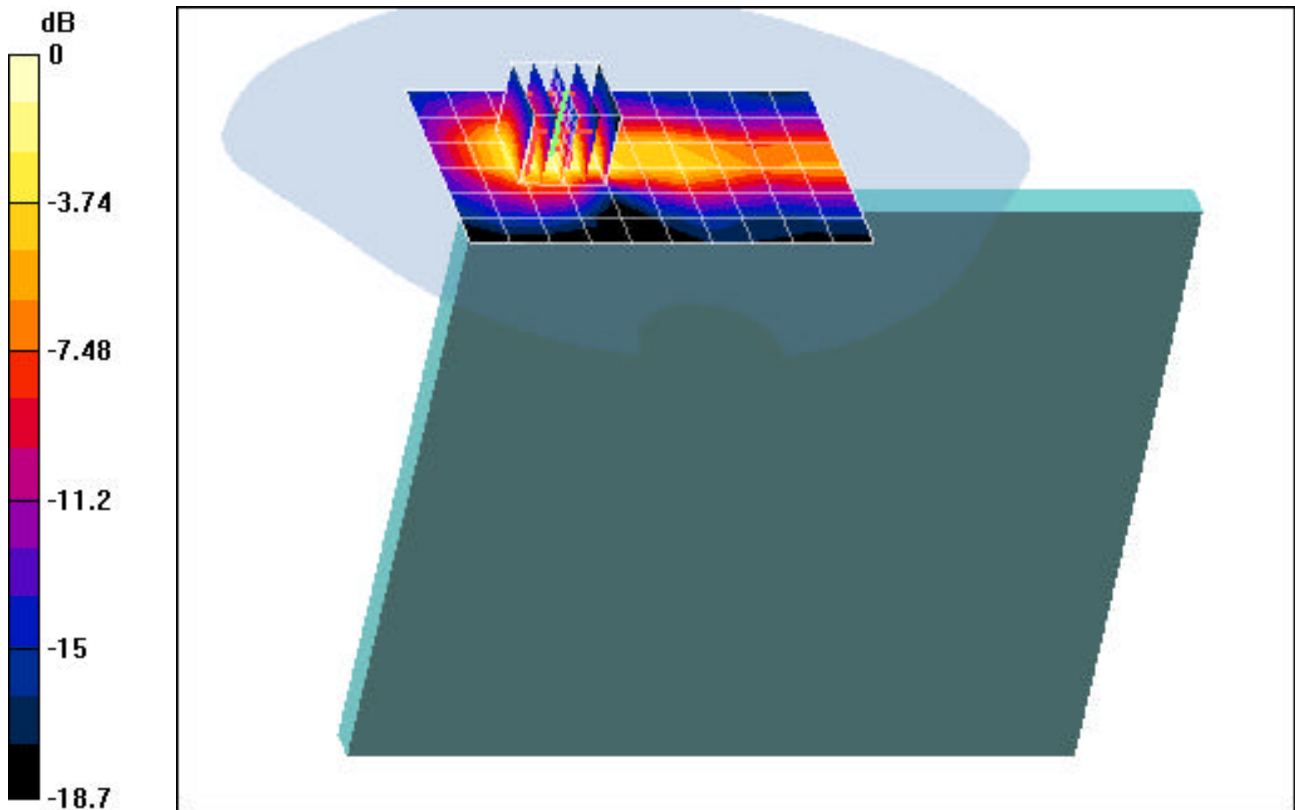

0 dB = 0.365mW/g

# PCTEST ENGINEERING LABORATORY, INC.

**DUT: AR5BMB-44; Type: IBM 802.11a/b/g WLAN Adapter; Serial: #4**

Communication System: IEEE 802.11g; Frequency: 2437 MHz; Duty Cycle: 1:1

Medium: 2450 Muscle ( $\sigma = 1.90$  mho/m,  $\epsilon_r = 53.31$ ,  $\rho = 1000$  kg/m<sup>3</sup>)

Phantom section: Flat Section; Space: 0.0 cm

Test Date: 01-24-2005; Ambient Temp: 22.6°C; Tissue Temp: 20.2°C

Probe: EX3DV4 - SN3550; ConvF(6.27, 6.27, 6.27); Calibrated: 10/26/2004

Sensor-Surface: 3mm (Mechanical Surface Detection)

Electronics: DAE4 Sn637; Calibrated: 9/22/2004

Phantom: SAM 12b; Type: SAM 4.0; Serial: TP:1197

Measurement SW: DASY4, V4.4 Build 3; Postprocessing SW: SEMCAD, V1.8 Build 130

**Tablet position, Left side, LCD Flip, ch.06, 24Mbps, Main antenna, Bluetooth on**

**Area Scan (5x19x1):** Measurement grid: dx=15mm, dy=15mm

**Zoom Scan (5x5x7)/Cube 0:** Measurement grid: dx=8mm, dy=8mm, dz=5mm

Reference Value = 2.18 V/m

Peak SAR (extrapolated) = 0.379 W/kg

**SAR(1 g) = 0.129 mW/g; SAR(10 g) = 0.054 mW/g**

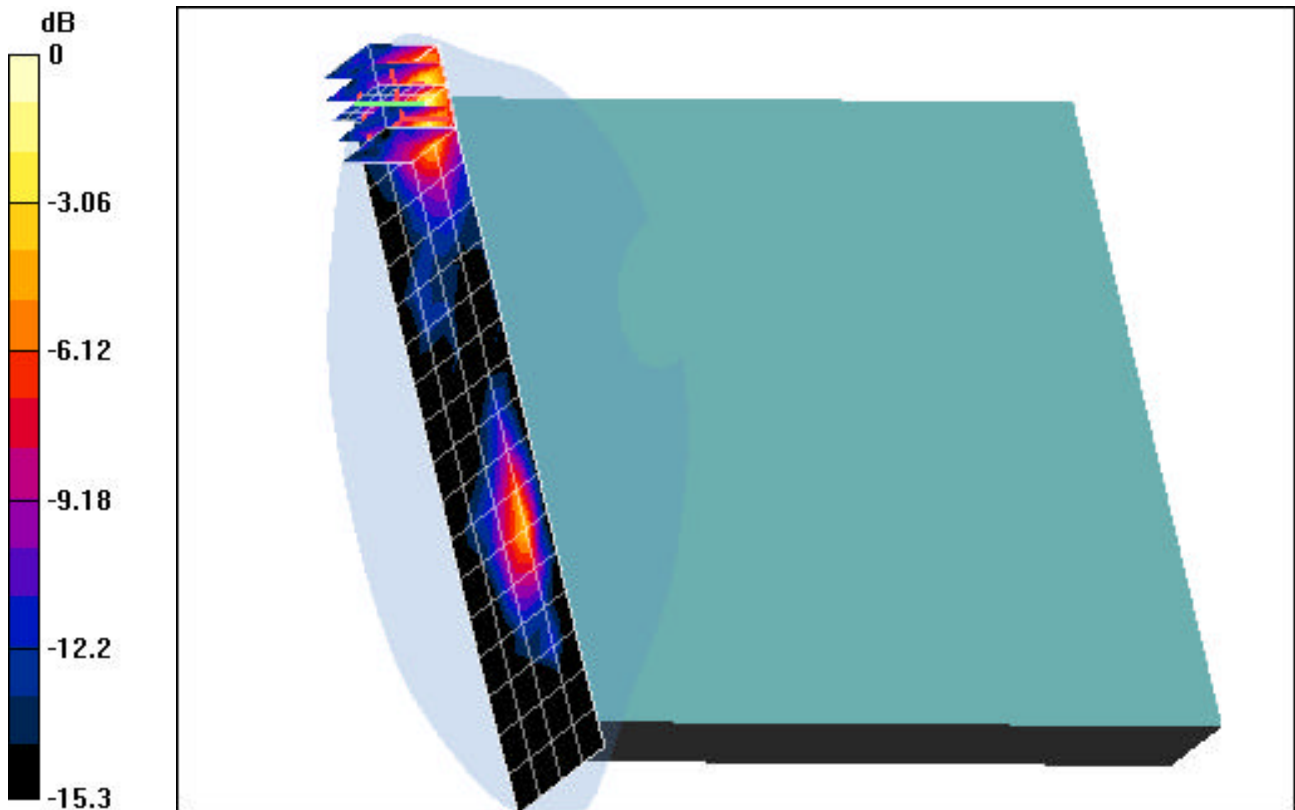

0 dB = 0.189mW/g

# PCTEST ENGINEERING LABORATORY, INC.

**DUT: AR5BMB-44; Type: IBM 802.11a/b/g WLAN Adapter; Serial: #4**

Communication System: IEEE 802.11a; Frequency: 5260 MHz; Duty Cycle: 1:1

Medium: 5300 Muscle ( $\sigma = 5.41$  mho/m,  $\epsilon_r = 48.06$ ,  $\rho = 1000$  kg/m<sup>3</sup>)

Phantom section: Flat Section; Space: 0.0 cm

Test Date: 01-20-2005; Ambient Temp: 22.9°C; Tissue Temp: 20.2°C

Probe: EX3DV4 - SN3550; ConvF(3.72, 3.72, 3.72); Calibrated: 10/26/2004

Sensor-Surface: 3mm (Mechanical Surface Detection)

Electronics: DAE4 Sn637; Calibrated: 9/22/2004

Phantom: SAM 12b; Type: SAM 4.0; Serial: TP:1197

Measurement SW: DAS4, V4.4 Build 3; Postprocessing SW: SEMCAD, V1.8 Build 130

**Laptop Position, LCD Flip, ch.52, 18Mbps, Main antenna, Bluetooth on**

**Area Scan (13x7x1):** Measurement grid: dx=10mm, dy=10mm

**Zoom Scan (8x8x8)/Cube 0:** Measurement grid: dx=4.3mm, dy=4.3mm, dz=3mm

Reference Value = 2.56 V/m

Peak SAR (extrapolated) = 0.822 W/kg

**SAR(1 g) = 0.094 mW/g; SAR(10 g) = 0.048 mW/g**

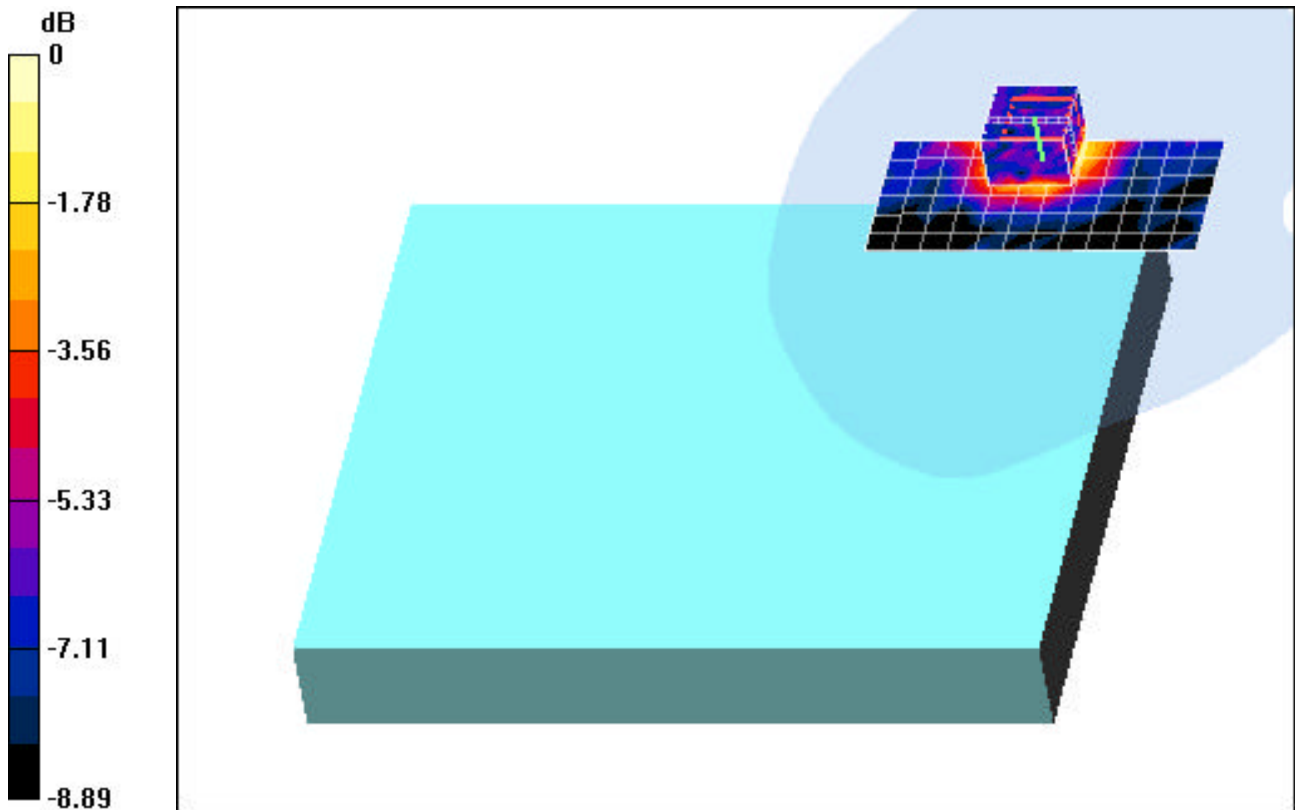

0 dB = 0.098mW/g

# PCTEST ENGINEERING LABORATORY, INC.

**DUT: AR5BMB-44; Type: IBM 802.11a/b/g WLAN Adapter; Serial: #4**

Communication System: IEEE 802.11a; Frequency: 5260 MHz; Duty Cycle: 1:1

Medium: 5300 Muscle ( $\sigma = 5.41$  mho/m,  $\epsilon_r = 48.06$ ,  $\rho = 1000$  kg/m<sup>3</sup>)

Phantom section: Flat Section; Space: 1.0 cm

Test Date: 01-17-2005; Ambient Temp: 23.6°C; Tissue Temp: 21.2°C

Probe: EX3DV4 - SN3550; ConvF(3.72, 3.72, 3.72); Calibrated: 10/26/2004

Sensor-Surface: 3mm (Mechanical Surface Detection)

Electronics: DAE4 Sn637; Calibrated: 9/22/2004

Phantom: SAM 12b; Type: SAM 4.0; Serial: TP:1197

Measurement SW: DASY4, V4.4 Build 3; Postprocessing SW: SEMCAD, V1.8 Build 130

**Bystander position, LCD Open, ch.52, 18Mbps, Main antenna, Bluetooth on**

**Area Scan (6x13x1):** Measurement grid: dx=10mm, dy=10mm

**Zoom Scan (8x8x8)/Cube 0:** Measurement grid: dx=4.3mm, dy=4.3mm, dz=3mm

Reference Value = 5.96 V/m

Peak SAR (extrapolated) = 2.49 W/kg

**SAR(1 g) = 0.697 mW/g; SAR(10 g) = 0.239 mW/g**

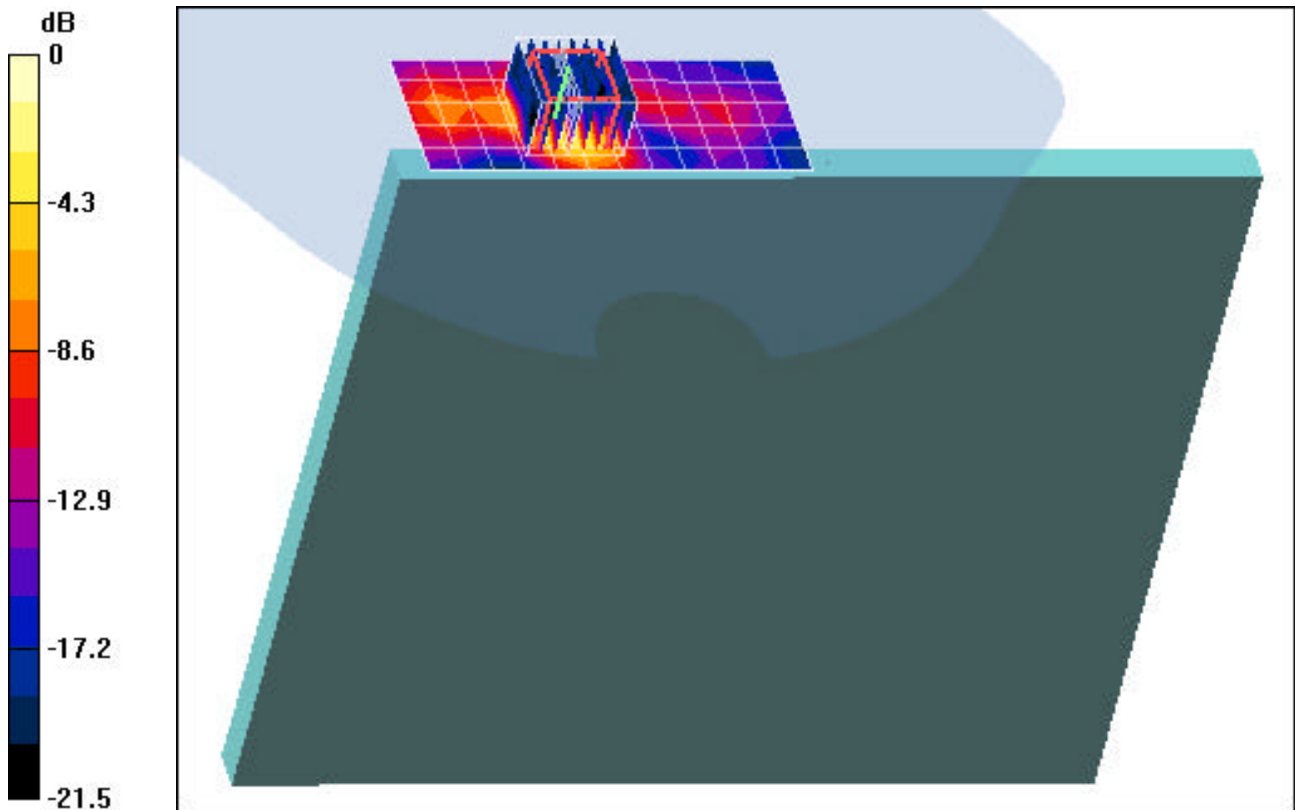

0 dB = 0.977mW/g

# PCTEST ENGINEERING LABORATORY, INC.

**DUT: AR5BMB-44; Type: IBM 802.11a/b/g WLAN Adapter; Serial: #4**

Communication System: IEEE 802.11a; Frequency: 5260 MHz; Duty Cycle: 1:1

Medium: 5300 Muscle ( $\sigma = 5.41$  mho/m,  $\epsilon_r = 48.06$ ,  $\rho = 1000$  kg/m<sup>3</sup>)

Phantom section: Flat Section; Space: 0.0 cm

Test Date: 01-19-2005; Ambient Temp: 23.0°C; Tissue Temp: 20.4°C

Probe: EX3DV4 - SN3550; ConvF(3.72, 3.72, 3.72); Calibrated: 10/26/2004

Sensor-Surface: 3mm (Mechanical Surface Detection)

Electronics: DAE4 Sn637; Calibrated: 9/22/2004

Phantom: SAM 12b; Type: SAM 4.0; Serial: TP:1197

Measurement SW: DASY4, V4.4 Build 3; Postprocessing SW: SEMCAD, V1.8 Build 130

**Tablet position, Left side, LCD Flip, ch.52, 18Mbps, Main antenna, Bluetooth on**

**Area Scan (7x27x1):** Measurement grid: dx=10mm, dy=10mm

**Zoom Scan (8x8x8)/Cube 0:** Measurement grid: dx=4.3mm, dy=4.3mm, dz=3mm

Reference Value = 3.44 V/m

Peak SAR (extrapolated) = 0.839 W/kg

**SAR(1 g) = 0.347 mW/g; SAR(10 g) = 0.154 mW/g**

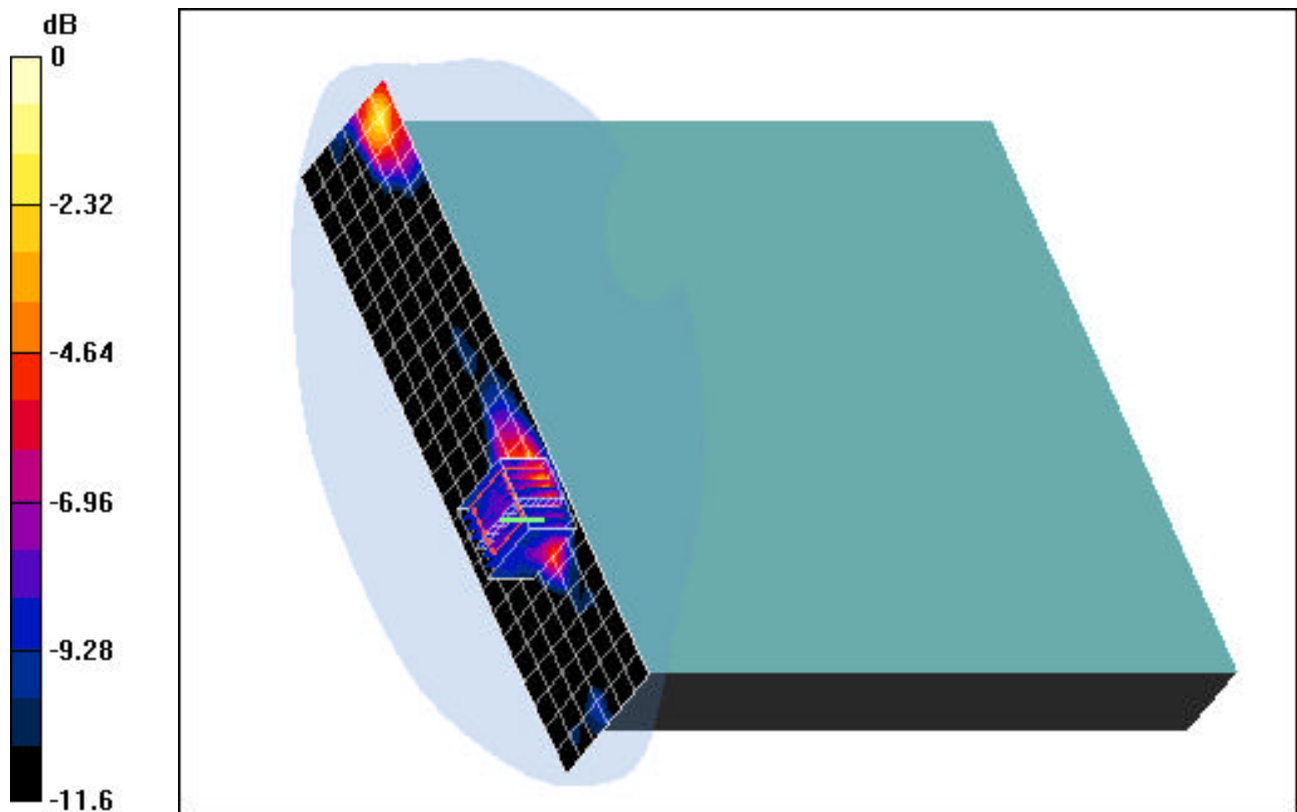

0 dB = 0.474mW/g

# PCTEST ENGINEERING LABORATORY, INC.

**DUT: AR5BMB- 44; Type: IBM 802.11a/b/g WLAN Adapter; Serial: #4**

Communication System: IEEE 802.11a; Frequency: 5785 MHz; Duty Cycle: 1:1

Medium: 5800 Muscle ( $\sigma = 5.94$  mho/m,  $\epsilon_r = 48.21$ ,  $\rho = 1000$  kg/m<sup>3</sup>)

Phantom section: Flat Section; Space: 0.0 cm

Test Date: 01-20-2005; Ambient Temp: 22.8°C; Tissue Temp: 20.5°C

Probe: EX3DV4 - SN3550; ConvF(3.48, 3.48, 3.48); Calibrated: 10/26/2004

Sensor-Surface: 3mm (Mechanical Surface Detection)

Electronics: DAE4 Sn637; Calibrated: 9/22/2004

Phantom: SAM 12b; Type: SAM 4.0; Serial: TP:1197

Measurement SW: DASY4, V4.4 Build 3; Postprocessing SW: SEMCAD, V1.8 Build 130

**Laptop Position, LCD Flip, ch.157, 18Mbps, Main antenna, Bluetooth on**

**Area Scan (13x7x1):** Measurement grid: dx=10mm, dy=10mm

**Zoom Scan (8x8x8)/Cube 0:** Measurement grid: dx=4.3mm, dy=4.3mm, dz=3mm

Reference Value = 3.11 V/m

Peak SAR (extrapolated) = 0.532 W/kg

**SAR(1 g) = 0.114 mW/g; SAR(10 g) = 0.061 mW/g**

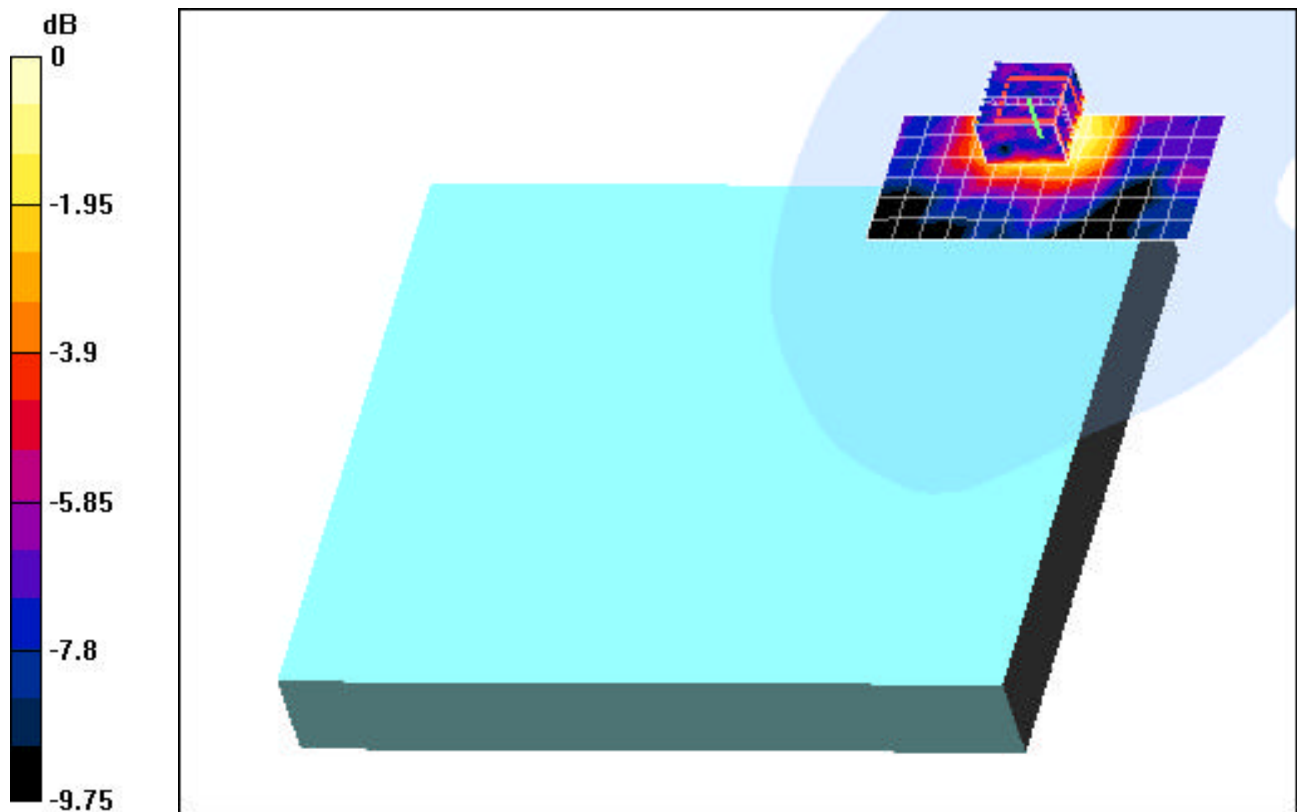

0 dB = 0.131mW/g



# PCTEST ENGINEERING LABORATORY, INC.

**DUT: AR5BMB-44; Type: IBM 802.11a/b/g WLAN Adapter; Serial: #4**

Communication System: IEEE 802.11a; Frequency: 5785 MHz; Duty Cycle: 1:1

Medium: 5800 Muscle ( $\sigma = 5.94$  mho/m,  $\epsilon_r = 48.21$ ,  $\rho = 1000$  kg/m<sup>3</sup>)

Phantom section: Flat Section; Space: 1.5 cm

Test Date: 01-17-2005; Ambient Temp: 23.2°C; Tissue Temp: 20.8°C

Probe: EX3DV4 - SN3550; ConvF(3.48, 3.48, 3.48); Calibrated: 10/26/2004

Sensor-Surface: 3mm (Mechanical Surface Detection)

Electronics: DAE4 Sn637; Calibrated: 9/22/2004

Phantom: SAM 12b; Type: SAM 4.0; Serial: TP:1197

Measurement SW: DASY4, V4.4 Build 3; Postprocessing SW: SEMCAD, V1.8 Build 130

**Bystander position, LCD Open, ch.157, 18Mbps, Main antenna, Bluetooth off**

**Area Scan (6x13x1):** Measurement grid: dx=10mm, dy=10mm

**Zoom Scan (8x8x8)/Cube 0:** Measurement grid: dx=4.3mm, dy=4.3mm, dz=3mm

Reference Value = 5.99 V/m

Peak SAR (extrapolated) = 2.46 W/kg

**SAR(1 g) = 0.633 mW/g; SAR(10 g) = 0.244 mW/g**

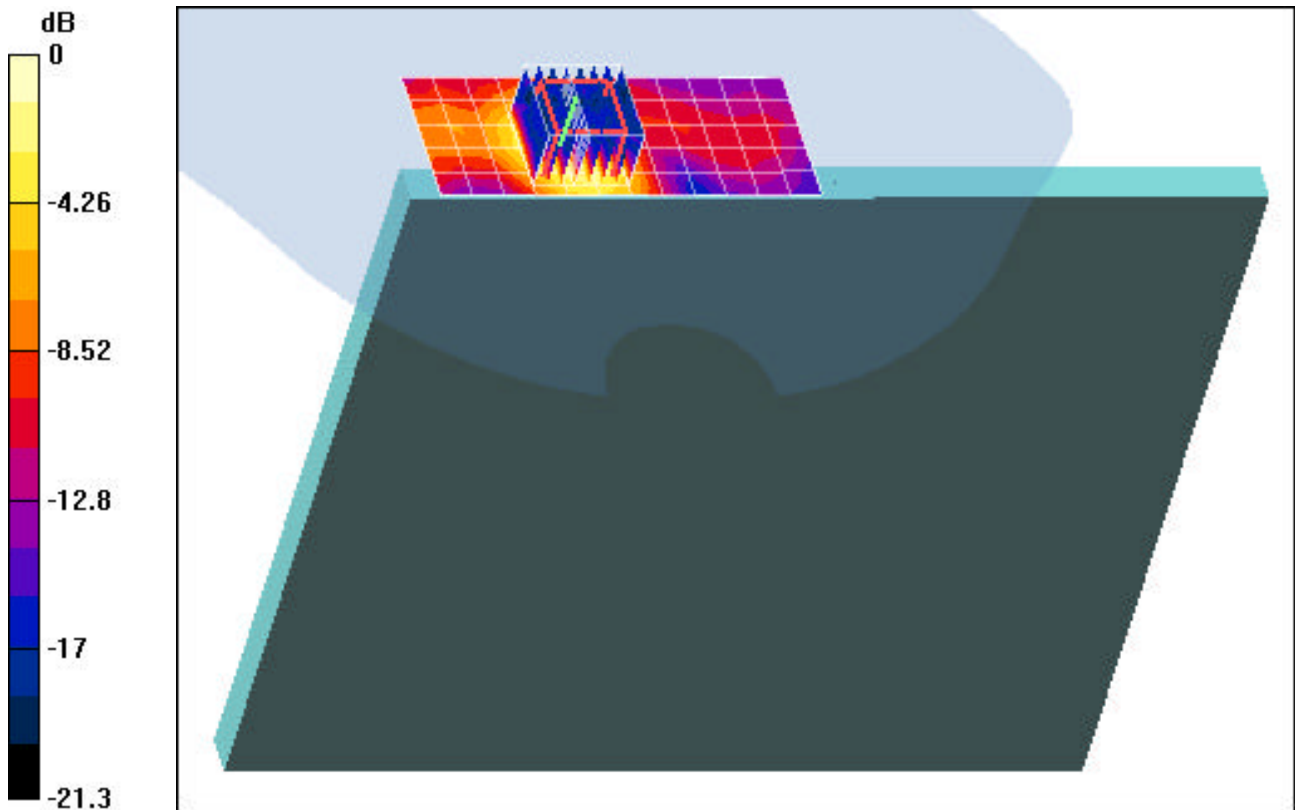

0 dB = 0.845mW/g

# PCTEST ENGINEERING LABORATORY, INC.

**DUT: AR5BMB-44; Type: IBM 802.11a/b/g WLAN Adapter; Serial: #4**

Communication System: IEEE 802.11a; Frequency: 5785 MHz; Duty Cycle: 1:1

Medium: 5800 Muscle ( $\sigma = 5.94$  mho/m,  $\epsilon_r = 48.21$ ,  $\rho = 1000$  kg/m<sup>3</sup>)

Phantom section: Flat Section; Space: 0.0 cm

Test Date: 01-18-2005; Ambient Temp: 22.6°C; Tissue Temp: 20.5°C

Probe: EX3DV4 - SN3550; ConvF(3.48, 3.48, 3.48); Calibrated: 10/26/2004

Sensor-Surface: 3mm (Mechanical Surface Detection)

Electronics: DAE4 Sn637; Calibrated: 9/22/2004

Phantom: SAM 12b; Type: SAM 4.0; Serial: TP:1197

Measurement SW: DASY4, V4.4 Build 3; Postprocessing SW: SEMCAD, V1.8 Build 130

**Tablet position, Left side, LCD Flip, ch.157, 18Mbps, Aux antenna, Bluetooth on**

**Area Scan (7x27x1):** Measurement grid: dx=10mm, dy=10mm

**Zoom Scan (8x8x8)/Cube 0:** Measurement grid: dx=4.3mm, dy=4.3mm, dz=3mm

Reference Value = 3.8 V/m

Peak SAR (extrapolated) = 0.846 W/kg

**SAR(1 g) = 0.372 mW/g; SAR(10 g) = 0.167 mW/g**

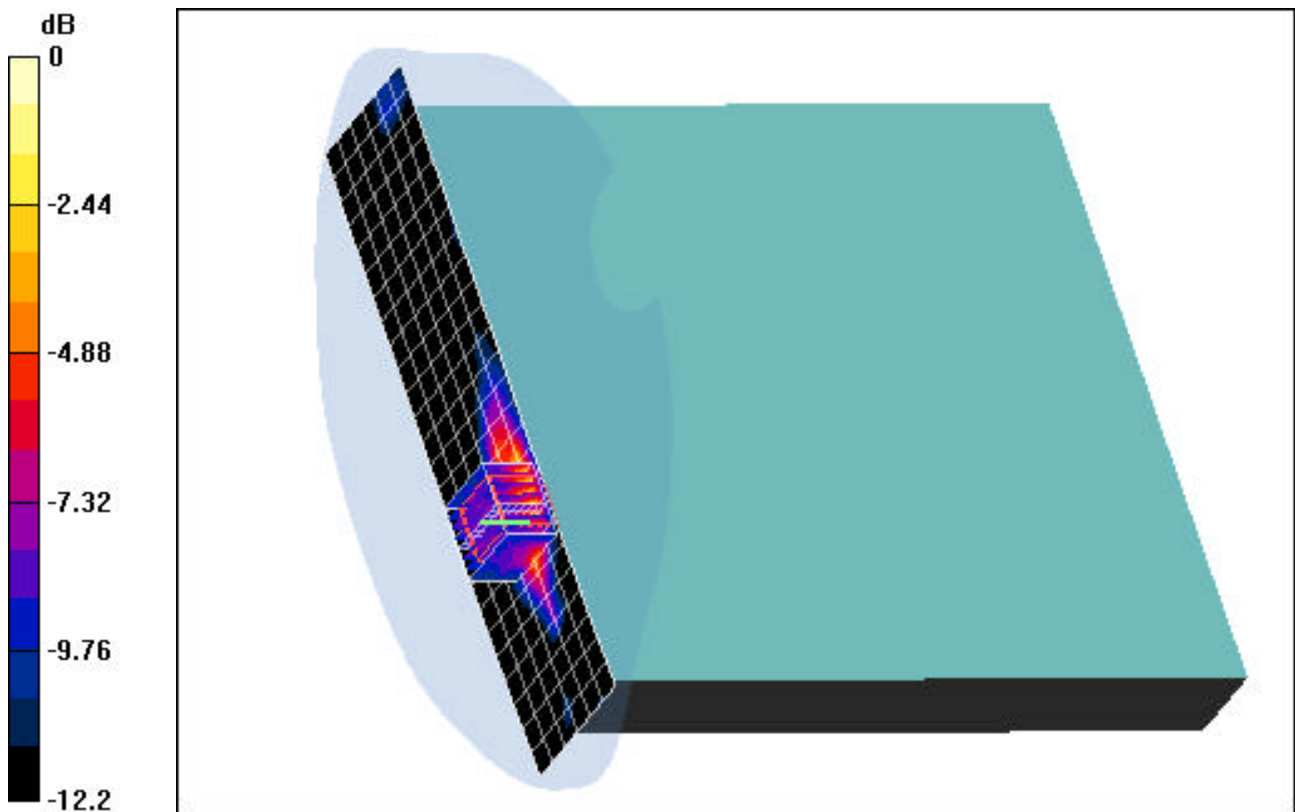

0 dB = 0.539mW/g

# PCTEST ENGINEERING LABORATORY, INC.

**DUT: AR5BMB-44; Type: IBM 802.11a/b/g WLAN Adapter; Serial: #4**

Communication System: IEEE 802.11b; Frequency: 2437 MHz; Duty Cycle: 1:1

Medium: 2450 Muscle ( $\sigma = 1.90$  mho/m,  $\epsilon_r = 53.31$ ,  $\rho = 1000$  kg/m<sup>3</sup>)

Phantom section: Flat Section; Space: 1.0 cm

Test Date: 01-21-2005; Ambient Temp: 22.5°C; Tissue Temp: 20.4°C

Probe: EX3DV4 - SN3550; ConvF(6.27, 6.27, 6.27); Calibrated: 10/26/2004

Sensor-Surface: 3mm (Mechanical Surface Detection)

Electronics: DAE4 Sn637; Calibrated: 9/22/2004

Phantom: SAM 12b; Type: SAM 4.0; Serial: TP:1197

Measurement SW: DASY4, V4.4 Build 3; Postprocessing SW: SEMCAD, V1.8 Build 130

**Bystander position, LCD Open, ch.06, 1Mbps, Main antenna, Bluetooth off**

**Area Scan (7x11x1):** Measurement grid: dx=15mm, dy=15mm

**Zoom Scan (5x5x7)/Cube 0:** Measurement grid: dx=8mm, dy=8mm, dz=5mm

Reference Value = 8.52 V/m

Peak SAR (extrapolated) = 0.566 W/kg

**SAR(1 g) = 0.289 mW/g; SAR(10 g) = 0.146 mW/g**

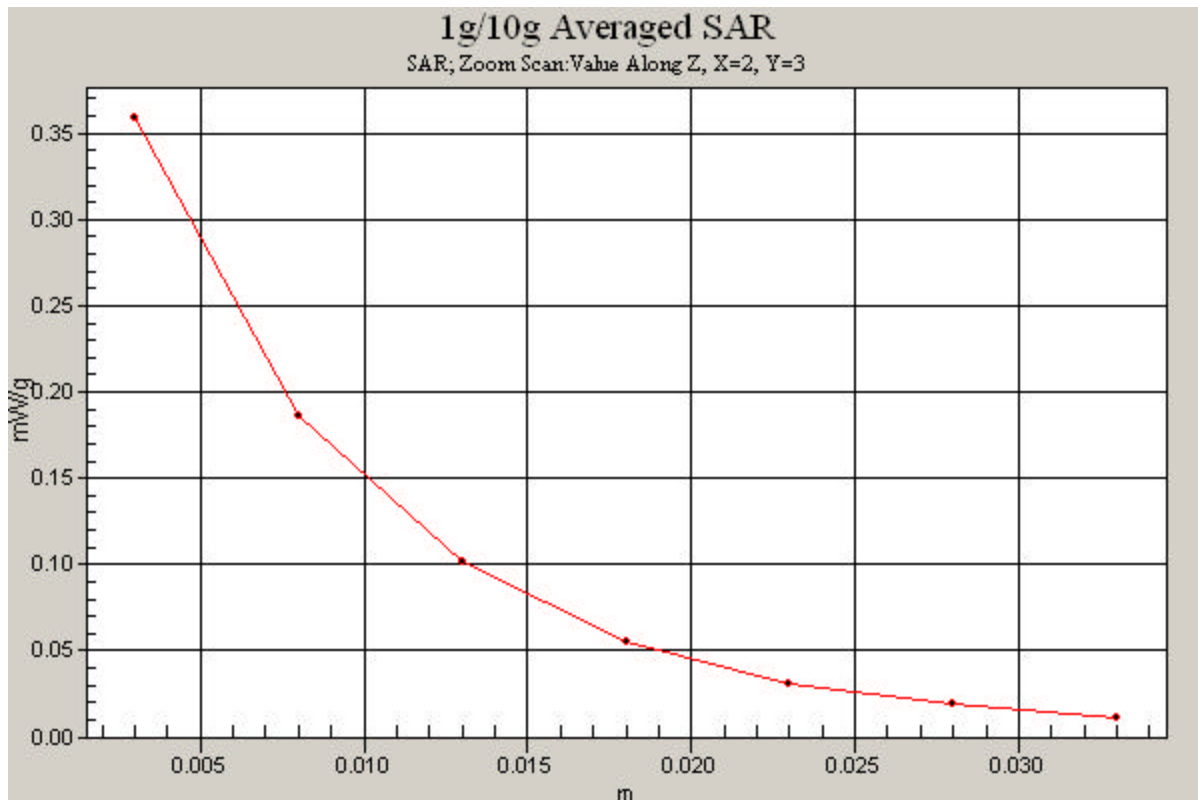

# PCTEST ENGINEERING LABORATORY, INC.

**DUT: AR5BMB-44; Type: IBM 802.11a/b/g WLAN Adapter; Serial: #4**

Communication System: IEEE 802.11a; Frequency: 5260 MHz; Duty Cycle: 1:1

Medium: 5300 Muscle ( $\sigma = 5.41$  mho/m,  $\epsilon_r = 48.06$ ,  $\rho = 1000$  kg/m<sup>3</sup>)

Phantom section: Flat Section; Space: 1.0 cm

Test Date: 01-17-2005; Ambient Temp: 23.6°C; Tissue Temp: 21.2°C

Probe: EX3DV4 - SN3550; ConvF(3.72, 3.72, 3.72); Calibrated: 10/26/2004

Sensor-Surface: 3mm (Mechanical Surface Detection)

Electronics: DAE4 Sn637; Calibrated: 9/22/2004

Phantom: SAM 12b; Type: SAM 4.0; Serial: TP:1197

Measurement SW: DASY4, V4.4 Build 3; Postprocessing SW: SEMCAD, V1.8 Build 130

**Bystander position, LCD Open, ch.52, 18Mbps, Main antenna, Bluetooth on**

**Area Scan (6x13x1):** Measurement grid: dx=10mm, dy=10mm

**Zoom Scan (8x8x8)/Cube 0:** Measurement grid: dx=4.3mm, dy=4.3mm, dz=3mm

Reference Value = 5.96 V/m

Peak SAR (extrapolated) = 2.49 W/kg

**SAR(1 g) = 0.697 mW/g; SAR(10 g) = 0.239 mW/g**

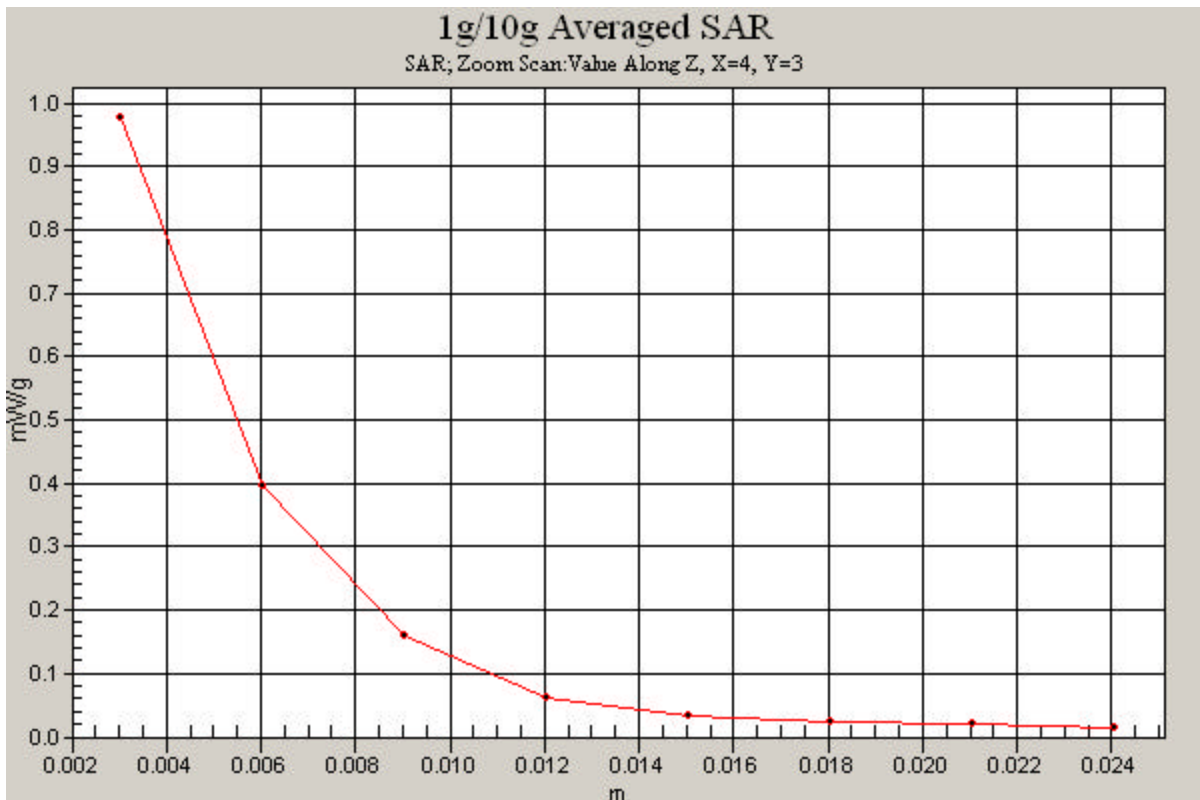

# PCTEST ENGINEERING LABORATORY, INC.

**DUT: AR5BMB-44; Type: IBM 802.11a/b/g WLAN Adapter; Serial: #4**

Communication System: IEEE 802.11a; Frequency: 5785 MHz; Duty Cycle: 1:1

Medium: 5800 Muscle ( $\sigma = 5.94$  mho/m,  $\epsilon_r = 48.21$ ,  $\rho = 1000$  kg/m<sup>3</sup>)

Phantom section: Flat Section; Space: 1.5 cm

Test Date: 01-17-2005; Ambient Temp: 23.2°C; Tissue Temp: 20.8°C

Probe: EX3DV4 - SN3550; ConvF(3.48, 3.48, 3.48); Calibrated: 10/26/2004

Sensor-Surface: 3mm (Mechanical Surface Detection)

Electronics: DAE4 Sn637; Calibrated: 9/22/2004

Phantom: SAM 12b; Type: SAM 4.0; Serial: TP:1197

Measurement SW: DASY4, V4.4 Build 3; Postprocessing SW: SEMCAD, V1.8 Build 130

**Bystander position, LCD Open, ch.157, 18Mbps, Main antenna, Bluetooth off**

**Area Scan (6x13x1):** Measurement grid: dx=10mm, dy=10mm

**Zoom Scan (8x8x8)/Cube 0:** Measurement grid: dx=4.3mm, dy=4.3mm, dz=3mm



Reference Value = 5.99 V/m

Peak SAR (extrapolated) = 2.46 W/kg

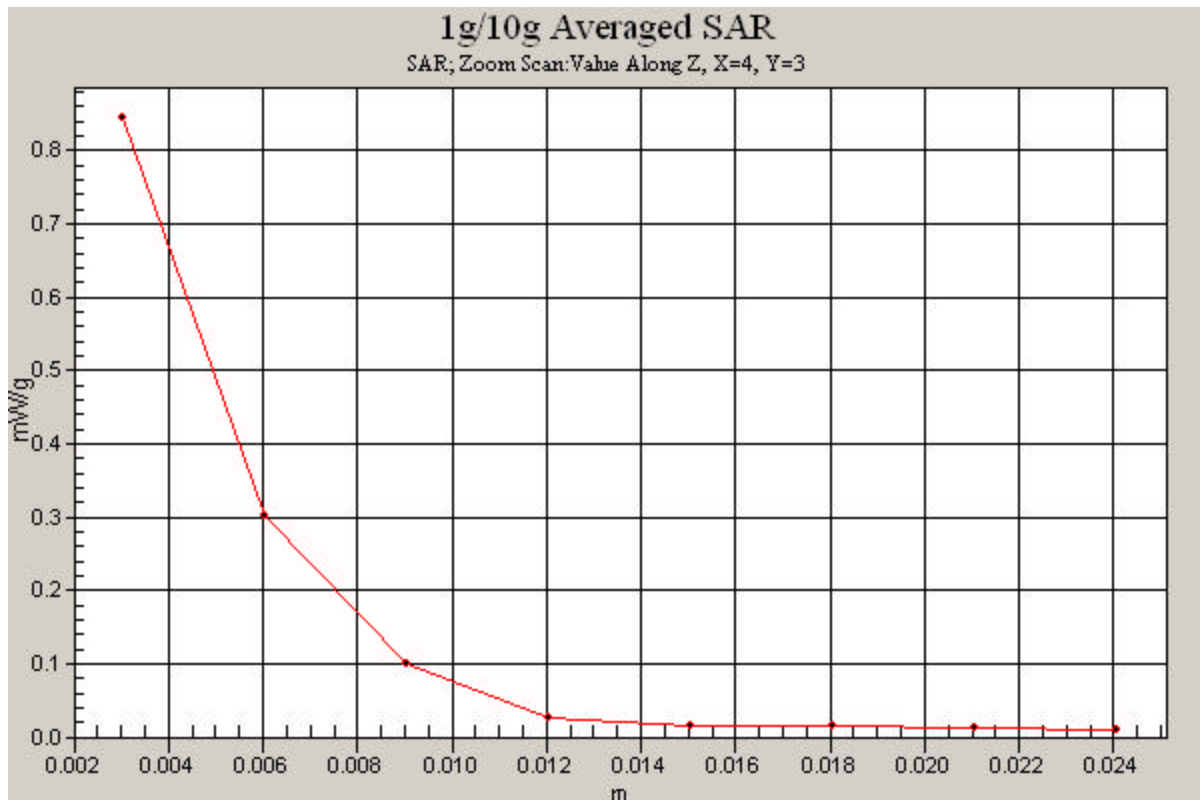

**SAR(1 g) = 0.633 mW/g; SAR(10 g) = 0.244 mW/g**



## ATTACHMENT B – SAR TEST SETUP PHOTOGRAPHS

PCTEST SAR & RSS-102 TEST REPORT	 <b>FCC/ IC Measurement Report</b> 			Reviewed by: Quality Manager	
SAR Filename: SAR.0501050003-R1.ANO	Test Dates: Jan. 17-24, 2005	EUT Type: IBM Laptop PC ThinkPad X41 Tablet Series Model: 1866/1867/1868/1869 w/ 802.11b/g WLAN Adapter	FCC ID: ANO20040600BTL	IC ID: 349E-AR5BMB44	Page 30 of 32

## ATTACHMENT C – DIPOLE VALIDATION

PCTEST SAR & RSS-102 TEST REPORT	 <b>FCC/ IC Measurement Report</b> 			Reviewed by: Quality Manager	
SAR Filename: SAR.0501050003-R1.ANO	Test Dates: Jan. 17-24, 2005	EUT Type: IBM Laptop PC ThinkPad X41 Tablet Series Model: 1866/1867/1868/1869 w/ 802.11b/g WLAN Adapter	FCC ID: ANO20040600BTL	IC ID: 349E-AR5BMB44	Page 31 of 32



# PCTEST ENGINEERING LABORATORY, INC.

**DUT: Dipole 2450 MHz; Type: D2450V2; Serial: D2450V2 - SN:719**

Communication System: CW; Frequency: 2450 MHz; Duty Cycle: 1:1

Medium: 2450 Brain ( $\sigma = 1.83$  mho/m,  $\epsilon_r = 38.53$ ,  $\rho = 1000$  kg/m<sup>3</sup>)

Phantom section: Flat Section; Space: 1.0 cm

Test Date: 01-20-2005; Ambient Temp: 23.3°C; Tissue Temp: 20.8°C

Probe: EX3DV4 - SN3550; ConvF(6.33, 6.33, 6.33); Calibrated: 10/26/2004

Sensor-Surface: 3mm (Mechanical Surface Detection)

Electronics: DAE4 Sn637; Calibrated: 9/22/2004

Phantom: SAM 12b; Type: SAM 4.0; Serial: TP:1197

Measurement SW: DASY4, V4.4 Build 3; Postprocessing SW: SEMCAD, V1.8 Build 130

## 2450MHz Dipole Validation

**Area Scan (5x7x1):** Measurement grid: dx=15mm, dy=15mm

**Zoom Scan (7x7x7)/Cube 0:** Measurement grid: dx=5mm, dy=5mm, dz=5mm

Input Power = 20.0 dBm (100 mW)

**SAR(1 g) = 5.07 mW/g; SAR(10 g) = 2.27 mW/g**

Target SAR(1g) = 5.24 mW/g; Deviation = -3.2 %

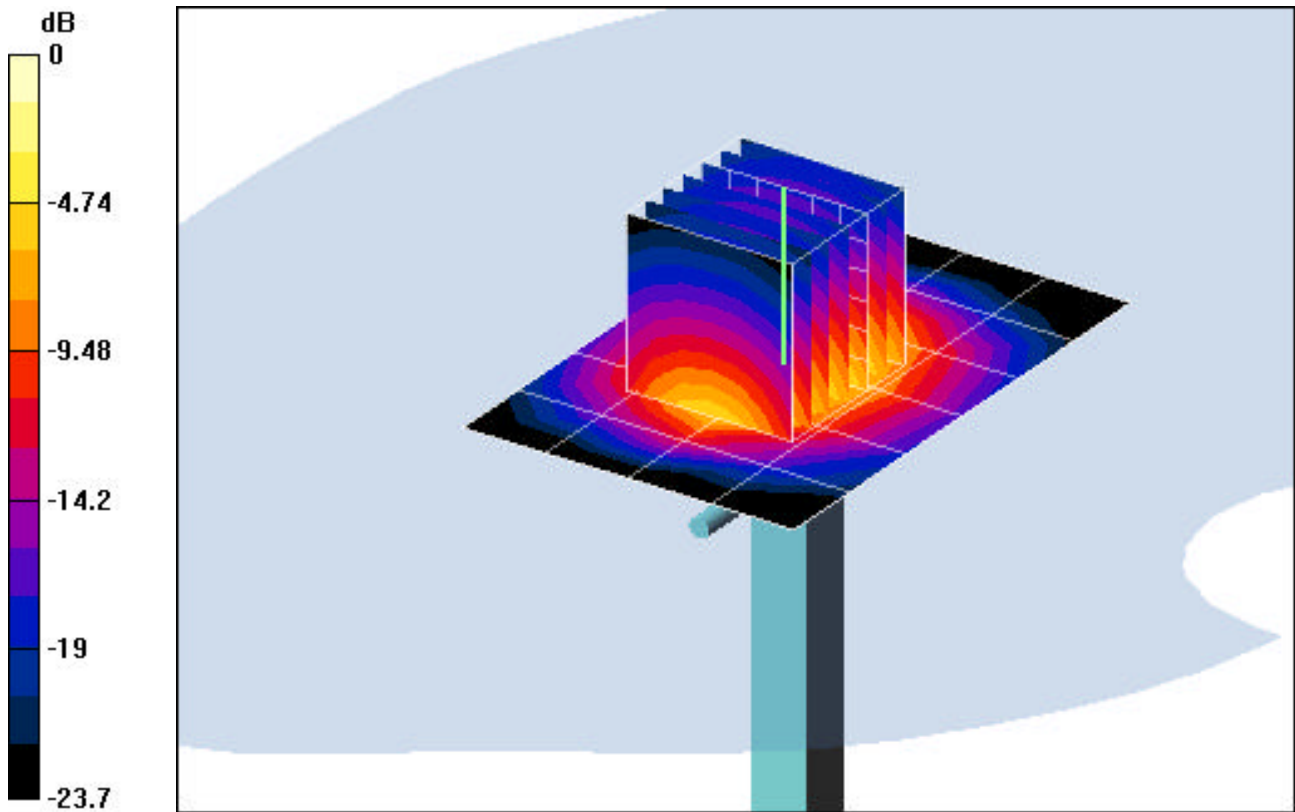

0 dB = 6.82mW/g

# PCTEST ENGINEERING LABORATORY, INC.

**DUT: Dipole 2450 MHz; Type: D2450V2; Serial: D2450V2 - SN:719**

Communication System: CW; Frequency: 2450 MHz; Duty Cycle: 1:1

Medium: 2450 Brain ( $\sigma = 1.83$  mho/m,  $\epsilon_r = 38.53$ ,  $\rho = 1000$  kg/m<sup>3</sup>)

Phantom section: Flat Section; Space: 1.0 cm

Test Date: 01-21-2005; Ambient Temp: 22.8°C; Tissue Temp: 20.6°C

Probe: EX3DV4 - SN3550; ConvF(6.33, 6.33, 6.33); Calibrated: 10/26/2004

Sensor-Surface: 3mm (Mechanical Surface Detection)

Electronics: DAE4 Sn637; Calibrated: 9/22/2004

Phantom: SAM 12b; Type: SAM 4.0; Serial: TP:1197

Measurement SW: DASYS4, V4.4 Build 3; Postprocessing SW: SEMCAD, V1.8 Build 130

## 2450MHz Dipole Validation

**Area Scan (5x7x1):** Measurement grid: dx=15mm, dy=15mm

**Zoom Scan (7x7x7)/Cube 0:** Measurement grid: dx=5mm, dy=5mm, dz=5mm

Input Power = 20.0 dBm (100 mW)

**SAR(1 g) = 4.78 mW/g; SAR(10 g) = 2.15 mW/g**

Target SAR(1g) = 5.24 mW/g; Deviation = -8.7 %

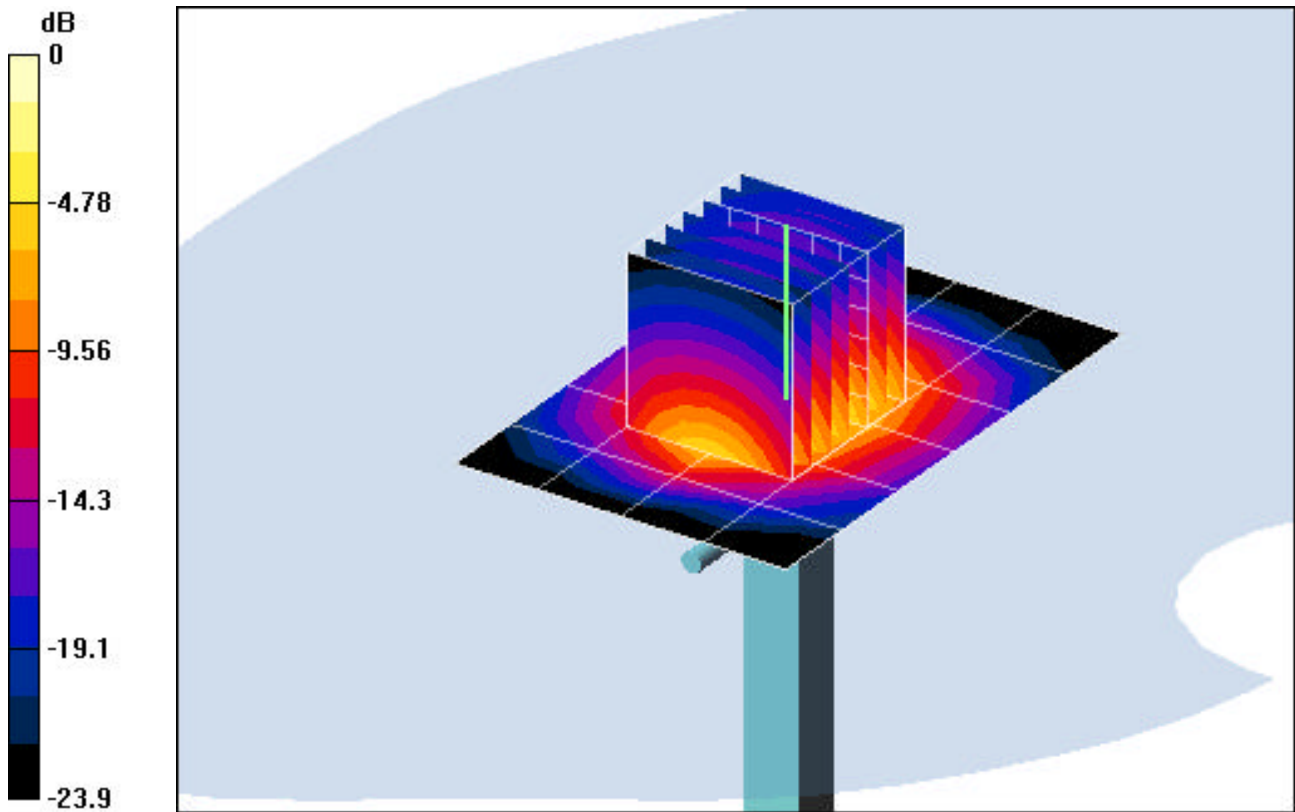

0 dB = 6.43mW/g

# PCTEST ENGINEERING LABORATORY, INC.

**DUT: Dipole 2450 MHz; Type: D2450V2; Serial: D2450V2 - SN:719**

Communication System: CW; Frequency: 2450 MHz; Duty Cycle: 1:1

Medium: 2450 Brain ( $\sigma = 1.83$  mho/m,  $\epsilon_r = 38.53$ ,  $\rho = 1000$  kg/m<sup>3</sup>)

Phantom section: Flat Section; Space: 1.0 cm

Test Date: 01-24-2005; Ambient Temp: 22.9°C; Tissue Temp: 20.7°C

Probe: EX3DV4 - SN3550; ConvF(6.33, 6.33, 6.33); Calibrated: 10/26/2004

Sensor-Surface: 3mm (Mechanical Surface Detection)

Electronics: DAE4 Sn637; Calibrated: 9/22/2004

Phantom: SAM 12b; Type: SAM 4.0; Serial: TP:1197

Measurement SW: DAS4, V4.4 Build 3; Postprocessing SW: SEMCAD, V1.8 Build 130

## 2450MHz Dipole Validation

**Area Scan (5x7x1):** Measurement grid: dx=15mm, dy=15mm

**Zoom Scan (7x7x7)/Cube 0:** Measurement grid: dx=5mm, dy=5mm, dz=5mm

Input Power = 20.0 dBm (100 mW)

**SAR(1 g) = 5.16 mW/g; SAR(10 g) = 2.32 mW/g**

Target SAR(1g) = 5.24 mW/g; Deviation = -1.5 %

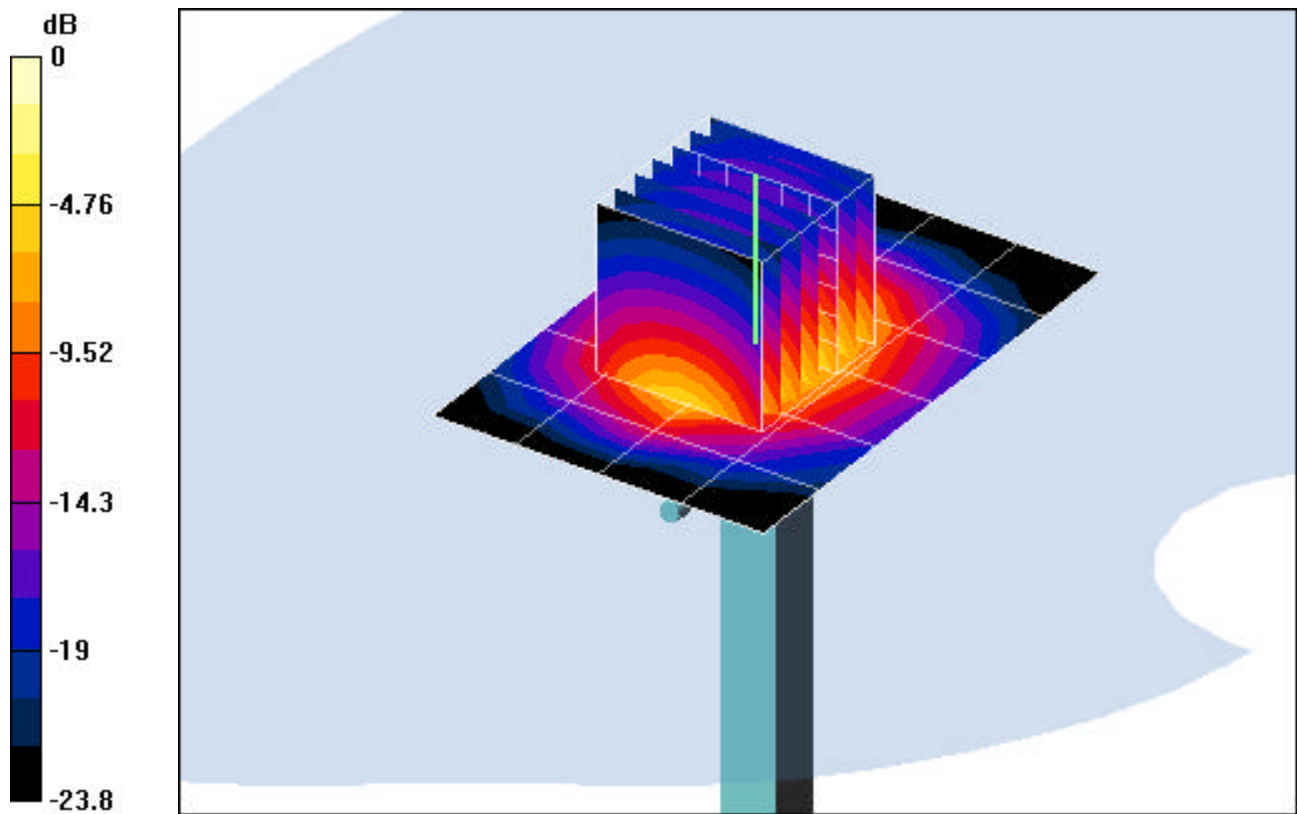

0 dB = 6.95mW/g

# PCTEST ENGINEERING LABORATORY, INC.

**DUT: Dipole 5800 MHz; Type: D5GHzV2; Serial: 1007**

Communication System: CW; Frequency: 5800 MHz; Duty Cycle: 1:1

Medium: 5800 Brain ( $\sigma = 5.40$  mho/m,  $\epsilon_r = 35.53$ ,  $\rho = 1000$  kg/m<sup>3</sup>)

Phantom section: Flat Section; Space: 1.0cm

Test Date: 01-17-2005; Ambient Temp: 22.6°C; Tissue Temp: 20.4°C

Probe: EX3DV4 - SN3550; ConvF(3.74, 3.74, 3.74); Calibrated: 10/26/2004

Sensor-Surface: 3mm (Mechanical Surface Detection)

Electronics: DAE4 Sn637; Calibrated: 9/22/2004

Phantom: SAM 12b; Type: SAM 4.0; Serial: TP:1197

Measurement SW: DASY4, V4.4 Build 3; Postprocessing SW: SEMCAD, V1.8 Build 130

## 5800MHz Dipole Validation

**Area Scan (7x9x1):** Measurement grid: dx=10mm, dy=10mm

**Zoom Scan (8x8x8)/Cube 0:** Measurement grid: dx=4.3mm, dy=4.3mm, dz=3mm

Input Power = 14.0 dBm (25 mW)

**SAR(1 g) = 2.13 mW/g; SAR(10 g) = 0.590 mW/g**

Target SAR(1g) = 2.25 mW/g; Deviation = -5.3 %

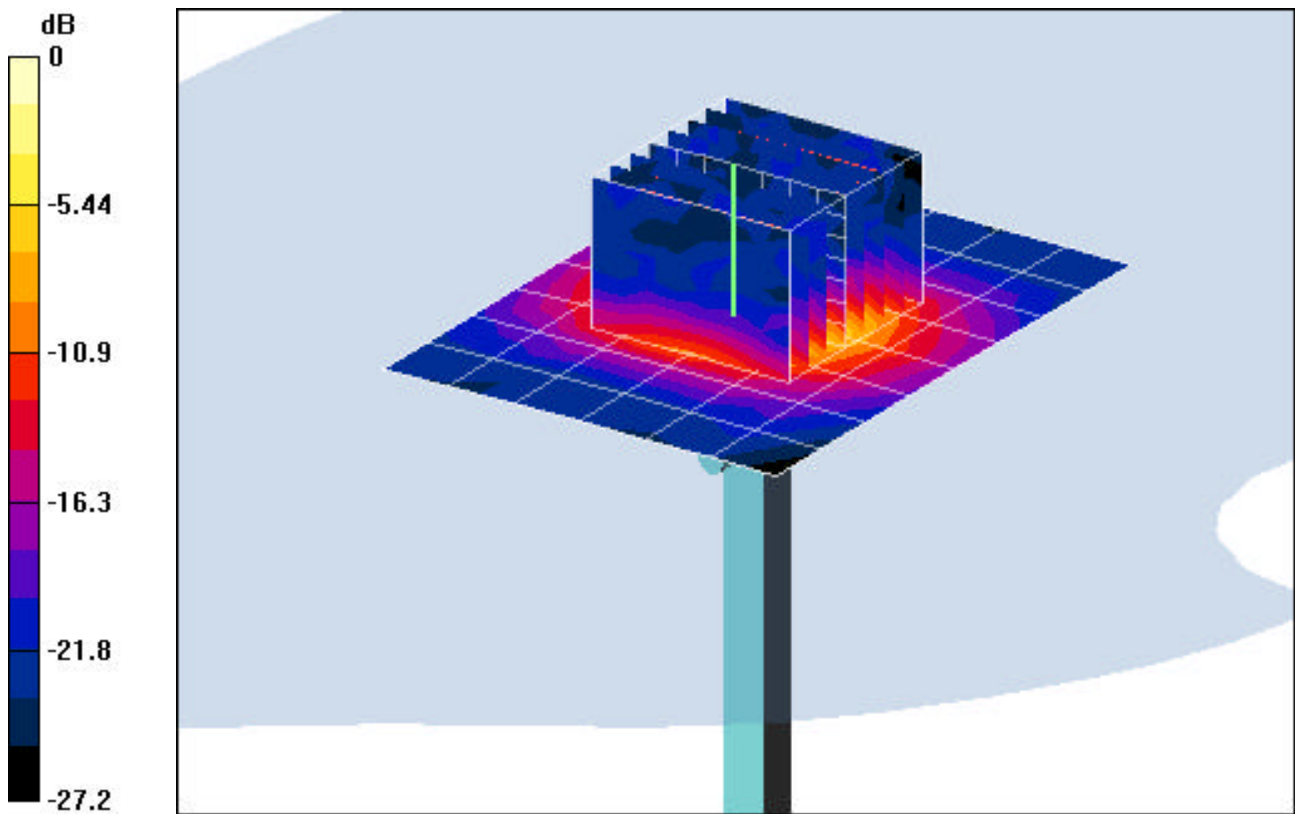

0 dB = 2.94mW/g

# PCTEST ENGINEERING LABORATORY, INC.

**DUT: Dipole 5800 MHz; Type: D5GHzV2; Serial: 1007**

Communication System: CW; Frequency: 5800 MHz; Duty Cycle: 1:1

Medium: 5800 Brain ( $\sigma = 5.40$  mho/m,  $\epsilon_r = 35.53$ ,  $\rho = 1000$  kg/m<sup>3</sup>)

Phantom section: Flat Section; Space: 1.0 cm

Test Date: 01-18-2005; Ambient Temp: 22.5°C; Tissue Temp: 20.2°C

Probe: EX3DV4 - SN3550; ConvF(3.74, 3.74, 3.74); Calibrated: 10/26/2004

Sensor-Surface: 3mm (Mechanical Surface Detection)

Electronics: DAE4 Sn637; Calibrated: 9/22/2004

Phantom: SAM 12b; Type: SAM 4.0; Serial: TP:1197

Measurement SW: DASY4, V4.4 Build 3; Postprocessing SW: SEMCAD, V1.8 Build 130

## 5800MHz Dipole Validation

**Area Scan (7x9x1):** Measurement grid: dx=10mm, dy=10mm

**Zoom Scan (8x8x8)/Cube 0:** Measurement grid: dx=4.3mm, dy=4.3mm, dz=3mm

Input Power = 14.0 dBm (25 mW)

**SAR(1 g) = 2.08 mW/g; SAR(10 g) = 0.579 mW/g**

Target SAR(1g) = 2.25 mW/g; Deviation = -7.5 %

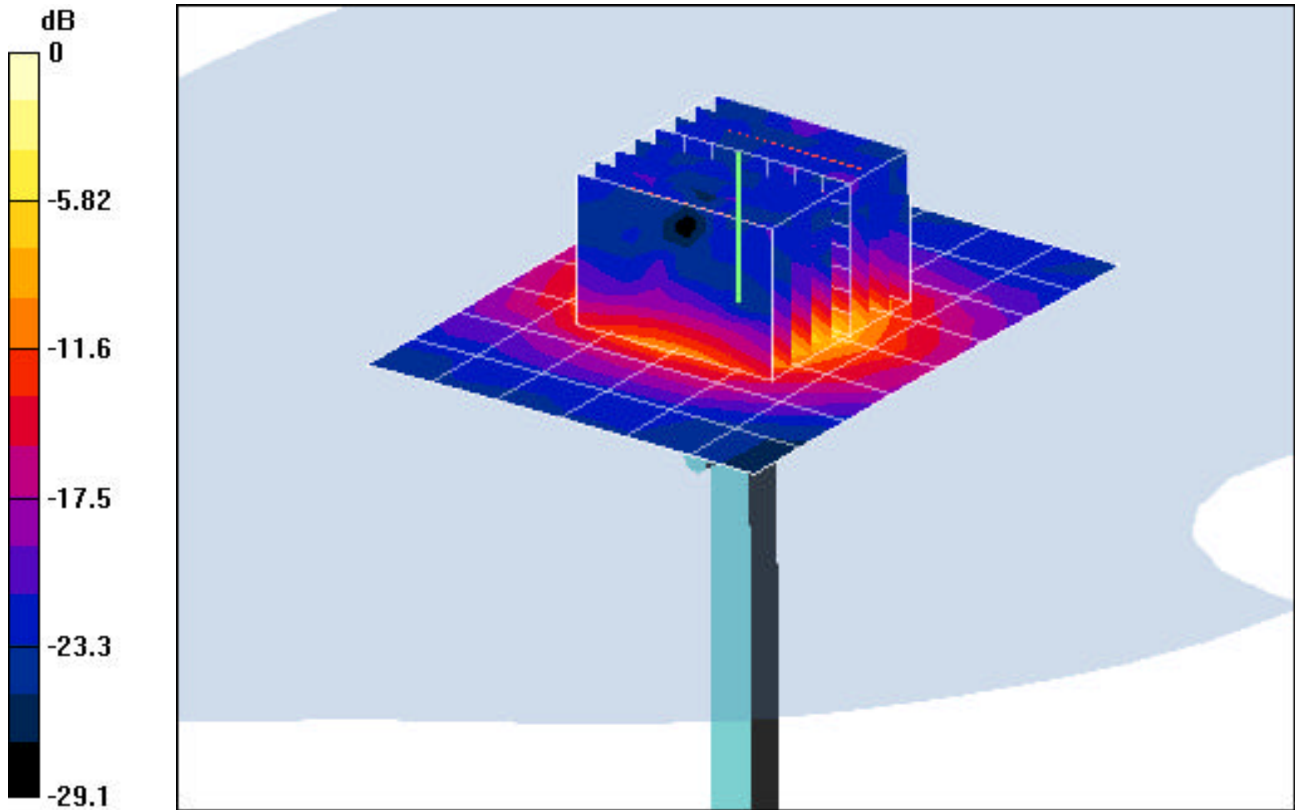

0 dB = 2.84mW/g

# PCTEST ENGINEERING LABORATORY, INC.

**DUT: Dipole 5800 MHz; Type: D5GHzV2; Serial: 1007**

Communication System: CW; Frequency: 5800 MHz; Duty Cycle: 1:1

Medium: 5800 Brain ( $\sigma = 5.40$  mho/m,  $\epsilon_r = 35.53$ ,  $\rho = 1000$  kg/m<sup>3</sup>)

Phantom section: Flat Section; Space: 1.0 cm

Test Date: 01-19-2005; Ambient Temp: 23.5°C; Tissue Temp: 20.6°C

Probe: EX3DV4 - SN3550; ConvF(3.74, 3.74, 3.74); Calibrated: 10/26/2004

Sensor-Surface: 3mm (Mechanical Surface Detection)

Electronics: DAE4 Sn637; Calibrated: 9/22/2004

Phantom: SAM 12b; Type: SAM 4.0; Serial: TP:1197

Measurement SW: DAS4, V4.4 Build 3; Postprocessing SW: SEMCAD, V1.8 Build 130

## 5800MHz Dipole Validation

**Area Scan (7x9x1):** Measurement grid: dx=10mm, dy=10mm

**Zoom Scan (8x8x8)/Cube 0:** Measurement grid: dx=4.3mm, dy=4.3mm, dz=3mm

Input Power = 14.0 dBm (25 mW)

**SAR(1 g) = 2.28 mW/g; SAR(10 g) = 0.628 mW/g**

Target SAR(1g) = 2.25 mW/g; Deviation = +1.3 %

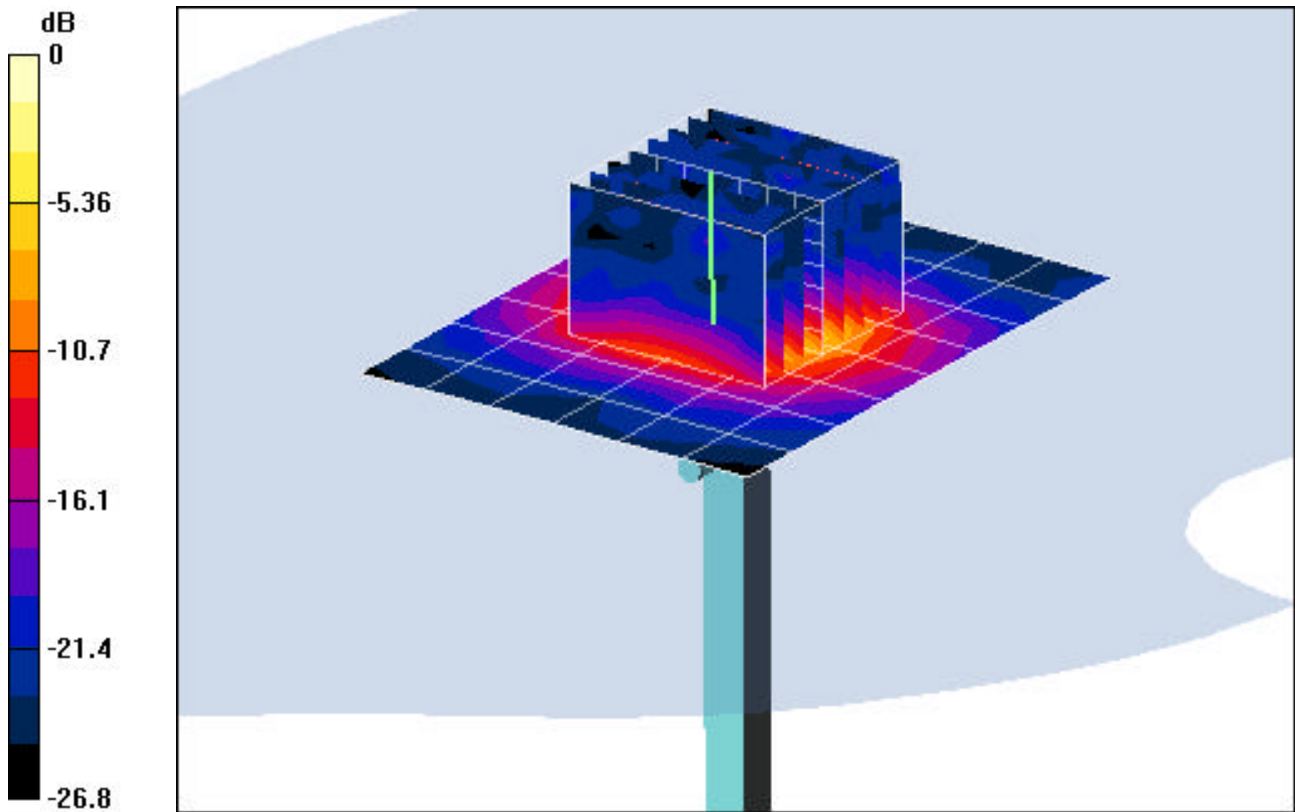

0 dB = 3.18mW/g



# PCTEST ENGINEERING LABORATORY, INC.

**DUT: Dipole 5800 MHz; Type: D5GHzV2; Serial: 1007**

Communication System: CW; Frequency: 5800 MHz; Duty Cycle: 1:1

Medium: 5800 Brain ( $\sigma = 5.40$  mho/m,  $\epsilon_r = 35.53$ ,  $\rho = 1000$  kg/m<sup>3</sup>)

Phantom section: Flat Section; Space: 1.0 cm

Test Date: 01-20-2005; Ambient Temp: 23.6°C; Tissue Temp: 20.5°C

Probe: EX3DV4 - SN3550; ConvF(3.74, 3.74, 3.74); Calibrated: 10/26/2004

Sensor-Surface: 3mm (Mechanical Surface Detection)

Electronics: DAE4 Sn637; Calibrated: 9/22/2004

Phantom: SAM 12b; Type: SAM 4.0; Serial: TP:1197

Measurement SW: DAS4, V4.4 Build 3; Postprocessing SW: SEMCAD, V1.8 Build 130

## 5800MHz Dipole Validation

**Area Scan (7x9x1):** Measurement grid: dx=10mm, dy=10mm

**Zoom Scan (8x8x8)/Cube 0:** Measurement grid: dx=4.3mm, dy=4.3mm, dz=3mm

Input Power = 14.0 dBm (25 mW)

**SAR(1 g) = 2.2 mW/g; SAR(10 g) = 0.610 mW/g**

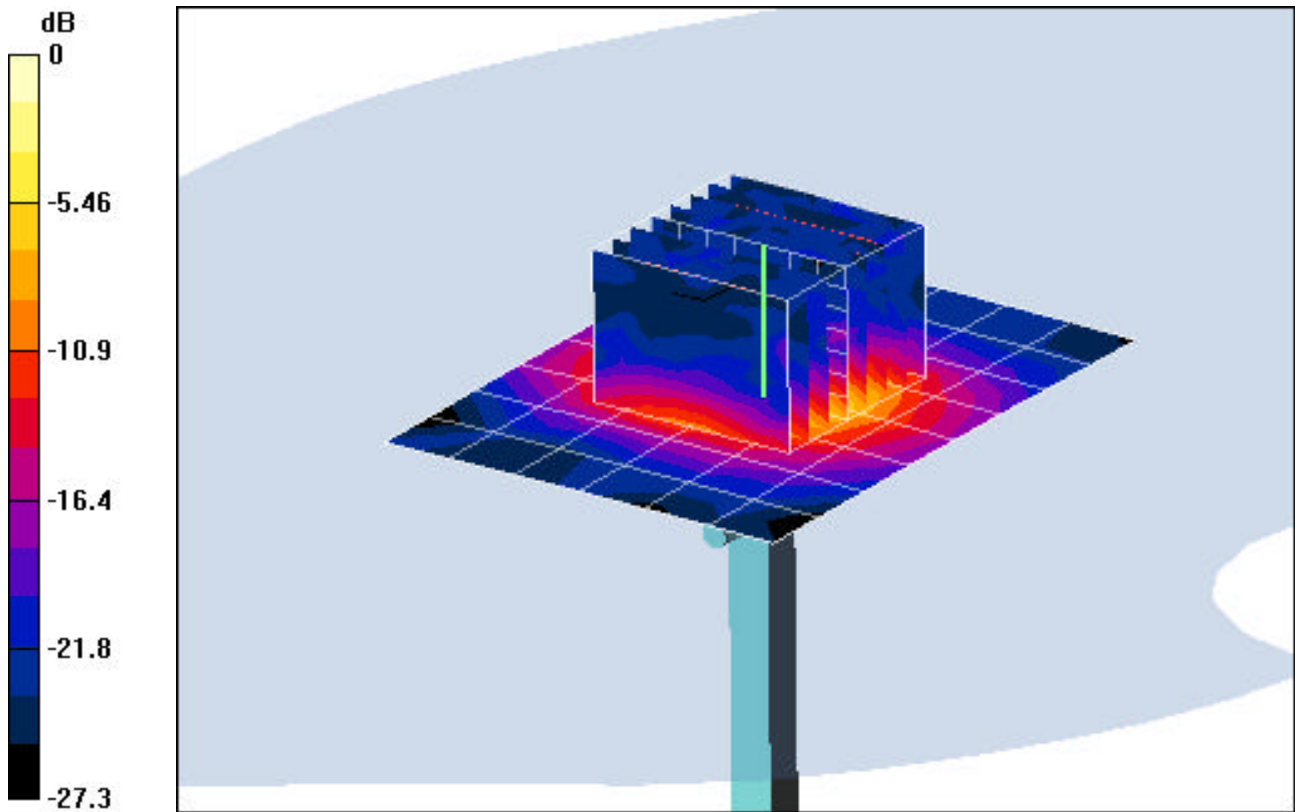

Target SAR(1g) = 2.25 mW/g; Deviation = -2.2 %



0 dB = 3.01mW/g



## ATTACHMENT D – PROBE CALIBRATION

PCTEST SAR & RSS-102 TEST REPORT	 <b>FCC/ IC Measurement Report</b> 			Reviewed by: Quality Manager	
SAR Filename: SAR.0501050003-R1.ANO	Test Dates: Jan. 17-24, 2005	EUT Type: IBM Laptop PC ThinkPad X41 Tablet Series Model: 1866/1867/1868/1869 w/ 802.11b/g WLAN Adapter	FCC ID: ANO20040600BTL	IC ID: 349E-AR5BMB44	Page 32 of 32



Accredited by the Swiss Federal Office of Metrology and Accreditation  
The Swiss Accreditation Service is one of the signatories to the EA  
Multilateral Agreement for the recognition of calibration certificates

Accreditation No.: **SCS 108**

Client **PC Test**

Certificate No: **EX3-3550\_Oct04**

## CALIBRATION CERTIFICATE

Object **EX3DV4 - SN:3550**

Calibration procedure(s) **QA CAL-01.v5 and QA CAL-12.v4  
Calibration procedure for dosimetric E-field probes**

Calibration date: **October 26, 2004**

Condition of the calibrated item **In Tolerance**

This calibration certificate documents the traceability to national standards, which realize the physical units of measurements (SI).  
The measurements and the uncertainties with confidence probability are given on the following pages and are part of the certificate.

All calibrations have been conducted in the closed laboratory facility: environment temperature (22 ± 3)°C and humidity < 70%.

Calibration Equipment used (M&TE critical for calibration)

Primary Standards	ID #	Cal Date (Calibrated by, Certificate No.)	Scheduled Calibration
Power meter E4419B	GB41293874	5-May-04 (METAS, No. 251-00388)	May-05
Power sensor E4412A	MY41495277	5-May-04 (METAS, No. 251-00388)	May-05
Reference 3 dB Attenuator	SN: S5054 (3c)	3-Apr-03 (METAS, No. 251-00403)	Aug-05
Reference 20 dB Attenuator	SN: S5086 (20b)	3-May-04 (METAS, No. 251-00389)	May-05
Reference 30 dB Attenuator	SN: S5129 (30b)	3-Apr-03 (METAS, No. 251-00404)	Aug-05
Reference Probe ES3DV2	SN:3013	8-Jan-04 (SPEAG, No. ES3-3013_Jan04)	Jan-05
DAE4	SN: 617	26-May-04 (SPEAG, No. DAE4-617_May04)	May-05

Secondary Standards	ID #	Check Date (in house)	Scheduled Check
Power sensor HP 8481A	MY41092180	18-Sep-02 (SPEAG, in house check Oct-03)	In house check: Oct 05
RF generator HP 8648C	US3642U01700	4-Aug-99 (SPEAG, in house check Dec-03)	In house check: Dec-05
Network Analyzer HP 8753E	US37390585	18-Oct-01 (SPEAG, in house check Nov-03)	In house check: Nov 04

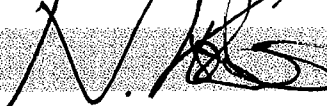
	Name	Function	Signature
Calibrated by:	Katja Pokovic	Technical Manager	
Approved by:	Niels Kuster	Quality Manager	

Issued: October 30, 2004

This calibration certificate shall not be reproduced except in full without written approval of the laboratory.



Accredited by the Swiss Federal Office of Metrology and Accreditation  
The Swiss Accreditation Service is one of the signatories to the EA  
Multilateral Agreement for the recognition of calibration certificates

Accreditation No.: **SCS 108**

### Glossary:

TSL	tissue simulating liquid
NORM <sub>x,y,z</sub>	sensitivity in free space
ConF	sensitivity in TSL / NORM <sub>x,y,z</sub>
DCP	diode compression point
Polarization $\varphi$	$\varphi$ rotation around probe axis
Polarization $\vartheta$	$\vartheta$ rotation around an axis that is in the plane normal to probe axis (at measurement center), i.e., $\vartheta = 0$ is normal to probe axis

### Calibration is Performed According to the Following Standards:

- IEEE Std 1528-2003, "IEEE Recommended Practice for Determining the Peak Spatial-Averaged Specific Absorption Rate (SAR) in the Human Head from Wireless Communications Devices: Measurement Techniques", December 2003
- CENELEC EN 50361, "Basic standard for the measurement of Specific Absorption Rate related to human exposure to electromagnetic fields from mobile phones (300 MHz - 3 GHz), July 2001

### Methods Applied and Interpretation of Parameters:

- NORM<sub>x,y,z</sub>**: Assessed for E-field polarization  $\vartheta = 0$  ( $f \leq 900$  MHz in TEM-cell;  $f > 1800$  MHz: R22 waveguide). NORM<sub>x,y,z</sub> are only intermediate values, i.e., the uncertainties of NORM<sub>x,y,z</sub> does not effect the  $E^2$ -field uncertainty inside TSL (see below *ConvF*).
- NORM(f)<sub>x,y,z</sub>** = NORM<sub>x,y,z</sub> \* *frequency\_response* (see Frequency Response Chart). This linearization is implemented in DASY4 software versions later than 4.2. The uncertainty of the frequency response is included in the stated uncertainty of *ConvF*.
- DCP<sub>x,y,z</sub>**: DCP are numerical linearization parameters assessed based on the data of power sweep (no uncertainty required). DCP does not depend on frequency nor media.
- ConvF and Boundary Effect Parameters**: Assessed in flat phantom using E-field (or Temperature Transfer Standard for  $f \leq 800$  MHz) and inside waveguide using analytical field distributions based on power measurements for  $f > 800$  MHz. The same setups are used for assessment of the parameters applied for boundary compensation (alpha, depth) of which typical uncertainty values are given. These parameters are used in DASY4 software to improve probe accuracy close to the boundary. The sensitivity in TSL corresponds to NORM<sub>x,y,z</sub> \* *ConvF* whereby the uncertainty corresponds to that given for *ConvF*. A frequency dependent *ConvF* is used in DASY 4.3 B17 and higher which allows extending the validity from  $\pm 50$  MHz to  $\pm 100$  MHz.
- Spherical isotropy (3D deviation from isotropy)**: in a field of low gradients realized using a flat phantom exposed by a patch antenna.
- Sensor Offset**: The sensor offset corresponds to the offset of virtual measurement center from the probe tip (on probe axis). No tolerance required.

# Probe EX3DV4

## SN:3550

Manufactured:	May 19, 2004
Calibrated:	October 26, 2004

Calibrated for DASY Systems

(Note: non-compatible with DASY2 system!)

## DASY - Parameters of Probe: EX3DV4 SN:3550

### Sensitivity in Free Space<sup>A</sup>

NormX	<b>0.47</b> ± 9.9%	$\mu\text{V}/(\text{V}/\text{m})^2$
NormY	<b>0.49</b> ± 9.9%	$\mu\text{V}/(\text{V}/\text{m})^2$
NormZ	<b>0.47</b> ± 9.9%	$\mu\text{V}/(\text{V}/\text{m})^2$

### Diode Compression<sup>B</sup>

DCP X	<b>92</b> mV
DCP Y	<b>92</b> mV
DCP Z	<b>92</b> mV

### Sensitivity in Tissue Simulating Liquid (Conversion Factors)

Please see Page 8.

### Boundary Effect

**TSL**                      **900 MHz**      **Typical SAR gradient: 5 % per mm**

Sensor Center to Phantom Surface Distance		<b>2.0 mm</b>	<b>3.0 mm</b>
SAR <sub>be</sub> [%]	Without Correction Algorithm	3.8	1.1
SAR <sub>be</sub> [%]	With Correction Algorithm	0.1	0.4

**TSL**                      **1750 MHz**      **Typical SAR gradient: 10 % per mm**

Sensor Center to Phantom Surface Distance		<b>2.0 mm</b>	<b>3.0 mm</b>
SAR <sub>be</sub> [%]	Without Correction Algorithm	4.8	2.4
SAR <sub>be</sub> [%]	With Correction Algorithm	0.8	0.9

### Sensor Offset

Probe Tip to Sensor Center                      **1.0 mm**

**The reported uncertainty of measurement is stated as the standard uncertainty of measurement multiplied by the coverage factor k=2, which for a normal distribution corresponds to a coverage probability of approximately 95%.**

<sup>A</sup> The uncertainties of NormX,Y,Z do not affect the E<sup>2</sup>-field uncertainty inside TSL (see Page 8).

<sup>B</sup> Numerical linearization parameter: uncertainty not required.

# Frequency Response of E-Field

(TEM-Cell:ifi110 EXX, Waveguide: R22)

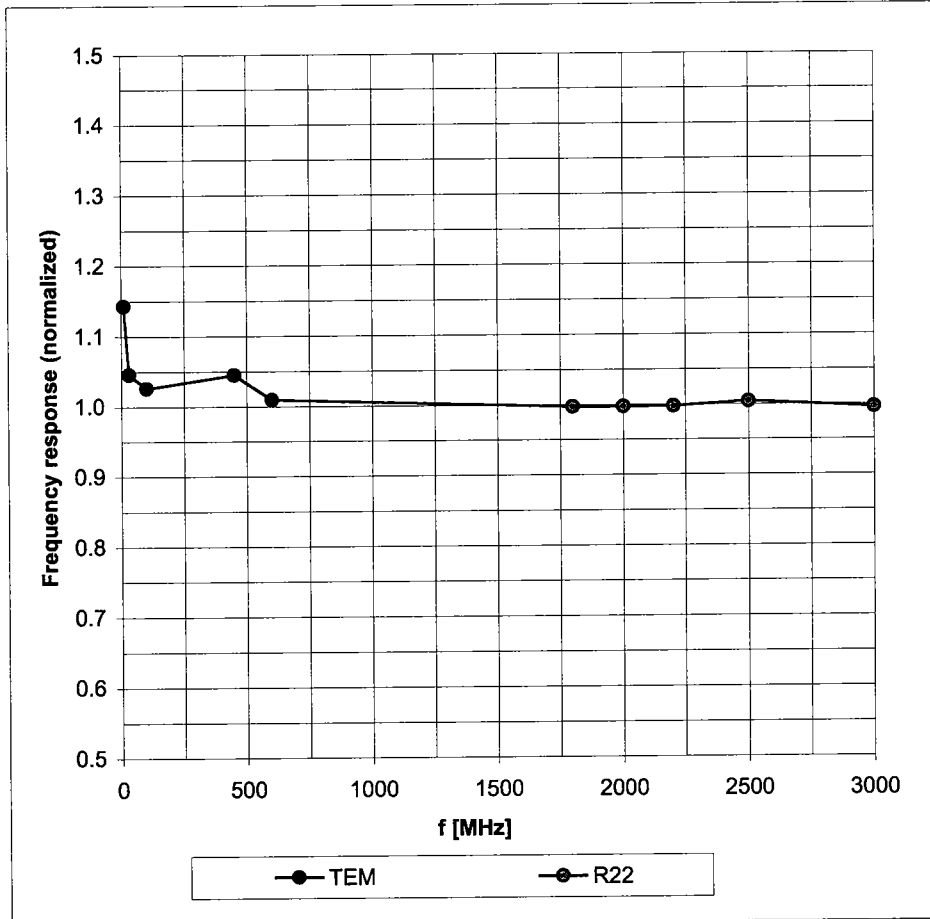

Uncertainty of Frequency Response of E-field:  $\pm 6.3\%$  (k=2)

### Receiving Pattern ( $\phi$ ), $\vartheta = 0^\circ$

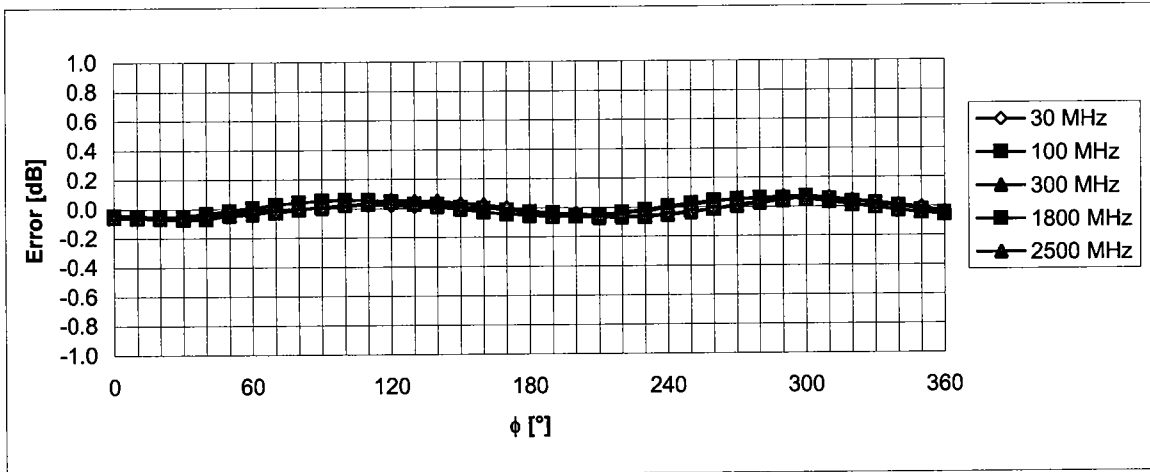
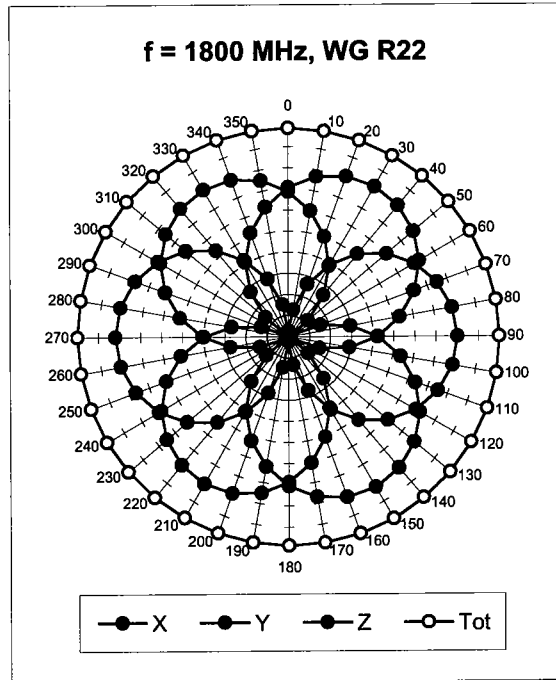
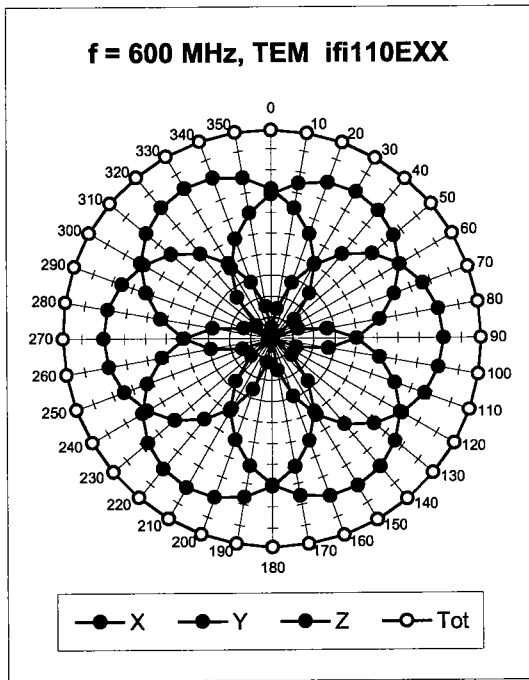

Uncertainty of Axial Isotropy Assessment:  $\pm 0.5\%$  ( $k=2$ )



## Dynamic Range $f(\text{SAR}_{\text{head}})$ (Waveguide R22, $f = 1800 \text{ MHz}$ )

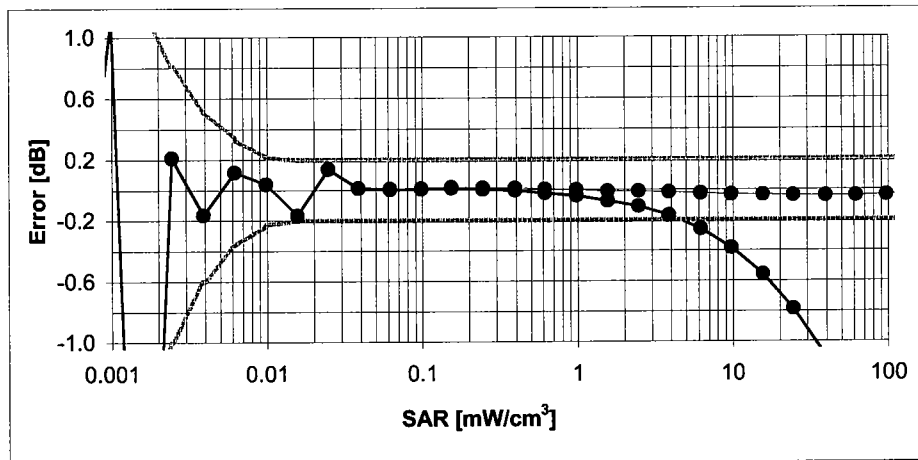
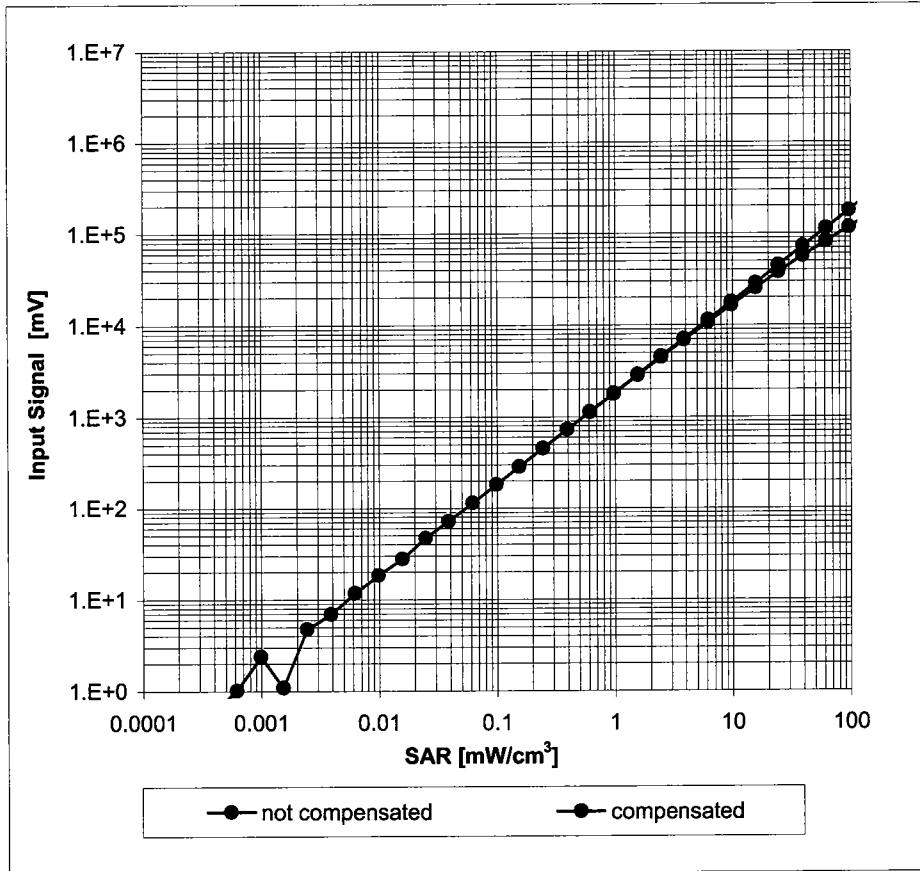

**Uncertainty of Linearity Assessment:  $\pm 0.6\%$  ( $k=2$ )**

## Conversion Factor Assessment

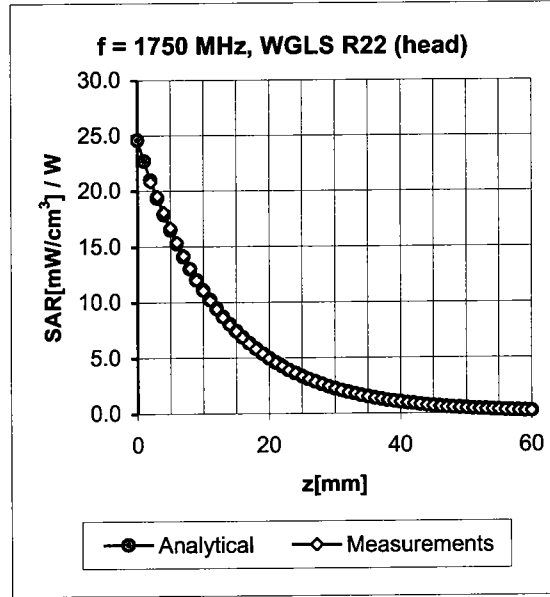
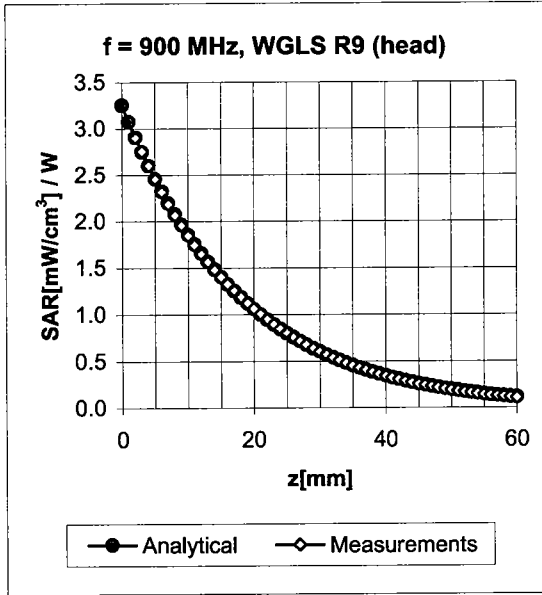

f [MHz]	Validity [MHz] <sup>c</sup>	TSL	Permittivity	Conductivity	Alpha	Depth	ConvF Uncertainty
450	± 50 / ± 100	Head	43.5 ± 5%	0.87 ± 5%	-0.03	2.33	8.28 ± 13.3% (k=2)
835	± 50 / ± 100	Head	41.5 ± 5%	0.90 ± 5%	0.92	0.65	8.12 ± 11.0% (k=2)
900	± 50 / ± 100	Head	41.5 ± 5%	0.97 ± 5%	0.97	0.62	7.76 ± 11.0% (k=2)
1640	± 50 / ± 100	Head	40.3 ± 5%	1.29 ± 5%	0.69	0.73	7.28 ± 11.0% (k=2)
1750	± 50 / ± 100	Head	40.0 ± 5%	1.40 ± 5%	0.64	0.80	6.97 ± 11.0% (k=2)
1900	± 50 / ± 100	Head	40.0 ± 5%	1.40 ± 5%	0.54	0.96	6.75 ± 11.0% (k=2)
1950	± 50 / ± 100	Head	40.0 ± 5%	1.40 ± 5%	0.57	0.88	6.62 ± 11.0% (k=2)
2450	± 50 / ± 100	Head	39.2 ± 5%	1.80 ± 5%	0.61	0.78	6.33 ± 11.8% (k=2)
450	± 50 / ± 100	Body	56.7 ± 5%	0.94 ± 5%	-0.08	2.62	8.05 ± 13.3% (k=2)
835	± 50 / ± 100	Body	55.2 ± 5%	0.97 ± 5%	0.98	0.65	7.99 ± 11.0% (k=2)
900	± 50 / ± 100	Body	55.0 ± 5%	1.05 ± 5%	1.01	0.63	7.75 ± 11.0% (k=2)
1640	± 50 / ± 100	Body	53.8 ± 5%	1.40 ± 5%	0.58	0.99	6.82 ± 11.0% (k=2)
1750	± 50 / ± 100	Body	53.3 ± 5%	1.52 ± 5%	0.50	1.16	6.48 ± 11.0% (k=2)
1900	± 50 / ± 100	Body	53.3 ± 5%	1.52 ± 5%	0.47	1.32	6.35 ± 11.0% (k=2)
1950	± 50 / ± 100	Body	53.3 ± 5%	1.52 ± 5%	0.64	0.83	6.53 ± 11.0% (k=2)
2450	± 50 / ± 100	Body	52.7 ± 5%	1.95 ± 5%	0.83	0.64	6.27 ± 11.8% (k=2)

<sup>c</sup> The validity of ± 100 MHz only applies for DASY 4.3 B17 and higher (see Page 2). The uncertainty is the RSS of the ConvF uncertainty at calibration frequency and the uncertainty for the indicated frequency band.

# Deviation from Isotropy in HSL

Error ( $\phi, \vartheta$ ),  $f = 900$  MHz

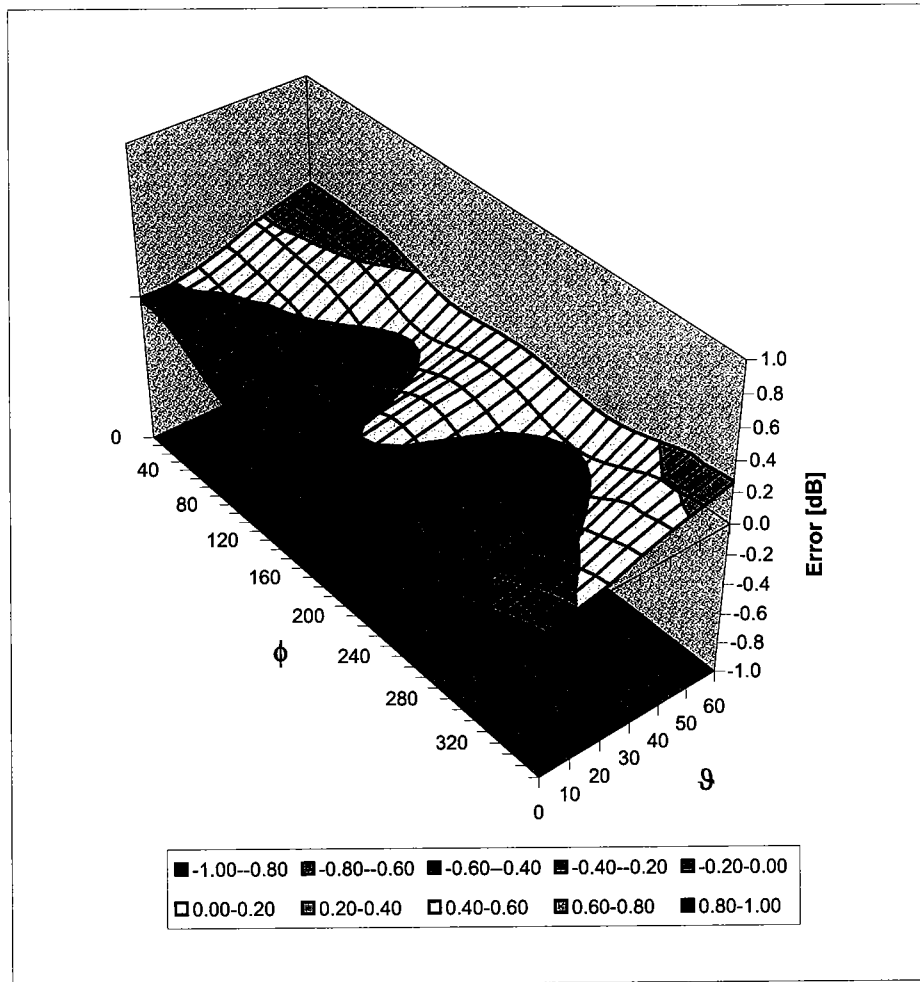

Uncertainty of Spherical Isotropy Assessment:  $\pm 2.6\%$  ( $k=2$ )

# Appendix<sup>D</sup>

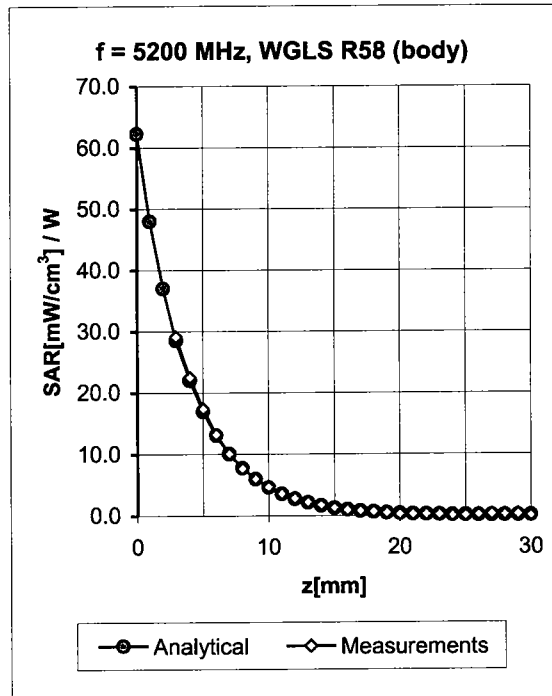
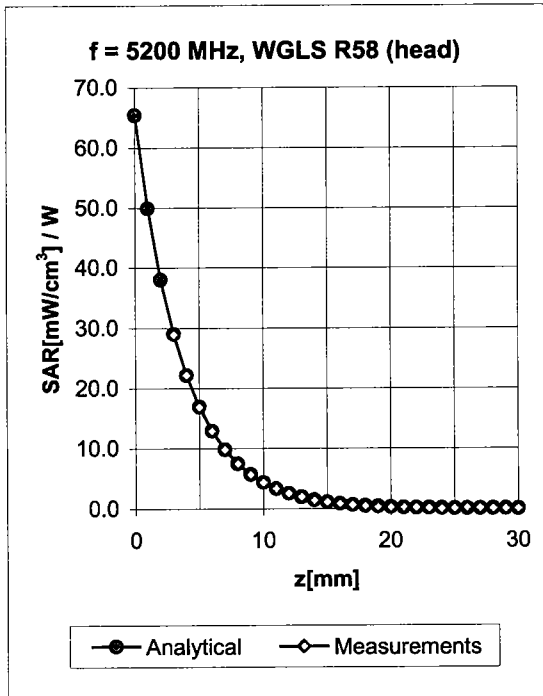

f [MHz] <sup>D</sup>	Validity [MHz]	TSL	Permittivity	Conductivity	Alpha	Depth	ConvF Uncertainty
5200	± 50	Head	36.0 ± 5%	4.76 ± 5%	0.45	1.80	4.17 ± 13.6% (k=2)
5500	± 50	Head	35.6 ± 5%	4.96 ± 5%	0.47	1.80	3.77 ± 13.6% (k=2)
5800	± 50	Head	35.3 ± 5%	5.27 ± 5%	0.48	1.80	3.74 ± 13.6% (k=2)
5200	± 50	Body	49.0 ± 5%	5.30 ± 5%	0.50	1.90	3.72 ± 13.6% (k=2)
5500	± 50	Body	48.6 ± 5%	5.65 ± 5%	0.50	1.95	3.47 ± 13.6% (k=2)
5800	± 50	Body	48.2 ± 5%	6.00 ± 5%	0.50	1.95	3.48 ± 13.6% (k=2)

<sup>D</sup> Accreditation for ConvF assessment above 3000 MHz is currently applied for. Accreditation is expected at the beginning of 2005.