

Emission Test Report

Standard: FCC Part 15 Subpart C / IC RSS-210

Document Number : FCC 19-0213-0

Product: IBM ThinkPad X30 Series

included IBM Dual-Band 11a/b Wi-Fi® Wireless Mini PCI Adapter

FCC ID: ANO20020304T2L
IC: 349E- PH11107E

January 10, 2003

Prepared :
EMC Staff Engineer

Takeshi Asano

Signature: 
IBM Japan, Ltd.
EMC Engineering
LAB-S59

1623-14, Shimotsuruma,
Yamato-shi Kanagawa-ken 242, Japan
Phone: +81-46-215-4779
Fax: +81-46-273-7420
E-Mail: asano@jp.ibm.com

Reviewed and Checked :
EMC Staff Engineer

Toshiya Murota

Signature: 
IBM Japan, Ltd.
EMC Engineering
LAB-S59

1623-14, Shimotsuruma,
Yamato-shi Kanagawa-ken 242, Japan
Phone: +81-46-215-6574
Fax: +81-46-273-7420
E-Mail: murota@jp.ibm.com

Approved :
Manager, EMC Engineering

Akihisa Sakurai

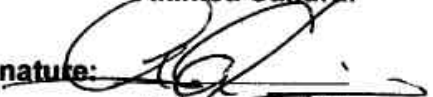
Signature: 
IBM Japan, Ltd.
EMC Engineering
LAB-S59

1623-14, Shimotsuruma,
Yamato-shi Kanagawa-ken 242, Japan
Phone: +81-46-215-2613
Fax: +81-46-273-7420
E-Mail: akihisa@jp.ibm.com

MEASUREMENT / TECHNICAL REPORT – Part 15 Subpart C (Intentional Radiator)

IBM ThinkPad X30 Series
(Machine type : 2672, 2673)
with

IBM Dual-Band 11a/b Wi-Fi® Wireless Mini PCI Adapter

FCC ID : ANO20020304T2L

January 10, 2003

<p>This report concerns: (check one)</p> <p>Original Grant <input checked="" type="checkbox"/></p> <p>Class I change <input type="checkbox"/></p> <p>Class II change <input type="checkbox"/></p>
<p>Equipment type: <u>Wireless LAN device</u></p>
<p>This report shall not be reproduced except in full, without the written permission of this test lab.</p>
<p>The measurement results contained in this report relate only to the item which was tested.</p>
<p>Measurement procedure used is ANSI C63.4-2000 unless otherwise specified.</p>
<p>Other test procedure: _____</p>
<p>The FCC has issued provisional acceptance of this test laboratory for Declaration of Conformity testing per letter dated 1997.</p>
<p>APPLICANT ANTI-DRUG ABUSE CERTIFICATION:</p> <p>By checking yes, the applicant certifies that, in the case of an individual applicant, he or she is not subject to a denial of federal benefits, that includes FCC benefits, pursuant to Section 5301 of the Anti-Drug Abuse of 1988, 21 U.S.C. 853(a), or, in the case of a non-individual applicant (e.g. corporation, partnership or other unincorporated association), no party to the application is subject to a denial of federal benefits, that includes FCC benefits, pursuant to that section. For the definition of a “party” for these purposes, see 47 CFR 1.2002(b).</p> <p style="text-align: center;"><input checked="" type="radio"/> Yes or No</p>
<p>“Report shall not be reproduced except in full, without the written approval of the laboratory” “the report must not be used by the client to claim product endorsement by NVLAP or any agency of the US government”</p>
<p>Prepared by: Takeshi Asano</p> <p style="text-align: right;">IBM Japan Corporation, Yamato EMC Engineering LAB-S59, 1623-14, Shimotsuruma, Yamato-shi Kanagawa-ken 242-8502, Japan Tel: +81-46-215-4779 Fax: +81-46-273-7420</p>

- Index -

A. GENERAL INFORMATION5

A.1 TEST METHODOLOGY5

A.2 TEST FACILITY / NVLAP ACCREDITATION5

A.3 EUT DETAILS5

B. SUMMARY OF TEST RESULTS6

C. OPERATION MODE OF EUT7

D. JUSTIFICATION7

E. TEST INSTRUMENTS8

F. MEASUREMENT UNCERTAINTY9

G. TEMPERATURE AND HUMIDITY10

H. RELATED SUBMITTAL(S)/GRANT(S)/NOTES10

1. BANDWIDTH AT 6 DB BELOW11

1.1 TEST PROCEDURE 11

1.2 TEST INSTRUMENTS AND MEASUREMENT SETUP 11

1.3 MEASUREMENT RESULTS 11

1.4 TRACE DATA OF 6DB BANDWIDTH12

2. OCCUPIED BANDWIDTH AT 20 DB BELOW / BANDEDGE, AND OUT OF BAND EMISSIONS18

2.1 TEST PROCEDURE18

2.2 TEST INSTRUMENTS AND MEASUREMENT SETUP18

2.3 MEASUREMENT RESULTS OF OCCUPIED BANDWIDTH/BAND-EDGE18

2.4 MEASUREMENT RESULTS OF OUT OF BAND EMISSIONS18

2.5 TRACE DATA OF 20DB BANDWIDTH19

2.6 TRACE DATA OF OUT OF BAND EMISSIONS25

3. CONDUCTED PEAK OUTPUT POWER31

3.1 TEST PROCEDURE31

3.2 MEASUREMENT RESULTS32

3.4 TRACE DATA OF CONDUCTED PEAK OUTPUT POWER33

4. PEAK POWER SPECTRAL DENSITY39

4.1 TEST PROCEDURE39

4.2 TEST INSTRUMENTS AND MEASUREMENT SETUP39

4.3 MEASUREMENT RESULTS39

4.4 TRACE DATA OF PEAK POWER SPECTRAL DENSITY40

5. AC WIRELINE CONDUCTED EMISSIONS (150KHZ – 30MHZ)46

5.1 TEST PROCEDURE46

5.2 TEST INSTRUMENTS AND MEASUREMENT SETUP46

5.3 MEASUREMENT RESULTS47

6. RESTRICTED BANDS RADIATIONS (30MHZ – 1GHZ)49

6.1 TEST PROCEDURE49

6.2 TEST INSTRUMENTS AND MEASUREMENT SETUP49

6.3 FIELD STRENGTH CALCULATION51

6.4 MEASUREMENT RESULTS.....52

7. RESTRICTED BANDS RADIATIONS (1GHZ – 40GHZ)55

7.1 TEST PROCEDURE.....55

7.2 TEST INSTRUMENTS AND MEASUREMENT SETUP55

7.3 FIELD STRENGTH CALCULATION57

7.4 MEASUREMENT RESULTS.....58

A. General Information

APPLICANT : IBM Japan, Ltd.
 TEST SITE : IBM Japan, Ltd., Yamato Semi-anechoic chamber #1
 TEST SITE ADDRESS : 1623 – 14 Shimotsuruma, Yamato-shi, Kanagawa 242-8502 Japan
 Tel: +81-46-215-4779, Fax: +81-46-273-7420
 REGULATION : FCC Part 15 Subpart C
 Industry Canada RSS-210 (Issue No.5)
 MODEL NUMBER : 2672-CHU (ThinkPad X30 Series)
 FCC ID : ANO20020304T2L
 IC Certification Number : 349E-PH11107E
 SERIAL NUMBER : ZZ-00094
 PHYSICAL CONDITION : Preproduction
 KIND OF EQUIPMENT : Personal computer with a IEEE802.11a & b Wireless LAN
 Mini-PCI Combo Card ([Composite application](#))
 TESTED DATE : November 18, 22, 25, 26, 27, December 4, 5, 11, 16, 24, 2002
 and January 8, 2003

A.1 Test Methodology

Both conducted and radiated testing were performed according to the procedures in ANSI C63.4-2000. Radiated testing was performed at an antenna to EUT distance of 3 meters.

A.2 Test Facility / NVLAP Accreditation

The semi-anechoic chamber #2 used to correct the data are located in Yamato Laboratory, IBM Japan.

- This facility has been fully described in a report dated September 1998, submitted to the FCC office, and accepted in a letter, dated Nov. 2, 1998(31040/SIT).
- IBM Yamato EMC Engineering is recognized under the National Voluntary Laboratory Accreditation Program for satisfactory compliance with Criteria established in Title 15, Part 285 Code of Federal Regulations.(NVLAP Lab code: 200198-0)
- This facility is accepted by **Industry Canada** in a letter dated March 19, 2001 as number **IC 349E** for chamber #2, and January 25, 2002 as number **IC 4221** for chamber #1.

A.3 EUT details

Table-A EUT details

Model and S/N	FCC ID IC Certification Number	Description
IBM Dual-Band 11a/b Wi-Fi® Wireless Mini PCI Adapter (s/n PVT-074F)	IC: 349E-PH11107E	IEEE802.11a & b Wireless LAN Mini-PCI Combo Card without antenna
ThinkPad X30 Series M/T 2672-CHU (s/n ZZ-00094)	FCC ID: ANO20020304T2L	Applying equipment IBM Notebook PC with built_in antenna CPU: Intel® Pentium® M Processor, 1.3GHz
P/N 02K6808	N/A	Universal AC adapter 56W, Unshielded power cord

B. Summary of Test Results

Table-B presents the list of the measurement items for DTS (Digital Transmissions System) devices under FCC Part 15 Subpart C and Industry Canada RSS-210.

The section numbers of upper portion are showing FCC number, and the other (lower) ones are for IC.

Table-B List of the measurements

Section(s)	Test Items		Condition	Result
	Transmit mode (TX):			
15.247(a)(2) 5.9.1	Bandwidth at 6 dB below		Conducted	Pass
15.247(c) 5.9.1 6.2.2 (o) (e1)	Occupied BW (or Band-edge) Out of Band Emissions (Bandwidth at 20 dB below)	The radiated emission in any 100kHz of outband shall be at least 20dB below the highest inband spectral density.		Pass
15.247(b) 6.2.2 (o) (b)	Transmitter peak output power	Shall not exceed 1.0 W.		Pass
15.247(d) 6.2.2 (o) (b)	Transmitter power spectral Density	Shall not be greater than 8 dBm in any 3kHz band.		Pass
15.207 6.6	AC Wireline Conducted Emissions 150kHz – 30MHz	Class B: Freq.(MHz) QP(dBμV) Ave.(dBμV) 0.15 - 0.5 66 - 56 56 - 46 0.5 - 5 56 46 5 - 30 60 50		Pass
15.205 / 209 6.2.1 / 6.3	General Field Strength Limits (Restricted Bands and Radiated Emission Limits)	Shall not exceed the limits specified in FCC 15.209 or RSS-210 Table3.	Radiated (30MHz - 1GHz)	Pass
			Radiated (1– 25GHz)	Pass

Receive mode (RX):				
15.207 7.4	AC Wireline Conducted Emissions 150kHz – 30MHz	Class B: Freq.(MHz) QP(dBμV) Ave.(dBμV) 0.15 - 0.5 66 - 56 56 - 46 0.5 - 5 56 46 5 - 30 60 50	Conducted	Pass
15.209 7.3	General Field Strength Limits (Radiated Emission Limits)	Shall not exceed the limits specified in RSS-210.	Radiated (30MHz - 1GHz)	Pass
			Radiated (1– 25GHz)	Pass

C. Operation Mode of EUT

1. All tests were performed using the “Atheros Radio Test” program. This tool supports the continuous transmission mode for the testing purpose.
2. The following frequencies were chosen for the measurements of each 2.4GHz or 5.8GHz band.
 - 2412MHz (lowest), 2437MHz(middle), and 2462MHz (highest) for 2.4GHz band
 - 5745MHz (lowest), 5785MHz(middle), and 5825MHz (highest) for 5.8GHz band
3. 11Mbps and 24Mbps transmission modes were selected for full testing as the worse case samplings. See “Chapter 3. Conducted Peak Output Power” as to the determination of measurement plots.
4. As for the RF receiving test, the middle channels (2437MHz or 5785MHz) were selected representatively.

Table-C Transmission mode of EUT (The measurement plots are shown in shading.)

Operation Frequency [GHz]	Rated output power (conducted) [dBm]										
	Bit rate 1/2M bps	5.5M bps	11M bps	6M bps	9M bps	12M bps	18M bps	24M bps	36M bps	18M bps	54M bps
2.412 (Ch. 1)	+17	+17	+17	-	-	-	-	-	-	-	-
2.417 (Ch. 2)	+17	+17	+17	-	-	-	-	-	-	-	-
2.422 (Ch. 3)	+17	+17	+17	-	-	-	-	-	-	-	-
2.427 (Ch. 4)	+17	+17	+17	-	-	-	-	-	-	-	-
2.432 (Ch. 5)	+17	+17	+17	-	-	-	-	-	-	-	-
2.437 (Ch. 6)	+17	+17	+17	-	-	-	-	-	-	-	-
2.442 (Ch. 7)	+17	+17	+17	-	-	-	-	-	-	-	-
2.447 (Ch. 8)	+17	+17	+17	-	-	-	-	-	-	-	-
2.452 (Ch. 9)	+17	+17	+17	-	-	-	-	-	-	-	-
2.457 (Ch. 10)	+17	+17	+17	-	-	-	-	-	-	-	-
2.462 (Ch. 11)	+17	+17	+17	-	-	-	-	-	-	-	-
5.745 (Ch.149)	-	-	-	+16	+16	+16	+16	+16	+15	+12	+10
5.765 (Ch.153)	-	-	-	+16	+16	+16	+16	+16	+15	+12	+10
5.785 (Ch.157)	-	-	-	+16	+16	+16	+16	+16	+15	+12	+10
5.805 (Ch.161)	-	-	-	+16	+16	+16	+16	+16	+15	+12	+10
5.825 (Ch.165)	-	-	-	+16	+16	+16	+16	+16	+15	+12	+10

D. Justification

The EUT was investigated for both the main (left) and the auxiliary (right) antennas. The worse case data taken in this report represents the measurement result of the right antenna that has comparatively higher gain in 2.4GHz band, and the left antenna in 5.8GHz band.

The same tendency with the previous application (ANO20020300D3L) was found on the worse cases, since the applying transmitter module is the same. i.e. The columns marked in shading of the above table is the worst cases of each Tx mode for all measurement items (conducted power, 6dB BW, ..etc.).

Table-D Peak Antenna Gains of EUT

2.4GHz band	Left Antenna gain	0.62 dBi (peak)
	Right Antenna gain	1.28 dBi (peak)
5.8GHz band	Left Antenna gain	0.32 dBi (peak)
	Right Antenna gain	-0.87 dBi (peak)

E. Test Instruments

Table-E List of Measuring Instruments

Description	Model	Serial Number	Calibration Date	Calibration Interval
Computer	IBM 5551-L	#4	N/A	N/A
Computer	IBM 6589-13J	97-15613	N/A	N/A
Spectrum Analyzer (100Hz-1.5GHz)	HP 85680B	2601A02634	08/28/02	1 year
Spectrum Analyzer (100Hz-1.5GHz)	HP 85680B	3019A05155	02/15/02	1 year
Spectrum Analyzer (100Hz-1.5GHz)	HP 85680B	2841A04252	06/17/02	1 year
Spectrum Analyzer Display	HP 85662A	2542A12308	08/28/02	1 year
Spectrum Analyzer Display	HP 85662A	3026A19353	02/15/02	1 year
Spectrum Analyzer Display	HP 85662A	2816A16831	06/17/02	1 year
Quasi-Peak Adapter	HP 85650A	2043A00062	08/28/02	1 year
Quasi-Peak Adapter	HP 85650A	2811A01156	06/17/02	1 year
Quasi-Peak Adapter	HP 85650A	3033A01449	02/15/02	1 year
Amplifier (100KHz - 1.3GHz) - for 30-200MHz	HP 8447D	2805A02919	04/15/02	1 year
- for 200-1000MHz	HP 8447D	2944A03506	04/15/02	1 year
Amplifier (1 - 26.5GHz)	HP 8449B	3008A00582	06/13/02	1 year
Amplifier (26.5 - 40GHz)	Agilent 83051A	3950M00193	12/06/01	1 year
Spectrum Analyzer EMI Test Receiver	R&S ESI26	836119/003	07/18/02	1 year
Spectrum Analyzer	HP 8563E	3416A02248	08/14/02	1 year
Harmonic Mixer	Agilent 11970A	011269-001	07/19/02	1 year
Receiver (9kHz-30MHz)	R&S ESH3	891806/012	10/07/02	1 year
Receiver (20MHz-1.3GHz)	R&S ESVP	893202/018	02/06/02	1 year
Biconical Antenna (30-200MHz)	EMCO 3108	2309	05/06/02	1 year
Log-Periodic Antenna (200-1000MHz)	EMCO 3146	1585	05/06/02	1 year
Horn Antenna (1- 18GHz)	EMCO 3115	9903-5774	07/18/02	1 year
Horn Antenna (3.95- 5.85GHz)	EMCO 3160-5	1099	04/17/02	1 year
Horn Antenna (5.85- 8.20GHz)	EMCO 3160-6	9712-1044	04/17/02	1 year
Horn Antenna (8.2- 12.4GHz)	EMCO 3160-7	1156	04/17/02	1 year
Horn Antenna (12.4- 18GHz)	EMCO 3160-8	1143	04/17/02	1 year
Horn Antenna (18- 26.5GHz)	EMCO 3160-9	0004-1202	04/17/02	1 year
Horn Antenna (26.5- 40GHz)	EMCO 3160-10	1175	04/17/02	1 year
LISN	EMCO 3825/2	1426	09/01/02	1 year
Power Meter	HP 437B	3043U03437	11/08/02	1 year
Power Sensor	HP 8481A	US41030582	11/08/02	1 year
Switch/control unit	HP 3488A	2719A17226	N/A	N/A
		2719A17228	N/A	N/A
Plotter	HP 7550A	2631A33619	N/A	N/A
Coaxial cables (1 – 18GHz):	Length:			

- Horn Ant <=> RF Amp.	6 m	- EM206SCO	09/05/02	1 year
- RF Amp.<=>Spectrum Analyzer(<12GHz)	15m	- EM215SCO	09/05/02	1 year
- RF Amp.<=>Spectrum Analyzer(>12GHz)	3 m	- SF102-20166	09/05/02	1 year
Coaxial cables (18 – 40GHz):				
- Horn Ant <=> RF Amp.	3m	- SF102-20167	09/05/02	1 year
- RF Amp.<=>Spectrum Analyzer	1m	- SF102-21105	09/05/02	1 year
N-Coax cables:				
- Bi-coni Ant <=> 10m Cable	9 m	- EM103L01	04/15/02	1 year
- 10m Cable <=> Shield Panel	10 m	- EM103L02	04/15/02	1 year
- Shield Panel <=> RF Amp	7 m	- EM103L03	04/15/02	1 year
- RF Amp <=> Power Splitter	0.5m	- EM103L04	04/15/02	1 year
- Log-peri Ant <=> 10m Cable	9 m	- EM103H01	04/15/02	1 year
- 10m Cable <=> Shield Panel	10 m	- EM103H02	04/15/02	1 year
- Shield Panel <=> RF Amp	7 m	- EM103H03	04/15/02	1 year
- RF Amp <=> Power Splitter	0.5m	- EM103H04	04/15/02	1 year
Coax cables:				
- Lisn-L <=> SW/Con.unit (SW100)	4 m	- EMIC-L	04/15/02	1 year
- Lisn-N <=> SW/Con.unit (SW101)	4 m	- EMIC-N	04/15/02	1 year
- SW/Con.unit <=> RCVR (Input)	1 m	- EMIC-R	04/15/02	1 year
- SW/Con.unit<=> Spe Ana.(Signal In)	1 m	- EMIC-S	04/15/02	1 year
- Power Splitter <=> SW/Con.unit (SW110)	1 m	- EM103L05	04/15/02	1 year
- Power Splitter <=> SW/Con.unit (SW300)	1 m	- EM103L06	04/15/02	1 year
- Power Splitter <=> SW/Con.unit (SW100)	1 m	- EM103H05	04/15/02	1 year
- Power Splitter <=> SW/Con.unit (SW301)	1 m	- EM103H06	04/15/02	1 year
- SW/Con.unit <=> Receiver (Input)	2 m	- EM1RCV	04/15/02	1 year
- SW/Con.unit <=> Spe Ana.(Signal In) for 30- 200MHz	2 m	- EM1SPL	04/15/02	1 year
- SW/Con.unit <=> Spe Ana.(Signal In) for 200-1000MHz	2 m	- EM1SPH	04/15/02	1 year

Notes.

- The above equipment calibration is traceable to National standards.
- HP: Hewlett Packard, R&S: Rohde & Schwarz

F. Measurement Uncertainty

Uncertainties of the both, the Yamato EMI radiated test facilities (EMI chambers, #1 and #2) and the Yamato EMI conducted test facility are derived with the NIS 81 " Treatment of uncertainty in EMC measurements" 1994.

Estimated site uncertainty values are as follows.

- EMI chamber #1 : 4.39dB
- EMI chamber #2 : 4.40dB
- EMI conducted measurement system : 2.4dB

Detail should be referred to "Treatment of Uncertainty, Calculations and Policy" report, document number TCR 10-0015.

G. Temperature and Humidity

The temperature is controlled within range of 17° to 28°.

The relative humidity is controlled within range of 40% to 70%.

H. Related Submittal(s)/Grant(s)/Notes

The host unit with full peripheral devices including the applying modular as an unintentional radiator is classified as a Digital Device under the FCC Part 15 Subpart B or the Industry Canada Class B Emission Compliance (ICES-003), and subject to SDoC.

1. Bandwidth at 6 dB below

1.1 Test Procedure

The bandwidth at 6 dB down from the highest inband spectral density is measured with a spectrum analyzer connected to the antenna terminal, while EUT is operating in transmission mode at the appropriate center frequency.

The spectrum analyzer is set to :

RBW=100kHz, VBW=100kHz^{*1}, Span=30MHz, Sweep=suitable duration based on the EUT specification

*1: To be adjusted accordingly based on the spectrum stability

1.2 Test Instruments and Measurement Setup

Table 1-1 : 6 dB Bandwidth Test Instruments

Description	Model	Serial Number
Spectrum Analyzer EMI Test Receiver	R&S ESI26	836119/003
Coax cables: - Spectrum Analyzer <=> EUT	Length: 110 cm Loss: 1.3 dB (for 2.4GHz) 2.3 dB (for 5.8GHz)	

Notes: - R&S: Rohde & Schwarz

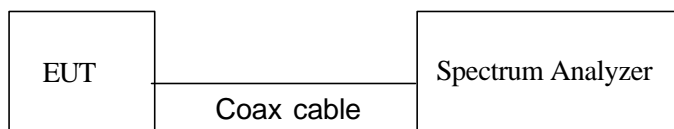

Figure 1: Measurement setup for 6dB bandwidth test

1.3 Measurement Results

Test Date: December 11 and 16, 2002

Table 1-2. EUT: M/T 2672-CHU, s/n ZZ-00094 , TX mode

Center Frequency (MHz)	Trace number	Lower frequency (MHz)	Upper frequency (MHz)	Bandwidth at 6 dB below (MHz)	note
2412	Plot 1-1	2406.62	2417.50	10.88	> 500kHz
2437	Plot 1-2	2431.38	2442.50	11.12	
2462	Plot 1-3	2456.62	2467.08	10.46	
5745	Plot 1-4	5736.67	5753.33	16.66	> 500kHz
5785	Plot 1-5	5776.67	5793.33	16.66	
5825	Plot 1-6	5816.67	5833.33	16.66	

1.4 Trace Data of 6dB bandwidth

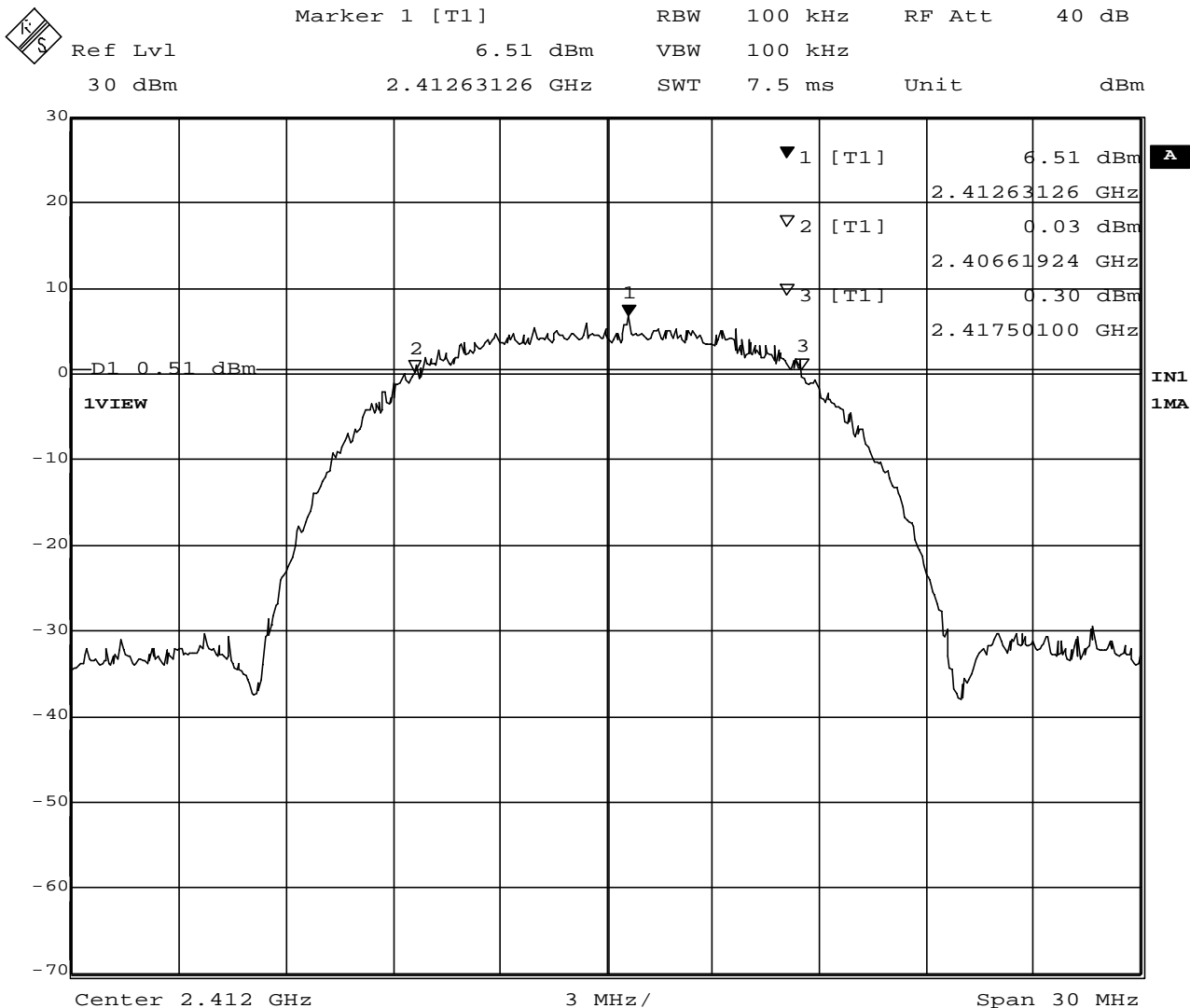

Date: 11.DEC.2002 19:58:28

Plot 1-1. 6dB BW at 2412MHz



Marker 1 [T1] RBW 100 kHz RF Att 40 dB
 Ref Lvl 6.30 dBm VBW 100 kHz
 30 dBm 2.43757114 GHz SWT 7.5 ms Unit dBm

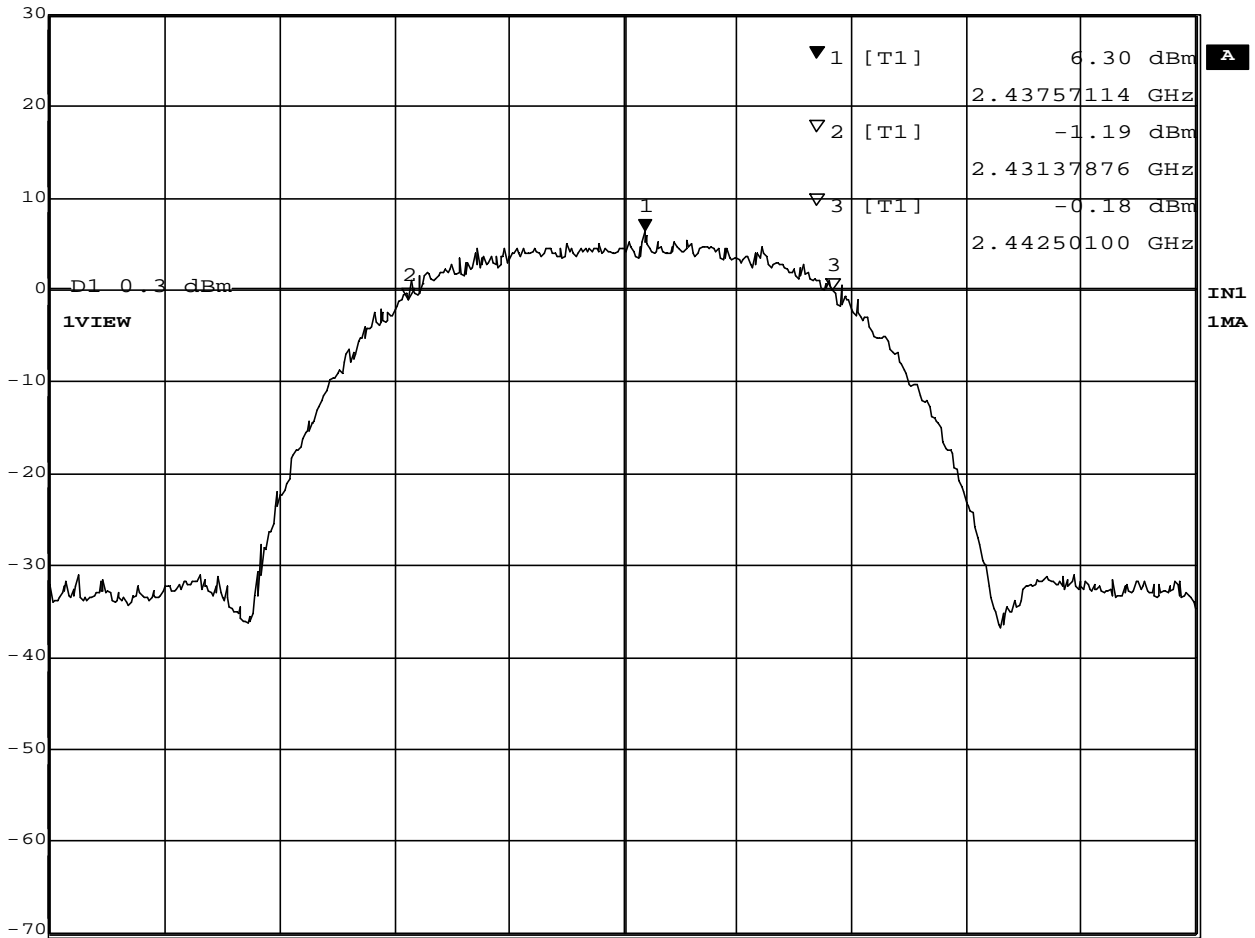

Center 2.437 GHz 3 MHz/ Span 30 MHz

Date: 11.DEC.2002 20:01:15

Plot 1-2. 6dB BW at 2437MHz



Marker 1 [T1] RBW 100 kHz RF Att 40 dB
 Ref Lvl 6.80 dBm VBW 100 kHz
 30 dBm 2.46257114 GHz SWT 7.5 ms Unit dBm

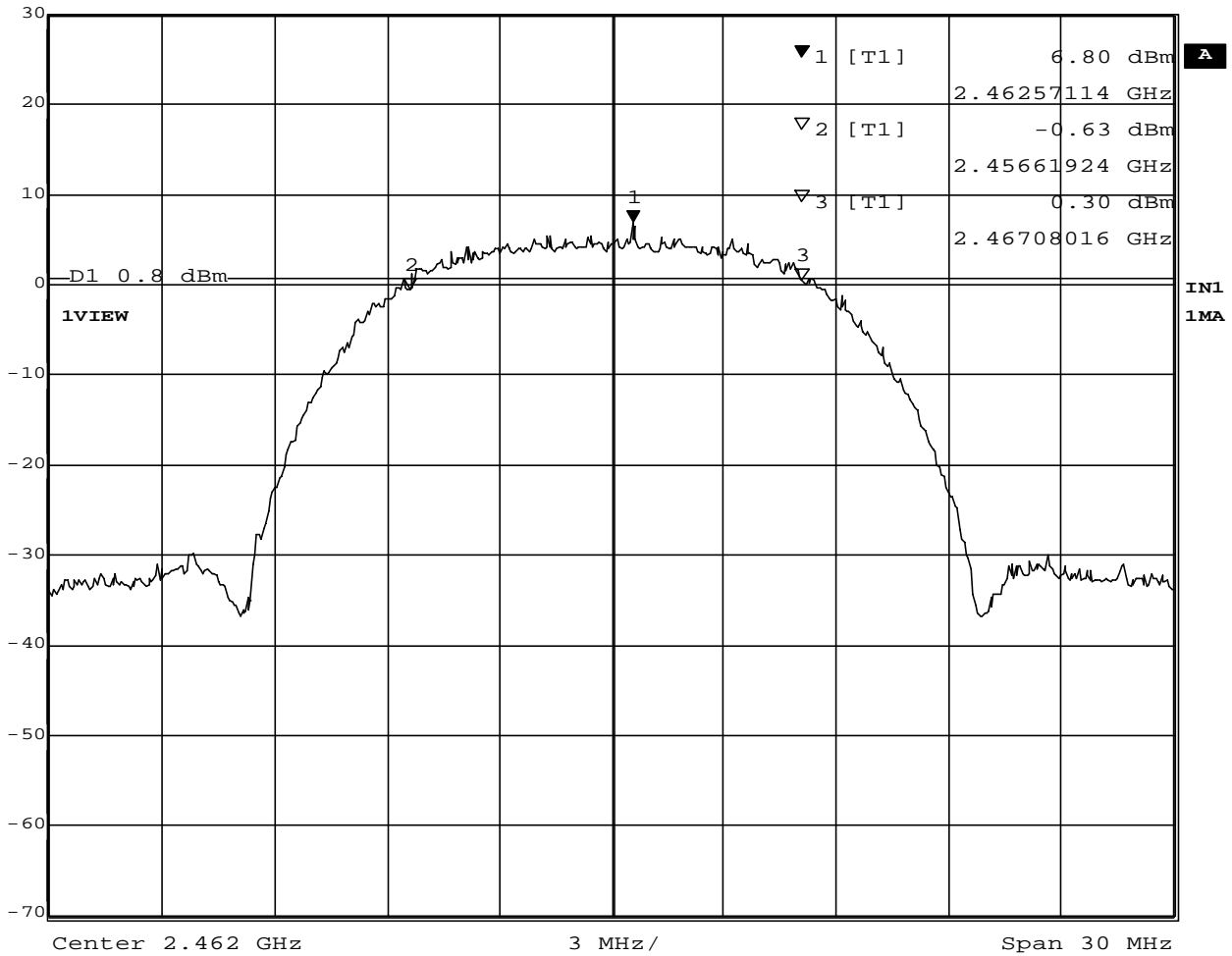

Date: 11.DEC.2002 20:03:45

Plot 1-3. 6dB BW at 2462MHz



Marker 1 [T1] RBW 100 kHz RF Att 40 dB
 Ref Lvl 2.08 dBm VBW 100 kHz
 30 dBm 5.74749499 GHz SWT 7.5 ms Unit dBm

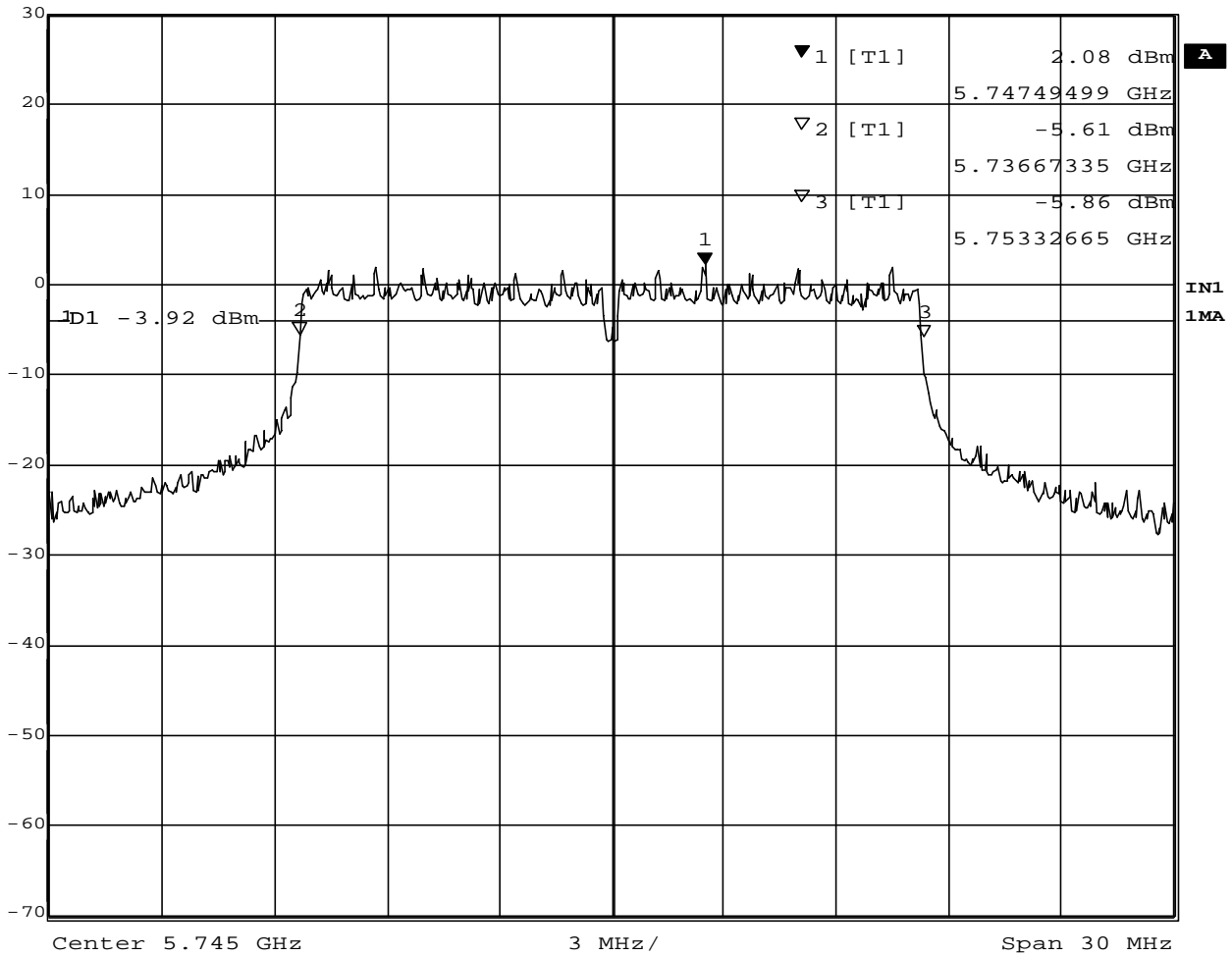

Date: 16.DEC.2002 17:44:17

Plot 1-4. 6dB BW at 5745MHz



Marker 1 [T1] RBW 100 kHz RF Att 40 dB
 Ref Lvl 2.03 dBm VBW 100 kHz
 30 dBm 5.77871743 GHz SWT 7.5 ms Unit dBm

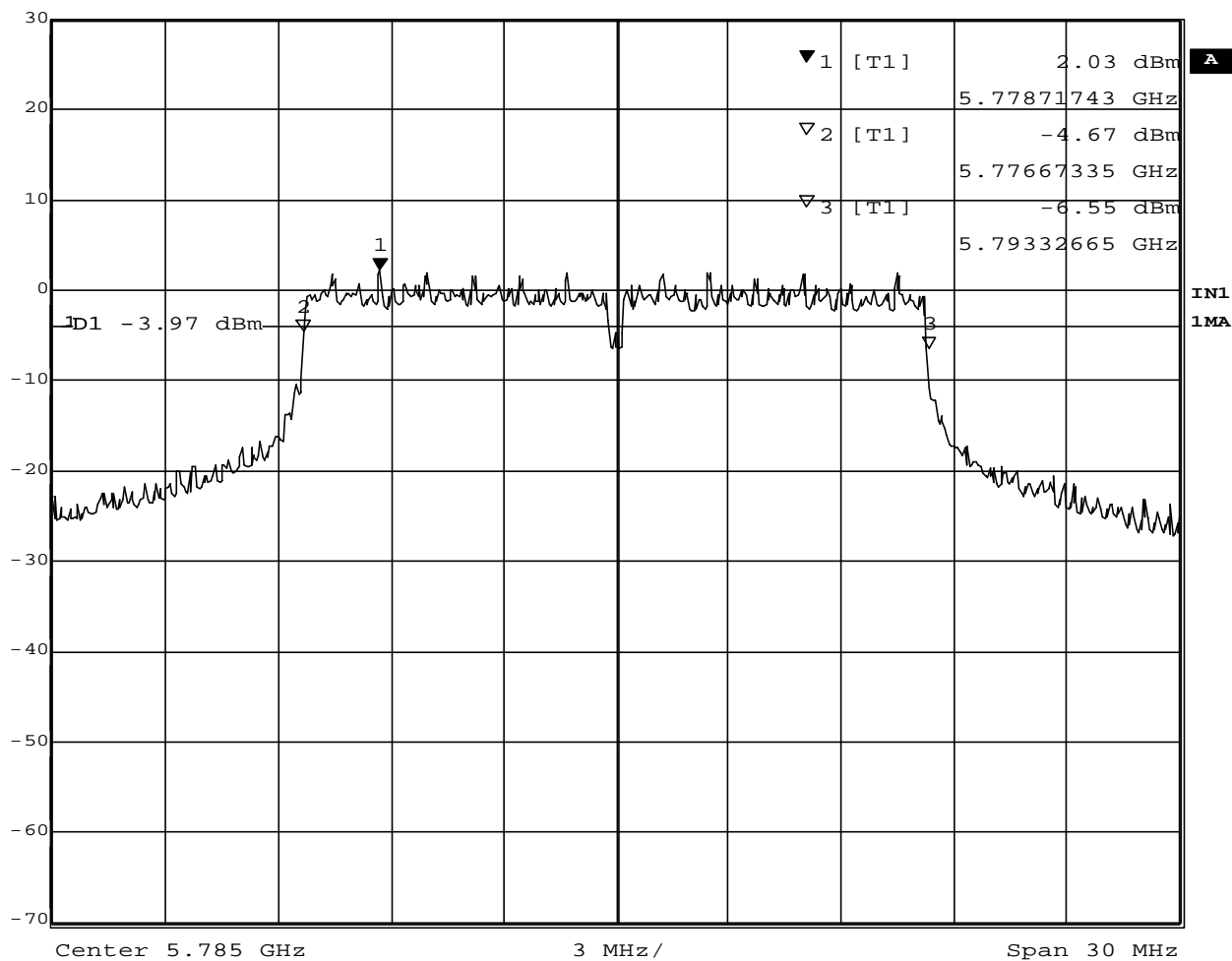

Date: 16.DEC.2002 17:43:00

Plot 1-5. 6dB BW at 5785MHz



Marker 1 [T1] RBW 100 kHz RF Att 40 dB
 Ref Lvl 2.57 dBm VBW 100 kHz
 30 dBm 5.81871743 GHz SWT 7.5 ms Unit dBm

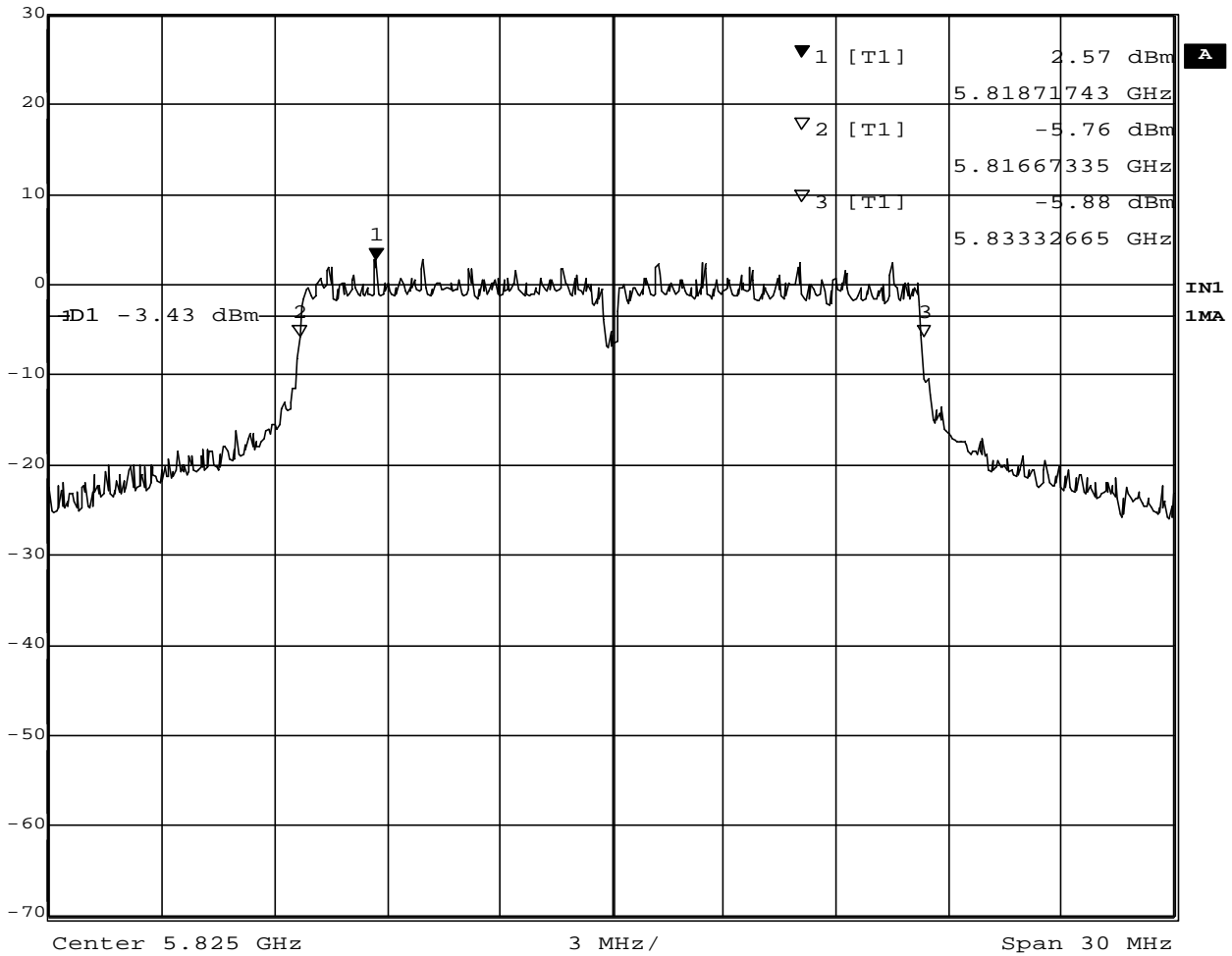

Date: 16.DEC.2002 17:46:32

Plot 1-6. 6dB BW at 5825MHz

2. Occupied Bandwidth at 20 dB below / Bandedge, and Out of Band Emissions

2.1 Test Procedure

The bandwidth at 20 dB down from the highest inband spectral density is measured with a spectrum analyzer connected to the antenna terminal, while EUT is operating in transmission mode at the appropriate center frequency.

The spectrum analyzer is set to:

RBW=100kHz, VBW=100kHz^{*1}, Span=50MHz, Sweep=suitable duration based on the EUT specification

*1: To be adjusted accordingly based on the spectrum stability

2.2 Test Instruments and Measurement Setup

Same as the Chapter 1 (Table 1-1 & Figure 1).

2.3 Measurement Results of Occupied Bandwidth/Band-edge

Test Date: December 11 and 16, 2002

Table 2-1. EUT: M/T 2672-CHU, s/n ZZ-00094 , TX mode

Center Frequency (MHz)	Trace number	Lower Frequency 20dB below (MHz)	Upper Frequency 20dB below (MHz)	Bandwidth at 20dB below (MHz)	Margin to Lower bandedge (MHz)	Margin to Upper bandedge (MHz)
2412	Plot 2-1	2403.95	2420.19	16.24	3.95	
2437	Plot 2-2	2428.83	2445.24	16.41		
2462	Plot 2-3	2453.83	2470.09	16.26		13.41
5745	Plot 2-4	5735.65	5754.49	18.84	10.65	
5785	Plot 2-5	5774.83	5794.47	19.64		
5825	Plot 2-6	5814.53	5834.97	20.44		15.03

2.4 Measurement Results of Out of Band Emissions

All conducted emission in any 100kHz bandwidth outside of the spread spectrum band was at least 20dB lower than the highest inband spectral density.

Test Date: December 11 and 16, 2002 : See Plot 2-7 to 2-12.

2.5 Trace Data of 20dB bandwidth

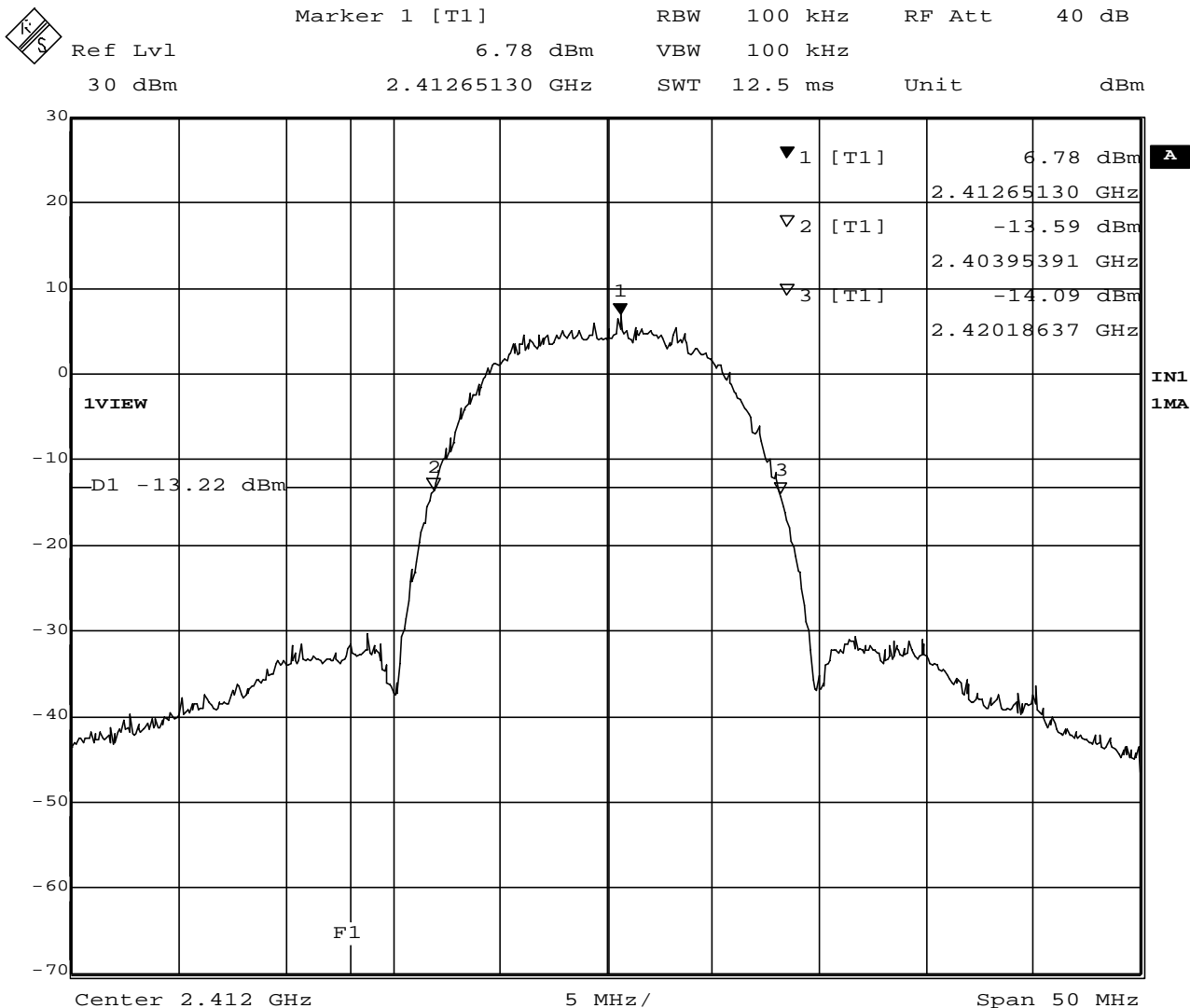

Date: 11.DEC.2002 20:06:22

Plot 2-1. 20dB BW at 2412MHz



Marker 1 [T1] RBW 100 kHz RF Att 40 dB
 Ref Lvl 5.90 dBm VBW 100 kHz
 30 dBm 2.43765130 GHz SWT 12.5 ms Unit dBm

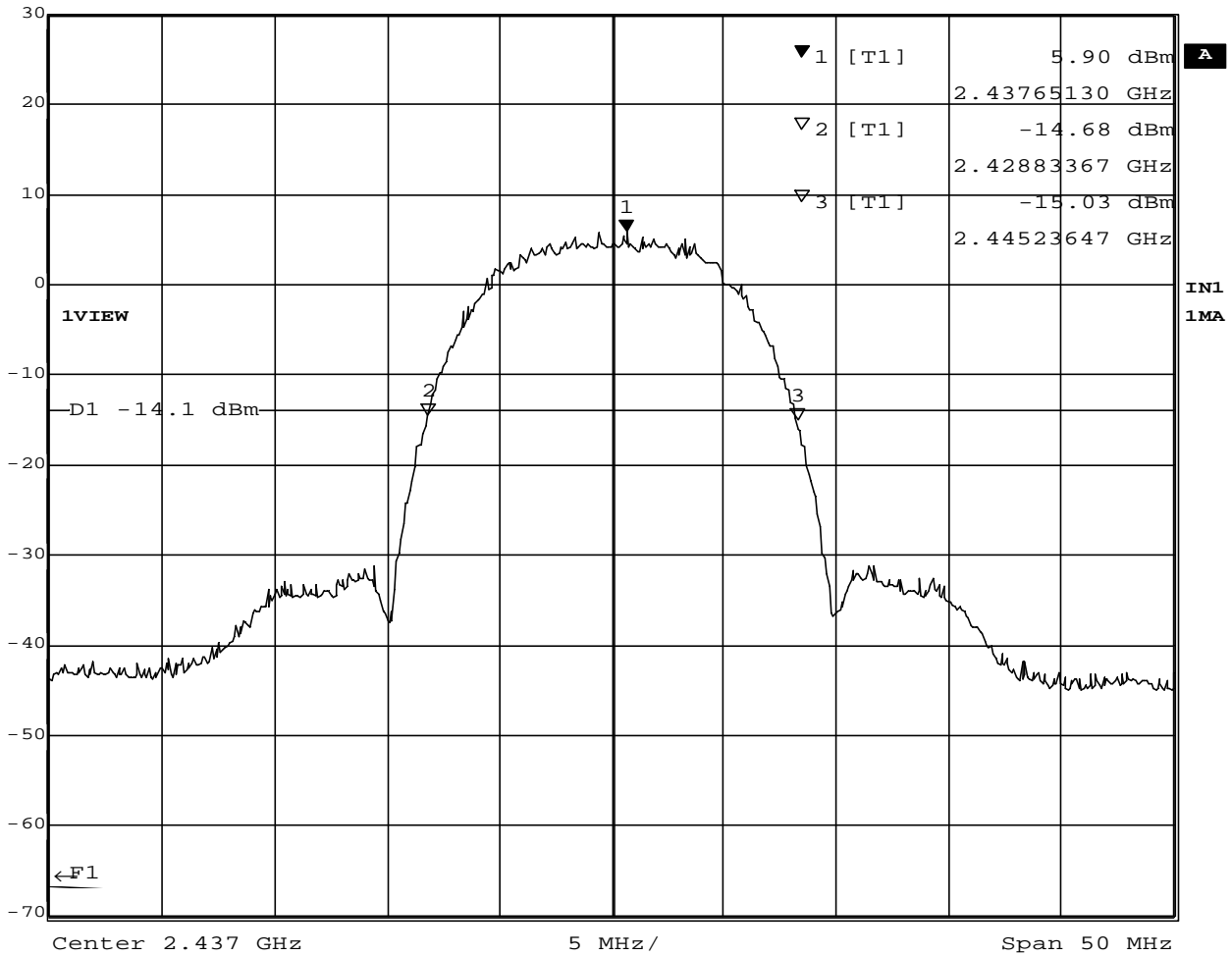

Date: 11.DEC.2002 20:08:11

Plot 2-2. 20dB BW at 2437MHz



Marker 1 [T1] RBW 100 kHz RF Att 40 dB
 Ref Lvl 6.61 dBm VBW 100 kHz
 30 dBm 2.46265130 GHz SWT 12.5 ms Unit dBm

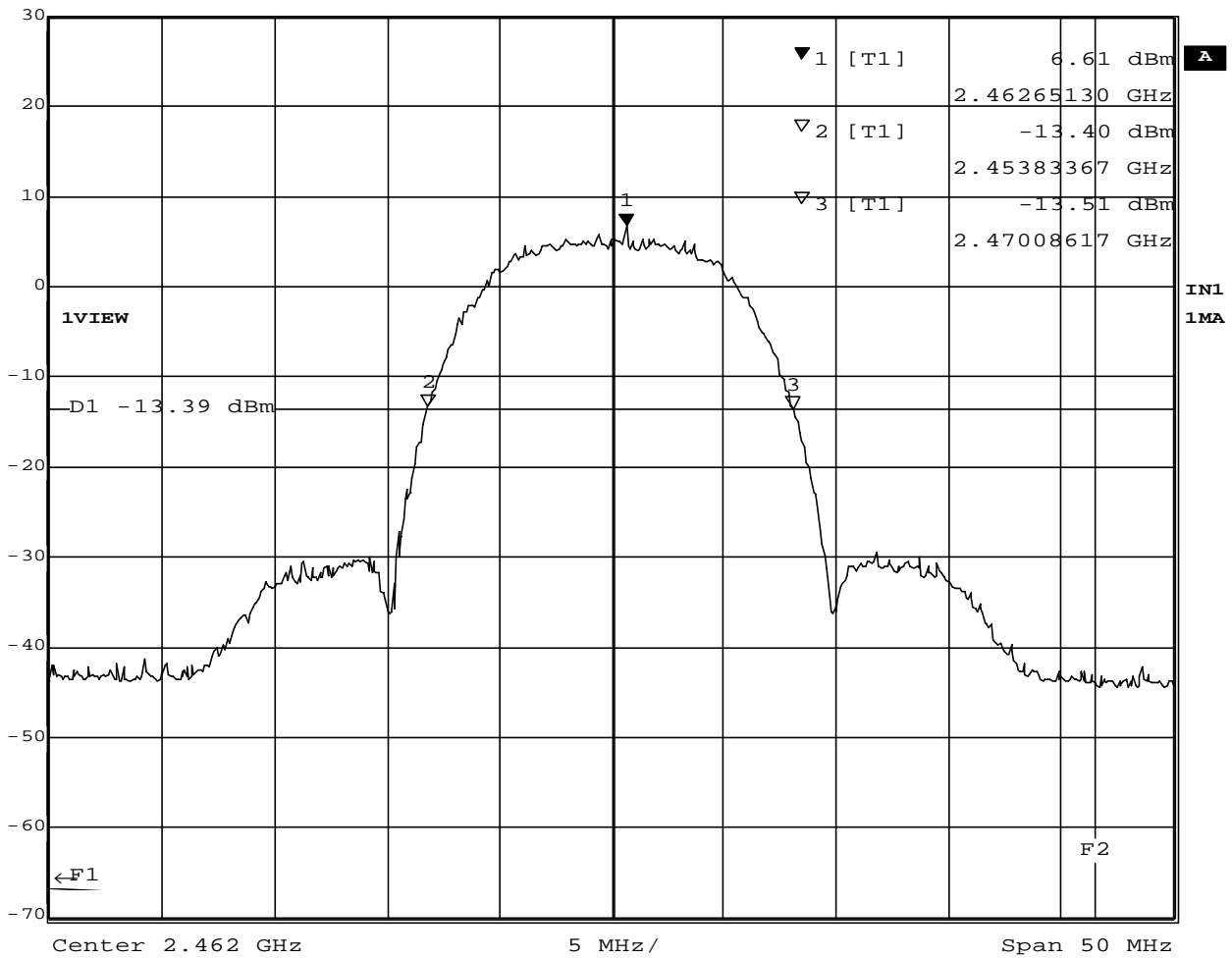

Date: 11.DEC.2002 20:11:22

Plot 2-3. 20dB BW at 2462MHz



Marker 1 [T1] RBW 100 kHz RF Att 40 dB
 Ref Lvl 2.21 dBm VBW 100 kHz
 30 dBm 5.73873747 GHz SWT 12.5 ms Unit dBm

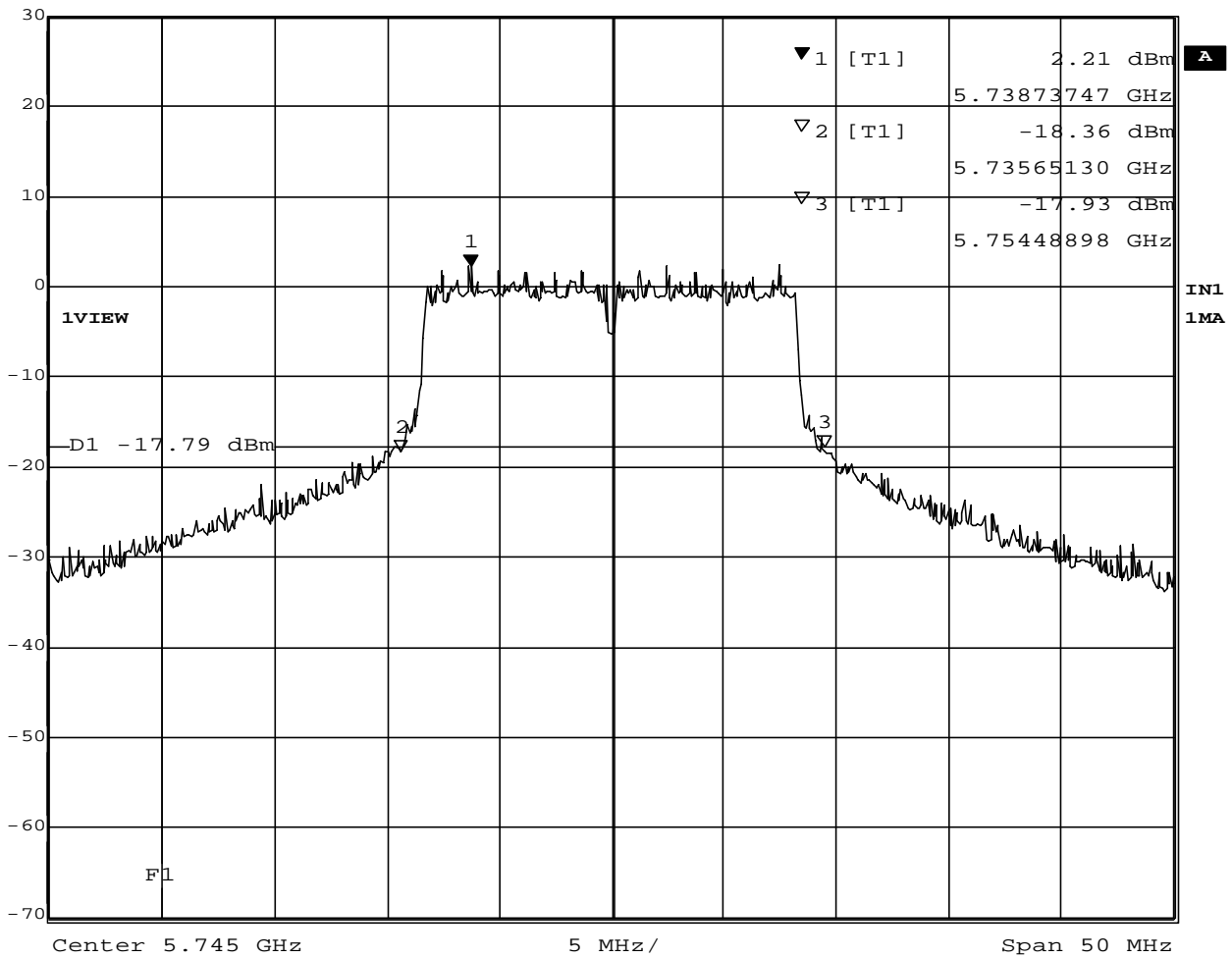

Date: 16.DEC.2002 17:49:55

Plot 2-4. 20dB BW at 5745MHz



Marker 1 [T1] RBW 100 kHz RF Att 40 dB
 Ref Lvl 2.32 dBm VBW 100 kHz
 30 dBm 5.78745491 GHz SWT 12.5 ms Unit dBm

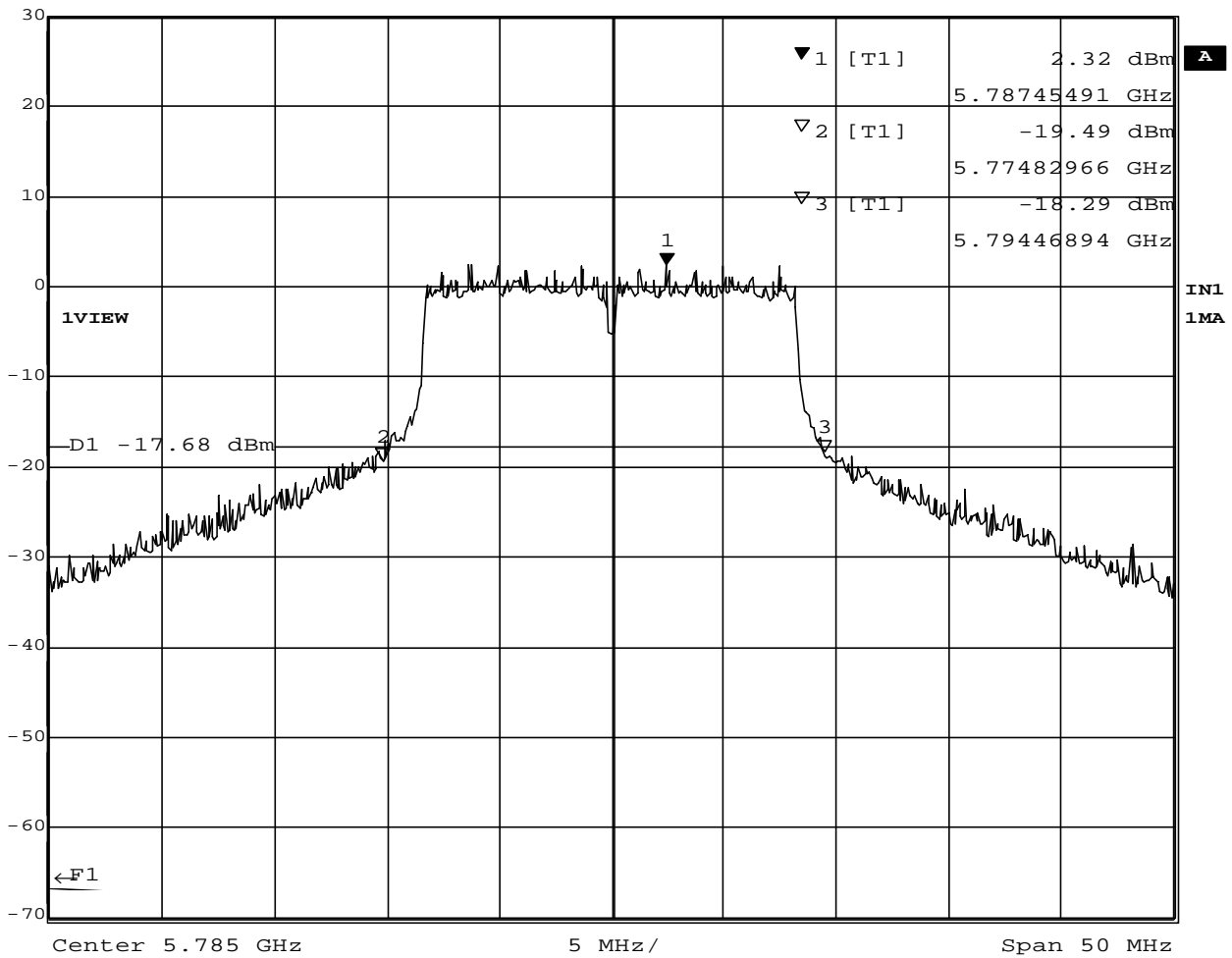

Date: 16.DEC.2002 17:52:48

Plot 2-5. 20dB BW at 5785MHz



Marker 1 [T1] RBW 100 kHz RF Att 40 dB
 Ref Lvl 2.68 dBm VBW 100 kHz
 30 dBm 5.81873747 GHz SWT 12.5 ms Unit dBm

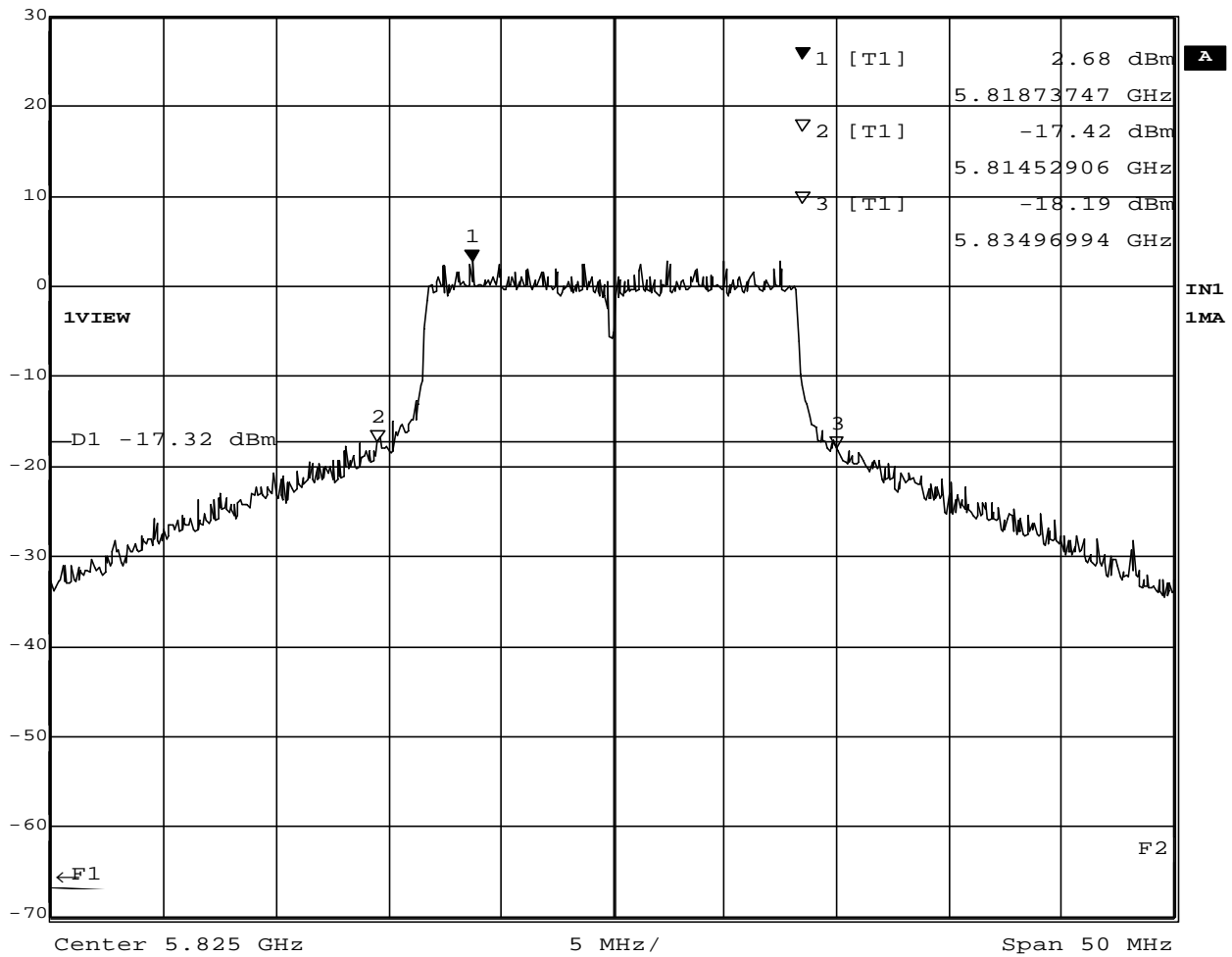

Date: 16.DEC.2002 17:57:20

Plot 2-6. 20dB BW at 5825MHz

2.6 Trace Data of Out of Band Emissions

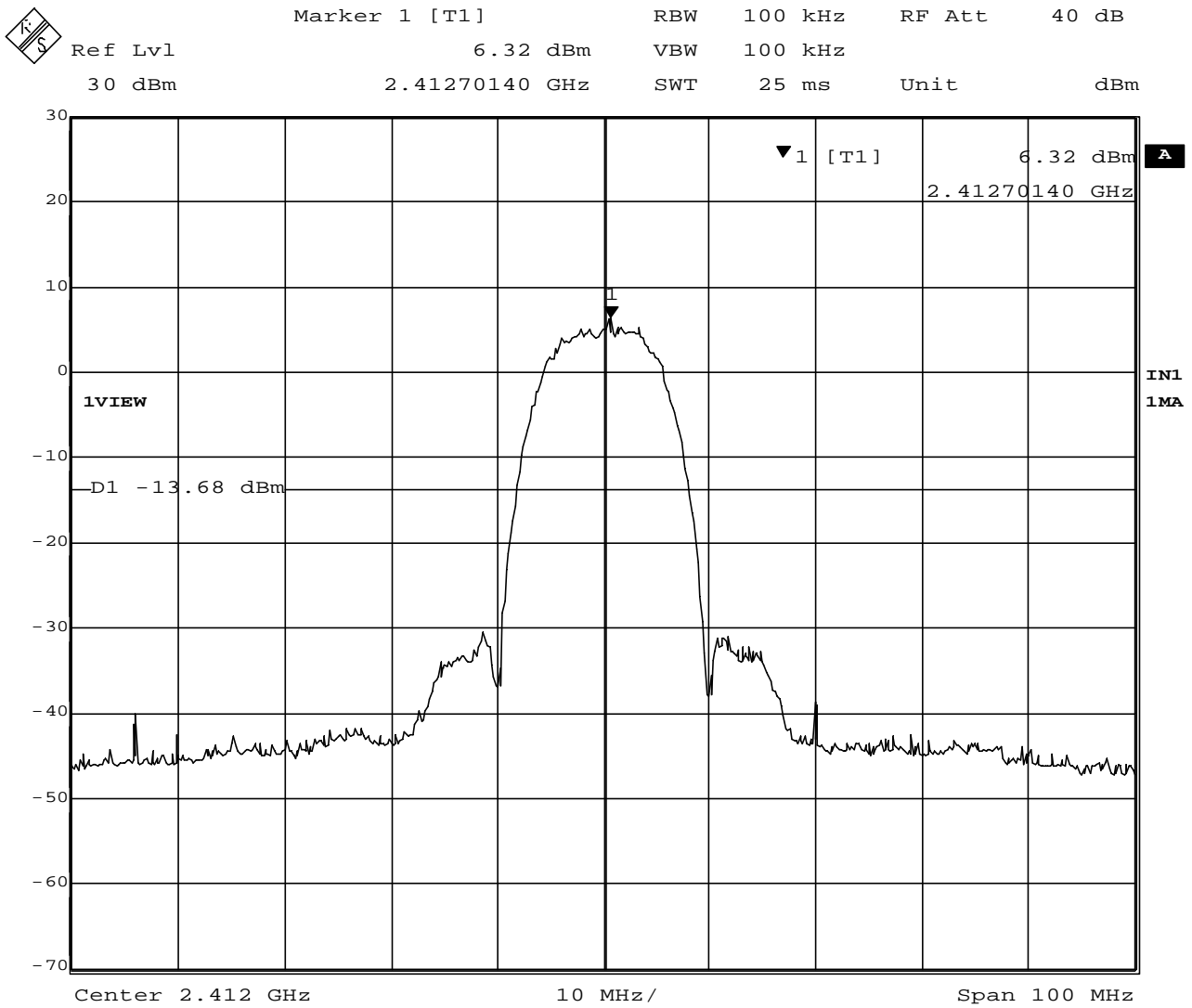

Date: 11.DEC.2002 20:13:09

Plot 2-7. Out of band emissions around 2412MHz



Ref Lvl	30 dBm	Marker 1 [T1]	2.43649900 GHz	RBW	100 kHz	RF Att	40 dB
				VBW	100 kHz		
				SWT	25 ms	Unit	dBm

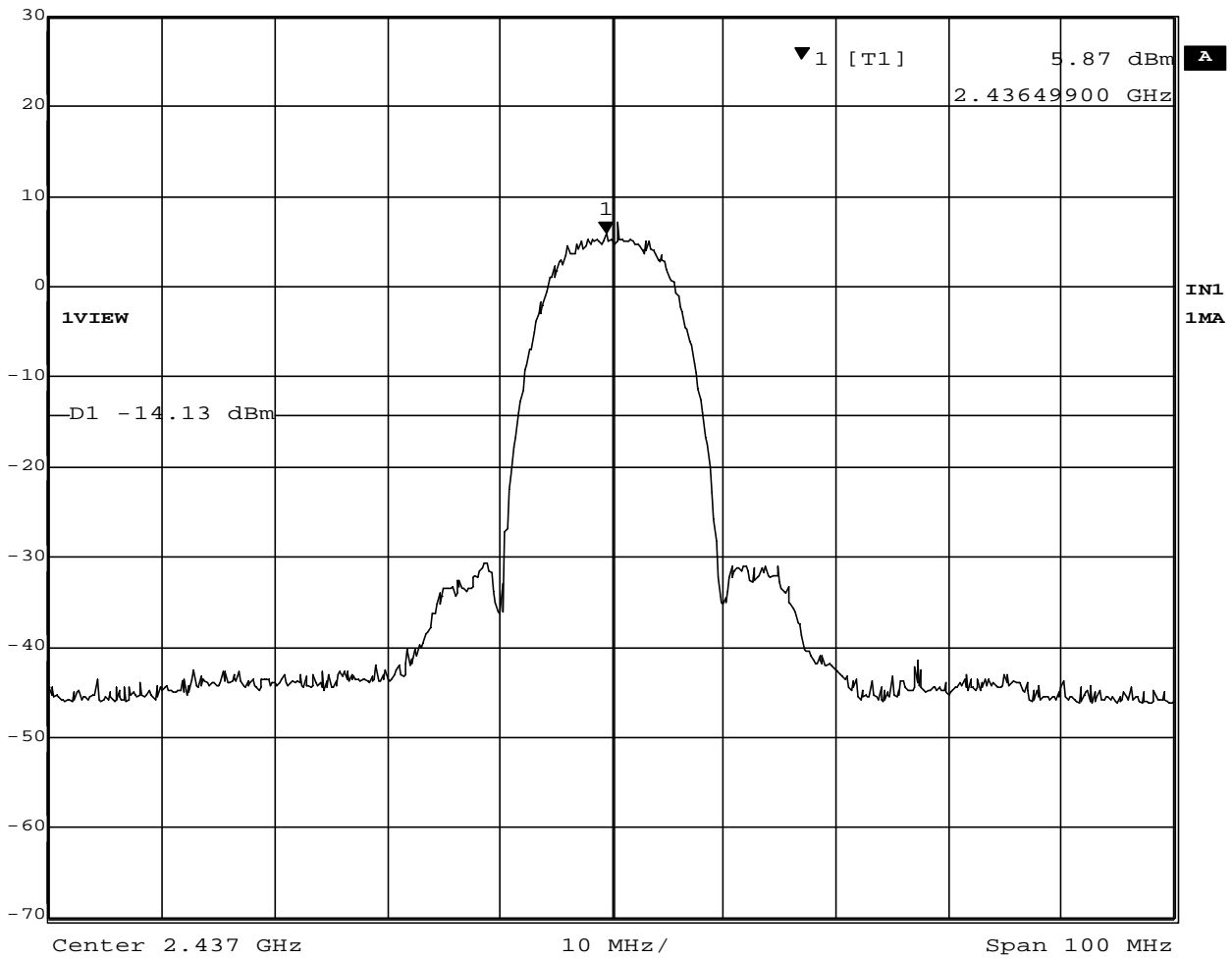

Date: 11.DEC.2002 20:15:10

Plot 2-8. Out of band emissions around 2437MHz



Marker 1 [T1] RBW 100 kHz RF Att 40 dB
Ref Lvl 6.91 dBm VBW 100 kHz
30 dBm 2.46250100 GHz SWT 25 ms Unit dBm

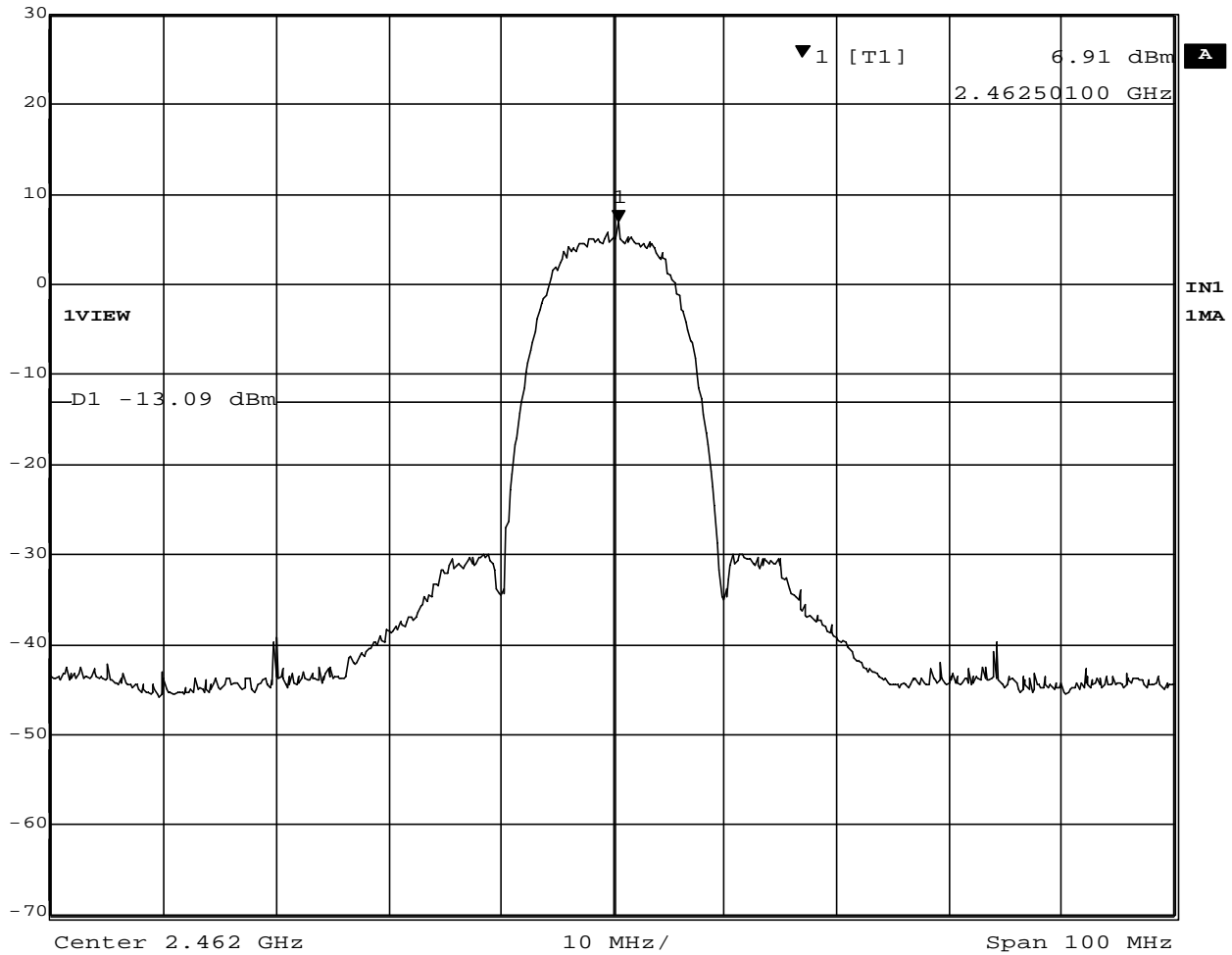

Date: 11.DEC.2002 20:17:15

Plot 2-9. Out of band emissions around 2462MHz



Marker 1 [T1] RBW 100 kHz RF Att 40 dB
Ref Lvl 2.07 dBm VBW 100 kHz
30 dBm 5.74750501 GHz SWT 25 ms Unit dBm

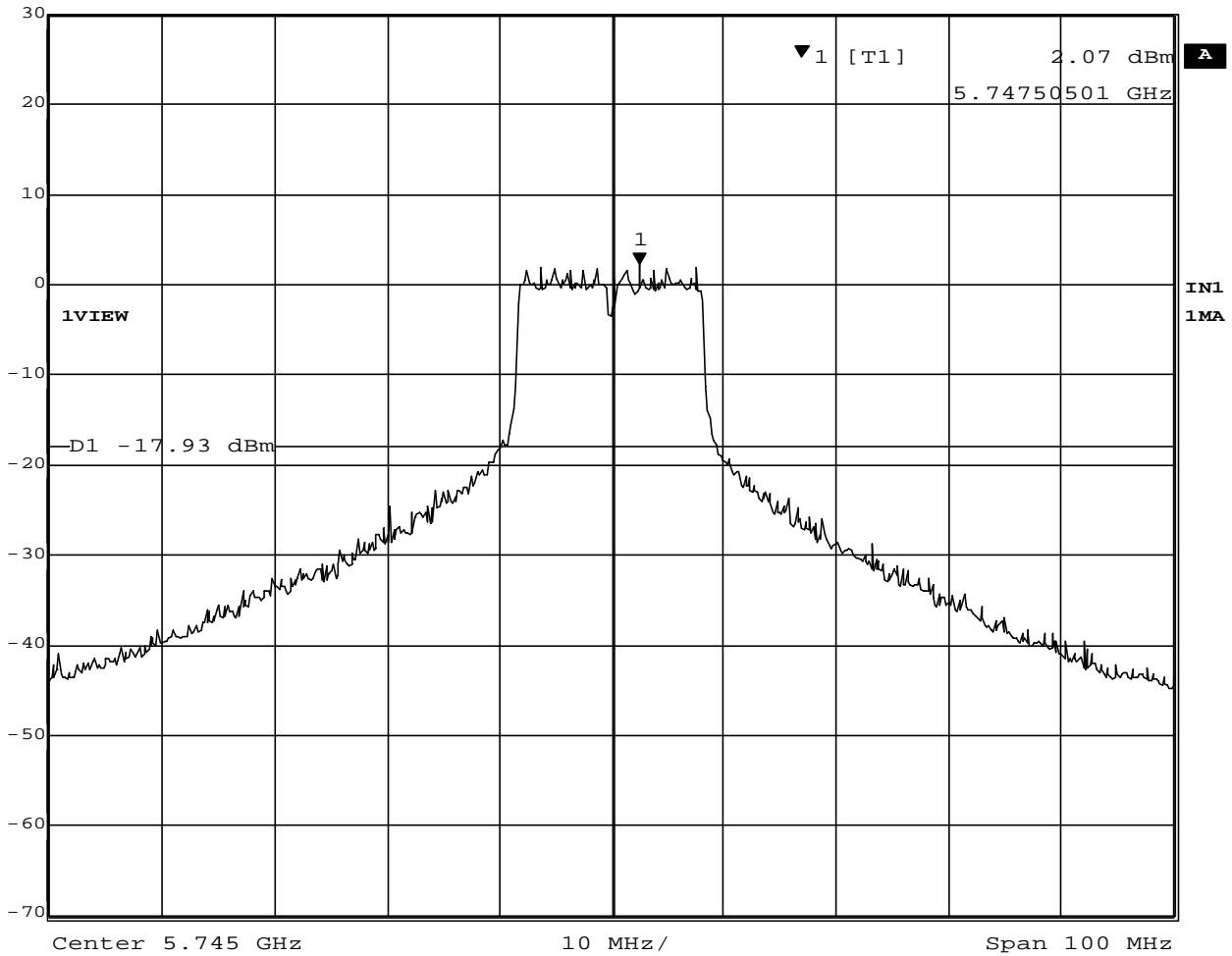

Date: 16.DEC.2002 17:59:04

Plot 2-10. Out of band emissions around 5745MHz



Marker 1 [T1] RBW 100 kHz RF Att 40 dB
Ref Lvl 2.49 dBm VBW 100 kHz
30 dBm 5.77868737 GHz SWT 25 ms Unit dBm

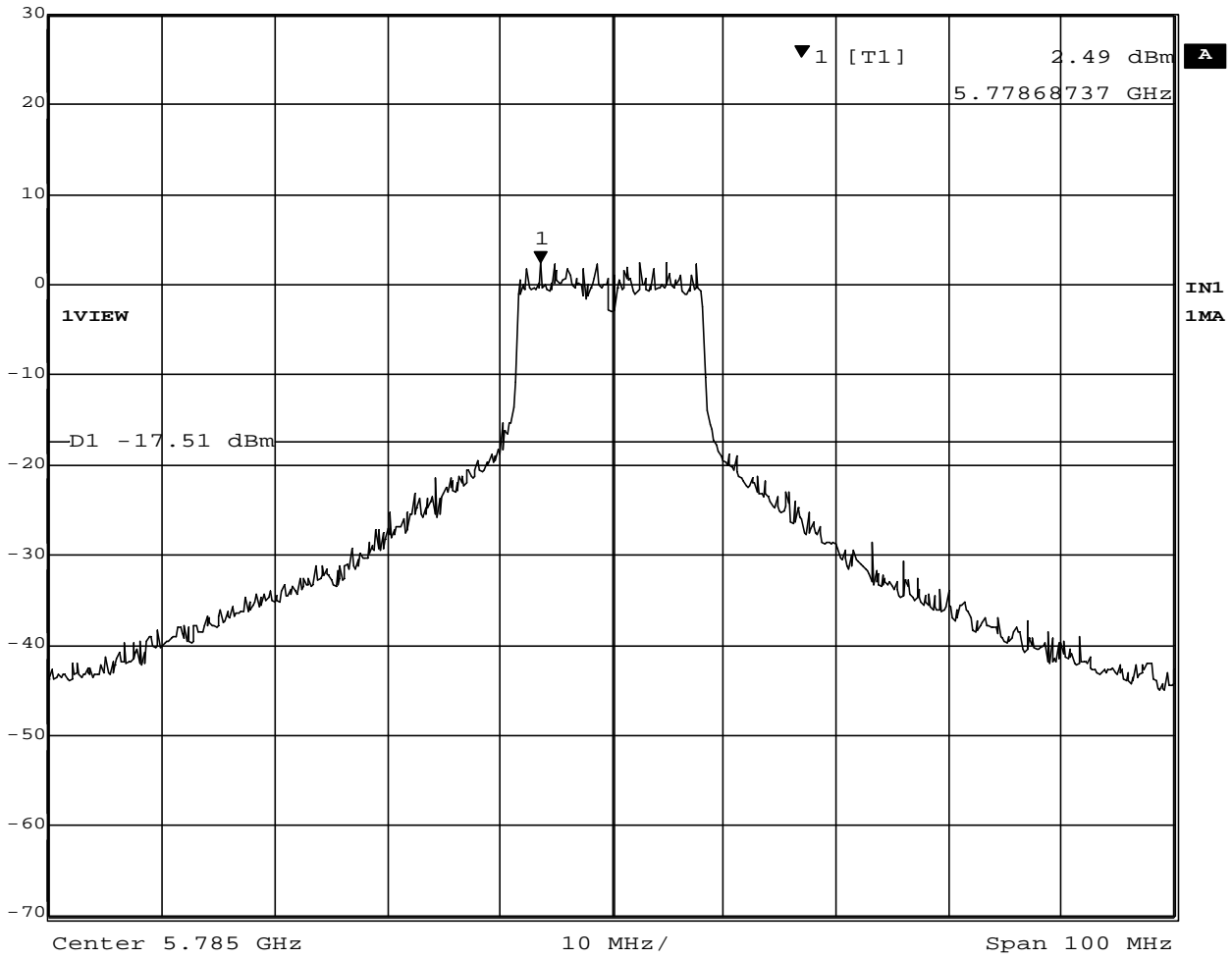

Date: 16.DEC.2002 18:00:39

Plot 2-11. Out of band emissions around 5785MHz



Marker 1 [T1] RBW 100 kHz RF Att 40 dB
Ref Lvl 2.41 dBm VBW 100 kHz
30 dBm 5.82750501 GHz SWT 25 ms Unit dBm

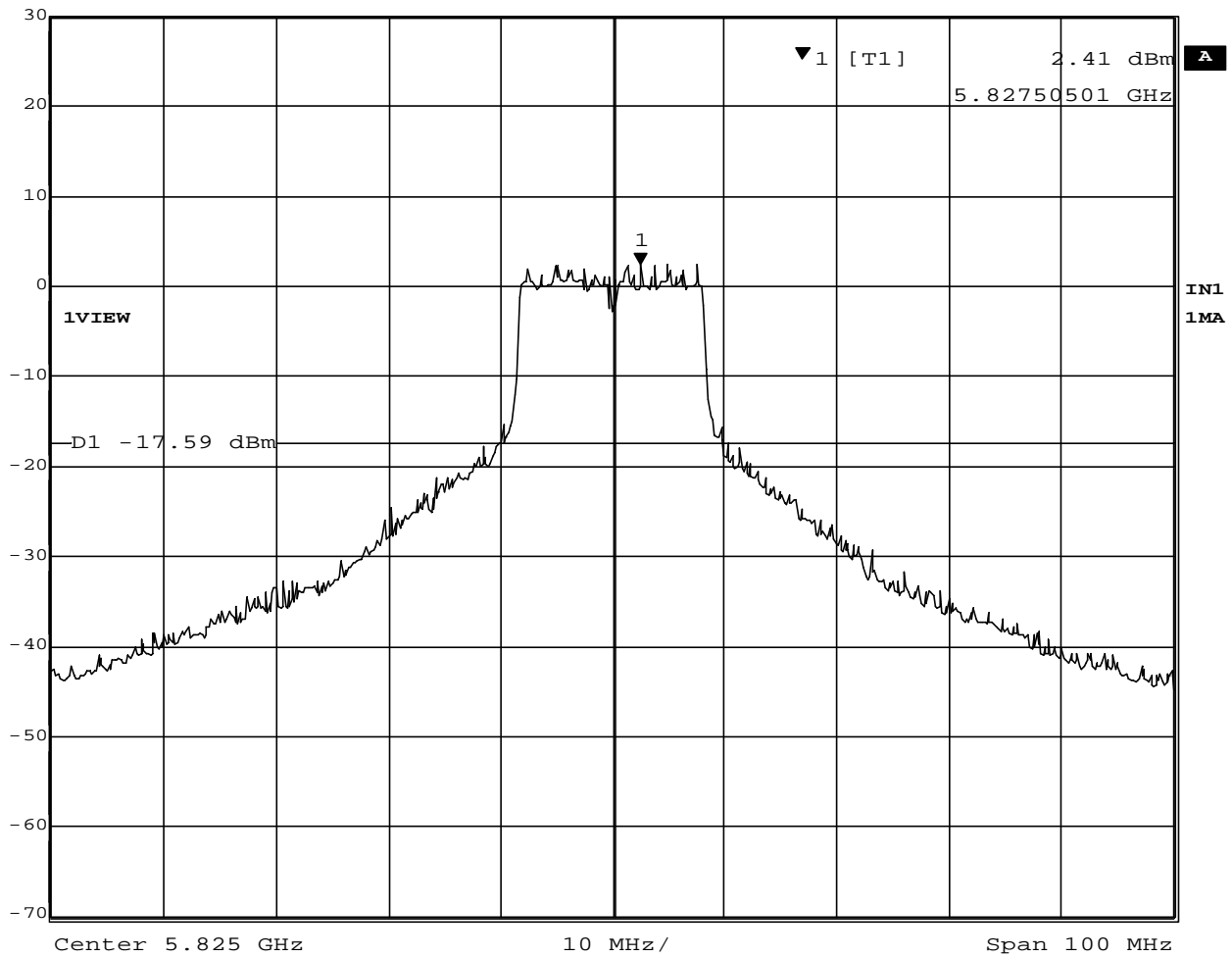

Date: 16.DEC.2002 18:01:46

Plot 2-12. Out of band emissions around 5825MHz

3. Conducted Peak Output Power

The test was performed with two kinds of measurement methods using power meter or spectrum analyzer.

3.1 Test Procedure

3.1.1 Power Meter measurement method

- A transmitter antenna terminal of EUT was connected to the input of a RF power sensor.
- Measurement was performed while EUT was operating in continuous transmission mode at the appropriate center frequencies. i.e. the lowest, middle, and highest frequencies of each 2.4GHz or 5.8GHz band.

Table 3-1 : Test Instruments of power meter method

Description	Model	Serial Number
Power Meter	HP 437B	3043U03437
Power Sensor	HP 8481A	US41030582
Coax cables: - Power Sensor <=> EUT	Length: 20 cm	Loss: 0.7dB (for 2.4GHz) 1.3dB (for 5.8GHz)

Notes: - HP: Hewlett Packard

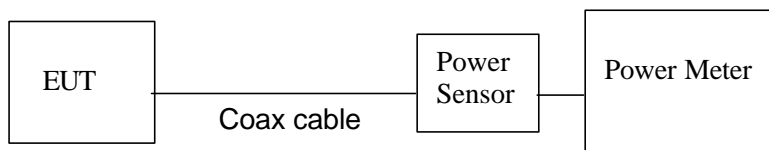

Figure 3-1: Measurement setup of power meter method

3.1.2 Spectrum Analyzer measurement method

The spectrum analyzer was connected to the antenna terminal, while EUT was operating in continuous transmission mode (shown in the Chapter C) at the appropriate center frequencies.

The spectrum analyzer was set to :

VBW= 30kHz, RBW=1MHz,

Span=30-40MHz encompassing the entire 6 dB emission bandwidth of the transmission signal,

Mode= sample detector, Trigger= free run

The band power measurement function was used to measure the peak power of each transmission mode selected by the step 3.1.1. The analyzer computed the peak power by integrating the spectrum across the 6 dB emission bandwidth given by the previous chapter.

The test instruments and setup configuration are the same as the Table 1-1 and Figure 1.

3.2 Measurement Results

Test Date: November 18, December 16 and 24, 2002

Table 3-2-1. Power meter measurement results (EUT: M/T 2672-CHU, s/n ZZ-00094)

Operation Frequency [GHz]	Rated output power (conducted) [dBm]									
	1 / 2M bps	5.5/11M bps	6M bps	9M bps	12M bps	18M bps	24M bps	36M bps	48M bps	54M bps
2.412 (Aux)	16.2	16.2	NA							
Specification	17									
2.437 (Aux)	16.1	16.1	N/A							
Specification	17									
2.462 (Aux)	16.1	16.2	N/A							
Specification	17									
5.745 (Main)	N/A		15.2	-	-	-	15.2	14.0	11.8	9.3
Specification	N/A		16				15	12	10	
5.785 (Main)	N/A		15.1	-	-	-	15.2	14.3	11.4	9.7
Specification	N/A		16				15	12	10	
5.825 (Main)	N/A		15.1	-	-	-	15.1	14.3	11.1	9.6
specification	N/A		16				15	12	10	

[Calculation table]

Measured Frequency (MHz)	Power Meter Reading (dBm)	Cable Loss (dB)	Results (dBm)	Limit		Peak antenna gain of EUT (dBi)	EIRP (dBm)	IC limit (dBm)
				FCC (dBm)	IC (dBm)			
2412	16.2	0.7	16.9	30	30	-	-	N/A
2437	16.1	0.7	16.8					
2462	16.2	0.7	16.9					
5745	15.2	1.3	16.5	30	30	0.32	16.8	36
5785	15.2	1.3	16.5					
5825	15.1	1.3	16.4					

Table 3-2-2. Spectrum analyzer measurement results (EUT: M/T 2672-CHU, s/n ZZ-00094)

Measured Frequency (MHz)	Analyzer reading (dBm)	Trace number	Cable Loss (dB)	Results (dBm)	Limit		Peak antenna gain of EUT (dBi)	EIRP (dBm)	IC limit (dBm)
					FCC (dBm)	IC (dBm)			
2412	15.79	Plot 3-1	1.3	17.1	30	30	-	-	N/A
2437	15.73	Plot 3-2	1.3	17.0					
2462	15.75	Plot 3-3	1.3	17.1					
5745	14.35	Plot 3-4	2.3	16.7	30	30	0.32	17.0	36
5785	14.31	Plot 3-5	2.3	16.6					
5825	14.33	Plot 3-6	2.3	16.6					

3.4 Trace Data of Conducted Peak Output Power

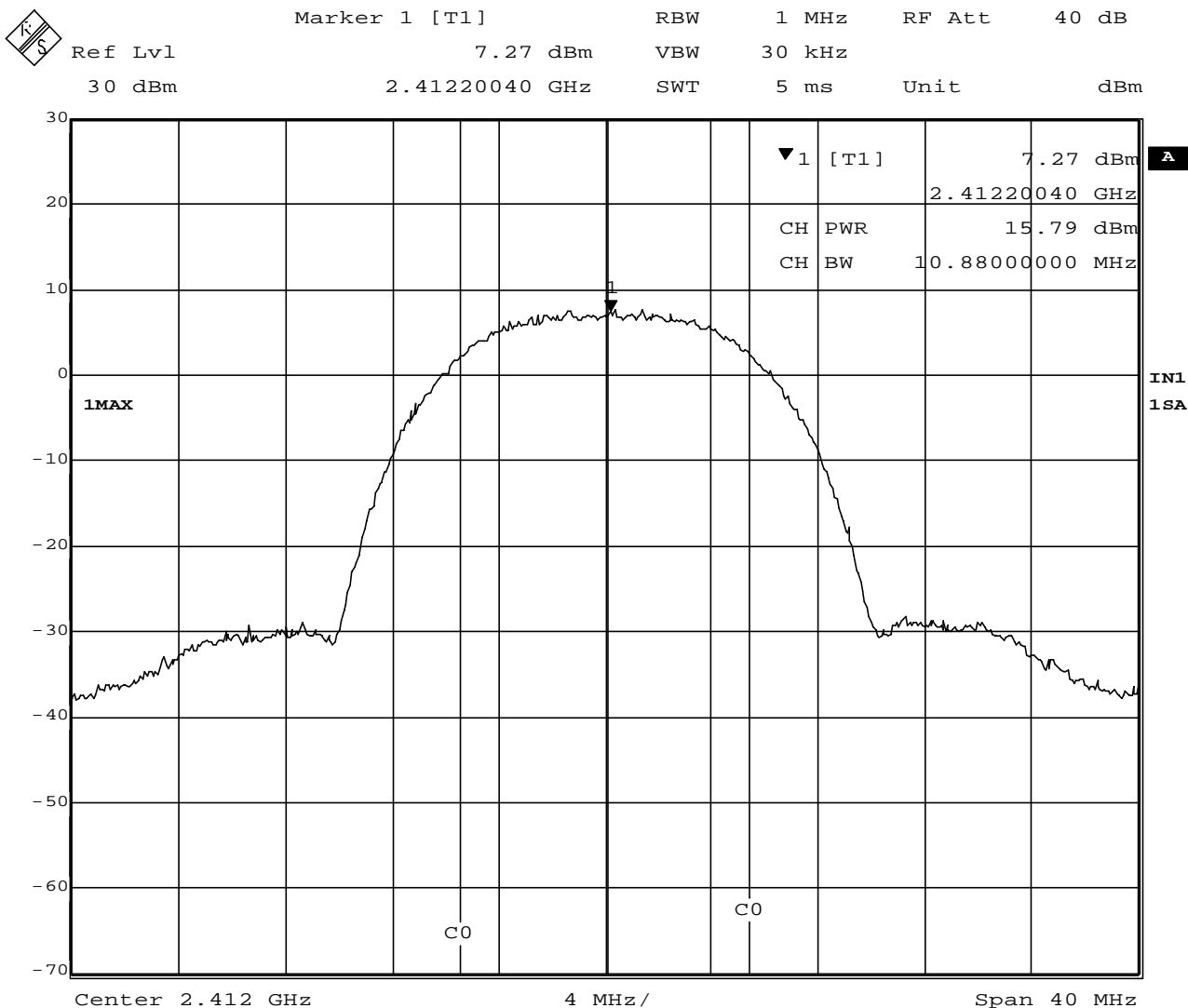

Date: 24.DEC.2002 10:22:09

Plot 3-1. Conducted Peak Output Power of 2412MHz



Ref Lvl	30 dBm	Marker 1 [T1]	2.43607816 GHz	RBW	1 MHz	RF Att	40 dB
				VBW	30 kHz		
				SWT	5 ms	Unit	dBm

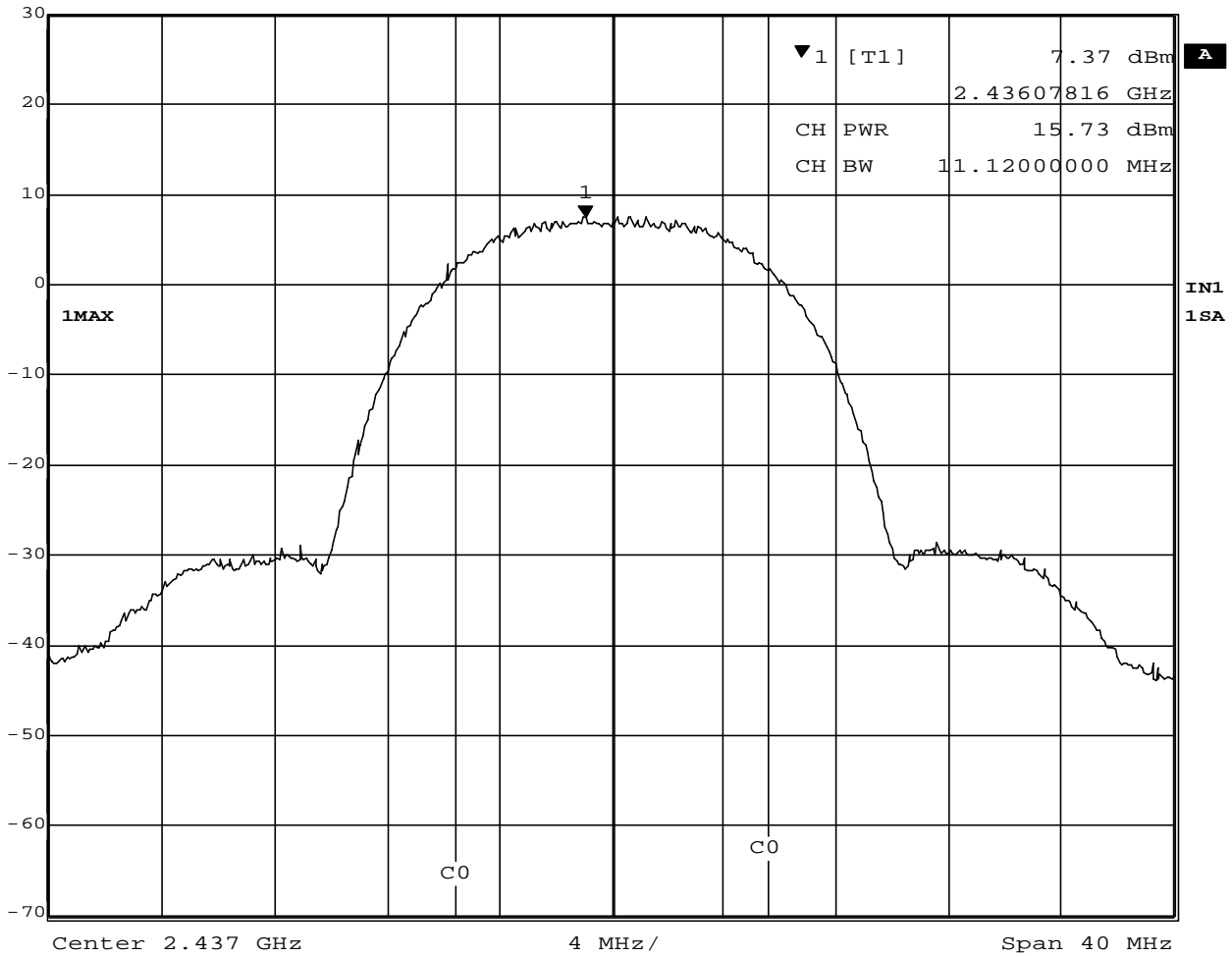

Date: 24.DEC.2002 10:24:30

Plot 3-2. Conducted Peak Output Power of 2437MHz



Ref Lvl	30 dBm	Marker 1 [T1]	2.46179960 GHz	RBW	1 MHz	RF Att	40 dB
				VBW	30 kHz		
				SWT	5 ms	Unit	dBm

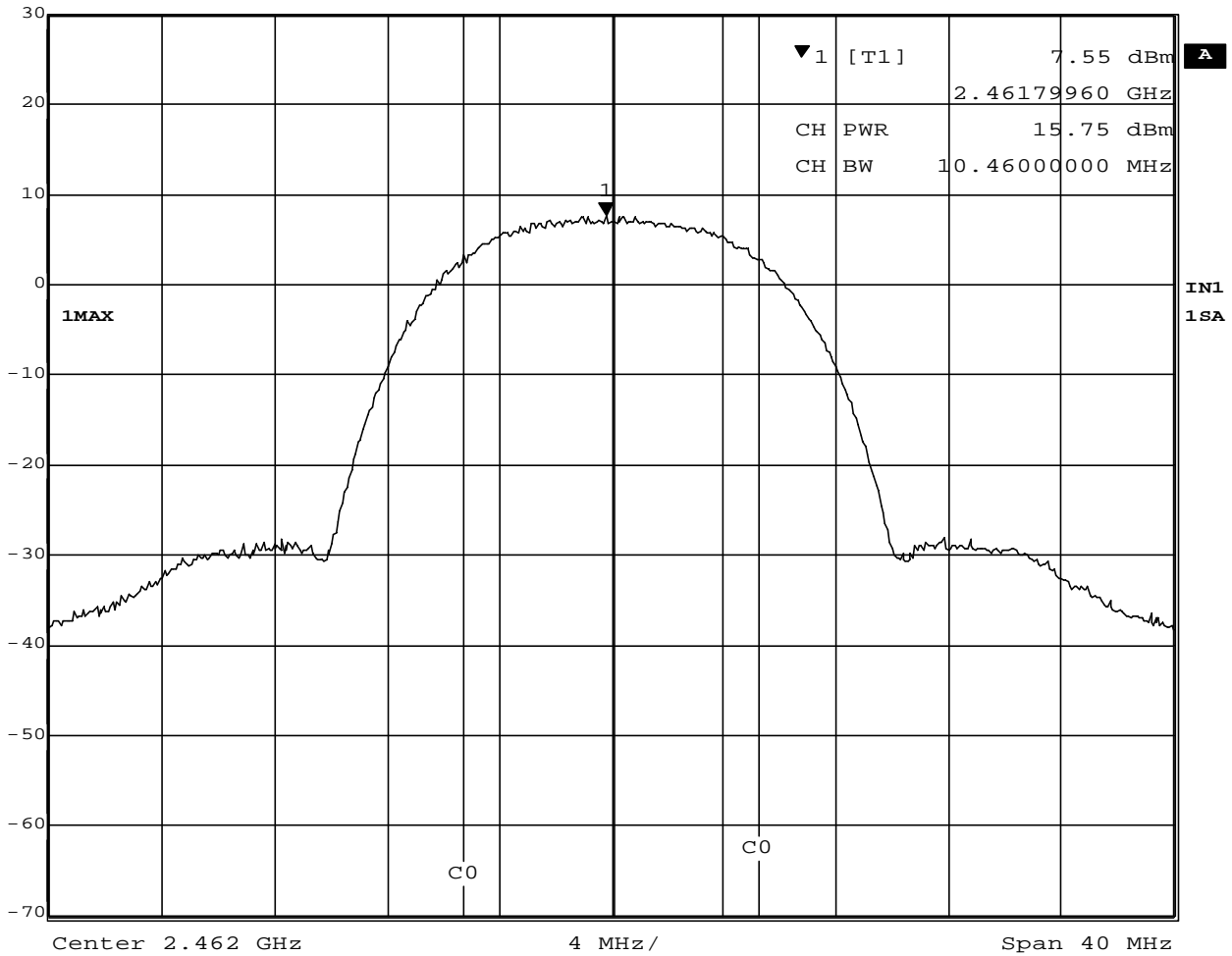

Date: 24.DEC.2002 10:26:11

Plot 3-3. Conducted Peak Output Power of 2462MHz



Ref Lvl	30 dBm	Marker 1 [T1]	3.56 dBm	RBW	1 MHz	RF Att	40 dB
			5.73942886 GHz	VBW	30 kHz		
				SWT	5 ms	Unit	dBm

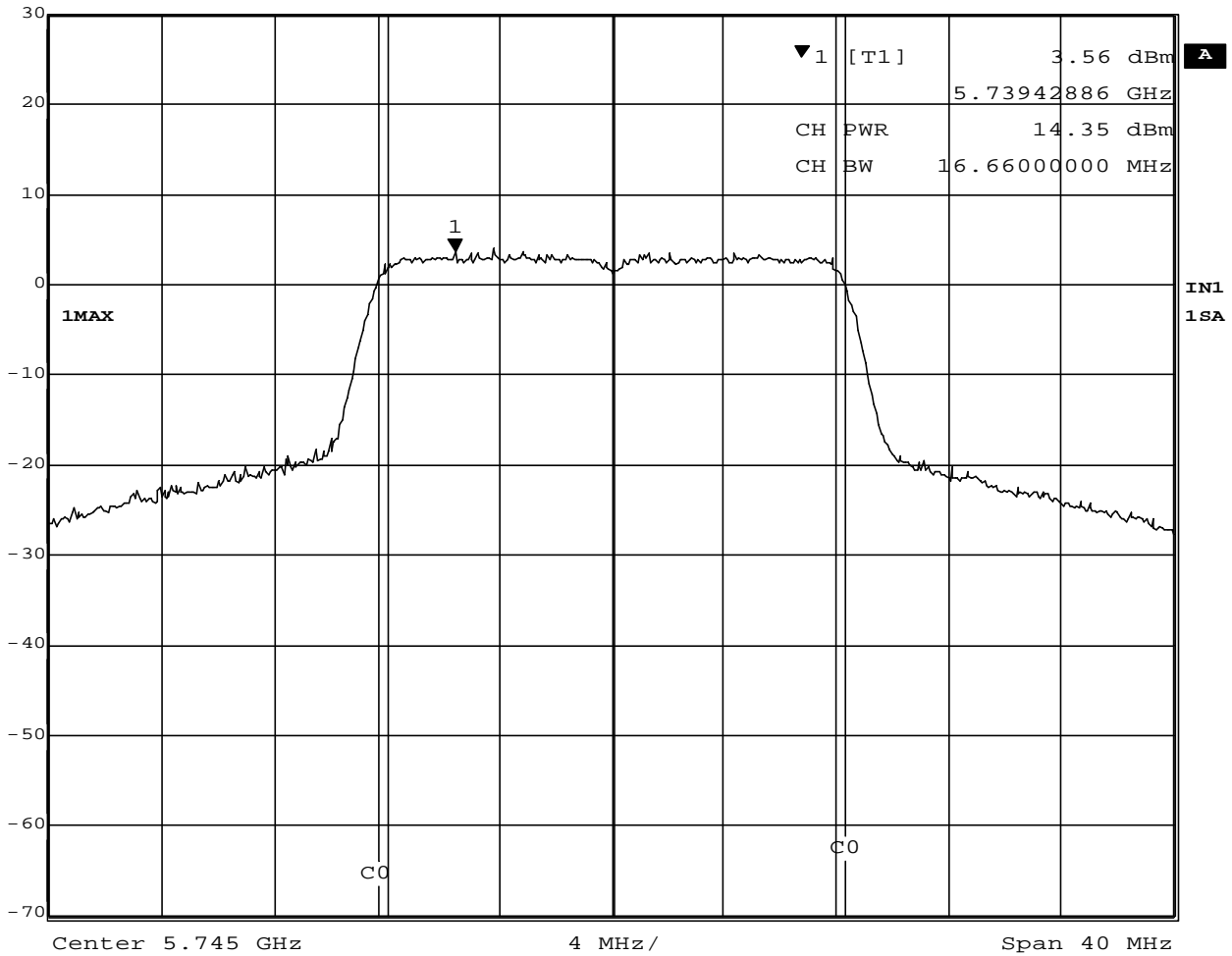

Date: 16.DEC.2002 18:05:06

Plot 3-4. Conducted Peak Output Power of 5745MHz



Ref Lvl	30 dBm	Marker 1 [T1]	3.38 dBm	RBW	1 MHz	RF Att	40 dB
			5.78279559 GHz	VBW	30 kHz		
				SWT	5 ms	Unit	dBm

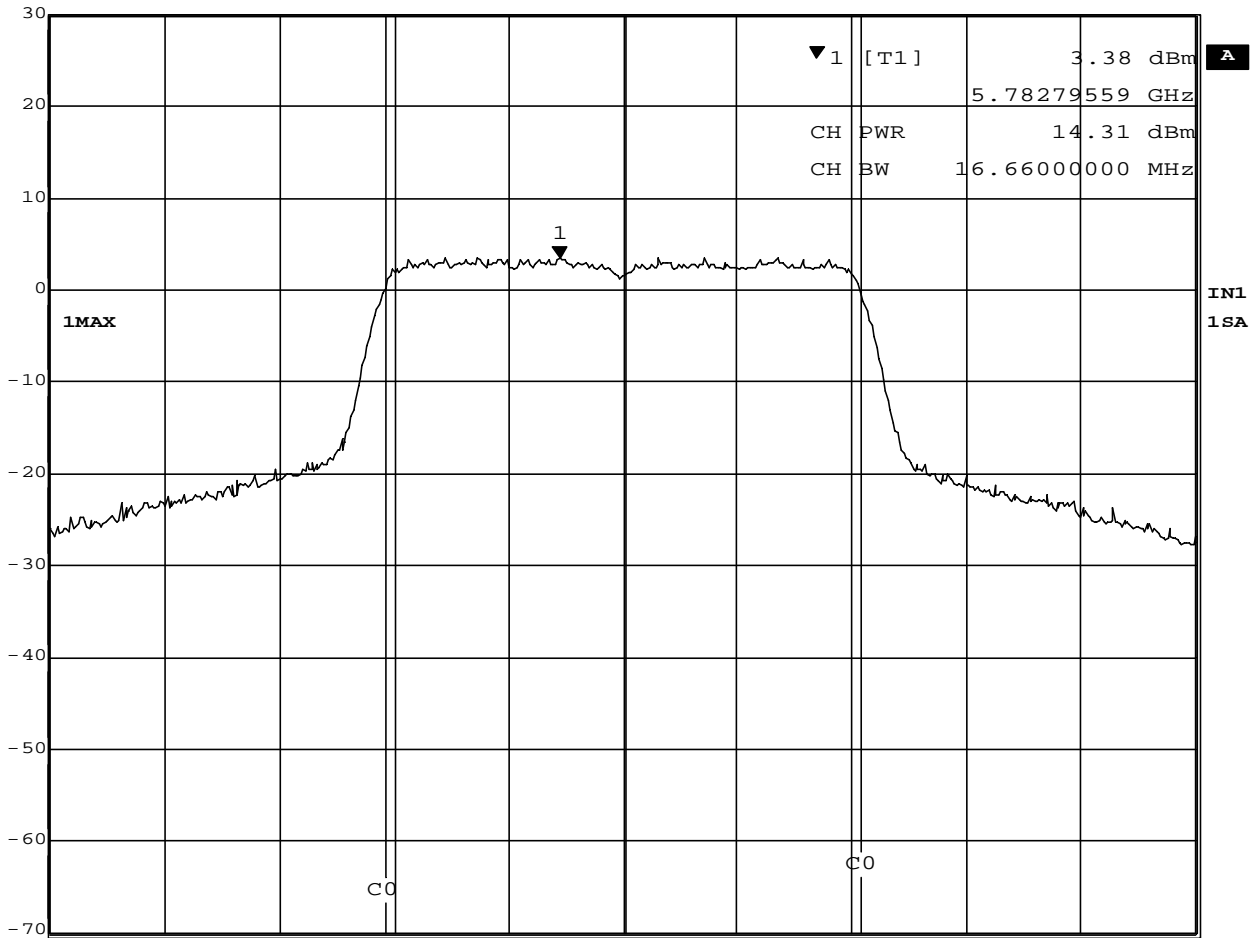

Center 5.785 GHz 4 MHz/ Span 40 MHz

Date: 16.DEC.2002 18:11:44

Plot 3-5. Conducted Peak Output Power of 5785MHz



Ref Lvl	30 dBm	Marker 1 [T1]	3.54 dBm	RBW	1 MHz	RF Att	40 dB
			5.81806613 GHz	VBW	30 kHz		
				SWT	5 ms	Unit	dBm

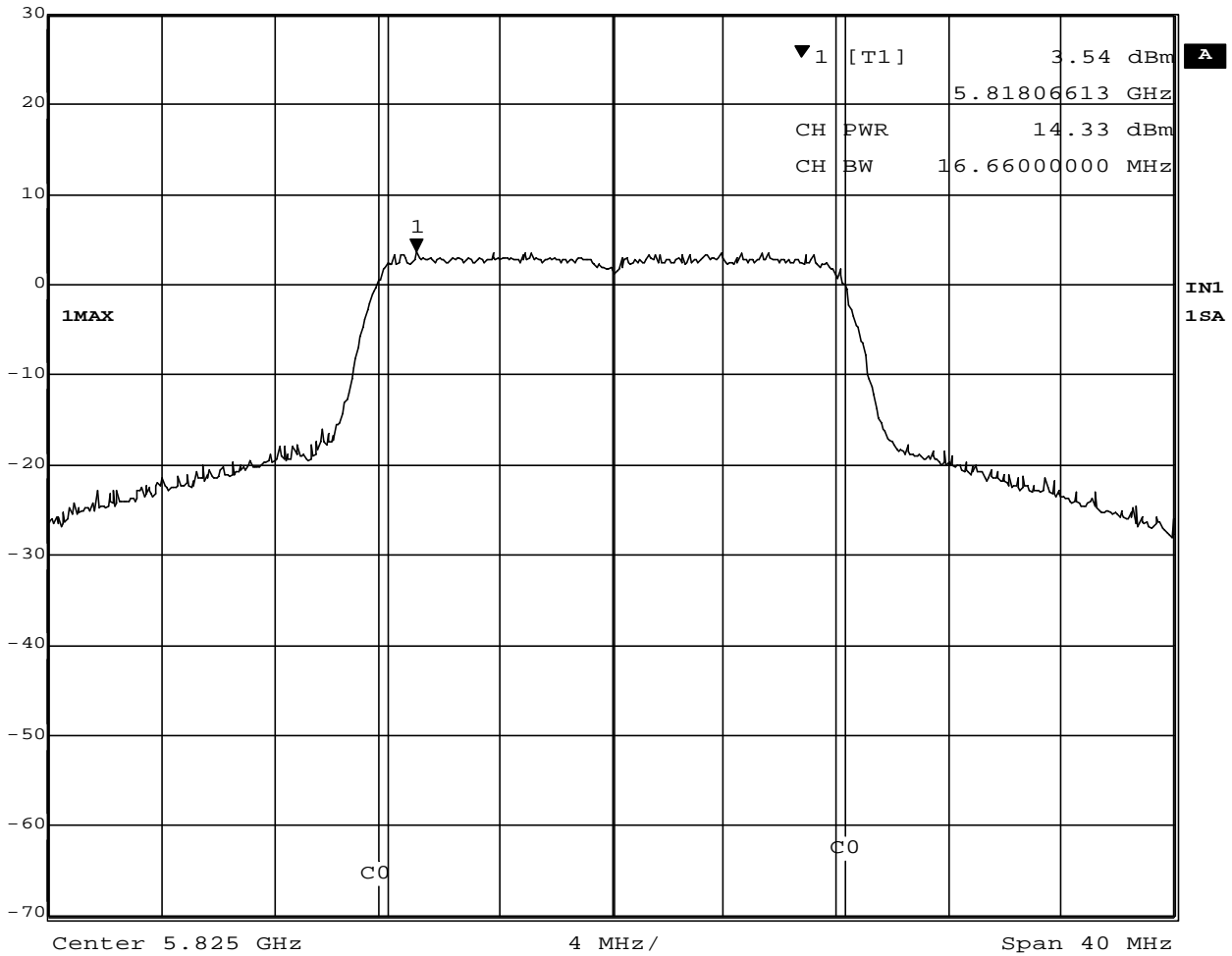

Date: 16.DEC.2002 18:14:26

Plot 3-6. Conducted Peak Output Power of 5825MHz

4. Peak Power Spectral Density

4.1 Test Procedure

The peak power density is measured with a spectrum analyzer connected to the antenna terminal, while EUT is operating in transmission mode at the appropriate center frequencies of each 2.4GHz or 5.8GHz band.

The spectrum analyzer is set to:

RBW= 3kHz, VBW=100kHz, Span=10MHz(for 2.4GHz band) or 20MHz(for 5.8GHz band), Sweep=2.8 seconds

4.2 Test Instruments and Measurement Setup

Same as the Chapter 1(Table 1-1 & Figure 1).

4.3 Measurement Results

Test Date: December 11 and 16, 2002

Table 4-1. EUT: M/T 2672-CHU, s/n ZZ-00094 , TX mode

Ch No.	Frequency (MHz)	Analyzer Reading (dBm)	Trace number	Cable loss (dB)	Result (dBm)	Limit (dBm)	Margin (dB)
1	2411.33	-6.81	Plot 4-1	1.3	- 5.5	8.0	13.5
6	2437.43	-5.20	Plot 4-2	1.3	- 3.9	8.0	11.9
11	2459.83	-6.41	Plot 4-3	1.3	- 5.1	8.0	13.1
149	5748.71	-11.45	Plot 4-4	2.3	- 9.2	8.0	17.2
157	5786.22	-11.39	Plot 4-5	2.3	- 9.1	8.0	17.1
165	5822.17	-11.05	Plot 4-6	2.3	- 8.8	8.0	16.8

4.4 Trace Data of Peak Power Spectral Density

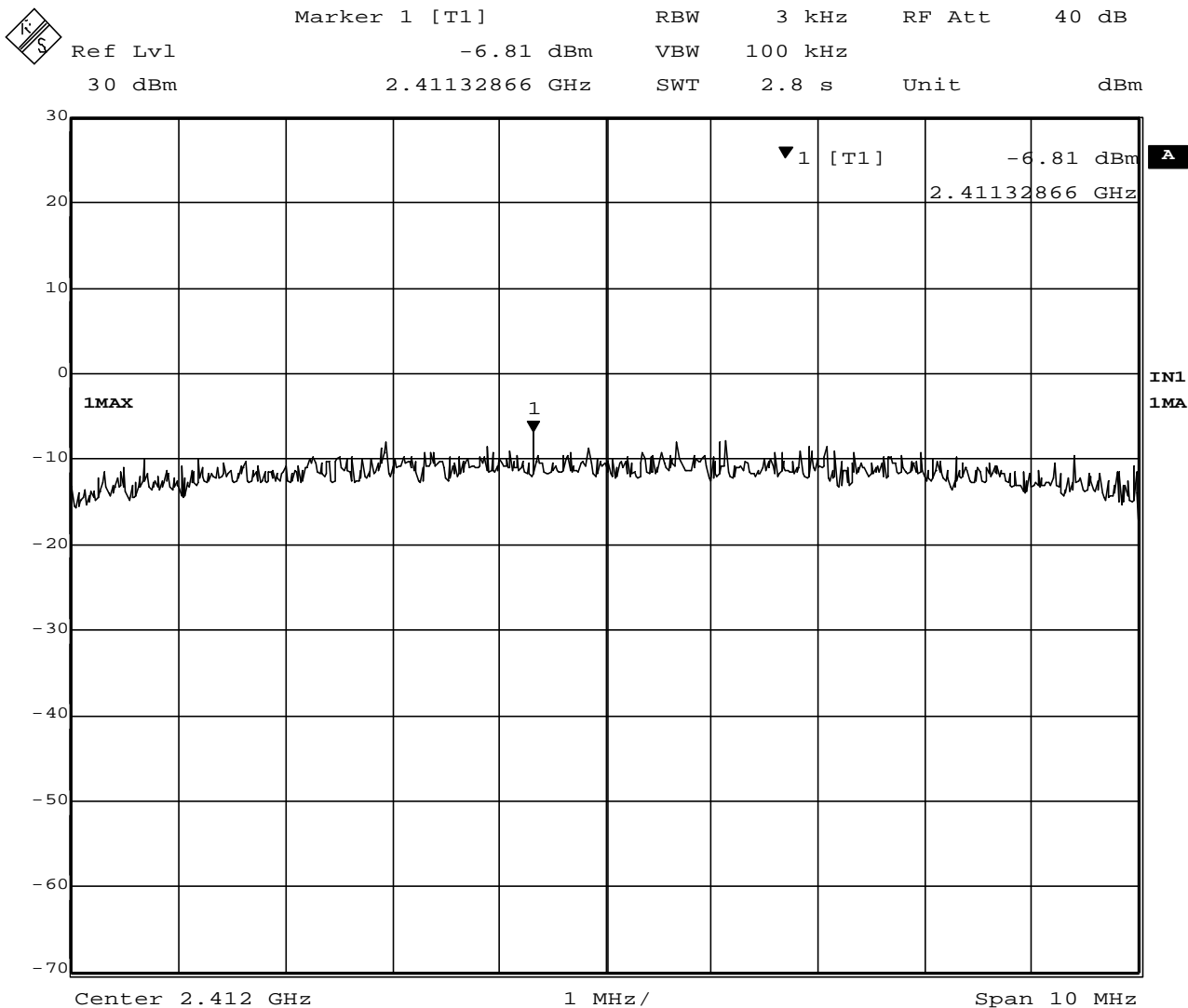

Date: 11.DEC.2002 20:28:35

Plot 4-1. Peak Power Spectral Density of 2412MHz



Marker 1 [T1] RBW 3 kHz RF Att 40 dB
Ref Lvl -5.20 dBm VBW 100 kHz
30 dBm 2.43743086 GHz SWT 2.8 s Unit dBm

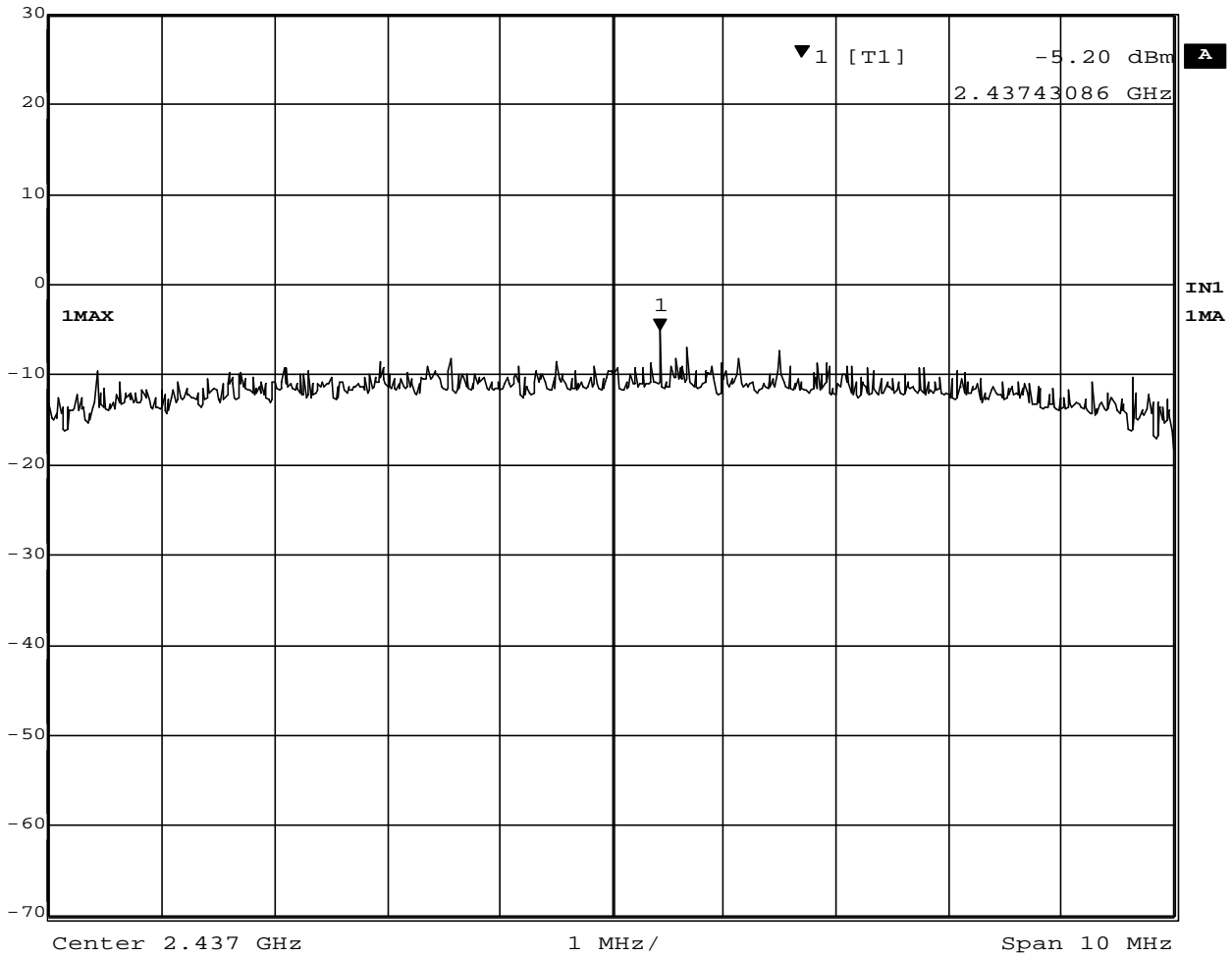

Date: 11.DEC.2002 20:30:01

Plot 4-2. Peak Power Spectral Density of 2437MHz



Ref Lvl	30 dBm	Marker 1 [T1]	2.45982565 GHz	RBW	3 kHz	RF Att	40 dB
				VBW	100 kHz		
				SWT	2.8 s	Unit	dBm

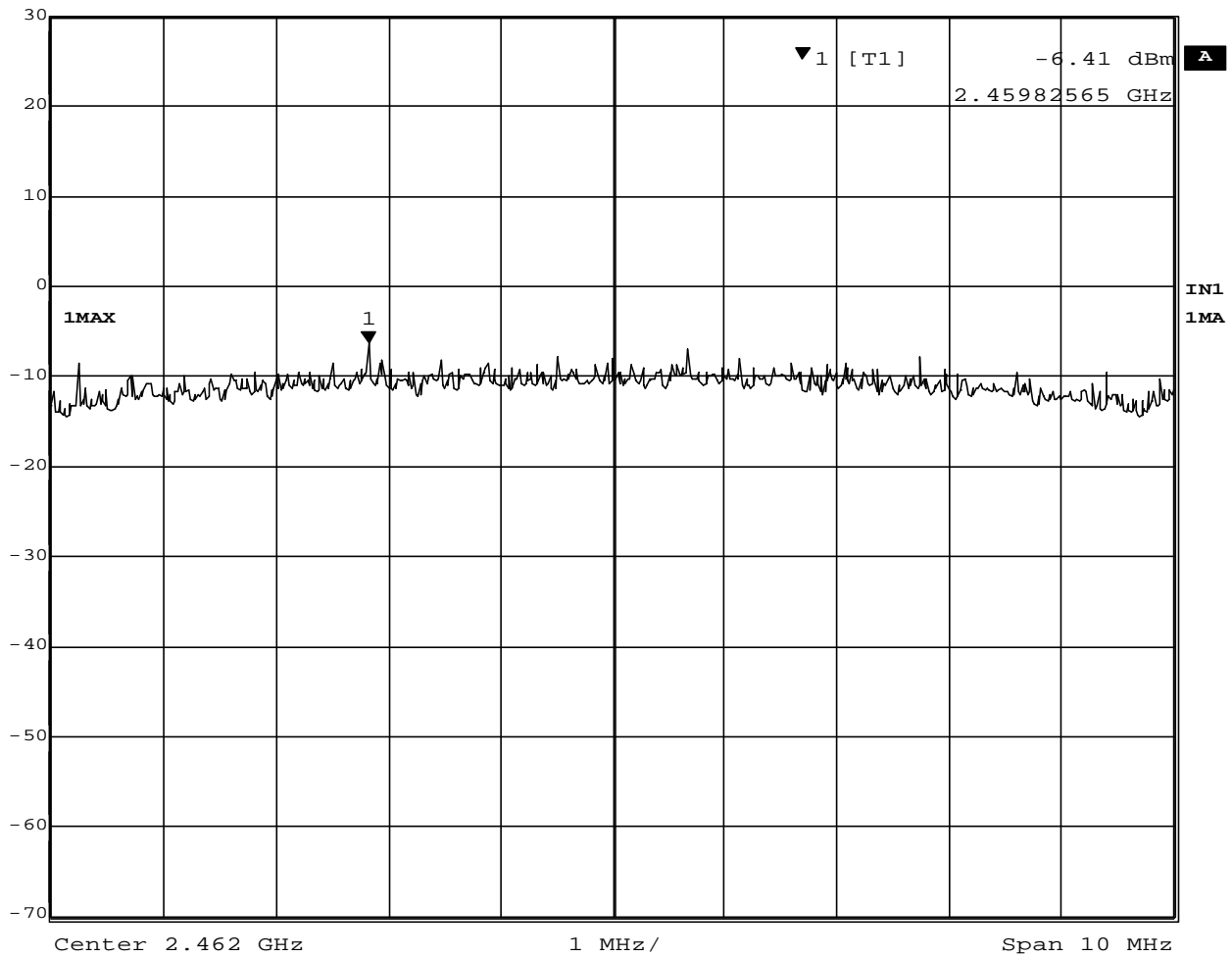

Date: 11.DEC.2002 20:31:52

Plot 4-3. Peak Power Spectral Density of 2462MHz



Marker 1 [T1]	RBW	3 kHz	RF Att	40 dB
Ref Lvl	-11.45 dBm	VBW	100 kHz	
30 dBm	5.74870741 GHz	SWT	5.6 s	Unit dBm

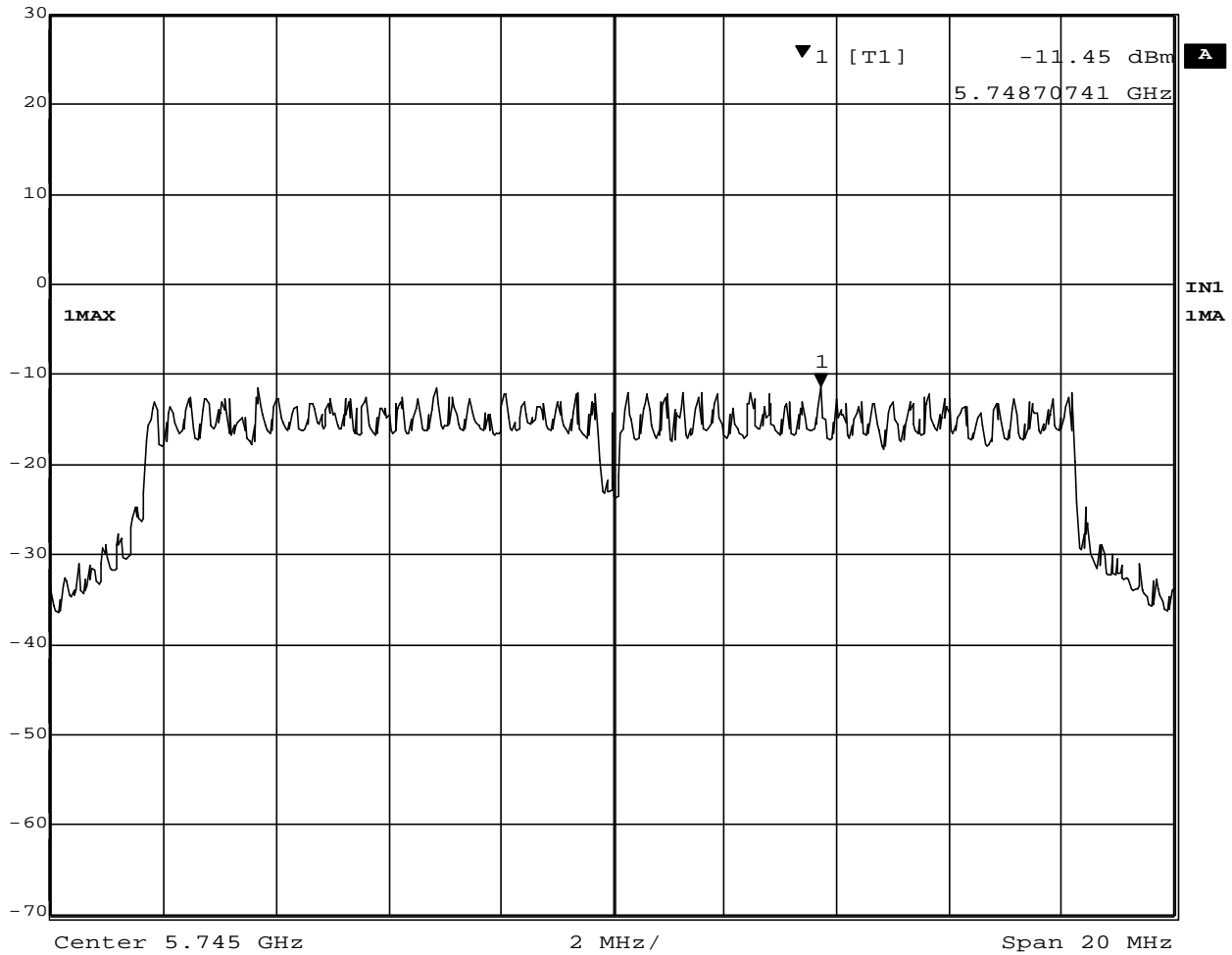

Date: 16.DEC.2002 18:21:13

Plot 4-4. Peak Power Spectral Density of 5745MHz



Ref Lvl	30 dBm	Marker 1 [T1]	5.78622244 GHz	RBW	3 kHz	RF Att	40 dB
				VBW	100 kHz		
				SWT	5.6 s	Unit	dBm

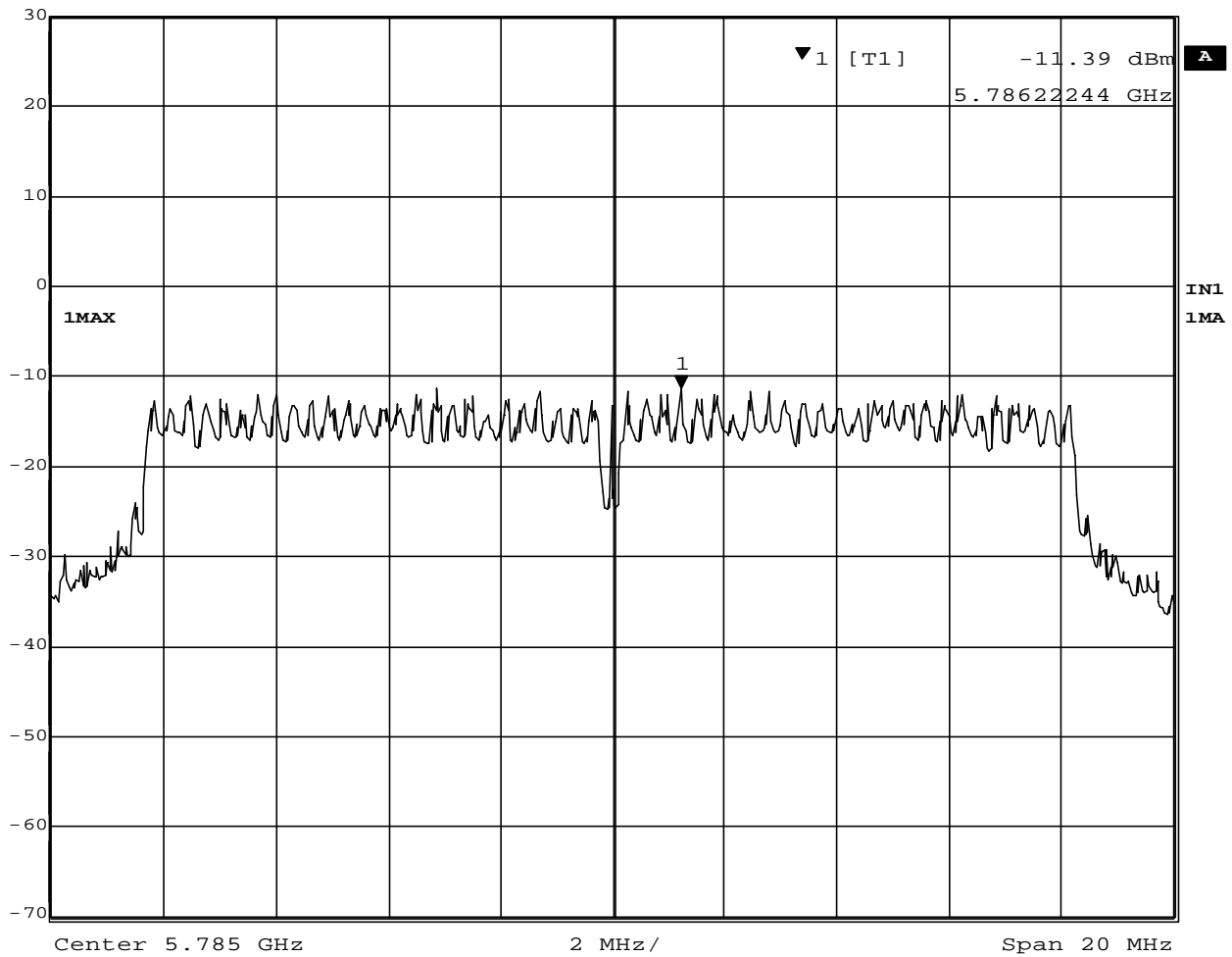

Date: 16.DEC.2002 18:22:04

Plot 4-5. Peak Power Spectral Density of 5785MHz



Marker 1 [T1] RBW 3 kHz RF Att 40 dB
Ref Lvl -11.05 dBm VBW 100 kHz
30 dBm 5.82217435 GHz SWT 5.6 s Unit dBm

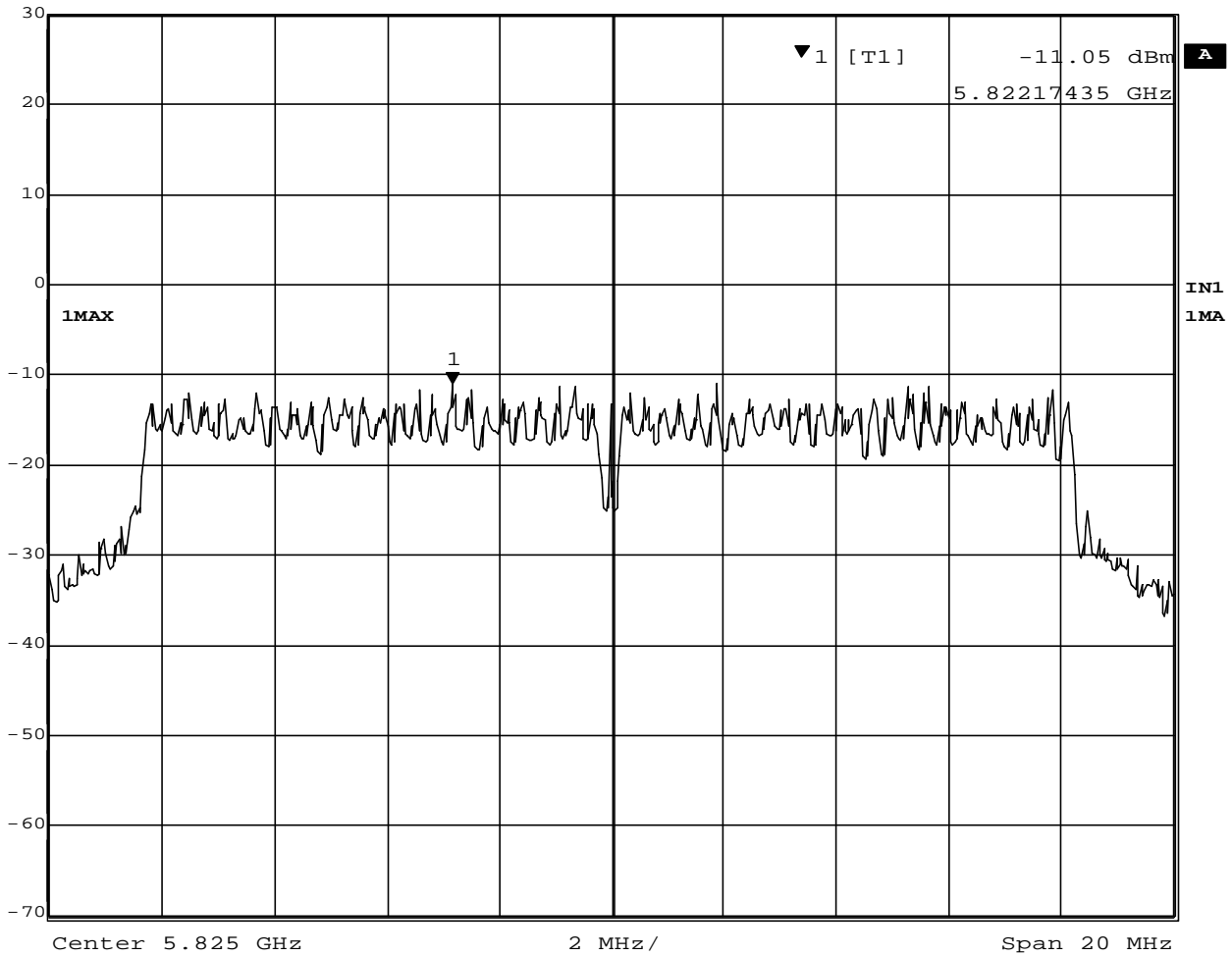

Date: 16.DEC.2002 18:23:48

Plot 4-6. Peak Power Spectral Density of 5825MHz

5. AC WIRELINE CONDUCTED EMISSIONS (150KHz – 30MHz) [FCC 15.207, RSS-210 6.6 / 7.4]

5.1 Test Procedure

The conducted emissions are measured in the IBM shielded room with a spectrum analyzer in peak hold. Emissions closest to the limit are measured in the quasi-peak mode (QP) with the tuned receiver using a bandwidth of 9KHz. The emissions are maximized further by cable manipulation. The highest emissions relative to the limit are listed.

5.2 Test Instruments and Measurement Setup

Table 5-1. Conducted Emission Test Instrumentation

Description	Model	Serial Number
Computer	IBM 6589-13J	97-15613
Spectrum Analyzer (100Hz-1.5GHz)	HP 85680B	2601A02634
Spectrum Analyzer Display	HP 85662A	2542A12308
Quasi-Peak Adapter	HP 85650A	2043A00062
Receiver (9kHz-30MHz)	R&S ESH3	891806/012
LISN	EMCO 3825/2	1426
Switch/control unit	HP 3488A	2719A17228
Plotter	HP 7550A	2631A33619
Coax cables: - Lisn-L <=> SW/Con.unit (SW100) - Lisn-N <=> SW/Con.unit (SW101) - SW/Con.unit <=> RCVR (Input) - SW/Con.unit<=> Spe Ana.(Signal In)	Length: 4 m 4 m 1 m 1 m	- EMIC-L - EMIC-N - EMIC-R - EMIC-S

Notes: - HP: Hewlett Packard, R&S: Rohde & Schwarz

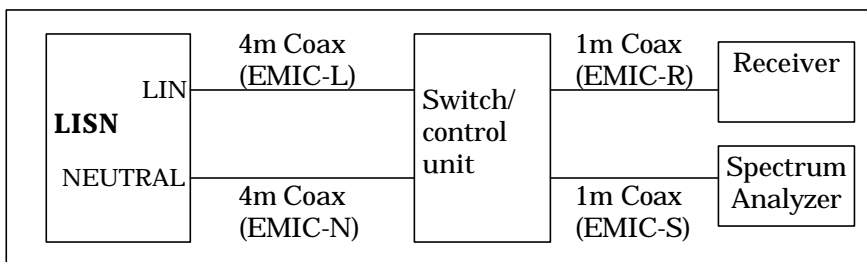

Figure 5. Cables for Conducted Emission Test

5.3 Measurement Results

The EUT was found to comply to the limits of FCC Part 15 Subpart C and RSS-210 with a margin of 16.3dB. The 6 highest emissions relative to the limits are reported.

Test Date: January 8, 2003

5.3.1 EUT in 2.4GHz IEEE802.11b transmission mode

Table 5-2-1. EUT: M/T 2672-CHU, s/n ZZ-00094, Ch.1(2412MHz) **TX** mode 11Mbps

Frequency (MHz)	Phase	QP Voltage (dB μ V)	CISPR22 QP Limit (dB μ V)	AV Voltage (dB μ V)	CISPR22 AV Limit (dB μ V)
0.2028	LINE	42.8	63.5	37.2	53.5
0.2713	LINE	34.7	61.1	30.4	51.1
0.3422	LINE	31.4	59.1	27.4	49.1
0.4131	LINE	24.8	57.6	21.1	47.6
0.4789	LINE	25.4	56.4	22.0	46.4
0.6202	LINE	21.8	56.0	17.5	46.0

Table 5-2-2. EUT: M/T 2672-CHU, s/n ZZ-00094 , Ch.6(2437MHz) **TX** mode 11Mbps

Frequency (MHz)	Phase	QP Voltage (dB μ V)	CISPR22 QP Limit (dB μ V)	AV Voltage (dB μ V)	CISPR22 AV Limit (dB μ V)
0.2017	LINE	38.2	63.5	33.1	53.5
0.2718	LINE	33.8	61.1	29.2	51.1
0.3427	LINE	30.0	59.1	26.1	49.1
0.4797	LINE	26.0	56.3	22.4	46.3
0.6162	LINE	22.7	56.0	18.7	46.0
24.9973	NEUTRAL	29.8	60.0	28.2	50.0

Table 5-2-3. EUT: M/T 2672-CHU, s/n ZZ-00094, Ch.11(2462MHz) **TX** mode 11Mbps

Frequency (MHz)	Phase	QP Voltage (dB μ V)	CISPR22 QP Limit (dB μ V)	AV Voltage (dB μ V)	CISPR22 AV Limit (dB μ V)
0.2028	LINE	39.4	63.5	34.3	53.5
0.2723	LINE	33.8	61.0	29.1	51.0
0.3407	LINE	29.3	59.2	25.5	49.2
0.4804	LINE	26.0	56.3	22.4	46.3
0.6159	LINE	22.8	56.0	18.8	46.0
6.5199	NEUTRAL	22.4	60.0	16.7	50.0

Table 5-2-4. EUT: M/T 2672-CHU, s/n ZZ-00094, Ch. 6 (2437MHz) **RX** mode

Frequency (MHz)	Phase	QP Voltage (dB μ V)	CISPR22 QP Limit (dB μ V)	AV Voltage (dB μ V)	CISPR22 AV Limit (dB μ V)
0.2028	LINE	39.5	63.5	34.4	53.5
0.2729	LINE	34.2	61.0	29.3	51.0
0.3415	LINE	29.8	59.2	25.9	49.2
0.4116	LINE	24.1	57.6	19.9	47.6
0.4799	LINE	25.9	56.3	22.4	46.3
0.6151	LINE	22.5	56.0	18.5	46.0

5.3.2 EUT in 5.8GHz IEEE802.11a transmission mode

Table 5-3-1. EUT: M/T 2672-CHU, s/n ZZ-00094, Ch.149(5745MHz) **TX** mode 24Mbps

Frequency (MHz)	Phase	QP Voltage (dB μ V)	CISPR22 QP Limit (dB μ V)	AV Voltage (dB μ V)	CISPR22 AV Limit (dB μ V)
0.2035	NEUTRAL	42.5	63.5	37.2	53.5
0.2747	LINE	36.5	61.0	31.5	51.0
0.3422	NEUTRAL	30.5	59.2	26.5	49.2
0.4104	NEUTRAL	24.4	57.6	20.8	47.6
0.4799	NEUTRAL	25.8	56.3	22.3	46.3
1.9915	NEUTRAL	20.5	56.0	17.5	46.0

Table 5-3-2 EUT: M/T 2672-CHU, s/n ZZ-00094, Ch.157(5785MHz) **TX** mode 24Mbps

Frequency (MHz)	Phase	QP Voltage (dB μ V)	CISPR22 QP Limit (dB μ V)	AV Voltage (dB μ V)	CISPR22 AV Limit (dB μ V)
0.2081	LINE	40.1	63.3	34.6	53.3
0.2738	NEUTRAL	34.8	61.0	30.0	51.0
0.3415	NEUTRAL	29.4	59.2	25.6	49.2
0.4117	LINE	23.1	57.6	20.1	47.6
0.4767	NEUTRAL	23.6	56.4	19.8	46.4
0.6158	NEUTRAL	22.8	56.0	19.0	46.0

Table 5-3-3 EUT: M/T 2672-CHU, s/n ZZ-00094, Ch.165(5825MHz) **TX** mode 24Mbps

Frequency (MHz)	Phase	QP Voltage (dB μ V)	CISPR22 QP Limit (dB μ V)	AV Voltage (dB μ V)	CISPR22 AV Limit (dB μ V)
0.1991	NEUTRAL	31.4	63.6	27.7	53.6
0.2747	NEUTRAL	34.3	61.0	29.0	51.0
0.3404	NEUTRAL	27.6	59.2	22.8	49.2
0.4136	NEUTRAL	23.7	57.6	18.8	47.6
0.4793	NEUTRAL	25.1	56.4	21.1	46.4
0.5499	LINE	19.6	56.0	14.3	46.0

Table 5-3-4 EUT: M/T 2672-CHU, s/n ZZ-00094, Ch.157(5785MHz) **RX** mode

Frequency (MHz)	Phase	QP Voltage (dB μ V)	CISPR22 QP Limit (dB μ V)	AV Voltage (dB μ V)	CISPR22 AV Limit (dB μ V)
0.2737	NEUTRAL	34.0	61.0	28.9	51.0
0.3422	NEUTRAL	28.7	59.1	24.5	49.1
0.4075	NEUTRAL	22.4	57.7	17.0	47.7
0.4792	NEUTRAL	25.2	56.4	21.4	46.4
0.6152	NEUTRAL	22.8	56.0	19.5	46.0
1.7858	NEUTRAL	20.1	56.0	16.8	46.0

6. RESTRICTED BANDS RADIATIONS (30MHz – 1GHz)

[FCC 15.205 / 209, RSS-210 6.2.1 / 6.3 / 7.3]

6.1 Test Procedure

Preliminary radiated emissions are measured in the semi-anechoic chamber at a 3 meter distance on every azimuth in both horizontal and vertical polarity. The antennas are also scanned in height. The emissions are recorded with a spectrum analyzer in peak hold mode. The identified emissions are further maximized by a cable manipulation. Emissions closest to the limits are measured in the quasi-peak mode with the tuned receiver using a bandwidth of 120kHz. The highest emissions relative to the limit are listed.

6.2 Test Instruments and Measurement Setup

Table 6-1 Radiated Emission Test Instrumentation

Description	Model	Serial Number
Computer	IBM 5551-L	#4
Spectrum Analyzer (100Hz-1.5GHz) for 30-200MHz	HP 85680B	3019A05155
Spectrum Analyzer Display for 30-200MHz	HP 85662A	3026A19353
Quasi-Peak Adapter for 30-200MHz	HP 85650A	3033A01449
Spectrum Analyzer (100Hz-1.5GHz) for 200-1000MHz	HP 85680B	2841A04252
Spectrum Analyzer Display for 200-1000MHz	HP 85662A	2816A16831
Quasi-Peak Adapter for 200-1000MHz	HP 85650A	2811A01156
Amplifier (100KHz-1.3GHz)		
- for 30-200MHz	HP 8447D	2805A02919
- for 200-1000MHz	HP 8447D	2944A03506
Biconical Antenna (30-200MHz)	EMCO 3108	2309
Log-Periodic Antenna (200-1000MHz)	EMCO 3146	1585
Receiver (20MHz-1.3GHz)	R&S ESVP	893202/018
Switch/control unit	HP 3488A	2719A17226
N-Coax cables:	Length:	
- Bi-coni Ant <=> 10m Cable	9 m	- EM103L01
- 10m Cable <=> Shield Panel	10 m	- EM103L02
- Shield Panel <=> RF Amp	7 m	- EM103L03
- RF Amp <=> Power Splitter	0.5m	- EM103L04
- Log-peri Ant <=> 10m Cable	9 m	- EM103H01
- 10m Cable <=> Shield Panel	10 m	- EM103H02
- Shield Panel <=> RF Amp	7 m	- EM103H03
- RF Amp <=> Power Splitter	0.5m	- EM103H04
Coax cables:		
- Power Splitter <=> SW/Con.unit (SW110)	1 m	- EM103L05
- Power Splitter <=> SW/Con.unit (SW300)	1 m	- EM103L06
- Power Splitter <=> SW/Con.unit (SW100)	1 m	- EM103H05
- Power Splitter <=> SW/Con.unit (SW301)	1 m	- EM103H06

- SW/Con.unit <=> Receiver (Input)	2 m	- EM1RCV
- SW/Con.unit <=> Spe Ana.(Signal In) for 30- 200MHz	2 m	- EM1SPL
- SW/Con.unit <=> Spe Ana.(Signal In) for 200-1000MHZ	2 m	- EM1SPH

Notes:

- HP: Hewlett Packard, R&S: Rohde & Schwarz

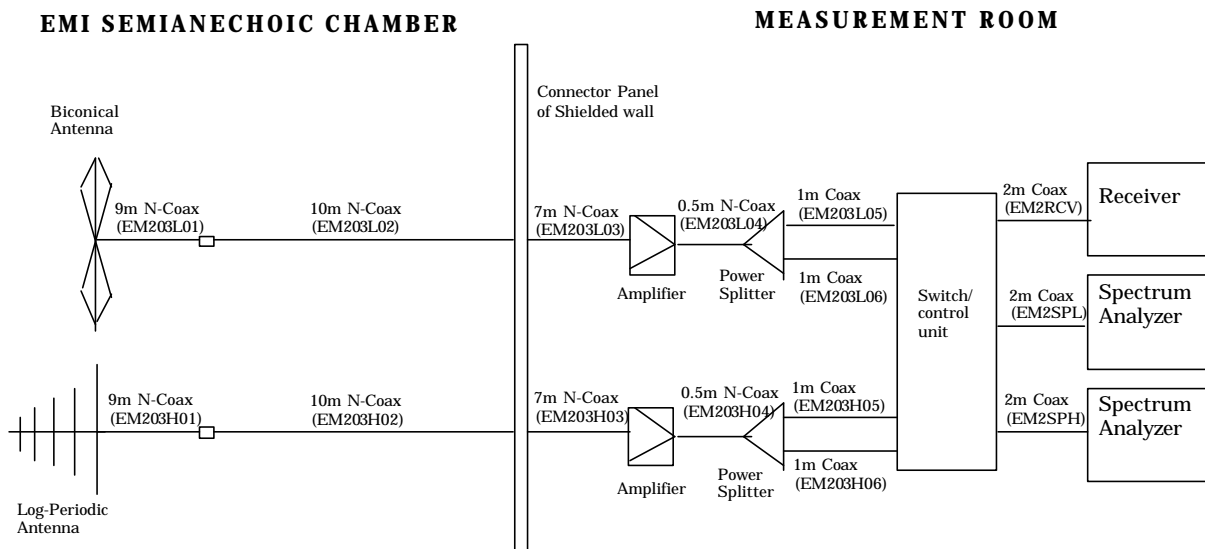

Figure 6 Cables for Radiated Emission Test

6.3 Field Strength Calculation

The field strength is calculated by adding the Antenna Factor and Cable Loss, and subtracting Amplifier Gain from the measured reading. In this test facility, the Antenna Factor, Cable Loss, and Amplifier Gains are loaded into the Rohde & Schwarz Receiver and the corrected field strength can be read directly on the receiver. All factors are included in the reported data.

$$FS = R + AF + CORR$$

where:

FS	=	Field Strength
R	=	Measured Receiver Input Amplitude
AF	=	Antenna Factor
CORR	=	Correction Factor = CL - AG
CL	=	Cable Loss
AG	=	Amplifier Gain

For example:

Given a Receiver input reading of 51.5dB μ V; Antenna Factor of 8.5dB/m; Cable Loss of 1.3dB; and an Amplifier Gain of 26dB. The Field Strength of the measured emission is:

$$FS = 51.5 + 8.5 + 1.3 - 26.0 = 35.3\text{dB}\mu\text{V/m}$$

Conversion between dB μ V/m (or dB μ V) and μ V/m (or μ V) are done as:

$$\text{Level}(\text{dB}\mu\text{V/m}) = 20 \times \text{Log}(\text{Level}(\mu\text{V/m}))$$

$$40\text{dB}\mu\text{V/m} = 100\mu\text{V/m}$$

$$48\text{dB}\mu\text{V/m} = 250\mu\text{V/m}$$

6.4 Measurement Results

The EUT was found to comply to the limits of FCC Part 15 Subpart C and RSS-210 with a margin of 1.5 dB at 30MHz - 1000MHz band.

The 6 highest emissions relative to the limits are reported.

Test Date: November 22 and 25, 2002

6.4.1 EUT in 2.4GHz IEEE802.11b transmission mode

Table 6-2-1. EUT: M/T 2672-CHU, s/n ZZ-00094, Ch.1(2412MHz) TX mode 11Mbps

Frequency (MHz)	Polarity (H/V)	Measured (dB μ V)	Antenna Factor (dB/m)	Corr. Factor (dB)	Field Strength (dB μ V/m)	Limit (dB μ V/m)	Field Strength (μ V/m)	Limit (μ V/m)
39.261	V	32.1	12.2	-18.5	25.8	40.0	19.5	100
199.973	H	38.7	13.8	-15.7	36.8	43.5	69.2	150
266.629	H	34.8	12.3	-14.4	32.7	46.0	43.2	200
454.779	V	41.4	16.5	-13.8	44.1	46.0	160.3	200
630.003	H	24.1	19.1	-11.9	31.3	46.0	36.7	200
933.202	V	20.1	22.6	-9.0	33.7	46.0	48.4	200

Table 6-2-2. EUT: M/T 2672-CHU, s/n ZZ-00094, Ch.6(2437MHz) TX mode 11Mbps

Frequency (MHz)	Polarity (H/V)	Measured (dB μ V)	Antenna Factor (dB/m)	Corr. Factor (dB)	Field Strength (dB μ V/m)	Limit (dB μ V/m)	Field Strength (μ V/m)	Limit (μ V/m)
36.456	V	34.4	12.5	-18.6	28.3	40.0	26.0	100
199.970	H	36.8	13.8	-15.7	34.9	43.5	55.6	150
259.873	H	34.7	12	-14.8	31.9	46.0	39.4	200
454.779	V	41.1	16.5	-13.8	43.8	46.0	154.9	200
859.872	V	21.6	22.1	-10.3	33.4	46.0	46.8	200
933.195	V	20.0	22.6	-9.0	33.6	46.0	47.9	200

Table 6-2-3. EUT: M/T 2672-CHU, s/n ZZ-00094, Ch.11(2462MHz) TX mode 11Mbps

Frequency (MHz)	Polarity (H/V)	Measured (dB μ V)	Antenna Factor (dB/m)	Corr. Factor (dB)	Field Strength (dB μ V/m)	Limit (dB μ V/m)	Field Strength (μ V/m)	Limit (μ V/m)
36.511	V	34.6	12.5	-18.6	28.5	40.0	26.6	100
199.969	H	38.5	13.8	-15.7	36.6	43.5	67.6	150
266.626	V	28.7	12.3	-14.4	26.6	46.0	21.4	200
454.780	V	41.6	16.5	-13.8	44.3	46.0	164.1	200
630.002	H	22.6	19.1	-11.9	29.8	46.0	30.9	200
932.563	H	18.3	22.6	-9.0	31.9	46.0	39.4	200

Table 6-2-4. EUT: M/T 2672-CHU, s/n ZZ-00094, Ch.6(2437MHz) **RX** mode

Frequency (MHz)	Polarity (H/V)	Measured (dB μ V)	Antenna Factor (dB/m)	Corr. Factor (dB)	Field Strength (dB μ V/m)	Limit (dB μ V/m)	Field Strength (μ V/m)	Limit (μ V/m)
38.823	V	32.0	12.2	-18.5	25.7	40.0	19.3	100
199.969	H	38.2	13.8	-15.7	36.3	43.5	65.3	150
266.626	H	33.8	12.3	-14.4	31.7	46.0	38.5	200
454.779	V	41.5	16.5	-13.8	44.2	46.0	162.2	200
899.865	H	23.3	22.5	-9.3	36.5	46.0	66.8	200
930.685	V	19.4	22.6	-9.1	32.9	46.0	44.2	200

6.4.2 EUT in 5.8GHz IEEE802.11a transmission mode

Table 6-3-1. EUT: M/T 2672-CHU, s/n ZZ-00094, Ch.149(5745MHz) **TX** mode 24Mbps

Frequency (MHz)	Polarity (H/V)	Measured (dB μ V)	Antenna Factor (dB/m)	Corr. Factor (dB)	Field Strength (dB μ V/m)	Limit (dB μ V/m)	Field Strength (μ V/m)	Limit (μ V/m)
37.423	H	34.6	12.4	-18.6	28.4	40.0	26.3	100
58.249	V	38.2	9.5	-18.2	29.5	40.0	29.9	100
63.850	V	38.7	9.1	-18.0	29.8	40.0	30.9	100
454.779	V	41.8	16.5	-13.8	44.5	46.0	167.9	200
863.996	V	25.5	22.2	-10.3	37.4	46.0	74.1	200
899.860	V	24.5	22.5	-9.3	37.7	46.0	76.7	200

Table 6-3-2 EUT: M/T 2672-CHU, s/n ZZ-00094, Ch.157(5785MHz) **TX** mode 24Mbps

Frequency (MHz)	Polarity (H/V)	Measured (dB μ V)	Antenna Factor (dB/m)	Corr. Factor (dB)	Field Strength (dB μ V/m)	Limit (dB μ V/m)	Field Strength (μ V/m)	Limit (μ V/m)
38.561	V	35.1	12.2	-18.5	28.8	40.0	27.5	100
58.637	V	38.0	9.5	-18.2	29.3	40.0	29.2	100
454.779	V	41.5	16.5	-13.8	44.2	46.0	162.2	200
733.221	V	25.4	20.6	-10.9	35.1	46.0	56.9	200
859.869	V	22.0	22.1	-10.3	33.8	46.0	49.0	200
899.862	V	24.3	22.5	-9.3	37.5	46.0	75.0	200

Table 6-3-3 EUT: M/T 2672-CHU, s/n ZZ-00094, Ch.165(5825MHz) **TX** mode 24Mbps

Frequency (MHz)	Polarity (H/V)	Measured (dB μ V)	Antenna Factor (dB/m)	Corr. Factor (dB)	Field Strength (dB μ V/m)	Limit (dB μ V/m)	Field Strength (μ V/m)	Limit (μ V/m)
38.326	V	36.5	12.3	-18.7	30.1	40.0	32.0	100
58.187	V	38.2	9.5	-18.2	29.5	40.0	29.9	100
454.779	V	41.7	16.5	-13.8	44.4	46.0	166.0	200
733.220	V	23.5	20.6	-10.9	33.2	46.0	45.7	200
863.996	V	27.1	22.2	-10.3	39.0	46.0	89.1	200
899.861	V	24.6	22.5	-9.3	37.8	46.0	77.6	200

Table 6-3-4 EUT: M/T 2672-CHU, s/n ZZ-00094, Ch.157(5785MHz) **RX** mode

Frequency (MHz)	Polarity (H/V)	Measured (dB μ V)	Antenna Factor (dB/m)	Corr. Factor (dB)	Field Strength (dB μ V/m)	Limit (dB μ V/m)	Field Strength (μ V/m)	Limit (μ V/m)
38.642	V	38.6	12.2	-18.5	32.3	40.0	41.2	100
57.845	V	37.0	9.6	-18.2	28.4	40.0	26.3	100
454.779	V	41.7	16.5	-13.8	44.4	46.0	166.0	200
733.226	V	24.7	20.6	-10.9	34.4	46.0	52.5	200
899.868	V	24.0	22.5	-9.3	37.2	46.0	72.4	200
928.567	H	19.7	22.6	-9.1	33.2	46.0	45.7	200

7. RESTRICTED BANDS RADIATIONS (1GHz – 40GHz)

[FCC 15.205 / 209, RSS-210 6.2.1 / 6.3 / 7.3]

7.1 Test Procedure

Radiated emissions were measured in the frequency range with 1 GHz to 40GHz in transmitting mode and 1 GHz to 25GHz in receiving mode. All tests were performed in the semi-anechoic chamber at a 3-meter distance (except for the frequency range with 18 GHz to 40 GHz where test distance was reduced to 1 meter) on both horizontal and vertical polarities. The antenna was also scanned in height. The emissions are recorded with a spectrum analyzer in peak hold mode. The identified emissions are further maximized as a function of cable manipulation, azimuth, and antenna height. The emissions closest to the limits are measured in the peak mode with the tuned spectrum analyzer using resolution bandwidth of 1MHz / video bandwidth of 1MHz, and the average setting mode with the tuned spectrum analyzer using resolution bandwidth of 1MHz / video bandwidth of 100Hz or 10Hz. The highest emissions relative to the limit are listed.

7.2 Test Instruments and Measurement Setup

Table 7 Radiated Emission Test Instrumentation (1GHz – 40GHz)

Description	Model	Serial Number
Spectrum Analyzer EMI Test Receiver	R&S ESI26	836119/003
Spectrum Analyzer	HP 8563E	3416A02248
Harmonic Mixer (26.5 – 40GHz)	Agilent 11970A	011269-001
Amplifier (1 - 26.5GHz)	HP 8449B	3008A00582
Amplifier (26.5 – 40GHz)	Agilent 83051A	3950M00193
Horn Antenna (1 - 18GHz)	EMCO 3115	9903-5774
Horn Antenna (3.95 – 5.85GHz)	EMCO 3160-5	1099
Horn Antenna (5.85 – 8.2GHz)	EMCO 3160-6	9712-1044
Horn Antenna (8.2 – 12.4GHz)	EMCO 3160-7	1158
Horn Antenna (12.4 – 18GHz)	EMCO 3160-8	1143
Horn Antenna (18 - 26.5GHz)	EMCO 3160-9	0004-1202
Horn Antenna (26.5 - 40GHz)	EMCO 3160-10	1175
Coaxial cables:	Length:	
- Horn Ant <=> RF Amp. (1-18GHz)	6 m	- EM206SCO
- RF Amp.<=>Spectrum Analyzer (1-12.4GHz)	15 m	- EM215SCO
- RF Amp.<=>Spectrum Analyzer (12.4-18GHz)	3m	- SF102-20166
- Horn Ant <=> RF Amp. (18-40GHz)	3m	- SF102-20167
- RF Amp.<=>Spectrum Analyzer (18-40GHz)	1m	- SF102-21105

Notes: - HP: Hewlett Packard, R&S: Rohde & Schwarz

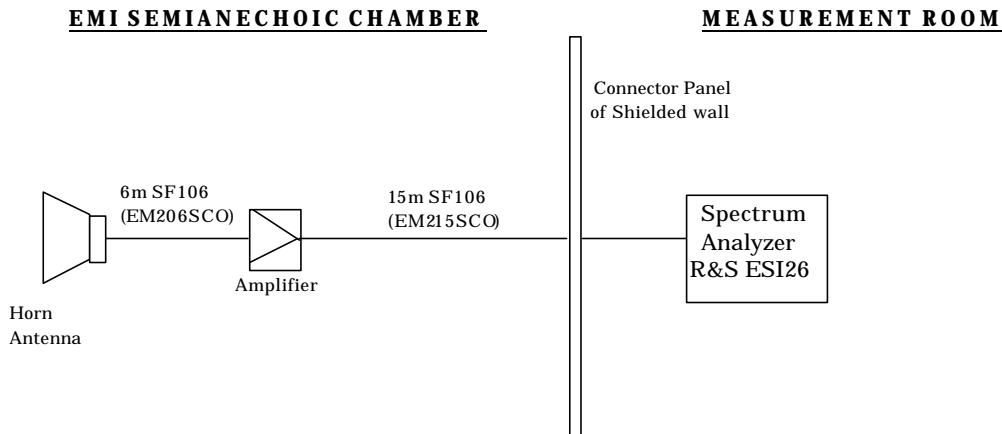

Figure 7-1. Cables for Radiated Emission Test (1 – 12.4 GHz)

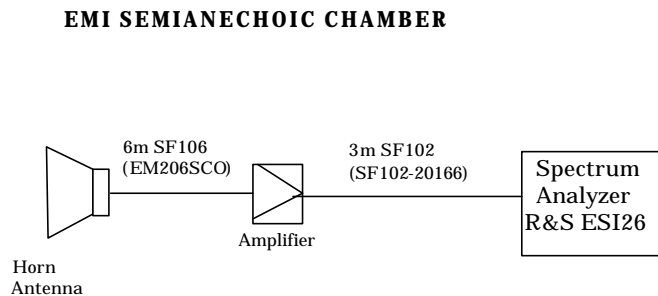

Figure 7-2. Cables for Radiated Emission Test (12.4 - 18GHz)

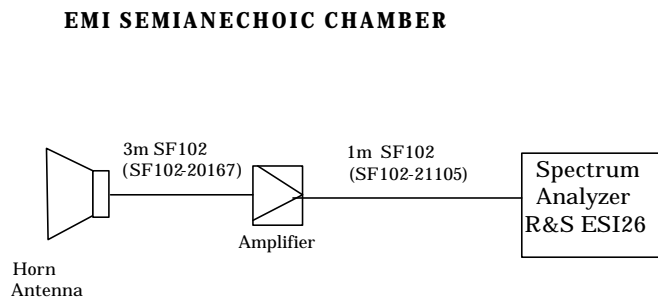

Figure 7-3. Cables for Radiated Emission Test (18 - 26.5GHz)

EMI SEMIANECHOIC CHAMBER

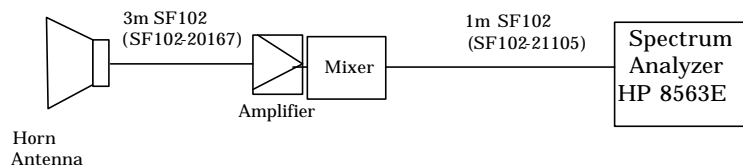

Figure 7-4. Cables for Radiated Emission Test (26.5 - 40GHz)

7.3 Field Strength Calculation

The field strength is calculated by adding the Antenna Factor and Cable Loss, and subtracting Amplifier Gain from the measured reading. All factors are included in the reported data.

$$FS = R + AF + CORR - FO$$

where:

- FS = Field Strength
- R = Measured Spectrum analyzer Input Amplitude
- AF = Antenna Factor
- CORR = Correction Factor = CL-AG
- CL = Cable Loss
- AG = Amplifier Gain
- FO = Distance Falloff Factor

For example:

Given a Spectrum Analyzer input reading of 51.5 dBμV; Antenna Factor of 8.5 dB/m; Cable Loss of 1.3 dB; Falloff Factor of 0 dB; and an Amplifier Gain of 26 dB. The Field Strength of the measured emission is:

$$FS = 51.5 + 8.5 + 1.3 - 26 - 0.0 = 35.6 \text{ dB}\mu\text{V/m}$$

Conversions between dBμV/m (or dBμV) and μV/m (or μV) are done as :

$$\begin{aligned} \text{Level(dB}\mu\text{V/m)} &= 20 \times \text{Log} (\text{Level}(\mu\text{V/m})) \\ 40 \text{ dB}\mu\text{V/m} &= 100 \mu\text{V/m} \\ 48 \text{ dB}\mu\text{V/m} &= 250 \mu\text{V/m} \end{aligned}$$

7.4 Measurement Results

The EUT was found to comply to the limits of FCC Part 15 Subpart C and RSS-210 with a margin of 3.0 dB. The measurement was done for the frequency range of 1 GHz to 40 GHz in TX mode and 1 GHz to 25GHz in RX mode.

Test Date: November 25, 26, 27, December 4 and 5, 2002

7.4.1 EUT in 2.4GHz IEEE802.11b transmission mode

Table 7-2-1. EUT: M/T 2672-CHU, s/n ZZ-00094, Ch.1(2412MHz) TX mode 11Mbps

Frequency (GHz)	Polarity (H/V)	Measured (dBμV) (peak)	Measured (dBμV) (average)	Antenna Factor (dB/m)	Corr. Factor (dB)	Falloff Factor (dB)	Field Strength (dBμV/m) (peak)	FCC Limit (dBμV/m) (peak)	Field Strength (dBμV/m) (average)	FCC Limit (dBμV/m) (average)
1.008	V	48.9	-	24.1	-32.9	0.0	40.1	74.0	-	54.0
1.130	V	52.8	-	24.6	-32.4	0.0	45.0	74.0	-	54.0
1.152	V	50.0	-	24.6	-32.4	0.0	42.2	74.0	-	54.0
1.196	V	58.2	-	25.2	-32.3	0.0	51.1	74.0	-	54.0
2.270	H	54.4	-	27.8	-30.5	0.0	51.7	74.0	-	54.0
2.349	H	56.7	46.5	28.1	-30.3	0.0	54.5	74.0	44.3	54.0
2.368	H	59.4	49.8	28.1	-30.4	0.0	57.1	74.0	47.5	54.0
2.390	H	62.5	53.2	28.2	-30.4	0.0	60.3	74.0	51.0	54.0
2.414	H	110.2	102.0	28.3	-30.4	0.0	108.1	OB*	99.9	OB*
4.824	V	45.6	-	27.1	-27.2	0.0	45.5	74.0	-	54.0
7.237	V	41.3	-	30.0	-26.4	0.0	44.9	74.0	-	54.0

*Note: OB means “operation band” (2400-2483.5MHz); in this case limit is 1W (measured conducted with power meter)

Table 7-2-2. EUT: M/T 2672-CHU, s/n ZZ-00094, Ch.6(2437MHz) TX mode 11Mbps

Frequency (GHz)	Polarity (H/V)	Measured (dBμV) (peak)	Measured (dBμV) (average)	Antenna Factor (dB/m)	Corr. Factor (dB)	Falloff Factor (dB)	Field Strength (dBμV/m) (peak)	FCC Limit (dBμV/m) (peak)	Field Strength (dBμV/m) (average)	FCC Limit (dBμV/m) (average)
1.008	V	49.0	-	24.1	-32.9	0.0	40.2	74.0	-	54.0
1.130	V	52.8	-	24.6	-32.4	0.0	45.0	74.0	-	54.0
1.152	V	49.9	-	24.6	-32.4	0.0	42.1	74.0	-	54.0
1.198	V	54.2	-	25.2	-32.3	0.0	47.1	74.0	-	54.0
2.310	H	54.0	-	28.0	-30.3	0.0	51.7	74.0	-	54.0
2.337	H	52.2	-	28.1	-30.3	0.0	50.0	74.0	-	54.0
2.368	H	58.0	49.5	28.1	-30.4	0.0	55.7	74.0	47.2	54.0
2.390	H	56.7	47.2	28.2	-30.4	0.0	54.5	74.0	45.0	54.0
2.436	H	109.1	101.0	28.3	-28.4	0.0	109.0	OB*	100.9	OB*
2.496	H	56.4	50.5	28.4	-30.2	0.0	54.6	74.0	48.7	54.0
4.874	V	45.9	-	27.0	-26.9	0.0	46.0	74.0	-	54.0
7.316	V	40.0	-	29.9	-25.8	0.0	44.1	74.0	-	54.0

*Note: OB means “operation band” (2400-2483.5MHz); in this case limit is 1W (measured conducted with power meter).

Table 7-2-3. EUT: M/T 2672-CHU, s/n ZZ-00094, Ch.11(2462MHz) **TX** mode 11Mbps

Frequency (GHz)	Polarity (H/V)	Measured (dBμV) (peak)	Measured (dBμV) (average)	Antenna Factor (dB/m)	Corr. Factor (dB)	Falloff Factor (dB)	Field Strength (dBμV/m) (peak)	FCC Limit (dBμV/m) (peak)	Field Strength (dBμV/m) (average)	FCC Limit (dBμV/m) (average)
1.008	V	482.0	-	24.1	-32.9	0.0	473.2	74.0	-	54.0
1.130	V	52.3	-	24.6	-32.4	0.0	44.5	74.0	-	54.0
1.152	V	50.3	-	24.6	-32.4	0.0	42.5	74.0	-	54.0
1.196	V	55.1	-	25.2	-32.3	0.0	48.0	74.0	-	54.0
2.305	H	52.7	-	28.0	-30.3	0.0	50.4	74.0	-	54.0
2.337	H	54.1	-	28.1	-30.3	0.0	51.9	74.0	-	54.0
2.369	H	55.2	-	28.1	-30.4	0.0	52.9	74.0	-	54.0
2.461	H	109.1	101.0	28.4	-30.2	0.0	107.3	OB*	99.2	OB*
2.484	H	60.4	51.5	28.4	-30.2	0.0	58.6	74.0	49.7	54.0
2.496	H	58.0	50.3	28.4	-30.2	0.0	56.2	74.0	48.5	54.0
4.924	V	48.0	-	27.0	-27.7	0.0	47.3	74.0	-	54.0
7.387	V	40.9	-	29.8	-26.2	0.0	44.5	74.0	-	54.0

*Note: OB means “operation band” (2400-2483.5MHz); in this case limit is 1W (measured conducted with power meter).

Table 7-2-4. EUT: M/T 2672-CHU, s/n ZZ-00094, Ch.6(2437MHz) **RX** mode

Frequency (GHz)	Polarity (H/V)	Measured (dBμV) (peak)	Measured (dBμV) (average)	Antenna Factor (dB/m)	Corr. Factor (dB)	Falloff Factor (dB)	Field Strength (dBμV/m) (peak)	FCC Limit (dBμV/m) (peak)	Field Strength (dBμV/m) (average)	FCC Limit (dBμV/m) (average)
1.008	V	49.4	-	24.1	-32.9	0.0	40.6	74.0	-	54.0
1.130	V	52.2	-	24.6	-32.4	0.0	44.4	74.0	-	54.0
1.152	V	49.3	-	24.6	-32.4	0.0	41.5	74.0	-	54.0
1.198	V	55.6	-	25.2	-32.3	0.0	48.5	74.0	-	54.0
1.860	V	49.0	-	27.4	-30.9	0.0	45.5	74.0	-	54.0

7.4.2 EUT in 5.8GHz IEEE802.11a transmission mode

Table 7-3-1. EUT: M/T 2672-CHU, s/n ZZ-00094, Ch.149(5745MHz) **TX** mode 24Mbps

Frequency (GHz)	Polarity (H/V)	Measured (dBμV) (peak)	Measured (dBμV) (average)	Antenna Factor (dB/m)	Corr. Factor (dB)	Falloff Factor (dB)	Field Strength (dBμV/m) (peak)	FCC Limit (dBμV/m) (peak)	Field Strength (dBμV/m) (average)	FCC Limit (dBμV/m) (average)
1.066	V	51.1	-	24.6	-32.7	0.0	43.0	74.0	-	54.0
1.130	V	52.6	-	24.6	-32.4	0.0	44.8	74.0	-	54.0
1.152	V	51.1	-	24.6	-32.4	0.0	43.3	74.0	-	54.0
1.192	V	56.0	-	25.2	-32.3	0.0	48.9	74.0	-	54.0
5.416	V	48.7	38.2	34.1	-26.9	0.0	55.9	74.0	45.4	54.0
5.751	V	102.6	91.3	34.0	-26.6	0.0	110.0	OB*	98.7	OB*
11.491	V	36.0	-	33.5	-21.6	0.0	47.9	74.0	-	54.0

*Note: OB means “operation band” (5725-5850MHz); in this case limit is 1W (measured conducted with power meter)

Table 7-3-2 EUT: M/T 2672-CHU, s/n ZZ-00094, Ch.157(5785MHz) **TX** mode 24Mbps

Frequency (GHz)	Polarity (H/V)	Measured (dBμV) (<i>peak</i>)	Measured (dBμV) (<i>average</i>)	Antenna Factor (dB/m)	Corr. Factor (dB)	Falloff Factor (dB)	Field Strength (dBμV/m) (<i>peak</i>)	FCC Limit (dBμV/m) (<i>peak</i>)	Field Strength (dBμV/m) (<i>average</i>)	FCC Limit (dBμV/m) (<i>average</i>)
1.066	V	51.1	-	24.6	-32.7	0.0	43.0	74.0	-	54.0
1.130	V	52.6	-	24.6	-32.4	0.0	44.8	74.0	-	54.0
1.152	V	49.0	-	24.6	-32.4	0.0	41.2	74.0	-	54.0
1.192	V	55.1	-	25.2	-32.3	0.0	48.0	74.0	-	54.0
5.416	V	49.2	37.9	34.1	-26.9	0.0	56.4	74.0	45.1	54.0
5.791	V	103.9	91.4	34.2	-26.3	0.0	111.8	OB*	99.3	OB*
11.569	H	38.6	-	33.5	-21.7	0.0	50.4	74.0	-	54.0

*Note: OB means “operation band” (5725-5850MHz); in this case limit is 1W (measured conducted with power meter)

Table 7-3-3 EUT: M/T 2672-CHU, s/n ZZ-00094, Ch.165(5825MHz) **TX** mode 24Mbps

Frequency (GHz)	Polarity (H/V)	Measured (dBμV) (<i>peak</i>)	Measured (dBμV) (<i>average</i>)	Antenna Factor (dB/m)	Corr. Factor (dB)	Falloff Factor (dB)	Field Strength (dBμV/m) (<i>peak</i>)	FCC Limit (dBμV/m) (<i>peak</i>)	Field Strength (dBμV/m) (<i>average</i>)	FCC Limit (dBμV/m) (<i>average</i>)
1.064	V	52.5	-	24.6	-32.7	0.0	44.4	74.0	-	54.0
1.130	V	52.4	-	24.6	-32.4	0.0	44.6	74.0	-	54.0
1.152	V	50.2	-	24.6	-32.4	0.0	42.4	74.0	-	54.0
1.198	V	55.8	-	25.2	-32.3	0.0	48.7	74.0	-	54.0
4.665	V	49.0	-	32.5	-28.2	0.0	53.3	74.0	-	54.0
5.416	V	49.2	37.8	34.1	-26.9	0.0	56.4	74.0	45.0	54.0
5.830	V	104.3	92.3	34.0	-26.2	0.0	112.1	OB*	100.1	OB*
11.651	H	35.5	-	33.6	-21.6	0.0	47.5	74.0	-	54.0

*Note: OB means “operation band” (5725-5850MHz); in this case limit is 1W (measured conducted with power meter)

Table 7-3-4 EUT: M/T 2672-CHU, s/n ZZ-00094, Ch.157(5785MHz) **RX** mode

Frequency (GHz)	Polarity (H/V)	Measured (dBμV) (<i>peak</i>)	Measured (dBμV) (<i>average</i>)	Antenna Factor (dB/m)	Corr. Factor (dB)	Falloff Factor (dB)	Field Strength (dBμV/m) (<i>peak</i>)	FCC Limit (dBμV/m) (<i>peak</i>)	Field Strength (dBμV/m) (<i>average</i>)	FCC Limit (dBμV/m) (<i>average</i>)
1.062	V	55.3	-	24.6	-32.7	0.0	47.2	74.0	-	54.0
1.130	V	52.5	-	24.6	-32.4	0.0	44.7	74.0	-	54.0
1.152	V	51.6	-	24.6	-32.4	0.0	43.8	74.0	-	54.0
1.192	V	56.4	-	25.2	-32.3	0.0	49.3	74.0	-	54.0

Measurement plots for adjacent restricted band



Marker 1 [T1] RBW 1 MHz RF Att 20 dB
 Ref Lvl 110.17 dB/V VBW 1 MHz
 117 dB/V 2.41350301 GHz SWT 5 ms Unit dB/V

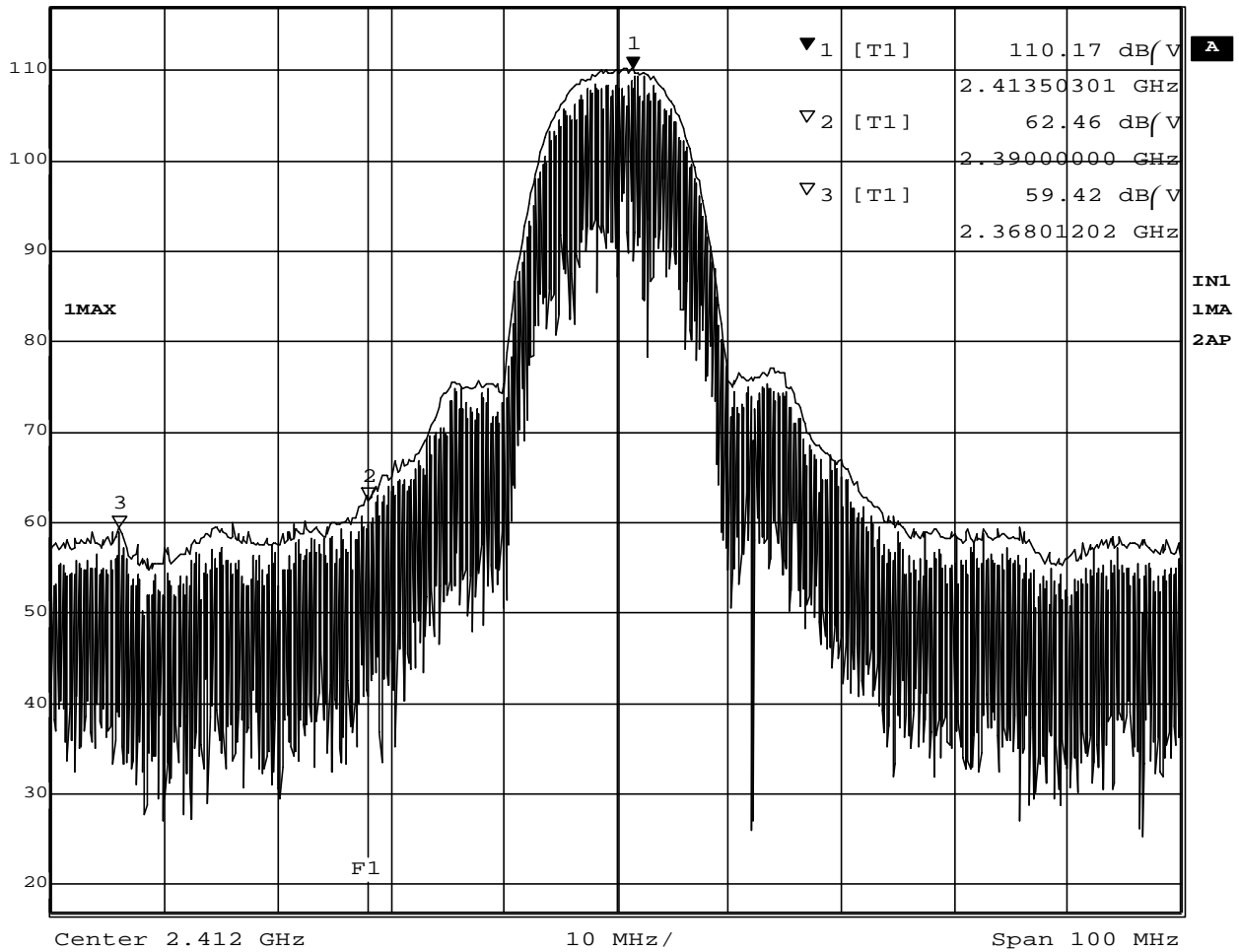

Date: 26.NOV.2002 11:52:27

Plot 7-3-1 Ch.1 2412MHz TX 11Mb/s (Peak)



Marker 1 [T1] RBW 1 MHz RF Att 20 dB
 Ref Lvl 101.96 dB/V VBW 10 Hz
 117 dB/V 2.41330261 GHz SWT 25 s Unit dB/V

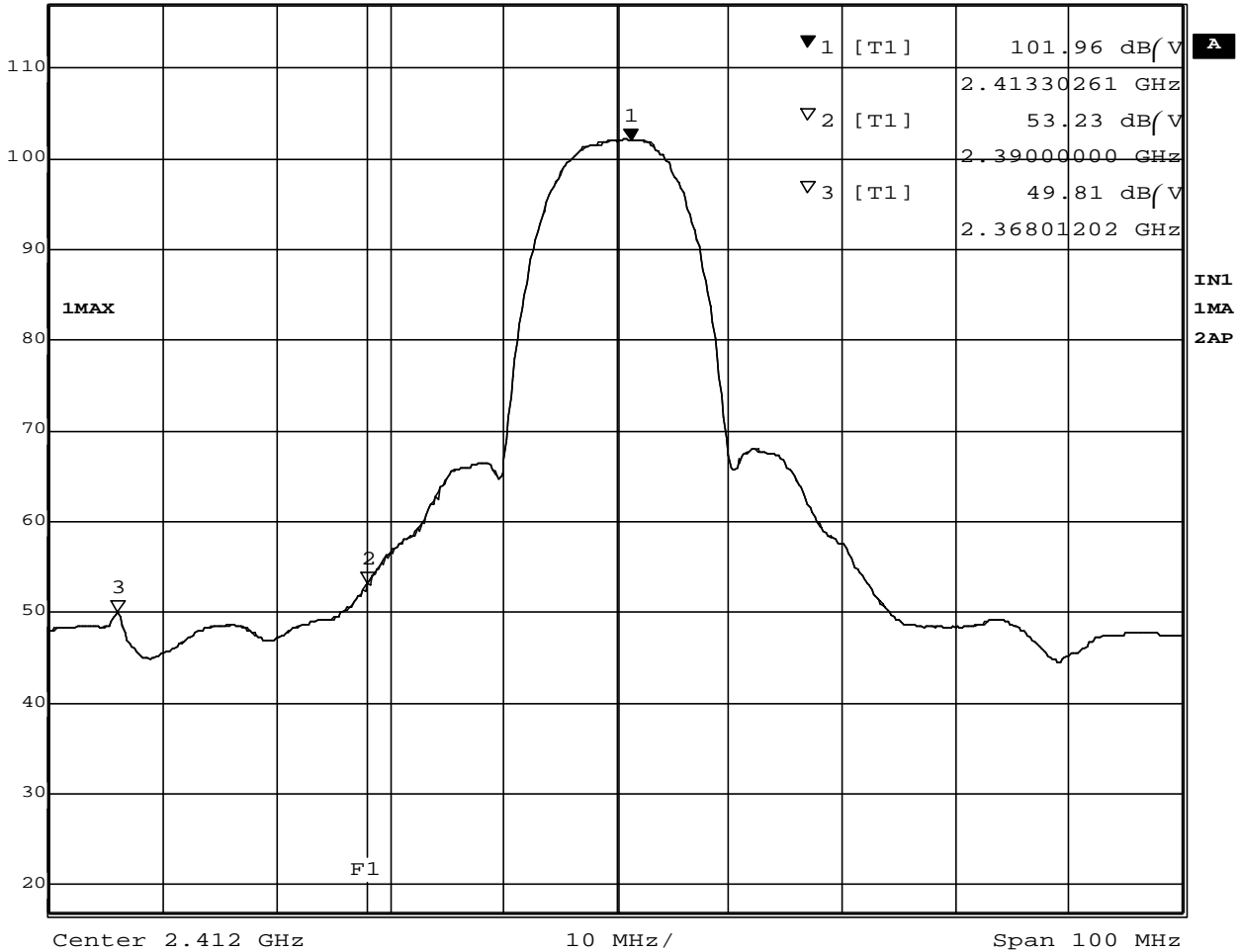

Date: 26.NOV.2002 11:51:56

Plot 7-3-2 Ch.1 2412MHz TX11Mb/s (Average)



Marker 1 [T1] RBW 1 MHz RF Att 20 dB
 Ref Lvl 109.08 dB/V VBW 1 MHz
 117 dB/V 2.46069739 GHz SWT 5 ms Unit dB/V

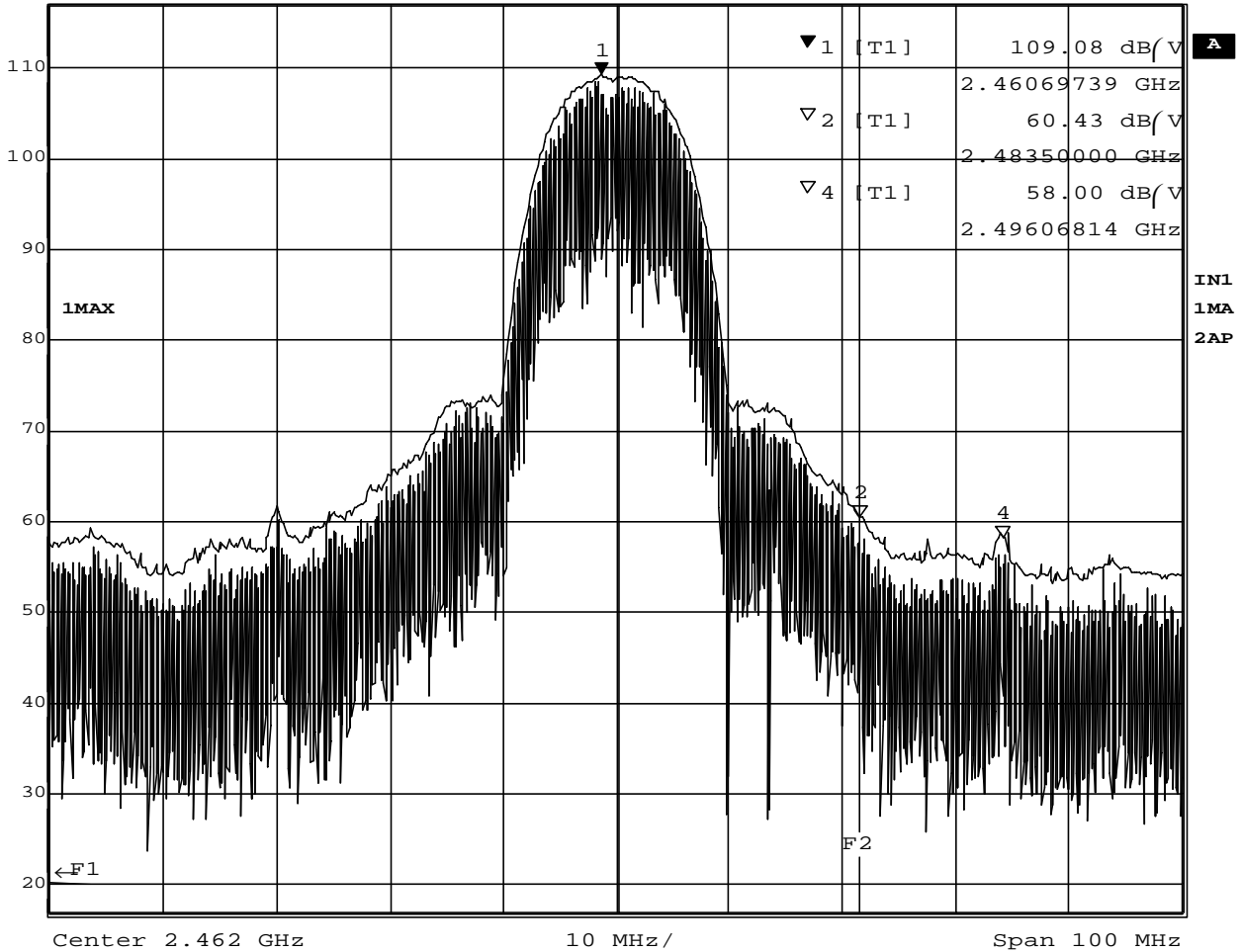

Date: 26.NOV.2002 13:03:26

Plot 7-3-3 Ch.11 2462MHz TX 11Mb/s (Peak)



Marker 1 [T1] RBW 1 MHz RF Att 20 dB
 Ref Lvl 101.02 dB/V VBW 10 Hz
 117 dB/V 2.46129860 GHz SWT 25 s Unit dB/V

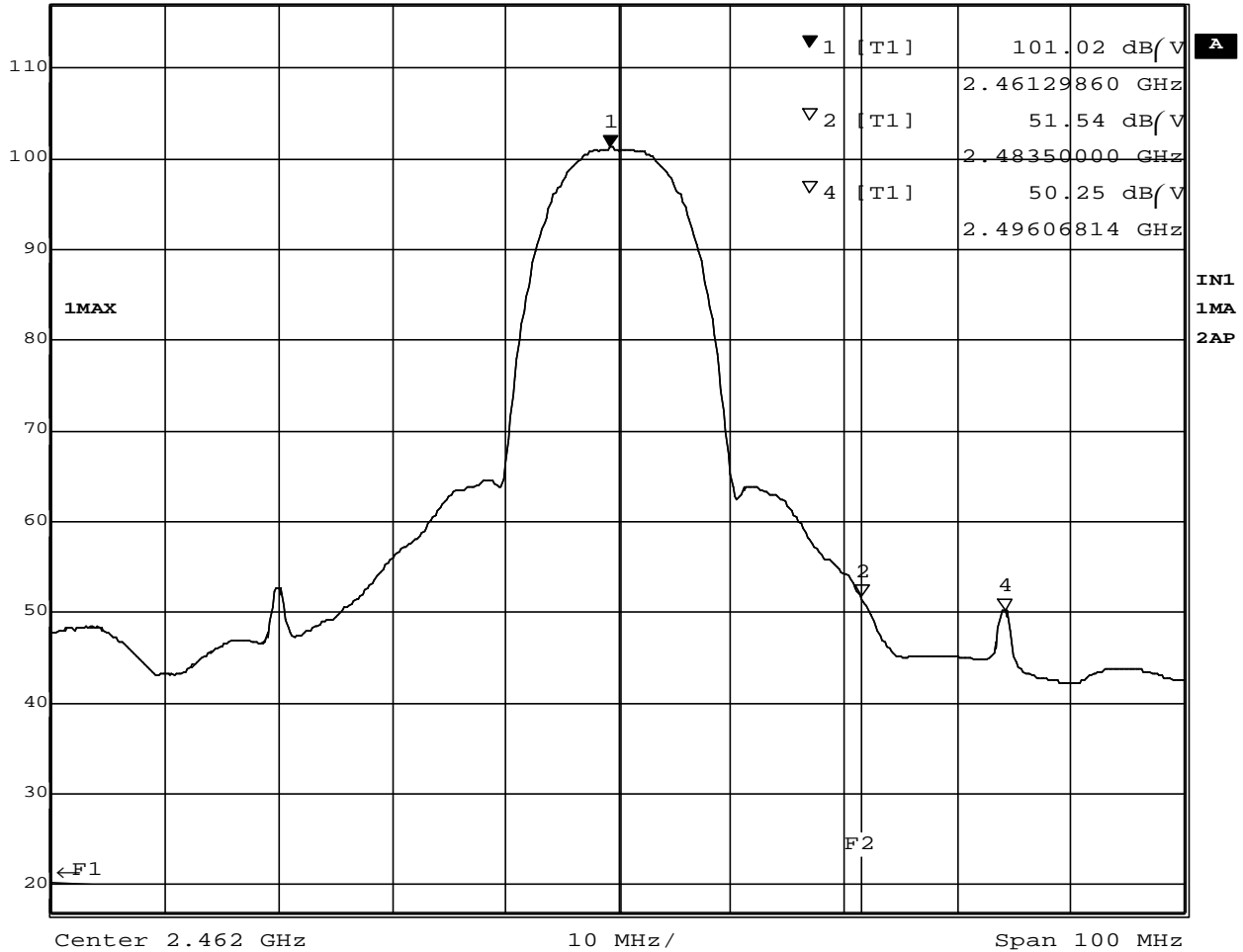

Date: 26.NOV.2002 13:04:19

Plot 7-3-4 Ch.11 2462MHz TX 11Mb/s (Average)