

RF Exposure

1. RF Exposure evaluation for the applying transmitter

As shown in the following photo, both main and auxiliary WLAN antennas of the applying laptop PC, IBM ThinkPad X30 Series, are located at the upper part of the display (LCD) bezel. The separation distances between the antennas and the human body are 20cm or more. Therefore the laptop PC can be categorized as a mobile device by FCC CFR 47 Section 2.1091.

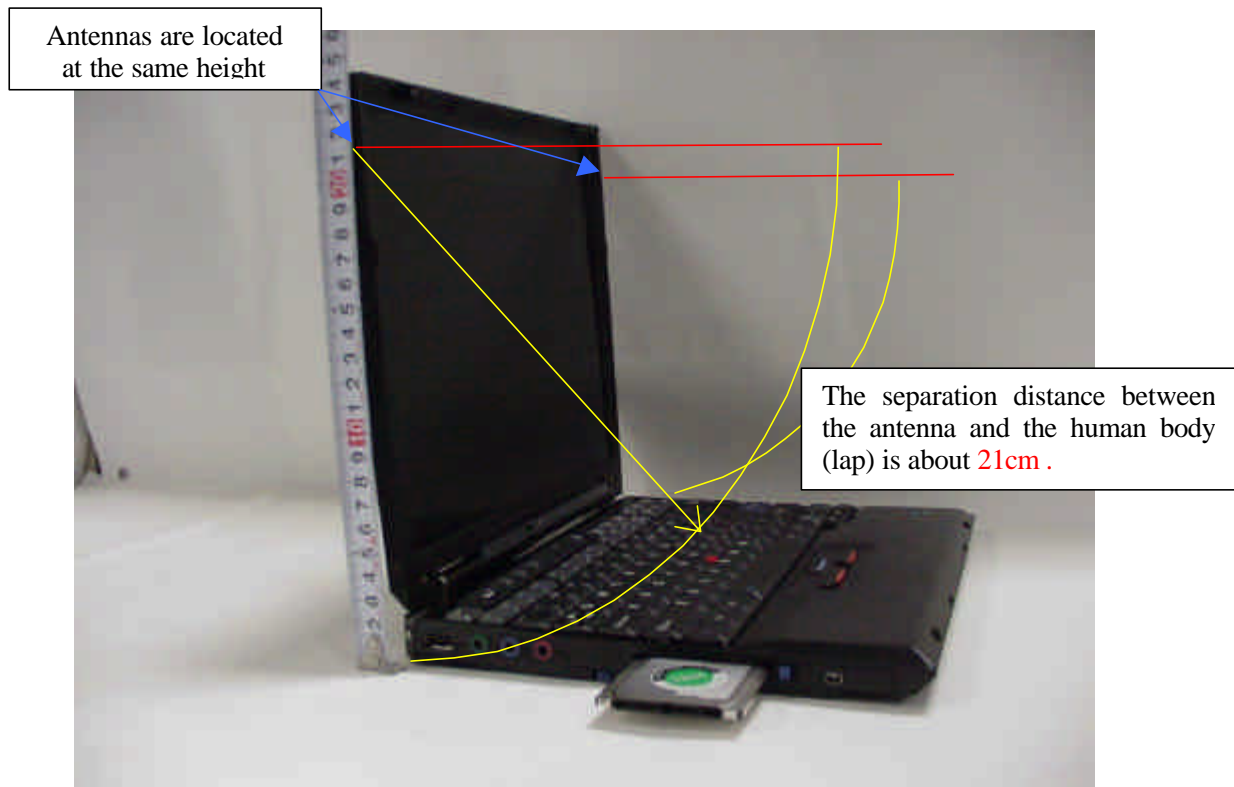

[MPE on 2.4GHz band]

The highest conducted peak output power of the Test Report is 51.3mW (17.1dBm) and the maximum antenna gain is 1.28 dBi (See page 5 of this exhibit.).

Therefore the peak radiated output power(EIRP) is calculated as follows.

$$EIRP = P + G = 17.1 \text{ dBm} + 1.28 \text{ dBi} = 18.38 \text{ dBm} (68.87\text{mW})$$

Then, the maximum power density at 20cm distance is calculated as :

$$S = EIRP / (4 \times R^2 \times \pi) = 0.0137 \text{ mW/cm}^2$$

[MPE on 5.8GHz band]

The highest conducted peak output power of the Test Report is 46.8mW (16.7dBm) and the maximum antenna gain is 0.32 dBi (See page 5 of this exhibit.).

Therefore the peak radiated output power(EIRP) is calculated as follows.

$$\text{EIRP} = P + G = 16.7 \text{ dBm} + 0.32 \text{ dBi} = 17.02 \text{ dBm} (50.35\text{mW})$$

Then, the maximum power density at 20cm distance is calculated as :

$$S = \text{EIRP}/(4 \times R^2 \times \pi) = 0.0100 \text{ mW/cm}^2$$

Since the applying laptop PC's WLAN transmitter does not function to emit the radio frequency from both diversity antennas simultaneously, the above value is the maximum RF exposure to the persons and is below the MPE limit (1.0 mW/ cm²). Therefore the laptop PC meets the MPE requirements for general Population/Uncontrolled exposure.

2. RF Exposure evaluation for Bluetooth transmitters

The applying laptop PC (ThinkPad X30 Series) supports three kinds of Bluetooth devices as follows.

	FCC ID	Grantee Name	Product Name	Granted Date	ERP in FCC Test Report
User's option	PI4BT-ULTRA	TDK Systems Europe Ltd.	Bluetooth Ultraport Module	May/22/2001	1.4 mW
	PI4BT-IBM-PCII		Bluetooth PC Card II	August/21/2001	1.0mW
Built-intype LMA Transmitter	ANO20020100MTN	IBM Japan, Ltd.	IBM integrated Bluetooth with 56K Modem	Under inspection with this application	2.5mW

Interfaces to connect Wireless options

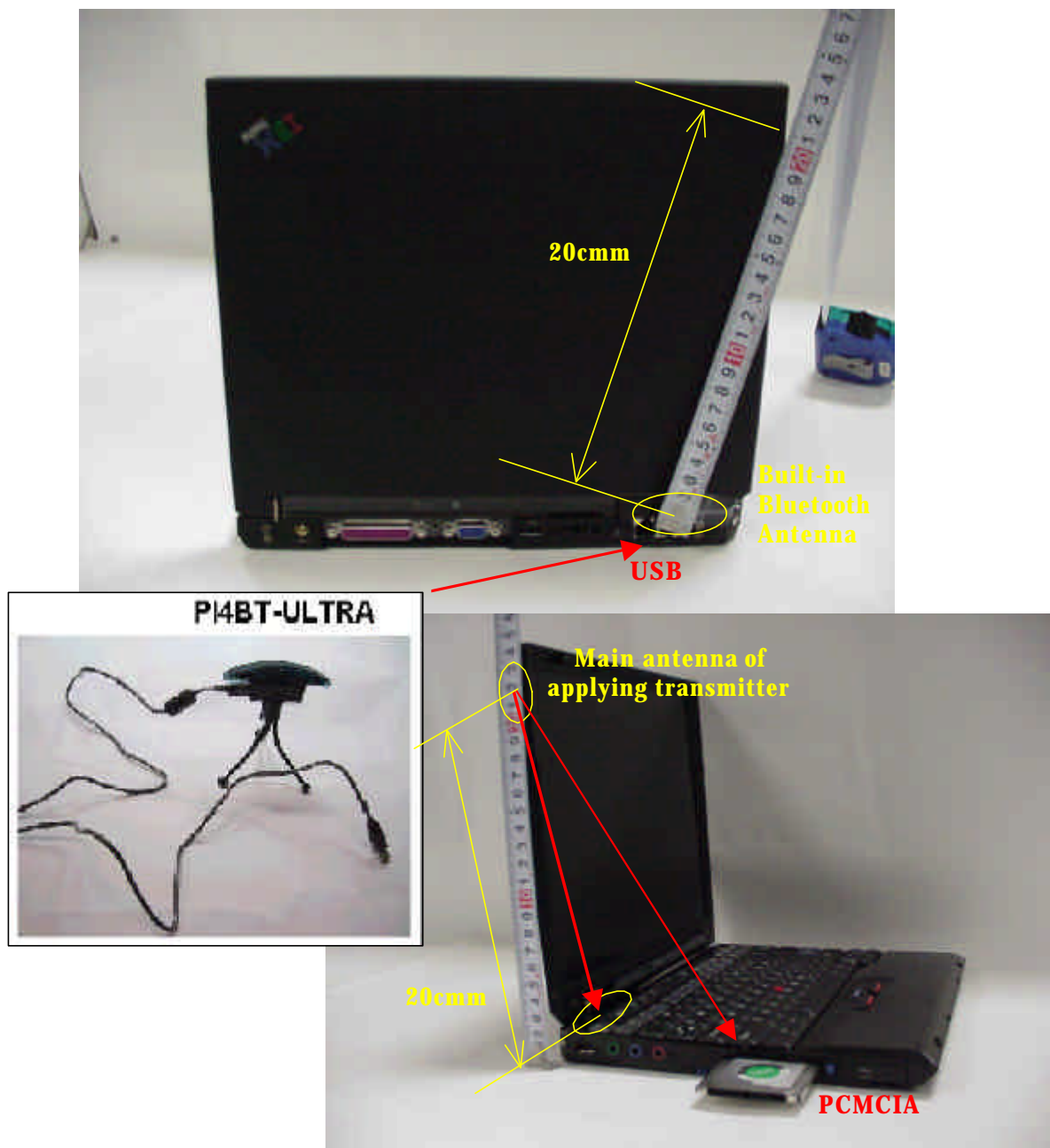

The main and auxiliary antennas of the applying transmitter in the LCD section are assembled apart from each Bluetooth antenna shown in the previous page with 20 cm or more distance.

Therefore the RF exposure evaluation for those Bluetooth transmitters is able to be done independently of the applying antennas. In other word, a collocated SAR testing is not required.

When a customer operates the applying PC on one's lap, the sufficient separation distance (minimum 20cm) between the above Bluetooth antennas and the person's body (lap) can not be maintained.

But the footnote of the Section 3 in Supplement C to OET Bulletin 65 states "¹⁴ If a device, its antenna or other radiating structures are operating at closer than 2.5 cm from a person's body or in contact with the body, SAR evaluation may be necessary when the output is more than 50 – 100 mW, depending on the device operating configurations and exposure conditions."

The total output power of the three Bluetooth transmitters in the previous table does not exceed 5mW. Therefore these transmitters also satisfy the RF exposure evaluation regarding CFR 47 Part 15.247(b)(4) without a SAR compliance test report, and can operate with the applying transmitter simultaneously.

IBM Web site guides to customers about the **grant condition** related to those collaborating transmitter devices. See page 8 of this exhibit.

3. Antenna Gains of applying equipment

3.1 Antenna Specification

Transmission Antenna assembly overview

Designator	Manufacture	Antenna type	Cable type and length	Gain (dBi) Note 1)
08K4083 Main antenna	Nissei Electric Ltd. (Japan)	Dual Band Inverted F type Antenna	coax 394mm	2400-2500MHz 0.62 dBi (peak)
				5725-5850MHz 0.32 dBi (peak)
08K4084 Auxiliary antenna	Nissei Electric Ltd. (Japan)	Dual Band Inverted F type Antenna	coax 534mm	2400-2500MHz 1.28 dBi (peak)
				5725-5850MHz -0.87 dBi (peak)

Notes:

1a. Includes all cable losses.

1b. Antenna type should be Omni Directional and have gain of 3.0 dBi or less for IEEE802.11a(5GHz band) and have gain of 2.0 dBi or less for IEEE802.11b(2.4GHz band), regarding the IBM internal specification.

3.2 Radiation characteristic of antennas

Radiation characteristic of antenna is measured in regard to the rotation angle x° as shown below.

Main Antenna

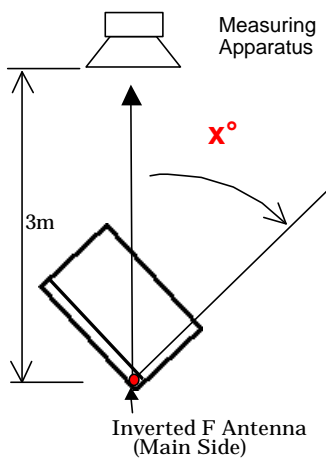

Auxiliary Antenna

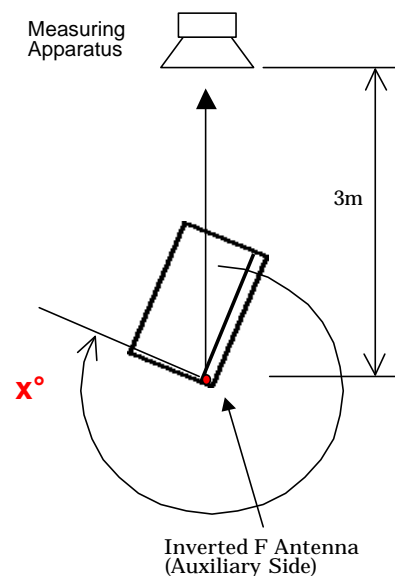

3.2.1 2400-2500MHz radiation characteristic

Main antenna

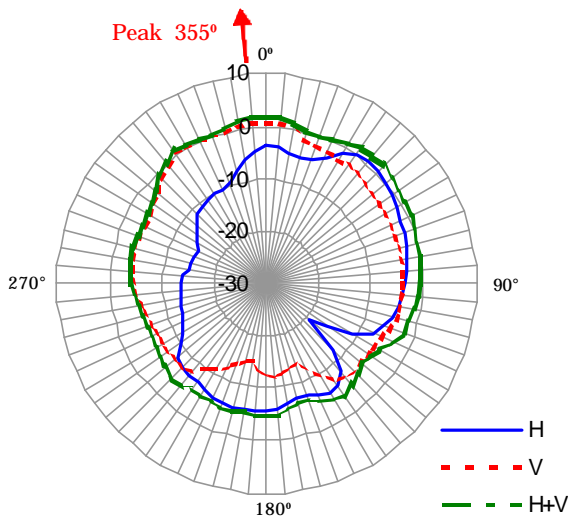

Hori (dBi) ave.	-5.66
Vert (dBi) ave.	-4.00
H+V (dBi) ave.	-1.74
Peak(dBi) (V)	0.62
Peak Angle (X°=)	355°
Center Frequency	2500MHz

Note1) The measurement was performed at 3 frequencies (2400, 2450, 2500MHz).

Note2) The maximum antenna gain was found around **355 degree** angle from measuring apparatus in **vertical** polarization at the high frequency (2500MHz).

Auxiliary antenna

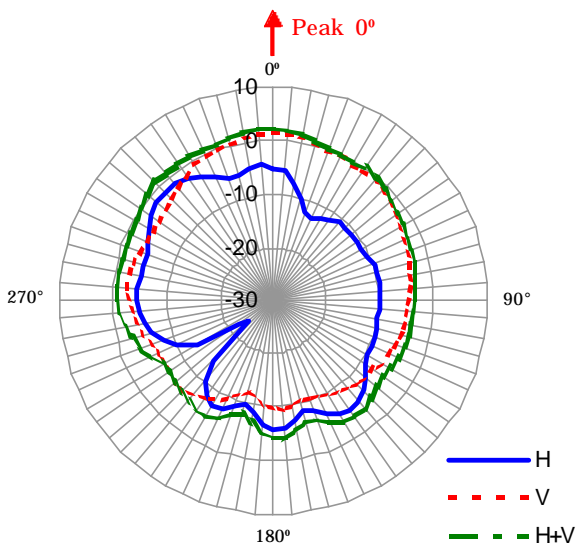

Hori (dBi) ave.	-6.61
Vert (dBi) ave.	-3.32
H+V (dBi) ave.	-1.65
Peak(dBi) (V)	1.28
Peak Angle (X°=)	0°
Center Frequency	2500MHz

Note1) The measurement was performed at 3 frequencies (2400, 2450, 2500MHz).

Note2) The maximum antenna gain was found around **0 degree** angle from measuring apparatus in **vertical** polarization at the high frequency (2500MHz).

3.2.2 5725-5850MHz radiation characteristic

Main antenna

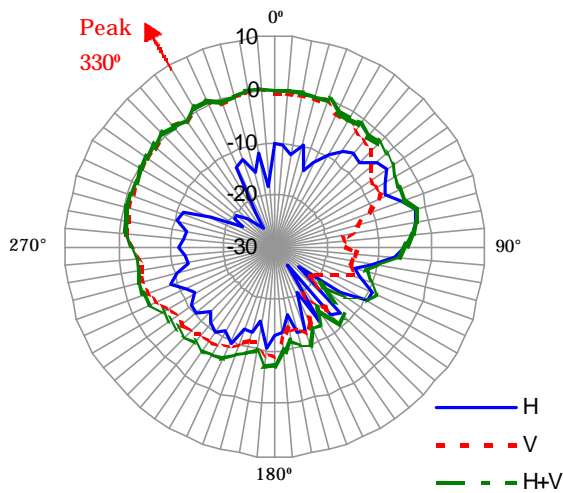

Hori (dBi) ave.	-9.97
Vert (dBi) ave.	-4.18
H+V (dBi) ave.	-3.17
Peak(dBi) (V)	0.32
Peak Angle (X°=)	330°
Center Frequency	5750MHz

Note1) The measurement was performed at 4 frequencies (5725, 5750, 5800, 5850MHz).

Note2) The maximum antenna gain was found around **330 degree** angle from measuring apparatus in **vertical** polarization at the low frequency (5750MHz).

Auxiliary antenna

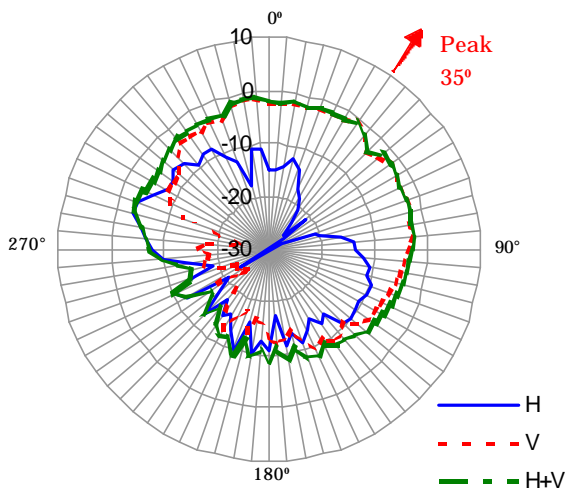

Hori (dBi) ave.	-10.88
Vert (dBi) ave.	-5.68
H+V (dBi) ave.	-4.53
Peak(dBi) (V)	-0.87
Peak Angle (X°=)	35°
Center Frequency	5725MHz

Note1) The measurement was performed at 4 frequencies (5725, 5750, 5800, 5850MHz).

Note2) The maximum antenna gain was found around **35 degree** angle from measuring apparatus in **vertical** polarization at the low frequency (5725MHz).

4. IBM Web site for user’s guidance concerning the co-located transmitters

Note) The contents will be available after the product announcement.

<http://www.pc.ibm.com/qtechinfo/MIGR-44156.html>

The screenshot shows the IBM website interface. At the top left is the IBM logo. To its right is a search bar with a 'Search' button. Below the logo is a navigation menu with links for 'Home', 'Products & services', 'Support & downloads', and 'My account'. A secondary menu includes 'Select a language', 'PC support home', 'Login', 'Profile', 'My page', 'Ask an expert', and 'Help'. The main content area is titled 'TP Wireless Systems - Additional RF Option devices receive FCC certification'. It features a sidebar on the left with 'PC support home' and 'Warranty lookup' sections, and a 'Related links' section containing various support resources. The main content includes a section for 'Applicable countries/regions' (United States), 'Service hints & tips', and 'Affected configurations'. A table lists 'Pre-installed Models' of IBM Dual-Band 11a/b Wi-Fi Wireless Mini PCI Adapters, their FCC IDs, and whether they allow multiple PC options for transmission. Below the table, there are links for 'Other wireless pre-installed type or wireless upgradable models', a note about BIOS recognition, and a list of three specific configurations with their FCC IDs and corresponding product links. A 'Solution' section provides supplementary information and a list of three steps for users to follow when using Bluetooth or wireless options. The footer contains 'About IBM', 'Privacy', 'Legal', and 'Contact' links, along with document ID, modification date, and copyright information.

TP Wireless Systems – Additional RF Option devices receive FCC certification

Applicable countries/regions
United States

Service hints & tips
Affected configurations
Additional RF Option devices receive FCC certification for use on:

Pre-installed Models of IBM Dual-Band 11a/b Wi-Fi Wireless Mini PCI Adapter	FCC IDs	PC options allowed multiple transmission		
		#1	#2	#3
ThinkPad R40 Series wireless models	ANO20020300D3L	<input type="radio"/>	<input type="radio"/>	<input type="radio"/>
ThinkPad T40 Series wireless models	ANO20020302R1L	<input type="radio"/>	<input type="radio"/>	<input type="radio"/>
ThinkPad X30 Series wireless models (X31)	ANO20020304T2L	<input type="radio"/>	<input type="radio"/>	<input type="radio"/>

[Other wireless pre-installed type or wireless upgradable models](#)

NG: Not recognized by BIOS, nor not authorized to use.

#1: FCC ID: ANO20020100MTN [IBM Integrated Bluetooth with 56K Modem](#)
 #2: FCC ID: P14BT-ULTRA [Bluetooth UltraPort Module from IBM](#)
 #3: FCC ID: P14BT-IBM-PCII [Bluetooth PC Card II](#)

Solution
 The supplementary document of ThinkPad’s “Service and Troubleshooting Guide” has the following information in “Wireless regulatory information – USA Federal Communications Commission (FCC)” section:

Please make sure of the following when you use a Bluetooth option or wireless option PC Card in your ThinkPad computer:

1. Visit the IBM site at www.ibm.com/pc/qtechinfo/MIGR-44156.html and confirm the updated list of RF option devices that have been approved to cooperate with the integrated wireless feature.
2. When you use any other RF option device that is not listed on the IBM site, all other wireless features including the integrated transmitter in your ThinkPad computer are required to be turned off.
3. Users are requested to follow the RF Safety instructions on wireless option devices that are included in the RF option device’s user’s manual.

Document id: MIGR-44156
 Last modified: 2002-06-03
 Copyright (C) 2002 IBM Corporation