

# Uniden®

# UM385

**WATERPROOF DSC MARINE RADIO**

**RADIO MARITIME ASN HYDROFUGE**



**OWNER'S MANUAL  
GUIDE D'UTILISATION**

## MAKING A DISTRESS CALL

Lift the red cover. Press and hold the DISTRESS button for three seconds. Your radio transmits your boat's location every few minutes until you receive a response.



Lift the red cover  
and press the  
DISTRESS button.

⚠ **NOTE: IF the radio displays Enter User MMSI, cancel the automatic distress call and make a normal voice distress call.**

## MAKING A VOICE DISTRESS CALL

**SPEAK SLOWLY — CLEARLY — CALMLY.**

For future reference, write your boat's name & call sign here:

1. Make sure your radio is on.
2. On the microphone, press the 16/9-TRI button to switch to Channel 16 (156.8 MHz). (If the corner of the display does not show 16, press the 16/9-TRI button again until it does.)
3. Press the PUSH TO TALK button on the microphone and say: *MAYDAY – MAYDAY – MAYDAY.*
4. Say *“THIS IS {name or call sign of your boat}.”*
5. Say *“MAYDAY {name or call sign of your boat}.”*
6. Tell where you are: (what navigational aids or landmarks are near, or read the latitude and longitude from your GPS).
7. State the nature of your distress, e.g. are you sinking, medical emergency, man overboard, on fire, adrift, etc.
8. Give number of persons aboard and conditions of any injured persons.
9. Estimate present seaworthiness of your ship (e.g. how immediate is the danger due to flooding or fire or proximity to shore).
10. Briefly describe your ship (length, type, color, hull).
11. Say: *“I WILL BE LISTENING ON CHANNEL 16.”*
12. End message by saying *“THIS IS {name or call sign of your boat}, OVER.”*
13. Release the PUSH TO TALK button and listen.

If you do not get an answer after 30 seconds, repeat your call, beginning at step 3, above.

## FAIRE UN APPEL DE DÉTRESSE

Soulevez le couvercle rouge. Maintenez la touche **DISTRESS** enfoncée pendant trois secondes. Votre radio transmet l'emplacement de votre bateau toutes les quelques minutes jusqu'à ce qu'il reçoive une réponse.

🔊 **REMARQUE** : Si la radio affiche *Enter User MMSI (Entrer l'ISMM de l'utilisateur)*, annulez l'appel de détresse automatique et faites un appel de détresse couvercle rouge et vocal standard.



↑  
Soulevez le couvercle rouge et appuyez sur le bouton **DISTRESS**.

## FAIRE UN APPEL DE DÉTRESSE VOCAL

**Parlez lentement – clairement – calmement.**

Pour toute référence ultérieure, transcrivez ci-dessous le nom et l'indicatif d'appel de votre bateau :

1. Vérifiez si votre radio est en marche.
2. Appuyez sur la touche **16/9-TRI** du microphone afin de commuter au canal 16 (156,8 MHz). (Si le canal 16 n'apparaît pas à l'affichage, appuyez de nouveau sur la touche **16/9-TRI** jusqu'à ce qu'il soit affiché.)
3. Appuyez sur le bouton de microphone **PUSH TO TALK** et dites : **MAYDAY – MAYDAY – MAYDAY.**
4. Donnez l'identité de votre navire en disant : "ICI {nom de votre bateau ou le numéro d'identification de votre bateau}".
5. Dites "MAYDAY {nom de votre bateau ou le numéro d'identification de votre bateau}".
6. Donnez votre position : (quels sont les points de repère ou aides à la navigation près de vous ou lisez les coordonnées de longitude et de latitude apparaissant sur votre dispositif GPS).
7. Révélez la nature de votre détresse (par exemple, nous sommes en train de couler, urgence médicale, un homme à la mer, un incendie, nous sommes à la dérive, etc.
8. Révélez la nature de l'assistance désirée (médicale, remorquage, essence, etc.)
9. Donnez le nombre de personnes à bord et les conditions des blessés, s'il y en a.
10. Donnez la condition de navigabilité actuelle de votre navire, tel que le degré de l'urgence par rapport à l'inondation, à l'incendie ou à votre proximité de la côte.
11. Donnez une brève description de votre navire en donnant le nom du bateau (par exemple, "Blue Duck est un yacht de croisière de 32 pieds, avec une coque blanche et un rouffle bleu.)
12. Dites : "JE VAIS ÉCOUTER SUR LE CANAL 16"
13. Terminez le message en disant "ICI {nom de votre bateau ou le numéro d'identification de votre bateau}". À VOUS".
14. Relâchez le bouton **PUSH TO TALK** du microphone et écoutez.

**Si vous n'obtenez pas de réponse après 30 secondes, répétez l'appel en commençant à l'étape 3 ci-dessus.**

# CÓMO HACER UNA LLAMADA DE SOCORRO

Levante la tapa roja. Mantenga oprimido el botón **DISTRESS** por tres segundos. La radio transmitirá la localidad de su nave cada cuantos minutos hasta que reciba una respuesta.



Levante la tapa roja y oprima el botón **DISTRESS**.

🗨 **Nota:** Si la radio exhibe (*Inserte el MMSI del usuario*), **cancela la llamada de socorro automática y haga una llamada de socorro normal por voz.**

## CÓMO HACER UNA LLAMADA DE SOCORRO POR VOZ

Hable despacio -- claro -- y con calma.

Para acordarse en el futuro, escriba el nombre y la señal de su nave aquí:

1. Asegúrese de que su radio está encendida.
2. En el micrófono, oprima el botón **16/9-TRI** para cambiar al canal 16 (156.8MHz).  
**(Si la esquina de la pantalla no muestra 16, oprima el botón 16/9-TRI otra vez hasta que lo haga.)**
3. Oprima el botón **PUSH TO TALK** (Oprima para hablar) en el micrófono y diga: “**MAYDAY ---MAYDAY--- MAYDAY.**”
4. Diga “**ESTE ES {nombre de su nave o la señal de su nave}.**”
5. Diga “**MAYDAY {nombre o señal de su nave}.**”
6. Describa donde se encuentra: (ayudas de navegación o marcas destacadas cercanas, o lea la latitud y la longitud en su GPS).
7. Describa la clase de su apuro, ej., se está hundiendo, emergencia médica, hombre al agua, hay fuego, está a la deriva, etc.
8. Describa el tipo de asistencia que necesita (atención médica, remolque, bombas, etc.).
9. Describa la cantidad de personas abordo y las condiciones de cualquier persona lesionada.
10. Estime la navegabilidad actual de su nave, (ej., cuanto de inmediato es el peligro de inundación o de incendio o proximidad a la costa).
11. Describa brevemente su nave (largura, tipo, color, casco).
12. Diga: “**ESTARÉ ESCUCHANDO EN EL CANAL 16.**”
13. Termine el mensaje diciendo: “**ESTE ES {nombre o señal de su nave}, OVER.**”
14. Suelte el botón **PUSH TO TALK** y escuche.

**Si no recibe una contestacion dentro de 30 segundos, repita su llamada, comenzando con el paso 3, descrito arriba.**

**Visite [www.uniden.com](http://www.uniden.com) para bajar el manual en español de la radio UM385.**

# CONTENTS

MAKING A VOICE DISTRESS CALL .....	II
FAIRE UN APPEL DE DÉTRESSE VOCAL .....	III
CÓMO HACER UNA LLAMADA DE SOCORRO POR VOZ .....	IV
<b>INTRODUCTION .....</b>	<b>1</b>
<b>FEATURES .....</b>	<b>1</b>
<b>EXPLANATION OF TERMS .....</b>	<b>1</b>
<b>GETTING STARTED .....</b>	<b>2</b>
What's Included .....	2
Parts of the Radio .....	2
Parts of the Microphone.....	3
<b>TURNING ON THE RADIO .....</b>	<b>4</b>
Setting the UIC Channel Mode (USA/CAN/INT) .....	4
<b>HOW IT WORKS .....</b>	<b>4</b>
Normal Mode Operation .....	5
Using the radio in normal mode .....	6
Scan Mode .....	7
Weather Mode .....	8
<b>USING YOUR RADIO .....</b>	<b>9</b>
Using Your Radio .....	10
Changing Display and Sound Options .....	13
Using Digital Selective Calling (DSC) Features .....	14
What is an MMSI Number?.....	15
Entering MMSI Numbers .....	15
Using the Directory.....	17
Calling a single station (Individual Call) .....	19
Receiving a DSC Call.....	21
Test Calls .....	22
Putting the Radio into Standby .....	26
Disabling Automatic Channel Switching.....	26
Renaming Channels .....	26
<b>INSTALLING THE HARDWARE .....</b>	<b>28</b>
<b>MOUNTING THE RADIO .....</b>	<b>28</b>
<b>CONNECTING THE RADIO.....</b>	<b>29</b>
Connecting the Accessory Cable.....	30
Connecting to a Chartplotter .....	32
<b>MAINTENANCE AND TROUBLESHOOTING .....</b>	<b>32</b>
<b>ENGINE NOISE SUPPRESSION .....</b>	<b>34</b>

<b>SPECIFICATIONS .....</b>	<b>35</b>
<b>RADIO SPECIFICATIONS .....</b>	<b>35</b>
<b>REFERENCE TABLES .....</b>	<b>36</b>
<b>Channel Descriptions and What They Mean.....</b>	<b>36</b>
<b>MARINE RADIO CHANNEL CHART.....</b>	<b>37</b>
<b>WEATHER CHANNELS AND FREQUENCIES (US, CAN, AND INT).....</b>	<b>41</b>
<b>EMERGENCY ALERT SYSTEM (SAME) INFORMATION .....</b>	<b>41</b>
<b>Types of Events.....</b>	<b>41</b>
<b>No Response Event Code .....</b>	<b>43</b>
<b>NMEA OPERATION .....</b>	<b>44</b>
<b>NMEA Input.....</b>	<b>44</b>
<b>NMEA Output .....</b>	<b>44</b>
<b>REGULATIONS AND SAFETY WARNINGS .....</b>	<b>45</b>
<b>MARITIME RADIO SERVICES OPERATION .....</b>	<b>45</b>
<b>BASIC RADIO GUIDELINES.....</b>	<b>45</b>
<b>FCC PART 15 / IC COMPLIANCE .....</b>	<b>45</b>
<b>FCC Part 15 .....</b>	<b>45</b>
<b>IC.....</b>	<b>46</b>
<b>ANTENNA SELECTION AND INSTALLATION .....</b>	<b>46</b>
<b>THREE-YEAR LIMITED WARRANTY .....</b>	<b>46</b>

# INTRODUCTION

## FEATURES

- Waterproof Radio – Complies with IPX4 waterproof standards, which means the radio is resistant to damage from rain or splashing water.
- Large, dot matrix display
- Advanced DSC Class D functions, including Test Calling
- Channel select buttons on the microphone
- Memory scan mode – Lets you save channels to memory and monitor them in quick succession.
- Transmitter Power Level Select – Lets you boost the transmitter power from 1 watt to 25 watts for added transmission distance.
- Battery level display and tone – Sounds an alert tone if the battery voltage goes too high or too low.
- Triple Watch Operation – Checks the Coast Guard Distress/Hailing channels 16 and 9 in the background.
- All marine VHF channels for the U.S., Canada, and international waters
- National Oceanic and Atmospheric Administration (NOAA) weather channel watch – Sounds a warning tone when a hazard alert is issued for your area.

## EXPLANATION OF TERMS

Term	What it Means
DSC	Digital Selective Calling. A VHF radio standard for communicating among boats and sending automated distress calls.
FIPS	Federal Information Processing Standard. A set of location codes roughly equivalent to your county codes.
WX	Weather Radio
GPS	Global Positioning System
NMEA	National Marine Electronics Association. The organization that governs standards for electronic equipment used on boats. NMEA 0183 is the standard for serial data communication used by GPS.
MMSI	Maritime Mobile Service Identity number. A unique, nine-digit number that identifies you and your boat when making DSC calls. It is also used by the Coast Guard if you send an automated distress call.
Station	Any DSC radio, whether it's operated on a boat, at a marina, or by a shore station.

# GETTING STARTED

## What's Included



VHF Marine Radio

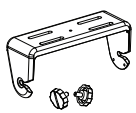

Mounting Bracket and Knobs

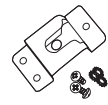

Microphone Mounting Hanger and Mounting Hardware



Mounting Hardware



DC Power Cable



Accessory Cable

## Parts of the Radio

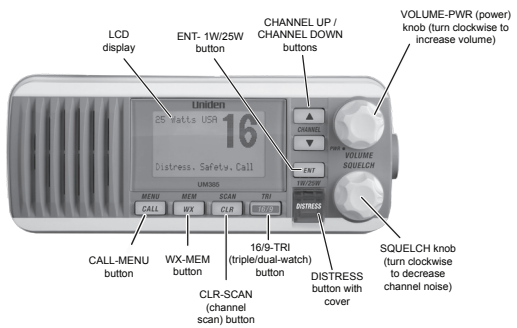

Button	Press to...	Press and hold to...
<b>ENT-1W/25W</b>	Choose an option on a menu or to display the GPS data.	Change the transmit power (see page 16).
<b>CHANNEL UP</b>	Move up one channel at a time.	Move quickly up the channels.
<b>CHANNEL DOWN</b>	Move down one channel at a time.	Move quickly down the channels.
<b>16/9-TRI</b>	1st press: Go to Channel 16. 2nd press: Go to Channel 9. 3rd press: Go back to the original channel.	Go into Triple Watch or Dual Watch mode (see page 17).



Button	Press to...	Press and hold to...
CLR-SCAN	Go to previous menu or cursor position in menu mode.	Start scanning the channels saved in memory.
WX-MEM	Listen to the current weather conditions in your area.	Save a channel into memory or remove a channel from memory.
CALL-MENU	Display the call menu.	Display the normal menu.
DISTRESS	Select the nature of your distress for a distress call.	Transmit a distress call.

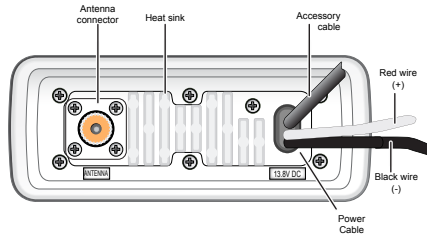

Connector/Cable	Connects to...	For details, see ...
Antenna connector	External VHF antenna with a male PL259 (SO238) connector and 50 $\Omega$ impedance. Minimum 4 ft, 3dB rated antenna for sailboats, 8 ft, 6 dB rated for power boats.	Connecting the radio (see page 39).
Power cable pigtail	Nominal 13.8 VDC power supply with negative ground (10.5 VDC to 16.0 VDC) (Red wire +, black wire -).	Connecting the radio (see page 39).
Accessory cable pigtail	GPS receiver, GPS chartplotter, External Speaker.	Connecting accessories (see page 40)

## Parts of the Microphone



## TURNING ON THE RADIO

Turn the **VOLUME-PWR** knob clockwise to turn on the radio. As it powers on, the radio displays the user MMSI number; if there is no MMSI set, the radio displays *MMSI not entered*. When it powers on, the radio selects the last channel used.

### Setting the UIC Channel Mode (USA/CAN/INT)

The radio comes preset to use the UIC channels assigned for the United States. If you are operating in an area that uses Canadian or international UIC channels, you will need to change the channel mode.

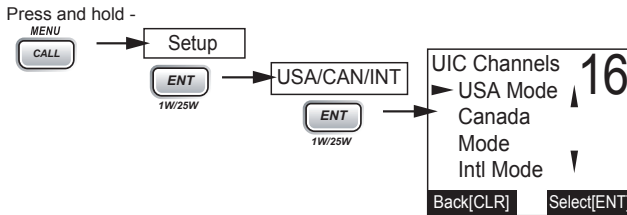

1. Press and hold **CALL-MENU** to display the normal menu, and choose the Setup sub-menu.
2. Select **USA/CAN/INT**. The screen displays the UIC channel setup.
3. Choose the channel mode you want to use: US (USA Mode), Canadian (Canada Mode), or international (Intl Mode).
4. Press **ENT-1W/25W**. The radio activates the new channel mode and exits the menu.

## HOW IT WORKS

Your radio has three basic modes of operation:

Mode	What It Does	Use It When	To Turn it on./off...
Normal	Monitors a single marine radio channel and lets you talk on that channel.	You want to talk to another station on a specific channel.	(default mode)
Scan	Monitors all the channels you save into memory.	You have a small group of channels you use most often and want to check them for traffic.	Press and hold the CLR-SCAN button.
Weather	Monitors the selected NOAA weather channel.	You want to hear the current and forecasted weather in your area.	Press the WX-MEM button.

In addition to the three basic operation modes, your radio also provides three different “watch” modes which you can activate during any of the three basic modes. In these watch modes, the radio briefly checks for activity on a specific channel then returns to its previous mode.

Watch Mode	What It Does	Use It When	To Turn it on./off...
Weather Alert	Checks for alerts on the last weather channel you used every seven seconds.	You want to be made aware of severe weather conditions in your area.	Select <i>WX-ALERT Mode</i> in Setup submenu, and then choose <i>ON</i> or <i>OFF</i> .
Triple	Checks for activity on channels 16 and 9 every two seconds.	You want to monitor a channel yet maintain a watch on channels 16 and 9.	Press and hold <b>16/9-TRI</b> for two seconds.
Dual	Checks for activity on channel 16 every two seconds.	You want to monitor a channel yet maintain a watch on channel 16.	Change Triple Watch to Dual Watch in the Setup menu, then press and hold <b>16/9-TRI</b> for two seconds.

⚠ **NOTE: You are required to monitor channel 16 whenever your boat is underway. You should have either Triple Watch or Dual Watch on at all times.**

## Normal Mode Operation

Normal mode monitors whatever channel you select, and you can transmit on that channel also. While using normal mode, the display lets you see the following information (not all indicators will display at the same time):

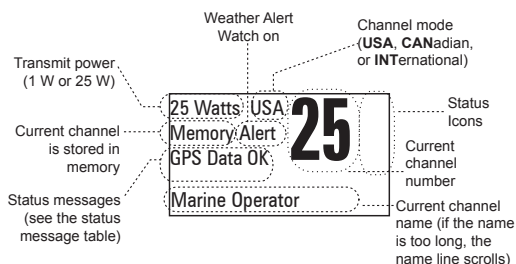

Message	Meaning
GPS Data OK	The radio is receiving valid GPS data.
Check GPS	The radio is not receiving valid GPS data: check the GPS status screen and the GPS connection.
Input Position	The radio has been unable to receive valid GPS data for at least four hours; it can no longer track your position. You need to manually input your position (see Setting the GPS position manually on page 19).
Battery Low	The battery voltage output is too low (below 10.5 VDC).
Battery High	The battery voltage output is too high (above 16.0 VDC).

## Using the radio in normal mode

- To transmit, press and hold **PUSH TO TALK** on the microphone. Release the button when you are finished talking.
- For the best sound quality, hold the microphone about two inches from your mouth while you're talking.
- Press **CHANNEL UP** on the radio or the microphone to move up one channel at a time. Press and hold either button to scroll quickly up the channels.
- Press **CHANNEL DOWN** on the radio or the microphone to move down one channel at a time. Press and hold either button to scroll quickly down the channels.
- To change the transmit power, press and hold **ENT-1W/25W** for two seconds. The transmit power switches between 1 watt and 25 watts each time you press and hold **ENT-1W/25W**.

### Normal mode with Weather Alert Watch

If you activate Weather Alert Watch while operating in normal mode, the radio checks the most recently-used weather channel every seven seconds. If it detects a weather alert for your area, it will change the channel to the last-used weather channel. The radio will not check the weather channel while you are actively transmitting; it waits until your transmission is finished and then checks the weather channel.

To turn Weather Alert Watch on or off, press and hold **CALL-MENU** while the radio is idle. Select *Setup* and then *WX-Alert Mode*. Use **CHANNEL UP** and **CHANNEL DOWN** to choose *WX Alert Mode* setting *ON* or *Off*.

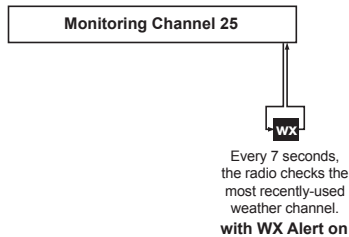

### Normal mode with Triple and Dual Watch

If you activate Triple Watch while operating in normal mode, the radio checks channels 16 and 9 every two seconds; with Dual Watch turned on, the radio only checks channel 16. The radio will not check channels 16 or 9 while you are actively transmitting; it waits until your transmission is finished and then checks the channels.

Press and hold **16/9-TRI** (on the radio or the microphone) for two seconds to turn Triple/Dual Watch on or off. (To change between Triple or Dual Watch, see page 17.)

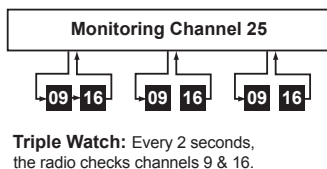

## Normal mode with both Weather Alert and Triple/Dual Watch

You can activate Weather Alert Watch and Triple/ Dual Watch at the same time. The radio performs both checks at their scheduled time.

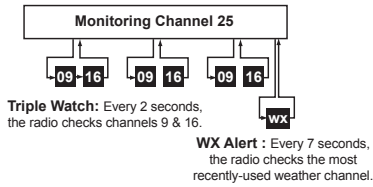

## Scan Mode

You can save channels into memory and then use scan mode to monitor those channels. When the radio detects a signal on a channel, it pauses on that channel as long as the signal is received; when the transmission stops, the radio will continue scanning.

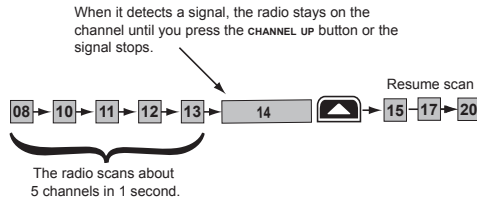

In scan mode, you can get the following information from the display (some indicators will not always be displayed).

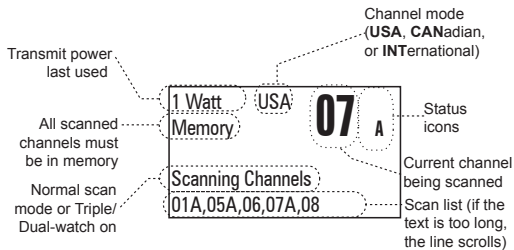

## Using the radio in scan mode

- You cannot transmit while in scan mode.
- You must have two or more channels in memory to start a scan.
- To save a channel into memory, select the channel, then press and hold **WX-MEM** for two seconds. Memory will show on the display.
- To remove a channel from memory, set the radio to that channel, then press and hold **WX-MEM** for two seconds. Memory will no longer show on the display.
- To activate scan mode, press and hold **CLR-SCAN**. Press and hold **CLR-SCAN** again to return to the previous mode.
- When the radio automatically stops on a channel, press **CHANNEL UP** to leave that channel and resume scanning.

- To end the scan, press the microphone's **PUSH TO TALK, CALL-MEM, or WX-MEM** buttons. The radio remains on the last scanned channel.

### Scan mode with Weather Alert Watch

If you activate Weather Alert Watch while operating in scan mode, the radio checks the most recently-used weather channel every seven seconds, then continues scanning the next channel in memory.

To turn Weather Alert Watch on or off, press and hold **CALL-MENU** while the radio is idle. Select Setup and then WX-Alert Mode. Use **CHANNEL UP** and **CHANNEL DOWN** to choose WX Alert Mode setting On or Off.

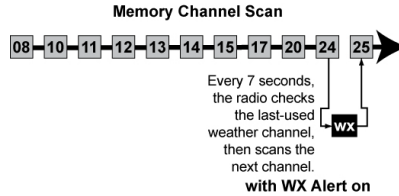

### Scan mode with Triple and Dual Watch

If you activate Triple Watch while operating in scan mode, the radio checks channels 16 and 9 every two seconds, then goes on to scan the next channel; with Dual Watch turned on, the radio only checks channel 16.

Press and hold **16/9-TRI** (on the radio or the microphone) for two seconds to turn Triple/Dual Watch on or off. (To change between Triple or Dual Watch, see page 17.)

Press and hold the **CLR-SCAN** key to turn off Scan mode and set the radio to Triple/Dual Watch mode.

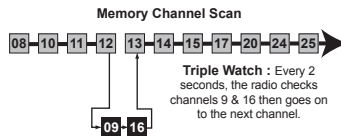

### Scan mode with both Weather Alert and Triple/Dual Watch

You can activate Weather Alert Watch and Triple/Dual Watch at the same time. The radio performs both checks at their scheduled time.

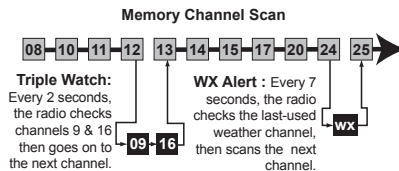

## Weather Mode

In cooperation with the FCC, NOAA also uses the weather channels to alert you of other hazards besides weather (child abduction alerts, nuclear, biological, etc.). In weather mode, the radio monitors one of the ten NOAA weather channels. If any type of alert is received for your area, the radio sounds an alert tone and displays the type of alert. In weather mode, the display shows the following:

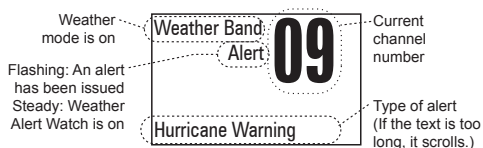

### Using the radio in weather mode

- You cannot transmit while in weather mode.
- To enter weather mode, press **WX-MEM**.
- Weather mode can filter out alerts that do not affect your location if the location code (FIPS code) of the alert is entered in your radio (see page 17). If you have no FIPS codes programmed into your radio, the radio will notify you of all alerts in any area.
- To turn off the radio’s alert tone, press any button.
- To cancel weather mode and return to the previous marine channel, press the **WX-MEM** button again.

### Weather mode with Weather Alert Watch

Because weather mode already monitors the weather channels, you don’t need Weather Alert Watch to check the weather channel every seven seconds. If you activate Weather Alert Watch while operating in weather mode, it operates as a type of “sleep mode”: the radio stays on the weather channel and mutes the speaker. If an alert is detected for your area, the radio sounds an alert tone and turns the speaker back on. This mode is very useful when you are anchoring for the night but want to stay informed of any hazards in your area.

To turn Weather Alert Watch on or off, press and hold **CALL-MENU** while the radio is idle. Select *Setup* and then *WX-Alert Mode*. Use **CHANNEL UP** and **CHANNEL DOWN** to choose WX Alert Mode setting *On* or *Off*.

### Weather mode with Triple and Dual Watch

If you activate Triple Watch while operating in weather mode, the radio checks channels 16 and 9 every two seconds; with Dual Watch turned on, the radio only checks channel 16. Press and hold **16/9-TRI** (on the radio or the microphone) for two seconds to turn Triple/Dual Watch on or off. (To change between Triple or Dual Watch, see page 17.)

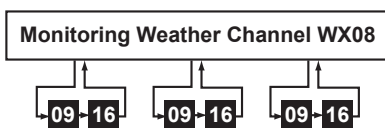

**Triple Watch:** Every 2 seconds, the radio checks channel 9, then channel 16.

## USING YOUR RADIO

To display the radio call menu, press **CALL-MENU**. To display the radio normal menu, press and hold **CALL-MENU**. The menu has the following options:

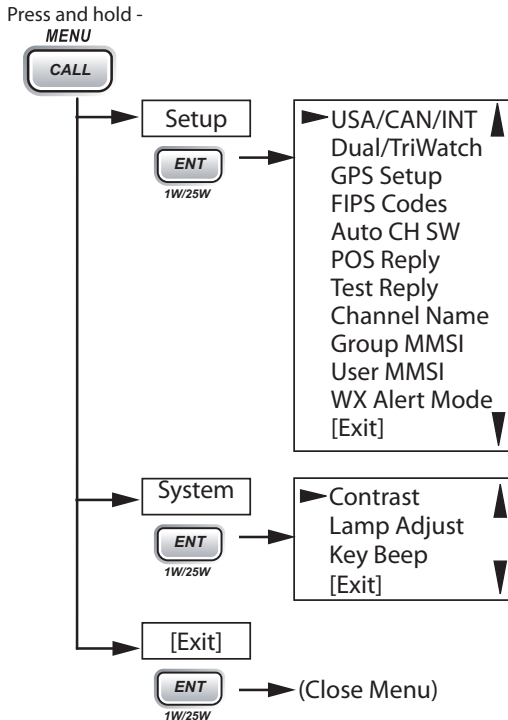

## Using Your Radio

- An arrow on the left side indicates the current selection.
- Press **CHANNEL UP** on the radio or the microphone to move up a line in the menu; if you are at the top line in the menu, the cursor jumps to the bottom of the menu.
- Press **ENT-1W/25W** to choose the selected item.
- Press **CHANNEL DOWN** on the radio or the microphone to move down a line in the menu; if you are at the bottom line of the menu, the cursor jumps to the top of the menu.
- Press **CLR-SCAN** to go back to the previous menu screen.
- From any menu screen, choose *Exit* or press and hold **CALL-MENU** to close the menu screen.

## Making a Voice MAYDAY Call

(see inside front cover)

## Setting the Volume

Turn the volume knob clockwise to increase the speaker volume; turn it counter-clockwise to decrease the volume.

## Setting the Squelch Level

The squelch feature reduces the level of static on the speaker by filtering out the background channel noise. At the lowest squelch level, the speaker plays all radio signals,



including any noise on the channel. Setting the squelch level higher filters out channel noise and lets only actual radio transmissions through.

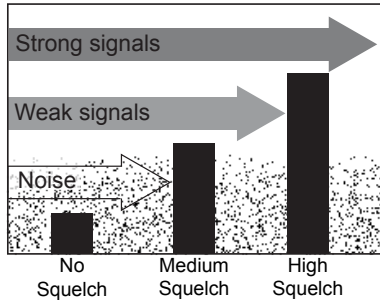

While listening to a channel, adjust the **SQUELCH** knob until the noise is filtered out and you can only hear the transmission. If you switch to a channel with a lot of noise or with a weak transmission, you may need to adjust the squelch level again.

🔊 **NOTE: Setting the squelch level too high may prevent you from hearing weaker transmissions. If you are having difficulty hearing a transmission, try setting the squelch level lower.**

### **Changing the Channel**

Press **CHANNEL UP** and **CHANNEL DOWN** briefly to scroll through the channels one channel at a time. Press and hold **CHANNEL UP** or **CHANNEL DOWN** to quickly scroll through the channels.

### **Making a Transmission**

To make a transmission, press and hold the microphone **PUSH TO TALK** button. Release the **PUSH TO TALK** button when you're finished talking to let the other party respond.

- To prevent stuck microphone problems or situations where **PUSH TO TALK** is pushed accidentally, the radio limits your talk time to 5 minutes in a single transmission. If you talk for over 5 minutes continuously, the display shows *RELEASE MIC BUTTON*.
- For the best sound quality, hold the microphone about two inches away from your mouth.
- You cannot transmit while the radio is in weather mode or scan mode.
- See the channel lists beginning on page 36 for a list of receive-only channels.

### **Boosting the Transmission Power**

In most situations, the 1 Watt transmission power is all you need. If you find yourself far away from other stations and have trouble getting a response, you may need to boost the transmission power from 1 Watt to 25 Watts:

1. Select the channel you want to transmit on.
2. Push and hold **ENT-1W/25W** for two seconds. The display shows *25 Watts* in the upper left hand corner.
3. The transmit power remains at 25 Watts until you change the setting back. Push and hold **ENT-1W/25W** for two seconds. The display shows 1 Watt.

- 🔊 **NOTE: Don't forget to change the transmission setting back to 1 Watt when you move closer to other stations.**
- 🔊 **NOTE: By default, when you change to channel 16, the radio automatically boosts the power to 25 Watts. Be sure to change the power back to 1 Watt if you are not making an emergency transmission.**

Some channels (for example, channels 13 and 67) limit the power of transmission to 1 Watt so that there is less interference between boaters attempting to use the channel at the same time. If you switch to one of these channels, the radio changes back to 1 Watt automatically. See the channel lists beginning on page 36 for a list of power-restricted channels.

### Choosing Triple Watch or Dual Watch

In Triple Watch mode, the radio briefly checks channels 16 and 9 every two seconds. In Dual Watch mode, the radio checks channel 16 only. Generally, Triple Watch is used in areas where channel 9 is used as a hailing frequency while Dual Watch is used in areas where channel 16 is used for distress and hailing. Your radio comes set to use Triple Watch; if you want to use Dual Watch instead, you will have to select it in the setup:

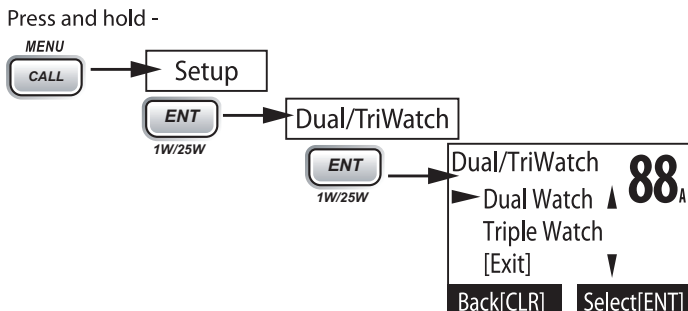

1. Press and hold **CALL MENU** to display the normal menu.
2. Select *Setup* and then *Dual/Tri Watch*.
3. Choose *Dual Watch* and press **ENT-1W/25W**. The radio activates the new setting and returns to the Setup menu.
4. To reactive Triple Watch, repeat the procedure described above, but choose Triple Watch in step 3.

### Using FIPS Codes for Weather Alerts

The US National Weather Service established 6-digit Federal Information Processing System (FIPS) codes to issue weather alerts in specific areas. You can choose which areas you want to hear alerts for by entering these FIPS codes in your radio. This can prevent you from being bothered by events that are far from where you are boating. The radio only sounds the alert tone if an incoming FIPS code matches one of the areas you selected.

- For more information about how the NWS uses FIPS codes, see the NWS website: [www.nws.noaa.gov/nwr/nwsfipschg.htm](http://www.nws.noaa.gov/nwr/nwsfipschg.htm).
- To see an index of FIPS codes by state, see the website of the National Institute of Standards and Technology (NIST): [www.itl.nist.gov/fipspubs/co-codes/states.htm](http://www.itl.nist.gov/fipspubs/co-codes/states.htm).

- For information on the Canadian implementation of FIPS codes, called Canadian Location Codes, see the website of the Meteorological Service of Canada (MSC): [http://www.msc.gc.ca/msb/weatheradio/transmitter/index\\_e.cfm](http://www.msc.gc.ca/msb/weatheradio/transmitter/index_e.cfm)

**NOTE:** If you travel outside the areas you have entered into your radio, you may not hear alerts that affect your new location. Be sure to enter the FIPS codes of all the areas you plan to travel to during this trip.

Follow the steps below to edit the list of FIPS codes. You can store up to 30 different FIPS codes in your radio.

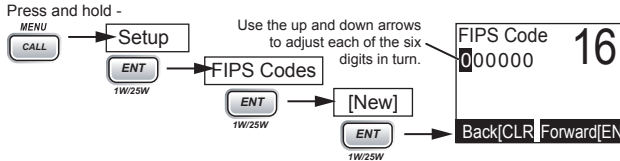

1. Display the normal menu and choose the Setup sub-menu.
2. Select *FIPS Codes*. The screen displays any previously-entered FIPS codes.
3. To add a new FIPS code, select *New*.
4. Use **CHANNEL UP** and **CHANNEL DOWN** to change the first of the six digits; **CHANNEL UP** increases the number and **CHANNEL DOWN** decreases it.
5. When the first digit is correct, press **ENT-1W/25W**. The cursor moves to the next digit. Enter the remaining five digits of the FIPS code in the same way. If you make a mistake while entering a digit, press **CLR-SCAN** to erase the wrong number and moved the cursor to the left digit.
6. When the sixth digit is correct, press **ENT-1W/25W**. The radio displays the new FIPS code and asks you to confirm. To save this code, select *Yes*; to cancel this code, select *No*. The radio returns to the list of FIPS codes.
7. To change an existing FIPS code, select the code you want to change.
8. To delete the FIPS code, select *Delete*. To edit the code, select *Edit*, then use **CHANNEL UP** and **CHANNEL DOWN** buttons to change each of the six digits.
9. When you are satisfied with the list of FIPS codes, select *Exit* to close the menu screen.

## Changing Display and Sound Options

### Contrast

Your radio display has 10 levels of contrast. To adjust the contrast, press and hold **CALL-MENU** while the radio is idle. Select *System* and then *Contrast*. Use **CHANNEL UP** and **CHANNEL DOWN** to change the contrast to your desired level.

To restore the default contrast setting, turn the radio off. Press **CALL-MENU** and hold it in while you turn the radio on.

### Lamp adjust

Your radio has 10 brightness levels on the display. To adjust the brightness, press and hold **CALL-MENU** while the radio is idle. Select *System* and then *Lamp Adjust*. Use **CHANNEL UP** and **CHANNEL DOWN** to change the brightness to your desired level.

## Turning the key beep on and off

Key beep is the tone that sounds when you press a key or a button. To turn off the key beep, press and hold **CALL-MENU** while the radio is idle. Select *System* and then *Key Beep*. Choose **OFF** to turn off the key beep.

## Setting the GPS Position Manually

If the radio is not receiving valid GPS data, the radio displays *Input Position*. Follow the steps below to manually input your position.

⚠ **NOTE: Be certain any manually-entered position is correct. If you enter the wrong position and then make a DSC distress call, you will be telling the arrows to adjust each of the values in turn.**

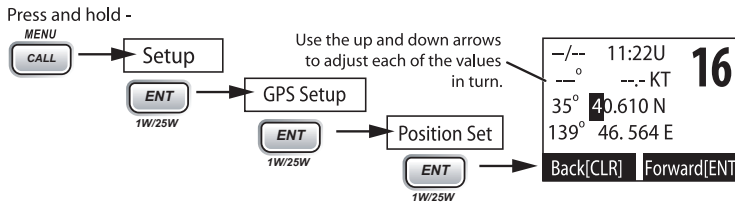

1. Display the normal menu and choose the Setup sub-menu.
2. Select *GPS Setup* and then choose *Position Set*.
3. The GPS manual input screen displays; the fields to be entered blink. The cursor highlights the hour. Use **CHANNEL UP** and **CHANNEL DOWN** to set the displayed hours to match coordinated universal time (UTC, also call Greenwich Mean Time and Zulu Time). When the display matches UTC time, press ENT-1W/25W. If you make a mistake while entering a digit, press **CLR-SCAN** to erase the wrong number and moved the cursor to the left digit.
4. The cursor moves to highlight the minutes. Use **CHANNEL UP** and **CHANNEL DOWN** to adjust the minutes and press ENT-1W/25W.
5. The cursor moves to highlight the degrees latitude. As you update each value, the cursor moves to the next value in turn. At each number, use **CHANNEL UP** and **CHANNEL DOWN** to adjust the number and press ENT-1W/25W.
6. When you have entered the last value, the radio returns to the GPS Setup menu.

## Using Digital Selective Calling (DSC) Features

### What is DSC?

Digital Selective Calling (DSC) is a standard that allows you to call other stations using their unique identification code (the Maritime Mobile Service Identity or MMSI number), just like you would call a phone number. To call another station, just enter that station's MMSI number and choose the voice channel you want to talk on. The radio uses channel 70 to transmit your MMSI number to the other station along with the voice channel you requested. If the other station accepts your call, both radios automatically switch to the requested voice channel so you can talk to the other station.

DSC provides a system for automated distress calls. At the touch of a button, the radio can transmit your MMSI number, the nature of your distress, and your current position based on data from your GPS receiver. The radio repeats the distress call every few minutes until it receives an acknowledgement.

The DSC standard dedicates a VHF channel—channel 70—to digital transmissions only. Since digital transmissions require less bandwidth voice transmissions, channel 70 avoids the problems of busy voice channels.

### **Advanced DSC Features**

Your radio supports the following DSC features:

<b>Feature</b>	<b>Menu Item</b>	<b>Function</b>
Individual Call	Individual	Contact another vessel from your directory.
Group Call	Group	Contact all vessels that share your group MMSI code.
All Ships Call	All Ships	Broadcast to all vessels within range (used for safety or advisory messages).
Position Request	POS Request	Request the current location of another vessel.
Position Send	Position Send	Transmit your current location to another vessel.
Test Call	Test	Make sure your radio is working and configured correctly.
Name and MMSI Directory	Directory	Store a list of 20 names and MMSI identification codes for DSC calls.
Standby Mode	Standby	Automaticcally respond to all DSC calls within an “Unavailable” status.
Received Call Log	Receive Log	Display the last 10 distress calls received by the radio and the last 20 general calls.

### **What is an MMSI Number?**

In order to use DSC features, you must be assigned an MMSI number and program that number into your radio. There are two kinds of MMSI numbers: individual numbers for use by single boats and group numbers for use by fleets, boating organizations, event coordinators, etc.

You can get more information on MMSI numbers at these resources:

- The dealer where you purchased the radio
- Recreational boaters can obtain an MMSI number from the Boat Owner’s Association of the U.S. (<http://www.boatus.com/mmsi/> or call 800-563-1536) or Sea Tow Services International ([http://seatow.com/boating\\_safety/mmsi.asp](http://seatow.com/boating_safety/mmsi.asp))
- Commercial boaters need a ship station license to get an MMSI number. For more information, visit the Federal Communications Commission (FCC) website at <http://wireless.fcc.gov/marine/fctsht14.html>.

### **Entering MMSI Numbers**

#### **Individual or User MMSI Number**

NOTE: Be sure you have the correct User MMSI number before entering it in the radio. The radio only allows you to enter the user MMSI once. If you need to re-enter the User MMSI number, Visit our website for assistance at [www.uniden.com](http://www.uniden.com).

Follow the steps below to enter your individual or user MMSI number into the radio:

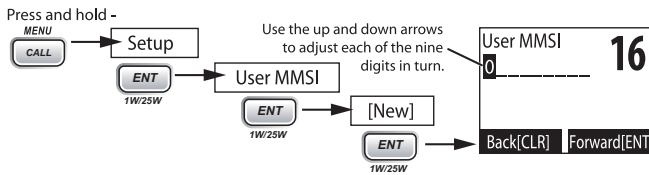

1. Display the normal menu and choose the Setup sub-menu.
2. Select *User MMSI*. (If an MMSI number was already entered, the screen displays it with the message *Cannot change over 1 time*. Visit our website for assistance at [www.uniden.com](http://www.uniden.com).)
3. Use **CHANNEL UP** and **CHANNEL DOWN** to enter the first of the nine digits; **CHANNEL UP** increases the number and **CHANNEL DOWN** decreases it.
4. When the first digit is correct, press **ENT-1W/25W**. The cursor moves to the next digit. Enter the remaining eight digits of the MMSI number in the same way. If you make a mistake while entering a number, press **CLR-SCAN** to erase the wrong number and the cursor is moved to the left digit.
5. When the ninth digit is correct, press **ENT-1W/25W**. The radio displays the new MMSI number and asks you to confirm.

NOTE: Be sure you entered the number correctly before confirming the entry. You can only save the user MMSI once.

6. To save this MMSI number, select Yes, then confirm the number. To cancel this MMSI number, select No. The radio returns to the Setup menu.

### Group MMSI number

You can change the group MMSI number as often as you want. Follow the steps below to enter a group MMSI number into the radio:

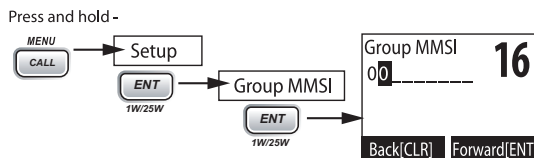

1. Display the normal menu and choose the Setup sub-menu.
2. Select *Group MMSI*. If one was entered previously, the screen displays it.
3. Group MMSI numbers always start with a 0, so that digit is already entered for you. Use **CHANNEL UP** and **CHANNEL DOWN** to change the second of the nine digits; **CHANNEL UP** increases the number and **CHANNEL DOWN** button decreases it.
4. When the second digit is correct, press the **ENT-1W/25W**. The cursor moves to the

next digit. Enter the remaining seven digits of the MMSI number in the same way. If you make a mistake while entering a number, press **CLR-SCAN** to erase the wrong number and the cursor is moved to the left digit.

- When the ninth digit is correct, press **ENT-1W/25W**. The radio displays the new MMSI number and asks you to confirm.
- To save this MMSI number, select *Yes* and confirm the entry. To cancel this MMSI number, select *No*. The radio returns to the Setup menu.

## Using the Directory

The directory lets you store up to 20 MMSI numbers of other stations so you can call them quickly.

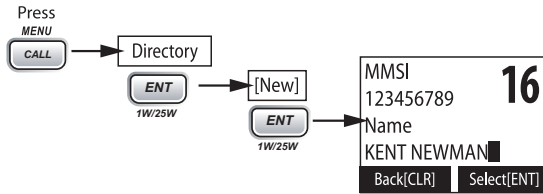

Follow the steps below to edit the MMSI numbers in your directory:

- Press **CALL-MENU** to display the call menu.
- Select *Directory*. The screen displays any previously-entered MMSI numbers and names.
- To add a new MMSI number to the directory, select *New*.
- The radio prompts you to enter the nine-digit MMSI number. Use **CHANNEL UP** and **CHANNEL DOWN** to change the first digit; the **CHANNEL UP** button increases the number and the **CHANNEL DOWN** button decreases it.
- When the first digit is correct, press **ENT-1W/25W**. The cursor moves to the next digit. Enter the remaining eight digits of the MMSI number in the same way. If you make a mistake while entering a number, press **CLR-SCAN** to erase the wrong number and the cursor is moved to the left digit.
- When the ninth digit is correct, press **ENT-1W/25W**.
- The radio prompts you to enter a name for this MMSI number; the name is what you will see in the directory list. Each name can be up to 12 characters. Use **CHANNEL UP** and **CHANNEL DOWN** to change the first character. The channel buttons scroll through the available characters according to the following table:

Channel Up Button	Channel Down Button
Capital letters (A through Z)	One blank space
Lower-case letters (a through z)	Numbers (0 through 9)
Punctuation (/ ' + -)	Punctuation (/ ' + -)
Numbers (0 through 9)	Lower-case letters (a through z)
One blank space	Capital letters (A through Z)

8. When the first character is correct, press **ENT-1W/25W** button. The cursor moves to the next character. Enter the remaining 11 characters of the name. If the name is shorter than 12 characters, press and hold **ENT-1W/25W** to complete the name entry. (If you press and hold **ENT-1W/25W** without entering a name, the radio uses the MMSI number in the directory list.) If you make a mistake while entering a number, press **CLR-SCAN** to erase the wrong number and the cursor is moved to left digit.
9. When you finish entering the name, the radio displays the new MMSI number and name and asks you to confirm. To save this directory entry, select *Yes*; to cancel this directory entry, select *No*. The radio returns to the directory list.
10. To change an existing directory entry, select the entry you want to change.
11. To delete the directory entry, select *Delete*. To edit the code, select *Edit*, then use **CHANNEL UP** and **CHANNEL DOWN** to edit the MMSI number and the name.
12. When you are satisfied with the directory list, select *Exit* to close the menu screen.

### **Making DSC Calls**

There are essentially four different types of DSC voice calls:

<b>Call type</b>	<b>What it does</b>	<b>When to use it</b>
Distress	Alerts all stations that you need assistance and sends them your current position.	In an emergency only.
Individual	Calls a single station using the User MMSL.	Any time you want to talk to another station.
Group	Calls all the stations that have the same Group MMSL as yours.	Any time you want with the whole group you are traveling with at the same time.
All Ships	Calls all stations within range of your radio.	Safety warnings (e.g., debris in the water) or any urgent situation.

Suppose you are coordinating safety for a sailboat race. Before the race starts, you instruct all the racers to enter your group MMSI number into their radios. During the race:

- Throughout the race, you use group calling to update the racers on the time, race status, and any course corrections.
- A power boat full of spectators comes a little too close to the race path. You use individual calling to contact the power boat and advise them to stay clear of the race.
- You see a rowboat entering the area, but since it doesn't have a radio, you can't communicate with the rowboat. You use all ships calling to alert all the other boats in the area of the possible danger.



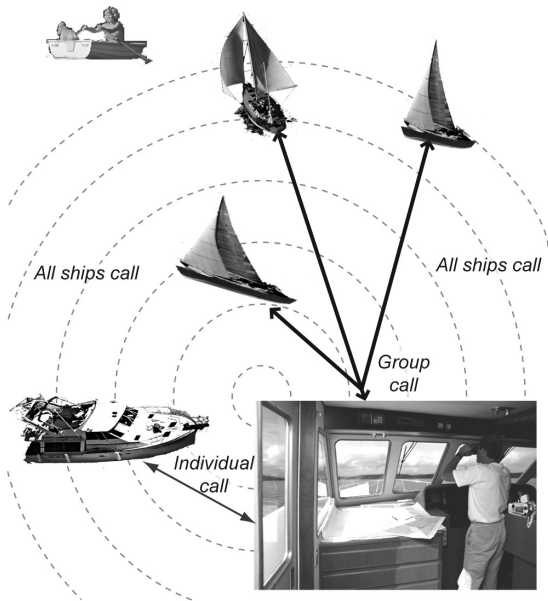

## Calling a single station (Individual Call)

To call a single station with DSC, follow the steps below:

1. Press **CALL-MENU** to display the call menu.
2. Select *Individual*.
3. The radio displays the names listed in your directory; use **CHANNEL UP** and **CHANNEL DOWN** to choose the directory entry you want to call and press **ENT-1W/25W**. If you want to call a station that is not in your directory, select *Manual*. The radio prompts you to enter the MMSI number you want to call. Enter the MMSI number the same way you enter directory entries (see page 22) Enter all nine digits and press **ENT-1W/25W**.
4. The radio prompts you to select a response channel. Use **CHANNEL UP** and **CHANNEL DOWN** to scroll through the available channels. When you reach the channel you want to use for a response, press the **ENT-1W/25W** button.
5. The radio displays the MMSI number you are about to call and asks you to confirm. If you want to call the displayed MMSI number, select *Send*. To cancel the call, select *Cancel*.
6. The radio automatically switches to channel 70 to transmit the call request.
  - When the other station accepts the call, both radios switch to the selected response channel for voice transmission.
  - If the other station cannot respond on the channel you selected, the radio displays *Not support CH*.

### **Calling a particular group of stations (Group Call)**

Group calling calls all the stations that share your group MMSI. You must have a group MMSI programmed into the radio to make a group call, and the stations (boats) you are calling must have this same group MMSI programmed into their radios.

1. Press **CALL-MENU** to display the call menu.
2. Select *Group*.
3. The radio prompts you to select a response channel. Use **CHANNEL UP** and **CHANNEL DOWN** to scroll through the available channels. When you reach the channel you want to use for a response, press **ENT-1W/25W**.
4. The radio asks you to confirm the call. Select *Send* to continue with the call or select *Cancel* to cancel the call.
5. The radio switches to channel 70 to transmit the call request then automatically switches to the designated response channel.

### **Calling all stations (All-Ships Call)**

All ships calling contacts all DSC radios within range of your boat. You should only use all ships calling in the event of a Safety warning (such as debris in the water) or to request assistance in an Urgency (any situation where your vessel has a serious problem but is not yet in distress).

1. Open the call menu.
2. Select *All Ships*, and then choose whether this is an Urgency call or a Safety call.
3. The radio asks you to confirm the call. Select *Send* to continue with the call or select *Cancel* to cancel the call.
4. The radio automatically switches to channel 70 to transmit the call request then automatically switches to channel 16, the designated response channel for all-ships calling.

### **Making an Automatic Distress Call**

If you have programmed your MMSI number, your radio can transmit an automated distress call with your current location and nature of the distress. The radio then monitors the channel 16 for a response and repeats the distress call every few minutes until it receives an acknowledgement.

🔊 **NOTE: To send an automatic distress call, press and hold DISTRESS for three seconds. If no MMSI number has been programmed, the radio prompts you to enter your MMSI number.**

If you want to include the nature of your distress in the distress call, use the following distress procedure:

1. Press **DISTRESS**.
2. The radio displays the list of distress conditions; use **CHANNEL UP** and **CHANNEL DOWN** to choose the nature of your distress, then press and hold **DISTRESS** for three seconds.

Undesignated	Sinking	Fire
Adrift	Flooding	Abandoning

Collision	Piracy, Armed	Grounding
Overboard	Capsizing	

3. If no MMSI number has been programmed, the radio prompts you to enter your MMSI number.

### Canceling an automatic distress call

While the radio is waiting for a response, it gives you the option of canceling the call. To cancel the distress call, choose *Cancel* and press **ENT-1W/25W**.

### Receiving a DSC Call

If your radio receives an individual DSC call from another station, it sounds an incoming call tone and displays the name or MMSI number of the station calling you. To respond to the call, select *Send: Able-Comply*; the radio sends an acknowledgement and automatically switches to the designated response channel. To reject the call, select *Send: Unable-Comply*; the radio advises the other station that you are unable to respond to the call.

If the DSC request contains a response channel that you are not allowed to use, the radio displays *Not Support CH*; your only response option is *Send: Unable-Comply*.

If the radio receives a group or all ships call, it sounds an incoming call tone and automatically switches to the designated response channel.

### Receive log

Just like your telephone's caller ID list, your radio keeps track of the calls you receive but do not answer. The receive log is useful if you have been off your boat or away from your radio and want to see who has tried to contact you. The radio displays the last 10 distress calls and the last 20 non-distress calls that it received. If you have unread incoming DSC calls, the radio displays a Message icon. When you display all Distress and Other receiving logs, the message icon disappears.

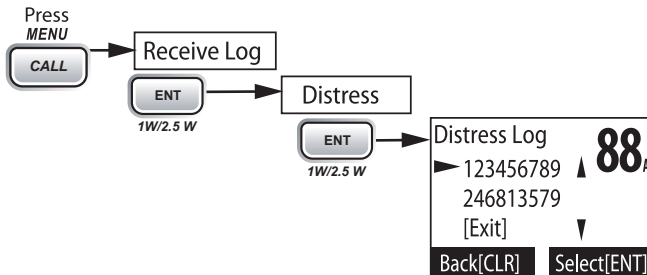

1. Press **CALL-MENU** to display the call menu.
2. Select *Receive Log*.
3. Select *Distress* to see the last 10 distress call received by the radio. Select *Other* to see the last 20 normal calls received by the radio, then choose from *Individual*, *Group*, or *All Ships* calls.
4. Calls are listed in the order they were received, with the newest call shown first. The display blinks if there are new calls you have not reviewed.

5. Select the call you want to see the details of. Use **CHANNEL UP** and **CHANNEL DOWN** to see all of the information. The log displays different information depending on type of call received. See the table below for the information stored for each type of call:

DSC Call Type	Receive Log Information
Distress	MMSI (or name), position, time, nature code.
Distress Acknowledge	MMSI (or name), distress MMSI, position, time, nature code.
Distress Relay	MMSI (or name), distress MMSI, position, time, nature code.
Distress Relay Acknowledge	MMSI (or name), distress MMSI, position, time, nature code.
Geographical	MMSI (or name), category code, communication channel number.
All Ships	MMSI (or name), category code, communication channel number.
Group	MMSI (or name), category code, communication channel number.
Individual	MMSI (or name), category code, communication channel number.
Individual Acknowledge	MMSI (or name), Completed/Unattended, category code, communication channel number.
Test	MMSI (or name), category code.
Test Acknowledge	MMSI (or name), category code.
Pos Reply	MMSI (or name), position, time, category code.
Pos Request	MMSI (or name), category code.
Pos Send	MMSI (or name), position, time, category code.

6. Press **CLR-SCAN** button to exit the detail screen and return to the log menu.
7. From the log menu, select *Exit* to close the receive log and return to the mode you were in.

### **Returning a call**

You can return individual calls directly from the receive log. From the call detail screen, press **CHANNEL DOWN** until *Call Back* appears at the bottom of the display. Press **ENT-1W/25W** to return that station's call.

## **Test Calls**

### **Making Test Calls (Test)**

You can use the test call feature to make sure your radio is working and configured correctly. To avoid overloading coastal receiving stations, you should limit test calls to these stations to once a week.

- ⚠ **NOTE:** Many coastal stations have specific frequencies and MMSI numbers you should use for making test calls. Before making a test call to a coastal station, be sure to check the **Local Notice to Mariners (LNM)**, issued every week by the US Coast Guard. The LNMs for each region are available online at <http://www.navcen.uscg.gov/lnm/default.htm>.

1. Press **CALL-MENU** to display the call menu.

2. Select *Test*.
3. The radio displays the names listed in your directory; use **CHANNEL UP** and **CHANNEL DOWN** to choose the directory entry you want to send a test call to and press **ENT-1W/25W** button. If you want to send a test call to a station that is not in your directory, select *Manual*. The radio prompts you to enter the MMSI number you want to call. Enter the MMSI number the same way you enter directory entries (see page 22). Enter all nine digits and press **ENT-1W/25W** button.

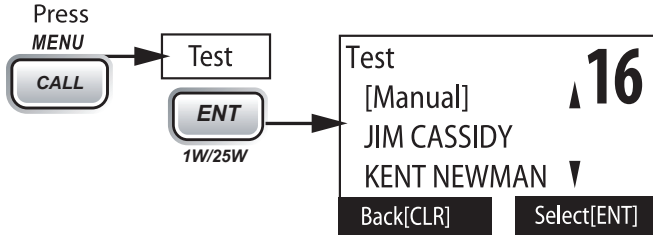

4. The radio displays the MMSI number you are about to call and asks you to confirm. If you want to call the displayed number, select *Send*. To cancel the call, select *Cancel*.

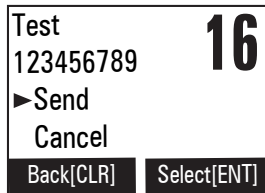

5. The radio automatically switches to channel 70 to transmit the test call request, then switches back to the last-used channel.
6. When the other station acknowledges the test call, the radio displays an acknowledgement screen.

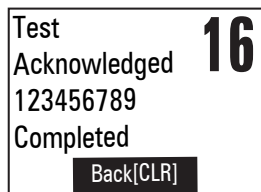

### Receiving Test Calls

When another station sends you a test call, the radio displays the test request screen.

- To acknowledge the test call, select *Reply*.
- To reject the test call, select *Cancel*.

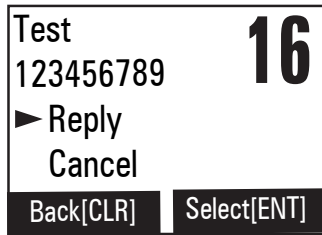

### Enabling automatic test call reply

If you want the radio to automatically reply to all test call, you can enable automatic test call reply.

1. Press and hold **CALL-MENU** to display the normal menu.
2. Select *Setup* and then *Test Reply*. Choose *Auto* and press **ENT-1W/25W**. The radio will automatically send an acknowledgement when it receives a test call.

Press and hold -

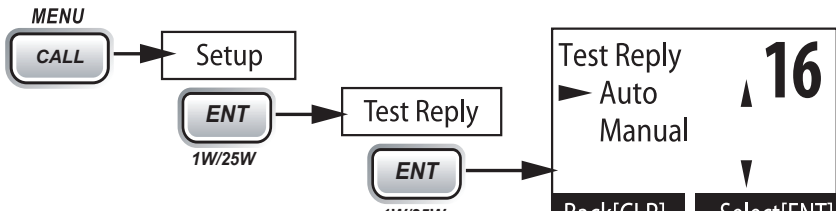

3. To disable automatic test call reply, repeat the steps above and select *Manual*.

### Position Request and Reply

Requesting another station's position (POS Request)

Anytime you need to know where another boat currently is—to find your boating partners, to respond to a request for assistance, etc.—you can send a position request to their radio:

1. Press **CALL-MENU** to display the call menu.
2. Select *DSC Call* sub-menu, then select *POS Request*.
3. The radio displays the names listed in your directory; use **CHANNEL UP** and **CHANNEL DOWN** to choose the directory entry you want to contact and press **ENT-1W/25W**. If you want to contact a station that is not in your directory, select *Manual*. The radio prompts you to enter the MMSI number you want to call. Enter the MMSI number the same way you enter directory entries (see page 22). Enter all nine digits and press **ENT-1W/25W**.
4. The radio displays the MMSI number you are about to contact and asks you to confirm. If you want to request the position of the displayed MMSI number, select *Send*. To cancel the request, select *Cancel*.
5. When the other station responds, the radio displays the MMSI number, the longitude, and the latitude of the other station. If your radio is connected to a chartplotter through the NMEA OUT connection (see page 43), the position information will also be displayed on the plotter screen.
6. If the other station does not have valid GPS data, the radio displays *No Position*.

### Receiving a position request (Position Reply)

When another station requests your current position, the radio displays the following screen:

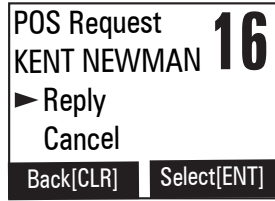

To send your current position to the other station, select *Reply*; the radio transmits your latitude and longitude to the other station. If you select *Reply* but the radio does not have valid GPS data, it transmits the reply code with *No Position*.

To reject the position request, select *Cancel*.

### Enabling automatic position reply

If you want the radio to automatically transmit your current position whenever it receives a position request, you can enable automatic position reply. Most boaters activate automatic position reply for safety reasons or because they subscribe to a marine towing service. Sometimes - for example, in some competitive situations - you may not want other stations to get your position without your manual confirmation

1. Press and hold **CALL-MENU** to display the normal menu.
2. Select *Setup* and then *POS Reply*.
3. Choose *Auto* and press **ENT-1W/25W**. The radio will automatically transmit your position when it receives a position request.
4. To disable automatic position reply, repeat the steps above and select *Manual*.

### Sending your own position (Position Send)

If your radio is connected to a GPS receiver, you can send your boat's position to someone else. If you are requesting assistance or using an all ships call to give a safety warning, you can send your current position so other stations know where you are:

1. Press **CALL-MENU** to display the call menu.
2. Select *Position Send*.
3. The radio displays the names listed in your directory; use **CHANNEL UP** and **CHANNEL DOWN** to choose the directory entry you want to contact and press **ENT-1W/25W**. If you want to contact a station that is not in your directory, select *Manual*. The radio prompts you to enter the MMSI number you want to call. Enter the MMSI number the same way you enter directory entries (see page 22). Enter all nine digits and press **ENT-1W/25W**.
4. The radio displays the MMSI number you are about to contact and asks you to confirm. If you want to transmit your position to the displayed MMSI number, select *Send*. To cancel the transmission, select *Cancel*.
5. The radio transmits your MMSI number, your longitude, and your latitude to the other station.

## Putting the Radio into Standby

If you are leaving your radio or do not wish to answer any DSC calls, you can put your radio in standby mode. If your radio receives an individual call, it will automatically respond with a message that indicates your radio is currently unattended. Follow the steps below to put your radio in standby:

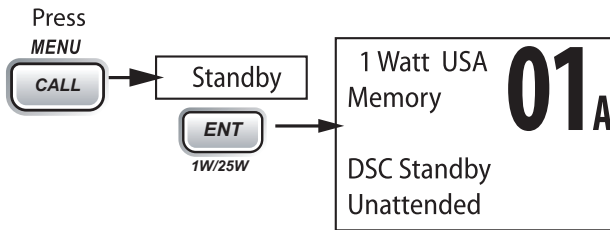

1. Display the Call menu.
2. Select *Standby* to place your radio in standby mode. The radio displays the standby screen, above.
3. To cancel standby and return to the mode your radio was in, press any button.

## Disabling Automatic Channel Switching

If you are involved in a bridge-to-bridge call, you may not want the radio to automatically switch channels when it receives a DSC call. In cases like this, you can disable automatic channel switching. If you receive an individual call, the radio will respond with an unattended code, just as if the radio were in Standby.

1. Press and hold **CALL-MENU** to display the normal menu.
2. Select *Setup* and then *Auto CH SW*.
3. Choose *Off* and press **ENT-1W/25W**. The radio will not automatically switch channels until you reactivate this feature.

🔊 **NOTE: Use this feature with caution. Deactivating automatic switching and then forgetting it can make it hard for you to receive DSC calls.**

If you have unread incoming DSC calls, the radio displays a message icon (📶). You will be able to review who has called. The radio displays the last 10 distress calls and the last 20 non-distress calls it received (see the receive log on page 29).

## Renaming Channels

If you discover that a marine radio channel has a different common name in your local area, you can change the name of that channel to make it easier for you to use (see the channel lists beginning on page 36 for the default channel names). To rename a channel, follow the steps below:

1. Display the normal menu and choose the Setup sub-menu.
2. Select *Channel Name*. The screen displays the list of channels.
3. Use **CHANNEL UP** and **CHANNEL DOWN** to choose the channel you want to change and press **ENT-1W/25W**.
4. Select *Rename* to enter a new name for this channel. The radio prompts you to enter a new name for this channel. Each name can be up to 12 characters. Use



**CHANNEL UP** and **CHANNEL DOWN** to change the first character.

5. When the first character is correct, press **ENT-1W/25W**. The cursor moves to the next character. Enter the remaining 11 characters of the name. If the name is shorter than 12 characters, press and hold **ENT-1W/25W** to complete the name entry. If you make a mistake while entering a number, press **CLR-SCAN** to erase the wrong number and the cursor is moved to the left digit.
6. When you finish entering the name, the radio displays the new channel name and asks you to confirm. To save this new channel name, select *Yes*; to cancel the change, select *No*. The radio returns to the channel list.
7. To restore a channel back to its original name, select the channel and choose *Default*.
8. When you are satisfied with the channel list, select *Exit* to close the menu screen.

# INSTALLING THE HARDWARE

## MOUNTING THE RADIO

Your radio can sit at any angle in the mounting bracket so it can easily accommodate the best location. First, determine the best place to mount the radio. For optimum performance, find a location that can:

- Properly support the weight of the radio, approximately 2.2 pounds or 1.1 kilograms. You may need to use some type of anchor with the mounting screws to hold the radio, depending on the surface.
- Keep the battery leads as short as possible.
- Keep the antenna lead-in wire as short as possible.
- Allow free air flow around the heat sink on the rear of the radio.
- Avoid interference with the ship's compass.

1. Install the radio into the mounting bracket.
2. Position the radio into the desired location. Mark the edges of the bracket on the mounting surface.

Actual product image may vary slightly.

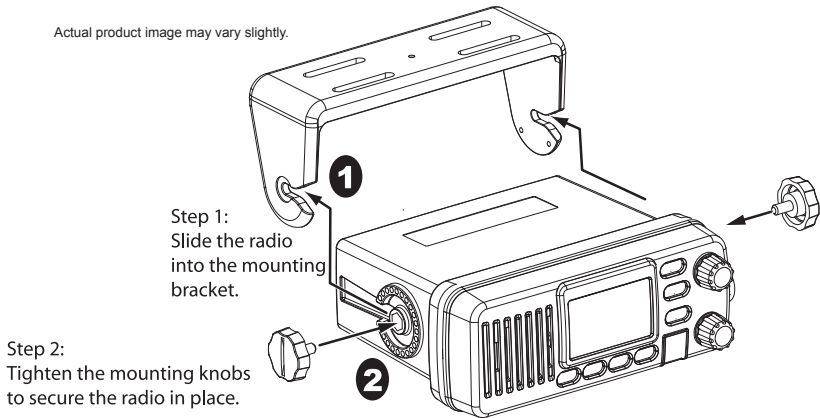

3. Remove the mounting bracket drill template from the back of the manual, and use the template to mark the drill holes on the mounting surface.
4. Drill the holes for the mounting bracket; be sure to follow any special requirements of the mounting surface.
5. Remove the bracket from the radio, and use the mounting hardware to secure the bracket to the mounting surface.

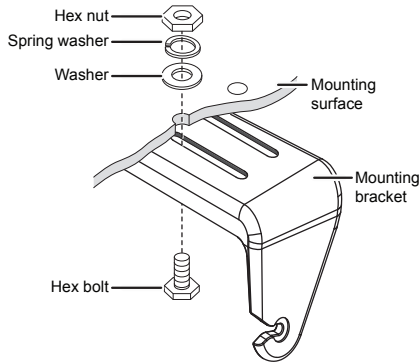

6. Install the radio back into the mounting bracket.

## CONNECTING THE RADIO

To operate correctly, your radio requires two electrical connections:

- providing it with power from the boat's electrical system
- connecting a VHF-FM marine antenna to the antenna connector

Power Supply Requirements	VHF Antenna Requirements
<p>Nominal 13.8 VDC power supply with a negative ground (10.5 VDC to 16.0 VDC). Power leads should be kept as short as possible. A direct connection to the power supply is ideal.</p> <p>Minimum of #14 AWG copper wire for extensions up to 20 feet, 12 AWG wire for extensions from 20 to 35 feet, or 10 AWG wire for extensions from 35 to 60 feet.</p>	<p>Male PL-259 connector</p> <p>50 <math>\Omega</math> impedance</p> <p>Minimum 3 foot, 3 dB rated antenna for sailboats or 8 foot, 6 dB rated antenna for powerboats</p> <p>Minimum RG-58 lead-in wire for antenna leads up to 20 feet, RG-8X for antenna leads from 20 to 35 feet, or RG-8U for antenna leads from 35 to 60 feet.</p>

1. Connect the BLACK wire of the power cable to the NEGATIVE (-) side of your power source.
  2. Connect the RED wire of the power cable to the POSITIVE (+) side of your power source.
- 🔧 **NOTE: To extend the life of the radio, use waterproof tape to seal electrical connections.**
3. Install your antenna according to the manufacturer's instructions.
  4. If necessary, consult the FCC guidelines for antenna separation. See Antenna Selection and Installation on page 63 for more details. (In summary, the FCC recommends that antennas up to 3 dB be installed a minimum of 3 feet from any occupied location; antennas over 3 dB should be installed at least 6 feet away.)
  5. Connect the PL-259 connector from the antenna lead-in wires to the SO238 connector labeled ANTENNA on the back of your radio.
  6. Plug the power cable into the power cable pigtail on the back of your radio.

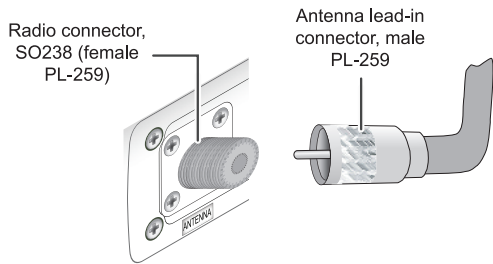

## Connecting the Accessory Cable

Use the accessory cable to connect the radio to a GPS receiver, a GPS chartplotter, and an external speaker. The wiring diagram below shows the connections for each accessory.

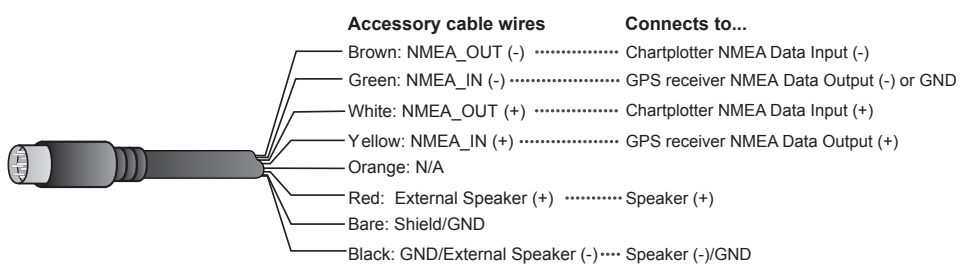

## Connecting to a GPS Receiver

If you connect the radio to a GPS receiver, the radio can automatically transmit your current position during an automated distress call or during a normal DSC call.

Your radio supports a standard NMEA0183 input from a GPS receiver. Follow the steps below to connect your radio to your GPS receiver:

1. Connect the GREEN wire of the included accessory cable to the GPS DATA OUTPUT (-) WIRE or the GROUND WIRE on your GPS receiver.
  2. Connect the YELLOW wire of the included accessory cable to the GPS DATA OUTPUT (+) WIRE on your GPS receiver.
  3. Be certain all wire connections are secure and that all open wires are adequately covered.
- 🔊 **NOTE: to extend the life of the radio, use waterproof tape to seal electrical connections.**
4. Plug the accessory cable into the accessory cable pigtail on the back of your radio.

## GPS Verification

If the GPS receiver is correctly connected and it transmits valid data, the display shows *GPS Data OK*. Press **ENT-1W25W** to open the GPS status screen and see detailed GPS data:

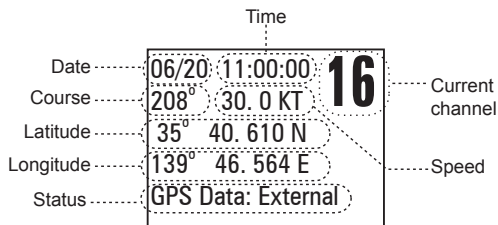

If the GPS does not send coordinates within 30 minutes, an audible alert sounds once and the display shows Input GPS. This message remains until the coordinates are updated.

After 4 hours, the audible alert sounds again if no coordinates are received and the GPS is connected. After 23.5 hours, the radio deletes the current coordinates and displays Input GPS.

See page 19 to manually set the GPS coordinates.

### Configuring the GPS

If the radio is receiving valid GPS data, it will automatically set the clock to your local time based on the GPS location. You can adjust your local time forward or back one hour if necessary (for example, if you are close to the border of a time zone); you can also adjust for Daylight Savings Time.

Follow the steps below to adjust the time:

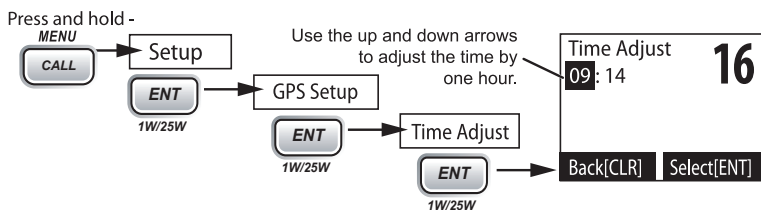

1. Display the normal menu and choose the Setup sub-menu.
2. Select *GPS Setup* and then choose *Time Adjust*.
3. The display shows your current local time. To adjust the time forward one hour, use **CHANNEL UP**. To adjust the time back one hour, use **CHANNEL DOWN** button. Press **ENT-1W/25W** button when you are finished.
4. The display prompts you to confirm the setting: choose *Set* to save the new time or *Cancel* to exit time setup without saving. The radio returns to the GPS Setup menu.
5. If your local area observes Daylight Savings Time, choose *Daylight Save* and press the **ENT-1W/25W** button.
6. If Daylight Savings Time is currently in effect, select *On*. If Daylight Savings Time is not currently in effect, select *Off*.
7. Press **ENT-1W/25W**. The radio activates the new time setting and returns to the GPS Setup menu.

## Connecting to a Chartplotter

Your radio provides a standard NMEA0183 GPS output that you can connect to a chartplotter. When it receives another boat's position data in a DSC call, the radio sends the position data to the chartplotter so you can see the location:

1. Connect the BROWN wire of the accessory cable to the NEGATIVE (-) wire of your chartplotter's NMEA data INPUT.
2. Connect the WHITE wire of the accessory cable to the POSITIVE (+) wire of your chartplotter's NMEA data INPUT
3. Be certain all wire connections are secure and that all open wires are adequately covered.

🔧 **NOTE: To extend the life of the radio, use waterproof tape to seal electrical connections.**

## Connecting to an External Speaker

You can use an external speaker to monitor the radio from a different part of your boat or in a noisy environment. If you adjust the **VOLUME-PWR** knob on the radio, it will also adjust the external speaker volume.

Your radio supports an external speaker with the following specifications:

- Minimum impedance of 4 Ohms
  - Minimum power handling of 10 Watts
1. Connect the BLACK wire of the accessory cable to the GROUND WIRE of your external speaker.
  2. Connect the RED wire of the accessory cable to the POSITIVE (+) WIRE of your external speaker.
  3. Be certain all wire connections are secure and that all open wires are adequately covered.

🔧 **NOTE: To extend the life of the radio, use waterproof tape to seal electrical connections.**

## MAINTENANCE AND TROUBLESHOOTING

Due to its rugged design, your radio requires very little maintenance. However, it is a precision electronic instrument, so you should follow a few precautions:

- If the antenna has been damaged, you should not transmit except in the case of an emergency. A defective antenna may cause damage to your radio.
- You are responsible for continued FCC technical compliance of your radio.
- You should arrange for periodic performance checks with your dealer.

Problem	Things to Try
The radio won't power on.	Check the power connections. Check the fuse. Check the master battery switch and branch circuit that connect to the radio.

Problem	Things to Try
The radio won't transmit.	<p>Make sure you are not in weather or scan mode.</p> <p>Make sure you are not trying to transmit on a receive-only channel (see the channels and frequency tables beginning on page 50).</p> <p>Make sure you are transmitting at the correct power level for this channel (see the channels and frequency tables beginning on page 50).</p> <p>Make sure the duration of each transmission is less than 5 minutes.</p>
Noise comes out of the speaker all the time	Adjust the squelch level; it is probably too low.
I can't hear anything (no volume) from the speaker.	Adjust the squelch level; it is probably too high.
I can transmit, but no one can hear me.	Check your UIC channel settings [see Setting the UIC channel mode (USA/CAN/INT) on page 5].
The display flashes, and I don't know why.	The display will flash if the radio is in a watch mode or in scan mode. Try turning off scanning, Weather Alert Watch, or Triple/Dual Watch (see page 11).
I can't read the display.	Adjust the contrast and backlight brightness level (see page 19).
The display is too bright at night.	<p>Adjust the backlight brightness level.</p> <p>Turn off the radio; hold <b>CALL-MENU</b> button and turn it back on (see page 19).</p>
I can't see any words on the display.	Reset the radio back to the default brightness level: turn off the radio; hold the <b>CALL-MENU</b> button and turn it back on.
I'm not getting any GPS data on my display.	<p>Make sure your GPS receiver is correctly connected (see Connecting to a GPS receiver, page 40).</p> <p>Make sure your GPS receiver is working properly.</p> <p>Make sure that your GPS receiver supports the NMEA parameters described in NMEA Operation on page 41.</p>
I'm not getting any hazard alerts.	<p>Make sure Weather Alert Watch is turned on.</p> <p>Check to make sure the FIPS codes in your radio include your current location (see Using FIPS codes for weather alerts on page 17).</p>

Problem	Things to Try
I'm getting all the hazard alerts, not just the ones for my area.	<p>Check to make sure the FIPS codes in your radio were entered correctly (see Using FIPS codes for weather alerts on page 17).</p> <p>Sometimes the Weather Alert Watch may catch a hazard alert in the middle of the broadcast and miss which FIPS codes are affected. For your safety, the radio triggers the alert tone and switches to the weather channel when this happens.</p>
I can't make Group DSC calls.	Make sure the Group MMSI was entered correctly.
Where can I find my radio's serial number?	Look on the right side of the radio (the side with the microphone cord), behind the mounting bracket.
The radio won't let me enter my User MMSI. What do I do?	Contact customer service.

## ENGINE NOISE SUPPRESSION

Interference from the noise generated by the electrical systems of engines is sometimes a problem with radios. Your radio has been designed to be essentially impervious to ignition noise and alternator noise. However, in some installations it may be necessary to take measures to further reduce the effect of noise interference. Your radio's DC battery wires, antenna lead, and accessory cables should be routed away from the engine and engine compartment, and from power cabling carrying high currents. In severe cases of noise interference, it may be necessary to install a noise suppression kit. Contact the dealer where you purchased the radio for more information.



# SPECIFICATIONS

All specifications are subject to change without notice.

## RADIO SPECIFICATIONS

General	
Controls	Volume-Pwr, Squelch
Status Indicators	Transmit power, Scan mode, Triple Watch mode, Battery High, Battery low, USA, CAN, INT, Alert, Memory, GPS, Message, Weather band, GPS status and Channel Display
Display	LCD (Full Dot Matrix)
Buttons	ENT-1W/25W, Channel UP, Channel DOWN, CALL-MENU, WX-MEM, CLR-SCAN, 16/9-TRI, and DISTRESS
Connectors and Cables	Antenna, accessory, and DC power
Size	H 2.62 inches x W 6.4 inches x L 5.12 inches (without Heat Sink) H 66.6 mm x W 162.6 mm x L 130.1 mm (without Heat Sink)
Weight	1.0 kg (2.2 pounds)
Supply Voltage	Nominal 13.8V DC, negative ground (10.5 VDC to 16.0 VDC)
Standard Accessories	Mounting bracket and hardware, microphone hanger,
Antenna Impedance	50 $\Omega$ nominal
Microphone	Rugged 2 k $\Omega$ condenser mic element with coiled cord
Speaker	1.77 inch, 8 $\Omega$
Operating Temperature Range	-4 °F to +122 °F (-20 °C to + 50 °C)
Shock and Vibration	Meets or exceeds EIA standards, RS152B and RS204C
FCC Approvals	Type accepted under part 80 of the Rules; meets Great Lakes Agreement and party boat requirements
Transmitter	
Power Output	1 watt or 25 watt (user selectable)
Power Requirement	25 watts output: 6A@13.8V DC
Modulation	$\pm$ 5 kHz deviation
Hum and Noise Signal-to-Noise	45 dB@1 kHz with 3 kHz deviation with 1000 Hz modulating frequency (nominal)
Audio Distortion	Less than 8% with 3 kHz deviation with 1000 Hz modulating frequency
Spurious Suppression	-40 dBm @ Hi, -40dBm @ Lo
Output Power Stabilization	Built-in automatic level control (ALC)
Frequency Range	156 to 163 MHz
Frequency Stability	$\pm$ 10 ppm @ -20°C to + 50°C
Receiver	
Frequency Range	156 to 163 MHz

General	
Sensitivity	0.25 $\mu$ V for 12 dB SINAD (nominal)
Circuit	Dual Conversion Super Heterodyne PLL (Crystal for DSC)
Squelch Sensitivity	0.2 $\mu$ V Threshold
Spurious Response	75 dB (nominal)
Adjacent Channel Selectivity	75 dB @ $\pm$ 25 kHz (nominal)
Audio Output Power	2.5 watts (10% Distortion, 8 $\Omega$ load)
Power Requirement	360 mA @ 13.8V DC at squelched, 920 mA @ 13.8V DC at maximum audio output
IF Frequencies	1st 41.925 MHz, 2nd 455 kHz (1st 21.7 MHz, 2nd 455 kHz for DSC)

## REFERENCE TABLES

☒ **NOTE:** This radio does not support AIS channels.

### Channel Descriptions and What They Mean

The table below lists the display name or channel description used in the following tables and what each description means.

Channel name/description	Used for
DISTRESS SAFETY AND CALLING	primarily emergency messages and distress calls
INTERSHIP SAFETY	safety messages from one ship to another, or from a ship to Coast Guard aircraft
NON-COMMERCIAL (recreational or voluntary ships only)	messages about the needs of the ship, including fishing reports, rendezvous, scheduling repairs and berthing information
COMMERCIAL (working ships only)	messages about the needs of the ship or the business the ship is engaged in
PUBLIC CORRESPONDENCE/MARINE OPERATOR	calls to the marine operator at a public coast station. Marine operators can connect you to the telephone network so you can make and receive calls. (There is usually a charge for this service.)
PORT OPERATIONS/VTS (vessel traffic system)	messages about the movement and safety of ships in or near ports, locks or waterways. In certain major ports, some channels may be restricted to specific types of port operations messages.
NAVIGATIONAL/BRIDGE TO BRIDGE	messages about ship navigation, for example, passing or meeting other ships, maneuvering through locks, or navigating around drawbridges. Messages must be short!

Channel name/description	Used for
STATE CONTROL	messages about government regulation and control, boating activities, or assistance to ships; also used to talk to ships and coast stations operated by state or local governments
DIGITAL SELECTIVE CALLING	DSC signals only (no voice communications allowed at any time)

## MARINE RADIO CHANNEL CHART

Ch No.	USA	INT	CAN	TX	RX	Channel Type/Name
01		x	x	156.050	160.650	Public Correspondence (Marine Operator)
01A*	x			156.050	156.0500	Port Operation and Commercial [VTS (Vessel Traffic System)] in some areas.
02		x	x	156.100	160.700	Public Correspondence (Marine Operator)
03		x	x	156.150	160.750	Public Correspondence (Marine Operator)
04		x		156.200	160.800	Public Correspondence (Marine Operator)
04A			x	156.200	156.200	Canadian Coast Guard: West Coast Commercial Fishing: East Coast
05		x		156.250	160.850	Public Correspondence (Marine Operator). Ship Movement, Port Operations
05A	x		x	156.250	156.250	Port Operations, Ship Movement, VTS in some areas
06	x	x	x	156.300	156.300	Inter-ship safety
07		x		156.350	160.950	Public Correspondence (Marine Operator)
7A	x		x	156.350	156.350	Commercial
08	x	x	x	156.400	156.400	Commercial (Inter-Ship Only)
09	x	x	x	156.450	156.450	Boater Calling, Commercial and Non-Commercial
10	x	x	x	156.500	156.500	Commercial
11	x	x	x	156.550	156.550	Commercial, VTS in selected areas
12	x	x	x	156.600	156.600	Port Operations, VTS in selected areas

Ch No.	USA	INT	CAN	TX	RX	Channel Type/Name
13	x	x	x	156.650	156.650	Internship Navigation Safety (Bridge-to-Bridge). Ships >20m length maintain a listening watch on this channel in US waters.
14	x	x	x	156.700	156.700	Port Operation, VTS in some areas
15	x			Inhibit	156.750	Environmental (Receive Only)
15		x	x	156.750	156.750	Inter-ship, Port Operations, Commercial, Non-Commercial, Ship Movement (1 Watt Only)
16	x	x	x	156.800	156.800	Distress, Safety, Calling
17	x	x	x	156.850	156.850	State and Local Govt Maritime Control (1 Watt Only)
18		x		156.900	161.500	Port Operations, Ship Movement
18A	x		x	156.900	156.900	Commercial Canada: Towing West Coast
19		x		156.950	161.550	Commercial
19A	x		x	156.950	156.950	Commercial
20	x	x	x	157.000	161.600	Port Operations Canada: 1 Watt Only
20A	x			157.000	157.000	Port Operation
21		x		157.050	161.650	Port Operations
21A	x		x	157.050	157.050	Coast Guard Only
21B			x	INHIBIT	161.650	Canadian CG Continuous Marine Broadcast (CMB) Service
22		x		157.100	161.700	Port Operations, Ship Movement
22A	x		x	157.100	157.100	US and Canadian Coast Guard Liaison and Airtime Safety Information Broadcasts Announced on Channel 16
23		x	x	157.150	161.750	Public Correspondence (Marine Operator)
23A	x			157.150	157.150	US Coast Guard Only
23B			x	INHIBIT	161.750	Canadian CG Continuous Marine Broadcast (CMB Service)
24	x	x	x	157.200	161.800	Public Correspondence (Marine Operator)
25	x	x	x	157.250	161.850	Public Correspondence (Marine Operator)
25B			x	INHIBIT	161.850	Canadian CG Continuous Marine Broadcast (CMB) Service

Ch No.	USA	INT	CAN	TX	RX	Channel Type/Name
26	x	x	x	157.300	161.900	Public Correspondence (Marine Operator)
27	x	x	x	157.350	161.950	Public Correspondence (Marine Operator)
28	x	x	x	157.400	162.000	Public Correspondence (Marine Operator)
28B			x	INHIBIT	162.000	Canadian CG Continuous Marine Broadcast (CMB) Service
60		x	x	156.025	160.625	Public Correspondence (Marine Operator)
61		x		156.075	160.675	Public Correspondence (Marine Operator)
61A			x	156.075	156.075	Canadian Coast Guard: West Coast Commercial Fishing: East Coast
62		x		156.125	160.725	Public Correspondence (Marine Operator)
62A			x	156.125	156.125	Canadian Coast Guard
63		x		156.175	160.775	Public Correspondence (Marine Operator)
63A	x		x	156.175	156.175	VTS, Port Operations
64		x	x	156.225	160.825	Public Correspondence (Marine Operator)
64A			x	156.225	156.225	Canada: Commercial Fishing Only
65		x		156.275	160.875	Public Correspondence (Marine Operator)
65A	x		x	156.275	156.275	Port Operations Canada: Towing West Coast
66		x		156.325	160.925	Public Correspondence (Marine Operator)
66A	x		x	156.325	156.325	Port Operations Canada: 1 Watt Only
67	x	x	x	156.375	156.375	US: Commercial, Bridge-to-Bridge, VTS in some areas Canada: Search and Rescue, Commercial in some areas, Non- Commercial on West Coast
68	x	x	x	156.425	156.425	Non -Cmmercial
69	x	x	x	156.475	156.475	Non-Commercial Canada: Commercial East Coast. Non-Commercial West Coast

Ch No.	USA	INT	CAN	TX	RX	Channel Type/Name
70	x	x	x	156.525	156.525	DSC (Digital Selective Calling) Only. No Voice Communications Allowed
71	x	x	x	156.575	156.575	US: Non-Commercial Canada: Ship Movement West Coast, Non-Commercial East Coast
72	x	x	x	156.625	156.625	Non-Commercial (Ship-to-Ship)
73	x	x	x	156.675	156.675	Port Operations
74	x	x	x	156.725	156.725	Port Operations
75	x	x	x	156.775	156.775	Port Operations (1 Watt Only)
76	x	x	x	156.825	156.825	Port Operations (1 Watt Only)
77	x	x	x	156.875	156.875	Port Operations (Ship-to-Ship)
78		x		156.925	161.525	Port Operations
78A	x		x	156.925	156.925	Non-Commercial, Inter-Ship
79		x		156.975	161.575	Port Operations
79A	x		x	156.9750	156.975	Commercial, Inter-Ship
80		x		157.025	161.625	Port Operationsx
80A	x		x	157.025	157.025	Commercial, Inter-Ship
81		x		157.075	161.675	Port Operations
81A	x		x	157.075	157.075	Government, Canadian Coast Guard
82		x		157.125	161.725	Port Operations
82A	x		x	157.125	157.125	Government, Canadian Coast Guard
83		x		157.175	161.775	Port Operations
83A	x		x	157.175	157.175	Coast Guard
83B			x	INHIBIT	161.775	Canadian CG Continuous Marine Broadcast (CMB) Service
84	x	x	x	157.225	161.825	Public Correspondence (Marine Operator)
85	x	x	x	157.275	161.875	Public Correspondence (Marine Operator)
86	x	x	x	157.325	161.925	Public Correspondence (Marine Operator)
87A	x	x	x	157.375	157.375	Public Correspondence (Marine Operator)
88A	x	x		157.425	157.425	Public Correspondence (Marine Operator)
1019	x	x		156.950	156.950	Commercial
1020	x	x		157.000	157.000	Port Operations
1078	x	x		156.925	156.925	Non-Commercial, Inter-Ship
1079	x	x		156.975	156.975	Commercial, Inter-Ship

Ch No.	USA	INT	CAN	TX	RX	Channel Type/Name
2019		x		161.550	161.550	Commercial
2020		x		161.600	161.600	Port Operations
2078		x		161.525	161.525	Port Operations
2079		x		161.575	161.575	Port Operations

## WEATHER CHANNELS AND FREQUENCIES (US, CAN, AND INT)

Ch No.	RX Freq	Name on display
WX01	162.5500	162.550 MHz
WX02	162.4000	162.400 MHz
WX03	162.4750	162.475 MHz
WX04	162.4250	162.425 MHz
WX05	162.4500	162.450 MHz
WX06	162.5000	162.500 MHz
WX07	162.5250	162.525 MHz
WX08	161.6500	161.650 MHz
WX09	161.7750	161.775 MHz

## EMERGENCY ALERT SYSTEM (SAME) INFORMATION

### Types of Events

- A WARNING is an event that alone poses a significant threat to public safety and/or property, probability of occurrence and location is high, and the onset time is relatively short.
- A WATCH meets the classification of a warning, but either the onset time, probability of occurrence, or location is uncertain.
- An EMERGENCY is an event that, by itself, would not kill or injure or do property damage, but indirectly may cause other things to happen that result in a hazard. For example, a major power or telephone loss in a large city alone is not a direct hazard, but disruption to other critical services could create a variety of conditions that could directly threaten public safety.
- A STATEMENT is a message containing follow up information to a warning, watch, or emergency.

Event	SAME Code	Type
Blizzard Warning	BZW	Warning
Coastal Flood Watch	CFA	Watch
Coastal Flood Warning	CFW	Warning
Dust Storm Warning	DSW	Warning
Flash Flood Watch	FFA	Watch
Flash Flood Warning	FFW	Warning
Flash Flood Statement	FFS	Statement
Flood Watch	FLA	Watch

<b>Event</b>	<b>SAME Code</b>	<b>Type</b>
Flood Warning	FLW	Warning
Flood Statement	FLS	Statement
High Wind Watch	HWA	Watch
High Wind Warning	HWW	Warning
Hurricane Watch	HUA	Watch
Hurricane Warning	HUW	Warning
Hurricane Statement	HLS	Statement
Severe Thunderstorm Watch	SVA	Watch
Severe Thunderstorm Warning	SVR	Warning
Severe Weather Statement	SVS	Statement
Special Marine Warning	SMW	Warning
Special Weather Statement	SPS	Statement
Tornado Watch	TOA	Watch
Tornado Warning	TOR	Warning
Tropical Storm Watch	TRA	Watch
Tropical Storm Warning	TRW	Warning
Tsunami Watch	TSA	Watch
Tsunami Warning	TSW	Warning
Winter Storm Watch	WSA	Watch
Winter Storm Warning	WSW	Warning
National Information Center	NIC	Test
Avalanche Watch	AVA	Watch
Avalanche Warning	AVW	Warning
Child Abduction Emergency	CAE	Emergency
Civil Danger Warning	CDW	Warning
Civil Emergency Message	CEM	Emergency
Earthquake Warning	EQW	Warning
Evacuation Immediate	EVI	Warning
Fire Warning	FRW	Warning
Hazardous Materials Warning	HMW	Warning
Law Enforcement Warning	LEW	Warning
Local Area Emergency	LAE	Emergency
911 Telephone Outage Emergency	TOE	Emergency
Nuclear Power Plant Warning	NUW	Warning



Event	SAME Code	Type
Radiological Hazard Warning	RHW	Warning
Shelter in Place Warning	SPW	Warning
Volcano Warning	VOW	Warning
Test Message	ADR	Test
Practice/Demo Warning	DMO	Test
Required Monthly Test	RMT	Test
Required Weekly Test	RWT	Test
Biological Hazard Warning	BHW	Warning
Boil Water Warning	BWW	Warning
Chemical Hazard Warning	CHW	Warning
Dam Watch	DBA	Watch
Dam Break Watch	DBW	Warning
Contagious Disease Warning	DEW	Warning
Emergency Action Notification	EAN	Warning
Emergency Action Termination	EAT	Statement
Evacuation Watch	EVA	Watch
Flood Contamination Warning	FCA	Warning
Flash Freeze Warning	FSW	Warning
Iceberg Warning	IBW	Warning
Industrial Fire Warning	IFW	Warning
Landslide Warning	LSW	Warning
National Audible Test	NAT	Test
Network Notification Message	NMN	Statement
National Periodic Test	NPT	Test
National Silent Test	NST	Test
Power Outage Advisory	POS	Statement
Wild Fire Watch	WFA	Watch
Wild Fire Warning	WFW	Warning
Unrecognized Watch	**A	Watch
Unrecognized Emergency	**E	Statement
Unrecognized Statement	**S	Statement
Unrecognized Warning	**W	Warning

### No Response Event Code

TXB	Transmitter Backup On
TXF	Transmitter Carrier On

TXO	Transmitter Carrier On
TXP	Transmitter Primary On

## NMEA OPERATION

This radio supports NMEA0183 version 3.01.

### NMEA Input

If you have difficulty getting your radio to receive data from your GPS receiver, check the device's configuration. It should be set to the following parameters:

Baud rate	4800 bps
Data bits	8
Parity	None
Stop bits	1
Data amplitude	Over 3.0 V
Drive capability	Over 10 mA

The radio supports RMC, GLL, GNS, GGA and ZDA sentences. When these sentences are received, the radio displays latitude/longitude, date, time, course, and speed. If any sentence except an RMC or GLL sentence is received, the radio uses the information based on the following priority order.

- Status:RMC > GLL > GNS > GGA
- Latitude/Longitude:RMC > GLL > GNS > GGA
- UTC Time: RMC > GLL > GNS > GGA > ZDA
- Date: RMC > ZDA
- Speed / Course:RMC

✂ **NOTE 1: If the radio receives only a GLL sentence, the radio does not display the current speed, course, and date.**

✂ **Note 2: If the radio receives both RMC and GLL sentences, the radio uses only the RMC sentence.**

✂ **Note 3: Status data is used to check whether the GPS data is valid or invalid.**

### NMEA Output

When the radio receives a DSC call (Distress, Position Reply, or Position Send), it outputs a DSC/DSE sentence from the NMEA output port.

✂ **NOTE: When the radio receives a distress call, it outputs a sentence in the following format:**

- \$CDDSC,12,3081234000,,07,00,0354013946,0657,,,S,E\*6D
- \$CDDSE,1,1,A,3081234000,00,60875646\*13

## REGULATIONS AND SAFETY WARNINGS

### MARITIME RADIO SERVICES OPERATION

**WARNING!** This transmitter will operate on channels/frequencies that have restricted use in the United States. The channel assignments include frequencies assigned for exclusive use of the U.S. Coast Guard, use in Canada, and use in international waters. Operation on these frequencies without proper authorization is strictly forbidden. See the channel tables beginning on page 50 for a list of available channels and their uses. If you are still not certain which channels to use, see the FCC maritime radio page at the FCC website ([http:// wireless.fcc.gov/marine/](http://wireless.fcc.gov/marine/)) or contact the FCC Call Center at 1-888-CALLFCC. For individuals requiring a license, such as commercial users, you should obtain a license application from your nearest FCC field office (for US users) or Industry Canada (for Canadian users).

### BASIC RADIO GUIDELINES

You should familiarize yourself with the rules on marine radios and be aware of which rules apply to your boat. Complete guidelines for all ship and marine radio types can be found at the US Coast Guard website under the topic Radio Info for Boaters (the direct link is <http://www.navcen.uscg.gov/marcomms/boater.htm>). Here are a few guidelines that affect nearly all boaters.

- If you have a VHF radio on your boat, you must maintain a watch on channel 16 (156.800 MHz) whenever the radio is not being used to communicate. Effective from 2004, if a radio is carried, it must be turned on and set to channel 16 whenever your vessel is underway.
- If you hear a distress call, wait a few minutes to let a shore station or Coast Guard vessel respond. If no other station has responded after 5 minutes, you must respond to the distress call.
- Do not make false mayday or distress calls as a prank or to test your radio. (This is essentially like making a false 9-1-1 call; you may be subject to fines.)

### COMPLIANCE

#### FCC Part 15

The equipment has been tested and found to comply with the limits for a Class B device, pursuant to Part 15 of the FCC rules. These limits are designed to provide reasonable protection against harmful interference in a residential installation. This equipment generates, uses, and can radiate radio frequency energy and, if not installed and used in accordance with the instructions, may cause harmful interference to radio communications. However, there is no guarantee that interference will not occur in a particular installation. If this equipment does cause harmful interference to radio or television reception, which can be determined by turning the equipment off and on, the user is encouraged to try to correct the interference by one of the following measures:

- Reorient or relocate the receiving antenna.
- Increase the separation between the equipment and the receiver

- Connect the equipment into an outlet on a circuit different from that to which the receiver is connected.
- Consult the dealer or an experienced radio/TV technician for help.

Changes or modifications not expressly approved by the party responsible for compliance could void your authority to operate the equipment. Any change or modification must be approved in writing by West Marine.

This device complies with Part 15 of the FCC rules. Operation is subject to the following two conditions: (1) This device may not cause harmful interference, and (2) this device must accept any interference received, including interference that may cause undesired operation.

Tout changement ou modification non approuvé expressément par la partie responsable pourrait annuler le droit à l'utilisateur de faire fonctionner cet équipement. Tout changement ou modification doit être approuvé par écrit par West Marine.

Avis de conformité à la FCC : Ce dispositif a été testé et s'avère conforme à l'article 15 des règlements de la Commission fédérale des communications (FCC). Ce dispositif est soumis aux conditions suivantes: 1) Ce dispositif ne doit pas causer d'interférences nuisibles et; 2) Il doit pouvoir supporter les parasites qu'il reçoit, incluant les parasites pouvant nuire à son fonctionnement.

In order to comply with FCC RF Exposure requirements, this device must be installed to provide at least 7.9 in (20 cm) separation from the human body at all times.

## **IC**

This device complies with Industry Canada license-exempt RSS standard(s). Operation is subject to the following two conditions: (1) this device may not cause interference, and (2) this device must accept any interference, including interference that may cause undesired operation of the device.

Cet appareil est conforme aux normes RSS exemptes de licences d'Industrie Canada. Son fonctionnement est soumis aux deux conditions suivantes : (1) cet appareil ne doit pas causer d'interférences nuisibles et (2), il doit pouvoir accepter les interférences, incluant celles pouvant nuire à son fonctionnement normal.

In order to comply with FCC/ISED RF Exposure requirements, this device must be installed to provide at least 7.9 in. (20 cm) separation from the human body at all times.

Afin de se conformer aux exigences d'exposition RF FCC/ISED, ce dispositif doit être installé pour assurer une séparation d'au moins 7.9 in. (20 cm) du corps humain à tout moment.

## ANTENNA SELECTION AND INSTALLATION

Your UM385 has been designed to accommodate all of the popular marine VHF antennas. However, the selection and the installation of the antenna is the responsibility of the user or installer.

The FCC has determined that excessive radiation poses a health risk to people near radio transmitting antennas. Therefore, the antenna used with this radio should be installed using the following guidelines to ensure a suitable distance between the antenna and persons close by.

- Small whip antennas (3 dB) or smaller should be installed keeping at least a two foot separation distance between the radiating element and people.
- Medium antennas (6 dB) should be installed keeping at least a three foot separation distance.
- Larger antennas (9 dB) should be installed keeping at least a four foot separation distance.
- No person should touch the antenna or come into the separation distance when the radio is transmitting.

## THREE-YEAR LIMITED WARRANTY

This Limited Warranty is Void outside the United States of America and Canada.

WARRANTOR: UNIDEN AMERICA CORP. (“Uniden”)

ELEMENTS OF WARRANTY: Uniden warrants, for three years, to the original retail owner, this Uniden roduct to be free from defects in materials and craftsmanship with only the limitations or exclusions set out below.

WARRANTY DURATION: This warranty to the original user shall terminate and be of no further effect 36 months after the date of original retail sale. The warranty is invalid if the Product is (A) damaged or not maintained as reasonable or necessary, (B) modified, altered, or used as part of any conversion kits, subassemblies, or any configurations not sold by Uniden, (C) improperly installed, (D) serviced or repaired by someone other than an authorized Uniden service center for a defect or malfunction covered by this warranty, (E) used in any conjunction with equipment or parts or as part of any system not manufactured by Uniden, or (F) installed or programmed by anyone other than as detailed by the Operating Guide for this product.

STATEMENT OF REMEDY: In the event that the product does not conform to this warranty at any time while this warranty is in effect, warrantor will either, at its option, repair or replace the defective unit and return it to you without charge for parts, service, or any other cost (except shipping and handling) incurred by warrantor or its representatives in connection with the per-formance of this warranty. Warrantor, at its option, may replace the unit with a new or refur-bished unit. THE LIMITED WARRANTY SET FORTH ABOVE IS THE SOLE AND ENTIRE WARRANTY PERTAINING TO THE PRODUCT AND IS IN LIEU OF AND EXCLUDES ALL OTHER WARRANTIES OF ANY NATURE WHATSOEVER, WHETHER EXPRESS, IMPLIED OR ARISING BY OPERATION OF LAW, INCLUDING, BUT NOT LIMITED TO ANY IMPLIED WARRANTIES OF MERCHANTABILITY OR FITNESS FOR A PARTICULAR PURPOSE. THIS WARRANTY DOES NOT COVER OR PROVIDE FOR THE REIMBURSEMENT

OR PAYMENT OF INCIDENTAL OR CONSEQUENTIAL DAMAGES. Some states do not allow this exclusion or limitation of incidental or consequential damages so the above limitation or exclusion may not apply to you.

LEGAL REMEDIES: This warranty gives you specific legal rights, and you may also have other rights which vary from state to state. This warranty is void outside the United States of America.

PROCEDURE FOR OBTAINING PERFORMANCE OF WARRANTY: If, after following the instructions in this Operating Guide you are certain that the Product is defective, pack the Product carefully (preferably in its original packaging). Include evidence of original purchase and a note describing the defect that has caused you to return it. The Product should be shipped freight prepaid, by traceable means, or delivered, to warrantor at:

Uniden America Corporation  
C/O Saddle Creek  
743 Henrietta Creek Rd., Suite 100  
Roanoke, TX 76262











**QUESTIONS?**  
Visit our website at  
[www.uniden.com](http://www.uniden.com).

**QUESTIONS?**  
Visitez notre site web au  
[www.uniden.com](http://www.uniden.com).