



	Test Report Serial No.:	092311AMW-T1124-E95U	Test Report Issue Date:	November 04, 2011	 
	Measurement Dates:	September 26-28, 2011	Test Report Revision:	Rev. 1.1 (2nd Release)	
	Rule Part(s) Applied:	FCC 47 CFR §2, §95A, §95B IC RSS-210 (8), RSS-Gen (3)	Test Site Registration:	FCC Accredited Site IC Site File #: 3874A-1	
					Test Lab Certificate No. 2470.01

DECLARATION OF COMPLIANCE	FCC PART 95(A/B) & IC RSS-210 (Issue 8)
----------------------------------	--

Test Lab Information	Name	CELLTECH LABS INCORPORATED				
	Address	21-364 Lougheed Road, Kelowna, British Columbia V1X 7R8 Canada				
Test Lab Accreditation(s)	A2LA	ISO/IEC 17025:2005 (A2LA Test Lab Certificate No. 2470.01)				
Test Site Registration No.(s)	IC	3874A-1				
Applicant Information	Name	UNIDEN AMERICA CORPORATION				
	Address	4700 Amon Carter Boulevard, Fort Worth, Texas 76155 United States				
Standard(s) & Procedure(s)	FCC	47 CFR Part 2	47 CFR Part 95 Subpart A	47 CFR Part 95 Subpart B		
	IC	RSS-210 Issue 8		RSS-Gen Issue 3		
	ANSI	TIA/EIA-603-C-2004		C63.4-2003		
Device Classification(s)	FCC	Licensed Non-Broadcast Transmitter Held to Face (TNF) - GMRS Part 95 Family Radio Face Held Transmitter (FRF) - FRS		47 CFR §95 (Subpart A) 47 CFR §95 (Subpart B)		
	IC	Low-power Licence-exempt Radiocommunication Device (GMRS/FRS)		RSS-210 Issue 8		
Device Category	FCC/IC	Portable				
RF Exposure Category	FCC/IC	General Population / Uncontrolled				
Application Type	FCC/IC	TCB Certification	IC	CB Certification		
Device Identifier(s)	FCC ID:	AMWUT063				
	IC:	513C-UT063				
Device Under Test (DUT)	Portable /FRS/GMRS Push-To-Talk (PTT) Radio Transceiver (GMRS/FRS Band)					
Date of Sample Receipt	September 23, 2011					
Date(s) of Evaluation	September 26-28, 2011					
Device Model(s)	GMR3040					
Test Sample Serial No.(s)	TA Sample No.2 (Identical Prototype)					
Number of Channels	22 (UHF Band)					
Transmit Frequency Ranges (GMRS/FRS UHF Band)	462.5500 - 462.7250 MHz (GMRS Channels 15-22)					
	462.5625 - 462.7125 MHz (GMRS/FRS Channels 1-7)					
	467.5625 - 467.7125 MHz (FRS Channels 8-14)					
Max. RF Output Power Tested	Mode	Frequency	Channel	dBm	Watts	Method
	GMRS	462.5625 MHz	1	27.9	0.62	ERP
	FRS	467.5625 MHz	8	26.1	0.41	ERP
Modulation Type(s)	FM					
Emission Designator(s)	11K0F3E					
Antenna Type(s) Tested	Non-detachable					
Antenna Gain Spec.	-3.6 dBi (GMRS), -3.3 dBi (FRS)					
Power Source(s) Tested	Li-Ion Battery Pack (3.6V, 550mAh) Model: BP-1028					
<p>This wireless device has demonstrated compliance with the applicable technical standards as indicated in the measurement report and was tested in accordance with the measurement procedures specified in FCC 47 CFR Rule Part 2, Part 95 Subpart A, Part 95 Subpart B; Industry Canada RSS-210 Issue 8, RSS-Gen Issue 3; ANSI TIA/EIA-603-C-2004 and ANSI C63.4-2003.</p> <p>I attest to the accuracy of data. All measurements were performed by me or were made under my supervision and are correct to the best of my knowledge and belief. I assume full responsibility for the completeness of these measurements and vouch for the qualifications of all persons taking them.</p> <p>The results and statements contained in this report pertain only to the device(s) evaluated.</p> <p>This test report shall not be reproduced partially, or in full, without the prior written approval of Celltech Labs Inc.</p>						
Test Report Approved By			Sean Johnston	Lab Manager	Celltech Labs Inc.	

Applicant:	Uniden America Corporation	FCC ID:	AMWUT063	IC:	513C-UT063	
DUT Type:	Portable FRS/GMRS UHF PTT Radio Transceiver	DUT Model:	GMR3040	(GMRS/FRS)		
2011 Celltech Labs Inc.	This document is not to be reproduced in whole or in part without the prior written permission of Celltech Labs Inc.					Page 1 of 38





	Test Report Serial No.:	092311AMW-T1124-E95U	Test Report Issue Date:	November 04, 2011	
	Measurement Dates:	September 26-28, 2011	Test Report Revision:	Rev. 1.1 (2nd Release)	
	Rule Part(s) Applied:	FCC 47 CFR §2, §95A, §95B IC RSS-210 (8), RSS-Gen (3)	Test Site Registration:	FCC Accredited Site IC Site File #: 3874A-1	
					Test Lab Certificate No. 2470.01

TABLE OF CONTENTS

1.0 SCOPE	5
2.0 REFERENCES	5
2.1 Normative References	5
3.0 PASS/FAIL CRITERIA.....	5
4.0 FACILITIES AND ACCREDITATIONS	6
5.0 GENERAL INFORMATION	6
5.1 Applicant Information	6
5.2 DUT Description	6
5.3 Rule Part(s) & Classification(s).....	6
5.4 Mode(s) of Operation Tested.....	7
5.5 Modification(s)	7
6.0 ANTENNA REQUIREMENT (FCC §95.647 & IC RSS-210 A6.1.4).....	7
Appendix A RF Output Power Measurement.....	8
Appendix B Modulation Characteristics (Modulation Limiting).....	11
Appendix C Modulation Characteristics (Audio Frequency Response)	15
Appendix D Modulation Characteristics (Low-pass Filter Response).....	17
Appendix E Occupied Bandwidth and Emission Mask	19
Appendix F Radiated Spurious Emissions - TX.....	28
Appendix G Radiated Spurious Emissions - RX	32
Appendix H Frequency Stability	35
END OF DOCUMENT	38



FIGURES

Figure A.5-1 - Setup Drawing – RF Output Power	9
Figure B.5-1 - Setup Drawing – Modulation Characteristics	11
Figure C.5-1 - Setup Drawing – Audio Frequency Response	15
Figure D.5-1 - Setup Drawing – Low-pass Filter Response	17
Figure E.5-1 - Setup Drawing – Occupied Bandwidth & Emission Mask	19
Figure F.6-1 - Setup Drawing – Radiated TX Spurious Emissions	29
Figure G.6-1 - Setup Drawing – Radiated RX Spurious Emissions	33
Figure H.5-1 - Setup Drawing – Frequency Stability	35

	Test Report Serial No.:	092311AMW-T1124-E95U	Test Report Issue Date:	November 04, 2011	 
	Measurement Dates:	September 26-28, 2011	Test Report Revision:	Rev. 1.1 (2nd Release)	
	Rule Part(s) Applied:	FCC 47 CFR §2, §95A, §95B IC RSS-210 (8), RSS-Gen (3)	Test Site Registration:	FCC Accredited Site IC Site File #: 3874A-1	
					Test Lab Certificate No. 2470.01

TEST SUMMARY						
Referenced Standard(s):		FCC CFR Title 47 Parts 2, 95(A/B)				
Appendix	Description of Test	Procedure Reference	Limit Reference	Test Start	Test End	Result
A	Effective Radiated Power (ERP)	ANSI/TIA/EIA-603-C	§95.639	Sept 26	Sept 26	Pass
B	Modulation Limiting	ANSI/TIA/EIA-603-C	§2.1047, §95.637	Sept 27	Sept 27	Pass
C	Audio Frequency Response	ANSI/TIA/EIA-603-C	§2.1047	Sept 27	Sept 27	Pass
D	Low-Pass Filter Response	ANSI/TIA/EIA-603-C	§2.1047, §95.637	Sept 27	Sept 27	Pass
E	Occupied Bandwidth and Emission Mask	ANSI/TIA/EIA-603-C	§2.1049, §95.633, §95.635	Sept 27	Sept 27	Pass
F	Radiated TX Spurious Emissions	ANSI/TIA/EIA-603-C	§2.1053, §95.635 (b) (7)	Sept 26	Sept 26	Pass
G	Radiated RX Spurious Emissions	n/a	n/a	n/a	n/a	n/a
H	Frequency Stability	ANSI/TIA/EIA-603-C	§2.1055, §95.621, §95.627	Sept 28	Sept 28	Pass
Referenced Standard(s):		Industry Canada RSS-210 Issue 8; RSS-Gen Issue 3				
Appendix	Description of Test	Procedure Reference	Limit Reference	Test Start	Test End	Result
A	Effective Radiated Power (ERP)	ANSI/TIA/EIA-603-C	RSS-210 A6.1.4 RSS-210 A6.2.4	Sept 27	Sept 27	Pass
B	Modulation Limiting	ANSI/TIA/EIA-603-C	RSS-210 A6.1.2 RSS-210 A6.2.2	Sept 27	Sept 27	Pass
C	Audio Frequency Response	ANSI/TIA/EIA-603-C	N/A	Sept 27	Sept 27	Pass
D	Low-Pass Filter Response	ANSI/TIA/EIA-603-C	RSS-210 A6.2.2	Sept 27	Sept 27	Pass
E	Occupied Bandwidth and Emission Mask	RSS-Gen 4.6.1	RSS-210 A6.1.3, A6.2.3 A6.1.5, A6.2.5	Sept 27	Sept 27	Pass
F	Radiated TX Spurious Emissions	RSS-Gen 4.9	RSS-210 A6.1.5, A6.2.5	Sept 26	Sept 26	Pass
G	Radiated RX Spurious Emissions	RSS-Gen 4.10	RSS-Gen 6.(a)	Sept 26	Sept 26	Pass
H	Frequency Stability	RSS-Gen 4.7	RSS-210 A6.1.6 RSS-210 A6.2.6	Sept 28	Sept 28	Pass



Applicant:	Uniden America Corporation	FCC ID:	AMWUT063	IC:	513C-UT063	
DUT Type:	Portable FRS/GMRS UHF PTT Radio Transceiver	DUT Model:	GMR3040	(GMRS/FRS)		
2011 Celltech Labs Inc.	This document is not to be reproduced in whole or in part without the prior written permission of Celltech Labs Inc.					Page 3 of 38

	Test Report Serial No.:	092311AMW-T1124-E95U	Test Report Issue Date:	November 04, 2011	  Test Lab Certificate No. 2470.01
	Measurement Dates:	September 26-28, 2011	Test Report Revision:	Rev. 1.1 (2nd Release)	
	Rule Part(s) Applied:	FCC 47 CFR §2, §95A, §95B IC RSS-210 (8), RSS-Gen (3)	Test Site Registration:	FCC Accredited Site IC Site File #: 3874A-1	

REVISION LOG

Revision	Description	Implemented By	Implementation Date
1.0	1st Release	Jon Hughes	October 27, 2011
1.1	2 nd Release – Added note on page 27 describing OBW and Mask plots with asterisk on the SA screen (response to TCB)	Sean Johnston	November 4, 2011

Test Report Prepared By	Date	QA Review By	Date
Sean Johnston	October 26, 2011	Jon Hughes	October 27, 2011

	Test Report Serial No.:	092311AMW-T1124-E95U	Test Report Issue Date:	November 04, 2011	  Test Lab Certificate No. 2470.01
	Measurement Dates:	September 26-28, 2011	Test Report Revision:	Rev. 1.1 (2nd Release)	
	Rule Part(s) Applied:	FCC 47 CFR §2, §95A, §95B IC RSS-210 (8), RSS-Gen (3)	Test Site Registration:	FCC Accredited Site IC Site File #: 3874A-1	

1.0 SCOPE

This report outlines the measurements made and results collected during electromagnetic emissions testing of the Uniden America Corporation Model: GMR3040 Portable FM GMRS/FRS Push-To-Talk (PTT) Radio Transceiver. The measurement results were applied against the applicable EMC requirements and limits outlined in the technical rules and regulations set forth in the Federal Communication's Commission Code of Federal Regulations Title 47 Part 2, Part 95 Subpart A and Subpart B; and Industry Canada Radio Standards Specification RSS-210 Issue 8 and RSS-Gen Issue 3.

2.0 REFERENCES



2.1 Normative References

ANSI/ISO 17025:2005	General Requirements for competence of testing and calibration laboratories
IEEE/ANSI C63.4:2003	Methods of Measurement of Radio-Noise Emissions from Low-Voltage Electrical and Electronic Equipment in the Range of 9 kHz to 40 GHz
ANSI/TIA/EIA-603-C:2004	Land Mobile FM or PM Communication Equipment Measurement and Performance Standards
CFR Title 47 Part 2	Code of Federal Regulations Title 47: Telecommunication Part 2: Frequency Allocations and Radio Treaty Matters; General Rules and Regulations
CFR Title 47 Part 95	Code of Federal Regulations Title 47: Telecommunication Part 95: Personal Radio Services Subpart A - General Mobile Radio Service (GMRS) Subpart B - Family Radio Service (FRS)
IC Spectrum Management & Telecommunications Policy	Radio Standards Specification RSS-210 Issue 8 - Low-Power Licence-Exempt Radiocommunication Devices (All Frequency Bands): Category I Equipment RSS-Gen Issue 3 - General Requirements and Information for the Certification of Radiocommunication Equipment

3.0 PASS/FAIL CRITERIA

Unless otherwise noted in the Appendices, the pass/fail criteria is the limit set forth in the reference standards. The DUT is considered to have passed the requirements if the data collected during the described measurement procedure is no greater than the specified limits as defined. The pass/fail statements made in this report only apply to the unit tested.

Applicant:	Uniden America Corporation	FCC ID:	AMWUT063	IC:	513C-UT063	
DUT Type:	Portable FRS/GMRS UHF PTT Radio Transceiver	DUT Model:	GMR3040	(GMRS/FRS)		
2011 Celltech Labs Inc.	This document is not to be reproduced in whole or in part without the prior written permission of Celltech Labs Inc.					Page 5 of 38

	Test Report Serial No.:	092311AMW-T1124-E95U	Test Report Issue Date:	November 04, 2011	 
	Measurement Dates:	September 26-28, 2011	Test Report Revision:	Rev. 1.1 (2nd Release)	
	Rule Part(s) Applied:	FCC 47 CFR §2, §95A, §95B IC RSS-210 (8), RSS-Gen (3)	Test Site Registration:	FCC Accredited Site IC Site File #: 3874A-1	
					Test Lab Certificate No. 2470.01

4.0 FACILITIES AND ACCREDITATIONS

The facilities used in collecting the test results outlined in this report are located at 21-364 Lougheed Road, Kelowna, British Columbia, Canada V1X 7R8. The radiated emissions site conforms to the requirements set forth in ANSI C63.4 and is filed and listed with Industry Canada under File Number IC 3874A-1. Celltech test site is listed with the FCC as an accredited test facility.

5.0 GENERAL INFORMATION

5.1 Applicant Information

Company Name	UNIDEN AMERICA CORPORATION
Address	4700 Amon Carter Boulevard
	Fort Worth, Texas 76155
	United States



5.2 DUT Description

Device Type	Portable FRS/GMRS Push-To-Talk Radio Transceiver (GMRS/FRS Band)	
Device Model(s)	GMR3040	
Test Sample Serial No.(s)	TA Sample No.2 (Identical Prototype)	
Device Identifier(s)	FCC ID:	AMWUT063
	IC:	513C-UT063
Co-located Transmitter(s)	None	
Power Source Tested	Li-Ion Battery Pack (3.6V, 550mAh) Model: BT-1028	
Antenna Type Tested	Non-detachable	
Antenna Gain Spec.	-3.6 dBi (GMRS), -3.3 dBi (FRS)	

5.3 Rule Part(s) & Classification(s)

Rule Part(s) Applied	FCC	47 CFR §2; §95(A), §95(B)
	IC	RSS-210 Issue 8, RSS-Gen Issue 3
Device Classification(s)	FCC	Licensed Non-Broadcast Transmitter Held to Face (TNF) - GMRS (Part 95A)
		Part 95 Family Radio Face Held Transmitter (FRF) - FRS (Part 95B)
	IC	Low-Power Licence-Exempt Radiocommunication Devices (All Frequency Bands): Category I Equipment (RSS-210) - GMRS/FRS

Applicant:	Uniden America Corporation	FCC ID:	AMWUT063	IC:	513C-UT063	
DUT Type:	Portable FRS/GMRS UHF PTT Radio Transceiver	DUT Model:	GMR3040	(GMRS/FRS)		
2011 Celltech Labs Inc.	This document is not to be reproduced in whole or in part without the prior written permission of Celltech Labs Inc.					Page 6 of 38

	Test Report Serial No.:	092311AMW-T1124-E95U	Test Report Issue Date:	November 04, 2011	 
	Measurement Dates:	September 26-28, 2011	Test Report Revision:	Rev. 1.1 (2nd Release)	
	Rule Part(s) Applied:	FCC 47 CFR §2, §95A, §95B IC RSS-210 (8), RSS-Gen (3)	Test Site Registration:	FCC Accredited Site IC Site File #: 3874A-1	
					Test Lab Certificate No. 2470.01

5.4 Mode(s) of Operation Tested

5.4.1 FRS/GMRS PTT Radio Transceiver

5.4.1.1 FRS

Transmitter Frequency Range(s)	462.5625 - 462.7125 MHz (Chan. 1-7)	467.5625 - 467.7125 MHz (Chan. 8-14)
Transmitter Test Channel(s)	467.5625 MHz (Channel 8)	
Transmitter Test Mode(s)	Enter TX Test Mode (keypad entry) - Select Channel (keypad entry); Continuous Transmit with PTT constantly depressed	
Modulation Type(s)	FM	

5.4.1.2 GMRS

Transmitter Frequency Range(s)	462.5625 - 462.7125 MHz (Chan. 1-7)	462.5500 - 462.7250 MHz (Chan. 15-22)
Transmitter Test Channel(s)	462.5625 MHz (Channel 1)	
Transmitter Test Mode(s)	Enter TX Test Mode (keypad entry) - Select Channel (keypad entry); Continuous Transmit with PTT constantly depressed	
Modulation Type(s)	FM	



5.5 Modification(s)

None

6.0 ANTENNA REQUIREMENT (FCC §95.647 & IC RSS-210 A6.1.4)

Complies

Applicant:	Uniden America Corporation	FCC ID:	AMWUT063	IC:	513C-UT063	
DUT Type:	Portable FRS/GMRS UHF PTT Radio Transceiver	DUT Model:	GMR3040	(GMRS/FRS)		
2011 Celltech Labs Inc.	This document is not to be reproduced in whole or in part without the prior written permission of Celltech Labs Inc.					Page 7 of 38

	Test Report Serial No.:	092311AMW-T1124-E95U	Test Report Issue Date:	November 04, 2011	 
	Measurement Dates:	September 26-28, 2011	Test Report Revision:	Rev. 1.1 (2nd Release)	
	Rule Part(s) Applied:	FCC 47 CFR §2, §95A, §95B IC RSS-210 (8), RSS-Gen (3)	Test Site Registration:	FCC Accredited Site IC Site File #: 3874A-1	
					Test Lab Certificate No. 2470.01

Appendix A RF Output Power Measurement

A.1 REFERENCES

Normative Reference Standard	FCC CFR 47 §2.1046(a), §2.1046(b), 2.1033(c)(6)(7), §95.639; IC RSS-210
Procedure Reference	The RF output power measurements were performed in accordance with TIA/EIA Standard 603 using the substitution method in an anechoic chamber.

A.2 LIMITS

FCC CFR 47 §95.639	Power output shall not exceed 0.50 Watts effective radiated power for the FRS channels. There can be no provisions for increasing the power or varying the power. No GMRS channel, under any condition of modulation, shall exceed: 1. 50W Carrier power (average TP during one modulated RF cycle) when transmitting emissions type A1D, F1D, G1D, A3E, F3E, or G3E. 2. 50W peak envelope TP when transmitting emission type H1D, J1D, R1D, H3E, J3E or R3E.
RSS-210 A6.1.4	The maximum permissible transmitter output power under any operating conditions is 0.5 W effective radiated power (e.r.p.). The radio shall be equipped with an integral antenna.
RSS-210 A6.2.4	A GMRS transmitter may transmit with a maximum power of 2 W e.r.p.



A.3 ENVIRONMENTAL CONDITIONS

Temperature	10 °C
Humidity	40 +/- 10 %
Barometric Pressure	101 +/- 3 kPa

ASSET NUMBER	MANUFACTURER	MODEL	DESCRIPTION	CAL DUE
00015	HP	E4408B	Spectrum Analyzer	03-May-12
00007	Gigatronics	8652A	Power Meter	04-May-12
00014	Gigatronics	80701A	Power Sensor	04-May-12
00072	EMCO	2075	Mini-mast	cnr
00073	EMCO	2080	Turn Table	cnr
00071	EMCO	2090	Multi-Device Controller	cnr
00015	HP	E4408B	Spectrum Analyzer	03-May-12
00050	Chase	CBL-6111A	Bilog Antenna	06-May-13
00055	EMCO	3121C	Dipole Antenna	27-Aug-12
00034	ETS	3115	Double Ridged Guide Horn	29-May-13

cnr = calibration not required

Applicant:	Uniden America Corporation	FCC ID:	AMWUT063	IC:	513C-UT063	
DUT Type:	Portable FRS/GMRS UHF PTT Radio Transceiver	DUT Model:	GMR3040	(GMRS/FRS)		
2011 Celltech Labs Inc.	This document is not to be reproduced in whole or in part without the prior written permission of Celltech Labs Inc.					Page 8 of 38

	Test Report Serial No.:	092311AMW-T1124-E95U	Test Report Issue Date:	November 04, 2011	 
	Measurement Dates:	September 26-28, 2011	Test Report Revision:	Rev. 1.1 (2nd Release)	
	Rule Part(s) Applied:	FCC 47 CFR §2, §95A, §95B IC RSS-210 (8), RSS-Gen (3)	Test Site Registration:	FCC Accredited Site IC Site File #: 3874A-1	
Test Lab Certificate No. 2470.01					



A.4 MEASUREMENT EQUIPMENT SETUP

MEASUREMENT EQUIPMENT CONNECTIONS	For the field strength measurements the measurement equipment was connected as shown in A.6. For the final substitutions the DUT was replaced with a dipole antenna and fed from a CW signal source sufficient to replicate the received field strength of the emission being investigated.			
	Frequency Range	RX Antenna	TX Antenna	
	30 MHz - 1GHz	Bilog	Dipole	
MEASUREMENT EQUIPMENT SETTINGS	For measuring the radiated field strength of the fundamental, the spectrum analyzer was set to the following settings:			
	Mode	RBW	VBW	Detector
		MHz	MHz	
	GMRS (Hi Power)	1	3	Peak
FRS (Lo Power)	1	3	Peak	

A.5 SETUP DRAWING

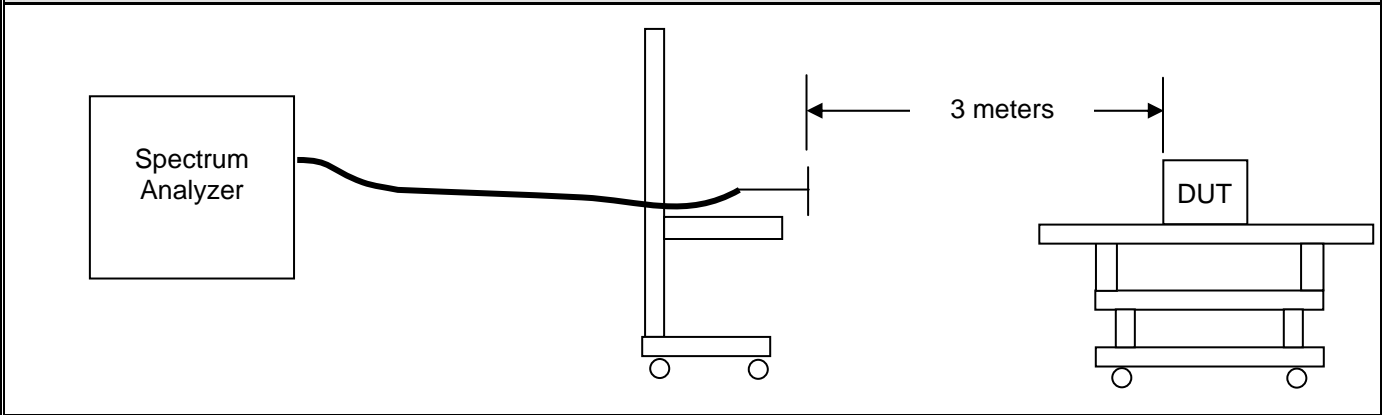
Figure A.5-1 - Setup Drawing – RF Output Power



	Test Report Serial No.:	092311AMW-T1124-E95U	Test Report Issue Date:	November 04, 2011	 
	Measurement Dates:	September 26-28, 2011	Test Report Revision:	Rev. 1.1 (2nd Release)	
	Rule Part(s) Applied:	FCC 47 CFR §2, §95A, §95B IC RSS-210 (8), RSS-Gen (3)	Test Site Registration:	FCC Accredited Site IC Site File #: 3874A-1	
					Test Lab Certificate No. 2470.01

A.6 TEST RESULTS

Measured Frequency (MHz)	Output Power (ERP) (Watts)
462.5625 (GMRS)	0.62
467.5625 (FRS)	0.41

Note(s):

1. Measured ERP Carrier Level (dBm) = Power Applied to Antenna (dBm) + Antenna Gain (dBd)
2. The DUT was measured in 3 orientations with respect to the receive antenna and the orientation with the highest Radiated Power results is shown (Vertical Polarization).

FCC Rule Part 2.1033 (C)(8) DC Input into final amplifier

Frequency (MHz)	Voltage V	Current A
462.5625 (GMRS)	3.6	0.50
467.5625 (FRS)	3.6	0.35

A.7 PASS/FAIL

In reference to the results outlined in A.6, the DUT passes the requirements as stated in the reference standards.

A.8 SIGN-OFF

I attest to the accuracy of the data. All measurements reported herein were performed by me and are correct to the best of my knowledge and belief. I assume full responsibility for the completeness of these measurements.





Sean Johnston
Lab Manager
Celltech Labs Inc.

Sept. 26, 2011

Date

Applicant:	Uniden America Corporation	FCC ID:	AMWUT063	IC:	513C-UT063	
DUT Type:	Portable FRS/GMRS UHF PTT Radio Transceiver	DUT Model:	GMR3040	(GMRS/FRS)		
2011 Celltech Labs Inc.	This document is not to be reproduced in whole or in part without the prior written permission of Celltech Labs Inc.					Page 10 of 38

	Test Report Serial No.:	092311AMW-T1124-E95U	Test Report Issue Date:	November 04, 2011	 
	Measurement Dates:	September 26-28, 2011	Test Report Revision:	Rev. 1.1 (2nd Release)	
	Rule Part(s) Applied:	FCC 47 CFR §2, §95A, §95B IC RSS-210 (8), RSS-Gen (3)	Test Site Registration:	FCC Accredited Site IC Site File #: 3874A-1	
					Test Lab Certificate No. 2470.01

Appendix B Modulation Characteristics (Modulation Limiting)

B.1 REFERENCES

Normative Reference Standard	FCC CFR 47 §2.1047, §95.637; IC RSS-210
Procedure Reference	TIA-603-C

B.2 LIMITS

§95.637 (a)	(a) A GMRS transmitter that transmits emission types F1D, G1D, or G3E must not exceed a peak frequency deviation of plus or minus 5 kHz. A GMRS transmitter that transmits emission type F3E must not exceed a peak frequency deviation of plus or minus 5 kHz. A FRS unit that transmits emission type F3E must not exceed a peak frequency deviation of plus or minus 2.5 kHz, and the audio frequency response must not exceed 3.125 kHz.
RSS-210 A6.1.2	(c) The peak frequency deviation shall not exceed ± 2.5 kHz. The limiter shall be followed by a low-pass filter to remove unwanted harmonics.
RSS-210 A6.2.2	(b) For emission types F1D, G1D, G3E, F3E or F2D, the peak frequency deviation shall not exceed ± 5 kHz. GMRS transmitters must include an audio frequency low-pass filter, unless they comply with the appropriate emission masks in Section A6.2.5, below. The filter must be between the modulation limiter and the modulated stage of the transmitter. The filter attenuation must be as follows: for 3 kHz $\leq f \leq 20$ kHz, the attenuation is at least 60 $\log_{10}(f, \text{kHz}/3)$ dB greater than the attenuation at 1 kHz, and for $f > 20$ kHz, the attenuation is at least 50 dB greater than the attenuation at 1 kHz.

B.3 ENVIRONMENTAL CONDITIONS

Temperature	25 +/- 5 °C
Humidity	40 +/- 10 %
Barometric Pressure	101 +/- 3 kPa

B.4 EQUIPMENT LIST

ASSET NUMBER	MANUFACTURER	MODEL	DESCRIPTION	CAL DUE
00028	HP	8901A	Modulation Analyzer	21Jul12
00027	HP	8903B	Audio Generator/Analyzer	21Jul12

B.5 SETUP DRAWING

Figure B.5-1 - Setup Drawing – Modulation Characteristics

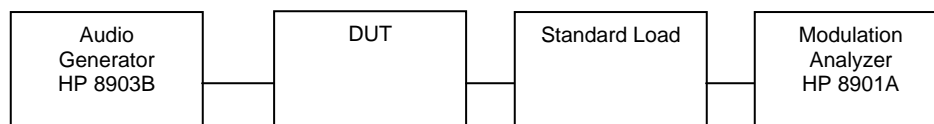

Applicant:	Uniden America Corporation	FCC ID:	AMWUT063	IC:	513C-UT063	
DUT Type:	Portable FRS/GMRS UHF PTT Radio Transceiver	DUT Model:	GMR3040	(GMRS/FRS)		
2011 Celltech Labs Inc.	This document is not to be reproduced in whole or in part without the prior written permission of Celltech Labs Inc.					Page 11 of 38

B.6 TEST RESULTS

B.6.1 GMRS

Audio Level	Deviation @ 1.0 KHz	Deviation @ 300 Hz	Deviation @ 3.0 KHz	Deviation @ 2.5 KHz	FCC Limit
mV	[KHz]	[KHz]	[KHz]	[KHz]	[KHz]
1.00	0.52	0.35	0.64	0.73	2.5
5.00	1.44	0.35	1.37	1.80	2.5
10.00	1.92	0.34	1.40	1.87	2.5
20.00	2.01	0.35	1.40	1.87	2.5
30.00	2.02	0.37	1.40	1.90	2.5
40.00	2.02	0.38	1.40	1.89	2.5
50.00	2.02	0.40	1.40	1.89	2.5
60.00	2.02	0.41	1.40	1.89	2.5
70.00	2.02	0.43	1.40	1.89	2.5
80.00	2.02	0.45	1.40	1.89	2.5
90.00	2.02	0.48	1.42	1.89	2.5
100.00	2.02	0.49	1.42	1.90	2.5

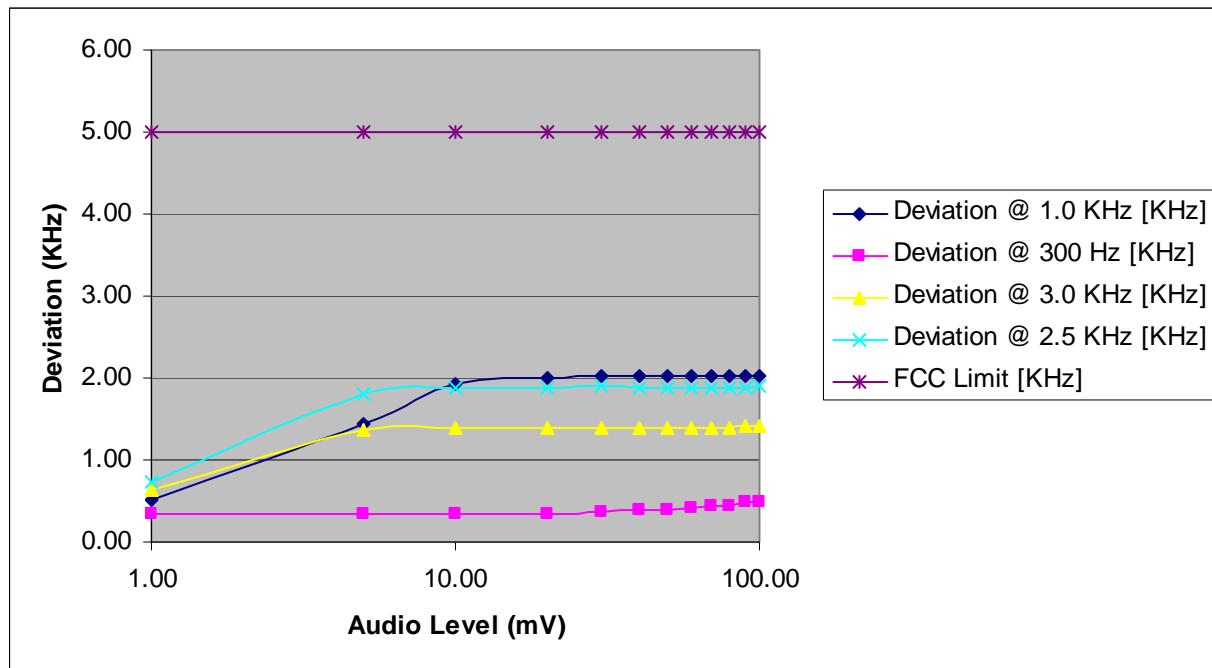

B.7 PASS/FAIL

In reference to the results outlined in B.6.1 the DUT passes the requirements as stated in the reference standards.

B.8 TEST RESULTS

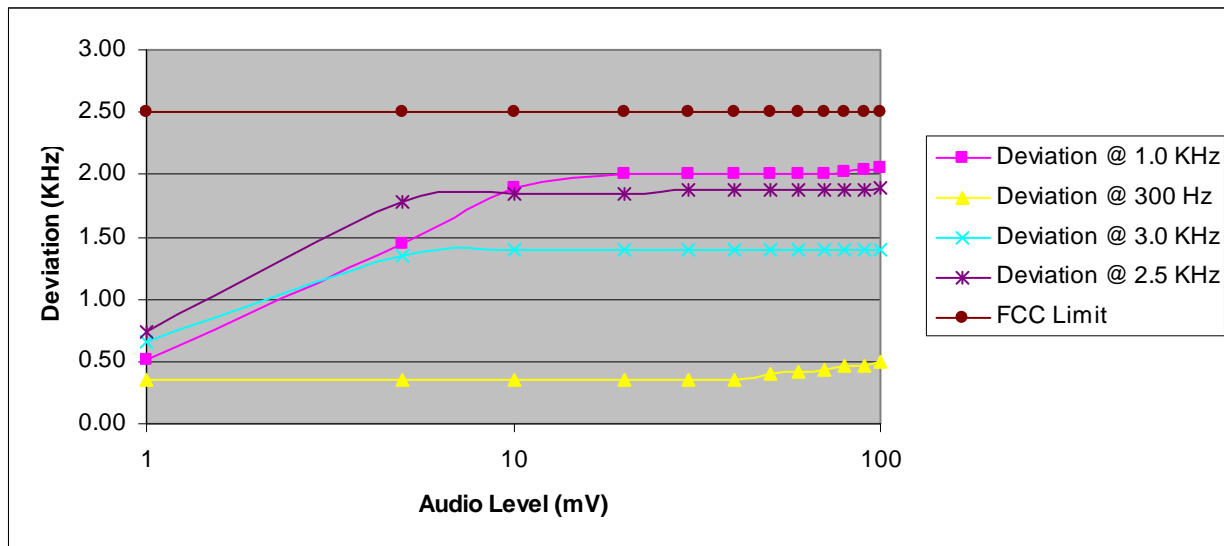

B.8.1 FRS

Audio Level	Deviation @ 1.0 KHz	Deviation @ 300 Hz	Deviation @ 3.0 KHz	Deviation @ 2.5 KHz	FCC
mV	[KHz]	[KHz]	[KHz]	[KHz]	[KHz]
1	0.52	0.35	0.65	0.74	2.50
5	1.44	0.35	1.35	1.78	2.50
10	1.90	0.35	1.39	1.85	2.50
20	2.00	0.35	1.40	1.85	2.50
30	2.00	0.35	1.40	1.87	2.50
40	2.00	0.35	1.40	1.87	2.50
50	2.00	0.40	1.40	1.87	2.50
60	2.01	0.42	1.40	1.87	2.50
70	2.01	0.44	1.40	1.87	2.50
80	2.02	0.46	1.40	1.88	2.50
90	2.03	0.47	1.40	1.88	2.50
100	2.05	0.49	1.40	1.89	2.50



B.9 PASS/FAIL

In reference to the results outlined in B.8.1 the DUT passes the requirements as stated in the reference standards.

	Test Report Serial No.:	092311AMW-T1124-E95U	Test Report Issue Date:	November 04, 2011	 
	Measurement Dates:	September 26-28, 2011	Test Report Revision:	Rev. 1.1 (2nd Release)	
	Rule Part(s) Applied:	FCC 47 CFR §2, §95A, §95B IC RSS-210 (8), RSS-Gen (3)	Test Site Registration:	FCC Accredited Site IC Site File #: 3874A-1	
					Test Lab Certificate No. 2470.01

B.10 SIGN-OFF

I attest to the accuracy of the data. All measurements reported herein were performed by me and are correct to the best of my knowledge and belief. I assume full responsibility for the completeness of these measurements.





Sean Johnston
Lab Manager
Celltech Labs Inc.

Sept. 27, 2011

Date

Applicant:	Uniden America Corporation	FCC ID:	AMWUT063	IC:	513C-UT063	
DUT Type:	Portable FRS/GMRS UHF PTT Radio Transceiver	DUT Model:	GMR3040	(GMRS/FRS)		
2011 Celltech Labs Inc.	This document is not to be reproduced in whole or in part without the prior written permission of Celltech Labs Inc.					Page 14 of 38

	Test Report Serial No.:	092311AMW-T1124-E95U	Test Report Issue Date:	November 04, 2011	 
	Measurement Dates:	September 26-28, 2011	Test Report Revision:	Rev. 1.1 (2nd Release)	
	Rule Part(s) Applied:	FCC 47 CFR §2, §95A, §95B IC RSS-210 (8), RSS-Gen (3)	Test Site Registration:	FCC Accredited Site IC Site File #: 3874A-1	
					Test Lab Certificate No. 2470.01

Appendix C Modulation Characteristics (Audio Frequency Response)

C.1 REFERENCES

Normative Reference Standard	FCC CFR 47 §2.1047
Procedure Reference	TIA-603-C

C.2 LIMITS

§2.1047	a) <i>Voice modulated communication equipment.</i> A curve or equivalent data showing the frequency response of the audio modulating circuit over a range of 100 to 5000 Hz shall be submitted. For equipment required to have an audio low-pass filter, a curve showing the frequency response of the filter or of all circuitry installed between the modulation limiter and the modulated stage shall be submitted.
---------	--

C.3 ENVIRONMENTAL CONDITIONS

Temperature	25 +/- 5 °C
Humidity	40 +/- 10 %
Barometric Pressure	101 +/- 3 kPa



C.4 EQUIPMENT LIST

ASSET NUMBER	MANUFACTURER	MODEL	DESCRIPTION	CAL DUE
00028	HP	8901A	Modulation Analyzer	21Jul12
00027	HP	8903B	Audio Generator/Analyzer	21Jul12

C.5 SETUP DRAWING

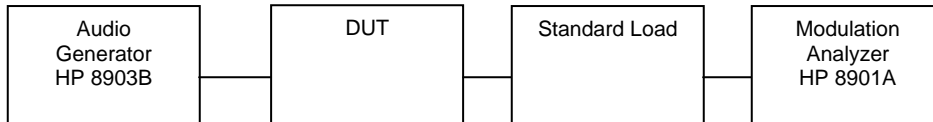
Figure C.5-1 - Setup Drawing – Audio Frequency Response



	Test Report Serial No.:	092311AMW-T1124-E95U	Test Report Issue Date:	November 04, 2011	 
	Measurement Dates:	September 26-28, 2011	Test Report Revision:	Rev. 1.1 (2nd Release)	
	Rule Part(s) Applied:	FCC 47 CFR §2, §95A, §95B IC RSS-210 (8), RSS-Gen (3)	Test Site Registration:	FCC Accredited Site IC Site File #: 3874A-1	
Test Lab Certificate No. 2470.01					

C.6 TEST RESULTS

Audio Frequency	Deviation
[Hz]	[dB]
300	-7.13
400	-5.04
500	-3.02
600	-2.54
700	-2.08
1000	-0.23
1250	0.88
1500	2.23
2000	3.56
2250	4.08
2500	4.01
2750	3.86
3000	2.67
4000	-1.51
5000	-3.35
6000	-5.25

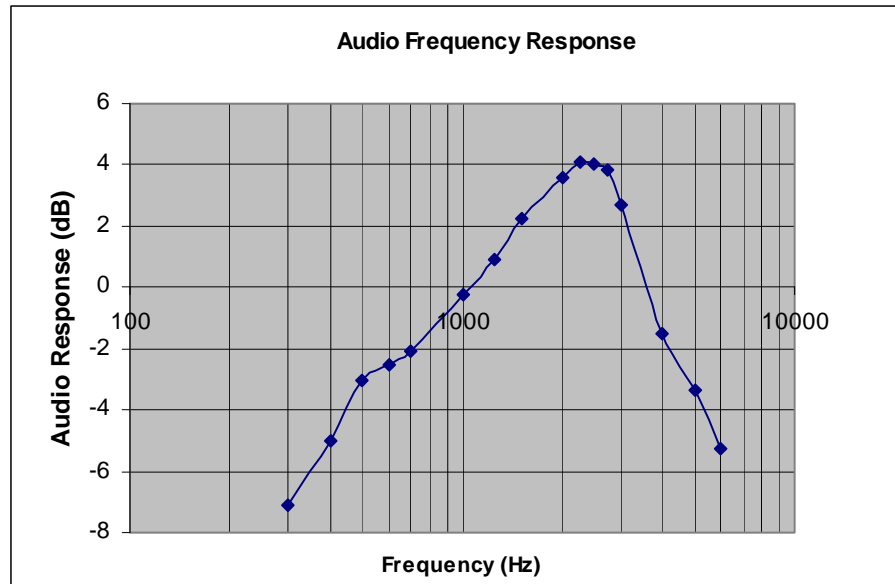

C.7 PASS/FAIL

In reference to the results outlined in C.6 the DUT passes the requirements as stated in the reference standards.

C.8 SIGN-OFF



I attest to the accuracy of the data. All measurements reported herein were performed by me and are correct to the best of my knowledge and belief. I assume full responsibility for the completeness of these measurements.



Sean Johnston
Lab Manager
Celltech Labs Inc.

Sept. 27, 2011

Date

	Test Report Serial No.:	092311AMW-T1124-E95U	Test Report Issue Date:	November 04, 2011	 
	Measurement Dates:	September 26-28, 2011	Test Report Revision:	Rev. 1.1 (2nd Release)	
	Rule Part(s) Applied:	FCC 47 CFR §2, §95A, §95B IC RSS-210 (8), RSS-Gen (3)	Test Site Registration:	FCC Accredited Site IC Site File #: 3874A-1	
					Test Lab Certificate No. 2470.01

Appendix D Modulation Characteristics (Low-pass Filter Response)

D.1 REFERENCES

Normative Reference Standard	FCC CFR 47 §2.1047, §95.637; IC RSS-210
Procedure Reference	TIA-603-C

D.2 LIMITS

§95.637 & RSS-210 A6.2.2	(b) Each GMRS transmitter, except a mobile station transmitter with a power output of 2.5 W or less, must automatically prevent a greater than normal audio level from causing overmodulation. The transmitter also must include audio frequency low-pass filtering, unless it complies with the applicable paragraphs of §95.631 (without filtering.) The filter must be between the modulation limiter and the modulated stage of the transmitter. At any frequency (f in kHz) between 3 and 20 kHz, the filter must have an attenuation of at least $60 \log_{10}(f/3)$ dB greater than the attenuation at 1 kHz. Above 20 kHz, it must have an attenuation of at least 50 dB greater than the attenuation at 1 kHz.
--------------------------	---

D.3 ENVIRONMENTAL CONDITIONS

Temperature	25 +/- 5 °C
Humidity	40 +/- 10 %
Barometric Pressure	101 +/- 3 kPa

D.4 EQUIPMENT LIST

ASSET NUMBER	MANUFACTURER	MODEL	DESCRIPTION	CAL DUE
00027	HP	8903B	Audio Generator/Analyzer	21Jul12

D.5 SETUP DRAWING

Figure D.5-1 - Setup Drawing – Low-pass Filter Response

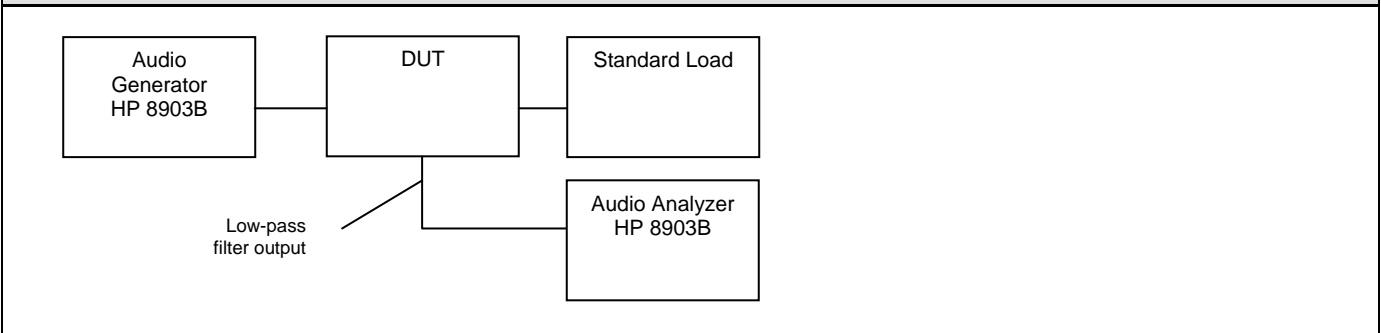

Applicant:	Uniden America Corporation	FCC ID:	AMWUT063	IC:	513C-UT063	
DUT Type:	Portable FRS/GMRS UHF PTT Radio Transceiver	DUT Model:	GMR3040	(GMRS/FRS)		
2011 Celltech Labs Inc.	This document is not to be reproduced in whole or in part without the prior written permission of Celltech Labs Inc.					Page 17 of 38

D.6 TEST RESULTS

Audio Frequency	Response Attenuation	Limit
[Hz]	[dB]	[dB]
1000	0.00	0
1250	-0.05	0
1500	-0.06	0
2000	-0.23	0
2250	-0.61	0
2500	-1.41	0
3000	-3.99	0
4000	-11.11	-7.4
5000	-18.10	-13.3
6000	-23.60	-18
7000	-27.50	-22
8000	-32.10	-25.5
9000	-35.40	-28.6
10000	-38.50	-31.3
15000	-49.80	-41.9
20000	-55.90	-49.4
25000	-60.00	-50

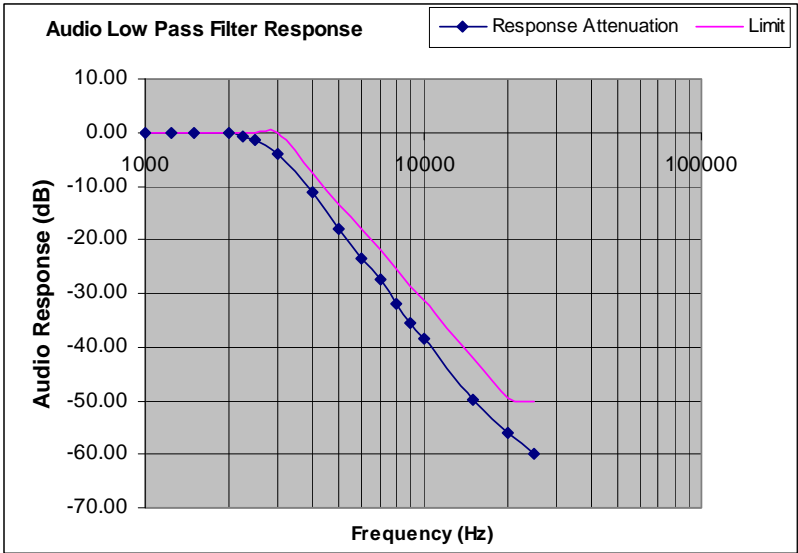

D.7 PASS/FAIL

In reference to the results outlined in D.6, the DUT passes the requirements as stated in the reference standards.

D.8 SIGN-OFF



I attest to the accuracy of the data. All measurements reported herein were performed by me and are correct to the best of my knowledge and belief. I assume full responsibility for the completeness of these measurements.



 Sean Johnston
 Lab Manager
 Celltech Labs Inc.

 Sept. 27, 2011

 Date

	Test Report Serial No.:	092311AMW-T1124-E95U	Test Report Issue Date:	November 04, 2011	 
	Measurement Dates:	September 26-28, 2011	Test Report Revision:	Rev. 1.1 (2nd Release)	
	Rule Part(s) Applied:	FCC 47 CFR §2, §95A, §95B IC RSS-210 (8), RSS-Gen (3)	Test Site Registration:	FCC Accredited Site IC Site File #: 3874A-1	
					Test Lab Certificate No. 2470.01

Appendix E Occupied Bandwidth and Emission Mask

E.1 REFERENCES

Normative Reference Standard	FCC CFR 47 §2.1049, §95.633, §95.635; IC RSS-210
Procedure Reference / Description	Occupied bandwidth was performed by connecting the output of the DUT to the input of a spectrum analyzer. The unit was supplied a 2500Hz audio signal and the 20dB bandwidth was measured for both the FRS and GMRS modes.

E.2 LIMITS

§95.633 & RSS-210 A6.1.3, A6.2.3	The <i>authorized bandwidth</i> (maximum permissible bandwidth of a transmission) for emission type H1D, J1D, R1D, H3E, J3E or R3E is 4 kHz. The authorized bandwidth for emission type A1D or A3E is 8 kHz. The authorized bandwidth for emission type F1D, G1D, F3E or G3E is 20 kHz. The authorized bandwidth for emission type F3E or F2D transmitted by a FRS unit is 12.5 kHz.
§95.635 & RSS-210 A6.1.5, A6.2.5	At least 25 dB (decibels) on any frequency removed from the center of the authorized bandwidth by more than 50% up to and including 100% of the authorized bandwidth. At least 35 dB on any frequency removed from the center of the authorized bandwidth by more than 100% up to and including 250% of the authorized bandwidth. At least 43 + 10 log ₁₀ (T) dB on any frequency removed from the center of the authorized bandwidth by more than 250%.

E.3 ENVIRONMENTAL CONDITIONS

Temperature	10 °C
Humidity	40 +/- 10 %
Barometric Pressure	101 +/- 3 kPa

E.4 EQUIPMENT LIST



ASSET NUMBER	MANUFACTURER	MODEL	DESCRIPTION	CAL DUE
00051	HP	8566B	Spectrum Analyzer RF Section	03-May-12
00047	HP	85685A	RF Preselector	05-May-12
00027	HP	8903B	Audio Generator/Analyzer	21-Jul-12

E.5 SETUP DRAWING

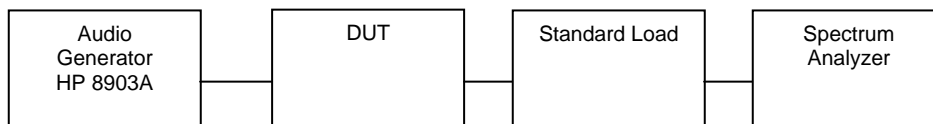
Figure E.5-1 - Setup Drawing – Occupied Bandwidth & Emission Mask



Applicant:	Uniden America Corporation	FCC ID:	AMWUT063	IC:	513C-UT063	
DUT Type:	Portable FRS/GMRS UHF PTT Radio Transceiver	DUT Model:	GMR3040	(GMRS/FRS)		
2011 Celltech Labs Inc.	This document is not to be reproduced in whole or in part without the prior written permission of Celltech Labs Inc.					Page 19 of 38

	Test Report Serial No.:	092311AMW-T1124-E95U	Test Report Issue Date:	November 04, 2011	 
	Measurement Dates:	September 26-28, 2011	Test Report Revision:	Rev. 1.1 (2nd Release)	
	Rule Part(s) Applied:	FCC 47 CFR §2, §95A, §95B IC RSS-210 (8), RSS-Gen (3)	Test Site Registration:	FCC Accredited Site IC Site File #: 3874A-1	
					Test Lab Certificate No. 2470.01

E.6 EMISSION DESIGNATOR & FREQUENCIES

2.1033(c) (4) Type of Emission: 11K0F3E

95.631

$B_n = 2M + 2DK$

$M = 3000$

$D = 2.5K$

$B_n = 2(3000) + 2(2500) = 11K$

GMRS Authorized Bandwidth 20.0 kHz

2.1033(c)(5) GMRS Frequency Range (MHz):

95.621

1. 462.5500 13. 462.7000
2. 462.5625 14. 462.7125
3. 462.5750 15. 462.7250
4. 462.5875
5. 462.6000
6. 462.6125
7. 462.6250
8. 462.6375
9. 462.6500
10. 462.6625
11. 462.6750
12. 462.6875

FRS Authorized Bandwidth 12.5 kHz

2.1033(c)(5) FRS Frequency Range (MHz):

95.627

1. 462.5625 8. 467.5625
2. 462.5875 9. 467.5875
3. 462.6125 10. 467.6125
4. 462.6375 11. 467.6375
5. 462.6625 12. 467.6625
6. 462.6875 13. 467.6875
7. 462.7125 14. 467.7125

Applicant:	Uniden America Corporation	FCC ID:	AMWUT063	IC:	513C-UT063	
DUT Type:	Portable FRS/GMRS UHF PTT Radio Transceiver	DUT Model:	GMR3040	(GMRS/FRS)		
2011 Celltech Labs Inc.	This document is not to be reproduced in whole or in part without the prior written permission of Celltech Labs Inc.					Page 20 of 38

Test Report Serial No.:	092311AMW-T1124-E95U	Test Report Issue Date:	November 04, 2011
Measurement Dates:	September 26-28, 2011	Test Report Revision:	Rev. 1.1 (2nd Release)
Rule Part(s) Applied:	FCC 47 CFR §2, §95A, §95B	Test Site Registration:	FCC Accredited Site
	IC RSS-210 (8), RSS-Gen (3)		IC Site File #: 3874A-1

E.7 TEST RESULTS

E.7.1 Occupied Bandwidth

E.7.1.1 FRS

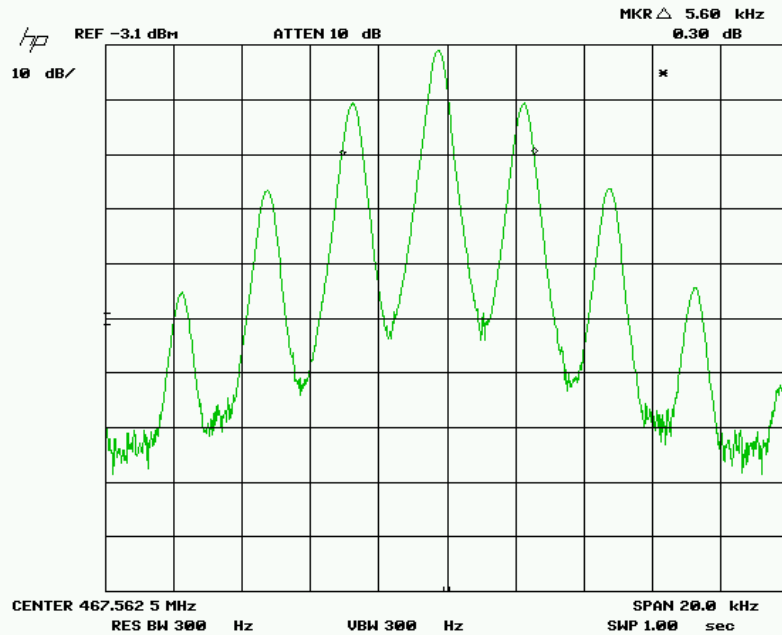

E.7.1.2 GMRS

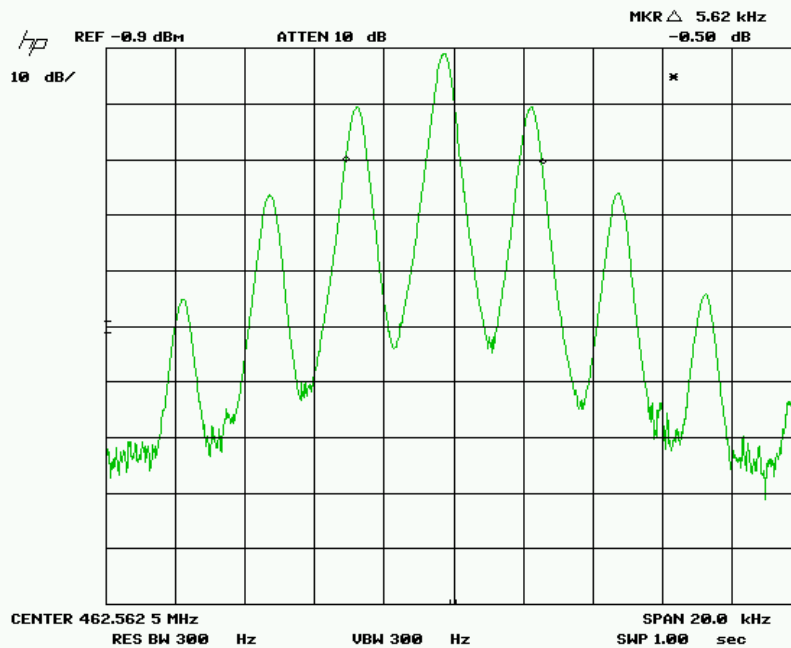

Applicant:	Uniden America Corporation	FCC ID:	AMWUT063	IC:	513C-UT063	
DUT Type:	Portable FRS/GMRS UHF PTT Radio Transceiver	DUT Model:	GMR3040	(GMRS/FRS)		
2011 Celltech Labs Inc.		This document is not to be reproduced in whole or in part without the prior written permission of Celltech Labs Inc.				Page 21 of 38

Test Report Serial No.:	092311AMW-T1124-E95U	Test Report Issue Date:	November 04, 2011
Measurement Dates:	September 26-28, 2011	Test Report Revision:	Rev. 1.1 (2nd Release)
Rule Part(s) Applied:	FCC 47 CFR §2, §95A, §95B	Test Site Registration:	FCC Accredited Site
	IC RSS-210 (8), RSS-Gen (3)		IC Site File #: 3874A-1

E.7.1.3 FRS CTCSS

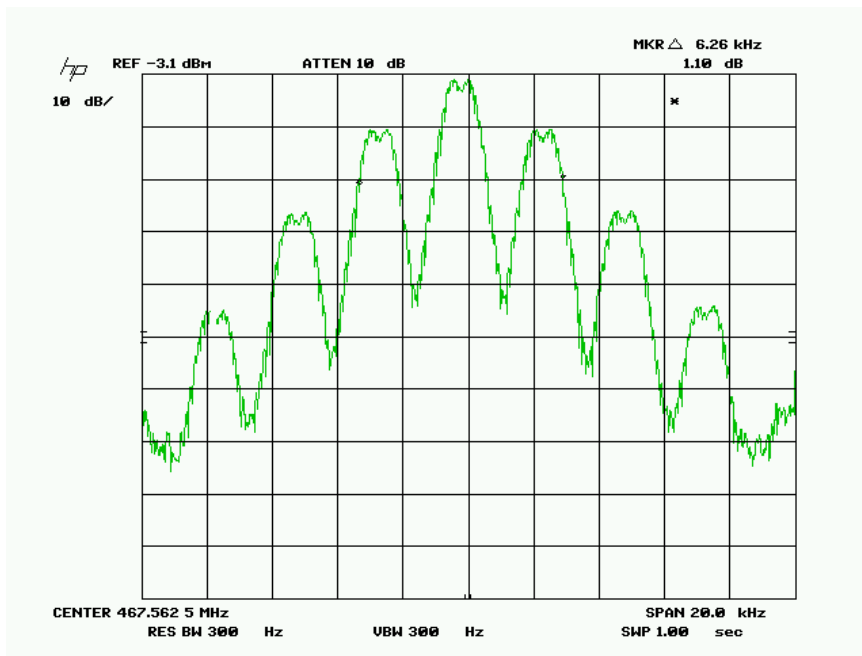

E.7.1.4 FRS DCS

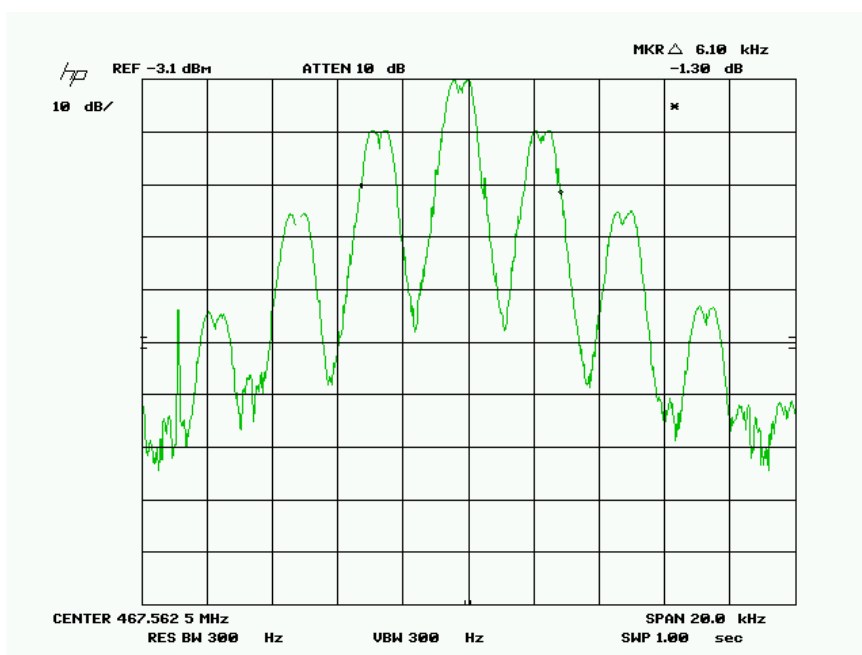

Test Report Serial No.:	092311AMW-T1124-E95U	Test Report Issue Date:	November 04, 2011
Measurement Dates:	September 26-28, 2011	Test Report Revision:	Rev. 1.1 (2nd Release)
Rule Part(s) Applied:	FCC 47 CFR §2, §95A, §95B	Test Site Registration:	FCC Accredited Site
	IC RSS-210 (8), RSS-Gen (3)		IC Site File #: 3874A-1

E.7.1.5 GMRS CTCSS

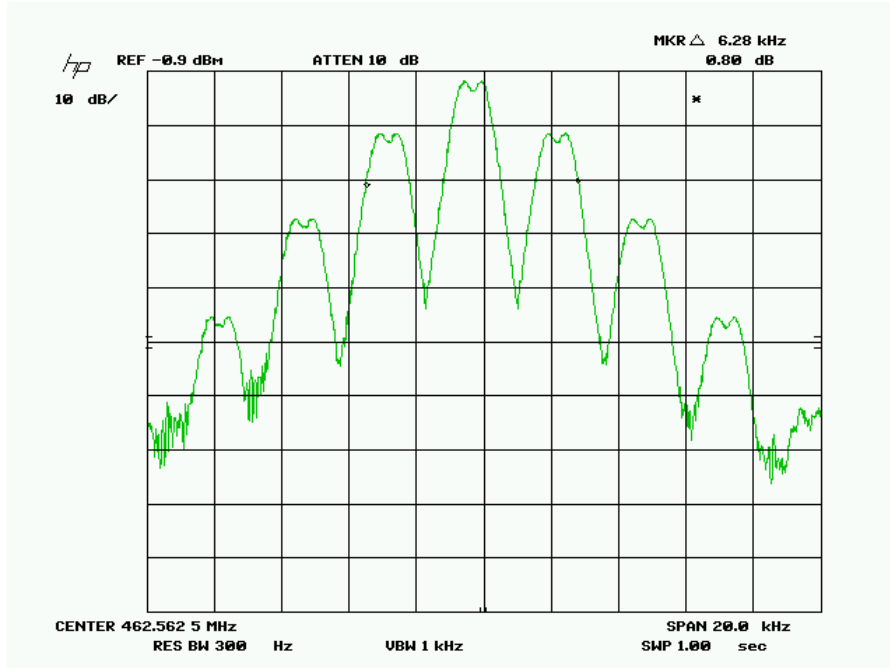

E.7.1.6 GMRS DCS

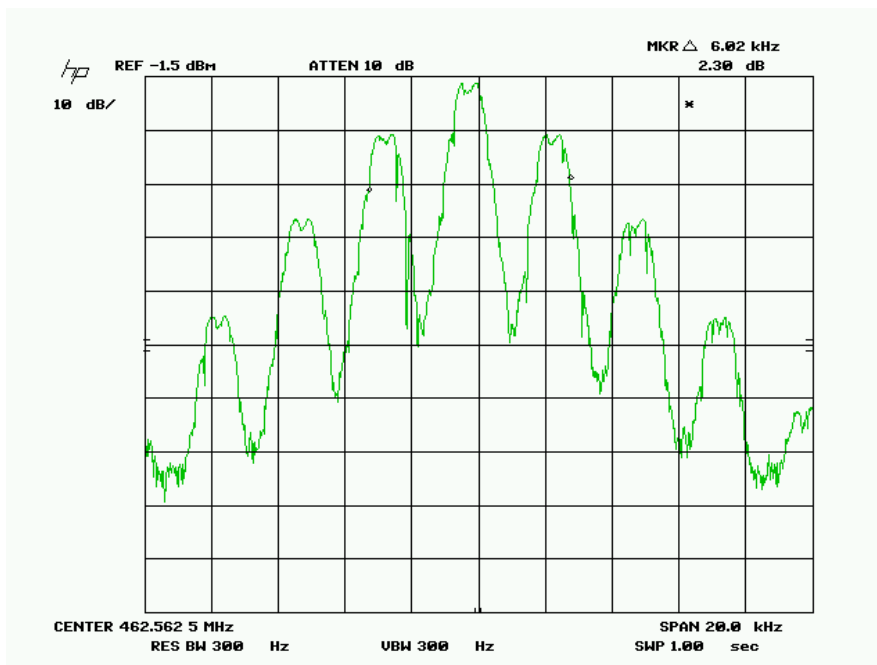

Applicant:	Uniden America Corporation	FCC ID:	AMWUT063	IC:	513C-UT063	
DUT Type:	Portable FRS/GMRS UHF PTT Radio Transceiver	DUT Model:	GMR3040	(GMRS/FRS)		
2011 Celltech Labs Inc.		This document is not to be reproduced in whole or in part without the prior written permission of Celltech Labs Inc.				Page 23 of 38

Test Report Serial No.:	092311AMW-T1124-E95U	Test Report Issue Date:	November 04, 2011
Measurement Dates:	September 26-28, 2011	Test Report Revision:	Rev. 1.1 (2nd Release)
Rule Part(s) Applied:	FCC 47 CFR §2, §95A, §95B	Test Site Registration:	FCC Accredited Site
	IC RSS-210 (8), RSS-Gen (3)		IC Site File #: 3874A-1

E.7.2 Emission Mask

E.7.2.1 FRS

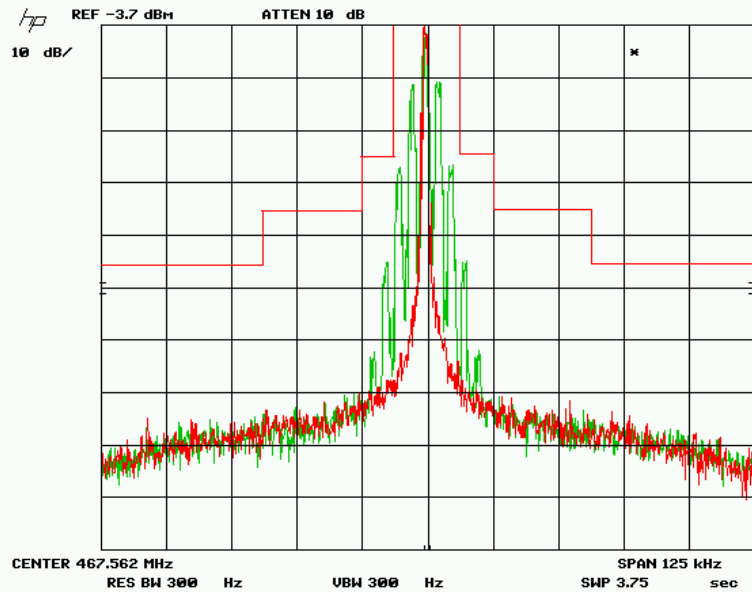

E.7.2.2 GMRS

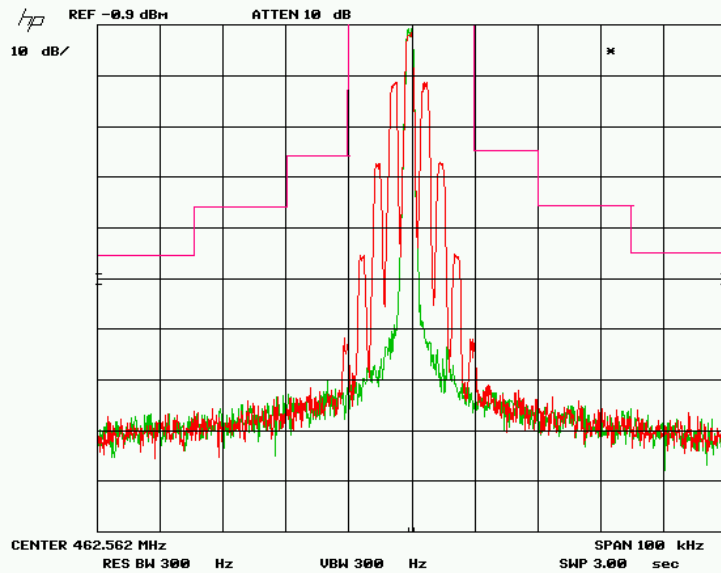

Applicant:	Uniden America Corporation	FCC ID:	AMWUT063	IC:	513C-UT063	
DUT Type:	Portable FRS/GMRS UHF PTT Radio Transceiver	DUT Model:	GMR3040	(GMRS/FRS)		
2011 Celltech Labs Inc.		This document is not to be reproduced in whole or in part without the prior written permission of Celltech Labs Inc.				Page 24 of 38

Test Report Serial No.:	092311AMW-T1124-E95U	Test Report Issue Date:	November 04, 2011
Measurement Dates:	September 26-28, 2011	Test Report Revision:	Rev. 1.1 (2nd Release)
Rule Part(s) Applied:	FCC 47 CFR §2, §95A, §95B	Test Site Registration:	FCC Accredited Site
	IC RSS-210 (8), RSS-Gen (3)		IC Site File #: 3874A-1

E.7.2.3 FRS CTCSS

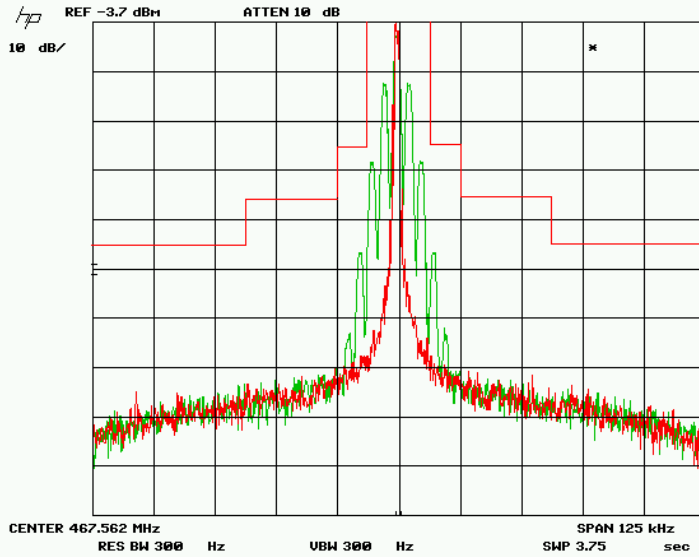

E.7.2.4 FRS DCS

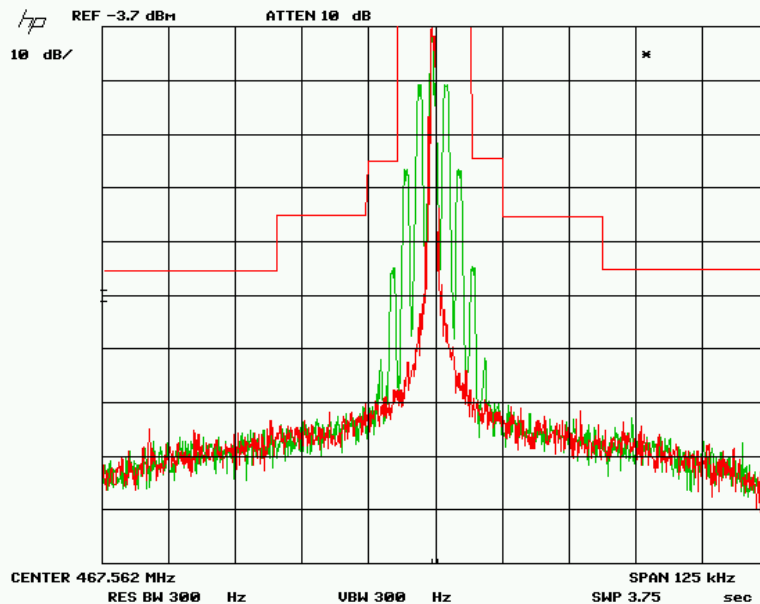

Test Report Serial No.:	092311AMW-T1124-E95U	Test Report Issue Date:	November 04, 2011
Measurement Dates:	September 26-28, 2011	Test Report Revision:	Rev. 1.1 (2nd Release)
Rule Part(s) Applied:	FCC 47 CFR §2, §95A, §95B	Test Site Registration:	FCC Accredited Site
	IC RSS-210 (8), RSS-Gen (3)		IC Site File #: 3874A-1

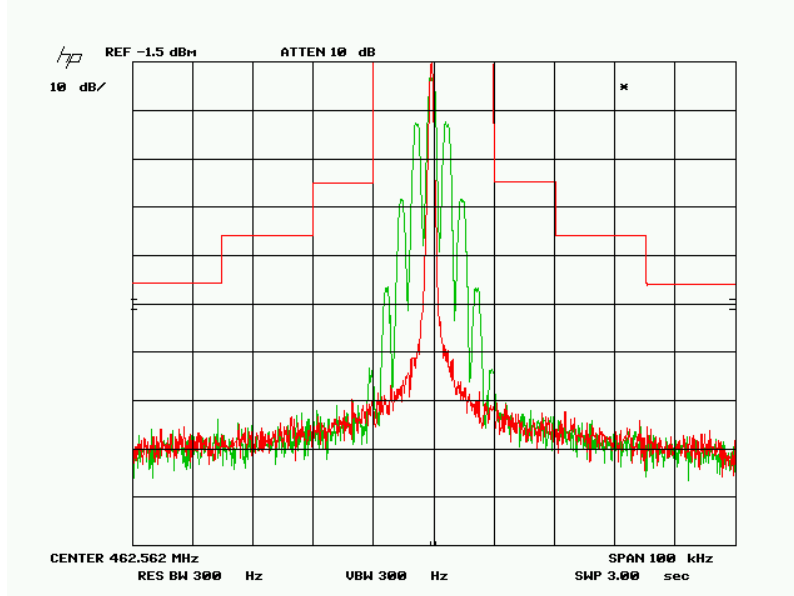

E.7.2.5 GMRS CTCSS

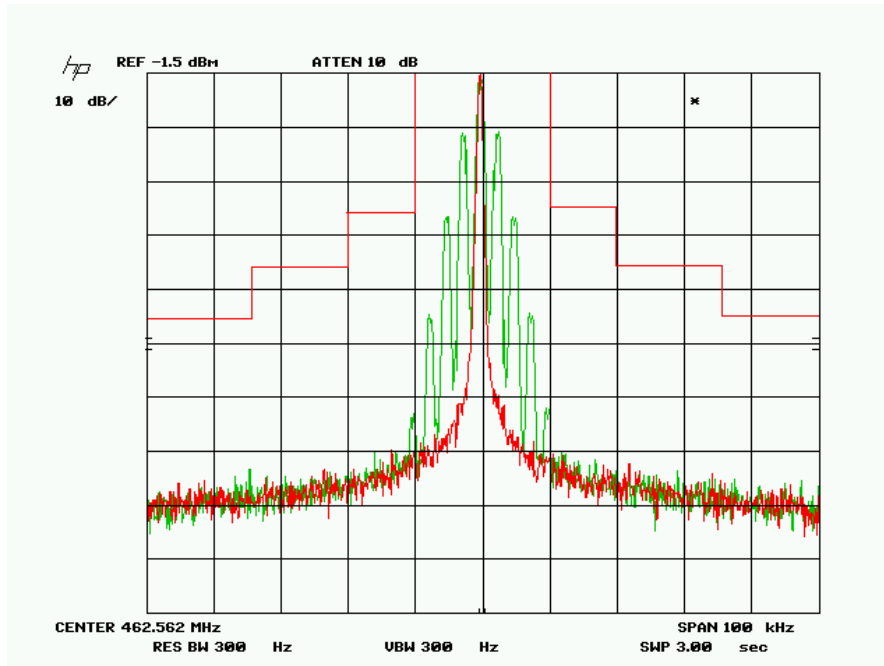

E.7.2.6 GMRS DCS



Applicant:	Uniden America Corporation	FCC ID:	AMWUT063	IC:	513C-UT063	
DUT Type:	Portable FRS/GMRS UHF PTT Radio Transceiver	DUT Model:	GMR3040	(GMRS/FRS)		
2011 Celltech Labs Inc.		This document is not to be reproduced in whole or in part without the prior written permission of Celltech Labs Inc.				Page 26 of 38

	Test Report Serial No.:	092311AMW-T1124-E95U	Test Report Issue Date:	November 04, 2011	 
	Measurement Dates:	September 26-28, 2011	Test Report Revision:	Rev. 1.1 (2nd Release)	
	Rule Part(s) Applied:	FCC 47 CFR §2, §95A, §95B IC RSS-210 (8), RSS-Gen (3)	Test Site Registration:	FCC Accredited Site IC Site File #: 3874A-1	
					Test Lab Certificate No. 2470.01

Note:
The asterisk appears on the occupied bandwidth plots (Section E.7.1) and emission mask plots (Section E.7.2) due to a plotter emulator program used to capture data. During the read process an asterisk appears on the SA screen indicating a data transfer. This is different from an un-calibrated measurement, as indicated in the plots below. Auto sweep time selected for measurements.

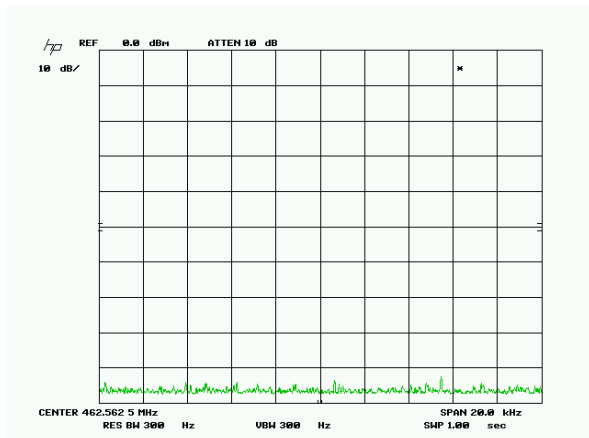



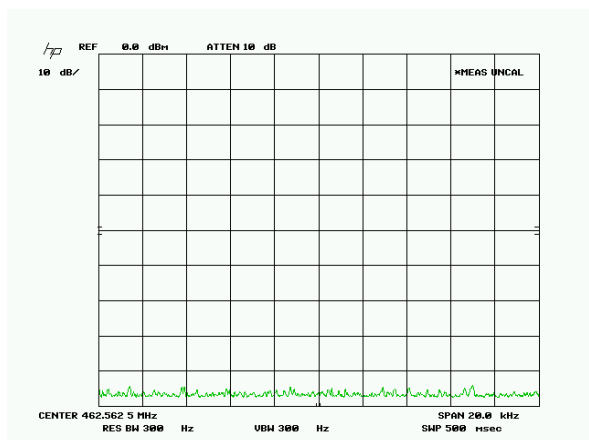

Data capture



Uncalibrated measurement

E.8 PASS/FAIL
In reference to the results outlined in E.7, the DUT passes the requirements as stated in the reference standards.
E.9 SIGN-OFF
I attest to the accuracy of the data. All measurements reported herein were performed by me and are correct to the best of my knowledge and belief. I assume full responsibility for the completeness of these measurements.
 <hr/> Sean Johnston Lab Manager Celltech Labs Inc. Sept. 27, 2011 <hr/> Date

Applicant:	Uniden America Corporation	FCC ID:	AMWUT063	IC:	513C-UT063	
DUT Type:	Portable FRS/GMRS UHF PTT Radio Transceiver	DUT Model:	GMR3040	(GMRS/FRS)	(GMRS/FRS)	
2011 Celltech Labs Inc.	This document is not to be reproduced in whole or in part without the prior written permission of Celltech Labs Inc.					Page 27 of 38

	Test Report Serial No.:	092311AMW-T1124-E95U	Test Report Issue Date:	November 04, 2011	 
	Measurement Dates:	September 26-28, 2011	Test Report Revision:	Rev. 1.1 (2nd Release)	
	Rule Part(s) Applied:	FCC 47 CFR §2, §95A, §95B IC RSS-210 (8), RSS-Gen (3)	Test Site Registration:	FCC Accredited Site IC Site File #: 3874A-1	
					Test Lab Certificate No. 2470.01

Appendix F Radiated Spurious Emissions - TX

F.1 REFERENCES

Normative Reference Standard	FCC CFR 47 §2.1053, §95.635 (b) (7); IC RSS-210
Procedure Reference	The transmitter spurious emissions were measured in accordance with TIA/EIA Standard 603 using the substitution method on a 3-meter open area test site (OATS).

F.2 LIMITS

§95.635 & RSS-210 A6.1.5, A6.2.5	(7) At least 43 + 10 log ₁₀ (T) dB on any frequency removed from the center of the authorized bandwidth by more than 250%.
--	---

F.3 ENVIRONMENTAL CONDITIONS

Temperature	10 °C
Humidity	40 +/- 10 %
Barometric Pressure	101 +/- 3 kPa

F.4 EQUIPMENT LIST

ASSET NUMBER	MANUFACTURER	MODEL	DESCRIPTION	CAL DUE
00072	EMCO	2075	Mini-mast	cnr
00073	EMCO	2080	Turn Table	cnr
00071	EMCO	2090	Multi-Device Controller	cnr
00015	HP	E4408B	Spectrum Analyzer	03-May-12
00050	Chase	CBL-6111A	Bilog Antenna	03-May-13
00055	EMCO	3121C	Dipole Antenna	27-Aug-12
00034	ETS	3115	Double Ridged Guide Horn	29-May-12
00035	ETS	3115	Double Ridged Guide Horn	29-May-12
00051	HP	8566B	Spectrum Analyzer RF Section	03-May-12
00049	HP	85650A	Quasi-peak Adapter	06-May-12
00047	HP	85685A	RF Preselector	05-May-12
00006	R & S	SMR 20	Signal Generator (10MHz-40GHz)	30-Apr-12
00114	Amplifier Research	DC7154	Directional Coupler (0.8-4.2 GHz)	cnr
00078	Pasternack	PE2214-20	Directional Coupler (1-18 GHz)	cnr
00106	Amplifier Research	5S1G4	Power Amplifier (5W, 800MHz-4.2GHz)	cnr
00041	Amplifier Research	10W1000C	Power Amplifier (0.5 - 1 GHz)	cnr
00007	Gigatronics	8652A	Power Meter	04-May-12
00014	Gigatronics	80701A	Power Sensor	04-May-12

cnr = calibration not required

Applicant:	Uniden America Corporation	FCC ID:	AMWUT063	IC:	513C-UT063	
DUT Type:	Portable FRS/GMRS UHF PTT Radio Transceiver	DUT Model:	GMR3040	(GMRS/FRS)		
2011 Celltech Labs Inc.	This document is not to be reproduced in whole or in part without the prior written permission of Celltech Labs Inc.					Page 28 of 38



F.5 MEASUREMENT EQUIPMENT SETUP

MEASUREMENT EQUIPMENT CONNECTIONS	For the field strength measurements, the measurement equipment was connected as shown in F.6. A number of antennas were used to cover the applicable frequency range tested. The ranges in which each antenna was used are as follows. For the final substitutions, the DUT was replaced with the appropriate antenna and fed from a CW signal source sufficient to replicate the received field strength of the emission being investigated.			
	Frequency Range	RX Antenna	TX Antenna	
	30 MHz - 1GHz	Bilog	Dipole	
	1 GHz - 18 GHz	ETS 3115 Horn	ETS 3115 Horn	
MEASUREMENT EQUIPMENT SETTINGS	For measuring the radiated field strength of the fundamental, the spectrum analyzer was set to the following settings:			
	Mode	RBW	VBW	Detector
		MHz	MHz	
	GMRS (Hi Power)	1	3	Peak
	FRS (Lo Power)	1	3	Peak

F.6 SETUP DRAWING

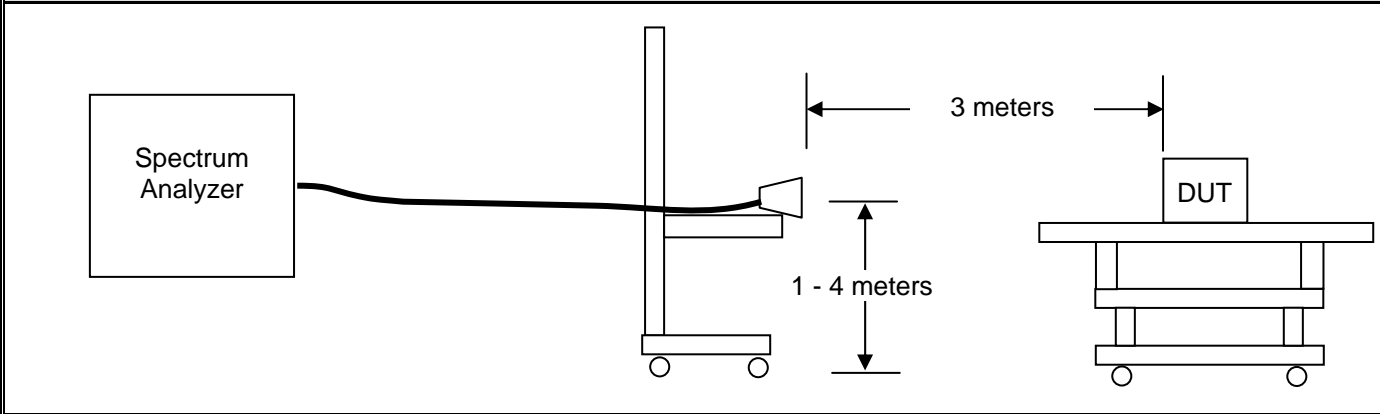
Figure F.6-1 - Setup Drawing – Radiated TX Spurious Emissions



	Test Report Serial No.:	092311AMW-T1124-E95U	Test Report Issue Date:	November 04, 2011	 
	Measurement Dates:	September 26-28, 2011	Test Report Revision:	Rev. 1.1 (2nd Release)	
	Rule Part(s) Applied:	FCC 47 CFR §2, §95A, §95B IC RSS-210 (8), RSS-Gen (3)	Test Site Registration:	FCC Accredited Site IC Site File #: 3874A-1	
					Test Lab Certificate No. 2470.01

F.7 TEST RESULTS

GMRS TX: 462.5625 MHz

Measured Output Power: 0.62 W, Limit: $43+10\log(W)$ = 40.9dBc

Emissions (MHz)	Attenuation (dBc)	Limit (dBc)	Margin (dB)
462.5625	-	-	-
925.125	63.2	40.9	22.3
1387.6875	62.9	40.9	22.0
1850.25	68.0	40.9	27.1

FRS TX: 467.5625 MHz

Measured Output Power: 0.41 W, Limit: $43+10\log(W)$ = 39.1dBc

Emissions (MHz)	Attenuation (dBc)	Limit (dBc)	Margin (dB)
467.5625	-	-	-
935.125	62.7	39.1	23.6
1402.6875	57.1	39.1	18.0
1870.25	61.2	39.1	22.1

Note(s):

1. Measured ERP Carrier Level (dBm) = Power Applied to Antenna (dBm) + Antenna Gain (dBd)
2. The DUT was measured in 3 orientations with respect to the receive antenna and the orientation with the highest Radiated Power results is shown (Vertical Polarization).
3. The DUT was measured with and without the optional speaker-microphone audio accessory connected to the audio jack of the DUT, and the worst-case configuration is reported (without the speaker-microphone audio accessory).

F.8 PASS/FAIL

In reference to the results outlined in F.7 the DUT passes the requirements as stated in the reference standards.

F.9 SIGN-OFF

I attest to the accuracy of the data. All measurements reported herein were performed by me and are correct to the best of my knowledge and belief. I assume full responsibility for the completeness of these measurements.





Sean Johnston
Lab Manager
Celltech Labs Inc.

Sept. 26, 2011

Date



Applicant:	Uniden America Corporation	FCC ID:	AMWUT063	IC:	513C-UT063	
DUT Type:	Portable FRS/GMRS UHF PTT Radio Transceiver	DUT Model:	GMR3040	(GMRS/FRS)		
2011 Celltech Labs Inc.		This document is not to be reproduced in whole or in part without the prior written permission of Celltech Labs Inc.				Page 30 of 38

	Test Report Serial No.:	092311AMW-T1124-E95U	Test Report Issue Date:	November 04, 2011	  Test Lab Certificate No. 2470.01
	Measurement Dates:	September 26-28, 2011	Test Report Revision:	Rev. 1.1 (2nd Release)	
	Rule Part(s) Applied:	FCC 47 CFR §2, §95A, §95B IC RSS-210 (8), RSS-Gen (3)	Test Site Registration:	FCC Accredited Site IC Site File #: 3874A-1	

F.10 TEST SETUP PHOTOGRAPH



Applicant:	Uniden America Corporation	FCC ID:	AMWUT063	IC:	513C-UT063	
DUT Type:	Portable FRS/GMRS UHF PTT Radio Transceiver	DUT Model:	GMR3040	(GMRS/FRS)		
2011 Celltech Labs Inc.		This document is not to be reproduced in whole or in part without the prior written permission of Celltech Labs Inc.				Page 31 of 38

	Test Report Serial No.:	092311AMW-T1124-E95U	Test Report Issue Date:	November 04, 2011	 
	Measurement Dates:	September 26-28, 2011	Test Report Revision:	Rev. 1.1 (2nd Release)	
	Rule Part(s) Applied:	FCC 47 CFR §2, §95A, §95B IC RSS-210 (8), RSS-Gen (3)	Test Site Registration:	FCC Accredited Site IC Site File #: 3874A-1	
					Test Lab Certificate No. 2470.01

Appendix G Radiated Spurious Emissions - RX

G.1 REFERENCES	
Normative Reference Standard	IC RSS-210
Procedure Reference(s)	The procedure used was ANSI C63.4-2003. The frequency was scanned from 30 MHz to 1.0 GHz. When an emission was found, the table was rotated to produce the maximum signal strength. The DUT was measured in three (3) orthogonal planes. RSS-Gen 4.10

G.2 LIMITS		
RSS-Gen 6.(a)	Frequency (MHz)	Limits
	30-88	40.0 dBuV/m measured @ 3 meters
	80-216	43.5 dBuV/m measured @ 3 meters
	216-960	46.0 dBuV/m measured @ 3 meters
	Above 960	54.0 dBuV/m measured @ 3 meters

G.3 ENVIRONMENTAL CONDITIONS	
Temperature	10 °C
Humidity	40 +/- 10 %
Barometric Pressure	101 +/- 3 kPa

G.4 EQUIPMENT LIST				
ASSET NUMBER	MANUFACTURER	MODEL	DESCRIPTION	CAL DUE
00072	EMCO	2075	Mini-mast	cnr
00073	EMCO	2080	Turn Table	cnr
00071	EMCO	2090	Multi-Device Controller	cnr
00015	HP	E4408B	Spectrum Analyzer	03-May-12
00050	Chase	CBL-6111A	Bilog Antenna	03-May-13
00051	HP	8566B	Spectrum Analyzer RF Section	03-May-12
00049	HP	85650A	Quasi-peak Adapter	06-May-12
00047	HP	85685A	RF Preselector	05-May-12
00006	R & S	SMR 20	Signal Generator (10MHz-40GHz)	30-Apr-12

cnr = calibration not required

Applicant:	Uniden America Corporation	FCC ID:	AMWUT063	IC:	513C-UT063	
DUT Type:	Portable FRS/GMRS UHF PTT Radio Transceiver	DUT Model:	GMR3040	(GMRS/FRS)		
2011 Celltech Labs Inc.		This document is not to be reproduced in whole or in part without the prior written permission of Celltech Labs Inc.				Page 32 of 38



G.5 MEASUREMENT EQUIPMENT SETUP

MEASUREMENT EQUIPMENT CONNECTIONS	For the field strength measurements, the measurement equipment was connected as shown in G.6. Various antenna types may be required to cover the applicable frequency range tested. The ranges in which each antenna was used are shown below.			
	Frequency Range	RX Antenna	TX Antenna	
	30 MHz - 1GHz	Bilog	N/a	
1 GHz - 18 GHz	ETS 3115 Horn	N/a		
MEASUREMENT EQUIPMENT SETTINGS	For the spurious out-of-band emissions, the spectrum analyzer was set to the following settings:			
	Measurement	RBW	VBW	Detector
		kHz	kHz	
	< 1 GHz	100	300	Peak*
	> 1 GHz	1000	3000	Peak*
* As a worst-case measurement, the QP limit was applied to measurements made with a peak detector.				

G.6 SETUP DRAWING

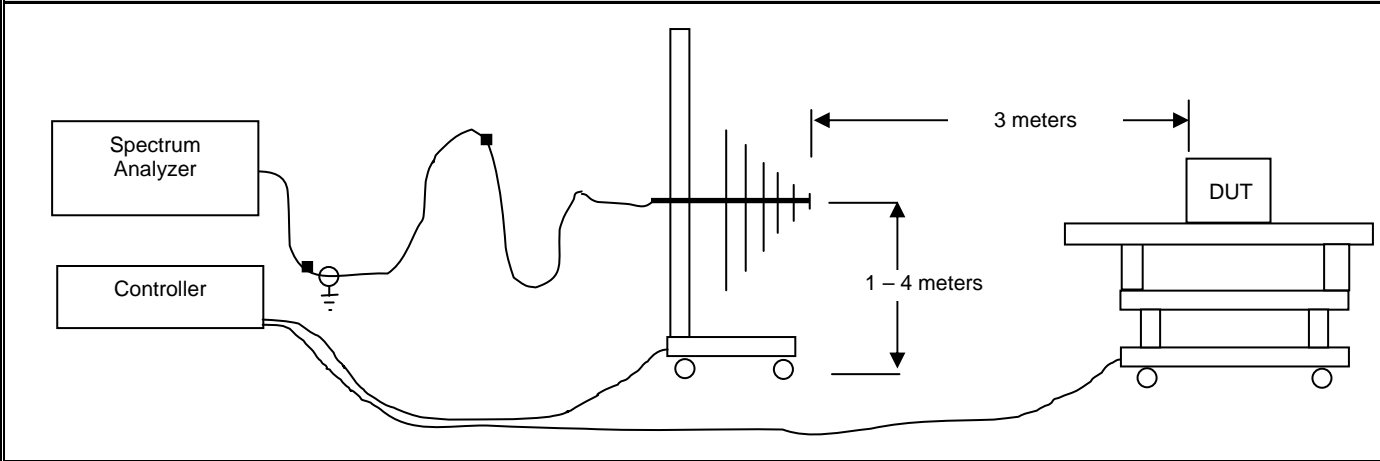
Figure G.6-1 - Setup Drawing – Radiated RX Spurious Emissions



	Test Report Serial No.:	092311AMW-T1124-E95U	Test Report Issue Date:	November 04, 2011	 
	Measurement Dates:	September 26-28, 2011	Test Report Revision:	Rev. 1.1 (2nd Release)	
	Rule Part(s) Applied:	FCC 47 CFR §2, §95A, §95B IC RSS-210 (8), RSS-Gen (3)	Test Site Registration:	FCC Accredited Site IC Site File #: 3874A-1	
					Test Lab Certificate No. 2470.01

G.7 TEST RESULTS

Tuned Frequency	Emission Frequency	Receiver	DUT	Ant Pol	Cable Loss	Correction Factor	Field Strength	Limit	Margin
CH	MHz	dBuV			dB	dB	dBuV/m	dBuV/m	dB
15	452.01	16.4	V	V	1.8	16.7	34.9	46	11.1
15	452.01	13.4	V	H	1.8	17.1	32.3	46	13.7
14	457.20	16.8	V	V	1.8	16.9	35.50	46	10.5
14	457.20	16.1	V	H	1.8	17.1	35.00	46	11
14	894.2	4.8	V	V	2	23.2	30.00	46	16
14	894.2	5	V	H	2	23.2	30.20	46	15.8

Note: The emissions reported above represent the highest emissions or noise floor measured within the frequency band of 30MHz and the 10th harmonic of the carrier. All other emissions were at the noise floor.

Formulae:

Total CF = Antenna Factor + Cable Factor + Other Factor (Amplifier Gain, filter loss, etc)

Field Strength = SA Reading + Total CF

The frequency points reported describe the highest emission measured in each of the ranges tested and are used to describe the measured spectrum as a whole. It is shown that the highest emissions measured within the spectrum pass the appropriate limits; therefore all emissions within the bands would also meet the requirements.

G.8 PASS/FAIL

In reference to the results outlined in G.7 the DUT passes the requirements as stated in the reference standard.

G.9 SIGN-OFF

I attest to the accuracy of the data. All measurements reported herein were performed by me and are correct to the best of my knowledge and belief. I assume full responsibility for the completeness of these measurements.





Sean Johnston
Lab Manager
Celltech Labs Inc.

Sept. 26, 2011

Date

Applicant:	Uniden America Corporation	FCC ID:	AMWUT063	IC:	513C-UT063	
DUT Type:	Portable FRS/GMRS UHF PTT Radio Transceiver	DUT Model:	GMR3040	(GMRS/FRS)		
2011 Celltech Labs Inc.	This document is not to be reproduced in whole or in part without the prior written permission of Celltech Labs Inc.					Page 34 of 38

	Test Report Serial No.:	092311AMW-T1124-E95U	Test Report Issue Date:	November 04, 2011	 
	Measurement Dates:	September 26-28, 2011	Test Report Revision:	Rev. 1.1 (2nd Release)	
	Rule Part(s) Applied:	FCC 47 CFR §2, §95A, §95B IC RSS-210 (8), RSS-Gen (3)	Test Site Registration:	FCC Accredited Site IC Site File #: 3874A-1	
					Test Lab Certificate No. 2470.01

Appendix H Frequency Stability

H.1 REFERENCES

Normative Reference Standard	FCC CFR 47 §2.1055, §95.621, §95.627; IC RSS-210
Procedure Reference / Description	<p>§95.621 (a) The frequency stability shall be measured with variation of ambient temperature as follows:</p> <p>(1) From -30° to +50° centigrade for all equipment except that specified in paragraphs (a) (2) and (3) of this section.</p> <p>(2) From -20° to +50° Family Radio Service under part 95 of this chapter.</p>

H.2 LIMITS

§95.621	(b) Each GMRS transmitter for mobile station, small base station and control station operation must be maintained within a frequency tolerance of 0.0005%. Each GMRS transmitter for base station (except small base), mobile relay station or fixed station operation must be maintained within a frequency tolerance of 0.00025%.
§95.627	(b) Each FRS unit must be maintained within a frequency tolerance of 0.00025%.
RSS-210 A6.1.6	FRS Devices: Carrier frequency tolerance shall be better than ± 5 ppm
RSS-210 A6.2.6	GMRS Devices: Carrier frequency tolerance shall be better than ± 5 ppm

H.3 ENVIRONMENTAL CONDITIONS

Temperature	25 +/- 5 °C
Humidity	40 +/- 10 %
Barometric Pressure	101 +/- 3 kPa

H.4 EQUIPMENT LIST

ASSET NUMBER	MANUFACTURER	MODEL	DESCRIPTION	CAL DUE
na	ESPEC	ECT-2	Heater/Refrigerator	na
0003	HP	53181A	Frequency Counter	09-Apr-12
na	HP	E3611A	DC Power Supply	Na
00207	VWR	na	Temperature Humidity Monitor	09-Apr-12

H.5 SETUP DRAWING

Figure H.5-1 - Setup Drawing – Frequency Stability

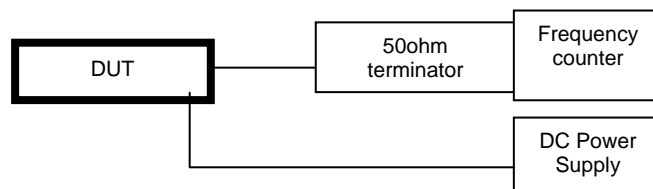

Applicant:	Uniden America Corporation	FCC ID:	AMWUT063	IC:	513C-UT063	
DUT Type:	Portable FRS/GMRS UHF PTT Radio Transceiver	DUT Model:	GMR3040	(GMRS/FRS)		
2011 Celltech Labs Inc.	This document is not to be reproduced in whole or in part without the prior written permission of Celltech Labs Inc.					Page 35 of 38

H.6 TEST RESULTS

Channel: 1 GMRS

Temperature (degrees C)	Assigned Frequency (MHz)	Measured Frequency (MHz)	Deviation (%)	Frequency tolerance with reference to value @ 20 °C (ppm)
-30	462.5625000	462.5617956	-0.000152%	-1.154655202
-20	462.5625000	462.5621543	-0.000075%	-0.379192141
-10	462.5625000	462.5625753	0.000016%	0.530955472
0	462.5625000	462.5626830	0.000040%	0.763788958
10	462.5625000	462.5626796	0.000039%	0.756438598
20	462.5625000	462.5623297	-0.000037%	0
30	462.5625000	462.5621507	-0.000076%	-0.386974876
40	462.5625000	462.5619333	-0.000123%	-0.85696559
50	462.5625000	462.5620598	-0.000095%	-0.583488933

Channel: 8 FRS

Temperature (degrees C)	Assigned Frequency (MHz)	Measured Frequency (MHz)	Deviation (%)	Frequency tolerance with reference to value @ 20 °C (ppm)
-30	467.5625000	467.5616742	-0.000177%	-1.649405352
-20	467.5625000	467.5622260	-0.000059%	-0.469242135
-10	467.5625000	467.5625513	0.000011%	0.226493811
0	467.5625000	467.5626271	0.000027%	0.388611194
10	467.5625000	467.5626521	0.000033%	0.442079987
20	467.5625000	467.5624454	-0.000012%	0
30	467.5625000	467.5621336	-0.000078%	-0.666862797
40	467.5625000	467.5619240	-0.000123%	-1.115145164
50	467.5625000	467.5621611	-0.000072%	-0.608047123

GMRS



Voltage (V)	Frequency (MHz)	% Deviation	PPM to reference
3.06	462.5622234	-0.000060%	-0.5980
4.14	462.5623260	-0.000038%	-0.3762

FRS

Voltage (V)	Frequency (MHz)	% Deviation	PPM to reference
3.06	467.5623463	-0.000033%	-0.3287
4.14	467.5624435	-0.000012%	-0.1208

H.7 PASS/FAIL

In reference to the results outlined in H.6 the DUT passes the requirements as stated in the reference standards.

	Test Report Serial No.:	092311AMW-T1124-E95U	Test Report Issue Date:	November 04, 2011	 
	Measurement Dates:	September 26-28, 2011	Test Report Revision:	Rev. 1.1 (2nd Release)	
	Rule Part(s) Applied:	FCC 47 CFR §2, §95A, §95B IC RSS-210 (8), RSS-Gen (3)	Test Site Registration:	FCC Accredited Site IC Site File #: 3874A-1	
					Test Lab Certificate No. 2470.01

H.8 SIGN-OFF

I attest to the accuracy of the data. All measurements reported herein were performed by me and are correct to the best of my knowledge and belief. I assume full responsibility for the completeness of these measurements.





Sean Johnston
Lab Manager
Celltech Labs Inc.

Sept. 28, 2011

Date

Applicant:	Uniden America Corporation	FCC ID:	AMWUT063	IC:	513C-UT063	
DUT Type:	Portable FRS/GMRS UHF PTT Radio Transceiver	DUT Model:	GMR3040	(GMRS/FRS)		
2011 Celltech Labs Inc.	This document is not to be reproduced in whole or in part without the prior written permission of Celltech Labs Inc.					Page 37 of 38

	Test Report Serial No.:	092311AMW-T1124-E95U	Test Report Issue Date:	November 04, 2011	 Test Lab Certificate No. 2470.01
	Measurement Dates:	September 26-28, 2011	Test Report Revision:	Rev. 1.1 (2nd Release)	
	Rule Part(s) Applied:	FCC 47 CFR §2, §95A, §95B IC RSS-210 (8), RSS-Gen (3)	Test Site Registration:	FCC Accredited Site IC Site File #: 3874A-1	

END OF DOCUMENT

Applicant:	Uniden America Corporation	FCC ID:	AMWUT063	IC:	513C-UT063	
DUT Type:	Portable FRS/GMRS UHF PTT Radio Transceiver	DUT Model:	GMR3040	(GMRS/FRS)		
2011 Celltech Labs Inc.	This document is not to be reproduced in whole or in part without the prior written permission of Celltech Labs Inc.					Page 38 of 38