

	<u>Date(s) of Evaluation</u> December 07, 2006	<u>Test Report Serial No.</u> 120706AMW-T795-S95U	<u>Report Revision No.</u> Revision 1.0	
	<u>Report Issue Date</u> December 14, 2006	<u>Description of Test(s)</u> Specific Absorption Rate	<u>RF Exposure Category</u> General Population	

RF EXPOSURE EVALUATION

SPECIFIC ABSORPTION RATE

SAR TEST REPORT

FOR

UNIDEN AMERICA CORPORATION

PORTABLE UHF FRS/GMRS PTT RADIO TRANSCEIVER

MODEL(S): GMR1448

IDENTIFIER(S)	FCC ID: AMWUT025	IC: 513C-UT025
Test Standard(s) and Procedure(s)	FCC OET Bulletin 65, Supplement C (01-01)	
	Industry Canada RSS-102 Issue 2	

Test Report Serial No.

120706AMW-T795-S95U

Test Report Revision No.

Revision 1.0 (Initial Release)

Test Lab and Location



**Celltech Compliance Testing & Engineering Lab
(Celltech Labs Inc.)
1955 Moss Court
Kelowna, BC
Canada
V1Y 9L3**



Certificate No. 2470.01

<u>Test Report Prepared By:</u> Cheri Frangiadakis Test Report Writer Celltech Labs Inc.	<u>Test Report Reviewed By:</u> Jonathan Hughes General Manager Celltech Labs Inc.
--	--

Company:	Uniden America Corporation	FCC ID:	AMWUT025	IC ID:	513C-UT025	
Model(s):	GMR1448	DUT Type:	Portable FM UHF FRS/GMRS PTT Radio Transceiver			
2006 Celltech Labs Inc.	This document is not to be reproduced in whole or in part without the prior written permission of Celltech Labs Inc.					Page 1 of 37

 Celltech <small>Testing and Engineering Services Lab</small>	<u>Date(s) of Evaluation</u> December 07, 2006	<u>Test Report Serial No.</u> 120706AMW-T795-S95U	<u>Report Revision No.</u> Revision 1.0	 Certificate No. 2470.01
	<u>Report Issue Date</u> December 14, 2006	<u>Description of Test(s)</u> Specific Absorption Rate	<u>RF Exposure Category</u> General Population	

DECLARATION OF COMPLIANCE SAR RF EXPOSURE EVALUATION

<u>Test Lab and Location</u> CELLTECH LABS INCORPORATED Testing and Engineering Services 1955 Moss Court Kelowna, B.C. Canada V1Y 9L3 Phone: 250-448-7047 Fax: 250-448-7046 e-mail: info@celltechlabs.com web site: www.celltechlabs.com	<u>Company Information</u> UNIDEN AMERICA CORPORATION Engineering Services Office 181 N. Country Club Road Lake City, SC 29560 United States
FCC IDENTIFIER: IC IDENTIFIER: Model(s):	AMWUT025 513C-UT025 GMR1448
Test Requirement(s): Test Procedure(s):	FCC 47 CFR §2.1093; Health Canada Safety Code 6 FCC OET Bulletin 65, Supplement C (Edition 01-01) Industry Canada RSS-102 Issue 2
Device Description: Transmit Frequency Range(s): Max. RF Output Power Tested: Antenna Type(s) Tested: Battery Type(s) Tested:	Portable FM UHF FRS/GMRS PTT Radio Transceiver 462.5500 - 462.7250 MHz (GMRS Channels 15-22) 462.5625 - 462.7125 MHz (FRS/GMRS Channels 1-7) 467.5625 - 467.7125 MHz (FRS Channels 8-14) 0.65 Watts (28.1 dBm) ERP (462.5625 MHz) GMRS Ch. 1 External Fixed Stubby NiMH 4.8 V, 550 mAh (Model: BP40) Alkaline AAA x4 (6 V)
Body-Worn Accessories Tested: Audio Accessories Tested:	Plastic Belt-Clip (P/N: UT916ZH) Headset (Ear-Loop with Boom-Microphone)
Max. SAR Level(s) Evaluated:	Face-held: 0.737 W/kg (1g) - 50% duty cycle Body-worn: 1.21 W/kg (1g) - 50% duty cycle

Celltech Labs Inc. declares under its sole responsibility that this wireless portable device has demonstrated compliance with the Specific Absorption Rate (SAR) RF exposure requirements specified in FCC 47 CFR §2.1093 and Health Canada's Safety Code 6. The device was tested in accordance with the measurement standards and procedures specified in FCC OET Bulletin 65, Supplement C (Edition 01-01) and Industry Canada RSS-102 Issue 2 for the General Population / Uncontrolled Exposure environment. All measurements were performed in accordance with the SAR system manufacturer recommendations.

I attest to the accuracy of data. All measurements were performed by me or were made under my supervision and are correct to the best of my knowledge and belief. I assume full responsibility for the completeness of these measurements and vouch for the qualifications of all persons taking them.

This test report shall not be reproduced partially, or in full, without the prior written approval of Celltech Labs Inc. The results and statements contained in this report pertain only to the device(s) evaluated.

Test Report Approved By:

Sean Johnston
SAR Lab Manager
Celltech Labs Inc.



Company:	Uniden America Corporation	FCC ID:	AMWUT025	IC ID:	513C-UT025	
Model(s):	GMR1448	DUT Type:	Portable FM UHF FRS/GMRS PTT Radio Transceiver			
2006 Celltech Labs Inc.	This document is not to be reproduced in whole or in part without the prior written permission of Celltech Labs Inc.					Page 2 of 37





	<u>Date(s) of Evaluation</u> December 07, 2006	<u>Test Report Serial No.</u> 120706AMW-T795-S95U	<u>Report Revision No.</u> Revision 1.0	
	<u>Report Issue Date</u> December 14, 2006	<u>Description of Test(s)</u> Specific Absorption Rate	<u>RF Exposure Category</u> General Population	

TABLE OF CONTENTS

1.0 INTRODUCTION _____	4
2.0 DESCRIPTION OF DEVICE UNDER TEST (DUT) _____	4
3.0 SAR MEASUREMENT SYSTEM _____	5
4.0 MEASUREMENT SUMMARY _____	6
5.0 DETAILS OF SAR EVALUATION _____	7
6.0 EVALUATION PROCEDURES _____	7
7.0 SYSTEM PERFORMANCE CHECK _____	8
8.0 SIMULATED EQUIVALENT TISSUES _____	9
9.0 SAR SAFETY LIMITS _____	9
10.0 ROBOT SYSTEM SPECIFICATIONS _____	10
11.0 PROBE SPECIFICATION (ET3DV6) _____	11
12.0 SIDE PLANAR PHANTOM _____	11
13.0 VALIDATION PLANAR PHANTOM _____	11
14.0 DEVICE HOLDER _____	11
15.0 TEST EQUIPMENT LIST _____	12
16.0 MEASUREMENT UNCERTAINTIES _____	13
MEASUREMENT UNCERTAINTIES (CONT.) _____	14
17.0 REFERENCES _____	15
APPENDIX A - SAR MEASUREMENT DATA _____	16
APPENDIX B - SYSTEM PERFORMANCE CHECK DATA _____	24
APPENDIX C - MEASURED FLUID DIELECTRIC PARAMETERS _____	27
APPENDIX D - SAR TEST SETUP & DUT PHOTOGRAPHS _____	30
APPENDIX E - SYSTEM VALIDATION _____	36
APPENDIX F - PROBE CALIBRATION _____	37

Company:	Uniden America Corporation	FCC ID:	AMWUT025	IC ID:	513C-UT025	
Model(s):	GMR1448	DUT Type:	Portable FM UHF FRS/GMRS PTT Radio Transceiver			
2006 Celltech Labs Inc.		This document is not to be reproduced in whole or in part without the prior written permission of Celltech Labs Inc.				Page 3 of 37

 Celltech <small>Testing and Engineering Services Ltd.</small>	<u>Date(s) of Evaluation</u> December 07, 2006	<u>Test Report Serial No.</u> 120706AMW-T795-S95U	<u>Report Revision No.</u> Revision 1.0	 Certificate No. 2470.01
	<u>Report Issue Date</u> December 14, 2006	<u>Description of Test(s)</u> Specific Absorption Rate	<u>RF Exposure Category</u> General Population	



1.0 INTRODUCTION

This measurement report demonstrates compliance of the Uniden America Corporation Model(s): GMR1448 Portable UHF FRS/GMRS PTT Radio Transceiver FCC ID: AMWUT025 with the SAR (Specific Absorption Rate) RF exposure requirements specified in FCC 47 CFR §2.1093 (see reference [1]) and Health Canada's Safety Code 6 (see reference [2]) for the General Population / Uncontrolled Exposure environment. The test procedures described in FCC OET Bulletin 65, Supplement C (Edition 01-01) (see reference [3]) and IC RSS-102 Issue 2 (see reference [4]) were employed. A description of the product and operating configuration, detailed summary of the test results, methodology and procedures used in the evaluation, equipment used, and the provisions of the rules are included within this test report.

2.0 DESCRIPTION OF DEVICE UNDER TEST (DUT)

Test Requirement(s)	FCC Rule Part 47 CFR §2.1093				
	Health Canada Safety Code 6				
Test Procedure(s)	FCC OET Bulletin 65, Supplement C (01-01)				
	Industry Canada RSS-102 Issue 2				
Device Description	Portable FM UHF FRS/GMRS PTT Radio Transceiver				
RF Exposure Category	General Population / Uncontrolled Environment				
FCC IDENTIFIER	AMWUT025				
IC IDENTIFIER	513C-UT025				
Model(s)	GMR1448				
Test Sample Serial No.	#5		Identical Prototype		
Modulation Type	FM (UHF)				
Transmit Frequency Range(s)	462.5500 - 462.7250 MHz		GMRS Channels 15-22		
	462.5625 - 462.7125 MHz		FRS/GMRS Channels 1-7		
	467.5625 - 467.7125 MHz		FRS Channels 8-14		
Max. RF Output Power Tested	0.65 Watts	28.1 dBm	ERP	462.5625 MHz	Channel 1
Antenna Type(s) Tested	External Fixed Stubby				
Battery Type(s) Tested	NiMH	4.8 V, 550 mAh		Model: BP40	
	Alkaline	6 V		AAA (x4)	
Body-Worn Accessories Tested	Plastic Belt-Clip (7 mm thickness)			P/N: UT916ZH	
Audio Accessories Tested	Headset (Ear-Loop with Boom-Microphone)			P/N: n/a	

Company:	Uniden America Corporation	FCC ID:	AMWUT025	IC ID:	513C-UT025	
Model(s):	GMR1448	DUT Type:	Portable FM UHF FRS/GMRS PTT Radio Transceiver			
2006 Celltech Labs Inc.		This document is not to be reproduced in whole or in part without the prior written permission of Celltech Labs Inc.				Page 4 of 37

	<u>Date(s) of Evaluation</u> December 07, 2006	<u>Test Report Serial No.</u> 120706AMW-T795-S95U	<u>Report Revision No.</u> Revision 1.0	 
	<u>Report Issue Date</u> December 14, 2006	<u>Description of Test(s)</u> Specific Absorption Rate	<u>RF Exposure Category</u> General Population	

3.0 SAR MEASUREMENT SYSTEM

Celltech Labs Inc. SAR measurement facility utilizes the Dosimetric Assessment System (DASY™) manufactured by Schmid & Partner Engineering AG (SPEAG™) of Zurich, Switzerland. The DASY4 measurement system is comprised of the measurement server, robot controller, computer, near-field probe, probe alignment sensor, specific anthropomorphic mannequin (SAM) phantom, and various planar phantoms for brain and/or body SAR evaluations. The robot is a six-axis industrial robot performing precise movements to position the probe to the location (points) of maximum electromagnetic field (EMF). A cell controller system contains the power supply, robot controller, teach pendant (Joystick), and remote control, is used to drive the robot motors. The Staubli robot is connected to the cell controller to allow software manipulation of the robot. A data acquisition electronic (DAE) circuit performs the signal amplification, signal multiplexing, AD-conversion, offset measurements, mechanical surface detection, collision detection, etc. is connected to the Electro-optical coupler (EOC). The EOC performs the conversion from the optical into digital electric signal of the DAE and transfers data to the DASY4 measurement server. The DAE4 utilizes a highly sensitive electrometer-grade preamplifier with auto-zeroing, a channel and gain-switching multiplexer, a fast 16-bit AD-converter and a command decoder and control logic unit. Transmission to the DASY4 measurement server is accomplished through an optical downlink for data and status information and an optical uplink for commands and clock lines. The mechanical probe-mounting device includes two different sensor systems for frontal and sidewise probe contacts. The sensor systems are also used for mechanical surface detection and probe collision detection. The robot uses its own controller with a built in VME-bus computer.



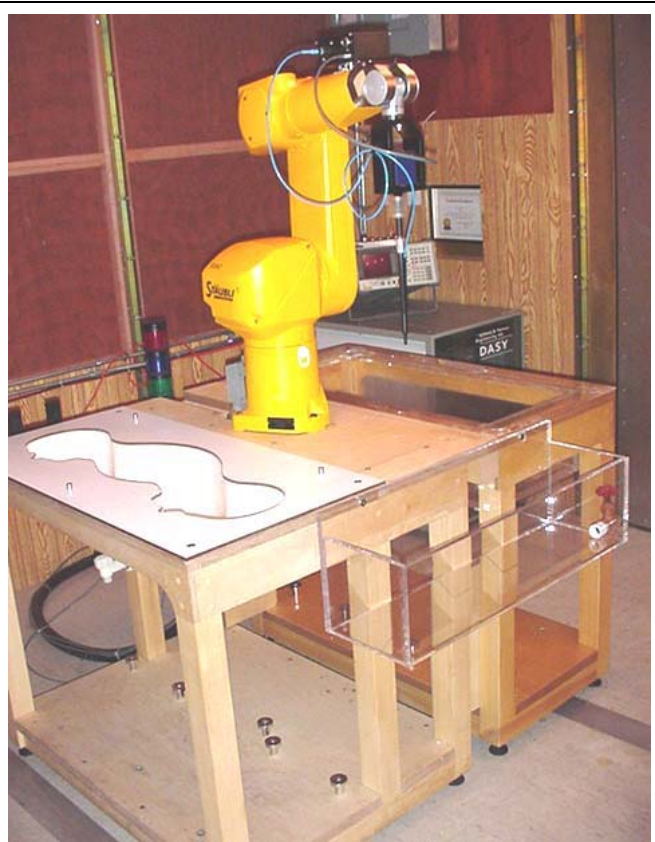

DASY4 SAR Measurement System with Plexiglas validation phantom



DASY4 SAR Measurement System with Plexiglas side planar phantom



Company:	Uniden America Corporation	FCC ID:	AMWUT025	IC ID:	513C-UT025	
Model(s):	GMR1448	DUT Type:	Portable FM UHF FRS/GMRS PTT Radio Transceiver			
2006 Celltech Labs Inc.		This document is not to be reproduced in whole or in part without the prior written permission of Celltech Labs Inc.				Page 5 of 37

 Testing and Engineering Services Lab	<u>Date(s) of Evaluation</u> December 07, 2006	<u>Test Report Serial No.</u> 120706AMW-T795-S95U	<u>Report Revision No.</u> Revision 1.0	 Certificate No. 2470.01
	<u>Report Issue Date</u> December 14, 2006	<u>Description of Test(s)</u> Specific Absorption Rate	<u>RF Exposure Category</u> General Population	

4.0 MEASUREMENT SUMMARY

SAR EVALUATION RESULTS														
Test Type	Freq. MHz	Channel		Test Mode	Battery Type	Accessory Type		DUT Spacing to Planar Phantom	Start Power (ERP) Watts	Measured SAR 1g (W/kg)		SAR Drift During Test dB	Scaled SAR with droop 1g (W/kg)	
						Body-Worn	Audio			Duty Cycle			Duty Cycle	
										100%	50%		100%	50%
Face	462.5625	1	GMRS	CW	NiMH	na	na	2.5 cm Front Side	0.65	1.27	0.635	-0.284	1.36	0.678
Face	462.5625	1	GMRS	CW	Alkaline	na	na	2.5 cm Front Side	0.65	1.29	0.645	-0.580	1.47	0.737
Body	462.5625	1	GMRS	CW	NiMH	Belt-Clip	Headset	0.7 cm Back Side	0.65	2.19	1.10	0.374	-	-
Body	462.5625	1	GMRS	CW	Alkaline	Belt-Clip	Headset	0.7 cm Back Side	0.65	2.13	1.07	-0.543	2.41	1.21
ANSI / IEEE C95.1 1999 - SAFETY LIMIT					BRAIN / BODY: 1.6 W/kg (averaged over 1 gram)					Spatial Peak Uncontrolled Exposure / General Population				
Test Date(s)		December 07, 2006			December 07, 2006			Measured Fluid Type		Brain	Body	Unit		
Dielectric Constant ϵ_r	450 MHz Brain				450 MHz Body				Atmospheric Pressure		102.1	102.1	kPa	
	IEEE Target	Meas.	Dev.	IEEE Target	Meas.	Dev.	Relative Humidity		33	33	%			
	43.5	± 5%	44.7	+2.8%	56.7	± 5%	56.9	+0.4%	Ambient Temperature		24.0	24.0	°C	
Conductivity σ (mho/m)	450 MHz Brain				450 MHz Body				Fluid Temperature		23.3	23.3	°C	
	IEEE Target	Meas.	Dev.	IEEE Target	Meas.	Dev.	Fluid Depth		≥ 15	≥ 15	cm			
	0.87	± 5%	0.90	+3.4%	0.94	± 5%	0.94	0.0%	ρ (Kg/m ³)		1000			
Note(s)	1.	The measurement results were obtained with the DUT tested in the conditions described in this report. Detailed measurement data and plots showing the maximum SAR location of the DUT are reported in Appendix A.												
	2.	The transmission band of the DUT is less than 10 MHz; therefore single channel data only is reported (per FCC OET Bulletin 65, Supplement C, Edition 01-01 - see reference [3]).												
	3.	The area scan evaluation was performed with fully charged batteries. After the area scan was completed the radio was cooled down and the batteries were replaced with fully charged batteries prior to the zoom scan evaluation.												
	4.	The power drifts of the DUT during the SAR evaluations were measured by the DASY4 system. The measured power droops were added to the measured SAR levels to report scaled SAR results as shown in the above test data table.												
	5.	A SAR-versus-Time power droop evaluation was performed in the maximum SAR configuration. See Appendix A (SAR Test Plots) for SAR-versus-Time power droop evaluation plot.												
	6.	The fluid temperature was measured prior to and after the SAR evaluations to ensure the temperature remained within +/-2°C of the fluid temperature reported during the dielectric parameter measurements.												
	7.	The dielectric parameters of the simulated tissue mixtures were measured prior to the SAR evaluations using an ALS-PR-DIEL Dielectric Probe Kit and an HP 8753ET Network Analyzer (see Appendix C).												
	8.	The SAR evaluations were performed within 24 hours of the system performance check.												

Company:	Uniden America Corporation	FCC ID:	AMWUT025	IC ID:	513C-UT025	
Model(s):	GMR1448	DUT Type:	Portable FM UHF FRS/GMRS PTT Radio Transceiver			
2006 Celltech Labs Inc.		This document is not to be reproduced in whole or in part without the prior written permission of Celltech Labs Inc.				Page 6 of 37

	<u>Date(s) of Evaluation</u> December 07, 2006	<u>Test Report Serial No.</u> 120706AMW-T795-S95U	<u>Report Revision No.</u> Revision 1.0	
	<u>Report Issue Date</u> December 14, 2006	<u>Description of Test(s)</u> Specific Absorption Rate	<u>RF Exposure Category</u> General Population	

5.0 DETAILS OF SAR EVALUATION



The Uniden America Corporation Model(s): GMR1448 Portable FM UHF FRS/GMRS PTT Radio Transceiver FCC ID: AMWUT025 was compliant for localized Specific Absorption Rate (General Population / Uncontrolled Exposure) based on the test provisions and conditions described below. The detailed test setup photographs are shown in Appendix D.

1. The DUT was evaluated in a face-held configuration with the front of the radio placed parallel to the outer surface of the planar phantom. A 2.5 cm separation distance was maintained between the front of the DUT and the outer surface of the planar phantom.
2. The DUT was tested in a body-worn configuration with the back of the radio placed parallel to the outer surface of the planar phantom. The attached plastic belt-clip accessory was touching the planar phantom and provided a 0.7 cm separation distance from the back of the DUT to the outer surface of the planar phantom. The DUT was evaluated for body-worn SAR with a headset (ear-loop boom-microphone) audio accessory connected to the audio port.
3. The RF conducted output power of the DUT could not be measured due to a non-detachable antenna. The DUT was evaluated for SAR at the maximum conducted power level preset by the manufacturer.
4. The DUT was evaluated for SAR at the maximum ERP level measured by the manufacturer prior to the SAR evaluations.
5. The power drift of the DUT during the SAR evaluations was measured by the DASY4 system.
6. The area scan evaluation was performed with a fully charged battery. After the area scan was completed the radio was cooled down and the battery was replaced with a fully charged battery prior to the zoom scan evaluation.
7. The DUT was tested in unmodulated continuous transmit operation (Continuous Wave mode at 100% duty cycle) with the transmit key constantly depressed. For a push-to-talk device the 50% duty cycle compensation reported assumes a transmit/receive cycle of equal time base.
8. The SAR evaluations were performed using a Plexiglas side-planar phantom.

6.0 EVALUATION PROCEDURES

- a. (i) The evaluation was performed in the applicable area of the phantom depending on the type of device being tested. For devices held to the ear during normal operation, both the left and right ear positions were evaluated using the SAM phantom.
(ii) For body-worn and face-held devices a planar phantom was used.
- b. The SAR was determined by a pre-defined procedure within the DASY4 software. Upon completion of a reference and optical surface check, the exposed region of the phantom was scanned near the inner surface with a grid spacing of 15mm x 15mm.
An area scan was determined as follows:
 - c. Based on the defined area scan grid, a more detailed grid is created to increase the points by a factor of 10. The interpolation function then evaluates all field values between corresponding measurement points.
 - d. A linear search is applied to find all the candidate maxima. Subsequently, all maxima are removed that are >2 dB from the global maximum. The remaining maxima are then used to position the cube scans.
A 1g and 10g spatial peak SAR was determined as follows:
 - e. Extrapolation is used to find the points between the dipole center of the probe and the surface of the phantom. This data cannot be measured, since the center of the dipoles is 2.7 mm away from the tip of the probe and the distance between the surface and the lowest measuring point is 1.4 mm (see probe calibration document in Appendix F). The extrapolation was based on trivariate quadratics computed from the previously calculated 3D interpolated points nearest the phantom surface.
 - f. Interpolated data is used to calculate the average SAR over 1g and 10g cubes by spatially discretizing the entire measured cube. The volume used to determine the averaged SAR is a 1mm grid (42875 interpolated points).
 - g. A zoom scan volume of 32 mm x 32 mm x 30 mm (5 x 5 x 7 points) centered at the peak SAR location determined from the area scan is used for all zoom scans for devices with a transmit frequency < 800 MHz. Zoom scans for frequencies ≥ 800 MHz are determined with a scan volume of 30 mm x 30 mm x 30 mm (7 x 7 x 7) to ensure complete capture of the peak spatial-average SAR.

Company:	Uniden America Corporation	FCC ID:	AMWUT025	IC ID:	513C-UT025	
Model(s):	GMR1448	DUT Type:	Portable FM UHF FRS/GMRS PTT Radio Transceiver			
2006 Celltech Labs Inc.	This document is not to be reproduced in whole or in part without the prior written permission of Celltech Labs Inc.					Page 7 of 37

	<u>Date(s) of Evaluation</u> December 07, 2006	<u>Test Report Serial No.</u> 120706AMW-T795-S95U	<u>Report Revision No.</u> Revision 1.0	
	<u>Report Issue Date</u> December 14, 2006	<u>Description of Test(s)</u> Specific Absorption Rate	<u>RF Exposure Category</u> General Population	

7.0 SYSTEM PERFORMANCE CHECK

Prior to the SAR evaluations a system check was performed using a Plexiglas planar phantom and 450MHz dipole (see Appendix E for system validation procedures). The dielectric parameters of the simulated tissue mixture were measured prior to the system performance check using an ALS-PR-DIEL Dielectric Probe Kit and HP 8753ET Network Analyzer (see Appendix C). A forward power of 250 mW was applied to the dipole and the system was verified to a tolerance of $\pm 10\%$ (see Appendix B for system performance check test plot).

SYSTEM PERFORMANCE CHECK EVALUATION

Test Date	Equiv. Tissue	SAR 1g (W/kg)			Dielectric Constant ϵ_r			Conductivity σ (mho/m)			ρ (Kg/m ³)	Amb. Temp. (°C)	Fluid Temp. (°C)	Fluid Depth (cm)	Humid. (%)	Barom. Press. (kPa)
		IEEE Target	Meas.	Dev.	IEEE Target	Meas.	Dev.	IEEE Target	Meas.	Dev.						
Dec. 07	Brain 450	1.23 $\pm 10\%$	1.30	+5.7%	43.5 $\pm 5\%$	44.7	+2.8%	0.87 $\pm 5\%$	0.90	+3.4%	1000	24.0	23.3	≥ 15	33	102.1
Note(s)		<p>1. The fluid temperature was measured prior to and after the SAR evaluation to ensure the temperature remained within $\pm 2^\circ\text{C}$ of the fluid temperature reported during the dielectric parameter measurements.</p> <p>2. The SAR evaluations were performed within 24 hours of the system performance check.</p>														

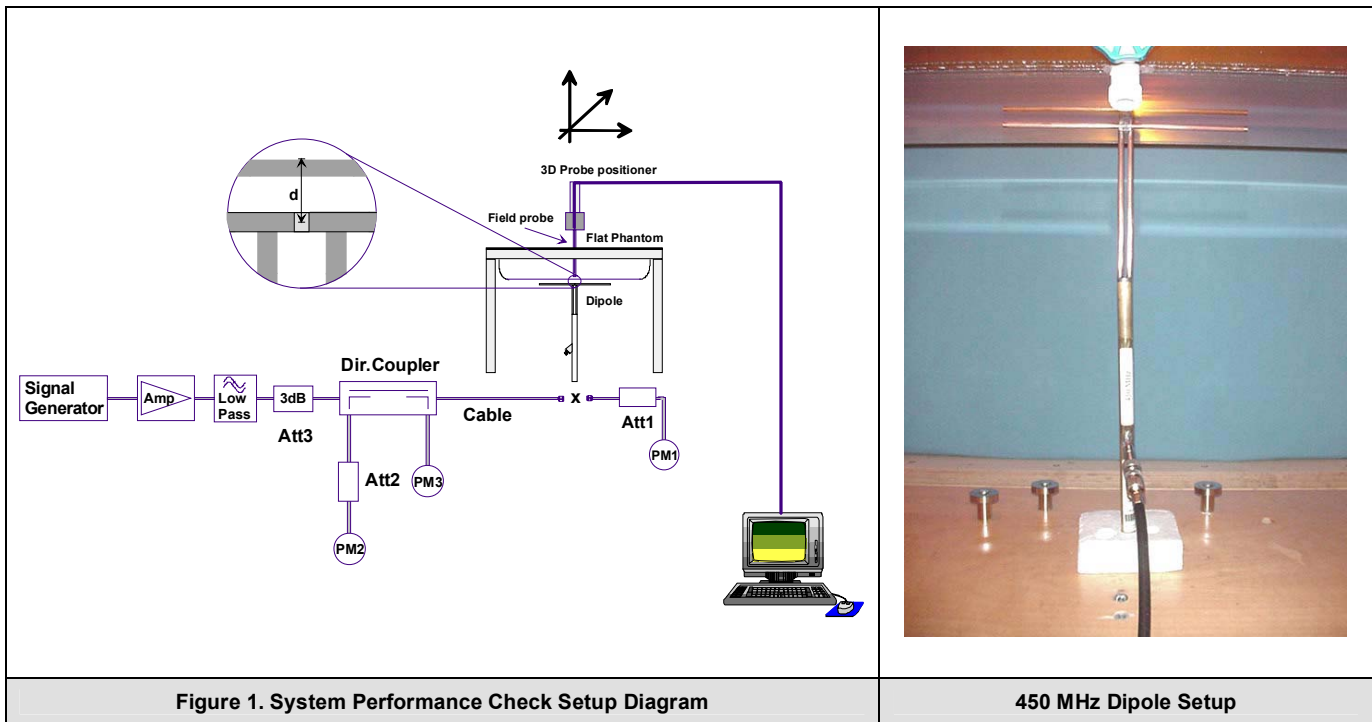



Figure 1. System Performance Check Setup Diagram

450 MHz Dipole Setup

Company:	Uniden America Corporation	FCC ID:	AMWUT025	IC ID:	513C-UT025	
Model(s):	GMR1448	DUT Type:	Portable FM UHF FRS/GMRS PTT Radio Transceiver			
2006 Celltech Labs Inc.		This document is not to be reproduced in whole or in part without the prior written permission of Celltech Labs Inc.				Page 8 of 37

	<u>Date(s) of Evaluation</u> December 07, 2006	<u>Test Report Serial No.</u> 120706AMW-T795-S95U	<u>Report Revision No.</u> Revision 1.0	
	<u>Report Issue Date</u> December 14, 2006	<u>Description of Test(s)</u> Specific Absorption Rate	<u>RF Exposure Category</u> General Population	

8.0 SIMULATED EQUIVALENT TISSUES



The 450MHz brain and body simulated tissue mixtures consist of a viscous gel using hydroxethylcellulose (HEC) gelling agent and saline solution. Preservation with a bactericide is added and visual inspection is made to ensure air bubbles are not trapped during the mixing process. The fluid was prepared according to standardized procedures, and measured for dielectric parameters (permittivity and conductivity).

SIMULATED TISSUE MIXTURES		
INGREDIENT	450 MHz Brain	450 MHz Body
	System Check & DUT Evaluation	DUT Evaluation
Water	38.56 %	52.00 %
Sugar	56.32 %	45.65 %
Salt	3.95 %	1.75 %
HEC	0.98 %	0.50 %
Bactericide	0.19 %	0.10 %

9.0 SAR SAFETY LIMITS

EXPOSURE LIMITS	SAR (W/kg)	
	(General Population / Uncontrolled Exposure Environment)	(Occupational / Controlled Exposure Environment)
Spatial Average (averaged over the whole body)	0.08	0.4
Spatial Peak (averaged over any 1 g of tissue)	1.60	8.0
Spatial Peak (hands/wrists/feet/ankles averaged over 10 g)	4.0	20.0
Uncontrolled environments are defined as locations where there is potential exposure of individuals who have no knowledge or control of their potential exposure.		
Controlled environments are defined as locations where there is potential exposure of individuals who have knowledge of their potential exposure and can exercise control over their exposure.		



Company:	Uniden America Corporation	FCC ID:	AMWUT025	IC ID:	513C-UT025	
Model(s):	GMR1448	DUT Type:	Portable FM UHF FRS/GMRS PTT Radio Transceiver			
2006 Celltech Labs Inc.		This document is not to be reproduced in whole or in part without the prior written permission of Celltech Labs Inc.				Page 9 of 37

 Celltech <small>Testing and Engineering Services Lab</small>	<u>Date(s) of Evaluation</u> December 07, 2006	<u>Test Report Serial No.</u> 120706AMW-T795-S95U	<u>Report Revision No.</u> Revision 1.0	 Certificate No. 2470.01
	<u>Report Issue Date</u> December 14, 2006	<u>Description of Test(s)</u> Specific Absorption Rate	<u>RF Exposure Category</u> General Population	

10.0 ROBOT SYSTEM SPECIFICATIONS

Specifications	
Positioner	Stäubli Unimation Corp. Robot Model: RX60L
Repeatability	0.02 mm
No. of axis	6
Data Acquisition Electronic (DAE) System	
<u>Cell Controller</u>	
Processor	AMD Athlon XP 2400+
Clock Speed	2.0 GHz
Operating System	Windows XP Professional
<u>Data Converter</u>	
Features	Signal Amplifier, multiplexer, A/D converter, and control logic
Software	Measurement Software: DASY4, V4.7 Build 44
	Postprocessing Software: SEMCAD, V1.8 Build 171
Connecting Lines	Optical downlink for data and status info., Optical uplink for commands and clock
DASY4 Measurement Server	
Function	Real-time data evaluation for field measurements and surface detection
Hardware	PC/104 166MHz Pentium CPU; 32 MB chipdisk; 64 MB RAM
Connections	COM1, COM2, DAE, Robot, Ethernet, Service Interface
E-Field Probe	
Model	ET3DV6
Serial No.	1387
Construction	Triangular core fiber optic detection system
Frequency	10 MHz to 6 GHz
Linearity	±0.2 dB (30 MHz to 3 GHz)
Phantom(s)	
<u>Evaluation Phantom</u>	
Type	Side Planar Phantom
Shell Material	Plexiglas
Bottom Thickness	2.0 mm ± 0.1 mm
Outer Dimensions	75.0 cm (L) x 22.5 cm (W) x 20.5 cm (H); Back Plane: 25.7 cm (H)
<u>Validation Phantom (≤ 450MHz)</u>	
Type	Planar Phantom
Shell Material	Plexiglas
Bottom Thickness	6.2 mm ± 0.1 mm
Outer Dimensions	86.0 cm (L) x 39.5 cm (W) x 21.8 cm (H)

Company:	Uniden America Corporation	FCC ID:	AMWUT025	IC ID:	513C-UT025	
Model(s):	GMR1448	DUT Type:	Portable FM UHF FRS/GMRS PTT Radio Transceiver			
2006 Celltech Labs Inc.		This document is not to be reproduced in whole or in part without the prior written permission of Celltech Labs Inc.				Page 10 of 37

	<u>Date(s) of Evaluation</u> December 07, 2006	<u>Test Report Serial No.</u> 120706AMW-T795-S95U	<u>Report Revision No.</u> Revision 1.0	 
	<u>Report Issue Date</u> December 14, 2006	<u>Description of Test(s)</u> Specific Absorption Rate	<u>RF Exposure Category</u> General Population	

11.0 PROBE SPECIFICATION (ET3DV6)

<p>Construction: Symmetrical design with triangular core Built-in shielding against static charges PEEK enclosure material (resistant to organic solvents, glycol)</p> <p>Calibration: In air from 10 MHz to 2.5 GHz In brain simulating tissue at frequencies of 900 MHz and 1.8 GHz (accuracy $\pm 8\%$)</p> <p>Frequency: 10 MHz to > 6 GHz; Linearity: ± 0.2 dB (30 MHz to 3 GHz)</p> <p>Directivity: ± 0.2 dB in brain tissue (rotation around probe axis) ± 0.4 dB in brain tissue (rotation normal to probe axis)</p> <p>Dynamic Range: 5 μW/g to > 100 mW/g; Linearity: ± 0.2 dB</p> <p>Surface Detect: ± 0.2 mm repeatability in air and clear liquids over diffuse reflecting surfaces</p> <p>Dimensions: Overall length: 330 mm Tip length: 16 mm Body diameter: 12 mm Tip diameter: 6.8 mm Distance from probe tip to dipole centers: 2.7 mm</p> <p>Application: General dosimetry up to 3 GHz Compliance tests of mobile phone</p>	
	ET3DV6 E-Field Probe

12.0 SIDE PLANAR PHANTOM

<p>The side planar phantom is constructed of Plexiglas material with a 2.0 mm shell thickness for face-held and body-worn SAR evaluations of portable radio transceivers. The side planar phantom is mounted on the side of the DASY4 compact system table.</p>	
	Side Planar Phantom

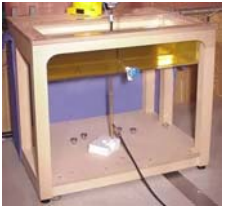

13.0 VALIDATION PLANAR PHANTOM

<p>The validation planar phantom is constructed of Plexiglas material with a 6.0 mm shell thickness for system validations at 450MHz and below. The validation planar phantom is mounted to the table of the DASY4 compact system.</p>	
	Validation Planar Phantom

14.0 DEVICE HOLDER



<p>The DASY4 device holder has two scales for device rotation (with respect to the body axis) and the device inclination (with respect to the line between the ear openings). The plane between the ear openings and the mouth tip has a rotation angle of 65°. The bottom plate contains three pair of bolts for locking the device holder. The device holder positions are adjusted to the standard measurement positions in the three sections.</p>	
	Device Holder

Company:	Uniden America Corporation	FCC ID:	AMWUT025	IC ID:	513C-UT025	
Model(s):	GMR1448	DUT Type:	Portable FM UHF FRS/GMRS PTT Radio Transceiver			
2006 Celltech Labs Inc.		This document is not to be reproduced in whole or in part without the prior written permission of Celltech Labs Inc.				Page 11 of 37

 Celltech <small>Testing and Engineering Services Ltd.</small>	<u>Date(s) of Evaluation</u> December 07, 2006	<u>Test Report Serial No.</u> 120706AMW-T795-S95U	<u>Report Revision No.</u> Revision 1.0	 Certificate No. 2470.01
	<u>Report Issue Date</u> December 14, 2006	<u>Description of Test(s)</u> Specific Absorption Rate	<u>RF Exposure Category</u> General Population	

15.0 TEST EQUIPMENT LIST

TEST EQUIPMENT		ASSET NO.	SERIAL NO.	DATE CALIBRATED		CALIBRATION DUE DATE
USED	DESCRIPTION					
x	Schmid & Partner DASY4 System	-	-	-	-	-
x	-DASY4 Measurement Server	00158	1078	N/A	N/A	N/A
x	-Robot	00046	599396-01	N/A	N/A	N/A
x	-DAE4	00019	353	21Jun06	21Jun07	21Jun07
	-DAE3	00018	370	08Feb06	08Feb07	08Feb07
x	-ET3DV6 E-Field Probe	00016	1387	16Mar06	16Mar07	16Mar07
	-EX3DV4 E-Field Probe	00125	3547	14Feb06	14Feb07	14Feb07
	-300MHz Validation Dipole	00023	135	23Oct06	23Oct07	23Oct07
x	-450MHz Validation Dipole	00024	136	07Dec06	07Dec07	07Dec07
	-835MHz Validation Dipole	00022	411	Brain	28Mar06	28Mar07
				Body	27Mar06	27Mar07
	-900MHz Validation Dipole	00020	054	Brain	06Jun06	06Jun07
				Body	06Jun06	06Jun07
	-1640MHz Validation Dipole	00211	0180	Brain	07Aug06	07Aug07
	-1800MHz Validation Dipole	00021	247	Brain	08Jun06	08Jun07
				Body	09Jun06	09Jun07
	-1900MHz Validation Dipole	00032	151	Brain	09Jun06	09Jun07
				Body	12Jun06	12Jun07
	-2450MHz Validation Dipole	00025	150	Body	24Apr06	24Apr07
	-5800MHz Validation Dipole	00126	1031	Brain	15Mar06	15Mar07
				Body	18Jul06	18Jul07
	-SAM Phantom V4.0C	00154	1033	N/A	N/A	N/A
	-Barski Planar Phantom	00155	03-01	N/A	N/A	N/A
x	-Plexiglas Side Planar Phantom	00156	161	N/A	N/A	N/A
x	-Plexiglas Validation Planar Phantom	00157	137	N/A	N/A	N/A
x	ALS-PR-DIEL Dielectric Probe Kit	00160	260-00953	N/A	N/A	N/A
x	Gigatronics 8652A Power Meter	00110	1835801	12Apr06	12Apr07	12Apr07
	Gigatronics 8652A Power Meter	00007	1835272	03Feb06	03Feb07	03Feb07
x	Gigatronics 80701A Power Sensor	00011	1833542	03Feb06	03Feb07	03Feb07
x	Gigatronics 80701A Power Sensor	00013	1833713	03Feb06	03Feb07	03Feb07
x	HP 8753ET Network Analyzer	00134	US39170292	18Apr06	18Apr07	18Apr07
x	HP 8648D Signal Generator	00005	3847A00611	N/A	N/A	N/A
	Rohde & Schwarz SMR40 Signal Generator	00006	100104	06Apr06	06Apr07	06Apr07
x	Amplifier Research 5S1G4 Power Amplifier	00106	26235	N/A	N/A	N/A

 Celltech <small>Testing and Engineering Services Lab</small>	<u>Date(s) of Evaluation</u> December 07, 2006	<u>Test Report Serial No.</u> 120706AMW-T795-S95U	<u>Report Revision No.</u> Revision 1.0	 Certificate No. 2470.01
	<u>Report Issue Date</u> December 14, 2006	<u>Description of Test(s)</u> Specific Absorption Rate	<u>RF Exposure Category</u> General Population	

16.0 MEASUREMENT UNCERTAINTIES

UNCERTAINTY BUDGET FOR DEVICE EVALUATION						
Error Description	Uncertainty Value ±%	Probability Distribution	Divisor	ci 1g	Uncertainty Value ±% (1g)	V _i or V _{eff}
Measurement System						
Probe calibration	4.0	Normal	1	1	4.0	∞
Axial isotropy of the probe	4.7	Rectangular	1.732050808	0.7	1.9	∞
Spherical isotropy of the probe	9.6	Rectangular	1.732050808	0.7	3.9	∞
Spatial resolution	0	Rectangular	1.732050808	1	0.0	∞
Boundary effects	1	Rectangular	1.732050808	1	0.6	∞
Probe linearity	4.7	Rectangular	1.732050808	1	2.7	∞
Detection limit	1	Rectangular	1.732050808	1	0.6	∞
Readout electronics	0.3	Normal	1	1	0.3	∞
Response time	0.8	Rectangular	1.732050808	1	0.5	∞
Integration time	2.6	Rectangular	1.732050808	1	1.5	∞
RF ambient conditions	3	Rectangular	1.732050808	1	1.7	∞
Mech. constraints of robot	0.4	Rectangular	1.732050808	1	0.2	∞
Probe positioning	2.9	Rectangular	1.732050808	1	1.7	∞
Extrapolation & integration	1	Rectangular	1.732050808	1	0.6	∞
Test Sample Related						
Device positioning	2.9	Normal	1	1	2.9	12
Device holder uncertainty	3.6	Normal	1	1	3.6	8
Power drift	5	Rectangular	1.732050808	1	2.9	∞
Phantom and Setup						
Phantom uncertainty	4	Rectangular	1.732050808	1	2.3	∞
Liquid conductivity (target)	5	Rectangular	1.732050808	0.64	1.8	∞
Liquid conductivity (measured)	2.5	Normal	1	0.64	1.6	∞
Liquid permittivity (target)	5	Rectangular	1.732050808	0.6	1.7	∞
Liquid permittivity (measured)	2.5	Normal	1	0.6	1.5	∞
Combined Standard Uncertainty					9.88	
Expanded Uncertainty (k=2)					19.77	

Measurement Uncertainty Table in accordance with IEEE Standard 1528-2003 (see reference [5])

Company:	Uniden America Corporation	FCC ID:	AMWUT025	IC ID:	513C-UT025	
Model(s):	GMR1448	DUT Type:	Portable FM UHF FRS/GMRS PTT Radio Transceiver			
2006 Celltech Labs Inc.		This document is not to be reproduced in whole or in part without the prior written permission of Celltech Labs Inc.				Page 13 of 37



 Celltech <small>Testing and Engineering Services Lab</small>	<u>Date(s) of Evaluation</u> December 07, 2006	<u>Test Report Serial No.</u> 120706AMW-T795-S95U	<u>Report Revision No.</u> Revision 1.0	 Certificate No. 2470.01
	<u>Report Issue Date</u> December 14, 2006	<u>Description of Test(s)</u> Specific Absorption Rate	<u>RF Exposure Category</u> General Population	

MEASUREMENT UNCERTAINTIES (Cont.)

UNCERTAINTY BUDGET FOR SYSTEM VALIDATION						
Error Description	Uncertainty Value ±%	Probability Distribution	Divisor	ci 1g	Uncertainty Value ±% (1g)	V _i or V _{eff}
Measurement System						
Probe calibration	4.0	Normal	1	1	4.0	∞
Axial isotropy of the probe	4.7	Rectangular	1.732050808	1	2.7	∞
Spherical isotropy of the probe	0	Rectangular	1.732050808	1	0.0	∞
Spatial resolution	0	Rectangular	1.732050808	1	0.0	∞
Boundary effects	1	Rectangular	1.732050808	1	0.6	∞
Probe linearity	4.7	Rectangular	1.732050808	1	2.7	∞
Detection limit	1	Rectangular	1.732050808	1	0.6	∞
Readout electronics	0.3	Normal	1	1	0.3	∞
Response time	0	Rectangular	1.732050808	1	0.0	∞
Integration time	0	Rectangular	1.732050808	1	0.0	∞
RF ambient conditions	3	Rectangular	1.732050808	1	1.7	∞
Mech. constraints of robot	0.4	Rectangular	1.732050808	1	0.2	∞
Probe positioning	2.9	Rectangular	1.732050808	1	1.7	∞
Extrapolation & integration	1	Rectangular	1.732050808	1	0.6	∞
Test Sample Related						
Dipole Positioning	2	Normal	1.732050808	1	1.2	∞
Power & Power Drift	4.7	Normal	1.732050808	1	2.7	∞
Phantom and Setup						
Phantom uncertainty	4	Rectangular	1.732050808	1	2.3	∞
Liquid conductivity (target)	5	Rectangular	1.732050808	0.64	1.8	∞
Liquid conductivity (measured)	2.5	Normal	1	0.64	1.6	∞
Liquid permittivity (target)	5	Rectangular	1.732050808	0.6	1.7	∞
Liquid permittivity (measured)	2.5	Normal	1	0.6	1.5	∞
Combined Standard Uncertainty					7.93	
Expanded Uncertainty (k=2)					15.87	

Measurement Uncertainty Table in accordance with IEEE Standard 1528-2003 (see reference [5])



Company:	Uniden America Corporation	FCC ID:	AMWUT025	IC ID:	513C-UT025	
Model(s):	GMR1448	DUT Type:	Portable FM UHF FRS/GMRS PTT Radio Transceiver			
2006 Celltech Labs Inc.		This document is not to be reproduced in whole or in part without the prior written permission of Celltech Labs Inc.				Page 14 of 37

	<u>Date(s) of Evaluation</u> December 07, 2006	<u>Test Report Serial No.</u> 120706AMW-T795-S95U	<u>Report Revision No.</u> Revision 1.0	 Certificate No. 2470.01
	<u>Report Issue Date</u> December 14, 2006	<u>Description of Test(s)</u> Specific Absorption Rate	<u>RF Exposure Category</u> General Population	

17.0 REFERENCES

- [1] Federal Communications Commission - "Radiofrequency radiation exposure evaluation: portable devices", Rule Part 47 CFR §2.1093: 1999.
- [2] Health Canada - "Limits of Human Exposure to Radiofrequency Electromagnetic Fields in the Frequency Range from 3 kHz to 300 GHz", Safety Code 6: 1999.
- [3] Federal Communications Commission - "Evaluating Compliance with FCC Guidelines for Human Exposure to Radio frequency Electromagnetic Fields", OET Bulletin 65, Supplement C (Edition 01-01), FCC, Washington, D.C.: June 2001.
- [4] Industry Canada - "Radio Frequency Exposure Compliance of Radiocommunication Apparatus (All Frequency Bands)", Radio Standards Specification RSS-102 Issue 2: November 2005.
- [5] IEEE Standard 1528-2003 - "Recommended Practice for Determining the Peak Spatial-Average Specific Absorption Rate (SAR) in the Human Head from Wireless Communications Devices: Measurement Techniques": December 2003.

Company:	Uniden America Corporation	FCC ID:	AMWUT025	IC ID:	513C-UT025	
Model(s):	GMR1448	DUT Type:	Portable FM UHF FRS/GMRS PTT Radio Transceiver			
2006 Celltech Labs Inc.	This document is not to be reproduced in whole or in part without the prior written permission of Celltech Labs Inc.					Page 15 of 37

	<u>Date(s) of Evaluation</u> December 07, 2006	<u>Test Report Serial No.</u> 120706AMW-T795-S95U	<u>Report Revision No.</u> Revision 1.0	
	<u>Report Issue Date</u> December 14, 2006	<u>Description of Test(s)</u> Specific Absorption Rate	<u>RF Exposure Category</u> General Population	

APPENDIX A - SAR MEASUREMENT DATA

	<u>Date(s) of Evaluation</u> December 07, 2006	<u>Test Report Serial No.</u> 120706AMW-T795-S95U	<u>Report Revision No.</u> Revision 1.0	
	<u>Report Issue Date</u> December 14, 2006	<u>Description of Test(s)</u> Specific Absorption Rate	<u>RF Exposure Category</u> General Population	

Date Tested: 12/07/2006

Face-Held SAR - 462.5625 MHz - Channel 1 (GMRS) - NiMH Battery Pack

DUT: Uniden; Model: GMR1448; Type: Portable UHF FRS/GMRS PTT Radio Transceiver; Serial: #5

Ambient Temp: 24.0°C; Fluid Temp: 23.3°C; Barometric Pressure: 102.1 kPa; Humidity: 33%

Communication System: FM UHF
4.8V, 550mAh NiMH Battery Pack
RF Output Power: 0.65 Watts (ERP)
Frequency: 462.5625 MHz; Duty Cycle: 1:1
Medium: HSL450 Medium parameters used: $\sigma = 0.90$ mho/m; $\epsilon_r = 44.7$; $\rho = 1000$ kg/m³

- Probe: ET3DV6 - SN1387; ConvF(7.4, 7.4, 7.4); Calibrated: 16/03/2006
- Sensor-Surface: 4mm (Mechanical Surface Detection)
- Electronics: DAE4 Sn353; Calibrated: 21/06/2006
- Phantom: Side Planar; Type: Plexiglas; Serial: 161
- Measurement SW: DASY4, V4.7 Build 44; Postprocessing SW: SEMCAD, V1.8 Build 171

Face-Held SAR - 2.5 cm Spacing from Front of DUT to Planar Phantom - GMRS Channel 1 Area Scan (7x15x1): Measurement grid: dx=15mm, dy=15mm

Face-Held SAR - 2.5 cm Spacing from Front of DUT to Planar Phantom - GMRS Channel 1 Zoom Scan (5x5x7)/Cube 0: Measurement grid: dx=7.5mm, dy=7.5mm, dz=5mm
Reference Value = 37.5 V/m; Power Drift = -0.284 dB
Peak SAR (extrapolated) = 2.02 W/kg
SAR(1 g) = 1.27 mW/g; SAR(10 g) = 0.887 mW/g
Maximum value of SAR (measured) = 1.33 mW/g

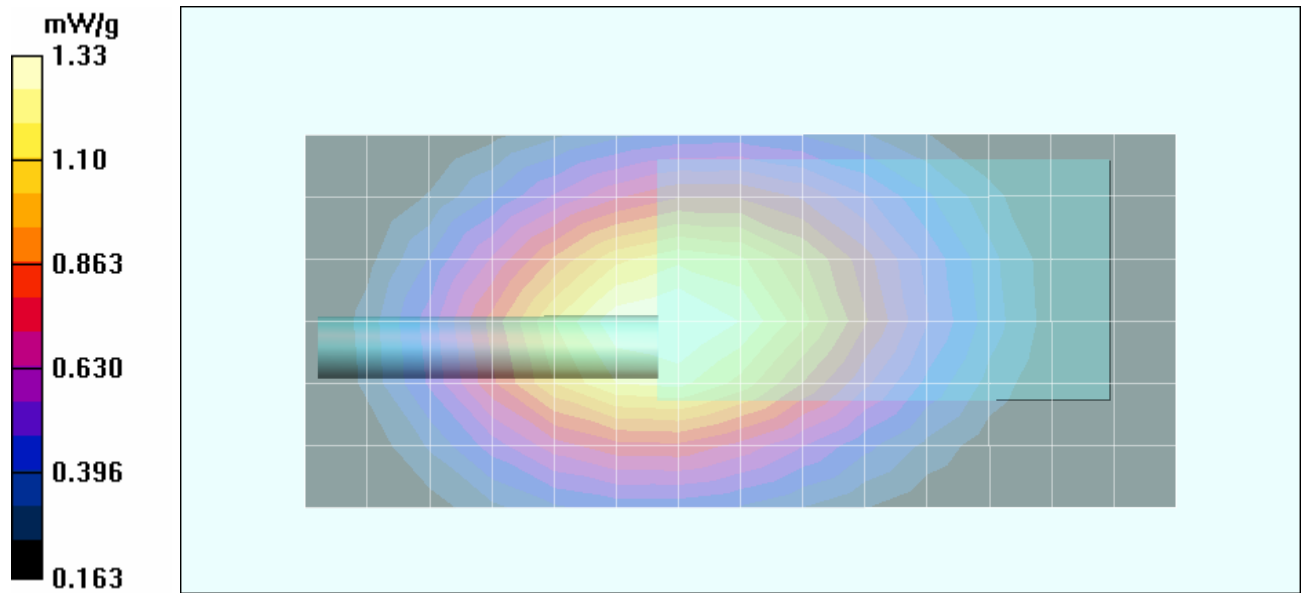

Company:	Uniden America Corporation	FCC ID:	AMWUT025	IC ID:	513C-UT025	
Model(s):	GMR1448	DUT Type:	Portable FM UHF FRS/GMRS PTT Radio Transceiver			
2006 Celltech Labs Inc.		This document is not to be reproduced in whole or in part without the prior written permission of Celltech Labs Inc.				Page 17 of 37

	<u>Date(s) of Evaluation</u> December 07, 2006	<u>Test Report Serial No.</u> 120706AMW-T795-S95U	<u>Report Revision No.</u> Revision 1.0	
	<u>Report Issue Date</u> December 14, 2006	<u>Description of Test(s)</u> Specific Absorption Rate	<u>RF Exposure Category</u> General Population	

Date Tested: 12/07/2006

Face-Held SAR - 462.5625 MHz - Channel 1 (GMRS) - Alkaline Batteries

DUT: Uniden; Model: GMR1448; Type: Portable UHF FRS/GMRS PTT Radio Transceiver; Serial: #5

Ambient Temp: 24.0°C; Fluid Temp: 23.3°C; Barometric Pressure: 102.1 kPa; Humidity: 33%

Communication System: FM UHF
 AAA Alkaline Batteries x4 (6 V)
 RF Output Power: 0.65 Watts (ERP)
 Frequency: 462.5625 MHz; Duty Cycle: 1:1
 Medium: HSL450 Medium parameters used: $\sigma = 0.90$ mho/m; $\epsilon_r = 44.7$; $\rho = 1000$ kg/m³

- Probe: ET3DV6 - SN1387; ConvF(7.4, 7.4, 7.4); Calibrated: 16/03/2006
- Sensor-Surface: 4mm (Mechanical Surface Detection)
- Electronics: DAE4 Sn353; Calibrated: 21/06/2006
- Phantom: Side Planar; Type: Plexiglas; Serial: 161
- Measurement SW: DASY4, V4.7 Build 44; Postprocessing SW: SEMCAD, V1.8 Build 171

Face-Held SAR - 2.5 cm Spacing from Front of DUT to Planar Phantom - GMRS Channel 1 Area Scan (7x15x1): Measurement grid: dx=15mm, dy=15mm

Face-Held SAR - 2.5 cm Spacing from Front of DUT to Planar Phantom - GMRS Channel 1 Zoom Scan (5x5x7)/Cube 0: Measurement grid: dx=7.5mm, dy=7.5mm, dz=5mm
 Reference Value = 38.8 V/m; Power Drift = -0.580 dB
 Peak SAR (extrapolated) = 2.07 W/kg
SAR(1 g) = 1.29 mW/g; SAR(10 g) = 0.899 mW/g
 Maximum value of SAR (measured) = 1.35 mW/g

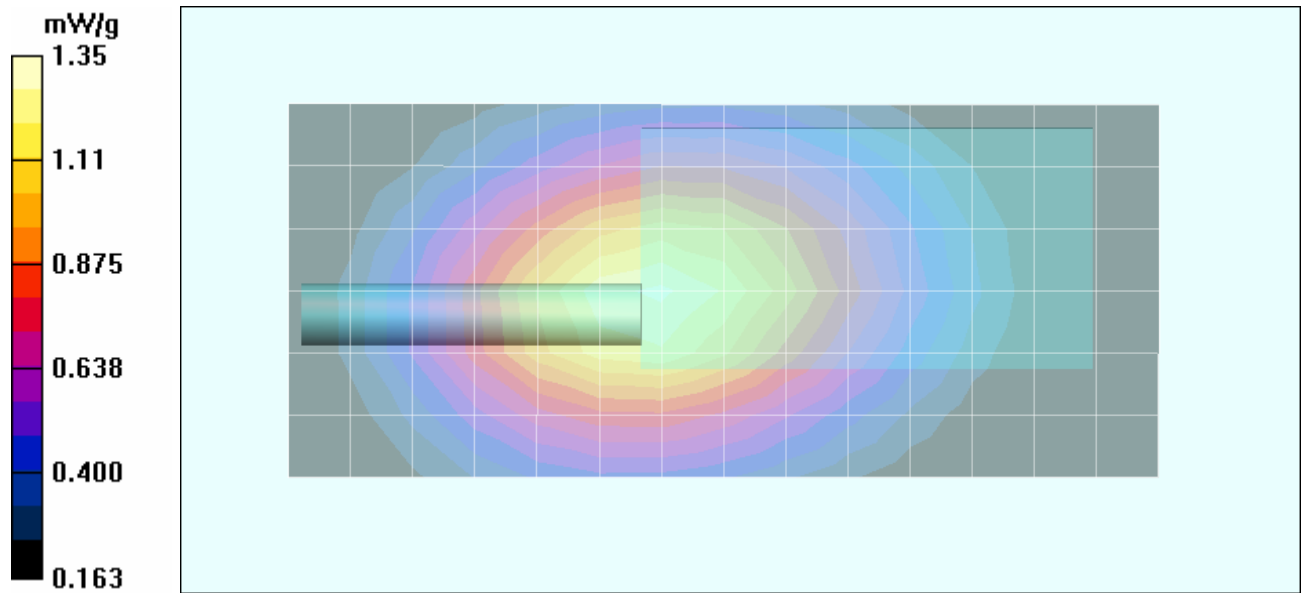

Company:	Uniden America Corporation	FCC ID:	AMWUT025	IC ID:	513C-UT025	
Model(s):	GMR1448	DUT Type:	Portable FM UHF FRS/GMRS PTT Radio Transceiver			
2006 Celltech Labs Inc.		This document is not to be reproduced in whole or in part without the prior written permission of Celltech Labs Inc.				Page 18 of 37

Z-Axis Scan

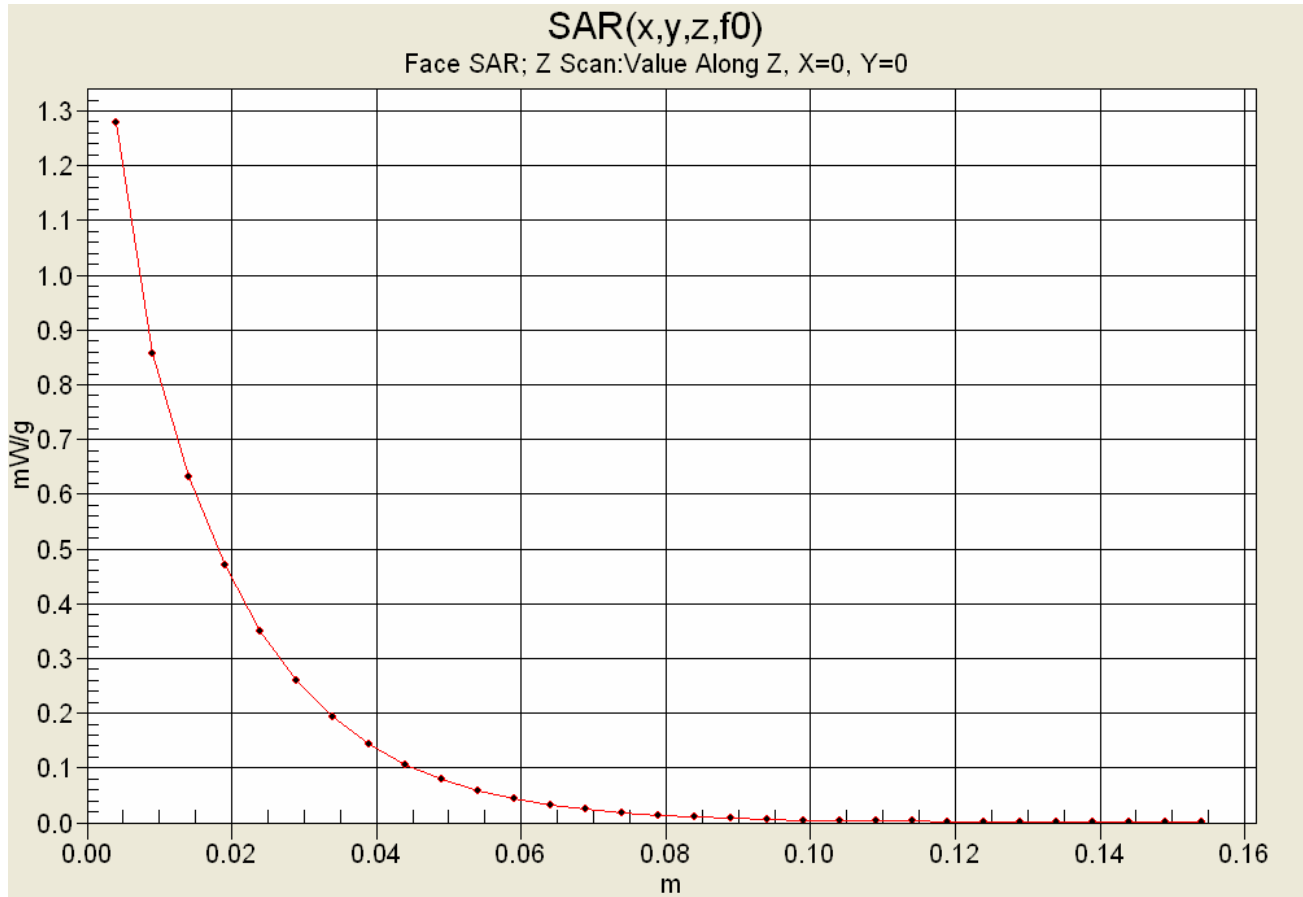

	<u>Date(s) of Evaluation</u> December 07, 2006	<u>Test Report Serial No.</u> 120706AMW-T795-S95U	<u>Report Revision No.</u> Revision 1.0	
	<u>Report Issue Date</u> December 14, 2006	<u>Description of Test(s)</u> Specific Absorption Rate	<u>RF Exposure Category</u> General Population	

Date Tested: 12/07/2006

Body-Worn SAR - 462.5625 MHz - Channel 1 (GMRS) - NiMH Battery Pack

DUT: Uniden; Model: GMR1448; Type: Portable UHF FRS/GMRS PTT Radio Transceiver; Serial: #5

Body-Worn Accessory: Plastic Belt-Clip; Audio Accessory: Headset (Ear-Loop with Boom-Microphone)

Ambient Temp: 24.0°C; Fluid Temp: 23.3°C; Barometric Pressure: 102.1 kPa; Humidity: 33%

Communication System: FM UHF
 4.8V, 550mAh NiMH Battery Pack
 RF Output Power: 0.65 Watts (ERP)
 Frequency: 462.5625 MHz; Duty Cycle: 1:1
 Medium: M450 Medium parameters used: $\sigma = 0.94$ mho/m; $\epsilon_r = 56.9$; $\rho = 1000$ kg/m³



- Probe: ET3DV6 - SN1387; ConvF(7.3, 7.3, 7.3); Calibrated: 16/03/2006
- Sensor-Surface: 4mm (Mechanical Surface Detection)
- Electronics: DAE4 Sn353; Calibrated: 21/06/2006
- Phantom: Side Planar; Type: Plexiglas; Serial: 161
- Measurement SW: DASY4, V4.7 Build 44; Postprocessing SW: SEMCAD, V1.8 Build 171

Body-Worn SAR - 0.7 cm Belt-Clip Spacing between Back of DUT and Planar Phantom - GMRS Channel 1 Area Scan (7x15x1): Measurement grid: dx=15mm, dy=15mm

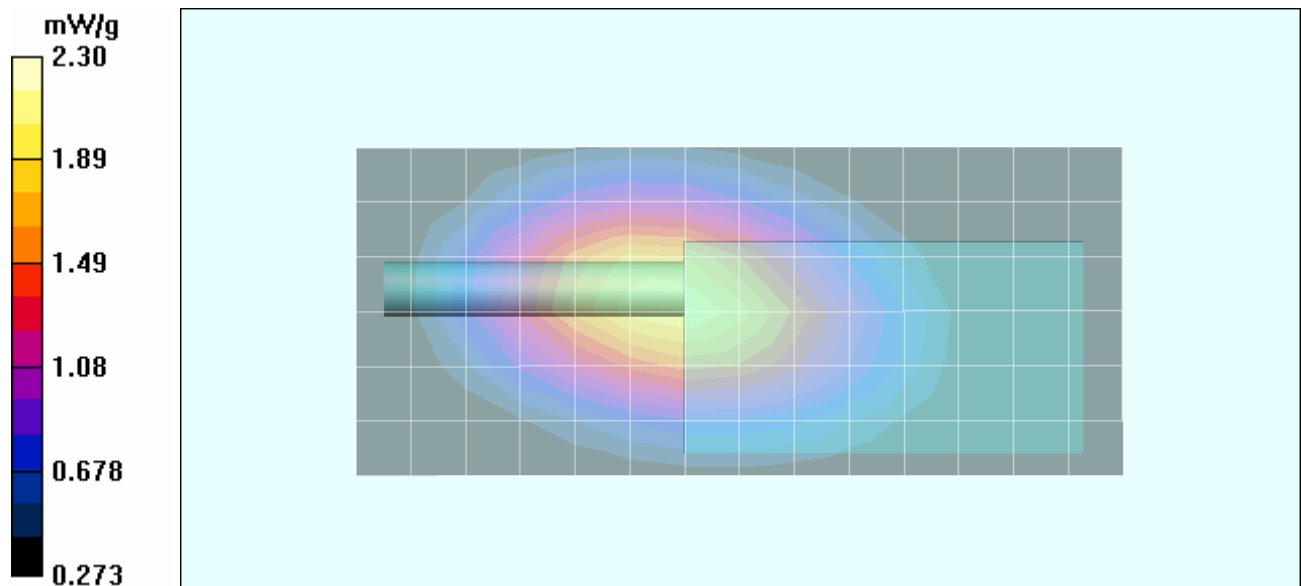
Body-Worn SAR - 0.7 cm Belt-Clip Spacing between Back of DUT and Planar Phantom - GMRS Channel 1 Zoom Scan (5x5x7)/Cube 0: Measurement grid: dx=7.5mm, dy=7.5mm, dz=5mm
 Reference Value = 42.5 V/m; Power Drift = 0.374 dB
 Peak SAR (extrapolated) = 3.48 W/kg
SAR(1 g) = 2.19 mW/g; SAR(10 g) = 1.52 mW/g
 Maximum value of SAR (measured) = 2.30 mW/g





Company:	Uniden America Corporation	FCC ID:	AMWUT025	IC ID:	513C-UT025	
Model(s):	GMR1448	DUT Type:	Portable FM UHF FRS/GMRS PTT Radio Transceiver			
2006 Celltech Labs Inc.		This document is not to be reproduced in whole or in part without the prior written permission of Celltech Labs Inc.				Page 20 of 37

	<u>Date(s) of Evaluation</u> December 07, 2006	<u>Test Report Serial No.</u> 120706AMW-T795-S95U	<u>Report Revision No.</u> Revision 1.0	 Certificate No. 2470.01
	<u>Report Issue Date</u> December 14, 2006	<u>Description of Test(s)</u> Specific Absorption Rate	<u>RF Exposure Category</u> General Population	

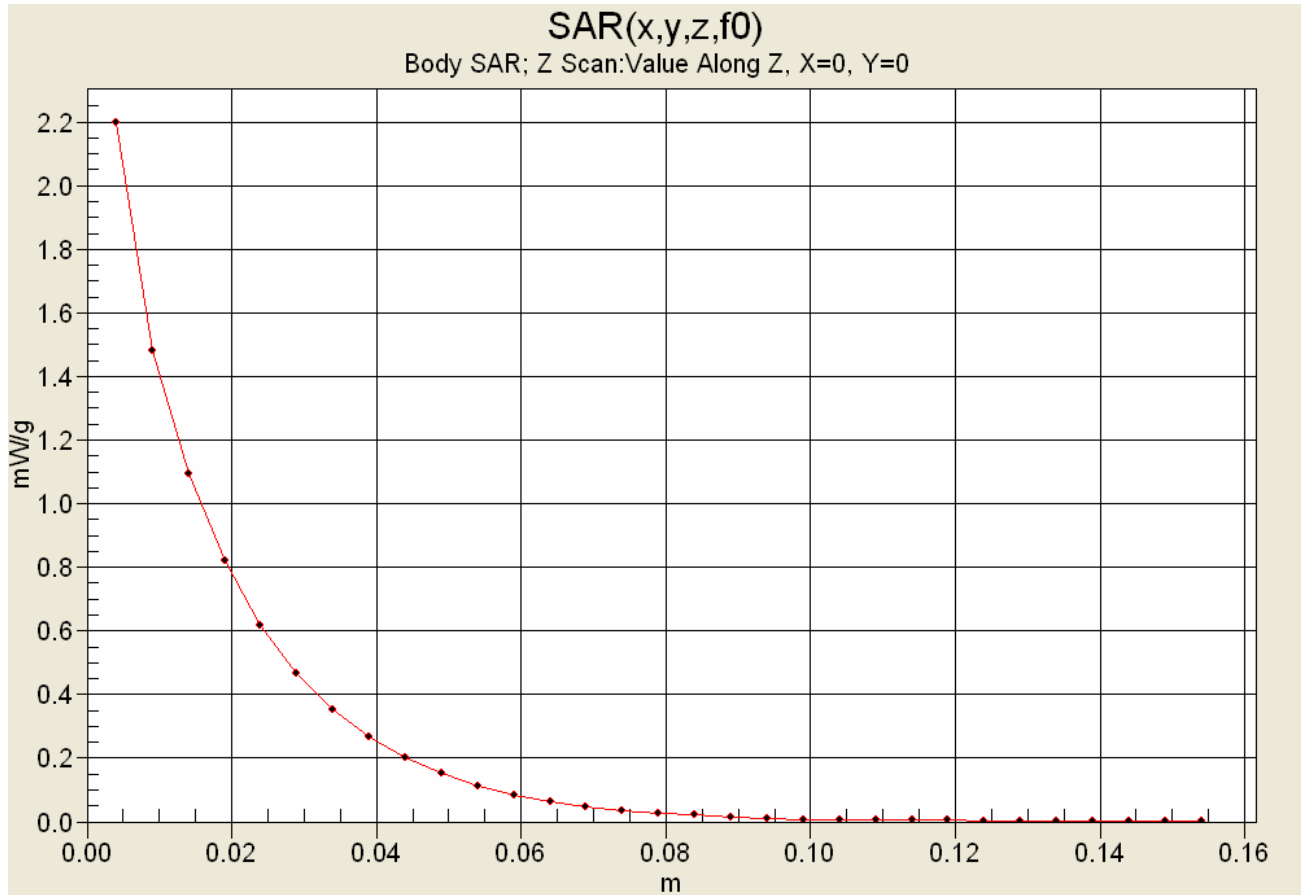
Z-Axis Scan



Company:	Uniden America Corporation	FCC ID:	AMWUT025	IC ID:	513C-UT025	
Model(s):	GMR1448	DUT Type:	Portable FM UHF FRS/GMRS PTT Radio Transceiver			
2006 Celltech Labs Inc.		This document is not to be reproduced in whole or in part without the prior written permission of Celltech Labs Inc.				Page 21 of 37

	<u>Date(s) of Evaluation</u> December 07, 2006	<u>Test Report Serial No.</u> 120706AMW-T795-S95U	<u>Report Revision No.</u> Revision 1.0	
	<u>Report Issue Date</u> December 14, 2006	<u>Description of Test(s)</u> Specific Absorption Rate	<u>RF Exposure Category</u> General Population	

Date Tested: 12/07/2006

Body-Worn SAR - 462.5625 MHz - Channel 1 (GMRS) - Alkaline Batteries

DUT: Uniden; Model: GMR1448; Type: Portable UHF FRS/GMRS PTT Radio Transceiver; Serial: #5

Body-Worn Accessory: Plastic Belt-Clip; Audio Accessory: Headset (Ear-Loop with Boom-Microphone)

Ambient Temp: 24.0°C; Fluid Temp: 23.3°C; Barometric Pressure: 102.1 kPa; Humidity: 33%

Communication System: FM UHF

AAA Alkaline Batteries x4 (6 V)

RF Output Power: 0.65 Watts (ERP)

Frequency: 462.5625 MHz; Duty Cycle: 1:1

Medium: M450 Medium parameters used: $\sigma = 0.94$ mho/m; $\epsilon_r = 56.9$; $\rho = 1000$ kg/m³

- Probe: ET3DV6 - SN1387; ConvF(7.3, 7.3, 7.3); Calibrated: 16/03/2006
- Sensor-Surface: 4mm (Mechanical Surface Detection)
- Electronics: DAE4 Sn353; Calibrated: 21/06/2006
- Phantom: Side Planar; Type: Plexiglas; Serial: 161
- Measurement SW: DASY4, V4.7 Build 44; Postprocessing SW: SEMCAD, V1.8 Build 171

Body-Worn SAR - 0.7 cm Belt-Clip Spacing between Back of DUT and Planar Phantom - GMRS Channel 1 Area Scan (7x15x1): Measurement grid: dx=15mm, dy=15mm

Body-Worn SAR - 0.7 cm Belt-Clip Spacing between Back of DUT and Planar Phantom - GMRS Channel 1

Zoom Scan (5x5x7)/Cube 0: Measurement grid: dx=7.5mm, dy=7.5mm, dz=5mm

Reference Value = 45.5 V/m; Power Drift = -0.543 dB



Peak SAR (extrapolated) = 3.38 W/kg

SAR(1 g) = 2.13 mW/g; SAR(10 g) = 1.47 mW/g

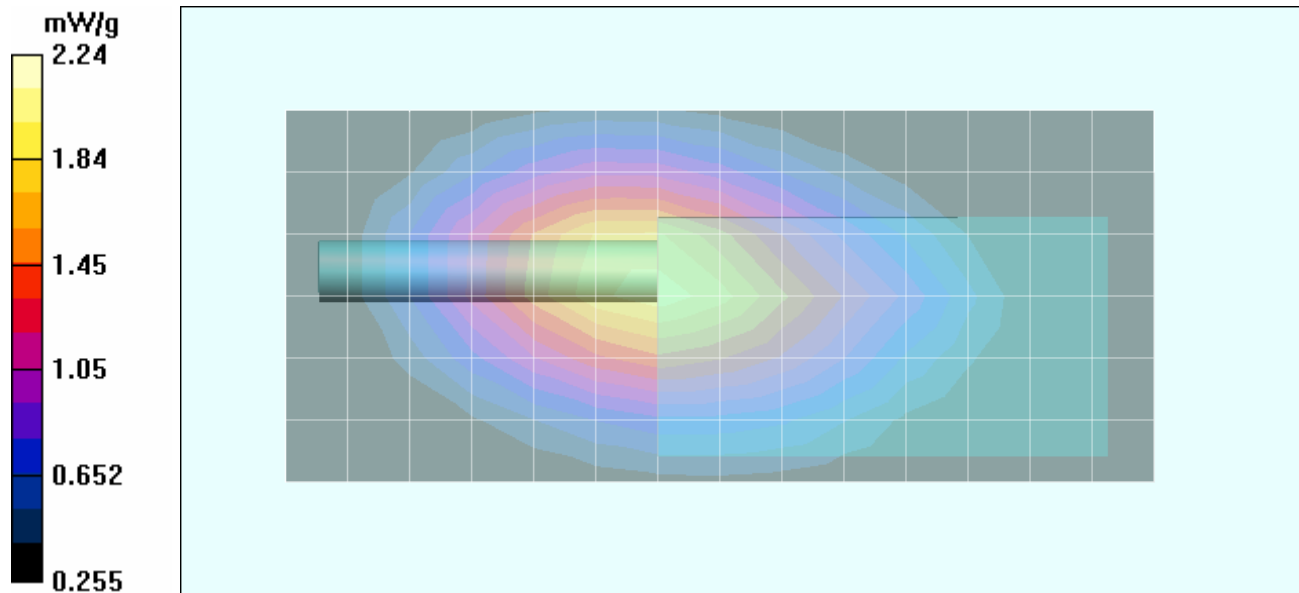
Maximum value of SAR (measured) = 2.24 mW/g



Company:	Uniden America Corporation	FCC ID:	AMWUT025	IC ID:	513C-UT025	
Model(s):	GMR1448	DUT Type:	Portable FM UHF FRS/GMRS PTT Radio Transceiver			
2006 Celltech Labs Inc.		This document is not to be reproduced in whole or in part without the prior written permission of Celltech Labs Inc.				Page 22 of 37

	<u>Date(s) of Evaluation</u> December 07, 2006	<u>Test Report Serial No.</u> 120706AMW-T795-S95U	<u>Report Revision No.</u> Revision 1.0	 Certificate No. 2470.01
	<u>Report Issue Date</u> December 14, 2006	<u>Description of Test(s)</u> Specific Absorption Rate	<u>RF Exposure Category</u> General Population	

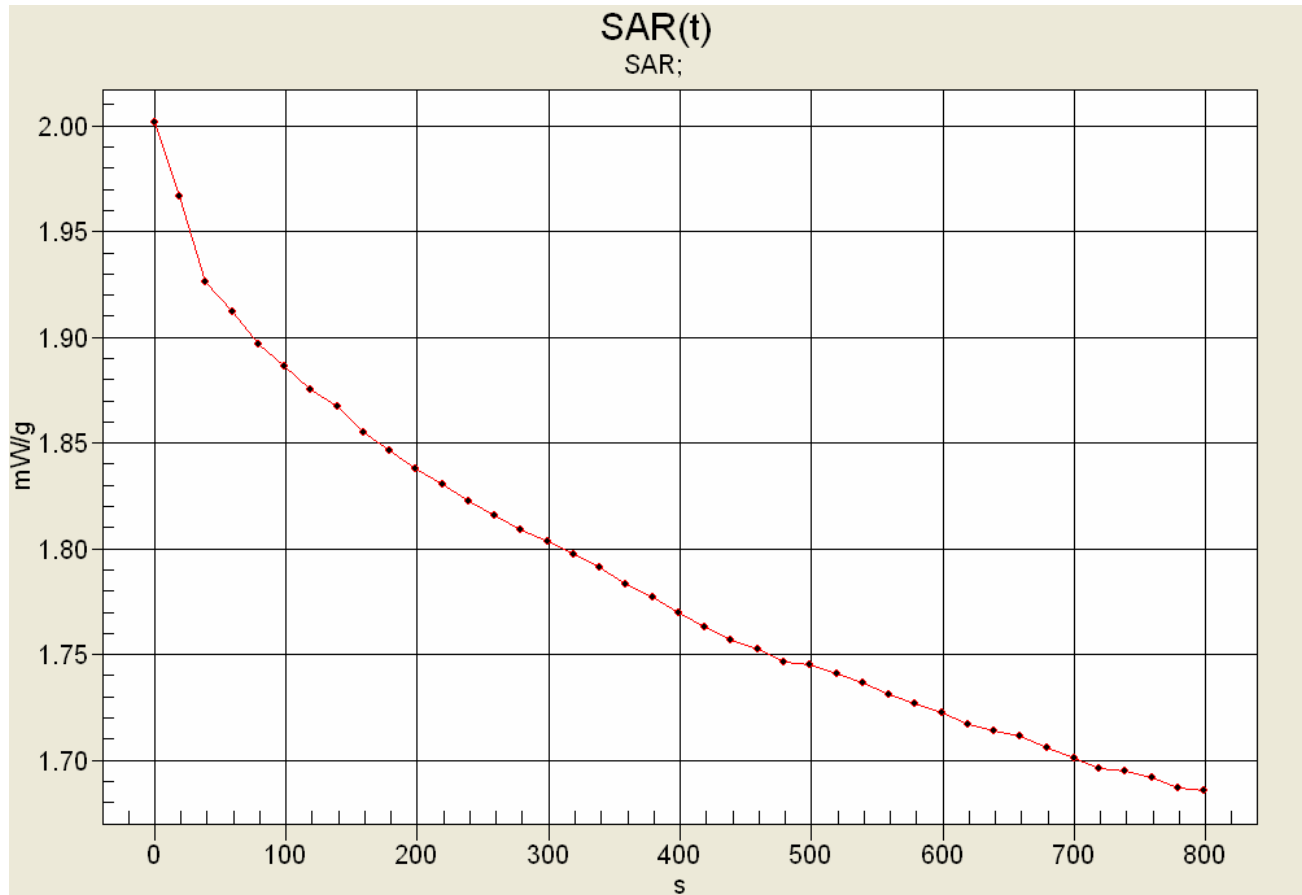

SAR-versus-Time Power Droop Evaluation

Body-Worn Configuration
Alkaline Batteries (6 V)
Fixed Stubby Antenna
GMRS Channel 1 (462.5625 MHz)



Max. SAR: 1.99946 mW/g
Min. SAR: 1.6837 mW/g (-0.746 dB)
SAR after 340s: 1.78896 mW/g (-0.483 dB)
(340s = Zoom Scan Duration)
(800s = Area Scan Duration)

Company:	Uniden America Corporation	FCC ID:	AMWUT025	IC ID:	513C-UT025	
Model(s):	GMR1448	DUT Type:	Portable FM UHF FRS/GMRS PTT Radio Transceiver			
2006 Celltech Labs Inc.		This document is not to be reproduced in whole or in part without the prior written permission of Celltech Labs Inc.				Page 23 of 37

	<u>Date(s) of Evaluation</u> December 07, 2006	<u>Test Report Serial No.</u> 120706AMW-T795-S95U	<u>Report Revision No.</u> Revision 1.0	
	<u>Report Issue Date</u> December 14, 2006	<u>Description of Test(s)</u> Specific Absorption Rate	<u>RF Exposure Category</u> General Population	

APPENDIX B - SYSTEM PERFORMANCE CHECK DATA

Company:	Uniden America Corporation	FCC ID:	AMWUT025	IC ID:	513C-UT025	
Model(s):	GMR1448	DUT Type:	Portable FM UHF FRS/GMRS PTT Radio Transceiver			
2006 Celltech Labs Inc.	This document is not to be reproduced in whole or in part without the prior written permission of Celltech Labs Inc.					Page 24 of 37

	<u>Date(s) of Evaluation</u> December 07, 2006	<u>Test Report Serial No.</u> 120706AMW-T795-S95U	<u>Report Revision No.</u> Revision 1.0	
	<u>Report Issue Date</u> December 14, 2006	<u>Description of Test(s)</u> Specific Absorption Rate	<u>RF Exposure Category</u> General Population	

Date Tested: 12/07/2006

System Performance Check - 450 MHz Dipole

DUT: Dipole 450 MHz; Asset: 00024; Serial: 136; Validation: 12/07/2006

Ambient Temp: 24.0°C; Fluid Temp: 23.3°C; Barometric Pressure: 102.1 kPa; Humidity: 33%

Communication System: CW

Forward Conducted Power: 250 mW

Frequency: 450 MHz; Duty Cycle: 1:1

Medium: HSL450 Medium parameters used: $\sigma = 0.90$ mho/m; $\epsilon_r = 44.7$; $\rho = 1000$ kg/m³

- Probe: ET3DV6 - SN1387; ConvF(7.4, 7.4, 7.4); Calibrated: 16/03/2006

- Sensor-Surface: 4mm (Mechanical Surface Detection)

- Electronics: DAE4 Sn353; Calibrated: 21/06/2006

- Phantom: Validation Planar; Type: Plexiglas; Serial: 137

- Measurement SW: DASY4, V4.7 Build 44; Postprocessing SW: SEMCAD, V1.8 Build 171

450 MHz Dipole - System Performance Check/Area Scan (6x11x1):

Measurement grid: dx=15mm, dy=15mm

450 MHz Dipole - System Performance Check/Zoom Scan (5x5x7)/Cube 0:

Measurement grid: dx=7.5mm, dy=7.5mm, dz=5mm

Reference Value = 39.0 V/m; Power Drift = 0.054 dB

Peak SAR (extrapolated) = 2.29 W/kg

SAR(1 g) = 1.30 mW/g; SAR(10 g) = 0.828 mW/g

Maximum value of SAR (measured) = 1.38 mW/g

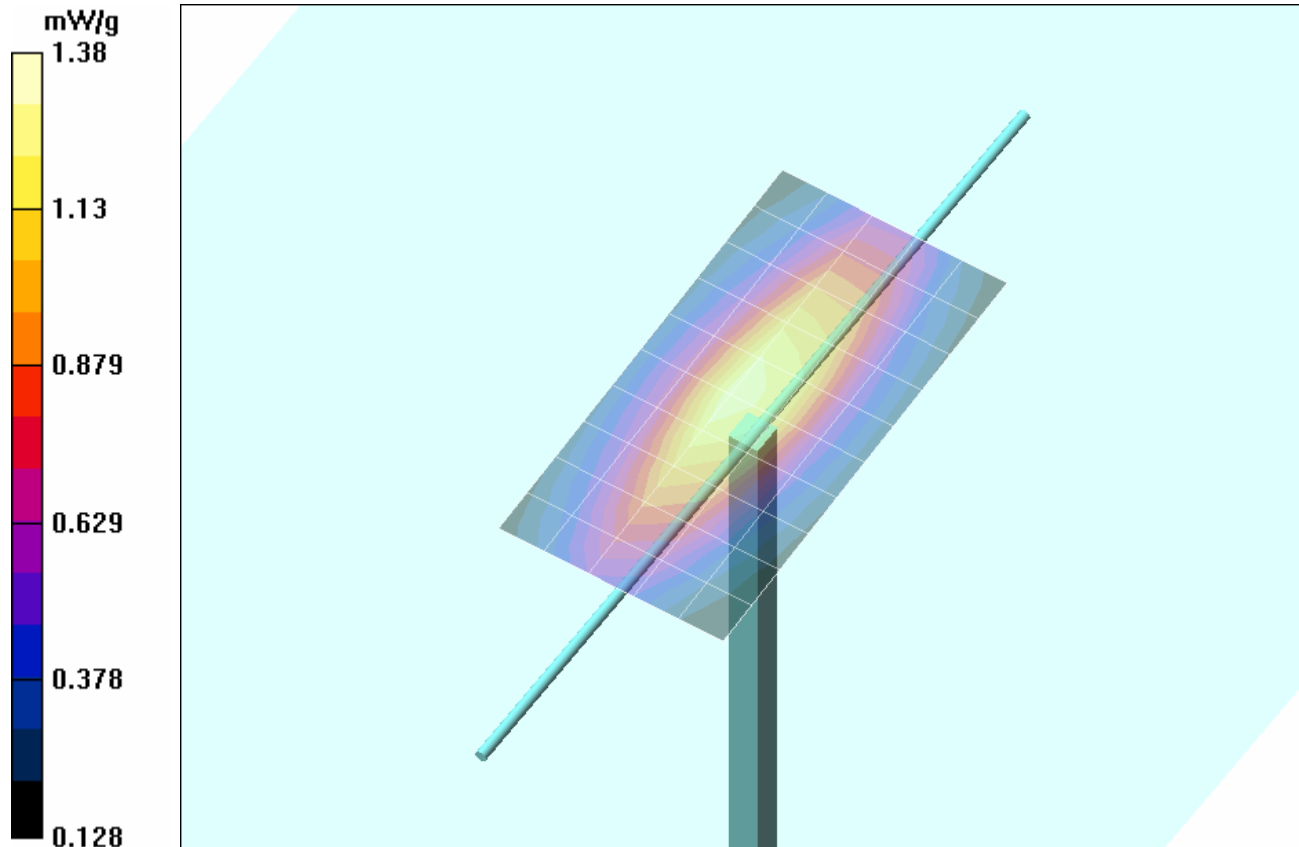



Company:	Uniden America Corporation	FCC ID:	AMWUT025	IC ID:	513C-UT025	
Model(s):	GMR1448	DUT Type:	Portable FM UHF FRS/GMRS PTT Radio Transceiver			
2006 Celltech Labs Inc.		This document is not to be reproduced in whole or in part without the prior written permission of Celltech Labs Inc.				Page 25 of 37

	<u>Date(s) of Evaluation</u> December 07, 2006	<u>Test Report Serial No.</u> 120706AMW-T795-S95U	<u>Report Revision No.</u> Revision 1.0	
	<u>Report Issue Date</u> December 14, 2006	<u>Description of Test(s)</u> Specific Absorption Rate	<u>RF Exposure Category</u> General Population	

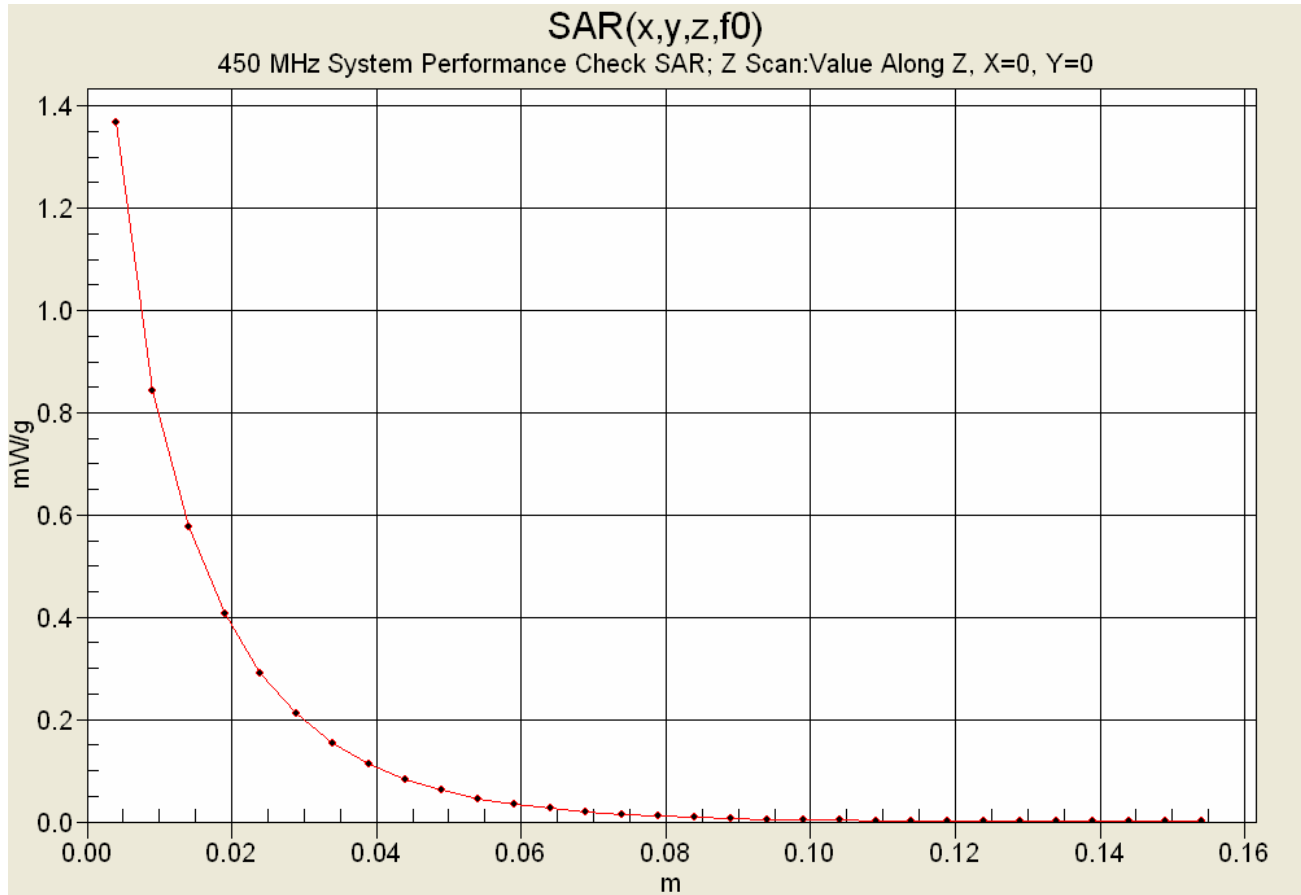
Z-Axis Scan



Company:	Uniden America Corporation	FCC ID:	AMWUT025	IC ID:	513C-UT025	
Model(s):	GMR1448	DUT Type:	Portable FM UHF FRS/GMRS PTT Radio Transceiver			
2006 Celltech Labs Inc.		This document is not to be reproduced in whole or in part without the prior written permission of Celltech Labs Inc.				Page 26 of 37

	<u>Date(s) of Evaluation</u> December 07, 2006	<u>Test Report Serial No.</u> 120706AMW-T795-S95U	<u>Report Revision No.</u> Revision 1.0	 Certificate No. 2470.01
	<u>Report Issue Date</u> December 14, 2006	<u>Description of Test(s)</u> Specific Absorption Rate	<u>RF Exposure Category</u> General Population	

APPENDIX C - MEASURED FLUID DIELECTRIC PARAMETERS

Company:	Uniden America Corporation	FCC ID:	AMWUT025	IC ID:	513C-UT025	
Model(s):	GMR1448	DUT Type:	Portable FM UHF FRS/GMRS PTT Radio Transceiver			
2006 Celltech Labs Inc.	This document is not to be reproduced in whole or in part without the prior written permission of Celltech Labs Inc.					Page 27 of 37

	<u>Date(s) of Evaluation</u> December 07, 2006	<u>Test Report Serial No.</u> 120706AMW-T795-S95U	<u>Report Revision No.</u> Revision 1.0	
	<u>Report Issue Date</u> December 14, 2006	<u>Description of Test(s)</u> Specific Absorption Rate	<u>RF Exposure Category</u> General Population	

450 MHz System Performance Check & DUT Evaluation (Brain)

Celltech Labs Inc.
 Test Result for UIM Dielectric Parameter
 Thu 07/Dec/2006
 Frequency (GHz)
 FCC_eHFCC OET 65 Supplement C (June 2001) Limits for Head Epsilon
 FCC_sHFCC OET 65 Supplement C (June 2001) Limits for Head Sigma
 Test_e Epsilon of UIM
 Test_s Sigma of UIM

Freq	FCC_eHFCC_sH	Test_e	Test_s
0.3500	44.70	0.87	47.00
0.3600	44.58	0.87	47.03
0.3700	44.46	0.87	46.57
0.3800	44.34	0.87	46.74
0.3900	44.22	0.87	46.22
0.4000	44.10	0.87	45.87
0.4100	43.98	0.87	45.56
0.4200	43.86	0.87	45.20
0.4300	43.74	0.87	45.11
0.4400	43.62	0.87	44.87
0.4500	43.50	0.87	44.67
0.4600	43.45	0.87	44.53
0.4700	43.40	0.87	44.30
0.4800	43.34	0.87	43.85
0.4900	43.29	0.87	43.89
0.5000	43.24	0.87	43.69
0.5100	43.19	0.87	43.31
0.5200	43.14	0.88	43.18
0.5300	43.08	0.88	43.13
0.5400	43.03	0.88	42.70
0.5500	42.98	0.88	42.54

Company:	Uniden America Corporation	FCC ID:	AMWUT025	IC ID:	513C-UT025	
Model(s):	GMR1448	DUT Type:	Portable FM UHF FRS/GMRS PTT Radio Transceiver			
2006 Celltech Labs Inc.		This document is not to be reproduced in whole or in part without the prior written permission of Celltech Labs Inc.				Page 28 of 37

	<u>Date(s) of Evaluation</u> December 07, 2006	<u>Test Report Serial No.</u> 120706AMW-T795-S95U	<u>Report Revision No.</u> Revision 1.0	 Certificate No. 2470.01
	<u>Report Issue Date</u> December 14, 2006	<u>Description of Test(s)</u> Specific Absorption Rate	<u>RF Exposure Category</u> General Population	

450 MHz DUT Evaluation (Body)

Celltech Labs Inc.
Test Result for UIM Dielectric Parameter
Thu 07/Dec/2006
Frequency (GHz)
FCC_eHFCC Bulletin 65 Supplement C (June 2001) Limits for Head Epsilon
FCC_sHFCC Bulletin 65 Supplement C (June 2001) Limits for Head Sigma
FCC_eB FCC Limits for Body Epsilon
FCC_sB FCC Limits for Body Sigma
Test_e Epsilon of UIM
Test_s Sigma of UIM

Freq	FCC_eB	FCC_sB	Test_e	Test_s
0.3500	57.70	0.93	58.74	0.86
0.3600	57.60	0.93	58.51	0.87
0.3700	57.50	0.93	58.45	0.88
0.3800	57.40	0.93	58.22	0.88
0.3900	57.30	0.93	57.91	0.89
0.4000	57.20	0.93	57.88	0.90
0.4100	57.10	0.93	57.54	0.91
0.4200	57.00	0.94	57.19	0.92
0.4300	56.90	0.94	57.25	0.92
0.4400	56.80	0.94	57.21	0.94
0.4500	56.70	0.94	56.88	0.94
0.4600	56.66	0.94	56.56	0.95
0.4700	56.62	0.94	56.63	0.96
0.4800	56.58	0.94	56.33	0.97
0.4900	56.54	0.94	56.36	0.98
0.5000	56.51	0.94	56.30	0.98
0.5100	56.47	0.94	55.99	0.99
0.5200	56.43	0.95	55.80	1.00
0.5300	56.39	0.95	55.69	1.01
0.5400	56.35	0.95	55.63	1.02
0.5500	56.31	0.95	55.51	1.02

Company:	Uniden America Corporation	FCC ID:	AMWUT025	IC ID:	513C-UT025	
Model(s):	GMR1448	DUT Type:	Portable FM UHF FRS/GMRS PTT Radio Transceiver			
2006 Celltech Labs Inc.		This document is not to be reproduced in whole or in part without the prior written permission of Celltech Labs Inc.				Page 29 of 37

	<u>Date(s) of Evaluation</u> December 07, 2006	<u>Test Report Serial No.</u> 120706AMW-T795-S95U	<u>Report Revision No.</u> Revision 1.0	
	<u>Report Issue Date</u> December 14, 2006	<u>Description of Test(s)</u> Specific Absorption Rate	<u>RF Exposure Category</u> General Population	

APPENDIX D - SAR TEST SETUP & DUT PHOTOGRAPHS

Company:	Uniden America Corporation	FCC ID:	AMWUT025	IC ID:	513C-UT025	
Model(s):	GMR1448	DUT Type:	Portable FM UHF FRS/GMRS PTT Radio Transceiver			
2006 Celltech Labs Inc.	This document is not to be reproduced in whole or in part without the prior written permission of Celltech Labs Inc.					Page 30 of 37

	<u>Date(s) of Evaluation</u> December 07, 2006	<u>Test Report Serial No.</u> 120706AMW-T795-S95U	<u>Report Revision No.</u> Revision 1.0	
	<u>Report Issue Date</u> December 14, 2006	<u>Description of Test(s)</u> Specific Absorption Rate	<u>RF Exposure Category</u> General Population	

FACE-HELD SAR TEST SETUP PHOTOGRAPHS
2.5 cm Spacing from Front of DUT to Planar Phantom

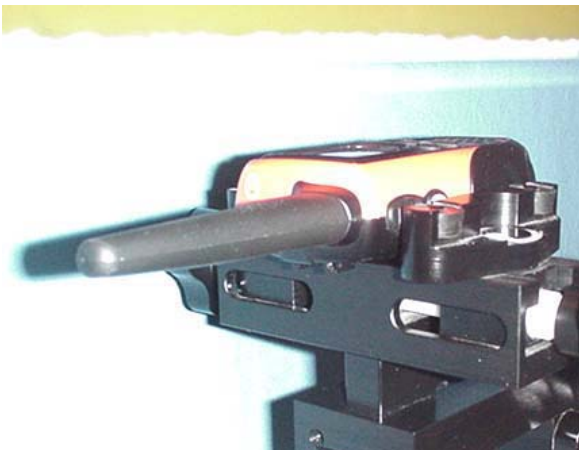
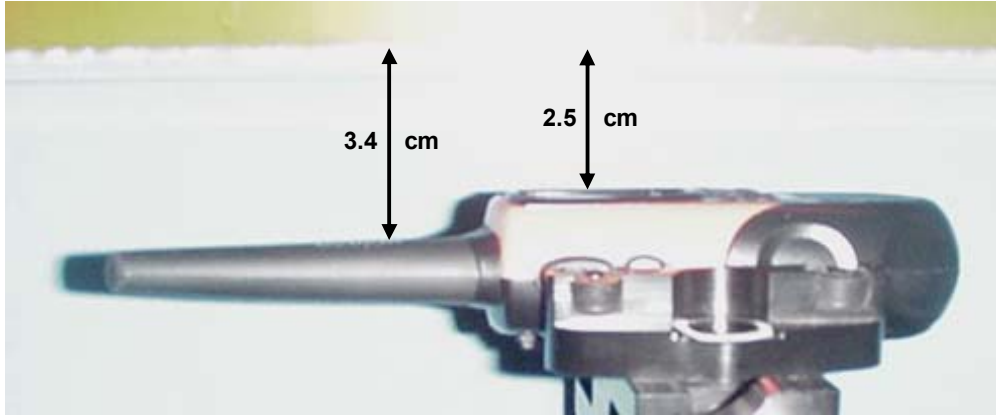

Company:	Uniden America Corporation	FCC ID:	AMWUT025	IC ID:	513C-UT025	
Model(s):	GMR1448	DUT Type:	Portable FM UHF FRS/GMRS PTT Radio Transceiver			
2006 Celltech Labs Inc.		This document is not to be reproduced in whole or in part without the prior written permission of Celltech Labs Inc.				Page 31 of 37

BODY-WORN SAR TEST SETUP PHOTOGRAPHS
0.7 cm Belt-Clip Spacing from Back of DUT to Planar Phantom with Headset (Ear-Loop & Boom-Microphone) Audio Accessory

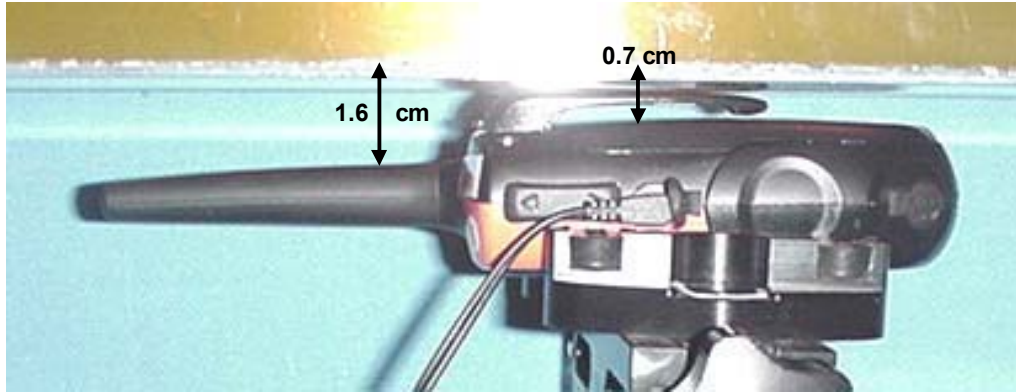

	<u>Date(s) of Evaluation</u> December 07, 2006	<u>Test Report Serial No.</u> 120706AMW-T795-S95U	<u>Report Revision No.</u> Revision 1.0	
	<u>Report Issue Date</u> December 14, 2006	<u>Description of Test(s)</u> Specific Absorption Rate	<u>RF Exposure Category</u> General Population	

DUT PHOTOGRAPHS



Front of DUT



Back of DUT



Back of DUT with Plastic Belt-Clip





Top end of DUT



Bottom end of DUT

Company:	Uniden America Corporation	FCC ID:	AMWUT025	IC ID:	513C-UT025	
Model(s):	GMR1448	DUT Type:	Portable FM UHF FRS/GMRS PTT Radio Transceiver			
2006 Celltech Labs Inc.		This document is not to be reproduced in whole or in part without the prior written permission of Celltech Labs Inc.				Page 33 of 37

	<u>Date(s) of Evaluation</u> December 07, 2006	<u>Test Report Serial No.</u> 120706AMW-T795-S95U	<u>Report Revision No.</u> Revision 1.0	
	<u>Report Issue Date</u> December 14, 2006	<u>Description of Test(s)</u> Specific Absorption Rate	<u>RF Exposure Category</u> General Population	

DUT PHOTOGRAPHS



Left Side of DUT with Plastic Belt-Clip



Right Side of DUT with Plastic Belt-Clip



DUT Battery Compartment





DUT with Alkaline AAA Batteries



DUT with NiMH Battery Pack

Company:	Uniden America Corporation	FCC ID:	AMWUT025	IC ID:	513C-UT025	
Model(s):	GMR1448	DUT Type:	Portable FM UHF FRS/GMRS PTT Radio Transceiver			
2006 Celltech Labs Inc.		This document is not to be reproduced in whole or in part without the prior written permission of Celltech Labs Inc.				Page 34 of 37



	<u>Date(s) of Evaluation</u> December 07, 2006	<u>Test Report Serial No.</u> 120706AMW-T795-S95U	<u>Report Revision No.</u> Revision 1.0	
	<u>Report Issue Date</u> December 14, 2006	<u>Description of Test(s)</u> Specific Absorption Rate	<u>RF Exposure Category</u> General Population	

DUT PHOTOGRAPHS





DUT with Headset (Ear-Loop & Boom-Microphone) Audio Accessory

Company:	Uniden America Corporation	FCC ID:	AMWUT025	IC ID:	513C-UT025	
Model(s):	GMR1448	DUT Type:	Portable FM UHF FRS/GMRS PTT Radio Transceiver			
2006 Celltech Labs Inc.	This document is not to be reproduced in whole or in part without the prior written permission of Celltech Labs Inc.					Page 35 of 37

	<u>Date(s) of Evaluation</u> December 07, 2006	<u>Test Report Serial No.</u> 120706AMW-T795-S95U	<u>Report Revision No.</u> Revision 1.0	 Certificate No. 2470.01
	<u>Report Issue Date</u> December 14, 2006	<u>Description of Test(s)</u> Specific Absorption Rate	<u>RF Exposure Category</u> General Population	

APPENDIX E - SYSTEM VALIDATION

Company:	Uniden America Corporation	FCC ID:	AMWUT025	IC ID:	513C-UT025	
Model(s):	GMR1448	DUT Type:	Portable FM UHF FRS/GMRS PTT Radio Transceiver			
2006 Celltech Labs Inc.	This document is not to be reproduced in whole or in part without the prior written permission of Celltech Labs Inc.					Page 36 of 37

	Date of Evaluation:	December 07, 2006	Document Issue No.:	SV450B-120706-R1.0	
	Evaluation Type:	System Validation	Validation Dipole:	450 MHz	Fluid Type:

450 MHz SYSTEM VALIDATION

Type:

450 MHz Validation Dipole

Asset Number:

00024

Serial Number:

136

Place of Validation:

Celltech Labs Inc.

Date of Validation:

December 07, 2006

Celltech Labs Inc. hereby certifies that the system validation was performed on the date indicated above.

Validated by:



Approved by:



1. Dipole Construction & Electrical Characteristics

The validation dipole was constructed in accordance with the IEEE Std “Recommended Practice for Determining the Spatial-Peak Specific Absorption Rate (SAR) in the Human Body Due to Wireless Communications Devices: Experimental Techniques”. The electrical properties were measured using an HP 8753ET Network Analyzer. The network analyzer was calibrated to the validation dipole N-type connector feed point using an HP85032E Type N calibration kit. The dipole was placed parallel to a planar phantom at a separation distance of 15.0mm from the simulating fluid using a loss-less dielectric spacer. The measured input impedance is:

Feed point impedance at 450MHz
 $\text{Re}\{Z\} = 56.170\Omega$
 $\text{Im}\{Z\} = 6.2559\Omega$

Return Loss at 450MHz
 -21.606dB

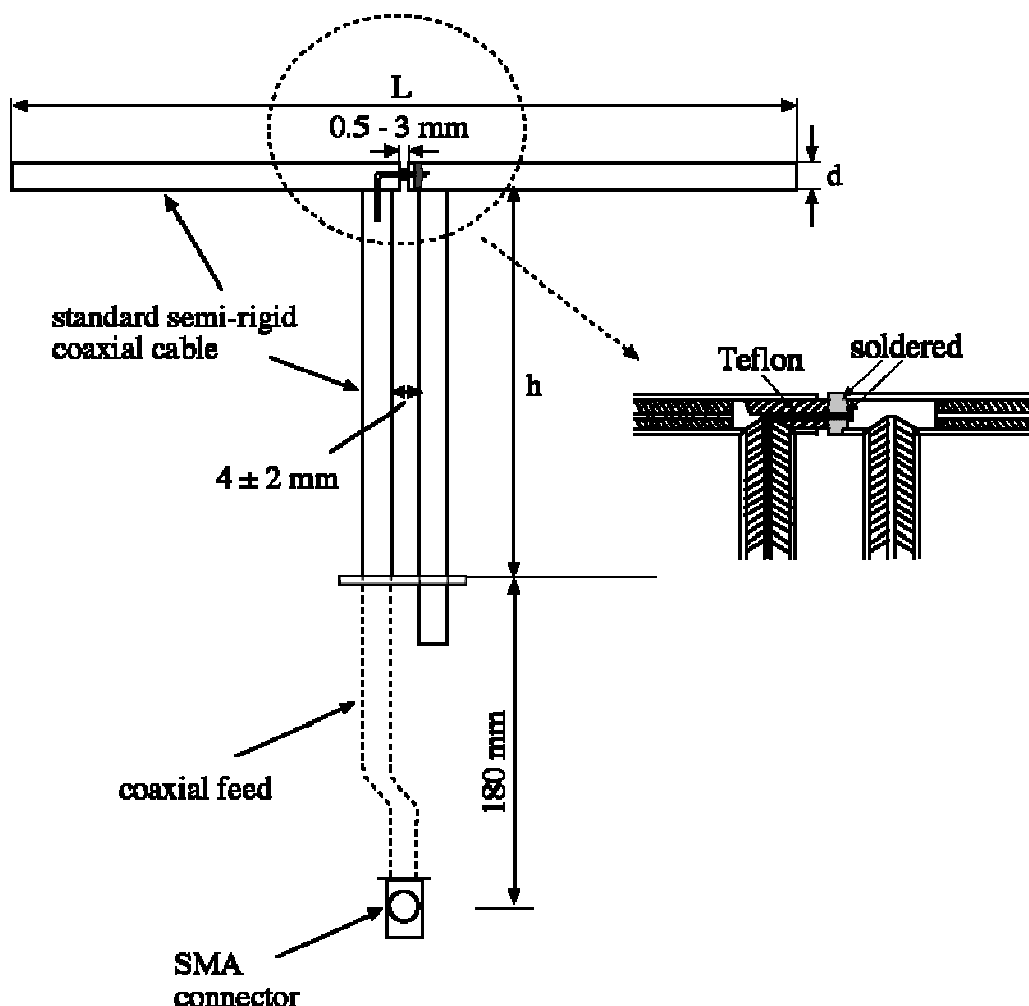

2. Validation Dipole VSWR Data

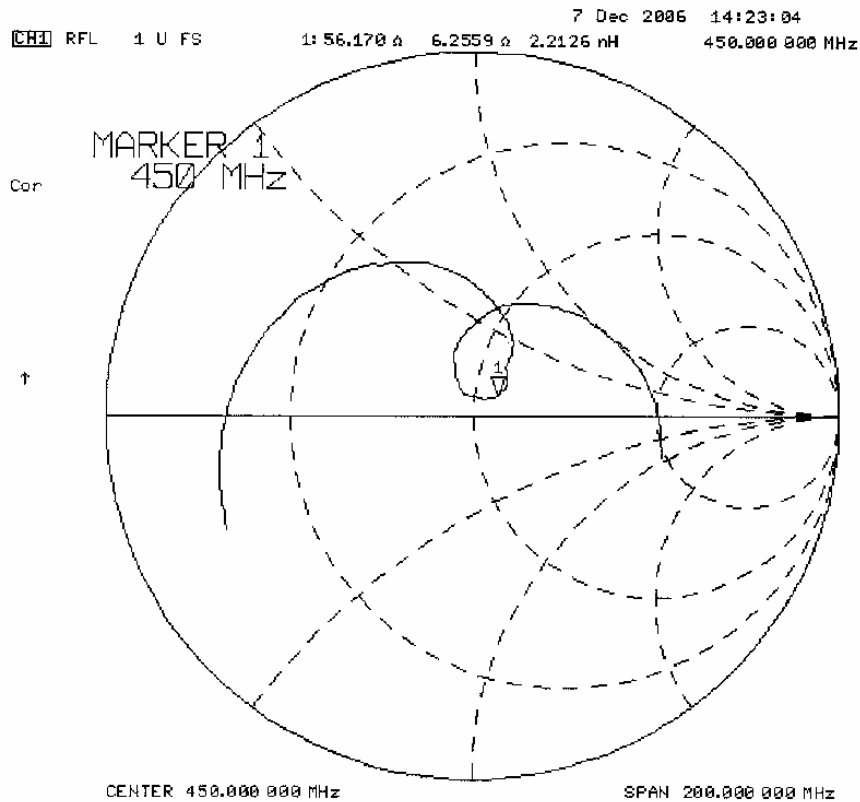
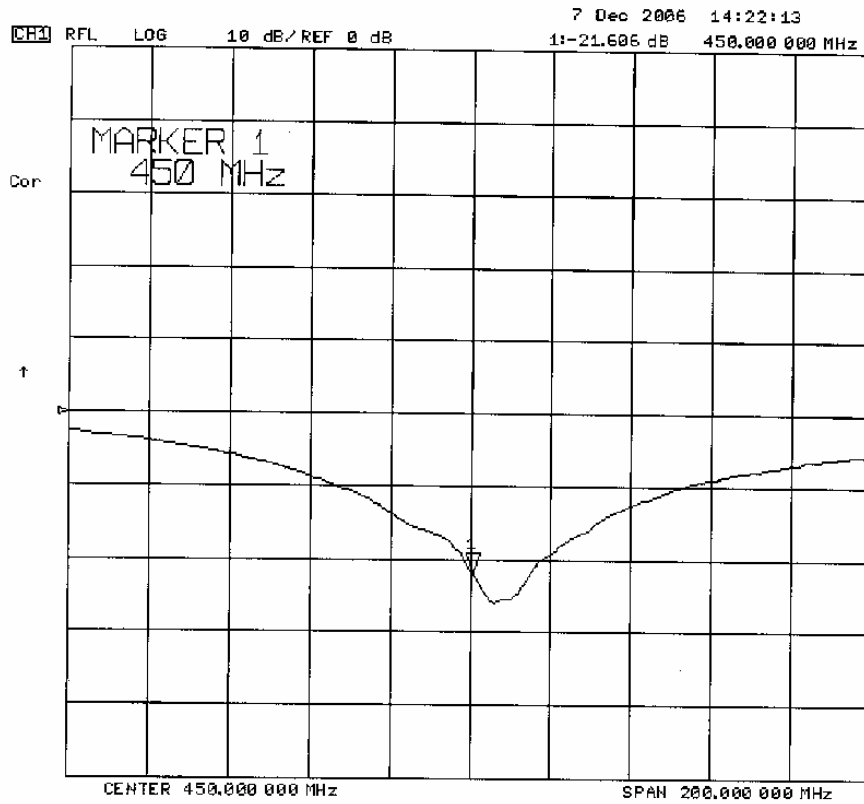

3. Validation Dipole Dimensions

Frequency (MHz)	L (mm)	h (mm)	d (mm)
300	420.0	250.0	6.2
450	288.0	167.0	6.2
835	161.0	89.8	3.6
900	149.0	83.3	3.6
1450	89.1	51.7	3.6
1800	72.0	41.7	3.6
1900	68.0	39.5	3.6
2000	64.5	37.5	3.6
2450	51.8	30.6	3.6
3000	41.5	25.0	3.6

4. Validation Phantom

The validation phantom was constructed using relatively low-loss tangent Plexiglas material.

The inner dimensions of the validation phantom are as follows:

Length: 83.5 cm
Width: 36.9 cm
Height: 21.8 cm

The bottom section of the validation phantom is constructed of 6.2 ± 0.1 mm Plexiglas.

5. Dimensions of Plexiglas Planar Phantom

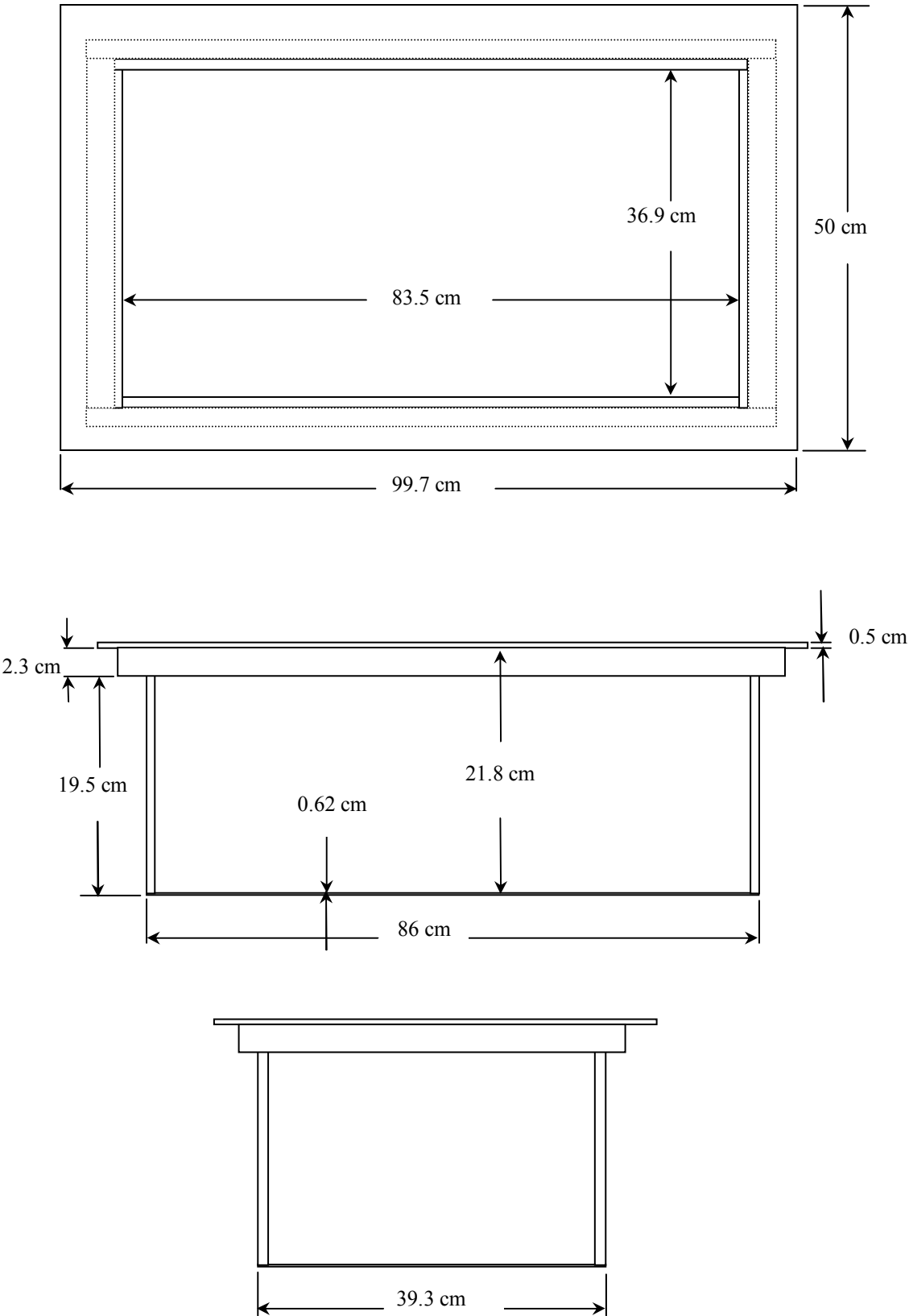

6. 450 MHz System Validation Setup



	Date of Evaluation:	December 07, 2006	Document Issue No.:	SV450B-120706-R1.0	
	Evaluation Type:	System Validation	Validation Dipole:	450 MHz	Fluid Type:

7. 450 MHz Validation Dipole Setup



8. SAR Measurement

The SAR measurement was performed with the E-field probe in mechanical detection mode only. The setup and determination of the forward power into the dipole was performed using the following procedures.

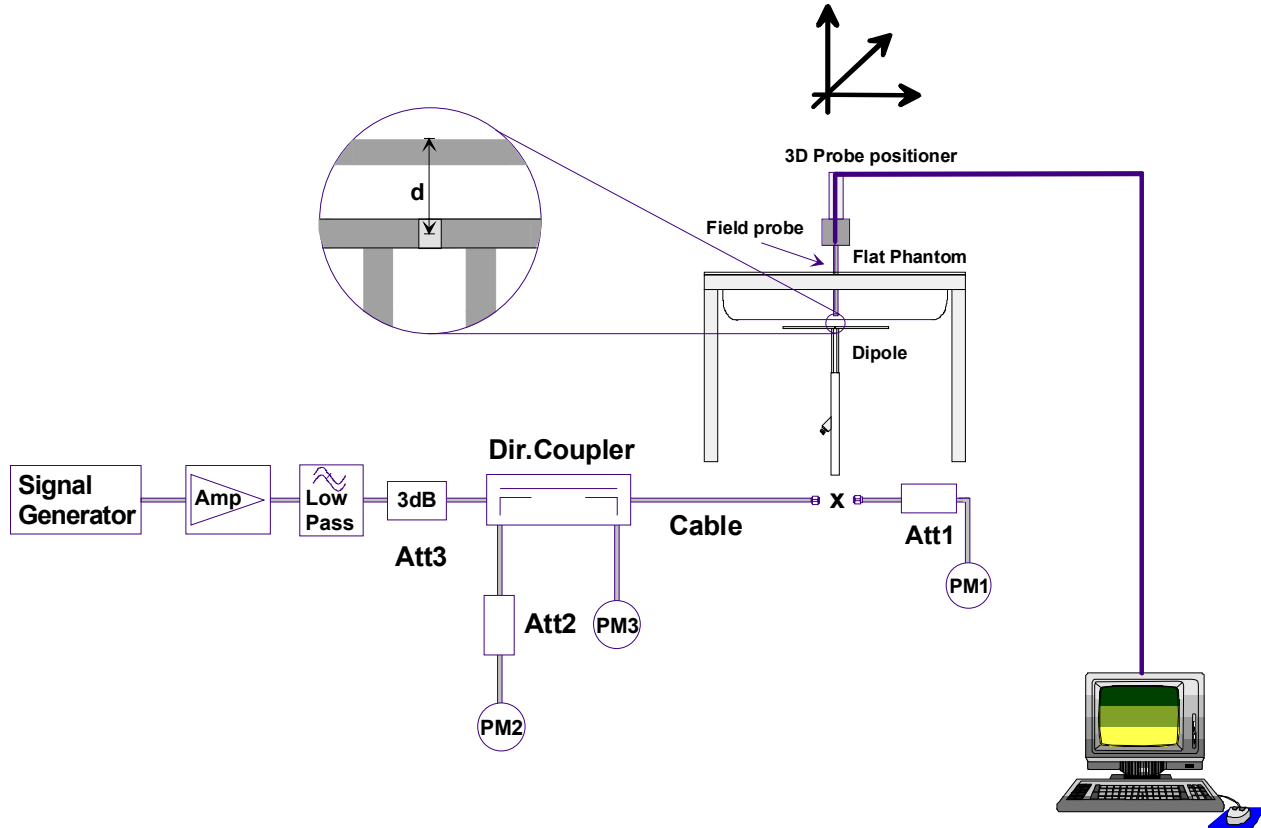

First the power meter PM1 (including attenuator Att1) is connected to the cable to measure the forward power at the location of the dipole connector (X). The signal generator is adjusted for the desired forward power at the dipole connector (taking into account the attenuation of Att1) as read by power meter PM2. After connecting the cable to the dipole, the signal generator is readjusted for the same reading at power meter PM2. If the signal generator does not allow adjustment in 0.01dB steps, the remaining difference at PM2 must be taken into consideration. PM3 records the reflected power from the dipole to ensure that the value is not changed from the previous value. The reflected power should be 20dB below the forward power.

9. Measurement Conditions

The planar phantom was filled with 450 MHz brain tissue simulant:

Relative Permittivity: 44.7 (+2.8% deviation from target)
 Conductivity: 0.90 mho/m (+3.4% deviation from target)
 Fluid Temperature: 23.3°C
 Fluid Depth: ≥ 15.0 cm

Environmental Conditions:

Ambient Temperature: 24.0°C
 Humidity: 33 %
 Barometric Pressure: 102.1kPa

The 450 MHz brain tissue simulant consisted of the following ingredients:

Ingredient	Percentage by weight
Water	38.56%
Sugar	56.32%
Salt	3.95%
HEC	0.98%
Dowicil 75	0.19%
450 MHz Target Dielectric Parameters at 22 °C	$\epsilon_r = 43.5$ (+/- 5%) $\sigma = 0.87$ S/m (+/- 5%)

10. 450 MHz System Validation SAR Test Results

SAR @ 0.25W Input averaged over 1g				SAR @ 1W Input averaged over 1g			
IEEE Target		Measured	Deviation	IEEE Target		Measured	Deviation
1.23	+/- 10%	1.27	+3.3%	4.90	+/- 10%	5.08	+3.7%
SAR @ 0.25W Input averaged over 10g				SAR @ 1W Input averaged over 10g			
IEEE Target		Measured	Deviation	IEEE Target		Measured	Deviation
0.825	+/- 10%	0.810	-1.8%	3.30	+/- 10%	3.24	-1.8%

The results have been normalized to 1W (forward power) into the dipole.

	Date of Evaluation:	December 07, 2006	Document Issue No.:	SV450B-120706-R1.0
	Evaluation Type:	System Validation	Validation Dipole:	450 MHz
			Fluid Type:	Brain

Date Tested: 12/07/2006

System Validation - 450 MHz Dipole - Brain Fluid

DUT: Dipole 450 MHz; Asset: 00024; Serial: 136; Validation: 12/07/2006

Ambient Temp: 24.0°C; Fluid Temp: 23.3°C; Barometric Pressure: 102.1 kPa; Humidity: 33%

Communication System: CW

Forward Conducted Power: 250 mW

Frequency: 450 MHz; Duty Cycle: 1:1

Medium: HSL450; Medium parameters used: $\sigma = 0.90$ mho/m; $\epsilon_r = 44.7$; $\rho = 1000$ kg/m³

- Probe: ET3DV6 - SN1387; ConvF(7.4, 7.4, 7.4); Calibrated: 16/03/2006
- Sensor-Surface: 4mm (Mechanical Surface Detection)
- Electronics: DAE4 Sn353; Calibrated: 21/06/2006
- Phantom: Validation Planar; Type: Plexiglas; Serial: 137
- Measurement SW: DASY4, V4.7 Build 44; Postprocessing SW: SEMCAD, V1.8 Build 171

450 MHz Dipole - System Validation/Area Scan (6x11x1):

Measurement grid: dx=15mm, dy=15mm

450 MHz Dipole - System Validation/Zoom Scan (5x5x7)/Cube 0:

Measurement grid: dx=7.5mm, dy=7.5mm, dz=5mm

Reference Value = 38.5 V/m; Power Drift = 0.014 dB

Peak SAR (extrapolated) = 2.24 W/kg

SAR(1 g) = 1.27 mW/g; SAR(10 g) = 0.810 mW/g

Maximum value of SAR (measured) = 1.34 mW/g

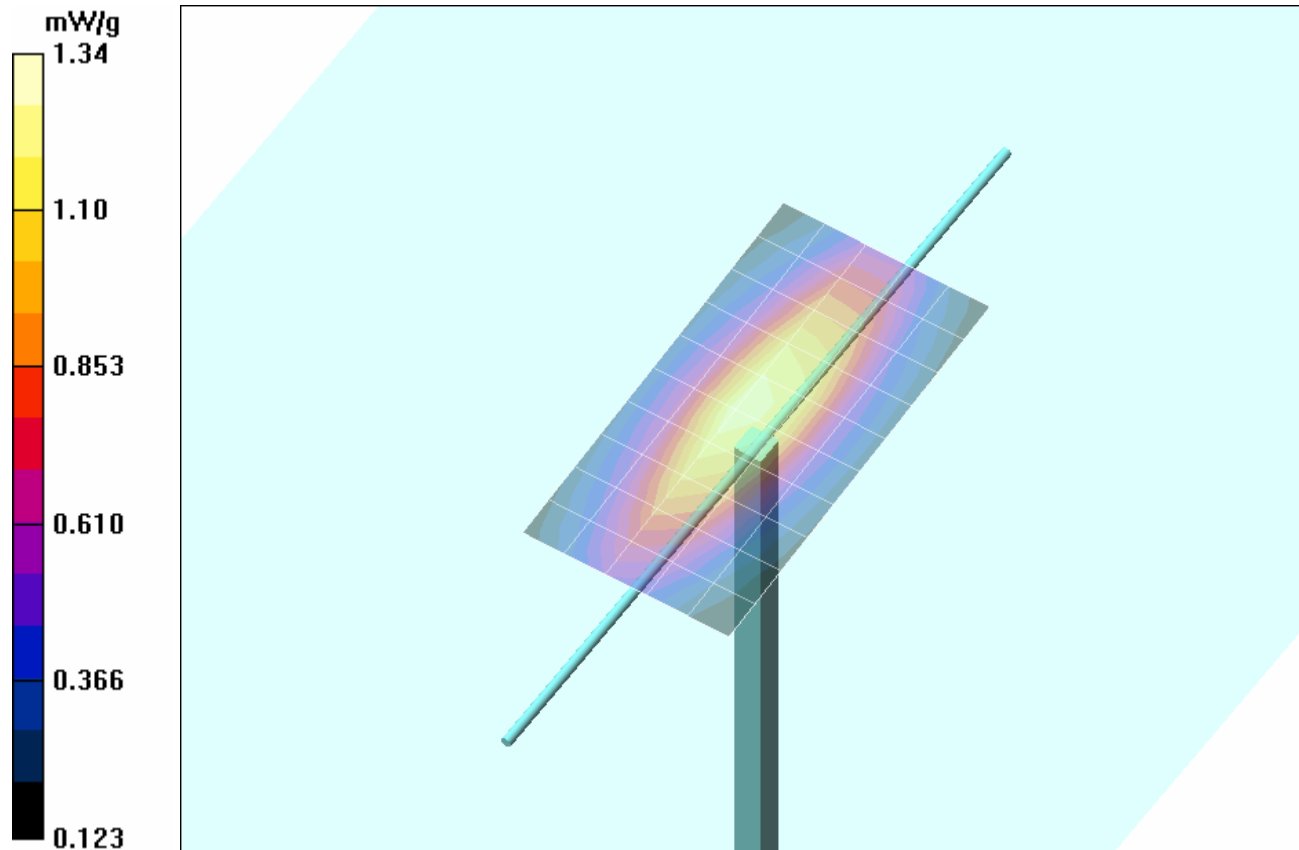

Z-Axis Scan

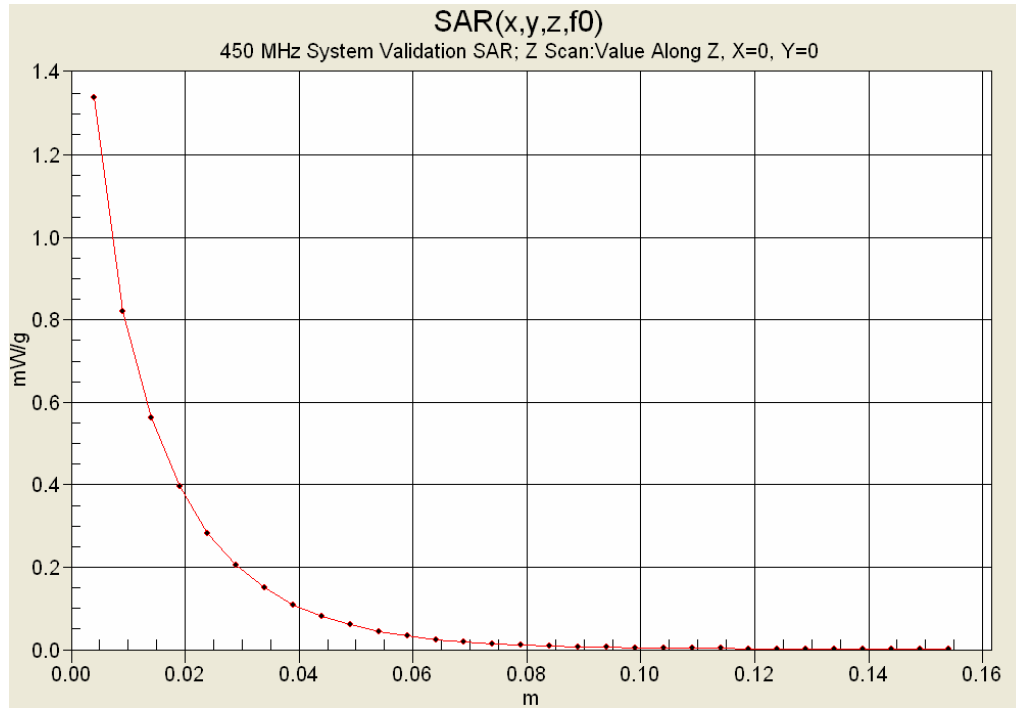

11. Measured Fluid Dielectric Parameters

System Validation (Brain) - 450 MHz Dipole

Celltech Labs Inc.

Test Result for UIM Dielectric Parameter

Thu 07/Dec/2006

Frequency (GHz)



FCC_eH FCC OET 65 Supplement C (June 2001) Limits for Head Epsilon

FCC_sH FCC OET 65 Supplement C (June 2001) Limits for Head Sigma

Test_e Epsilon of UIM

Test_s Sigma of UIM

Freq	FCC_eH	FCC_sH	Test_e	Test_s
0.3500	44.70	0.87	47.00	0.81
0.3600	44.58	0.87	47.03	0.82
0.3700	44.46	0.87	46.57	0.83
0.3800	44.34	0.87	46.74	0.84
0.3900	44.22	0.87	46.22	0.85
0.4000	44.10	0.87	45.87	0.86
0.4100	43.98	0.87	45.56	0.87
0.4200	43.86	0.87	45.20	0.88
0.4300	43.74	0.87	45.11	0.88
0.4400	43.62	0.87	44.87	0.89
0.4500	43.50	0.87	44.67	0.90
0.4600	43.45	0.87	44.53	0.91
0.4700	43.40	0.87	44.30	0.92
0.4800	43.34	0.87	43.85	0.92
0.4900	43.29	0.87	43.89	0.94
0.5000	43.24	0.87	43.69	0.94
0.5100	43.19	0.87	43.31	0.95
0.5200	43.14	0.88	43.18	0.96
0.5300	43.08	0.88	43.13	0.97
0.5400	43.03	0.88	42.70	0.98
0.5500	42.98	0.88	42.54	0.98

	<u>Date(s) of Evaluation</u> December 07, 2006	<u>Test Report Serial No.</u> 120706AMW-T795-S95U	<u>Report Revision No.</u> Revision 1.0	 Certificate No. 2470.01
	<u>Report Issue Date</u> December 14, 2006	<u>Description of Test(s)</u> Specific Absorption Rate	<u>RF Exposure Category</u> General Population	

APPENDIX F - PROBE CALIBRATION

Company:	Uniden America Corporation	FCC ID:	AMWUT025	IC ID:	513C-UT025	
Model(s):	GMR1448	DUT Type:	Portable FM UHF FRS/GMRS PTT Radio Transceiver			
2006 Celltech Labs Inc.	This document is not to be reproduced in whole or in part without the prior written permission of Celltech Labs Inc.					Page 37 of 37



Accredited by the Swiss Federal Office of Metrology and Accreditation
**The Swiss Accreditation Service is one of the signatories to the EA
Multilateral Agreement for the recognition of calibration certificates**

Accreditation No.: **SCS 108**

Client **Celltech Labs**

Certificate No: **ET3-1387_Mar06**

CALIBRATION CERTIFICATE

Object **ET3DV6 - SN:1387**

Calibration procedure(s) **QA CAL-01.v5
Calibration procedure for dosimetric E-field probes**

Calibration date: **March 16, 2006**

Condition of the calibrated item **In Tolerance**

This calibration certificate documents the traceability to national standards, which realize the physical units of measurements (SI).
The measurements and the uncertainties with confidence probability are given on the following pages and are part of the certificate.

All calibrations have been conducted in the closed laboratory facility: environment temperature (22 ± 3)°C and humidity < 70%.

Calibration Equipment used (M&TE critical for calibration)

Primary Standards	ID #	Cal Date (Calibrated by, Certificate No.)	Scheduled Calibration
Power meter E4419B	GB41293874	3-May-05 (METAS, No. 251-00466)	May-06
Power sensor E4412A	MY41495277	3-May-05 (METAS, No. 251-00466)	May-06
Power sensor E4412A	MY41498087	3-May-05 (METAS, No. 251-00466)	May-06
Reference 3 dB Attenuator	SN: S5054 (3c)	11-Aug-05 (METAS, No. 251-00499)	Aug-06
Reference 20 dB Attenuator	SN: S5086 (20b)	3-May-05 (METAS, No. 251-00467)	May-06
Reference 30 dB Attenuator	SN: S5129 (30b)	11-Aug-05 (METAS, No. 251-00500)	Aug-06
Reference Probe ES3DV2	SN: 3013	2-Jan-06 (SPEAG, No. ES3-3013_Jan06)	Jan-07
DAE4	SN: 654	2-Feb-06 (SPEAG, No. DAE4-654_Feb06)	Feb-07
Secondary Standards	ID #	Check Date (in house)	Scheduled Check
RF generator HP 8648C	US3642U01700	4-Aug-99 (SPEAG, in house check Nov-05)	In house check: Nov-07
Network Analyzer HP 8753E	US37390585	18-Oct-01 (SPEAG, in house check Nov-05)	In house check: Nov 06

Calibrated by: **Katja Pokovic** Function: **Technical Manager** Signature:

Approved by: **Niels Kuster** Quality Manager

Issued: March 16, 2006

This calibration certificate shall not be reproduced except in full without written approval of the laboratory.



Accredited by the Swiss Federal Office of Metrology and Accreditation
The Swiss Accreditation Service is one of the signatories to the EA
Multilateral Agreement for the recognition of calibration certificates

Accreditation No.: **SCS 108**

Glossary:

TSL	tissue simulating liquid
NORM _{x,y,z}	sensitivity in free space
ConF	sensitivity in TSL / NORM _{x,y,z}
DCP	diode compression point
Polarization φ	φ rotation around probe axis
Polarization ϑ	ϑ rotation around an axis that is in the plane normal to probe axis (at measurement center), i.e., $\vartheta = 0$ is normal to probe axis

Calibration is Performed According to the Following Standards:

- IEEE Std 1528-2003, "IEEE Recommended Practice for Determining the Peak Spatial-Averaged Specific Absorption Rate (SAR) in the Human Head from Wireless Communications Devices: Measurement Techniques", December 2003
- CENELEC EN 50361, "Basic standard for the measurement of Specific Absorption Rate related to human exposure to electromagnetic fields from mobile phones (300 MHz - 3 GHz), July 2001

Methods Applied and Interpretation of Parameters:

- NORM_{x,y,z}**: Assessed for E-field polarization $\vartheta = 0$ ($f \leq 900$ MHz in TEM-cell; $f > 1800$ MHz: R22 waveguide). NORM_{x,y,z} are only intermediate values, i.e., the uncertainties of NORM_{x,y,z} does not effect the E²-field uncertainty inside TSL (see below *ConvF*).
- NORM(f)_{x,y,z}** = NORM_{x,y,z} * *frequency_response* (see Frequency Response Chart). This linearization is implemented in DASY4 software versions later than 4.2. The uncertainty of the frequency response is included in the stated uncertainty of *ConvF*.
- DCP_{x,y,z}**: DCP are numerical linearization parameters assessed based on the data of power sweep (no uncertainty required). DCP does not depend on frequency nor media.
- ConvF and Boundary Effect Parameters**: Assessed in flat phantom using E-field (or Temperature Transfer Standard for $f \leq 800$ MHz) and inside waveguide using analytical field distributions based on power measurements for $f > 800$ MHz. The same setups are used for assessment of the parameters applied for boundary compensation (alpha, depth) of which typical uncertainty values are given. These parameters are used in DASY4 software to improve probe accuracy close to the boundary. The sensitivity in TSL corresponds to NORM_{x,y,z} * *ConvF* whereby the uncertainty corresponds to that given for *ConvF*. A frequency dependent *ConvF* is used in DASY version 4.4 and higher which allows extending the validity from ± 50 MHz to ± 100 MHz.
- Spherical isotropy (3D deviation from isotropy)**: in a field of low gradients realized using a flat phantom exposed by a patch antenna.
- Sensor Offset**: The sensor offset corresponds to the offset of virtual measurement center from the probe tip (on probe axis). No tolerance required.

Probe ET3DV6

SN:1387

Manufactured:	September 21, 1999
Last calibrated:	March 18, 2005
Recalibrated:	March 16, 2006

Calibrated for DASYS Systems

(Note: non-compatible with DASYS2 system!)

DASY - Parameters of Probe: ET3DV6 SN:1387**Sensitivity in Free Space^A****Diode Compression^B**

NormX	1.62 ± 10.1%	$\mu\text{V}/(\text{V}/\text{m})^2$	DCP X	92 mV
NormY	1.72 ± 10.1%	$\mu\text{V}/(\text{V}/\text{m})^2$	DCP Y	92 mV
NormZ	1.72 ± 10.1%	$\mu\text{V}/(\text{V}/\text{m})^2$	DCP Z	92 mV

Sensitivity in Tissue Simulating Liquid (Conversion Factors)

Please see Page 8.

Boundary Effect

TSL 900 MHz Typical SAR gradient: 5 % per mm

Sensor Center to Phantom Surface Distance		3.7 mm	4.7 mm
SAR _{be} [%]	Without Correction Algorithm	9.3	5.0
SAR _{be} [%]	With Correction Algorithm	0.1	0.2

Sensor Offset

Probe Tip to Sensor Center 2.7 mm

The reported uncertainty of measurement is stated as the standard uncertainty of measurement multiplied by the coverage factor k=2, which for a normal distribution corresponds to a coverage probability of approximately 95%.

^A The uncertainties of NormX,Y,Z do not affect the E²-field uncertainty inside TSL (see Page 8).

^B Numerical linearization parameter: uncertainty not required.

Frequency Response of E-Field

(TEM-Cell:ifi110 EXX, Waveguide: R22)

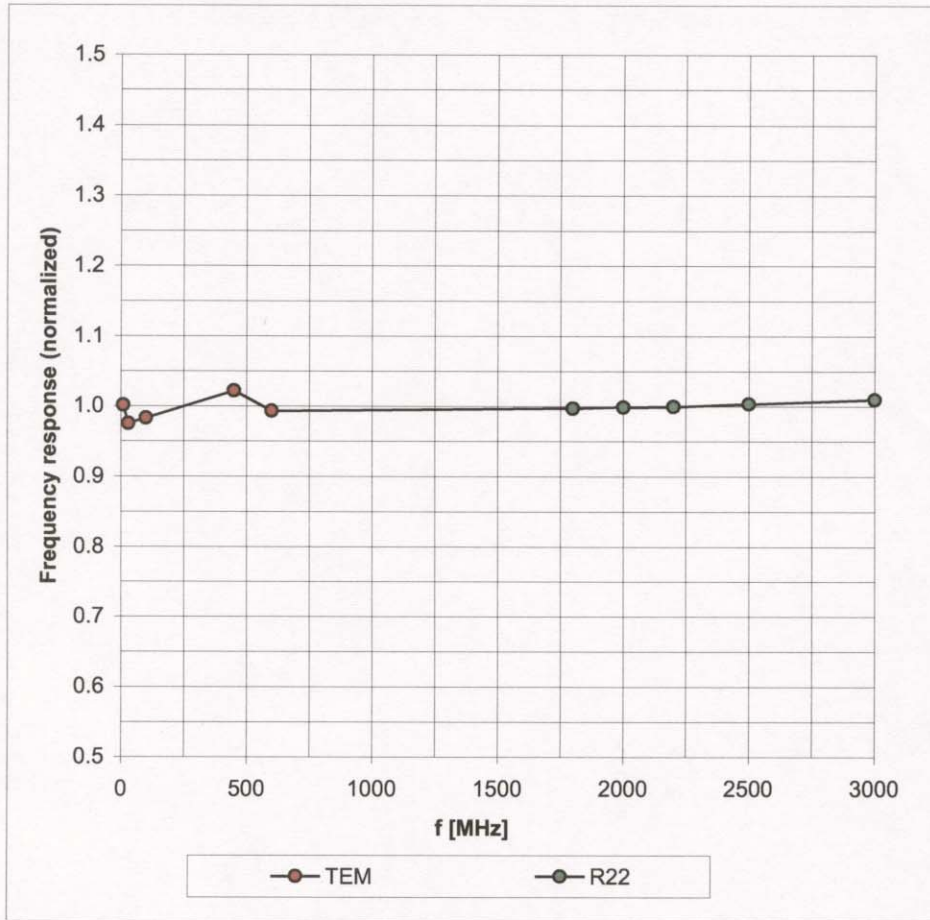

Uncertainty of Frequency Response of E-field: $\pm 6.3\%$ (k=2)

Receiving Pattern (ϕ), $\vartheta = 0^\circ$

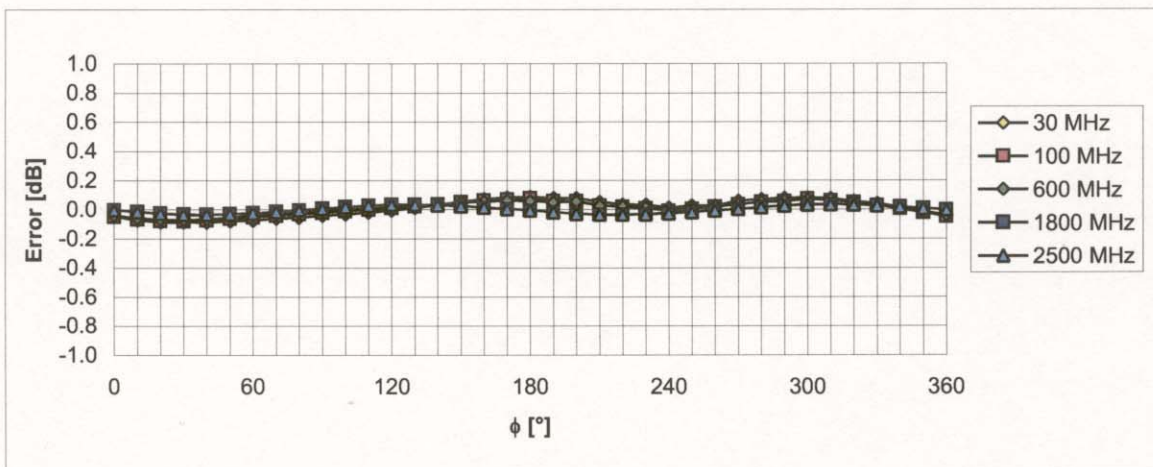
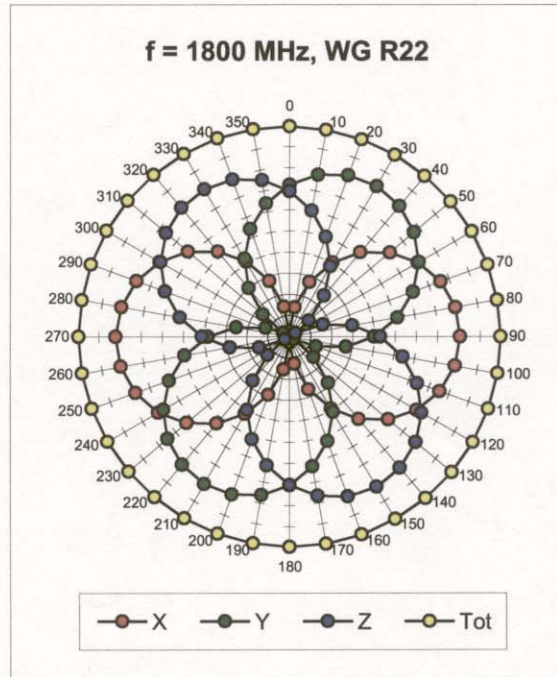
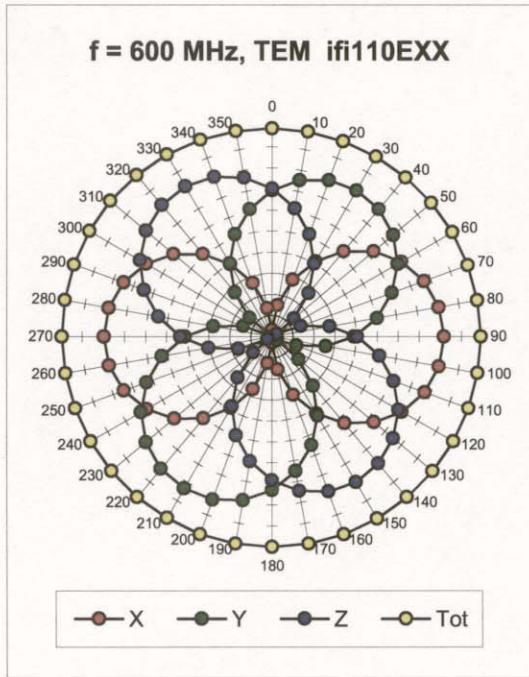

Uncertainty of Axial Isotropy Assessment: $\pm 0.5\%$ ($k=2$)

Dynamic Range f(SAR_{head}) (Waveguide R22, f = 1800 MHz)

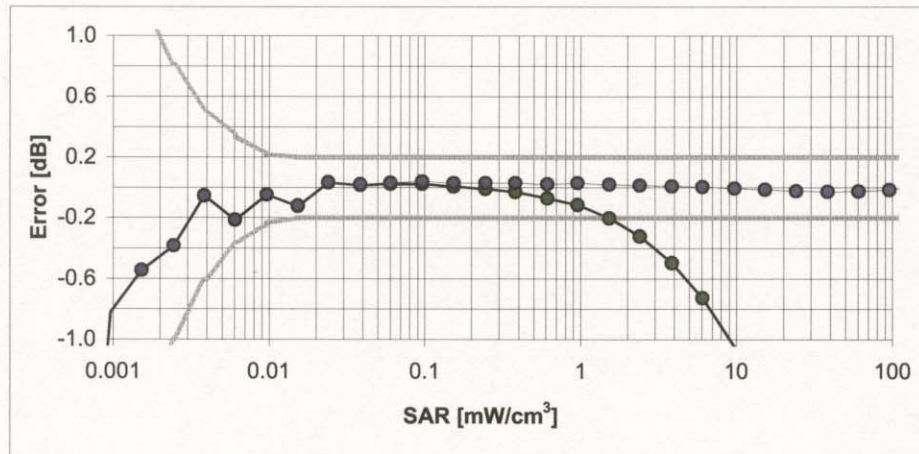
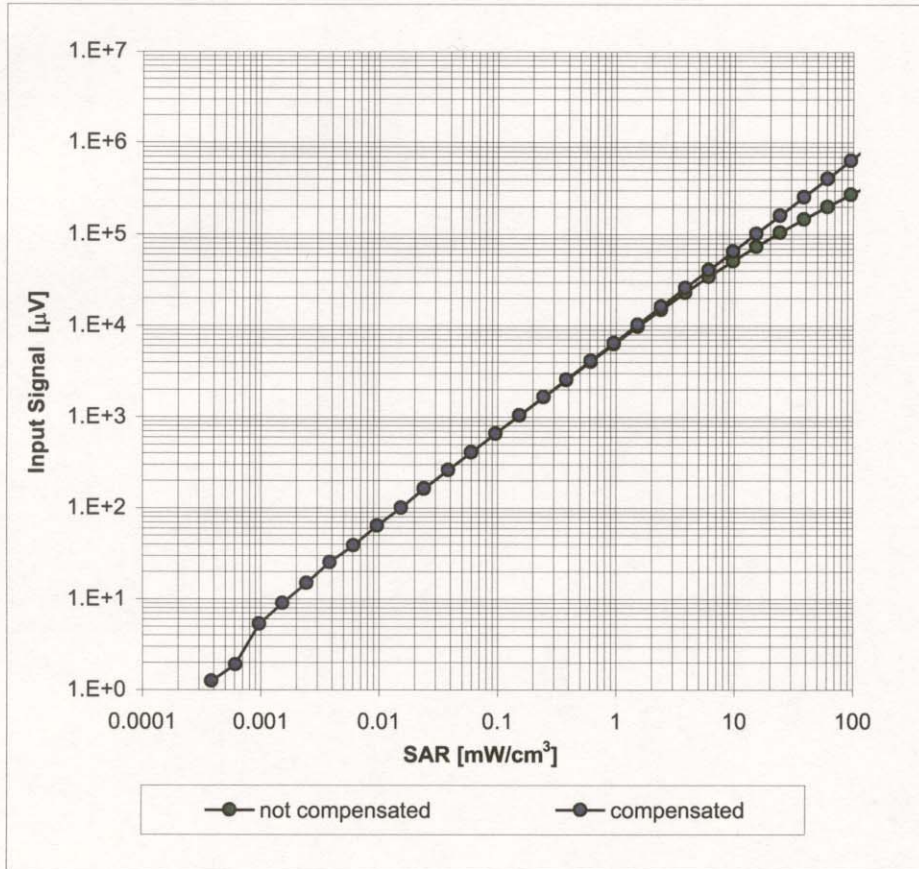

Uncertainty of Linearity Assessment: ± 0.6% (k=2)

Conversion Factor Assessment

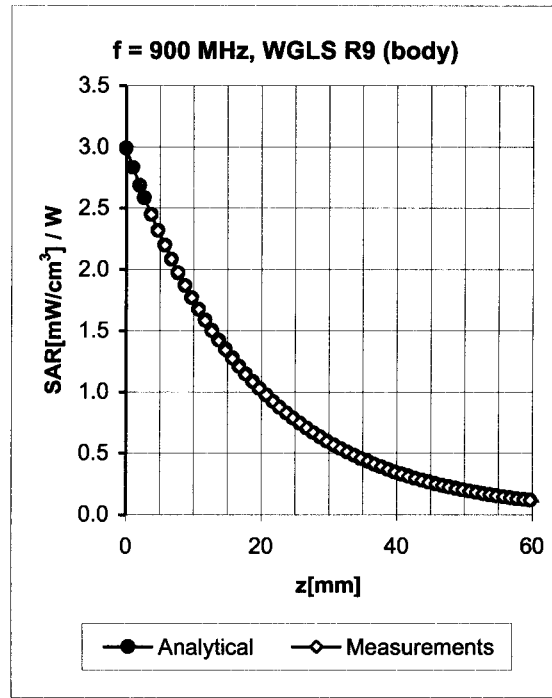
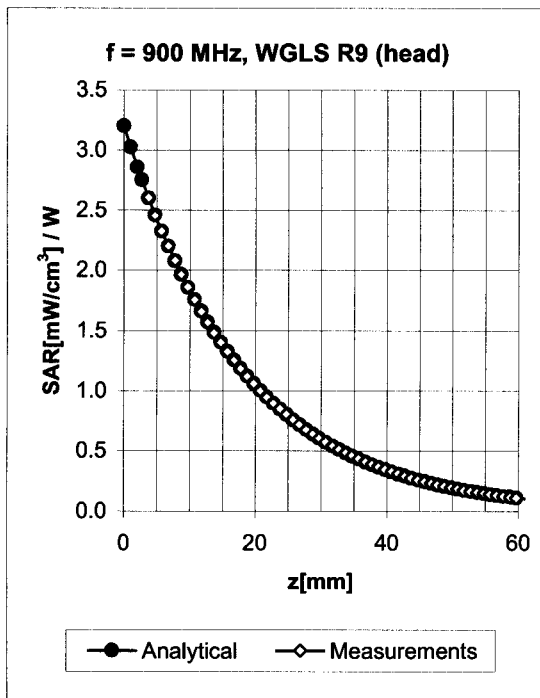

f [MHz]	Validity [MHz] ^c	TSL	Permittivity	Conductivity	Alpha	Depth	ConvF Uncertainty
900	± 50 / ± 100	Head	41.5 ± 5%	0.97 ± 5%	0.62	1.86	6.35 ± 11.0% (k=2)
900	± 50 / ± 100	Body	55.0 ± 5%	1.05 ± 5%	0.59	1.97	6.04 ± 11.0% (k=2)

^c The validity of ± 100 MHz only applies for DASY v4.4 and higher (see Page 2). The uncertainty is the RSS of the ConvF uncertainty at calibration frequency and the uncertainty for the indicated frequency band.

Deviation from Isotropy in HSL

Error (ϕ, ϑ), $f = 900$ MHz

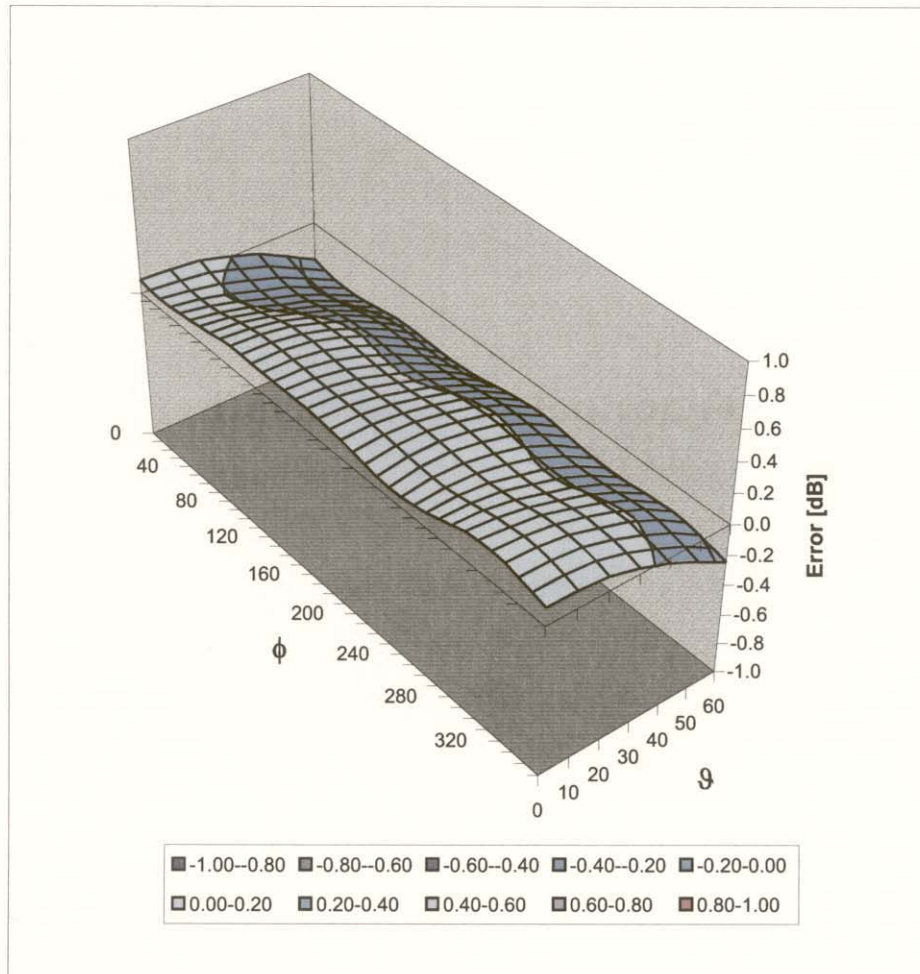

Uncertainty of Spherical Isotropy Assessment: $\pm 2.6\%$ ($k=2$)

Additional Conversion Factors for Dosimetric E-Field Probe

Type:

ET3DV6

Serial Number:

1387

Place of Assessment:

Zurich

Date of Assessment:

March 18, 2006

Probe Calibration Date:

March 16, 2006

Schmid & Partner Engineering AG hereby certifies that conversion factor(s) of this probe have been evaluated on the date indicated above. The assessment was performed using the FDTD numerical code SEMCAD of Schmid & Partner Engineering AG. Since the evaluation is coupled with measured conversion factors, it has to be recalculated yearly, i.e., following the re-calibration schedule of the probe. The uncertainty of the numerical assessment is based on the extrapolation from measured value at 900 MHz or at 1800 MHz.

Assessed by:

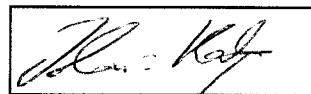

Dosimetric E-Field Probe ET3DV6 SN:1387

Conversion factor (\pm standard deviation)

150 \pm 50 MHz	ConvF	8.6 \pm 10%	$\epsilon_r = 52.3 \pm 5\%$ $\sigma = 0.76 \pm 5\%$ mho/m (head tissue)
150 \pm 50 MHz	ConvF	8.2 \pm 10%	$\epsilon_r = 61.9 \pm 5\%$ $\sigma = 0.80 \pm 5\%$ mho/m (body tissue)
300 \pm 50 MHz	ConvF	7.8 \pm 9%	$\epsilon_r = 45.3 \pm 5\%$ $\sigma = 0.87 \pm 5\%$ mho/m (head tissue)
450 \pm 50 MHz	ConvF	7.4 \pm 8%	$\epsilon_r = 43.5 \pm 5\%$ $\sigma = 0.87 \pm 5\%$ mho/m (head tissue)
450 \pm 50 MHz	ConvF	7.3 \pm 8%	$\epsilon_r = 56.7 \pm 5\%$ $\sigma = 0.94 \pm 5\%$ mho/m (body tissue)
750 \pm 50 MHz	ConvF	6.6 \pm 7%	$\epsilon_r = 41.8 \pm 5\%$ $\sigma = 0.89 \pm 5\%$ mho/m (head tissue)
750 \pm 50 MHz	ConvF	6.4 \pm 7%	$\epsilon_r = 55.4 \pm 5\%$ $\sigma = 0.96 \pm 5\%$ mho/m (body tissue)
1925 \pm 50 MHz	ConvF	5.0 \pm 7%	$\epsilon_r = 39.8 \pm 5\%$ $\sigma = 1.48 \pm 5\%$ mho/m (head tissue)
1925 \pm 50 MHz	ConvF	4.7 \pm 7%	$\epsilon_r = 53.2 \pm 5\%$ $\sigma = 1.60 \pm 5\%$ mho/m (body tissue)

Important Note:

For numerically assessed probe conversion factors, parameters Alpha and Delta in the DASY software must have the following entries: Alpha = 0 and Delta = 1.
 Please see also Section 4.7 of the DASY4 Manual.