

Probe ET3DV5

SN:1370

Manufactured:	February 1999
Calibrated:	February 2000

Calibrated for System DASY3

Introduction

The performance of all probes is measured before delivery. This includes an assessment of the characteristic parameters, receiving patterns as a function of frequency, frequency response and relative accuracy. Furthermore, each probe is tested in use according to a dosimetric assessment protocol. The sensitivity parameters (NormX, NormY, NormZ), the diode compression parameter (DCP) and the conversion factor (ConvF) of the probe and some of the measurement diagrams are given in the following.

The performance of the individual probes varies slightly due to tolerances arising from the manufacturing process. Since the lines are highly resistive (several MOhms), the offset and noise problem is greatly increased if signals in the low μV range are measured. Accurate measurement below $10 \mu\text{W/g}$ are possible if the following precautions are taken. 1) check the current grounding with the *multimeter*¹, i.e., low noise levels, 2) compensate the current *offset*¹, 3) use long integration time (approx. 10 seconds), 4) *calibrate*¹ before each measurement, 5) persons should avoid moving around the lab while measuring.

Since the field distortion caused by the supporting material and the sheath is quite high in the θ direction, the receiving pattern is poor in air. However, the distortion in tissue equivalent material is much less because of its high dielectricity. In addition, the fields induced in the phantoms by dipole structures close to the body are dominantly parallel to the surface. Thus, the error due to non-isotropy is much better than 1 dB for dosimetric assessments.

The probes are calibrated in the TEM cell if 110 although the field distribution in the cell is not very uniform and the frequency response is not very flat. To ensure consistency, a strict protocol is followed. The conversion factor (ConF) between this calibration and the measurement in the tissue simulation solution is performed by comparison with temperature measurements and computer simulations. This conversion factor is only valid for the specified tissue simulating liquids at the specified frequencies. If measurements have to be performed in solutions with other electrical properties or at other frequencies, the conversion factor has to be assessed by the same procedure.

As the probes have been constructed with printed resistive lines on ceramic substrates (thick film technique), the probe is very delicate with respect to mechanical shocks.

Attention:

Do not drop the probe or let the probe collide with any solid object. Never let the robot move without first activating the emergency stop feature (i.e., without first turning the data acquisition electronics on).

¹ Feature of the DASY Software Tool.

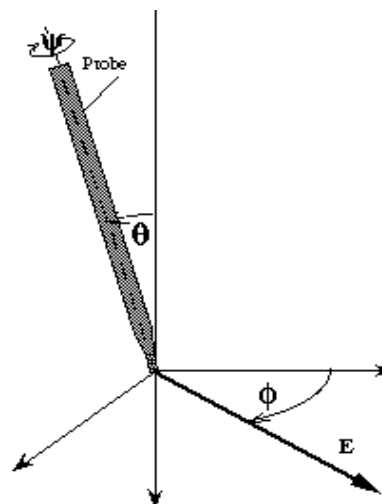

Fig 1: Due to the field distortion caused by the supporting material, the probe has two characteristic directions, referred to as angle ψ and θ .

DASY3 - Parameters of Probe: ET3DV5 SN:1370

Sensitivity in Free Space

NormX	1.58	$\mu\text{V}/(\text{V}/\text{m})^2$
NormY	1.64	$\mu\text{V}/(\text{V}/\text{m})^2$
NormZ	1.80	$\mu\text{V}/(\text{V}/\text{m})^2$

Diode Compression

DCP X	96	mV
DCP Y	96	mV
DCP Z	96	mV

Sensitivity in Tissue Simulating Liquid

450 MHz	ConvF X	6.5	extrapolated	$\epsilon_r = 48 \pm 5\%$ $\sigma = 0.50 \pm 10\% \text{ mho/m}$ (brain tissue simulating liquid)
	ConvF Y	6.5	extrapolated	
	ConvF Z	6.5	extrapolated	
900 MHz	ConvF X	6.0	$\pm 10\%$	$\epsilon_r = 42.5 \pm 5\%$ $\sigma = 0.86 \pm 10\% \text{ mho/m}$ (brain tissue simulating liquid)
	ConvF Y	6.0	$\pm 10\%$	
	ConvF Z	6.0	$\pm 10\%$	
1500 MHz	ConvF X	5.4	interpolated	$\epsilon_r = 41 \pm 5\%$ $\sigma = 1.32 \pm 10\% \text{ mho/m}$ (brain tissue simulating liquid)
	ConvF Y	5.4	interpolated	
	ConvF Z	5.4	interpolated	
1800 MHz	ConvF X	5.1	$\pm 10\%$	$\epsilon_r = 41 \pm 5\%$ $\sigma = 1.69 \pm 10\% \text{ mho/m}$ (brain tissue simulating liquid)
	ConvF Y	5.1	$\pm 10\%$	
	ConvF Z	5.1	$\pm 10\%$	

Sensor Offset

Probe Tip to Sensor Center	2.7	mm
Surface to Probe Tip	1.6 ± 0.2	mm

Receiving Pattern (ϕ), $\theta = 0^\circ$

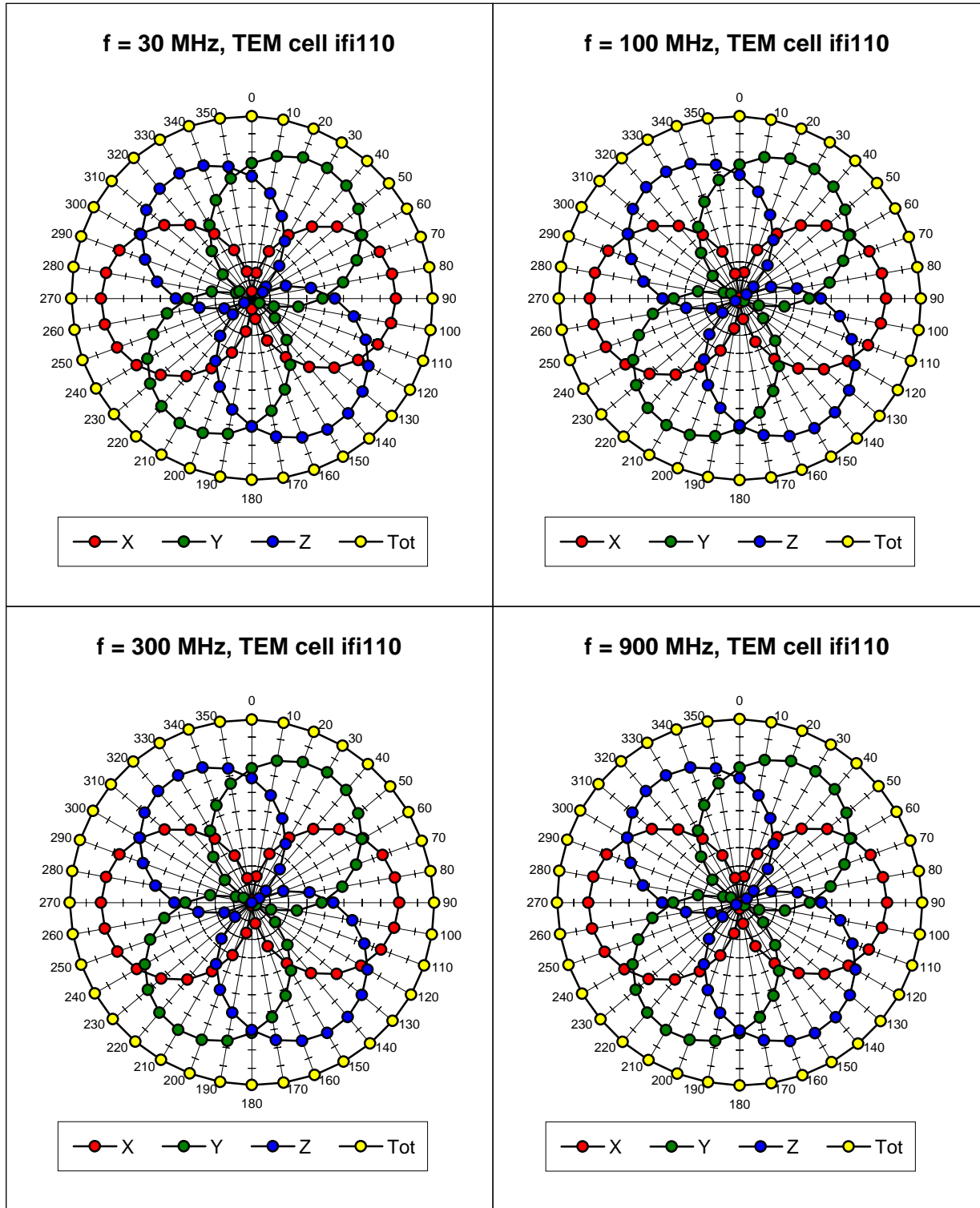

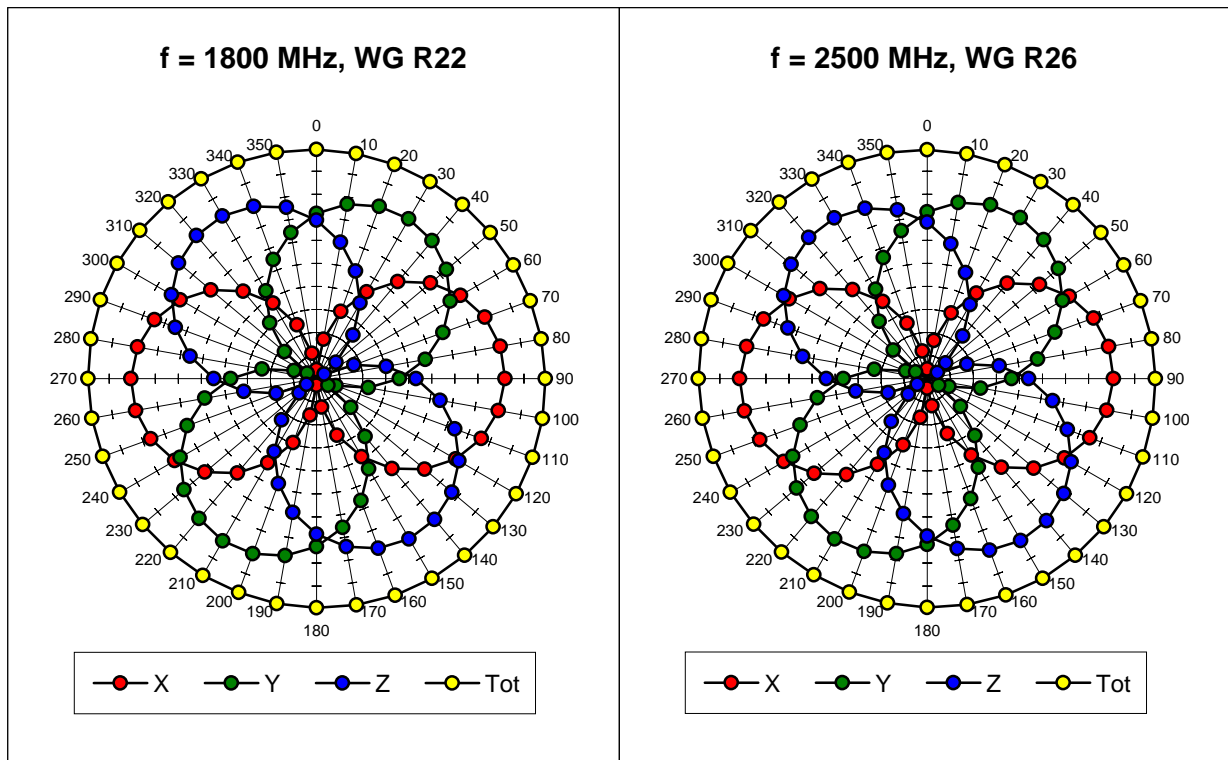

Isotropy Error (ϕ), $\theta = 0^\circ$

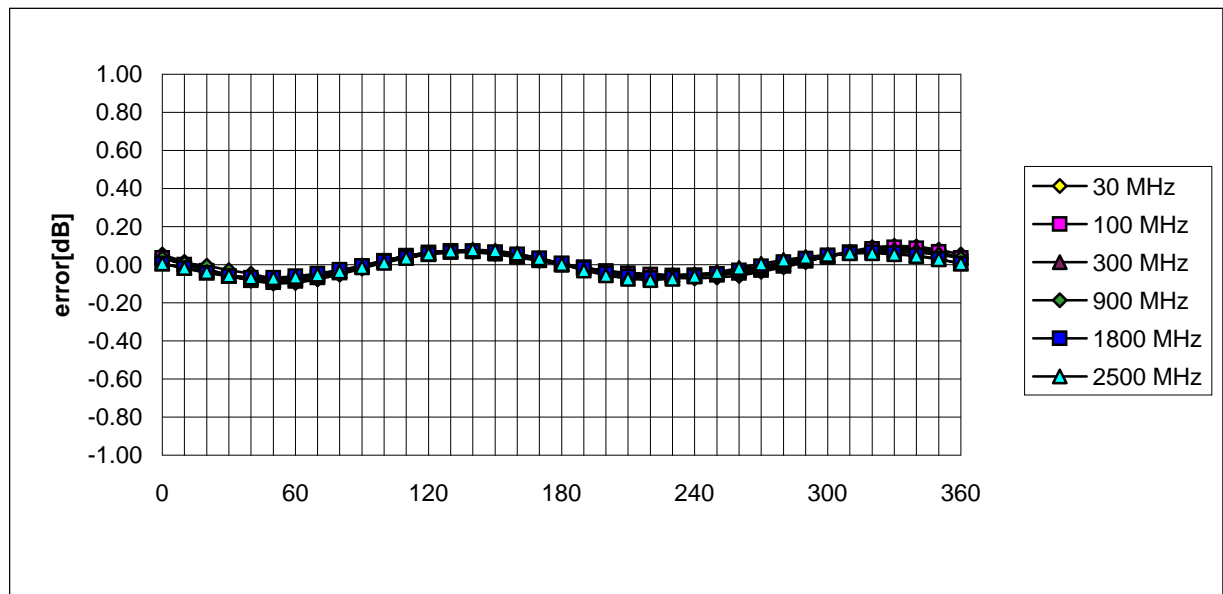

Frequency Response of E-Field

(TEM-Cell:ifi110, Waveguide R22, R26)

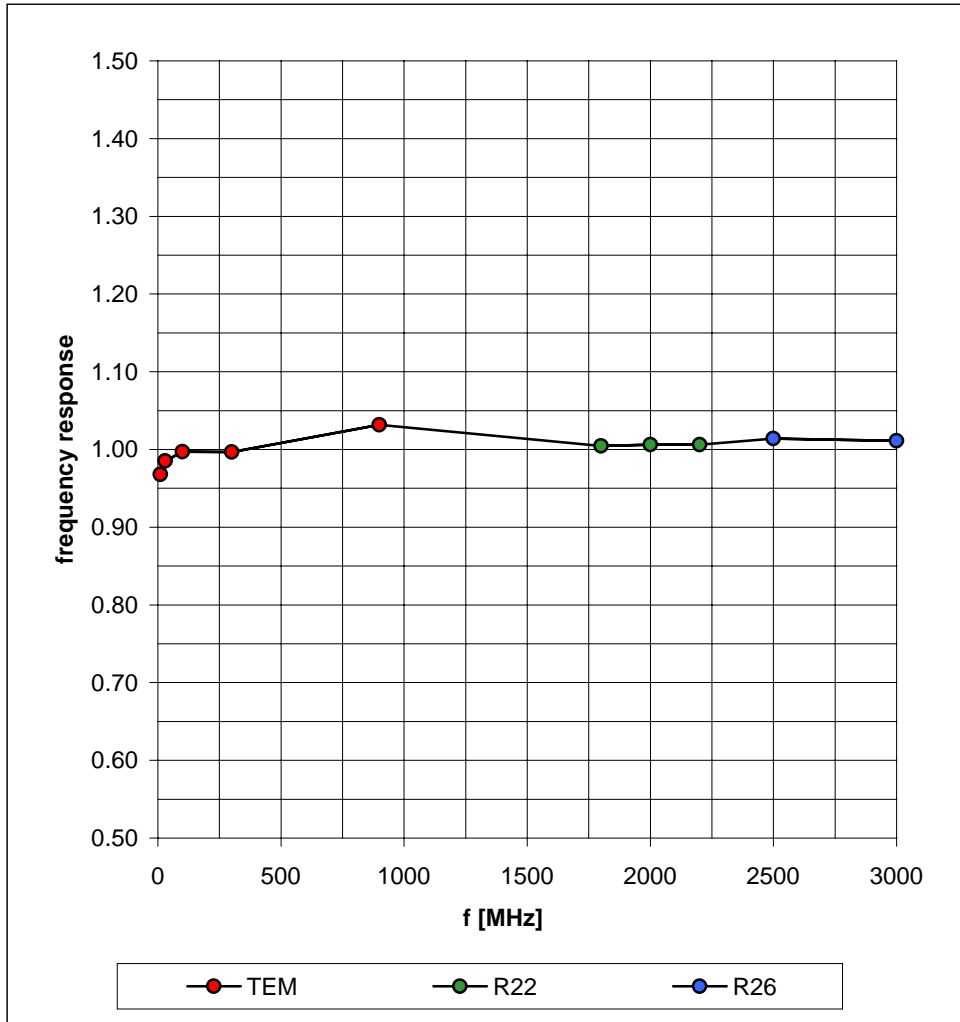

Dynamic Range f(SAR_{brain})

(TEM-Cell:ifi1110)

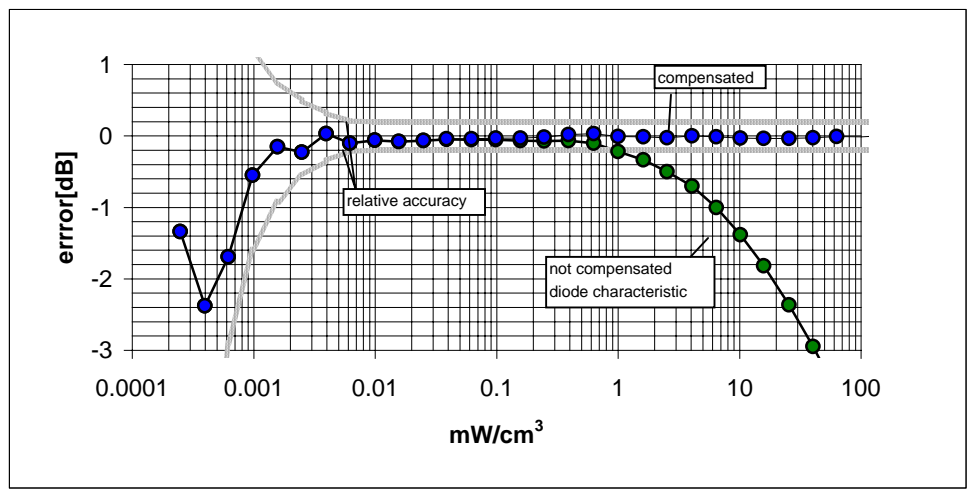
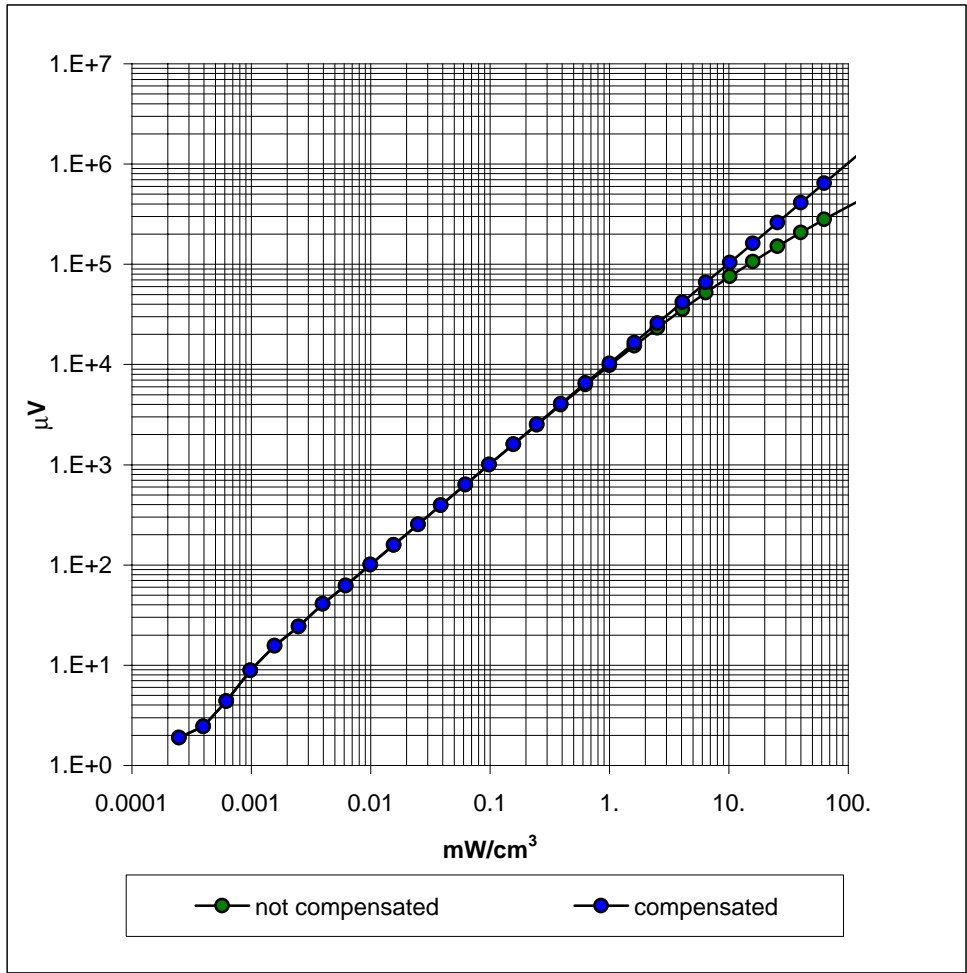

Conversion Factor Assessment

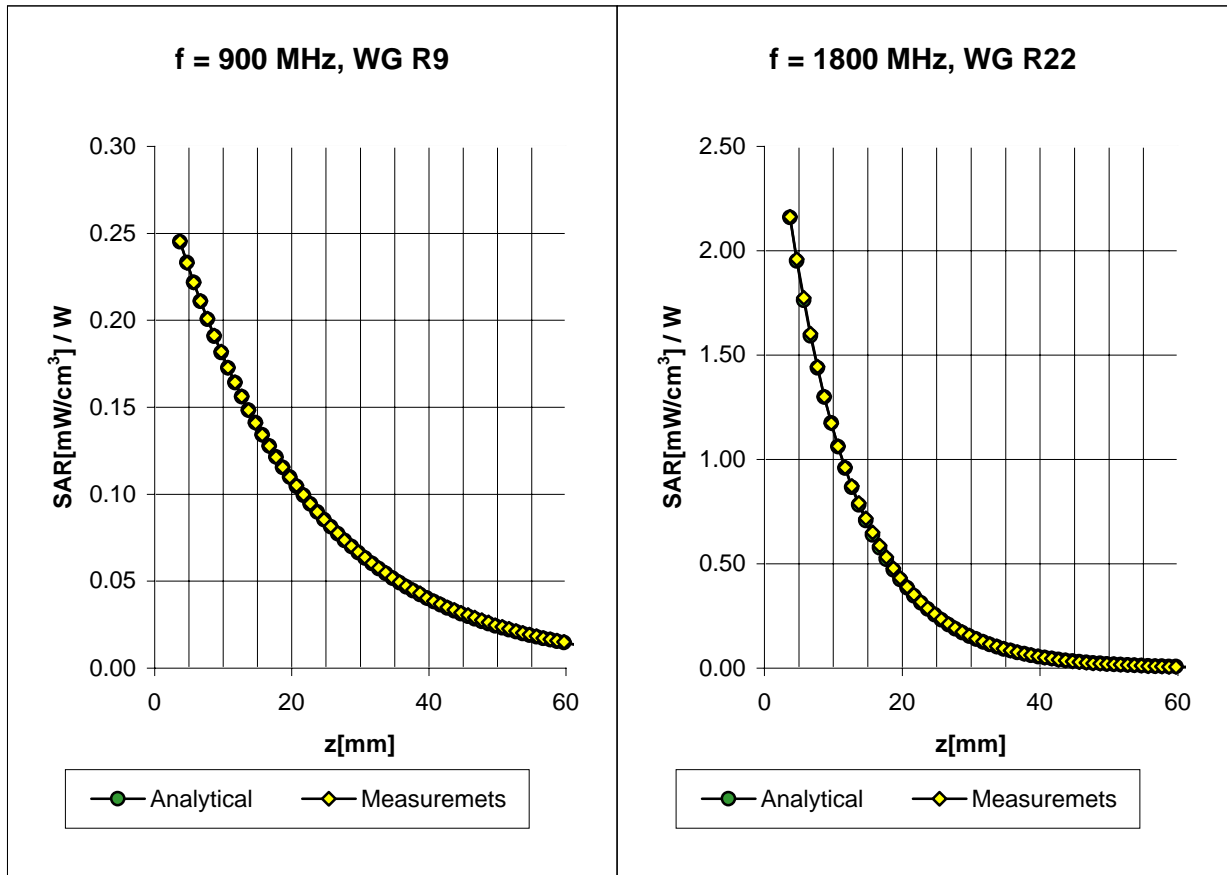

Receiving Pattern (ϕ) (in brain tissue, z = 5 mm)

