

EXI 5160

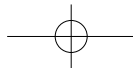

5.8
GIGAHERTZ
WITH EXTENDED RANGE

This product combines 5.8 GHz and 900 MHz
which enhances security and clarity.

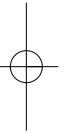
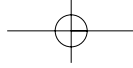

Step 1 Checking the Package Contents

Make sure you have received the following items in the package. If any of these items are missing or damaged, contact the Uniden Parts Department.

- Base unit
- Handset
- AC adapter
- Rechargeable battery
- Telephone cord
- Beltclip
- This owner's manual
- Other printed material

Uniden Parts Department at
(800) 554-3988
Hours: M-F 8:00 a.m. to
5:00 p.m. CST.
We can also be reached on
the web at www.uniden.com

Step 2 Install and Charge the Handset Battery

TO INSTALL THE HANDSET BATTERY

- A** Remove the cover.
- B** Connect the battery pack connector with the correct polarity.
- C** Replace the cover.



www.uniden.com

- D** Plug the AC adapter cord into the base unit and then into a 120V AC outlet.

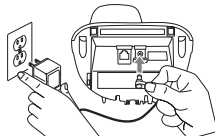

- E** Place the handset in the base and charge continuously for 15 - 20 hours before using the phone.

Step 3 Connect to Phone Line

When the handset battery pack is fully charged, after 15-20 hours of charging, plug the telephone cord into the base unit and then into a telephone wall jack.

Your phone is set for tone dialing. If your local network requires pulse dialing, please see "Choosing the dialing mode" on page 16.

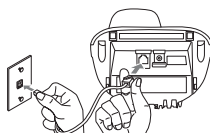

Step 4 Setting Display Options



Note: Three Caller ID options are available: AutoTalk, Caller ID on Call Waiting (CIDCW), and Area Code.

TO SET CALLER ID, LANGUAGE AND DIALING OPTIONS

- A** Press and hold *call id/menu*.
- B** Press *vol/▲/△* or *vol/▲/▽* to move the pointer to an option.
- C** Press *select* to change the option setting.
- D** Press *end* to exit, and return the handset to the base.

OPTIONS INCLUDE

- A** Auto Talk On/Off
- B** CIDCW On/Off (Caller ID on call waiting)
- C** Area Code Enter/Remove
- D** Dial Pulse/Tone
- E** Language English/French/Spanish

Contents

Quick Reference Guide	3	Erasing a Stored Name and Phone Number	30
Welcome/Features	5	RocketDial	
Controls and Functions	6	RocketDial	31
Getting Started		Storing and Editing the RocketDial	31
Setting up the Phone	8	Making Calls with the RocketDial	31
Mounting the Base Unit on a Wall	13	Deleting the RocketDial	32
Setting Menu Options	15	Caller ID Features	
Basics		Caller ID	33
Making and Receiving Calls	18	When the Telephone Rings	33
Adjusting the Handset Ringer and Earpiece Volume	19	Viewing the Caller ID Message List	34
Redial	20	Deleting Information from the Caller ID List	35
Tone Dialing Switch-over	20	Using the Caller ID List	37
Traveling Out-of-Range	20	Additional Information	
Selecting a Different Channel	21	Changing the Digital Security Code	39
Page	21	Installing the Beltclip	39
Flash and Call Waiting	21	Headset Installation	39
Voice Mail Waiting Indicator	22	Note on Power Sources	40
Memory Dialing		Maintenance	40
Storing Phone Numbers and Names	23	Troubleshooting	41
Steps for Entering Names and Special Characters	25	General Information	44
Making Calls with Memory Dialing	26	Precautions & Warranty	45
Chain Dialing	27	I.C. Notice	47
Editing a Stored Name and/or Phone Number	28	Index	48

Welcome

Congratulations on your purchase of the Uniden cordless phone. This cordless phone is designed and engineered to exacting standards for reliability, long life, and outstanding performance.

Note: Some illustrations in this manual may differ from the actual unit for explanation purposes. The color of your cordless telephone may vary.



As an ENERGY STAR® Partner, Uniden has determined that this product or product models meets the ENERGY STAR® guidelines for energy efficiency. ENERGY STAR® is a U.S. registered mark.

Features

- 5.8 GHz Extended Range Technology
- 3 Line Backlit Display
- Caller ID and Call Waiting Caller ID
- RocketDial
- 10 Number Memory Dialing
- 32 Digit Redial
- Flash and Pause
- English, French or Spanish Display Option
- Tone/Pulse Dialing
- Page/Find handset
- Earpiece Volume Control
- Ringer Volume Control (High-Low-Off)
- Hearing Aid Compatible
- 20 Channel Autoscan

Be sure to visit our web site: www.uniden.com

Uniden® and RocketDial® are registered trademarks of Uniden America Corporation. AutoTalk, AutoStandby, UltraClear Plus, Random Code and AutoSecure are trademarks of Uniden America Corporation.

Controls and Functions

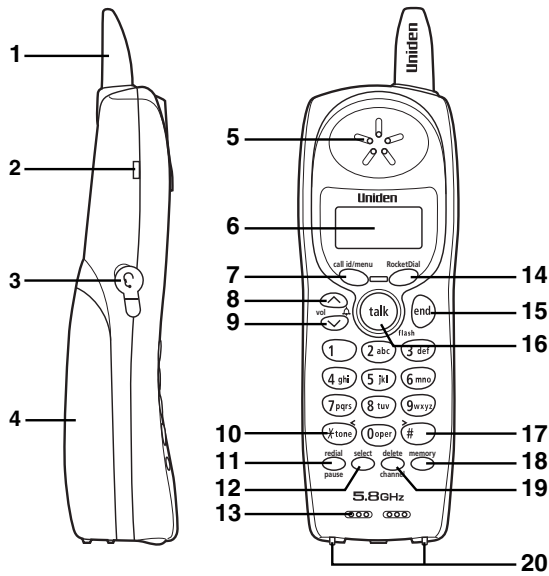

1. Handset antenna
2. Beltclip hole
3. Optional headset jack
4. Handset battery compartment
5. Handset earpiece
6. LCD display
7. call id (Caller ID)/menu key
8. vol (volume) / Δ / \wedge (up) key
9. vol (volume) / Δ / ∇ (down) key
10. * /tone / \leftarrow (left cursor) key
11. redial/pause key
12. select key
13. Handset microphone and ringer speaker
14. RocketDial key
15. end key
16. talk/flash key
17. # / \rightarrow (right cursor) key
18. memory key
19. delete/channel key
20. Handset charging contacts

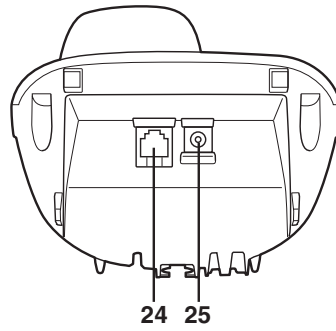
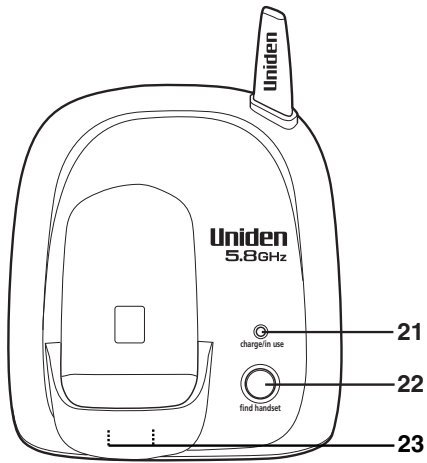

- 21. charge/in use LED
- 22. find handset key
- 23. Base charging contacts
- 24. Telephone line jack
- 25. DC IN 9V jack



If your home has specially wired alarm equipment connected to the telephone line, be sure that installing the system does not disable your alarm equipment.

If you have questions about what will disable your alarm equipment, contact your telephone company or a qualified installer.

Setting up the Phone

Do the following steps:

- A. Choose the best location
- B. Install the rechargeable battery pack into the handset
- C. Connect the base unit

A. Choose the best location

Before choosing a location for your new phone, read the INSTALLATION CONSIDERATIONS included in the PRECAUTIONS. Here are some important guidelines you should consider:

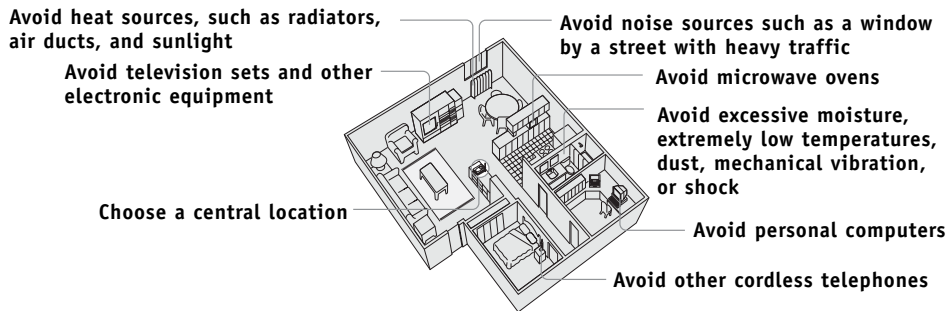

- The location should be close to both a phone jack and a continuous power outlet which is not switchable.
- Keep the base and handset away from sources of electrical noise such as motors, microwave ovens, and fluorescent lighting.
- The base can be placed on a desk, tabletop, or mounted on a standard wall plate.

B. Install the rechargeable battery pack into the handset

The handset is powered by a rechargeable battery pack. The battery recharges automatically when the handset is placed in the base unit.

Charge the handset battery pack for at least 15-20 hours before using your new cordless telephone for the first time! To maximize the charge capacity of your battery pack, DO NOT plug the telephone cord into the base unit and wall jack until the battery is fully charged.

- 1) Press down on the handset battery case cover (use the finger indentation for a better grip) and slide the cover downward to remove.
- 2) Plug the battery pack connector (red & black wires) into the small, black jack inside the battery compartment. (The connector notches fit into the grooves of the jack only one-way.) Match the wire colors to the polarity label in the battery compartment, connect the battery and listen for a click to insure connection.
- 3) Make sure you have a good connection by slightly pulling on the battery wires. If the connection is secure, the battery jack will remain in place.

www.uniden.com

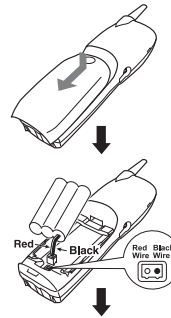

- Use only the Uniden BT-800 rechargeable battery pack supplied with your cordless telephone.
- You can also use Uniden BT-905 battery, but its usage time is less than BT-800.

GETTING STARTED [9]

GETTING STARTED



- Replacement batteries are also available through the Uniden Parts Department at (800) 554-3988, Monday through Friday from 8:00 a.m. to 5:00 p.m. or online at www.uniden.com
- The handset should always sit in charging cradle face forward to make good contact with base unit's charge contacts.

- 4) Place the battery case cover back on the handset by sliding it upwards until it clicks into place.
- 5) Place the handset in the base unit face forward for 15-20 hours without interruption. The base unit's LED light (labeled **charge/in use**) illuminates once the handset is placed in the base. The LED light will illuminate regardless if the battery pack is connected or not.

DO NOT rely on the LED light as an indicator that the battery pack is connected and the handset is charging!

If the base **charge/in use** LED light does not illuminate:

- Check to see if the AC adapter is plugged into the base unit and the electrical wall outlet properly. (Use only the supplied AC adapter. Do not use any other AC adapter.)
- Check to see if the handset is sitting correctly in the base and making good contact with the base unit's charging contacts.

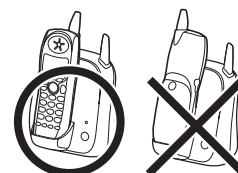
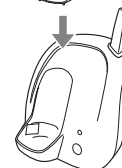
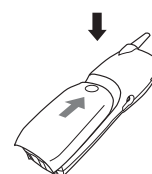

Low battery alert

When the battery pack is very low and needs to be charged, the phone is programmed to eliminate functions in order to save power. If the phone is not in use, "Low Battery" appears on the LCD and none of the keys will operate. If the phone is in use, "Low Battery" flashes and the handset beeps. Complete your conversation as quickly as possible and return the handset to the base unit for charging.



The last number dialed in the redial memory, the names and the numbers stored in the memory locations or CID list are retained for up to 30 minutes while you replace the battery pack.

Cleaning the charging contacts

To maintain a good charge, it is important to clean the charging contacts on both the handset and base unit once a month. Using water only, dampen a cloth to clean the charging contacts. Then make sure to go back over the charging contacts with a dry cloth before returning the handset to the base to charge.

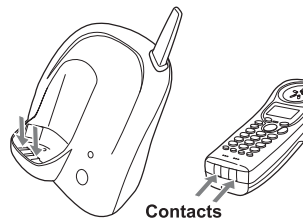

Do not use paint thinner, benzene, alcohol, or other chemical products. Doing so may discolor the surface of the telephone and damage the finish.



- Even when the battery pack is not being used, it will gradually discharge over a long period of time. For optimum performance, be sure to return the handset to the base unit after a telephone call.
- **Talk Mode** - The handset is off the base and *talk/flash* has been pressed, enabling a dial tone.
- **Standby Mode** - The handset is not in use, off the base and *talk/flash* has not been pressed. A dial tone is not present.



Use only the supplied AD-314 AC adapter. Do not use any other AC adapter.



Place the power cord so that it does not create a trip hazard or where it could become chafed and create a fire or electrical hazard.

C. Connect the base unit

- 1) Connect the AC adapter to the **DC IN 9V** jack and to a standard 120V AC wall outlet.
- 2) Set the base on a desk or tabletop, and place the handset on the base unit.
- 3) Make sure that the **charge/in use** LED illuminates.

If the LED does not illuminate, check to see that the AC adapter is plugged in and that the handset makes good contact with the base charging contacts.



- Connect the AC adapter to a continuous power supply.
- Place the base unit close to the AC outlet so that you can unplug the AC adapter easily.

- After installing the battery pack in the handset, charge your handset at least **15-20 hours before plugging into the phone line**. Once the handset battery pack is fully charged, connect the telephone line cord to the base and telephone wall outlet.

- 4) Connect the telephone line cord to the **TEL LINE** jack and to a telephone outlet once the handset is fully charged.



If your telephone outlet isn't modular, contact your telephone company for assistance.

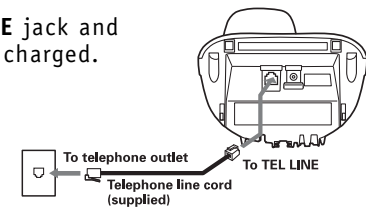
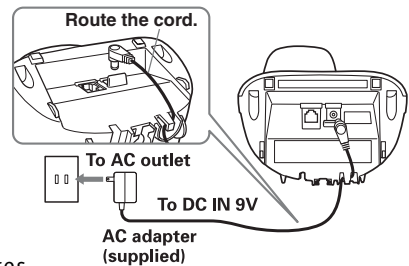

Mounting the Base Unit on a Wall

Standard wall plate mounting

This phone can be mounted on any standard wall plate.

- 1) Plug the AC adapter into the **DC IN 9V** jack.
- 2) Wrap the AC adapter cord inside the molded wiring channel as shown.
- 3) Plug the AC adapter into a standard 120V AC wall outlet.
- 4) Plug the telephone line cord into the **TEL LINE** jack. Wrap the cord inside the molded wiring channel as shown.
- 5) Plug the telephone line cord into the telephone outlet.
- 6) Align the mounting slots on the base with the mounting posts on the wall. Then push in and down until the phone is firmly seated.

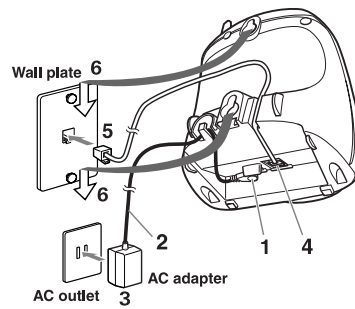

DO NOT use an AC outlet controlled by a wall switch.

GETTING STARTED

Direct wall mounting

If you don't have a standard wall plate, you can mount your phone directly to the wall. Before doing this, consider the following:

- Avoid electrical cables, pipes, or other items behind the mounting location that could cause a hazard when inserting screws into the wall.
- Try to mount your phone within 5 feet of a working phone jack to avoid excessive lengths.
- Make sure the wall material is capable of supporting the weight of the base and handset.
- Use #10 screws (minimum length of 1-3/8 inches) with anchoring devices suitable for the wall material where the base unit will be placed.

1) Insert two mounting screws into the wall, (with their appropriate anchoring device), 3-15/16 inches apart. Allow about 1/8 of an inch between the wall and screw heads for mounting the phone.

2) Refer to steps 1 through 6 on page 13 to mount the telephone.

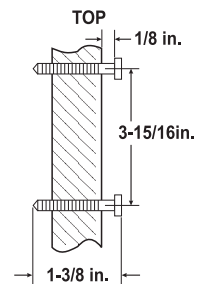

Setting Menu Options

There are five setup options available. They are Caller ID options [AutoTalk, CIDCW (Caller ID on Call Waiting), Area Code], Dial Mode and Language.

AutoTalk allows you to answer the phone without pressing the **talk/flash** button. If the phone rings when AutoTalk is On, simply remove the handset from the base and the phone automatically answers the call. If the phone rings when AutoTalk is Off, you must press **talk/flash** to answer the call.

Caller ID options

To change your AutoTalk and CIDCW:

- 1) Press and hold **call id/menu**. The following screen appears.
- 2) Use **vol/▲/▲** or **vol/▲/▼** to move the pointer to the selection that you would like to change. Press **select** to toggle between "On" and "Off" for AutoTalk and CIDCW.
- 3) Press **end** and return the handset to the base unit to complete the setting. The handset returns to standby mode.

```

Auto Talk :Off
CIDCW    :On
Area Code :
  
```

To enter your Area Code:

If you enter a 3-digit area code number in the Area Code option, your local area code does not appear in Caller ID messages. Do not program this option if your calling area requires 10-digit dialing. When reviewing Caller ID messages, you will see only the local seven digit number. For calls received from outside your local area code, you will see a full 10-digit number.



- If your calling area requires 10-digit dialing, do not program this option.
- The cordless phone features include **AutoTalk™** and **AutoStandby™**. AutoTalk allows you to answer a call by just removing the handset from the base so you don't have to waste time pushing buttons. AutoStandby allows you to hang up by simply returning the handset to the base.

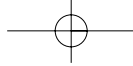

- 1) When the phone is in standby mode, press and hold **call id/menu**. The Caller ID setting screen appears.
- 2) Press **vol/ Δ / ∇** twice to select "Area Code".
- 3) Press **select**.
- 4) Use the number keys (**0 - 9**), or **delete/channel** to enter the 3-digit area code.
- 5) Press **select**. A confirmation tone sounds and the displayed area code is entered.
- 6) Press **end** or return the handset to the base unit to complete the setting. The handset returns to standby mode.

```

Auto Talk :Off
CIDCW    :On
Area Code :

```

```

Auto Talk :Off
CIDCW    :On
Area Code :

```

```

Auto Talk :Off
CIDCW    :On
Area Code :

```



When the area code has already been stored in memory, the stored area code will be displayed. To change it, use the **delete/channel** and number keys to enter the new area code. Then press **select**. A confirmation tone sounds. To complete the setting, press **end** or return the handset to the base unit.

```

Auto Talk :Off
CIDCW    :On
Area Code :817

```



note

Make sure your battery pack is fully charged before choosing the dialing mode.

Choosing the dialing mode

Most phone systems use tone dialing which sends DTMF tones through the phone lines. However, some phone systems (such as those in rural areas) still use pulse dialing. The default setting is tone dialing. Depending on your dialing system, set the mode as follows:

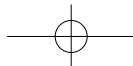

- 1) When the phone is in standby mode, press and hold **call id/menu**. The following screen appears.
- 2) Press **vol/▲/▼** three times to select "Dial".
- 3) Press **select** to toggle between "Tone" and "Pulse" for each setting.
- 4) Press **end** or return the handset to the base unit to complete the setting. The handset returns to standby mode.
 - If you are not sure of your dialing system, set for tone dialing and make a trial call. If the call connects, leave the setting as is. Otherwise, set for pulse dialing.
 - If your phone system requires pulse dialing and you need to send the DTMF tones for certain situations during a call, you may "switch-over" to tone dialing. (Refer to "Tone Dialing Switch-over" on page 20.)

```

▶Auto Talk :Off
CIDCW      :On
Area Code  :
    
```

```

CIDCW      :On
Area Code  :
▶Dial      :Tone
    
```

Setting the language

- 1) When the phone is in standby mode, Press and hold **call id/menu**. The following screen appears.
- 2) Press **vol/▲/▼** four times to select "Language".
- 3) Press **select** to toggle "Eng", "Fr." or "Esp" for each setting.
- 4) Press **end** or return the handset to the base unit to complete the setting. The handset returns to standby mode.

```

▶Auto Talk :Off
CIDCW      :On
Area Code  :
    
```

```

Area Code  :
Dial       :Tone
▶Language  :Eng
    
```



Refer to page 15 "Setting Menu Options" to turn On the AutoTalk feature if desired.

Making and Receiving Calls

	Handset On Base	Handset Off Base
To receive a call	Pick up the handset (AutoTalk: On) or pick up the handset and press talk/flash (AutoTalk: Off).	Press talk/flash (AutoTalk: Off), or press talk/flash , * /tone/ < , # / > or any number key (AutoTalk: On).
To make a call	<ol style="list-style-type: none"> 1) Pick up the handset. 2) Press talk/flash. 3) Listen for the dial tone. 4) Enter the number. <p style="text-align: center;">OR</p> <ol style="list-style-type: none"> 1) Pick up the handset. 2) Enter the number, then press talk/flash. 	<ol style="list-style-type: none"> 1) Press talk/flash. 2) Listen for the dial tone. 3) Enter the number. <p style="text-align: center;">OR</p> <p>Enter the number, then press talk/flash.</p>
To hang up	Press end or return the handset to the base (AutoStandby).	
To redial	<ol style="list-style-type: none"> 1) Pick up the handset. 2) Press talk/flash. 3) Listen for the dial tone. 4) Press redial/pause. <p style="text-align: center;">OR</p> <ol style="list-style-type: none"> 1) Pick up the handset. 2) Press redial/pause, then press talk/flash. 	<ol style="list-style-type: none"> 1) Press talk/flash. 2) Listen for the dial tone. 3) Press redial/pause. <p style="text-align: center;">OR</p> <p>Press redial/pause, then press talk/flash.</p>

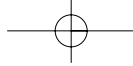

Adjusting the Handset Ringer and Earpiece Volume

Handset ringer tone and volume

Press the volume up key or volume down key (labeled as, **vol/▲/▲** or **vol/▲/▼**) in standby mode to select one of five ringer tones and volume combinations.

Earpiece volume

Press the volume up key or volume down key (labeled as, **vol/▲/▲** or **vol/▲/▼**) during a call to change the earpiece volume of the handset. This setting will remain in effect after the telephone call has ended.

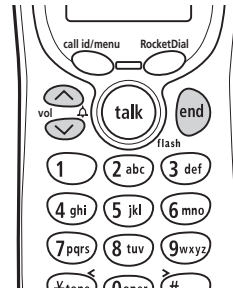

Temporarily Mute Ringer

If the handset is off the base, simply press the **end** to temporarily mute the incoming ring. The ringer will sound with the next incoming call.

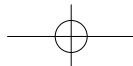

note

- The tone feature only applies when the dial mode is set to pulse.
- This special number can be stored in a memory location. This is referred to as Chain Dialing (See page 27.)

Redial

The *redial/pause* key redials the last number dialed. The redialed number can be up to 32 digits long.

Tone Dialing Switch-over

Some telephone companies use equipment that requires pulse dialing (sometimes referred to as rotary dialing). If you need to enter tone dialing digits, you can switch-over to tone dialing during the call. This feature is useful when you need tone dialing to use automated systems, for example, entering your bank account number after you have called your bank.

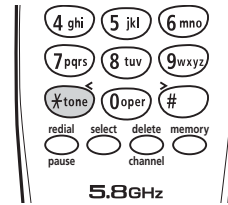

Initially make your call with the pulse dialing mode. Once your call connects, press the **/tone/*<. Enter the desired number. These digits will be sent as tone dialing. Once the call ends, the tone mode is canceled and pulse dialing mode resumes.

Traveling Out-of-Range

During a call, as you begin to move your handset too far from your base unit, noise increases. If you pass the range limits of the base unit, your call will terminate within 1 minute.

Selecting a Different Channel

If you encounter interference while using your phone, you can manually change the phone's channel for clear operation. This function works only when the phone is in use. Press **delete/channel**. "Scanning" appears on the display, indicating the phone is changing to another channel. For more information on interference, refer to "Precautions" on page 45.

Page

To locate the handset (while it's off the base), press **find handset** on the base. The handset beeps for 60 seconds. Paging is canceled when pressing any key or the handset is returned to the base.

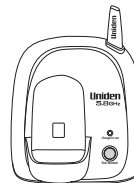

Flash and Call Waiting

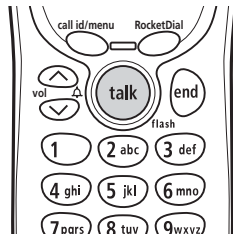

If you have "Call Waiting" service and a call waiting tone sounds while you are on a call, press **talk/flash** to accept the waiting call. There is a short pause, then you will hear the new caller. To return to the original caller, press **talk/flash** again.

note You must subscribe through your local telephone company to receive Call Waiting Service.

www.uniden.com

note

The **UltraClear Plus™** true compander circuitry virtually eliminates background noise. This innovative technology, together with 20 different channels, provides you with the best possible reception during all your conversations.

hints

You can cancel paging by pressing the **find handset** on the base.



You must subscribe to voice mail service from your telephone company in order to use this feature. The voice mail company will provide you with the access number.

Voice Mail Waiting Indicator

If you subscribe to voice mail service, you can use your cordless telephone to access your voice mailbox. The **charge/in use** light on the base of your phone flashes whenever you have messages waiting in your voice mailbox. Just program the **RocketDial** with your access number and you can get your messages at the touch of a button. (The voice mail service provider will supply you with the access number. This number may be simply a phone number. Refer to the provider's literature.)

You may need to occasionally reset the indicator if it remains On after you have retrieved your messages. To reset the indicator, press and hold **find handset** for 5 seconds.

Storing Phone Numbers and Names

Memory Dialing allows you to dial a number using just a few key presses. Your cordless telephone stores up to 10 names/numbers in the handset.

- 1) Press **memory** in standby mode, "Select Memory" is displayed.
- 2) Press **vol/▲/△** or **vol/▲/▽**, or enter a number (**1 - 0**) to select the memory location where you would like to store the number.
- 3) Press **memory** or **select**.
- 4) Press **memory** or **select**. The Store Name screen appears and a cursor flashes indicating that the display is ready for the name to be entered.

If the Edit screen appears, the selected memory location is already stored. Then you must either edit the entry in this location, delete the entry in this location, or select "Go Back" to choose another location.

- 5) To enter a name (up to 13 characters), use the number keys.
 - See the "Steps for Entering Names and Special Characters". (See page 25).
 - Use **#/>** and *** /tone/ <** to move the cursor to the desired location.
 - Use **delete/channel** to delete characters as needed.
 - Press and hold **delete/channel** to delete all the characters.
 - If a name is not required, go to step 6.

www.uniden.com

```
Select Memory
01:
02 JOHN DOE
```

```
01:(Empty)
Press Select
to edit
```

```
Store Name
█
```

```
Edit Memory01
Delete Memory01
Go Back
```

note

- In memory dialing operation, you must press a key within 30 seconds or the phone will return to standby mode. If you return the handset to the base, the phone will return to standby mode also.
- You have 30 seconds after pressing **memory** or **select** to enter the number you wish to store. Otherwise, an error tone will sound and the phone will return to standby mode.



The pause feature is useful for long distance calling, credit card dialing, or sequences that require a pause between digits.

6) Press **memory** or **select**. "Store Number" is displayed. The cursor flashes indicating that the display is ready for the number to be entered.

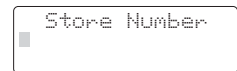

7) Use the number keys, ***/tone/<** or ***/>** to enter the phone number. The phone number cannot exceed 20 digits. Use **redial/pause** to enter a pause in the dialing sequence. The display shows a "P". Each pause counts as one digit and represents a two second delay of time between the digits. Use **delete/channel** to delete digits as needed.

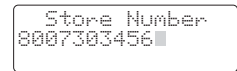

8) Press **memory** or **select**. You will hear a confirmation tone, and the following screen appears. Memory storage is complete. For example, if you store a name and number into memory location number 01, the display shows "Memory01 Stored". After about 2 seconds, the following screen is displayed. Repeat steps 2 - 8 to store more numbers.

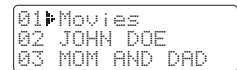
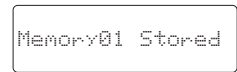

9) Press **end** to return to standby mode.

Steps for Entering Names and Special Characters

Refer to the letters on the number keys to select the desired characters. With each press of a numeric key, the displayed character appears in the following order: Upper case letters first, lower case letters next and finally the number corresponding to the key.

If you make a mistake while entering a name

Use ***/tone/<** or ***/>** to move the cursor to the incorrect character. Press **delete/channel** to erase the wrong character, then enter the correct character. To delete all characters, press and hold **delete/channel**.

For example, to enter **Movies**.

- 1) Pick up the handset. Press **memory**.
- 2) Enter a number or press **vol/Δ/∧** or **vol/Δ/∇** to select a memory location.
- 3) Press **memory** or **select**.
- 4) Press **memory** or **select**. (When there is information already stored in the selected memory location, "Edit MemoryXX" is displayed. See page 28 for information on "Editing a Stored Name and/or Phone Number".)
- 5) Press **6** then press ***/>** to move the cursor to the right.
- 6) Press **6** six times.
- 7) Press **8** six times.
- 8) Press **4** six times.
- 9) Press **3** five times.
- 10) Press **7** eight times.
- 11) When finished, press **memory** or **select**.

To continue to store the telephone number, proceed to step 7 on page 24.

keys	Number of times key is pressed								
	1	2	3	4	5	6	7	8	9
1	1								
2	A	B	C	a	b	c	2		
3	D	E	F	d	e	f	3		
4	G	H	I	g	h	i	4		
5	J	K	L	j	k	l	5		
6	M	N	O	m	n	o	6		
7	P	Q	R	p	q	r	=	?	
8	T	U	V	t	u	v	8		
9	W	X	Y	z	x	y	z	9	
0	*	#	-	&	<	>	(blank)	0	



note

If the next character uses the same number key, you must press ***/>** to move the cursor over. Otherwise the next time you press the number key, it overwrite the existing character.



- If you press **memory** or **select** before **talk/flash**, you can confirm the name and the number stored in the selected memory location.
- Whenever you are using a memory menu screen, you must press a key within 30 seconds or the phone will return to standby mode.

Making Calls with Memory Dialing

Memory dialing from Standby Mode

- 1) Press **memory**. The handset displays your programmed memory locations.
- 2) Press **vol/▲/▼** or **vol/▲/▲**, or enter the number (**1 - 0**) to select the memory location you would like to dial.
- 3) Press **talk/flash**. "Talk" and the volume setting appear on the display. Then the displayed number is dialed.

```
Select Memory
01: Movies
02: JOHN DOE
```

```
>Talk<
8007303456
```

-  To exit the memory function without dialing, press **end**. The handset returns to standby mode.

Memory dialing from Talk Mode

1) Press **talk/flash**. "Talk" and the volume setting appears.

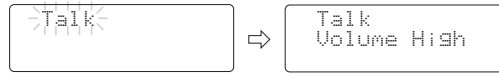

2) Press **memory**.

3) Press **vol/▲/△** or **vol/▲/▽**, or enter a number (1 - 0) to select the memory location of the desired phone number. If you press **select** key, the number is dialed.

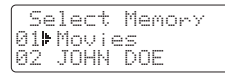

4) The phone number in the memory will be dialed when the **select** is pressed.



5) To hang up, press **end**.

Chain Dialing

The memory locations on the handset are not limited to phone numbers. You can also store a group of numbers (up to 20 digits) that you need to enter once your call connects. This is referred to as Chain Dialing.

An example of this is a bank account number. Once you have called your bank and are prompted to enter the account number, press **memory** and select the location number where the special number has been stored. Then press **select**.

Store your special number with an identifying name. (Refer to "Storing Phone Numbers and Names" on page 23.)

Editing a Stored Name and/or Phone Number

- 1) Press **memory**, "Select Memory" is displayed.
- 2) Press **vol/▲/▲** or **vol/▲/▼**, or enter a number (**1 - 0**) to select the memory location you would like to edit, and press **memory** or **select**.
- 3) Press **memory** or **select**.
The following screen appears with the memory location number that you have selected.
- 4) Press **vol/▲/▲** or **vol/▲/▼** to select "Edit MemoryXX", then press **memory** or **select**. The following screen appears. The cursor flashes indicating that the display is ready for the name to be edited. When a name has not been stored, the cursor appears at the beginning of the second line.
- 5) Use the number keys, ***/tone/<**, **#/>**, or **delete/channel** to edit the name. (See page 25.) To edit only the phone number, skip this step.
- 6) Press **memory** or **select**. The following screen appears. The cursor flashes indicating that the display is ready for the number to be edited.

```
Select Memory
01: Movies
02: JOHN DOE
```

```
01: Movies
8007303456
```

```
Edit Memory01
Delete Memory01
Go Back
```

```
Store Name
Movies
```

```
Store Number
8007303456
```

7) Use the number key, ***** /*tone* / **<**, **#** / **>**, *redial/pause* or *delete/channel* to edit the phone number. The phone number cannot exceed 20 digits. (See page 24.)
If you don't want to change the phone number, skip this step.

8) Press *memory* or *select*. If you changed either name or phone number, a confirmation display shows up. If it is correct, press *vol* / **▲** / **△** and press *select*. You hear a confirmation tone, and the following screen appears. The memory storage is complete.
For example, if you edit a name and number into memory location number 01, the display shows "Memory01 Stored". After about 2 seconds, Select memory is displayed.

9) Press *end* to return to standby mode.

```
Replace Memory?  
Yes  
No
```

```
Memory01 Stored
```

```
01 Movies  
02 JOHN DOE  
03 MOM AND DAD
```

Erasing a Stored Name and Phone Number

- 1) Press **memory**, "Select Memory" is displayed.
- 2) Press **vol/▲/▲** or **vol/▲/▼**, or enter a number (1 - 0) to select the memory location you would like to erase.
- 3) Press **memory** or **select**.
- 4) Press **memory** or **select**.
The Edit screen appears with the memory location number that you have selected in the display.
- 5) Press **vol/▲/▼** to move the pointer down to "Delete MemoryXX".
- 6) Press **memory** or **select**. The "Delete MemoryXX?" screen appears.
- 7) Press **vol/▲/▲** to move the pointer to "Yes".
- 8) Press **select** or **delete/channel**.
You hear a confirmation tone, and the "MemoryXX Deleted" screen appears.
- 9) After about 2 seconds, the display returns to the Select Memory screen. You may delete the information in another memory location (return to step 2) or press **end** to return to standby mode.

```
Select Memory
01 Movies
02 JOHN DOE
```

```
02: JOHN DOE
5452930
```

```
Edit Memory02
Delete Memory02
Go Back
```

```
Delete Memory02?
Yes
No
```

```
Memory02 Deleted
```

```
01 Movies
02
03 MOM AND DAD
```

RocketDial

You can store your most frequently dialed number in the RocketDial location. The RocketDial allows you to dial a number with one key press. (There is no need to press **talk/flash**. The phone will automatically dial the number stored.) If you subscribe to voice mail service, store your access number in this location.

Storing and Editing the RocketDial

- 1) When the phone is in standby mode, press and hold **RocketDial**. The following display appears.

If the Edit screen appears, there is a number already stored. Press **vol/▲/▲** or **vol/▲/▼** to select "Edit Number", then press **select**.

- 2) Store the number by following step 7 under "Storing Phone Numbers and Names" on page 24.
- 3) Press **select**.

You hear a confirmation tone, and the "Number Stored" screen appears. Memory storage is complete.

Making Calls with the RocketDial

When the phone is in standby mode, simply press **RocketDial**. The number stored in the RocketDial memory location is instantly dialed.

www.uniden.com

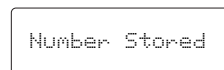
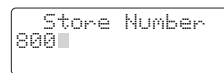
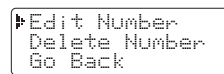
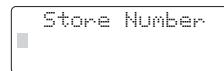
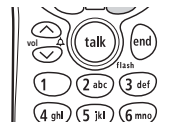

- **RocketDial** is a one touch speed dial key that automatically dials your most important or frequently called number. The number dialed, is a preset number stored by the user.
- Number stored in RocketDial is independent from the numbers stored in Memory Dial.
- If the RocketDial does not have a stored number, the handset will beep rapidly and the phone will not dial.

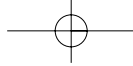

Deleting the RocketDial

- 1) When the phone is in standby mode, press and hold **RocketDial**. The following display appears.
- 2) Press **vol/▲/▲** or **vol/▲/▼** to select "Delete Number".
- 3) Press **select**. Following display appears.
- 4) Press **vol/▲/▲** to move the pointer to "Yes".
- 5) Press **select** or **delete/channel**.
You hear a confirmation tone, and the following display appears. After about 2 seconds, the handset returns to standby mode.

```
Edit Number
Delete Number
Go Back
```

```
Delete Number?
Yes
No
```

```
Number Deleted
```

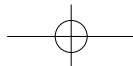

Caller ID

You must subscribe to Caller ID service to use this feature.

When the telephone rings, the Caller ID feature allows you to view the caller's name and phone number on the display before you answer the phone. The handset displays the phone number of the incoming call, the name, and time. Additionally, you can dial the displayed number and store the information for memory dialing. Make sure you have turned on the Caller ID on Call Waiting feature. (See page 15.)

When the Telephone Rings

1) When the Caller ID message is received, the display shows the caller's phone number along with the date and time. The incoming call information is stored in the Caller ID record. If the Caller ID service includes the caller's name, the caller's name appears on the display (up to 15 letters).

The date and time received	5/11 12:30PM
Caller's name	Jane Smith
Caller's phone number	214-555-1234

You may receive any one of the following messages:

When invalid data is received	"Incomplete Data"
When a private name is received	"Private Name"
When a private number is received	"Private Number"
When an unknown name is received	"Unknown Name"
When an unknown number is received	"Unknown Number"



- If you answer a call before the Caller ID message is received (for example: before the second ring), the Caller ID message will not appear.
- When the call is received via a telephone company that does not offer Caller ID service, the caller's phone number and name do not appear. (This includes international calls.)
- When the call is via a private branch exchange (PBX), the caller's phone number and name may not appear.



- In Caller ID operation, if no key is pressed for more than 30 seconds, an error tone sounds and the handset returns to standby mode.
- If a call comes in via a telephone system that does not offer Caller ID service, no information is stored.
- Each message can be up to 15 characters for the phone number and the name.
- The number of calls from the same Caller ID appears next to the received time. Once you view the new message, the number will be cleared and disappear.

2) When you pick up the phone, the display changes to "Talk". (AutoTalk feature is set to on.)

 Data errors appear as "■".

Viewing the Caller ID Message List

The Caller ID list stores information for up to 30 messages (Caller ID names/numbers) - even unanswered calls.

- 1) Press **call id/menu**.
The summary screen appears. The screen shows the number of new messages and total messages.
- 2) Press **vol/▲/▼** to display the latest Caller ID message.
- 3) Press **vol/▲/▼** to see the next message. Or press **vol/▲/▼** key to see the previous message.
- 4) Press **end** to return to standby mode.

```

Caller ID
New :01
Total:02
    
```

```

5/17 12:30PM 03
Jane Smith
214-555-1234
    
```

Deleting Information from the Caller ID List

The cordless phone stores up to 30 messages (Caller ID names/numbers). If the phone receives the 31st message, the oldest one in the list is automatically deleted. Caller ID data can also be deleted manually.

Deleting a Caller ID message

- 1) Press **call id/menu**. Display the message to be deleted from the Caller ID list by pressing **vol/▲/▲** or **vol/▲/▼**.
- 2) Press **delete/channel**.
- 3) Press **vol/▲/▲** or **vol/▲/▼** to select "Yes" or "No".
- 4) Press **select** or **delete/channel**.

```
5/17 12:30PM 03
Jane Smith
214-555-1234
```

```
Delete Message?
▶Yes
No
```

When the pointer is at "Yes":

A tone sounds and the Caller ID message is deleted. The next Caller ID message is then displayed.

When the pointer is at "No":

The display returns to the Caller ID message.

Deleting all Caller ID names/numbers

- 1) Press **call id/menu**.
- 2) Press **delete/channel**.

```
Caller ID
New :01
Total:02
```



- While using the "Delete All?" or "Delete Message?" screen if no key is pressed for more than 30 seconds, an error tone sounds and the telephone returns to standby mode.
- If you get an incoming call or page, the deleting operation is canceled and you can answer the call or page.

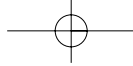

3) Press **vol/▲/▲** or **vol/▲/▼** to select "Yes" or "No".

```
Delete All?  
Yes  
▶No
```

4) Press **select** or **delete/channel**.

When the pointer is at "Yes":
A tone sounds and all stored Caller ID messages are deleted.

```
Caller ID  
Total:00
```

When the pointer is at "No":
The display returns to the summary screen.

```
Caller ID  
New :01  
Total:02
```

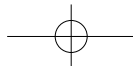

Using the Caller ID List

Calling a party from the Caller ID list

You can place a call from the Caller ID list. The cordless phone stores up to 30 messages (Caller ID names/numbers).

- 1) Press **call id/menu**. Select the phone number that you want to dial by pressing **vol/▲/▲** or **vol/▲/▼**.
- 2) Press **talk/flash**. The displayed phone number dials automatically.

```
5/17 12:30PM 03
Jane Smith
214-555-1234
```

```
Talk
2145551234
```



You can place a call from Talk Mode. Press the **talk/flash**, then press the **call id/menu**. Select the phone number that you want to dial by pressing the **vol/▲/▲** or **vol/▲/▼**, then press **select**. The displayed phone number will be dialed.

Long Distance calls and Area Code Setting/Cancellation

Pressing **1** while the incoming Caller ID information is displayed (in step 1) will place the prefix "1" in the display to set up for a long distance call. Pressing **3** will set or cancel an area code setting.



- You cannot make a call from the Caller ID list if your cordless telephone is connected to a private branch exchange (PBX).
- When a long distance call has been set, "1" appears in the display.



You cannot store a Caller ID message if no phone number appears in the message.

Storing Caller ID messages in Memory dialing

Messages (Caller ID names/numbers) shown in the Caller ID list can be stored in memory dialing.

- 1) Press **call id/menu**.
Select the phone number to be stored from the Caller ID list by pressing **vol/▲/▲** or **vol/▲/▼**.
- 2) Press **memory**.
- 3) Press **vol/▲/▲** or **vol/▲/▼** or enter a number (**1 - 0**) to select the memory location to be stored.
- 4) Press **select**.
You hear a confirmation tone, and the number is stored in memory. The display returns to the Caller ID list.

```

5/17 12:30PM 03
Jane Smith
214-555-1234

```

```

Select Memory
01▶
02 JOHN DOE

```

```

5/17 12:30PM 03
Jane Smith
214-555-1234

```



If a message has already been stored in the selected memory number location, a confirmation screen is displayed. Press **vol/▲/▲** to select "Yes". Press **select** to overwrite. The display returns to the Caller ID list.

```

Replace Memory?
Yes
▶No

```

Changing the Digital Security Code

The digital security code is an identification code used to connect the handset and the base unit. Normally, setting the code is not necessary. The first time you charge your handset, the security code is automatically set.

In the rare situation that you suspect another cordless telephone is using the same security code, you can change the code.

- 1) Remove the handset from the base unit. Press and hold **find handset** on the base.
- 2) While holding **find handset**, place the handset in the base unit, and leave the handset on the base for more than 3 seconds. A new random security code is set.

Installing the Beltclip

To attach the beltclip

Insert the beltclip into the holes on each side of the handset. Press down until it clicks.

To remove the beltclip

Pull both sides of the beltclip to release the tabs from the holes.

Headset Installation

Your phone may be used with an optional headset, the Uniden HS910.

To use this feature, insert the headset plug into the headset jack.

Your phone is ready for hands-free conversations.

(Headset may be purchased by calling the Uniden Parts Department or visiting the web site, see QUICK REFERENCE GUIDE on page 3.)



- To protect you against misbilled calls which might result from your phone being activated by other equipment, the cordless phone provides **AutoSecure™** to electronically lock your phone when the handset is in the base. Also, the **Random Code™** digital security which automatically selects one of over 262,000 digital security codes for the handset and base.
- If the handset battery pack is completely discharged or the battery pack is removed, the digital security code will be lost. If this happens, a new security code is set automatically the next time the battery pack is charged.

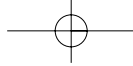

Note on Power Sources

Battery replacement and handling

When the operating time becomes short, even after a battery is recharged, please replace the battery. With normal usage, your battery should last about one year. Please contact your place of purchase or the Uniden Parts Department for a replacement battery.

Warning: To avoid the risk of personal injury or property damage from fire or electrical shock, only use the Uniden battery model and Uniden adapter model specifically designated for this product.

Power Failure

During the period that the power is off, you will not be able to make or receive calls with the telephone.

Caution

- Use only the specified Uniden battery pack.
- Do not remove the battery from the handset to charge it.
- Never throw the battery into a fire, disassemble it, or heat it.
- Do not remove or damage the battery casing.

Maintenance

To maintain a good charge, it is important to clean the charging contacts on both the handset and base unit once a month.

Using water only, dampen a cloth to clean the charging contacts.

Then make sure to go back over the charging contacts with a dry cloth.

Caution

Do not use paint thinner, benzene, alcohol, or other chemical products. Doing so may discolor the surface of the telephone and damage the finish.

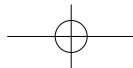

Troubleshooting

If your phone is not performing to your expectations, please try these simple steps first.

Symptom	Suggestion
The charge/in use LED won't illuminate when the handset is placed in the base.	<ul style="list-style-type: none">• Make sure the AC adapter is plugged into the base and wall outlet.• Make sure the handset is properly seated in the base.• Make sure the charging contacts on the handset and base are clean.
The audio sounds weak and/or scratchy.	<ul style="list-style-type: none">• Move the handset and/or base to a different location away from metal objects or appliances and try again.• Press delete/channel to help eliminate background noise.• Make sure that you are not too far from the base.
Can't make or receive calls.	<ul style="list-style-type: none">• Check both ends of the base telephone line cord.• Make sure the AC adapter is plugged into the base and wall outlet.• Disconnect the AC adapter for a few minutes, then reconnect it.• Change the digital security code (see page 39).• Make sure that you are not too far from the base.

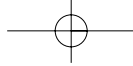

Symptom	Suggestion
The handset doesn't ring or receive a page.	<ul style="list-style-type: none"> • The battery pack may be weak. Charge the battery for 15-20 hours. • The handset may be too far away from the base unit. • Place the base unit away from appliances or metal objects. • Change the digital security code (see page 39). • Check the battery pack to insure there is a secure connection. • Make sure ringer volume isn't set to "off".
Severe noise interference.	<ul style="list-style-type: none"> • Keep the handset away from microwave ovens, computers, remote control toys, wireless microphones, alarm systems, intercoms, room monitors, fluorescent lights, electrical appliances, other cordless telephones and other devices that use electricity. • Move to another location or turn off the source of interference.
The Caller ID does not display.	<ul style="list-style-type: none"> • The handset was picked up before the second ring. • The call was placed through a switchboard. • Call your local telephone company to verify your Caller ID service is current. • Charge the handset.
Voice Message Indication does not work.	<ul style="list-style-type: none"> • Contact your local telephone company to make sure that your telephone receives FSK message signaling.
If you still have a problem.	<ul style="list-style-type: none"> • Call our customer hotline at 1-800-297-1023.

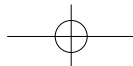

Liquid Damage

Moisture and liquid can damage your cordless phone. In case of accidental submersion, please read the following steps.

Case	Action
If the handset or base is exposed to moisture or liquid, but only affects the exterior plastic housing.	Wipe off the liquid and use as normal.
If moisture or liquid has entered the plastic-housing (i.e. liquid can be heard in the phone or liquid has entered the handset battery compartment or vent openings on the base).	<p>Handset:</p> <ol style="list-style-type: none"> 1. Remove the battery cover and leave it off for ventilation. 2. Remove the battery pack by disconnecting. 3. Leave the battery cover off and the battery pack disconnected for at least 3 days. 4. Once completely dry, reconnect the battery pack and the battery cover. 5. Recharge the handset's battery pack for 20 hours in the base unit before using the phone. <p>Base:</p> <ol style="list-style-type: none"> 1. Disconnect the AC adapter from the base unit, cutting off electrical power. 2. Disconnect the telephone cord from the base unit. 3. Let dry for at least 3 days. <p>IMPORTANT: You must unplug the telephone line while recharging the battery pack to avoid charge interruption.</p> <p>CAUTION: DO NOT use a microwave oven to speed up the drying process. This will cause permanent damage to the handset, base and the microwave oven.</p> <p>After following these steps, if your cordless telephone does not work, please send to: Uniden America Corporation Parts and Service Division 4700 Amon Carter Blvd. Ft. Worth, TX76155 1-800-554-3988. Monday through Friday 8 a.m. to 5 p.m. CST</p>

General Information

The phone complies with FCC Parts 15 and 68.
Operating temperature: -10° to 50°C (+14°F to +122°F)

AC Adapter Information

AC Adapter part number: AD-314
Input Voltage: 120V AC 60Hz
Output Voltage: 9V DC 350 mA

Battery Information

Battery part number: BT-800
Capacity: 800 mAh, 3.6V



You can also use BT-905, but its usage time is less than BT-800.
Purchase BT-800 at Uniden Website www.uniden.com.

Frequency

925.181-927.451 MHz
5739.320-5746.130 MHz



- To avoid damage to the phone use only Uniden AD-314 and BT-800 (or BT-905 having less usage time) with your phone.
- If the handset is left off of the base, the actual Talk mode duration will be reduced respective to the amount of time the handset is off the base.

Recharge your phone on a regular basis by returning the handset to the base after each phone call. When the operating time becomes short, even after the battery is recharged, please replace the battery. With normal usage, the battery should last about one year.

A replacement Uniden adapter and battery may be purchased at your local Uniden dealer or by contacting the Uniden Parts Department (800) 554-3988. Hours are from 8:00 a.m. to 5:00 p.m. Central Time, Monday through Friday. We can also be reached on the web at www.uniden.com.

Specifications, features, and availability of optional accessories are all subject to change without prior notice.

Precautions!

Before you read anything else, please observe the following:

Warning!

Uniden America Corporation DOES NOT represent this unit to be waterproof. To reduce the risk of fire, electrical shock, or damage to the unit, DO NOT expose this unit to rain or moisture.

Rechargeable Nickel-Cadmium Battery Warning

- This equipment contains a rechargeable nickel-cadmium battery.
- Cadmium is a chemical known to the State of California to cause cancer.
- The rechargeable nickel-cadmium battery contained in this equipment may explode if disposed of in a fire.
- Do not short-circuit the battery.
- Do not charge the rechargeable nickel-cadmium battery used in this equipment in any charger other than the one designed to charge this battery as specified in the owner's manual. Using another charger may damage the battery or cause the battery to explode.

Rechargeable Nickel-Cadmium Batteries Must Be Recycled or Disposed of Properly

- Uniden voluntarily participates in an RBRC® industry program to collect and recycle nickel-cadmium batteries at the end of their useful life, when taken out of service within the United States. The RBRC® program provides a convenient alternative to placing used nickel-cadmium batteries into the trash or municipal waste stream, which is illegal in some areas.
- Through the RBRC® program, Uniden makes it easy for you to drop off the used battery at local retailers of replacement nickel-cadmium batteries. You may also contact your local recycling center for information on where to return the used battery. Please call 1-800-8-BATTERY for information on Ni-Cd battery recycling in your area. Uniden's involvement in this program is part of its commitment to protecting our environment and conserving natural resources.
- RBRC® is a registered trademark of the Rechargeable Battery Recycling Corporation.

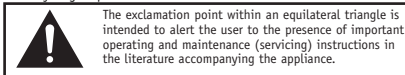

Uniden works to reduce lead content in our PVC coated cords in our product and accessories.

Warning!

The cords on this products and/or accessories contain lead, a chemical

www.uniden.com

known to the State of California to cause birth defects or other reproductive harm. *Wash hands after handling.*

Important Safety Instructions

When using your telephone equipment, these basic safety precautions should always be followed to reduce the risk of fire, electrical shock, and injury to persons:

1. Read and understand all instructions.
2. Follow all warnings and instructions marked on the product.
3. Unplug this product from the wall outlet before cleaning. Use a dry cloth for cleaning without liquid or aerosol cleaners.
4. Do not use this product near water; for example, near a bathtub, wash bowl, kitchen sink or laundry tub, in a wet basement, or near a swimming pool.
5. Do not place this product on an unstable cart, stand, or table. The telephone may fall, causing serious damage to the unit.
6. Slots and openings in the cabinet and the back or bottom are provided for ventilation. To protect the product from overheating, these openings must not be blocked or covered. This product should never be placed near or over a radiator or heat register. This product should not be placed in a built-in installation unless proper ventilation is provided.
7. This product should be operated only from the type of power source indicated on the marking label. If you are not sure of the type of power supply to your home, consult your dealer or local power company.
8. Do not allow anything to rest on the power cord. Do not locate this product where the cord will be damaged by persons walking on it.
9. Do not overload wall outlets and extension cords, as this can result in the risk of fire or electrical shock.
10. Never push objects of any kind into this product through cabinet slots, as they may touch dangerous voltage points or short out parts that could result in a risk of fire or electric shock. Never spill liquid of any kind on the product.
11. To reduce the risk of electric shock, do not disassemble this product. Take it to qualified service personnel when service or repair work is required. Opening or removing covers may expose you to dangerous voltages or other risks. Incorrect reassembly can cause electric shock when the appliance is subsequently used.
12. Unplug this product from the wall outlet and refer servicing to qualified service personnel under the following conditions:
 - A. When the power supply cord is damaged or frayed.
 - B. If liquid has been spilled into the product.
 - C. If the product has been exposed to rain or water.
 - D. If the product does not operate normally when following the operating instructions. (Adjust only those controls that are covered by the operating instructions. Improper adjustment of other controls may result in damage and will often require extensive repair work by a qualified technician.)
 - E. If the product has been dropped or the cabinet has been damaged.

- F. If the product exhibits a distinct change in performance.
13. Do not use the telephone to report a gas leak in the vicinity of the leak.

Additional Battery Safety Precautions

Caution! To reduce the risk of fire or injury to persons by the battery, read and follow these instructions:

1. Use only the Uniden battery pack specified in the owner's manual.
2. Do not dispose of the battery pack in a fire. The cell may explode. Check the nickel-cadmium battery disposal package insert for disposal instructions.
3. Do not open or mutilate the battery pack. Released electrolyte is corrosive and may cause damage to the eyes or skin. It may be toxic if swallowed.
4. Exercise care in handling the battery in order not to short the battery with conducting materials such as rings, bracelets, and keys. The battery or conductor may overheat and cause burns.
5. Charge the battery pack provided with or identified for use with this product only in accordance with the instructions and limitations specified in the owner's manual provided for this product.
6. Observe proper polarity orientation between the battery pack and battery charger.

SAVE THESE INSTRUCTIONS!

Important Electrical Considerations

Unplug all electrical appliances when you know an electrical storm is approaching. Lightning can pass through your household wiring and damage any device connected to it. This phone is no exception.

The FCC Wants You To Know

Changes or modifications to this product not expressly approved by Uniden, or operation of this product in any way other than as detailed by the owner's manual, could void your authority to operate this product. Your telephone complies with Part 68 of FCC Rules. You must, upon request, provide the FCC registration number and the REN to your telephone company. Both numbers are on the base unit.

NOTE:

- You must not connect your phone to:
 - coin-operated systems
 - most electronic key telephone systems

Range

Your new phone is designed to achieve the maximum possible range by transmitting and receiving according to the highest specifications set forth by the FCC. We have rated this phone to operate at a maximum distance with the qualification that the range depends upon the environment in which the telephone is used. Many factors limit range, and it would be impossible to include all the variables in our rating. The Maximum Range rating of this phone is meant to be used as a means of comparison against other range claims.

Telephone Line Problems

The FCC has granted the telephone company the right to disconnect service in the event that your phone causes problems on the telephone line. Also, the telephone company may make changes in facilities and services which may affect the operation of your unit. However, your telephone company must give adequate notice in writing prior to such actions to allow you time for making necessary arrangements to continue uninterrupted service.

If you are having trouble with your telephone service, you must first disconnect your phone to determine if it is the cause of your problem. If you determine that it is the cause, you must leave it disconnected until the trouble has been corrected.

Radio Interference

Radio interference may occasionally cause buzzing and humming in your cordless handset, or clicking noises in the base. This interference is caused by external sources such as TV, refrigerator, vacuum cleaner, fluorescent lighting, or electrical storm. Your unit is NOT DEFECTIVE. If these noises continue and are too distracting, please check around your home to see what appliances may be causing the problem.

In addition, we recommend that the base not be plugged into a circuit that also powers a major appliance because of the potential for interference. Be certain that antenna on the unit is fully extended. In the unlikely event that you consistently hear other voices or distracting transmissions on your phone, you may be receiving radio signals from another cordless telephone or other source of interference. If you cannot eliminate this type of interference, you need to change to a different channel.

Finally, it should be noted that some cordless telephones operate at frequencies that may cause interference to nearby TVs and VCRs.

To minimize or prevent such interference, the base of the cordless telephone should not be placed near or on top of a TV or VCR.

If interference is experienced, moving the cordless telephone farther away from the TV or VCR will often reduce or eliminate the interference.

More Than One Cordless Telephone

If you want to use more than one cordless telephone in your home, they must operate on different channels. Press the channel key to select a channel that provides the clearest communication.

Cordless Telephone Privacy

Cordless telephones are radio devices. Communications between the handset and base of your cordless telephone are accomplished by means of radio waves which are broadcast over the open airways. Because of the inherent physical properties of radio waves, your communications can be received by radio receiving devices other than your own cordless telephone unit. Consequently, any communications using your cordless telephone may not be private.

Installation Considerations

Selecting a Location

Before choosing a location for your new phone, there are some

important guidelines you should consider:

- The location should be close to both a phone jack and continuous power outlet. (A continuous power outlet is an AC outlet which does not have a switch to interrupt its power.)
- Keep the base and handset away from sources of electrical noise such as motors or fluorescent lighting.
- Be sure there is sufficient space to fully extend the base antenna.
- The base can be placed on a desk or tabletop or mounted on a standard telephone wall plate.
- You should charge your new phone for 15-20 hours before completing the installation or using the handset.

Telephone Line Outlets

There are two types of phone outlets:

Modular Jack

Most phone equipment available now uses modular jacks. Phone cords are fitted with a molded plastic connector which plugs into this type of jack. If you do not have modular phone jacks, contact your local telephone company for information about their installation.

Hardwired Jack

Some equipment is wired directly to a phone jack, and these types of installations require a modular jack converter. This type of installation is not difficult; however, you should contact your Uniden telephone dealer or a telephone supply store for advice about the proper adapter or converter for your particular situation.

Connecting the Telephone Cords

Consider these safety guidelines before connecting the telephone cords:

Caution!

- *Never install telephone wiring during a lightning storm.*
- *Never touch uninsulated telephone wires or terminals unless the telephone line has been disconnected.*
- *Use caution when installing or modifying telephone lines.*

Applying Power to the Base

This phone requires an AC outlet, without a switch to interrupt power, and the included AC adapter. To relieve strain on the DC plug when the phone is placed on a desk or table, wrap the power cord around the strain relief notch on the back of the base.

NOTE: Place the power cord so that it does not create a trip hazard, or where it could become chafed and create a fire or other electrical hazards.

One Year Limited Warranty

Important: Evidence of original purchase is required for warranty service.

WARRANTOR: UNIDEN AMERICA CORPORATION ("Uniden")

ELEMENTS OF WARRANTY: Uniden warrants, for one year, to the original retail owner, this Uniden Product to be free from defects in materials and craftsmanship with only the limitations or exclusions set out below.

WARRANTY DURATION: This warranty to the original user shall terminate and be of no further effect 12 months after the date of original retail sale. The warranty is invalid if the Product is (A) damaged or not maintained as reasonable or necessary, (B) modified, altered, or used as part of any conversion kits, subassemblies, or any configurations not sold by Uniden, (C) improperly installed, (D) serviced or repaired by someone other than an authorized Uniden service center for a defect or malfunction covered by this warranty, (E) used in any conjunction with equipment or parts or as part of any system not manufactured by Uniden, or (F) installed or programmed by anyone other than as detailed by the owner's manual for this product.

STATEMENT OF REMEDY: In the event that the product does not conform to this warranty at any time while this warranty is in effect, warrantor will either, at its option, repair or replace the defective unit and return it to you without charge for parts, service, or any other cost (except shipping and handling) incurred by warrantor or its representatives in connection with the performance of this warranty. Warrantor, at its option, may replace the unit with a new or refurbished unit. THE LIMITED WARRANTY SET FORTH ABOVE IS THE SOLE AND ENTIRE WARRANTY PERTAINING TO THE PRODUCT AND IS IN LIEU OF AND EXCLUDES ALL OTHER WARRANTIES OF ANY NATURE WHATSOEVER, WHETHER EXPRESS, IMPLIED OR ARISING BY OPERATION OF LAW, INCLUDING, BUT NOT LIMITED TO ANY IMPLIED WARRANTIES OF MERCHANTABILITY OR FITNESS FOR A PARTICULAR PURPOSE. THIS WARRANTY DOES NOT COVER OR PROVIDE FOR THE REIMBURSEMENT OR PAYMENT OF INCIDENTAL OR CONSEQUENTIAL DAMAGES. Some states do not allow this exclusion or limitation of incidental or consequential damages so the above limitation or exclusion may not apply to you.

LEGAL REMEDIES: This warranty gives you specific legal rights, and you may also have other rights which vary from state to state. This warranty is void outside the United States of America and Canada.

PROCEDURE FOR OBTAINING PERFORMANCE OF WARRANTY: If, after following the instructions in the owner's manual you are certain that the Product is defective, pack the Product carefully (preferably in its original packaging). The Product should include all parts and accessories originally packaged with the Product. Include evidence of original purchase and a note describing the defect that has caused you to return it. The Product should be shipped freight prepaid, by traceable means, to warrantor at:

Uniden America Corporation

Parts and Service Division

4700 Amon Carter Blvd. Fort Worth, TX 76155

(800) 297-1023, 8 a.m. to 5 p.m. Central, Monday through Friday

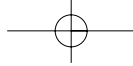

I.C. Notice

TERMINAL EQUIPMENT

NOTICE: This equipment meets the applicable Industry Canada Terminal Equipment Technical Specifications. This is confirmed by the registration number. The abbreviation, IC, before the registration number signifies that registration was performed based on a Declaration of Conformity indicating that Industry Canada technical specifications were met. It does not imply that Industry Canada approved the equipment.

NOTICE: The Ringer Equivalence Number (REN) for this terminal equipment is marked on the equipment itself. The REN assigned to each terminal equipment provides an indication of the maximum number of terminals allowed to be connected to a telephone interface. The termination on an interface may consist of any combination of devices subject only to the requirement that the sum of the Ringer Equivalence Numbers of all the devices does not exceed five.

RADIO EQUIPMENT

The term "IC:" before the radio certification number only signifies that Industry Canada technical specifications were met.

Operation is subject to the following two conditions: (1) this device may not cause interference, and (2) this device must accept any interference, including interference that may cause undesired operation of the device. "Privacy of communications may not be ensured when using this telephone".

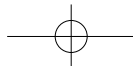

Index

A

AC adapter information 44
 Adjusting ringer and earpiece volume..... 19

B

Battery pack
 Information 44
 Install 9
 Maintenance 11, 40
 Preparing and charging 12
 Replacement and handling 40
 Beltclip installation 39

C

Caller ID
 Caller ID service 33
 Call Waiting 21
 Deleting 35
 Setting Caller ID options 15
 Using 37
 Viewing..... 34
 Channel 21
 Connection 12

D

Dial mode..... 16
 Digital security code 39

E, F, G

Earpiece volume..... 19
 General information 44

H

Headset installation 39

I, J, K, L

I.C. Notice 47

[48] ADDITIONAL INFORMATION

Interference 46
 Language 17

M, N, O

Maintenance 40
 Making a call 18
 Memory dialing
 Editing a stored name
 and/or phone number 28
 Erasing a stored name
 and phone number..... 30
 Making calls with memory dialing..... 26
 Storing phone
 numbers and names 23
 Mounting on a wall 13

P, Q

Package contents..... 3
 Paging 21
 Precautions..... 45
 Quick reference guide 3

R

Receiving a call..... 18
 Redialing a call 18, 20
 Ringer tone and volume 19
 RocketDial 31

S

Setting menu options 15
 Setting up the handset..... 9
 Setting up the phone 8

T, U, V, W, X, Y, Z

Technical information 44
 Troubleshooting..... 41
 Voice mail waiting indicator..... 22
 Warranty 46

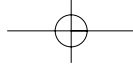

MEMO

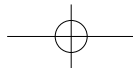
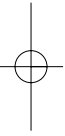

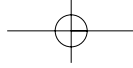

MEMO

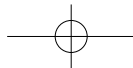
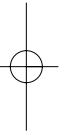
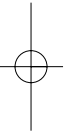

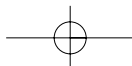

At Uniden, we'll take care of you!

If you need any assistance with this product, please call our Customer Hotline at **1-800-297-1023**

or visit our web site at **www.uniden.com**

PLEASE DO NOT RETURN THIS PRODUCT TO THE PLACE OF PURCHASE.

Our Uniden representatives will be happy to help you with any matters regarding the operation of this unit, available accessories, or any other related matters.

Thank you for purchasing a Uniden product.
Hours: M-F 8:00 AM to 5:00 PM CST.



For information on the accessibility features of this product, please call
1-800-874-9314 (V/TTY)

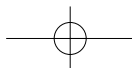

A World Without Wires® **Uniden®**

PACKAGE INCLUDES: Cordless Phone, Belt Clip, Rechargeable Battery, AC Adapter, Telephone Cord and Printed Materials.

©2003 Uniden America Corporation, Fort Worth, Texas. All rights reserved.
Contains additional foreign articles. Custom manufactured in China.

May be covered under one or more of the following U.S. patents:

4,523,058	4,595,795	4,797,916	5,381,460	5,426,690
5,434,905	5,491,745	5,493,605	5,533,010	5,574,727
5,581,598	5,650,790	5,660,269	5,661,780	5,663,981
5,671,248	5,696,471	5,717,312	5,732,355	5,754,407
5,758,289	5,786,345	5,787,355	5,794,152	5,801,466
5,825,161	5,864,619	5,893,034	5,912,968	5,915,227
5,929,599	5,930,720	5,980,359	5,987,330	6,044,261
6,070,082	6,125,277	6,253,088	6,314,278	

UCZZ01002BZ