

# BCT15X

- [Important information](#)
  - [General Precautions](#)
  - [Quick Start](#)
  - [Feature List](#)
  - [Specifications](#)
  - [FCC Information](#)
  - [Warranty and Support Information](#)
  - [User Guide Information](#)
- [Operation overview](#)
- [Setting up the hardware](#)
- [Programming your scanner](#)
- [Operating your scanner](#)



## Important information

For general information about using a scanner, including how to program the various types of radio systems into your scanner, we suggest you start with the [General Users Guide](#) page.

### [General Precautions](#)

### **Quick Start**

[Using Preloaded Systems](#)

### [Feature List](#)

### **Specifications**

- [Hardware specifications](#)
- "BCT15X -- The Complete Guide" is coming soon.

### [FCC Information](#)

### [Warranty and Support Information](#)

### [User Guide Information](#)

## Operation overview

- [Available operation modes](#)
- [Menu reference](#)
- [Keys and their functions](#)
- [Reading the display](#)

## Setting up the hardware

- [Included with the scanner](#)
- [Connecting the antenna](#)
- [Connecting a GPS receiver](#)

## Programming your scanner

- [Setting up systems](#)
- [Programming Number Tags](#)
- [Programming Quick Keys](#)
- [Programming Search Keys](#)
- [Programming locations](#)
- [Setting alerts](#)

## Operating your scanner

- [Using Number Tags](#)
- [State-by-State Scanning](#)
- [BearTracker Warning System](#)
- [Using Quick Keys, Startup Keys, and Search Keys](#)
- [Using Tone Out mode](#)
- [Using Close Call mode](#)
- [Using Band Scope mode](#)
- [Using GPS mode](#)

---

This page applies to the following scanner(s): [BCT15X Users Guide](#)

## [Conventional Systems](#)

Please note that these pages are meant as general instructions. While most of the information here applies to all scanners, some options may not be available on certain scanner models. Model-specific options are indicated in the text.

Since a conventional system is really a collection of frequencies, the first thing you need to know is the frequency for each channel you want to program. Here is an example of a conventional system frequency list from [RadioReference](#):

Frequency	Input	License	Type	Tone	Alpha Tag	Description	Mode	Tag
146.94000	146.34000	<a href="#">KSFTW-R</a>	RM	110.9 PL	TC RACES Pri	Tarrant County RACES/Skywarn Primary	FM	Ham
146.76000	146.16000	<a href="#">KSFTW-R</a>	RM	110.9 PL	TC RACES B/U	Tarrant County RACES/Skywarn Backup	FM	Ham
444.10000	449.10000	<a href="#">KSFTW-R</a>	RM	110.9 PL	TC RACES Adm	Tarrant County Backup / Admin / Secondary Net Freq.	FM	Ham
224.94000	223.34000	<a href="#">KSFTW-R</a>	RM	110.9 PL	TC RACES Int	Tarrant County Admin Freq. / WX Service Intercom Freq.	FM	Ham

Conventional System

- Here is a [conceptual layout diagram](#) of a basic conventional system. ([Click here](#) for a legend of the diagram.)
- You can download a planning worksheet for conventional systems as a [pdf file](#) or an [Excel spreadsheet file](#).
- [Programming a Conventional System](#)
  - [Create a system](#)
    - [System properties](#)
  - [Create at least 1 channel group](#)
    - [Channel group properties](#)
  - [Create at least 1 channel in each group](#)
    - [Channel properties](#)

## Programming a Conventional System

To program a conventional system, you'll need to program the required elements in following order ([click here for information on using the menu](#)):

### Create a system

1. Go to the [Program System](#) menu and choose *New System* .
2. The scanner will prompt you for the System Type. Select *Conventional* .
3. When the scanner prompts you confirm, tap **YES** .
4. The scanner creates the system with a default name. Select [Edit Name](#) if you want to change it.
5. If you need to change any of the system properties, you can do that now. Unless a property is *Required* , you can operate the system without changing the default settings.

### System properties

All of these options can be found under your scanner's [Program System](#) menu. If necessary, the sub-menu and option name on each scanner are listed beside the property.

Property	Option name
<b>Required</b>	
None	
<b>Recommended</b>	
Name	<a href="#">Edit Name</a>
Number tag	<a href="#">Set Number Tag</a>
Quick key	<a href="#">Set Quick Key</a>
<b>Optional</b>	
Record Flag	BCD996XT and <a href="#">BCT15X</a> : <a href="#">Set Record</a> BCD396XT and <a href="#">BC346XT</a> : Not available
Automatic Gain Control (AGC)	BCD396XT and <a href="#">BCD996XT</a> : <a href="#">Set Audio AGC</a> BC346XT and <a href="#">BCT15X</a> : Not available
Set State	BCT15X: <a href="#">Set State</a> Other Models: Not available
Delay time	<a href="#">Set Delay Time</a>
Hold time	<a href="#">Set Hold Time</a>
Lockout	<a href="#">Set Lockout</a>
P25 wait time	BCD396XT and <a href="#">BCD996XT</a> : <a href="#">P25 Waiting Time</a> BC346XT and <a href="#">BCT15X</a> : Not available
Startup key	<a href="#">Set Startup Key</a>
<b>Available operations</b>	
Copy a system	<a href="#">Copy System</a>
Delete a system	<a href="#">Delete System</a>

## Create at least 1 channel group

Each conventional system can contain up to 20 channel groups, and all systems must contain at least 1 channel group.

1. On the [Program System](#) menu, select the system you just created.
2. Go to the [Edit Group](#) menu and select *New Group* .
3. If you need to change any of the channel group properties, you can do that now. Unless a property is *Required* , you can operate the system without changing the default settings.

## Channel group properties

All of these options can be found by selecting the group name under your scanner's [Edit Group](#) menu. If necessary, the sub-menu and option name on each scanner are listed beside the property.

Property	Option name
<b>Required</b>	
None	
<b>Recommended</b>	
Name	<a href="#">Edit Name</a>
Quick key	<a href="#">Set Quick Key</a>
<b>Optional</b>	
Location information	<a href="#">Set Location Info</a>
Lockout	<a href="#">Set Lockout</a>
<b>Available operations</b>	
Delete a group	<a href="#">Delete Group</a>

## Create at least 1 channel in each group

Each conventional system can contain up to 1000 channels in each group, and all groups must contain at least 1 channel.

1. On the [Edit Group](#) menu, select the channel group you just created.
2. Go to the [Edit Channel](#) menu and select *New Channel* .
3. Input the frequency for this channel in MHz.
4. If you need to change any of the channel properties, you can do that now. Unless a property is *Required* , you can operate the system without changing the default settings.

## Channel properties

(All of these options can be found by selecting the channel name your scanner's [Edit Channel](#) menu. If necessary, the sub-menu and the exact option name are listed beside each property.)

Property	Option name
<b>Required</b>	
Frequency	<a href="#">Edit Frequency</a>
<b>Recommended</b>	
Analog/digital	BCD396XT and <a href="#">BCD996XT</a> : <a href="#">Set Audio Type</a> BC346XT and <a href="#">BCT15X</a> : Not available
• CTCSS/DCS	<a href="#">Set CTCSS/DCS</a> ( <a href="#">BCD396XT</a> : analog channels only)

<ul style="list-style-type: none"> <li>• P25 Network Address (NAC)</li> </ul>	BCD396XT and <a href="#">BCD996XT: P25 NAC Option</a> (digital channels only)  BC346XT and <a href="#">BCT15X</a> : Not available
Modulation	<a href="#">Set Modulation</a>
Name	<a href="#">Edit Name</a>
Number tag	<a href="#">Set Number Tag</a>
<b>Optional</b>	
Alert	<a href="#">Set Alert</a>
Record	BCD996XT and BCT15: <a href="#">Set Record</a> BCD396XT and <a href="#">BC346XT</a> : Not available.
Attenuator	<a href="#">Set Attenuator</a>
Lockout	<a href="#">Set Lockout</a>
Priority	<a href="#">Set Priority</a>
Volume Offset	<a href="#">Volume Offset</a>
<b>Available operations</b>	
Copy a channel	<a href="#">Copy Channel</a>
Delete a channel	<a href="#">Delete Channel</a>

This page applies to the following scanner(s): [BCD996XT](#) [BCT15X](#) [BCD396XT](#) [BC346XT](#)  
[UsersGuide](#)

## EDACS SCAT Systems

Please note that these pages are meant as general instructions. While most of the information here applies to all scanners, some options may not be available on certain scanner models. Model-specific options are indicated in the text.

This section deals with EDACS SCAT systems. [Click here for information on EDACS Wide and Narrow systems.](#) Below is an example of an EDACS SCAT system from [RadioReference](#):

<b>System Name:</b>	Medley City Public Safety
<b>Location:</b>	Medley, FL
<b>County:</b>	Dade
<b>System Type:</b>	EDACS SCAT
<b>System Voice:</b>	Analog
<b>Last Updated:</b>	<i>Updated Function Tag assignments for 1 talkgroups</i>
<b>Hits:</b>	1742

### System Frequencies

Red (c) are Primary Control Channels | Blue (a) are alternate control channels | Click a Site Name for additional site information | Site Map: [FCC Callsigns](#) [RR Locations](#)

Site Name
000 <a href="#">Police</a> 01 <a href="#">855.13750c</a>

### System Talkgroups

Updated in the last 7 days
  Updated in the last 24 hours
 [List All](#) in one table
 [Show New](#) Talkgroups

#### POLICE Talkgroups ▶

DEC	AFS	Mode	Alpha Tag	Description	Tag
100	00-124	A	DISPATCH	Police Dispatch	Law Dispatch

150 px

And here is a [conceptual layout diagram](#) of a basic EDACS SCAT system. ([Click here](#) for a legend of the diagram.)

- [Programming an EDACS SCAT System](#)
  - [Create a system](#)
    - [System properties](#)
  - [Create a site](#)
    - [Site properties](#)
  - [Create at least 1 frequency](#)
    - [Frequency properties](#)

## Programming an EDACS SCAT System

To program an EDACS SCAT system, you'll need to program the required elements in following order ([click here for information on using the menu](#)):

### Create a system

1. Go to the [Program System](#) menu and choose *New System* .
2. The scanner will prompt you for the System Type. Select *EDCS* .
3. The scanner will prompt you for the sub-type. Select *SCAT* .
4. When the scanner prompts you confirm, tap **YES** .
5. The scanner creates the system with a default name. Select [Edit Name](#) if you want to change it.
6. If you need to change any of the system properties, you can do that now. Unless a property is *Required* , you can operate the system without changing the default settings.

### System properties

All of these options can be found under your scanner's [Program System](#) menu. If necessary, the sub-menu and option name on each scanner are listed beside the property.

Property	Option name
	<b>Required</b>
None	
	<b>Recommended</b>

Name	<a href="#">Edit Name</a>
Number tag	<a href="#">Set Number Tag</a>
<b>Optional</b>	
Record	BCD996XT or <a href="#">BCT15X: Set Record</a> BCD396XT or <a href="#">BC346XT</a> : Not available
Automatic Gain Control (AGC)	BCD396XT or <a href="#">BCD996XT: Set Audio AGC</a> BC346XT or BCT15: Not available
Delay time	<a href="#">Set Delay Time</a>
<b>Available operations</b>	
Copy a system	<a href="#">Copy System</a>
Delete a system	<a href="#">Delete System</a>

## Create a site

Each EDACS SCAT system must contain exactly 1 site.

1. On the [Program System](#) menu, select the system you just created.
2. Go to the [Edit Site](#) menu.
3. If you need to change any of the site properties, you can do that now. Unless a property is *Required*, you can operate the system without changing the default settings.

## Site properties

All of these options can be found under your scanner's [Edit Site](#) menu. If necessary, the sub-menu and option name on each scanner are listed beside the property.

Property	Option name
<b>Required</b>	
None	
<b>Recommended</b>	
Quick key	<a href="#">Set Quick Key</a>
<b>Optional</b>	
Attenuator	<a href="#">Set Attenuator</a>
Hold time	<a href="#">Set Hold Time</a>
Location information	<a href="#">Set Location Info</a>
Set State	BCT15X: <a href="#">Set State</a> Other Models: Not available
Lockout	<a href="#">Set Lockout</a>
Modulation	<a href="#">Set Modulation</a>
Startup key	<a href="#">Set Startup Key</a>
<b>Available operations</b>	
None	

## Create at least 1 frequency

Each EDACS SCAT system must contain at least 1 frequency in its site.

1. Open the [Edit Site](#) menu.
2. Go to the [Set Frequencies](#) sub-menu and select *New Frequency*.
3. Enter at least 1 frequency for this site.
4. If you need to change any of the frequency properties, you can do that now. Unless a property is *Required*, you can operate the system without changing the default settings.

## Frequency properties



All of these options can be found by selecting the frequency under the [Set Frequencies](#) sub-menu. If necessary, the sub-menu and option name on each scanner are listed beside the property.

Property	Option name
<b>Required</b>	
None	
<b>Recommended</b>	
Number tag	<a href="#">Set Number Tag</a>
<b>Optional</b>	
Record	BCD996XT or BCT15X: <a href="#">Set Record</a> BCD396XT or BC346XT: Not available.
Volume Offset	<a href="#">Volume Offset</a>
Lockout	<a href="#">Set Lockout</a>
<b>Available operations</b>	
Delete a frequency	<a href="#">Delete Frequency</a>

This page applies to the following scanner(s): [BCD996XT](#) [BCT15X](#) [BCD396XT](#) [BC346XT](#) [Users Guide](#)

# EDACS Trunked Systems

Please note that these pages are meant as general instructions. While most of the information here applies to all scanners, some options may not be available on certain scanner models. Model-specific options are indicated in the text.

This section deals with EDACS Wide or standard systems. [Click here for information on EDACS SCAT systems](#). This includes EDACS systems that use ESK. No special setting is needed to enable ESK tracking on an EDACS system. Note that the scanner cannot decode EDACS ProVoice. Below is an example of an EDACS trunked system from [RadioReference](#):

<b>System Name:</b>	Irving Public Safety System
<b>Location:</b>	Irving, TX
<b>County:</b>	Dallas
<b>System Type:</b>	EDACS Standard
<b>System Voice:</b>	Analog
<b>Last Updated:</b>	11-08-2007 03:40

System Frequencies		<small>Red* are Primary Control Channels      Blue* are Secondary Control Channels</small>							
Site	Description								
001	Primary	01-868.53750*	02-868.08750	03-868.58750	04-855.46250	05-868.63750	06-857.21250	07-868.73750	
		08-868.83750	09-866.58750	10-868.91250					

EDACS Wide System

- Here is a [conceptual layout diagram](#) of a basic EDACS Wide system. ([Click here](#) for a legend of the diagram.)
- You can download a planning worksheet for EDACS systems as a [pdf file](#) or an [Excel spreadsheet file](#).
- [Programming an EDACS System](#)
  - [Create a system](#)
    - [System properties](#)
  - [Create at least 1 site](#)
    - [Site properties](#)
  - [Create at least 1 frequency in each site](#)
    - [Frequency properties](#)
- [Programming a system for Scanning](#)
  - [Create at least 1 channel group](#)
    - [Channel group properties](#)
  - [Create at least 1 channel in each group](#)

- [Channel properties](#)

## Programming an EDACS System

To program an EDACS system, you'll need to program the required elements in following order ([click here for information on using the menu](#)):

### Create a system

1. Go to the [Program System](#) menu and choose *New System* .
2. The scanner will prompt you for the System Type. Select *EDCS* .
3. The scanner will prompt you for the sub-type. Select *Wide/Narrow* .
4. When the scanner prompts you confirm, tap **YES** .
5. The scanner creates the system with a default name. Select [Edit Name](#) if you want to change it.
6. If you need to change any of the system properties, you can do that now. Unless a property is *Required* , you can operate the system without changing the default settings.

### System properties

All of these options can be found under your scanner's [Program System](#) menu. If necessary, the sub-menu and option name on each scanner are listed beside the property.

Property	Option name
<b>Required</b>	
None	
<b>Recommended</b>	
Name	<a href="#">Edit Name</a>
Number tag	<a href="#">Set Number Tag</a>
<b>Optional</b>	
Automatic Gain Control (AGC)	BCD396XT and <a href="#">BCD996XT</a> : <a href="#">Set Audio AGC</a> BC346XT and <a href="#">BCT15X</a> : Not available
Record	BCD996XT and <a href="#">BCT15X</a> : <a href="#">Set Record</a> BCD396XT and <a href="#">BC346XT</a> : Not available
Delay time	<a href="#">Set Delay Time</a>

Emergency alert	<a href="#">Emergency Alert</a>
ID format	<a href="#">Set ID Format (AFS) or (DEC)</a>
ID scan/search	<a href="#">ID Scan/Search</a>
Priority ID scan	<a href="#">Priority ID scan</a>
<b>Available operations</b>	
Copy a system	<a href="#">Copy System</a>
Delete a system	<a href="#">Delete System</a>
Review locked-out IDs	<a href="#">Rvw ID:Srch L/O</a>
Clear all locked-out IDs	<a href="#">Clr All L/O IDs</a>

## Create at least 1 site

Each EDACS system can contain up to 256 sites, and all systems must contain at least 1 site.

1. On the [Program System](#) menu, select the system you just created.
2. Go to the [Edit Site](#) menu and select *New Site* .
3. If you need to change any of the site properties, you can do that now. Unless a property is *Required* , you can operate the system without changing the default settings.

## Site properties

All of these options can be found under your scanner's [Edit Site](#) menu. If necessary, the sub-menu and option name on each scanner are listed beside the property.

Property	Option name
<b>Required</b>	
Site type	<a href="#">Set Site Type</a>
<b>Recommended</b>	
Name	<a href="#">Edit Name</a>
Quick key	<a href="#">Set Quick Key</a>

<b>Optional</b>	
Attenuator	<a href="#">Set Attenuator</a>
Hold time	<a href="#">Set Hold Time</a>
Location information	<a href="#">Set Location Info</a>
State	BCT15X: <a href="#">Set State</a> Other Models: Not available
Lockout	<a href="#">Set Lockout</a>
Modulation	<a href="#">Set Modulation</a>
Startup key	<a href="#">Set Startup Key</a>
<b>Available operations</b>	
Delete a site	<a href="#">Delete Site</a>

## Create at least 1 frequency in each site

Each trunked system can contain up to 30 frequencies in each site, and all sites must contain at least 1 frequency.

1. On the [Edit Site](#) menu, select the site you just created.
2. Go to the [Set Frequencies](#) sub-menu and select *New Frequency* .
3. Enter at least 1 frequency for this site.
4. When you enter a new frequency, the scanner will prompt you for the [logical channel number or LCN](#) for that frequency. Enter a number from 1 through 30.
5. If you need to change any of the frequency properties, you can do that now. Unless a property is *Required* , you can operate the system without changing the default settings.

## Frequency properties

All of these options can be found by selecting the frequency under the [Set Frequencies](#) sub-menu. If necessary, the sub-menu and option name on each scanner are listed beside the property.

Property	Option name
<b>Required</b>	

Logical channel number	<a href="#">Input LCN</a>
<b>Recommended</b>	
None	
<b>Optional</b>	
Lockout	<a href="#">Set Lockout</a>
<b>Available operations</b>	
Delete a frequency	<a href="#">Delete Frequency</a>

## Programming a system for Scanning

Once you create the system and at least 1 site, you can [Search](#) the system with no problems. However, if you want to [Scan](#) the system, you'll need to program the required elements in following order ([click here for information on using the menu](#)):

### Create at least 1 channel group

Each EDACS system can contain up to 20 channel groups, and any system you want to scan must contain at least 1 channel group.

1. On the [Program System](#) menu, select the system you just created.
2. Go to the [Edit Group](#) menu and select *New Group* .
3. If you need to change any of the channel group properties, you can do that now. Unless a property is *Required* , you can operate the system without changing the default settings.

### Channel group properties

All of these options can be found by selecting the group name under your scanner's [Edit Group](#) menu. If necessary, the sub-menu and option name on each scanner are listed beside the property.

Property	Option name
<b>Required</b>	
None	

Recommended	
Name	<a href="#">Edit Name</a>
Quick key	<a href="#">Set Quick Key</a>
Optional	
Location information	<a href="#">Set Location Info</a>
Lockout	<a href="#">Set Lockout</a>
Available operations	
Delete a group	<a href="#">Delete Group</a>

## Create at least 1 channel in each group

Each trunked system can contain up to 500 channels.

1. On the [Edit Group](#) menu, select the channel group you just created.
2. Go to the [Edit Channel](#) menu and select *New Channel* .
3. Input the [Talk Group ID \(TGID\)](#) for this channel.
4. If you need to change any of the channel properties, you can do that now. Unless a property is *Required* , you can operate the system without changing the default settings.

## Channel properties

All of these options can be found by selecting the channel name your scanner's [Edit Channel](#) menu. If necessary, the sub-menu and option name on each scanner are listed beside the property.

Property	Option name
Required	
TGID	<a href="#">Edit Talk Group ID</a>
Recommended	
Name	<a href="#">Edit Name</a>
Number tag	<a href="#">Set Number Tag</a>

<b>Optional</b>	
Record	BCD996XT and <a href="#">BCT15X: Set Record</a> BCD396XT and <a href="#">BC346XT</a> : Not available.
Alert	<a href="#">Set Alert</a>
Lockout	<a href="#">Set Lockout</a>
Priority	<a href="#">Set Priority</a>
Volume Offset	<a href="#">Volume Offset</a>
<b>Available operations</b>	
Copy a channel	<a href="#">Copy Channel</a>
Delete a channel	<a href="#">Delete Channel</a>

This page applies to the following scanner(s): [BCD996XT](#) [BCT15X](#) [BCD396XT](#) [BC346XT](#)  
[UsersGuide](#)



# LTR Trunked Systems

Please note that these pages are meant as general instructions. While most of the information here applies to all scanners, some options may not be available on certain scanner models. Model-specific options are indicated in the text.

Below is an example of a Logic Trunked Radio or *LTR* system from [RadioReference](#):

<b>System Name:</b>	American Airlines Center System							
<b>Location:</b>	Dallas, TX							
<b>County:</b>	Dallas							
<b>System Type:</b>	LTR Standard							
<b>System Voice:</b>	Analog							
<b>Last Updated:</b>	08-15-2004 21:23							
<b>System Frequencies</b>								
Site	Description							
001	Site-1	01-461.50000	02-N/A	03-461.70000	04-N/A	05-462.17500	06-N/A	07-463.87500
		08-N/A	09-N/A	10-N/A	11-464.40000	12-N/A	13-N/A	14-463.33750
		15-N/A	16-464.08750	17-N/A	18-464.18750			

LTR System

- Here is a [conceptual layout diagram](#) of a basic LTR system. ([Click here](#) for a legend of the diagram.)
- You can download a planning worksheet for LTR systems as a [pdf file](#) or an [Excel spreadsheet file](#).
- For more information on the different types of LTR systems and how they work, see the [Logic Trunked Radio](#) page at [Radio Reference's Wiki](#).
- [Programming an LTR System](#)
  - [Create a system](#)
    - [System properties](#)
  - [Create at least 1 site](#)
    - [Site properties](#)
  - [Create at least 1 frequency in each site](#)
    - [Frequency properties](#)
- [Programming a system for Scanning](#)
  - [Create a channel group](#)
    - [Channel group properties](#)
  - [Create a channel in each group](#)

- [Channel properties](#)

## Programming an LTR System

To program an LTR system, you'll need to program the required elements in following order ([click here for information on using the menu](#)):

### Create a system

1. Go to the [Program System](#) menu and choose *New System* .
2. The scanner will prompt you for the System Type. Select *LT* .
3. When the scanner prompts you confirm, tap **YES** .
4. The scanner creates the system with a default name. Select [Edit Name](#) if you want to change it.
5. If you need to change any of the system properties, you can do that now. Unless a property is *Required* , you can operate the system without changing the default settings.

### System properties

All of these options can be found under your scanner's [Program System](#) menu. If necessary, the sub-menu and option name on each scanner are listed beside the property.

Property	Option name
<b>Required</b>	
None	
<b>Recommended</b>	
Name	<a href="#">Edit Name</a>
Number tag	<a href="#">Set Number Tag</a>
<b>Optional</b>	
Automatic Gain Control (AGC)	BCD396XT and <a href="#">BCD996XT</a> : <a href="#">Set Audio AGC</a>
	BC346XT and <a href="#">BCT15X</a> : Not available
Record Out	BCD996XT and <a href="#">BCT15X</a> : <a href="#">Set Record</a>
	BCD396XT and <a href="#">BC346XT</a> : Not available

Delay time	<a href="#">Set Delay Time</a>
ID scan/search	<a href="#">ID Scan/Search</a>
Priority ID scan	<a href="#">Priority ID scan</a>
<b>Available operations</b>	
Copy a system	<a href="#">Copy System</a>
Delete a system	<a href="#">Delete System</a>
Review locked-out IDs	<a href="#">Rvw ID:Srch L/O</a>
Clear all locked-out IDs	<a href="#">Clr All L/O IDs</a>

## Create at least 1 site

Each LTR system can contain up to 256 sites, and all systems must contain at least 1 site.

1. On the [Program System](#) menu, select the system you just created.
2. Go to the [Edit Site](#) menu and select *New Site*.
3. If you need to change any of the site properties, you can do that now. Unless a property is *Required*, you can operate the system without changing the default settings.

## Site properties

All of these options can be found under your scanner's [Edit Site](#) menu. If necessary, the sub-menu and option name on each scanner are listed beside the property.

Property	Option name
<b>Required</b>	
None	
<b>Recommended</b>	
Name	<a href="#">Edit Name</a>
Quick key	<a href="#">Set Quick Key</a>
<b>Optional</b>	

Attenuator	<a href="#">Set Attenuator</a>
Hold time	<a href="#">Set Hold Time</a>
Location information	<a href="#">Set Location Info</a>
State	BCT15X: <a href="#">Set State</a> Other Models: Not available
Lockout	<a href="#">Set Lockout</a>
Modulation	<a href="#">Set Modulation</a>
Startup key	<a href="#">Set Startup Key</a>
<b>Available operations</b>	
Delete a site	<a href="#">Delete Site</a>

## Create at least 1 frequency in each site

Each LTR system can contain up to 20 frequencies in each site, and all sites must contain at least 1 frequency.

1. On the [Edit Site](#) menu, select the site you just created.
2. Go to the [Set Frequencies](#) sub-menu and select *New Frequency* .
3. Enter at least 1 frequency for this site.
4. When you enter a new frequency, the scanner will prompt you for the [logical channel number or LCN](#) for that frequency. Enter a number from 1 through 20.
5. If you need to change any of the frequency properties, you can do that now. Unless a property is *Required* , you can operate the system without changing the default settings.

## Frequency properties

All of these options can be found by selecting the frequency under the [Set Frequencies](#) sub-menu. If necessary, the sub-menu and option name on each scanner are listed beside the property.

Property	Option name
<b>Required</b>	
Logical channel number	<a href="#">Input LCN</a>

<b>Recommended</b>	
None	
<b>Optional</b>	
Lockout	<a href="#">Set Lockout</a>
<b>Available operations</b>	
Delete a frequency	<a href="#">Delete Frequency</a>

## Programming a system for Scanning

Once you create the system and at least 1 site, you can [Search](#) the system with no problems. However, if you want to [Scan](#) the system, you'll need to program the required elements in following order ([click here for information on using the menu](#)):

### Create a channel group

Each LTR system can contain up to 20 channel groups.

1. On the [Program System](#) menu, select the system you just created.
2. Go to the [Edit Group](#) menu and select *New Group* .
3. If you need to change any of the channel group properties, you can do that now. Unless a property is *Required* , you can operate the system without changing the default settings.

### Channel group properties

All of these options can be found by selecting the group name under your scanner's [Edit Group](#) menu. If necessary, the sub-menu and option name on each scanner are listed beside the property.

Property	Option name
<b>Required</b>	
None	
<b>Recommended</b>	
Name	<a href="#">Edit Name</a>

Quick key	<a href="#">Set Quick Key</a>
<b>Optional</b>	
Location information	<a href="#">Set Location Info</a>
Lockout	<a href="#">Set Lockout</a>
<b>Available operations</b>	
Delete a group	<a href="#">Delete Group</a>

## Create a channel in each group

Each trunked system can contain up to 500 channels.

1. On the [Edit Group](#) menu, select the channel group you just created.
2. Go to the [Edit Channel](#) menu and select *New Channel* .
3. Input the [Talk Group ID \(TGID\)](#) for this channel.
4. If you need to change any of the channel properties, you can do that now. Unless a property is *Required* , you can operate the system without changing the default settings.

## Channel properties

All of these options can be found by selecting the channel name your scanner's [Edit Channel](#) menu. If necessary, the sub-menu and option name on each scanner are listed beside the property.

Property	Option name
<b>Required</b>	
TGID	<a href="#">Edit Talk Group ID</a>
<b>Recommended</b>	
Name	<a href="#">Edit Name</a>
Number tag	<a href="#">Set Number Tag</a>
<b>Optional</b>	
Alert	<a href="#">Set Alert</a>

Record Out	BCD996XT and <a href="#">BCT15X</a> : <a href="#">Set Record</a>
	BCD396XT and <a href="#">BC346XT</a> : Not available
Lockout	<a href="#">Set Lockout</a>
Priority	<a href="#">Set Priority</a>
Volume Offset	<a href="#">Volume Offset</a>
<b>Available operations</b>	
Copy a channel	<a href="#">Copy Channel</a>
Delete a channel	<a href="#">Delete Channel</a>

This page applies to the following scanner(s): [BCD996XT](#) [BCT15X](#) [BCD396XT](#) [BC346XT](#) [Users Guide](#)

# Motorola Trunked Systems

Please note that these pages are meant as general instructions. While most of the information here applies to all scanners, some options may not be available on certain scanner models. Model-specific options are indicated in the text.

A Motorola system can be an 800 MHz, 400 MHz (UHF), or 100-200 MHz (VHF) system. Below are some examples of these Motorola systems from [RadioReference](#):

<b>System Name:</b>	Grand Prairie System
<b>Location:</b>	Grand Prairie, TX
<b>County:</b>	Dallas
<b>System Type:</b>	Motorola Type II SmartZone
<b>System Voice:</b>	Analog and APCO-25 Common Air Interface
<b>Last Updated:</b>	06-19-2006 16:37

System ID Table		
Sysid	CT	WACN
2515	105.88	

**System Frequencies**  
Red\* are Primary Control Channels     Blue\* are Secondary Control Channels

Site	Description	Freqs								
001	Primary	858.96250	857.96250*	858.96250*	859.96250*	860.96250*	868.23750	868.51250	868.76250	868.96250

Motorola 800 MHz System

<b>System Name:</b>	Arlington System
<b>Location:</b>	Arlington, TX
<b>County:</b>	Tarrant
<b>System Type:</b>	Motorola Type II Smartnet
<b>System Voice:</b>	Analog
<b>Last Updated:</b>	09-12-2006 14:37

System ID Table		
Sysid	CT	WACN
162A	105.88	

**System Frequencies**  
Red\* are Primary Control Channels     Blue\* are Secondary Control Channels

Site	Description	Freqs								
001	Primary	856.48750	856.71250	857.48750	857.71250*	858.48750	858.71250*	859.48750	859.71250*	860.48750
		860.71250*	867.56250	868.26250						

Another Motorola 800 MHz System



- Even though some (or all) of the System Voice channels are APCO 25, this system, and others like it, is correctly programmed as a Motorola 800 MHz system, per the information given for the System Type.

<b>System Name:</b>	United Parcel Service (DFW Airport) System		
<b>Location:</b>	DFW Airport, TX		
<b>County:</b>	2 counties		
<b>System Type:</b>	Motorola Type II Smartnet		
<b>System Voice:</b>	Analog		
<b>Last Updated:</b>	06-04-2007 18:42		

Sysid	CT	WACN
7507	116.13	

Base	Spacing	Offset
461.5000	300	12.5
451.0000	560	12.5

---

**System Frequencies**  
Red\* are Primary Control Channels     Blue\* are Secondary Control Channels

Site	Description	Freqs								
001	Primary	451.31250	451.66250	451.88750	452.03750	452.53750	452.68750*	452.88750*	462.18750*	462.48750*

Motorola UHF System (400 MHz band)

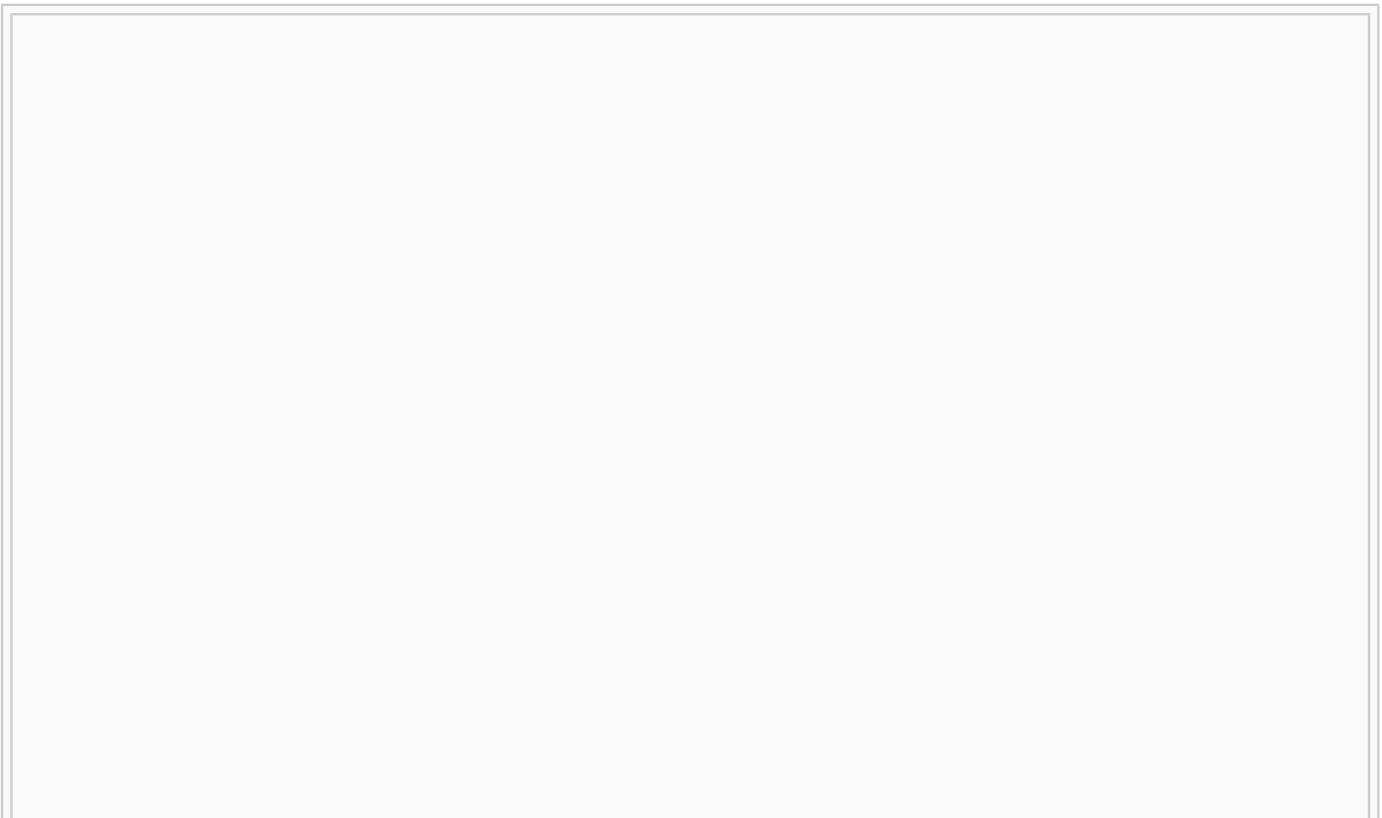

<b>System Name:</b>	Staffordshire Fire & Rescue System
<b>Location:</b>	Staffordshire, EN
<b>County:</b>	Staffordshire
<b>System Type:</b>	Motorola Type II Smartnet
<b>System Voice:</b>	Analog
<b>Last Updated:</b>	02-01-2008 11:17

Sysid	CT	WACN
1533		

Base	Spacing	Offset
152.0000	390	12.5
154.0000	461	12.5

### System Frequencies

**Red\*** are Primary Control Channels      **Blue\*** are Secondary Control Channels

Site	Description	Freqs								
001	North Simulcast	153.82500	154.08750	154.72500	154.88750	155.07500	155.30000	155.41250*	155.43750	155.56250
		155.61250								
002	South Simulcast	152.15000*	152.26250	152.31250	152.53750	152.82500	155.21250	155.52500	155.55000	155.87500
006	Site-6	152.83750	154.08750	154.72500	154.88750	155.07500	155.30000	155.41250*	155.43750	155.56250
		155.81250								
011	Site-11	152.02500*	154.57500	154.75000						

Motorola VHF System (100-200 MHz band)

- Here is a [conceptual layout diagram](#) of a basic Motorola system. ([Click here](#) for a legend of the diagram.)
- You can download a planning worksheet for Motorola systems as a [pdf file](#) or an [Excel spreadsheet file](#).
- For more information on the different types of Motorola systems and how they work, see the [Motorola](#) page at [Radio Reference's Wiki](#).
- [Programming a Motorola System](#)
  - [Create a system](#)
    - [System properties](#)
  - [Create at least 1 site](#)
    - [Site properties](#)
  - [Create at least 1 frequency in each site](#)
    - [Frequency properties](#)
- [Programming a system for Scanning](#)
  - [Create a channel group](#)
    - [Channel group properties](#)
  - [Create a channel](#)
    - [Channel properties](#)

# Programming a Motorola System

To program a Motorola system, you'll need to program the required elements in following order:

## Create a system

1. Go to the [Program System](#) menu and choose *New System* .
2. The scanner will prompt you for the System Type. Select *MOT* .
3. When the scanner prompts you confirm, tap **YES** .
4. The scanner creates the system with a default name. Select [Edit Name](#) if you want to change it.
5. If you need to change any of the system properties, you can do that now. Unless a property is *Required* , you can operate the system without changing the default settings.

## System properties

All of these options can be found under your scanner's [Program System](#) menu. If necessary, the sub-menu and option name on each scanner are listed beside the property.

Property	Option name
<b>Required</b>	
<b>Fleet map</b>	<a href="#">Edit Fleet Map</a> (Required for Motorola Type I or Type I/II Hybrid systems only)
<b>Recommended</b>	
<b>Name</b>	<a href="#">Edit Name</a>
<b>Number tag</b>	<a href="#">Set Number Tag</a>
<b>Optional</b>	
<b>Automatic Gain Control (AGC)</b>	BCD396XT and BCD996XT: <a href="#">Set Audio AGC</a> BC346XT and BCT15X: Not available
<b>Record</b>	BCD996XT and BCT15X: <a href="#">Set Record</a> BCD396XT and BC346XT: Not available
<b>Delay time</b>	<a href="#">Set Delay Time</a>
<b>Emergency alert</b>	<a href="#">Emergency Alert</a>
<b>ID format</b>	<a href="#">Set ID Format (DEC/HEX)</a>
<b>ID scan/search</b>	<a href="#">ID Scan/Search</a>
<b>Priority ID scan</b>	<a href="#">Priority ID scan</a>
<b>Status bit</b>	<a href="#">Set Status bit</a>
<b>Available operations</b>	
<b>Copy a system</b>	<a href="#">Copy System</a>
<b>Delete a system</b>	<a href="#">Delete System</a>

<b>Review locked-out IDs</b>	<a href="#">Rvw ID:Srch L/O</a>
<b>Clear all locked-out IDs</b>	<a href="#">Clr All L/O IDs</a>

## Create at least 1 site

Each Motorola system can contain up to 256 sites, and all systems must contain at least 1 site.

1. On the [Program System](#) menu, select the system you just created.
2. Go to the [Edit Site](#) menu and select *New Site* .
3. If you need to change any of the site properties, you can do that now. Unless a property is *Required* , you can operate the system without changing the default settings.

## Site properties

All of these options can be found under your scanner's [Edit Site](#) menu. If necessary, the sub-menu and option name on each scanner are listed beside the property.

Property	Option name
<b>Required</b>	
<b>Band plan</b>	<a href="#">Edit Band Plan</a>
<b>Recommended</b>	
<b>Name</b>	<a href="#">Edit Name</a>
<b>Quick key</b>	<a href="#">Set Quick Key</a>
<b>Optional</b>	
<b>Attenuator</b>	<a href="#">Set Attenuator</a>
<b>Hold time</b>	<a href="#">Set Hold Time</a>
<b>Location information</b>	<a href="#">Set LocationInfo</a>
<b>Lockout</b>	<a href="#">Set Lockout</a>
<b>Modulation</b>	<a href="#">Set Modulation</a>
<b>P25 wait time</b>	BCD396XT and BCD996XT: <a href="#">P25 Waiting Time</a> BC346XT and BCT15X: Not available
<b>Startup key</b>	<a href="#">Set Startup Key</a>
<b>Available operations</b>	
<b>Delete a site</b>	<a href="#">Delete Site</a>

## Create at least 1 frequency in each site

Each site must contain at least 1 frequency.

1. On the [Edit Site](#) menu, select the site you just created.
2. Go to the [Set Frequencies](#) sub-menu and select *New Frequency* .
3. Enter at least 1 frequency for this site.
4. If you need to change any of the frequency properties, you can do that now. Unless a property is *Required* , you can operate the system without changing the default settings.

## Frequency properties

All of these options can be found by selecting the frequency under the [Set Frequencies](#) sub-menu. If necessary, the sub-menu and option name on each scanner are listed beside the property.

Property	Option name
<b>Required</b>	
None	
<b>Recommended</b>	
None	
<b>Optional</b>	
Lockout	<a href="#">Set Lockout</a>
<b>Available operations</b>	
Delete a frequency	<a href="#">Delete Frequency</a>

## Programming a system for Scanning

Once you create the system and at least 1 site, you can scan the system in ID Search mode. In this mode, the scanner stops on all system traffic for talk groups you have not locked out. If you want to use ID Scan mode, you'll need to program channels into the system. In ID Scan, the scanner only stops on talk groups you have programmed into a channel.

### Create a channel group

Each Motorola system can contain up to 20 channel groups.

1. On the [Program System](#) menu, select the system you just created.
2. Go to the [Edit Group](#) menu and select *New Group* .
3. If you need to change any of the channel group properties, you can do that now. Unless a

property is *Required* , you can operate the system without changing the default settings.

## Channel group properties

(All of these options can be found by selecting the group name under the [Edit Group](#) menu. If necessary, the sub-menu and the exact option name are listed beside each property.)

<b>Required</b>	None
<b>Recommended</b>	Name ( <a href="#">Edit Name</a> )
	Quick key ( <a href="#">Set Quick Key</a> )
<b>Optional</b>	Location information ( <a href="#">Set LocationInfo</a> )
	Lockout ( <a href="#">Set Lockout</a> )
<b>Available operations</b>	<a href="#">Delete Group</a>

## Create a channel

Each trunked system can contain up to 500 channels.

1. On the [Edit Group](#) menu, select the channel group you just created.
2. Go to the [Edit Channel](#) menu and select *New Channel* .
3. Input the Talk Group ID (TGID) for this channel.
4. If you need to change any of the channel properties, you can do that now. Unless a property is *Required* , you can operate the system without changing the default settings.

## Channel properties

(All of these options can be found by selecting the channel name under the [Edit Channel](#) menu. If necessary, the sub-menu and the exact option name are listed beside each property.)

<b>Required</b>	TGID ( <a href="#">Edit Talk Group ID</a> )
<b>Recommended</b>	Audio type (Analog or digital) (BCD396XT and BCD996XT only) ( <a href="#">Set Audio Type</a> )
	Name ( <a href="#">Edit Name</a> )
	Number tag ( <a href="#">Set Number Tag</a> )

<b>Optional</b>	Alert ( <a href="#">Set Alert</a> )
	Record (BCD996XT and BCT15X: <a href="#">Set Record</a> ; BCD396XT and BC346XT: Not available)
	Lockout ( <a href="#">Set Lockout</a> )
	Priority ( <a href="#">Set Priority</a> )
	<a href="#">Volume Offset</a>
<b>Available operations</b>	<a href="#">Copy Channel</a>
	<a href="#">Delete Channel</a>

This page applies to the following scanner(s): [BCD996XT](#) [BCT15X](#) [BCD396XT](#) [BC346XT](#) [Users Guide](#)

# Radio Systems Overview

There are two basic types of radio systems: conventional systems and trunked systems.

- [Conventional radio systems](#)
- [Trunked radio systems](#)
  - [Trunked system basics](#)
  - [How a trunked system works](#)
  - [A real life example](#)

## Conventional radio systems

In a conventional radio system, each group of users is assigned one (for simplex systems) or two frequencies (for repeater systems). For example, the police in your area might operate on 460.500 MHz, the fire department on 154.445 MHz, the highway department on 37.900 MHz, etc. All transmissions from each group always go out on the on the same frequency--the police won't randomly switch to 500.000 MHz, for instance.

Since each group always stays on the same frequency and frequencies never overlap, it's very easy to follow conversations on conventional systems: when your scanner stops on a frequency, you usually know who it is, and more importantly, you can stop on a channel and listen to an entire conversation.

Up until the late 1980s, this was the primary way that radio systems operated. Some examples of conventional radio systems are

- Aircraft
- Amateur radio
- FRS/GMRS users
- Small, private radio systems

## Trunked radio systems

Several major trends have converged that have resulted in agencies moving to more efficient *trunked* radio systems:

- Higher levels of radio usage has meant that there aren't enough individual frequencies available to allow every group to have their own frequency.
- Technology advances have brought down the overall cost and complexity of implementing a trunked radio system while increasing the features available to the agency and individual radio users.
- Roll-out of major statewide trunked systems makes it easier for even small agencies to piggy back onto the larger system for less cost than replacing existing systems.

## Trunked system basics

There are three major elements common to most trunked systems:

### System Controller

The system controller is a special computer that assigns voice channels to users as they key up their radio. The controller is the brains behind the trunking system.

### Voice Frequency Pool

The voice frequency pool is a selection of radio frequencies available to the system controller for assigning voice traffic. By assigning voice frequencies to channels only as they are needed, a trunked system can support many more channels than it actually has frequencies.

### Talk Group IDs

A Talk Group ID identifies which user or agency has been assigned a particular voice frequency at any particular moment. The Talk Group ID is essentially the user's "channel": since each voice frequency is used over and over by all the agencies on the system, trunked systems rely on the Talk Group ID to identify which particular user or agency is talking.



## How a trunked system works

A typical communication on a trunked system goes something like this:

1. A user selects the channel they want to communicate on and presses the PTT button on the side of their radio.
2. This sends a channel request message to the controller that the user wants to start a transmission on the Talk Group ID (the channel) that they selected.
3. The controller locates an unused voice frequency and assigns it to that Talk Group ID.
4. The controller then sends out a *channel grant message* to all radios on the system so everyone knows where to find the voice channel for that Talk Group.
5. At this point, the original user's radio beeps, and the user can begin their transmission. While this sounds complicated, in real life this process takes about half a second (sometimes less).

When the user releases the PTT button, the controller releases the voice frequency from its Talk Group ID assignment, leaving the frequency free for the next user that becomes active.

## A real life example

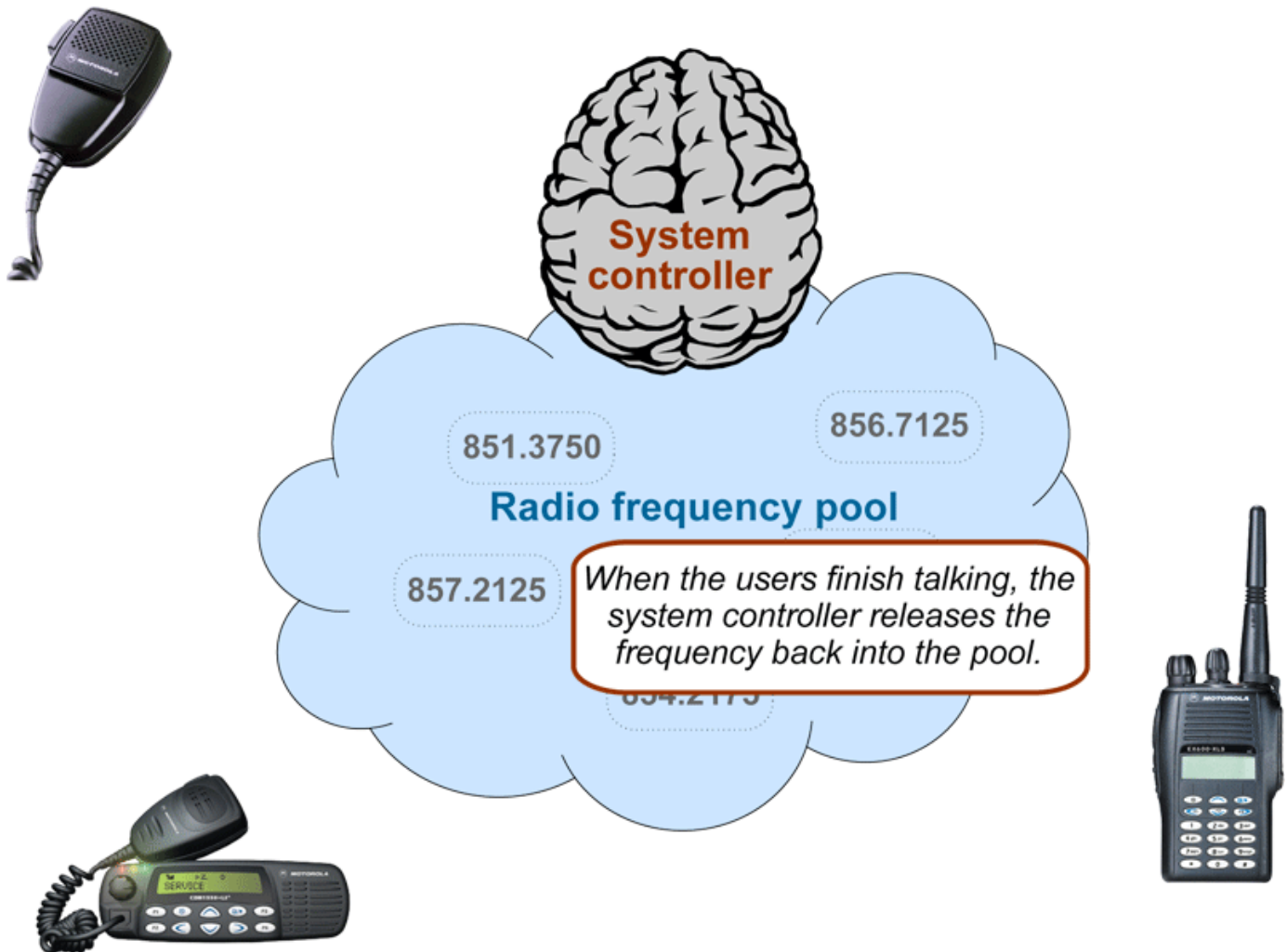

A typical 20-frequency trunked system can support hundreds of channels. For example, the Fort Worth system includes over 400 channels providing communication support for Fort Worth agencies (Police, Fire and Ambulance) and agencies in the surrounding cities of Kennedale, North Richland Hills, Forest Hill, Haltom City and Richland Hills. In addition, the same system also supports the Tarrant County Sheriff and Texas Christian University. (You can see its setup in the [RadioReference database](#).)

Before moving to the trunked system, the Police had only 6 channels (North, South, East, West, Information, and Tactical). Since moving to the trunked system, they are now able to provide 11 channels for North Side PD alone: a main dispatch channel, three talkaround channels, a supervisor channel, a bike patrol channel, and several community patrol channels. Other police districts have similar channel requirements, and now special

operations teams such as SWAT, Narcotics, and Traffic each have one or more dedicated channels for their use as well.

This page applies to the following scanner(s): [BCD996XT](#) [BCT15X](#) [BCD396XT](#) [BC346XT](#) [Users Guide](#)

# Deciphering Trunked Systems

- [Before you program a trunked system](#)
  - [System Type](#)
    - [P25 Systems](#)
    - [LTR Systems](#)
    - [Motorola Systems](#)
    - [EDACS Systems](#)
    - [Conventional Systems](#)
    - [Non-scannable Systems](#)
  - [System Voice](#)
  - [System Frequencies](#)
  - [Talk Group IDs \(Channels\)](#)

## Before you program a trunked system

To the average radio user, the complexity of a trunked system is invisible. Their radio is programmed up at the radio shop. They can still easily select who they need to communicate with by selecting a channel on their two-way. They can even directly call other radio users without tying up a dispatch channel — something they could never do before. As a scanner user, on the other hand, you need to know the different types of trunking systems in use, what options are available on each system, and three key pieces of information about any trunking system before you start any actual programming:

- System Type
- System Frequencies
- IDs of the Talk Groups you want to hear

All of this information is usually available from the online database at [RadioReference](#). The picture to the right shows a screenshot of a system from the database, with the pertinent information highlighted.

**System Name:** Fort Worth / Tarrant County Public Safety  
**Location:** Fort Worth, TX  
**Country:** Tarrant  
**System Type:** Motorola Type II Smartnet  
**System Voice:** Analog  
**Last Updated:** December 10, 2009 11:12:03 AM  
**HTS:** 25043

**System ID List**

System ID	Connect Tone
3632	90.00

**System Frequencies**

Red (c) are Primary Control Channels | Blue (a) are alternate control channels | Click a Site Name for additional site information | Site Map: FCC Callsigns BR Locations

Site Name	Freqs
001 Primary	866.16250 866.21250 866.28750 866.36250 866.38750 866.66250 866.68750 866.71250 866.83750 866.88750 867.16250 867.21250 867.26250 867.33750 867.38750 867.66250 867.71250c 867.76250c 867.83750c 867.88750c

**System Talkgroups**

Updated in the last 7 days Updated in the last 24 hours List All in one table Show New Talkgroups

**FWPD North Talkgroups**

DEC	HEX	Mode	Alpha Tag	Description	Tag
2992	0bb	A	N-PTRL	NORTH DIVISION - PATROL	Law Dispatch
3024	0bd	A	N-CID	NORTH DIVISION - CID	Law Tac
3056	0bf	A	N-COPS	NORTH DIVISION - CRO/CODE BLUE	Law Tac
3088	0c1	A	N-SUPV	NORTH DIVISION - SUPERVISOR	Law Tac
3120	0c3	A	N-FOOT	NORTH DIVISION - FOOT/BIKE PATROL	Law Tac
3152	0c5	A	N-TLK1	NORTH DIVISION - TALK CH 1	Law Talk
3184	0c7	A	N-TLK2	NORTH DIVISION - TALK CH 2	Law Talk
3216	0c9	A	N-TLK3	NORTH DIVISION - TALK CH 3	Law Talk
6864	1ad	A	N-COPS2	NORTH DIVISION - CRO/CODE BLUE	Law Tac
18832	499	A	N-COPS3	NORTH DIVISION - CRO/CODE BLUE	Law Tac
18864	49b	A	N-COPS4	NORTH DIVISION - CRO/CODE BLUE	Law Tac

**FWPD South Talkgroups**

DEC	HEX	Mode	Alpha Tag	Description	Tag
2448	099	A	S-PTRL	SOUTH DIVISION - PATROL	Law Dispatch
2480	09b	A	S-CID	SOUTH DIVISION - CID	Law Tac
2512	09d	A	S-COPS	SOUTH DIVISION - CRO/CODE BLUE	Law Tac

**System type**

**System voice (Types of voice modulation used on the system.)**

**System frequencies (Red or blue text means the frequency is a control channel.)**

**Talk group information (There may be several screens of data in larger systems.)**

## System Type

There are five major types of scannable systems; some of these also have subtypes. In the RadioReference database, you can generally determine the radio system type by looking at the line labeled *System Type* at the top of the screen (inside the red square in the screenshot).

## P25 Systems

These are identified in the RadioReference database as *Project 25 Standard* . If the System Type line says anything else, then it is not a P25 system (even though it might have some P25 channels).

## LTR Systems

These systems are identified as *LTR Standard* in the system type.

## Motorola Systems

There are several subcategories of Motorola systems, but they will all have some form of *Motorola* in the system type: *Motorola Fleetnet* , *Motorola Smartnet* , *Motorola Smartzone* , etc. Once you have identified that it is a Motorola system, you can check the system frequencies to confirm its subtype:

- Motorola 800: all of the frequencies are in the 800 MHz range
- Motorola 900: all of the frequencies are in the 900 MHz range
- Motorola UHF: all of the frequencies are between 400 and 512 MHz
- Motorola VHF: all of the frequencies are between 100 and 200 MHz.

## EDACS Systems

There are three subtypes of EDACS systems:

- EDACS Wide: identified as *EDACS Standard* in the system type.
- EDACS Narrow: identified as *EDACS Narrowband* in the system type.
- EDACS SCAT: identified as *EDACS Scat* in the system type (these systems operate on a single frequency).

## Conventional Systems

This fifth type of scannable system is a general catchall for all non-trunked systems. See [Conventional Systems](#) for more information.

## Non-scannable Systems

There are several system types that cannot be monitored with a scanner, either because the systems use proprietary digital formats that are not licensable by scanner manufacturers, or because the systems are not in wide enough use to make it cost-effective for manufacturers to

develop a scanner that can monitor them.

These non-scannable systems are identified in the system type as:

- EDACS w/ESK
- LTR Passport
- OpenSky Standard
- MPT1327
- Tetra

## System Voice

The other line inside the red square in the screenshot is *System Voice* , which summarizes the kinds of voice modulation used on the system. You'll find the following voice types:

- Analog (can be heard with any trunking scanner)
- APCO-25 (can be heard with a digital scanner)
- ProVoice (cannot be heard by any scanner)
- VSELP (cannot be heard by any scanner)

<b>System Name:</b>	Mansfield Public Safety
<b>Location:</b>	Mansfield, TX
<b>County:</b>	Tarrant
<b>System Type:</b>	Motorola Type II SmartZone
<b>System Voice:</b>	Analog and APCO-25 Common Air Interface
<b>Uniden DSP:</b>	983 1985 2892
<b>Last Updated:</b>	<u>Tagged 21 Talkgroups with (Law Dispatch)</u>
<b>Hits:</b>	5225

The system voice also tells us when digital channels are mixed in with analog channels on the same system. Unfortunately, this means the system voice line can cause a lot of confusion. Just remember: system *voice* does not define the system *type* .

For example, in the system information shown to the left, we see that *APCO-25* can be used as a voice type on a Motorola system that is not actually a *P25 system* . When we're trying to determine whether a system is a P25 system, we need to ignore the *System Voice* line and focus on the *System Type* line. If there is P25 Voice on a non-P25 system, the scanner can sort this out while scanning.

## System Frequencies

The *system frequencies* section in the database lists all the frequencies used by the system (see the blue square in the screenshot above on the right). For Motorola and P25 systems, you will

need to program only the system control channel frequencies: those are the frequencies shown in red (for primary control channels) and blue (for alternate control channels) in the database.

For EDACS and LTR systems, you will need to program all the listed frequencies and their associated LCN (that is a small number right next to the frequency). Some systems have multiple sets of frequencies. These are called *multi-site* systems: each set of frequencies corresponds to a different physical antenna site.

## Talk Group IDs (Channels)

The Talk Group information section (inside the green rectangle) shows the different channels on the system and which agency uses them. You'll need to go through the list and make a note of the channels you want to hear. Then you can start thinking about how you want to organize those channels.

(Keep in mind that this screenshot shows just a few of the channels on a single system. One of the great features available to subscribers on RadioReference is the ability to tag channels directly on the site and print out a nicely-formatted hardcopy of each system. It makes this task much, much easier.)

This page applies to the following scanner(s): [BCD996XT](#) [BCT15X](#) [BCD396XT](#) [BC346XT](#)  
[Users Guide](#)

# Location-based Scanning

Location-based scanning allows you to control which systems/sites and channel groups are scanned based on your exact location. This frees you from having to manually enable and disable systems or channel groups as you change location.

To use Location-Based scanning, you need to have the following:

- the location for the center point for each system/site or channel group you want to control
- the radius or distance from the center point you want to set as the range for each system/site or channel group
- if you are scanning while traveling, you may want to include the heading (direction) of travel
- some type of mapping method. If you don't want to use paper maps, you might try a mapping software (such as Microsoft® Streets and Trips or Delorme® Street Atlas) that allows you to draw markings and overlays on maps.
- a GPS receiver with a serial data output (NMEA)

There are many different approaches you can use to determine where to place a center point for a system/site or channel group. The two most common are the geopolitical approach and the antenna-centric approach. For large trunked systems, you may find that a combination of these two approaches works best.

- [The Geopolitical Approach](#)
- [The Antenna-Centric Approach](#)
  - [Finding an antenna location](#)
- [Combining for Efficiency](#)
- [See Also](#)

## The Geopolitical Approach

With the geopolitical approach, you want the scanner to turn on the system/site or channel group at the limit of relevance rather than reception. This approach is useful for scanning

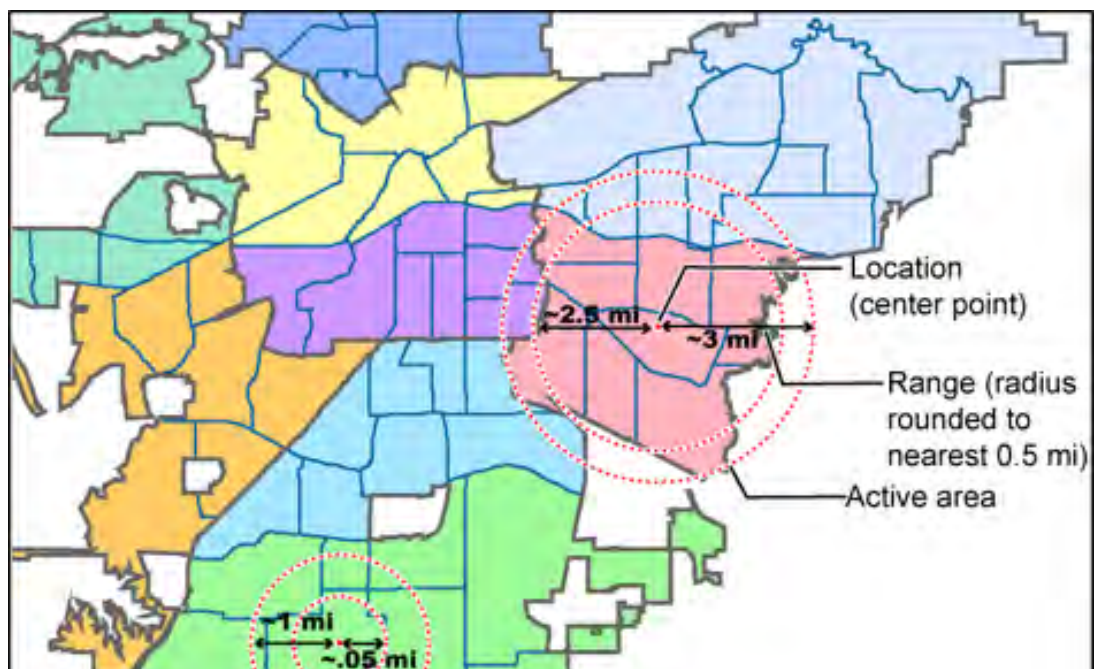



targets that have a well-defined jurisdiction and their transmission are only relevant when you are within that jurisdiction.

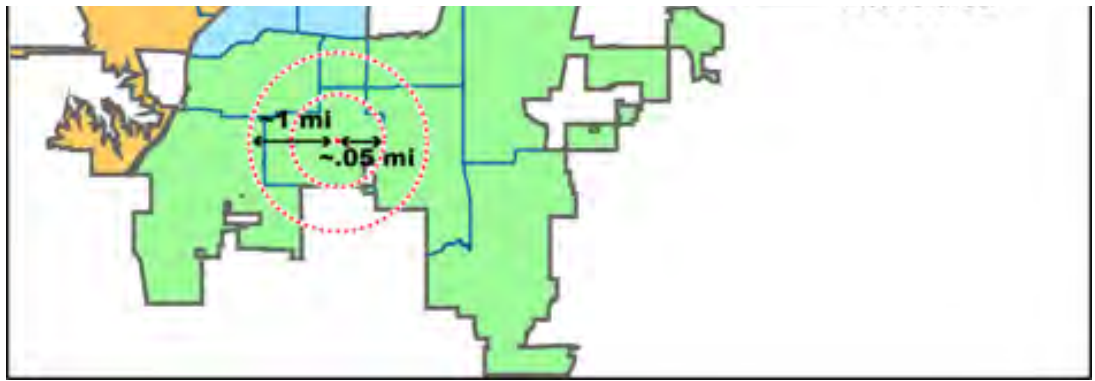

To use the geopolitical approach, find the geographical center of the scanning target's territory (whether city, county, district, precinct, or other agency jurisdiction), and set these coordinates as your center point location. Then, adjust the range or radius to cover the boundaries of that target.

To use this method, use your chosen mapping application to zoom out so that the entire target is visible, then, draw a circle that just covers the targets boundaries. Adjust the size of the circle to the nearest 1/2 mile increment.

Depending on the shape of the territory, you may have to choose between a lot of overlap or not covering the entire area: jurisdiction, you might end up with a large amount of overlap. You'll have to decide which radius that best suits your application.

For example, if your territory is a city, you'll have a lot of "extra" area if you use one single location:

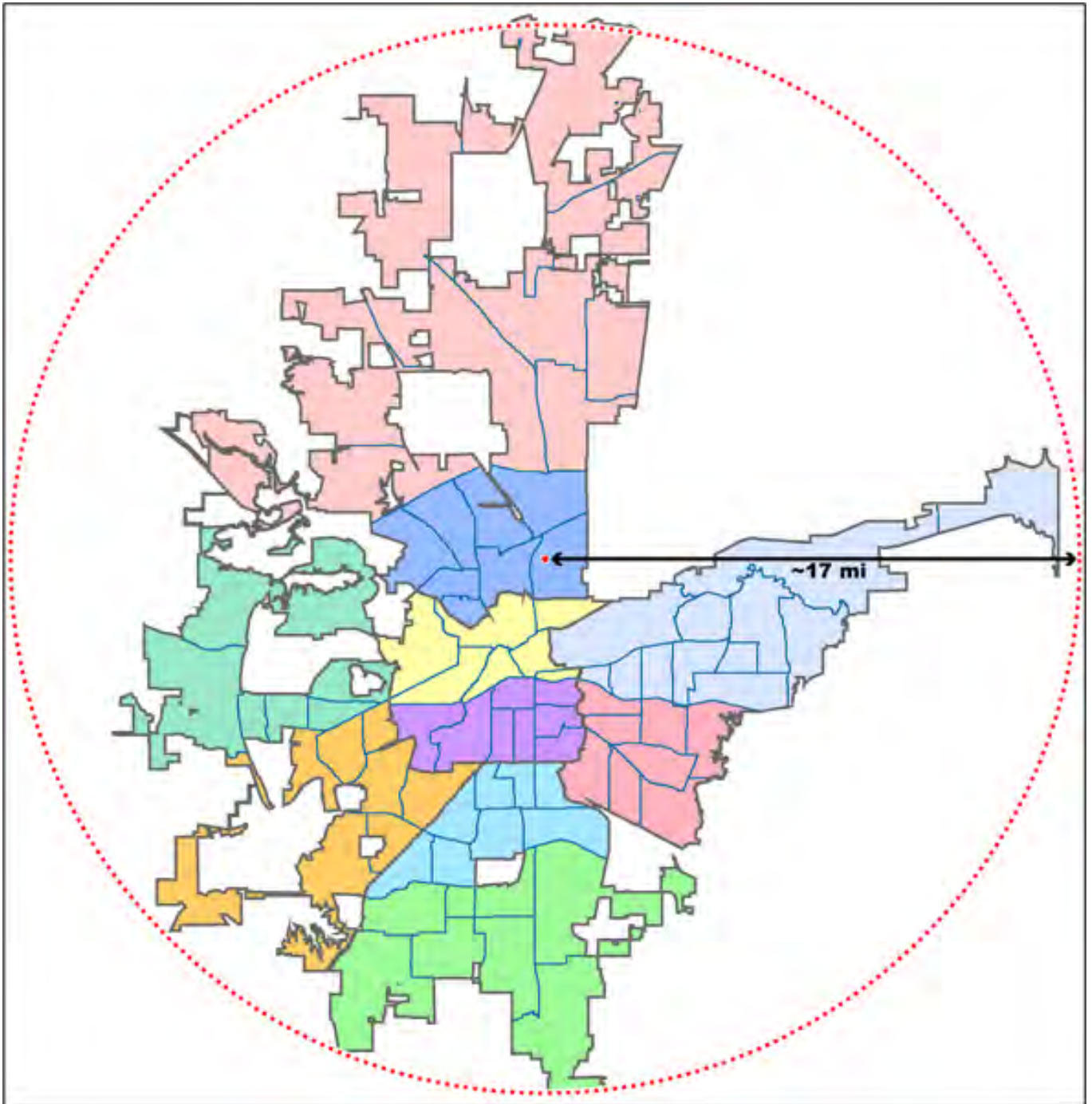

On the other hand, if you sub-divide the area, you may end up with areas that are not covered:

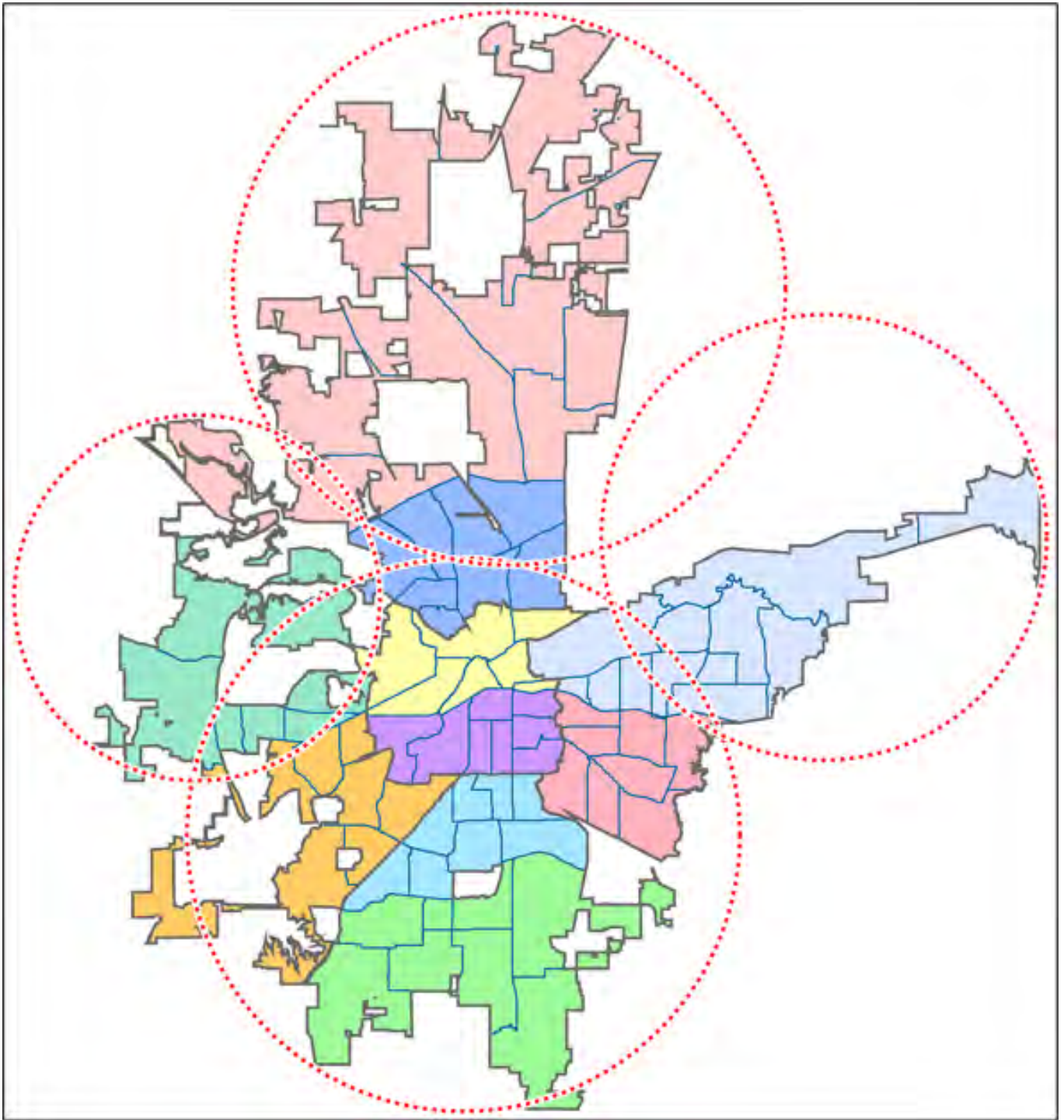

## The Antenna-Centric Approach

Using an antenna-centric approach, you set the physical antenna location as the system/sites center point and the antenna's actual reach as the range.

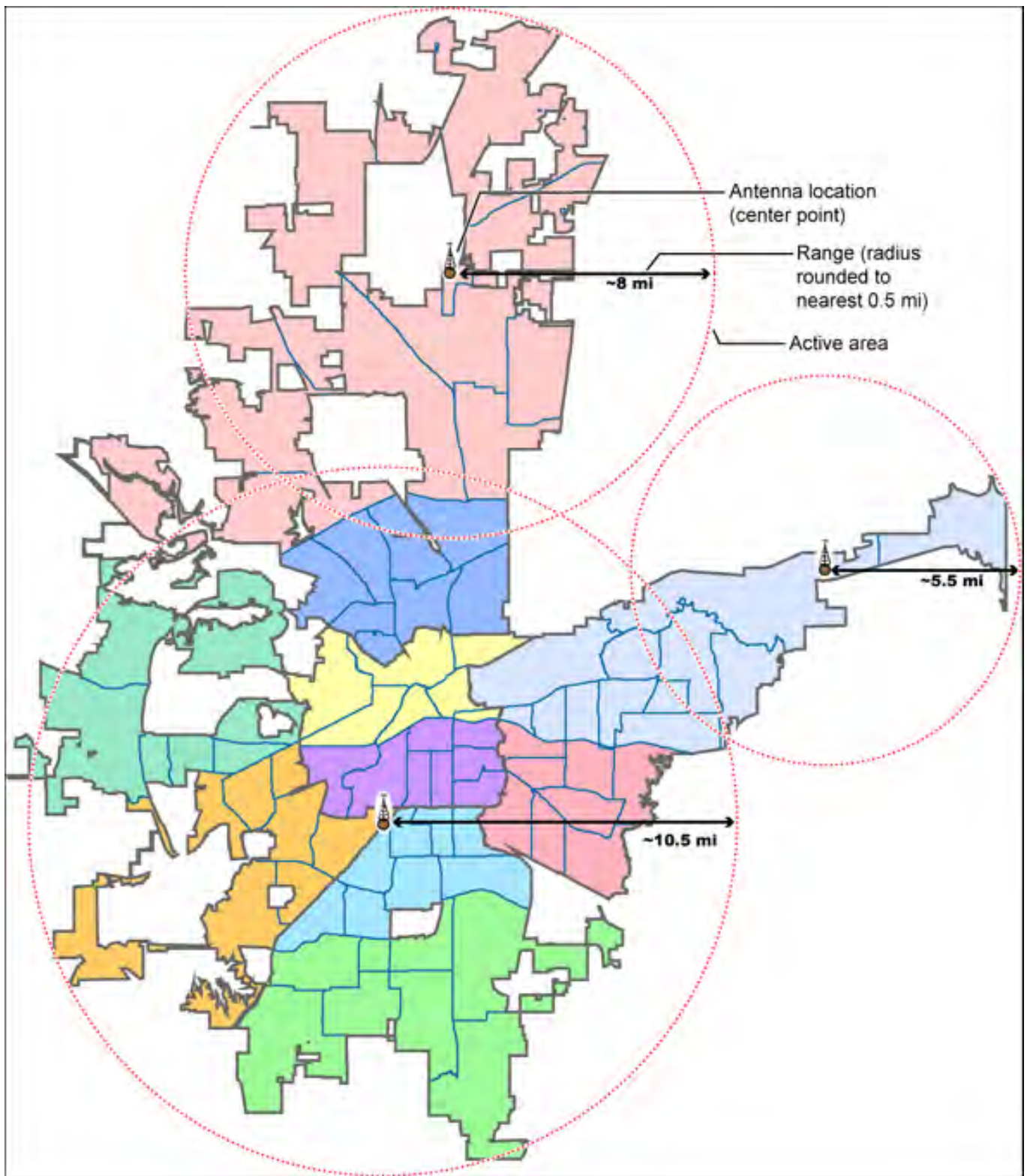

## Finding an antenna location

You can find the physical location of antennas using the databases available at [Radio Reference](#) or the FCC's Antenna Structure Registration site. Both sites list the latitude, longitude, and height of the antenna, and both sites can map the exact location for you. ([Radio Reference](#) is more user-friendly, so it's easier to

find what you're looking for.)

## Combining for Efficiency

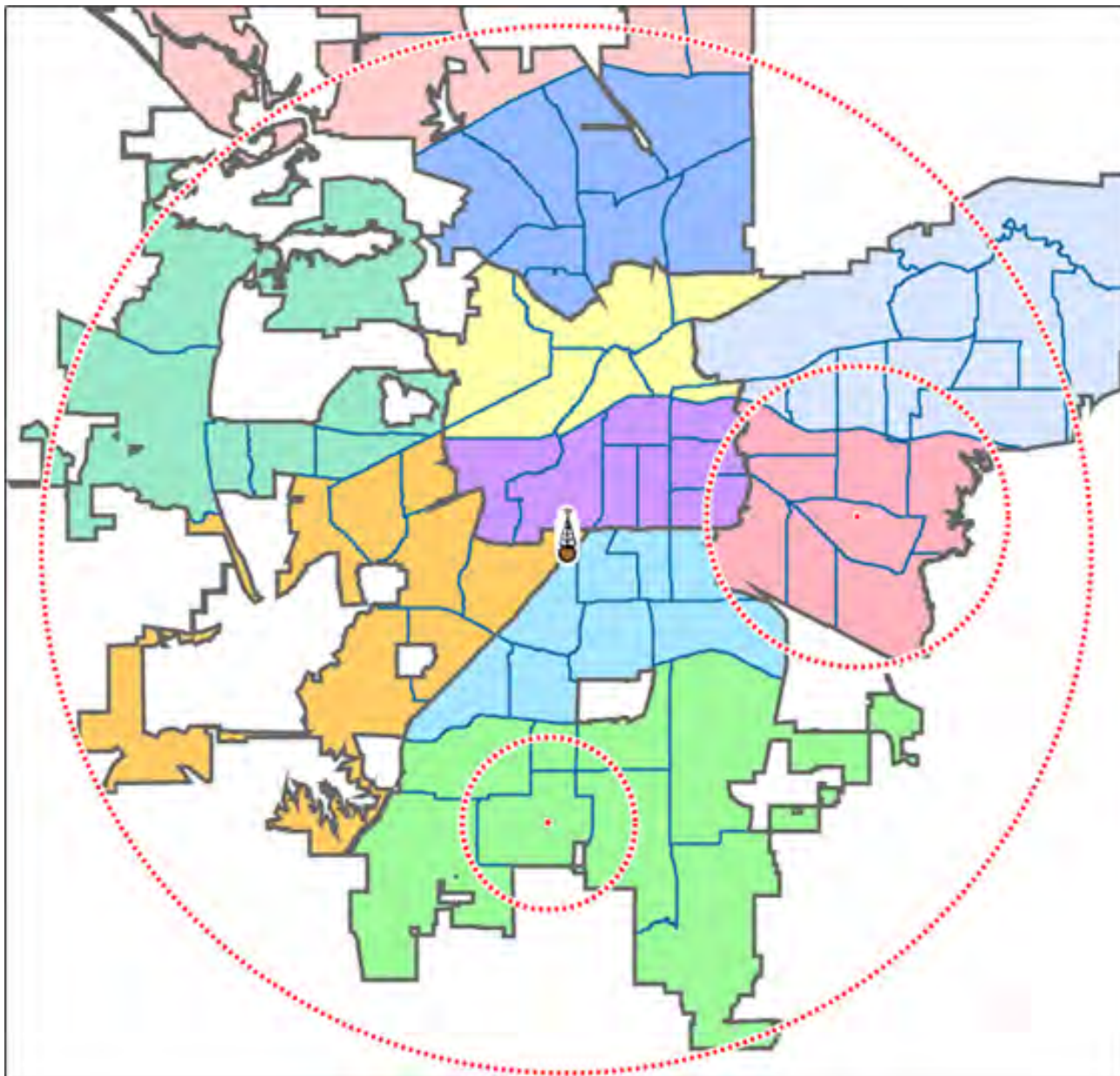

Because many trunked systems have both multiple antenna sites and multiple agencies with differing geographic boundaries, you may want to combine the approaches:

1. Use the antenna centric approach at the site level: set the geographic coordinates of the antenna as the central location for each site.
2. Use the geopolitical approach at the channel group level. Within the same system, set up a channel group for each agency, and set the central point of the agency territory as the group location.

With both approaches combined into a single system, the scanner will now seamlessly switch between

antenna sites as needed to keep the scanner tuning only to those sites you can receive well, and will also turn channel groups on and off as you relocate to different jurisdictions.

## See Also

[Connecting a GPS receiver](#)

[Programming locations](#)

This page applies to the following scanner(s): [BCD996XT](#) [BCT15X](#) [BCD396XT](#) [BC346XT](#) [Users Guide](#)

# Scanning Legally

Your scanner covers frequencies used by many different groups, including police and fire departments, ambulance services, government agencies, private companies, amateur radio services, military operations, pager services, and wireline (telephone and telegraph) service providers.

It is legal to listen to almost every transmission your scanner can receive. However, there are some transmissions that you should never intentionally listen to. These include:

- Telephone conversations (cellular, cordless, or other private means of telephone signal transmission)
- Pager transmissions
- Any scrambled or encrypted transmissions

According to the Electronic Communications Privacy Act (ECPA), you are subject to fines and possible imprisonment for intentionally listening to, using, or divulging the contents of such a conversation unless you have the consent of a party to the conversation (unless such activity is otherwise illegal).

This scanner has been designed to prevent the reception of cellular telephone transmissions and the decoding of scrambled transmissions. This is done to comply with the legal requirement that scanners be manufactured so they are not easy to modify to pick up these transmissions. Do not open your scanner's case to make any modifications that could allow it to pick up transmissions that are illegal to monitor. Modifying or tampering with your scanner's internal components or using it in a way other than as described in the manual could invalidate your warranty and void your FCC authorization to operate it.

In some areas, mobile and/or portable use of this scanner is unlawful or requires a permit. Check the laws in your area. It is also illegal in many areas (and a bad idea everywhere) to interfere with the duties of public safety officials by traveling to the scene of an incident without authorization.

**Digital Scanners Only:** A license is required to use this product in Canada!

This page applies to the following scanner(s): [BCD996XT](#) [BCT15X](#) [BCD396XT](#)  
[BC346XT Users Guide](#)



# General Precautions

Before you use this scanner, please read and observe the following:

## Earphone Warning

You can use an optional 32Ω stereo headset or earphone with your scanner. Use of an incorrect earphone or headset might be potentially hazardous to your hearing. The output of the phone jack is monaural, but you will hear it in both headphones of a stereo headset.

Set the volume to a comfortable audio level coming from the speaker before plugging in the earphone or headset. Otherwise, you might experience some discomfort or possible hearing damage if the volume suddenly becomes too loud because of the volume control or squelch control setting. This might be particularly true of the type of earphone that is placed in the ear canal.

## Liquid Exposure Warning

Uniden does not represent this unit to be waterproof. To reduce the risk of fire or electrical shock, do not expose this unit to rain or moisture!

## Power Disconnection Caution

**Important:** Always turn the scanner off before disconnecting external power. Some settings are saved only as the scanner is powering down.

---

This topic applies to the following scanner(s): [BCD996XT](#) [BCT15X](#) [BCD396XT](#)  
[BC346XT](#) [Users Guide](#)

# FCC Information

## The FCC Wants You to Know

IMPORTANT! This scanning radio has been manufactured so that it will not tune to the radio frequencies assigned by the FCC for cellular telephone usage. The Electronic Communications Privacy Act of 1986, as amended, makes it a federal crime to intentionally intercept cellular or cordless telephone transmissions or to market this radio when altered to receive them. The installation, possession, or use of this scanning radio in a motor vehicle may be prohibited, regulated, or require a permit in certain states, cities, and/or local jurisdictions. Your local law enforcement officials should be able to provide you with information regarding the laws in your community.

For more details, see [Scanning Legally](#).

## Modification Notice

Changes or modifications to this product not expressly approved by Uniden, or operation of this product in any way other than as detailed by this User's Guide, could void your authority to operate this product.

## Part 15 Information

This scanner has been tested and found to comply with the limits for a scanning receiver, pursuant to Part 15 of the FCC Rules. These limits are designed to provide reasonable protection against harmful interference in a residential installation. This scanner generates, uses, and can radiate radio frequency energy and, if not installed and used in accordance with the instructions, may cause harmful interference to radio communications.

There is no guarantee that interference will not occur in a particular installation. If this scanner does cause harmful interference to radio or television reception, which can be determined by turning the scanner on and off, you are encouraged to try to correct the interference by one or more of the following measures:

- Reorient or relocate the receiving antenna.

- Increase the separation between the scanner and the receiver

This device complies with Part 15 of the FCC Rules. Operation is subject to the following two conditions:

1. This device may not cause harmful interference, and
2. this device must accept any interference received, including interference that may cause undesired operation.

This page applies to the following scanner(s): [BCD996XT](#) [BCT15X](#) [BCD396XT](#)  
[BC346XT Users Guide](#)

# Warranty and Support Information

## Support Information

Information online	<a href="http://www.uniden.com">www.uniden.com</a>
Email support	<a href="http://mycusthelp.com/uniden">http://mycusthelp.com/uniden</a>
Phone support	(800) 297-1023 (during regular business hours, Central time)

## One-Year Limited Warranty

This warranty text applies to the following scanners:

- [BCD396XT](#)
- [BC346XT](#)
- [BCD996XT](#)
- [BCT15X](#)

*If your scanner is not listed, the warranty information below may not apply.*

**Important: Evidence of original purchase is required for warranty service!**

WARRANTOR: UNIDEN AMERICA CORPORATION (Uniden)

ELEMENTS OF WARRANTY: Uniden warrants, for one year, to the original retail owner, this Uniden Product to be free from defects in materials and craftsmanship with only the limitations or exclusions set out below.

WARRANTY DURATION: This warranty to the original user shall terminate and be of no further effect 12 months after the date of original retail sale. The warranty is invalid if

the Product is

- (A) damaged or not maintained as reasonable or necessary,
- (B) modified, altered, or used as part of any conversion kits, subassemblies, or any configurations not sold by Uniden,
- (C) improperly installed,
- (D) serviced or repaired by someone other than an authorized Uniden service center for a defect or malfunction covered by this warranty,
- (E) used in any conjunction with equipment or parts or as part of any system not manufactured by Uniden, or
- (F) installed or programmed by anyone other than as detailed by the Operating Guide for this product.

**STATEMENT OF REMEDY:** In the event that the product does not conform to this warranty at any time while this warranty is in effect, warrantor will repair the defect and return it to you without charge for parts, service, or any other cost (except shipping and handling) incurred by warrantor or its representatives in connection with the performance of this warranty. **THE LIMITED WARRANTY SET FORTH ABOVE IS THE SOLE AND ENTIRE WARRANTY PERTAINING TO THE PRODUCT AND IS IN LIEU OF AND EXCLUDES ALL OTHER WARRANTIES OF ANY NATURE WHATSOEVER, WHETHER EXPRESS, IMPLIED OR ARISING BY OPERATION OF LAW, INCLUDING, BUT NOT LIMITED TO ANY IMPLIED WARRANTIES OF MERCHANTABILITY OR FITNESS FOR A PARTICULAR PURPOSE. THIS WARRANTY DOES NOT COVER OR PROVIDE FOR THE REIMBURSEMENT OR PAYMENT OF INCIDENTAL OR CONSEQUENTIAL DAMAGES.** Some states do not allow this exclusion or limitation of incidental or consequential damages so the above limitation or exclusion might not apply to you.

**LEGAL REMEDIES:** This warranty gives you specific legal rights, and you might also have other rights which vary from state to state. This warranty is void outside the United States of America.

**PROCEDURE FOR OBTAINING PERFORMANCE OF WARRANTY:** If, after following the instructions in this Operating Guide you are certain that the Product is defective, pack the Product carefully (preferably in its original packaging). Include evidence of original purchase and a note describing the defect that has caused you to return it. The Product should be shipped freight prepaid, by traceable means, or delivered, to warrantor at:

Uniden America Corporation Parts and Service Division 4700 Amon

Carter Boulevard Fort Worth, TX 76155

This page applies to the following scanner(s): [BCD996XT](#) [BCT15X](#) [BCD396XT](#)  
[BCD346XT](#) [Users Guide](#)

# User Guide Information

Illustrations in this guide are used for explanation purposes only. Your scanner may not match the illustrations exactly.

All content (including any media) contained within in this guide is copyright 2009 by Uniden America Corporation unless otherwise specified. Any content not belonging to Uniden America is marked as such and used with permission.

Content or information in external sources are neither the intellectual property not the responsibility of Uniden America Corp. Uniden America makes no claim to the accuracy or completeness of external content.

Screen grabs used in most examples are provided with the permission of [RadioReference.com](http://RadioReference.com)

Astro®, DPL®, Digital Private Line®, Motorola®, PL®, PRIVACY PLUS®, Private Line®, SMARTNET®, and SMARTZONE® are registered trademarks of Motorola, Inc.

LTR® is a registered trademark of E.F. Johnson Co.

EDACS® is a registered trademark of M/A-COM Private Radio Systems Inc.

Uniden® and Bearcat® are registered trademarks of Uniden America Corporation.

TrunkTracker™, Trunk Tracking™, and Close Call™ are proprietary trademarks of Uniden America Corporation.

Other trademarks used throughout this manual are the property of their respective holders.

[Users Guide](#)

# Available Operation Modes

To determine whether the information on this page applies to your scanner, see the tags at the bottom of the page.

The scanner has several different operation modes; in each mode, the scanner's operation, display, and key functions can be completely different:

- [Scan mode](#)
- [Search mode](#)
- [Hold mode](#)
- [Close Call Priority mode](#)
- [Close Call Only mode](#)
- [Close Call Do Not Disturb mode](#)
- [Priority Scan mode](#)
- [Priority Plus Scan mode](#)
- [GPS mode](#)
- [Weather mode](#)
- [Weather Priority Mode](#)
- [Weather Alert mode](#)
- [Tone Out mode](#)
- [Band Scope mode](#)

## Scan mode

The scanner checks each frequency in the user-programmed list of frequencies. For trunked systems, it checks each Talk Group ID in the user-programmed list. When it detects a signal, the scanner stays on the channel and opens squelch. For trunked systems, if the Talk Group ID becomes active, the scanner switches to the audio channel and opens squelch. When the signal stops, the scanner continues the scan.

For information about key operation and other specifics about Scan Mode:

- [BCD396XT](#) and [BC346XT](#): [Hand Held Scanner Scan Mode](#)
- [BCD996XT](#): [BCD996XT Scan Mode](#)



- [BCT15X: BCT15X Scan Mode](#)

To enter Scan mode, tap **SCAN**. (This is the default mode when the scanner powers on.)

## Search mode

The scanner checks each frequency that falls within a user-programmed range. For trunked systems, it checks each control channel in the user-programmed list. When it detects a signal, the scanner stays on the channel and opens squelch. For trunked systems, when it detects an active Talk Group ID, the scanner switches to the audio channel and opens squelch. When the signal stops, the scanner continues the search.

For information about key operation and other specifics about Scan Mode:

- [BCD396XT](#) and [BC346XT](#): [Hand Held Scanner Search Mode](#)
- [BCD996XT](#): [BCD996XT Search Mode](#)
- [BCT15X](#): [BCT15X Search Mode](#)

To enter Search mode, **FUNCTION+** tap **SCAN** . The scanner asks if you want to perform the Quick Search: tap **YES** if this is the search you want. To start a different search, tap **NO**: the scanner takes you to the [Search for...](#) menu, and you can select your search.

## Hold mode

The scanner stays on the current channel and enables save and edit options (options vary depending on the type of system).

For more information about key operation and other specifics about hold mode:

- [BCD396XT](#): [BCD396XT Hold Mode](#)
- [BCD996XT](#): [BCD996XT Hold Mode](#)
- [BC346XT](#): [BC346XT Hold Mode](#)
- [BCT15X](#): [BCT15X Hold Mode](#).

To enter Hold mode, tap **HOLD**.

## Close Call Priority mode

In Close Call Priority, the scanner interrupts its current operation every 2 seconds, searches for signals that are stronger than other signals on the selected band, then returns to the previous operation. When it detects a close call hit, the scanner can switch to the channel and open squelch (depending on the setting). In Close Call DND (do-not-disturb) mode, the scanner only interrupts if it is not already receiving audio.

For more information about key operation and other specifics about Close Call mode:

- [BCD396XT](#) or [BC346XT](#): [Handheld Scanner Close Call Mode](#)
- [BCD996XT](#): [BCD996XT Close Call Mode](#)
- [BCT15X](#): [BCT15X Close Call Mode](#)

To enter Close Call mode on the [BCD396XT](#) or [BC346XT](#), **FUNCTION** + repeatedly tap **HOLD** until Close Call Pri appears.

To enter Close Call mode on the [BCD996XT](#), repeatedly tap the **SQ** knob until Close Call Pri appears.

To enter Close Call mode on the [BCT15X](#), **Function** + repeatedly tap the **SQ** knob until Close Call Pri appears.

The Close Call icon appears for Close Call Priority mode and is in reverse colors for Close Call DND mode.

## Close Call Only mode

The scanner stops the current operation and only performs Close Call checks as described above.

For more information about key operation and other specifics about Close Call Only mode:

- [BCD396XT](#) or [BC346XT](#): [Handheld Scanner Close Call Only Mode](#)
- [BCD996XT](#): [BCD996XT Close Call Only Mode](#)
- [BCT15X](#): [BCT15X Close Call Only Mode](#)

To enter Close Call only mode on the [BCD396XT](#) or [BC346XT](#), **FUNCTION** + press & hold **HOLD**.

To enter Close Call only mode on the [BCD996XT](#), press and hold the **SQ** knob.

To enter Close Call only mode on the [BCT15X](#), **FUNCTION** + press & hold the **SQ** knob.

## Close Call Do Not Disturb mode

When set in this mode, the scanner will periodically make Close Call checks whenever the scanner is not receiving audio in another mode. This eliminates the annoying breaks in conversation while still allowing for the Close Call functionality. In Close Call Do Not Disturb mode, the Close Call icon appears in reversed color.

For more information about key operation and other specifics about Close Call Do Not Disturb mode:

- [BCD396XT](#) or [BC346XT](#): [Handheld Scanner Close Call Mode](#)
- [BCD996XT](#): [BCD996XT Close Call Mode](#)
- [BCT15X](#): [BCT15X Close Call Mode](#)

To enter Close Call Do Not Disturb mode on the [BCD396XT](#) or [BC346XT](#), **FUNCTION** + repeatedly press **HOLD** until Close Call DND appears

To enter Close Call Do Not Disturb mode on the [BCD996XT](#), repeatedly press the **SQ** knob until Close Call DND appears.

To enter Close Call Do Not Disturb mode on the [BCT15X](#), **FUNCTION** + repeatedly press the **SQ** knob until Close Call DND appears.

## Priority Scan mode

At a specified interval, the scanner interrupts its current operation, checks the user-designated conventional priority channels, then resumes the previous operation. You can

set the interval for priority scan checks.

For more information about key operation and other specifics about Priority Scan mode, see [Priority Scan](#).

To enter Priority Scan mode on the [BCD396XT](#) or [BC346XT](#):

1. Enter Hold mode.
2. **FUNCTION** + tap **NO**.

To enter Priority Scan mode on the [BCD996XT](#), press **PRI**.

To enter Priority Scan mode on the [BCT15X](#), **FUNCTION** + press **POL/PRI**.

If no conventional channels in enabled and unlocked systems are designated as priority, the scanner will display *Priority Scan No Channel*.

For trunked priority channels, you need to enable priority scanning in the system option menu as well as tagging the channel as priority. Trunked priority only works while scanning that system's control channel or (in the case of Motorola systems) when the scanner is scanning any channel in the system.

## Priority Plus Scan mode

The scanner stops the current operation and only performs Priority Scan checks as described above.

To enter Priority Plus Scan mode on the [BCD396XT](#) or [BC346XT](#):

1. Enter Hold mode.
2. **FUNCTION** + repeatedly tap **NO** until the scanner displays *Priority Mode Plus On*.

To enter Priority Plus Scan mode on the [BCD996XT](#), press **PRI** until the scanner displays *Priority Mode Plus On*.

To enter Priority Plus Scan mode on the [BCT15X](#), **FUNCTION** +

repeatedly tap **POL/PRI** until the scanner displays *Priority Mode Plus On*.

## GPS mode

(Requires a connected GPS receiver.) The scanner displays longitude, latitude, and heading information.

For more information about key operation and other specifics about GPS mode:

- For the [BCD396XT](#) or [BC346XT](#): [Handheld GPS Mode](#)
- For the [BCD996XT](#): [BCD996XT GPS Mode](#)
- For the [BCT15X](#): [BCT15X GPS Mode](#)

To enter GPS mode on the [BCD396XT](#) or [BC346XT](#), **FUNCTION** + tap **GPS**.

To enter GPS mode on the [BCD996XT](#) or BCT15, tap **GPS**.

## Weather mode

The scanner checks each of the 10 National Weather Radio channels and opens squelch when it detects a signal. When the signal stops, the scanner continues checking the other weather channels. For more information about Weather Mode, see [Weather Mode](#).

To enter Weather mode on the [BCD396XT](#) or [BC346XT](#), **FUNCTION** + press & hold **WX**.

To enter Weather mode on the [BCD996XT](#), press & hold **WX**.

To enter Weather mode on the [BCT15X](#), **FUNCTION** + press and hold **GPS/WX**.

## Weather Priority Mode

In Weather Priority mode, the scanner interrupts scanning every 5 seconds to check for an alert. If an alert tone is present, the scanner sounds an alert tone, then stays on the weather channel so you can hear the alert. For more information about Weather Priority

Mode, see [Weather Mode](#).

To enter Weather Priority mode on the [BCD396XT](#) or [BC346XT](#),  
**FUNCTION** + tap **WX**.

To enter Weather Priority mode on the [BCD996XT](#), tap **WX**.

To enter Weather Priority mode on the [BCT15X](#), **FUNCTION** + tap **GPS/**  
**WX**.

## Weather Alert mode

This is similar to Weather mode: the scanner checks each of the 10 National Weather Radio channels and stays on a channel when it detects a signal. However, in Weather Alert mode, the scanner only opens squelch if it detects the EAS alert tone. For more information about Weather Alert Mode, see [Weather Mode](#).

To enter Weather Alert mode on the [BCD396XT](#) or [BC346XT](#):

1. Enter Weather mode.
2. **FUNCTION**+ tap **WX**.

To enter Weather Alert mode on the [BCD996XT](#):

1. Enter Weather mode.
2. Tap **WX** .

To enter Weather Alert mode on the [BCT15X](#):

1. Enter Weather mode.
2. **FUNCTION** + tap **GPS/WX**.

## Tone Out mode

The scanner checks up to 10 user-programmed channels for two-tone sequential, single, or group paging tones. When it detects a tone that matches the configuration for that channel, the scanner displays the tone information and opens squelch. For more

information about Tone Out Mode:

- [BCD396XT](#) or [BC346XT](#): [Hand Held Tone-Out Mode](#)
- [BCD996XT](#): [BCD996XT Tone-Out Mode](#)
- [BCT15X](#): [BCT15X Tone-Out Mode](#)

To enter Tone Out mode, tap **MENU** , then scroll down and select *Tone-Out for...*

To exit Tone Out mode, enter Scan mode.

## Band Scope mode

The scanner searches a frequency ranges and displays a visual representation of the signal level. For more information about Band Scope Mode:

- [BCD396XT](#) or [BC346XT](#): [Hand Held Band Scope Mode](#)
- [BCD996XT](#): [BCD996XT Band Scope Mode](#)
- [BCT15X](#): [BCT15X Band Scope Mode](#)







To enter Band Scope Mode:

1. Set one of the 3 search keys to a Band Scope search.
2. Enter Search mode.
3. **FUNCTION** + Tap the designated search key.

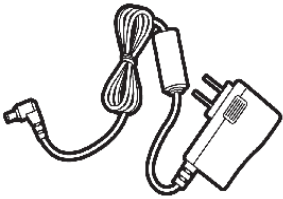
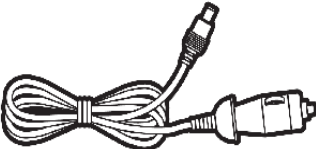
This page applies to the following scanner(s): [BCD996XT](#) [BCT15X](#) [BCD396XT](#)  
[BC346XT Users Guide](#)

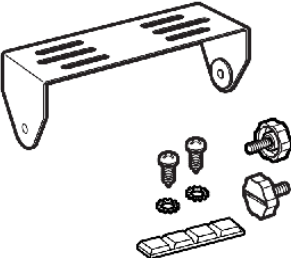
- [Included With Your Scanner](#)
- [Setting Up Your Scanner](#)
  - [Power Related Issues](#)
  - [Base Station](#)
  - [Setting Up an Audio Recording Device or Computer Recording](#)
  - [Vehicle Installation](#)
    - [Mounting Using the Bracket](#)
    - [Mounting Using the DIN-E Sleeve \(Option for BCT15X\)](#)
    - [Removing the Scanner from the DIN-E Sleeve](#)
    - [Mounting Using ISO Technique](#)
  - [Removing the Display Sticker](#)
  - [Connecting an Optional Antenna](#)
  - [Connecting an Earphone/Headphone](#)
  - [Connecting an Extension Speaker](#)

## Included With Your Scanner

 <p><b>Scanner</b></p>	 <p><b>AC Adapter</b></p>	 <p><b>Vehicle Accessory Power Cord</b></p>
 <p><b>Three-Wire Harness</b></p>	 <p><b>Mounting Bracket and Hardware</b></p>	 <p><b>Antenna</b></p>
 <p><b>Serial Programming Cable</b></p>	 <p><b>O/M on CD ROM</b></p>	 <p><b>Other Printed Materials</b></p>



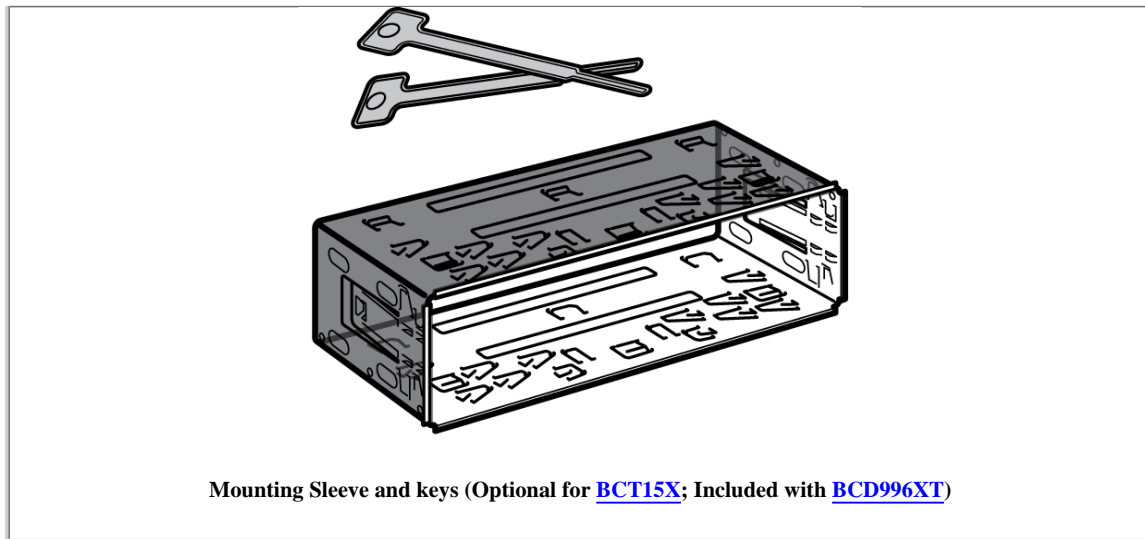

## Setting Up Your Scanner

These guidelines will help you install and set up your new scanner:

The scanner can be placed on a convenient surface in your home as a base station, and connected to a standard outlet that supplies 120VAC, 60Hz. You must use either the supplied antenna or an electrically correct outdoor antenna, properly and safely mounted at your chosen site.

The scanner is also designed to accommodate either DIN-E and ISO-DIN automotive mounting configurations using a DIN-E sleeve and keys, (Part Number DIN-0001, [BCD996XT](#): Included; [BCT15X](#): Optional).

The unit can also be placed above, beneath, or in the dash of your vehicle using the supplied bracket and mounting hardware.

- If your scanner receives interference or electrical noise, move the scanner or its antenna away from the source.
- To improve the scanner's reception, use an optional external antenna designed for multi-band coverage. (You can purchase this type of antenna at a local electronics store). If the optional antenna has no cable, use 50Ω coaxial cable for lead-in. A mating plug might be necessary for the optional antennas.
- Use an optional stereo earphone or stereo headset with proper impedance (32 Ω) for private listening. Read the precautions at [General Precautions](#).
- Do not use the scanner in high-moisture environments such as the kitchen or bathroom.
- Avoid placing the scanner in direct sunlight or near heating elements or vents.

## Power Related Issues

**Important:** To prevent memory from being corrupted, do not unplug the AC adapter during the time the memory is accessed for programming or auto store.

### Notes:

- If when you connect the AC adapter the [VOL] /Power Switch is ON, the scanner may not power on. Should this occur, simply turn the control OFF, then ON again.
- If the scanner loses power (as when you turn off your car's ignition with the scanner's power switch on), it can lose some system settings such as display color and backlight. To ensure that such settings persist, either change the setting using the scanner's menu or power the scanner off then back on using the power switch after making such setting changes.

When you turn off the scanner using the power switch, the scanner remembers the last settings and mode. When you turn power back on, it resumes the previous mode.

## Base Station

This is the simplest approach to let you get started quickly. Decide on a location that is convenient to a nearby wall outlet, has desk space to let you complete your programming worksheets, will safely allow the indoor antenna to be extended, or near a window to use an outdoor antenna.

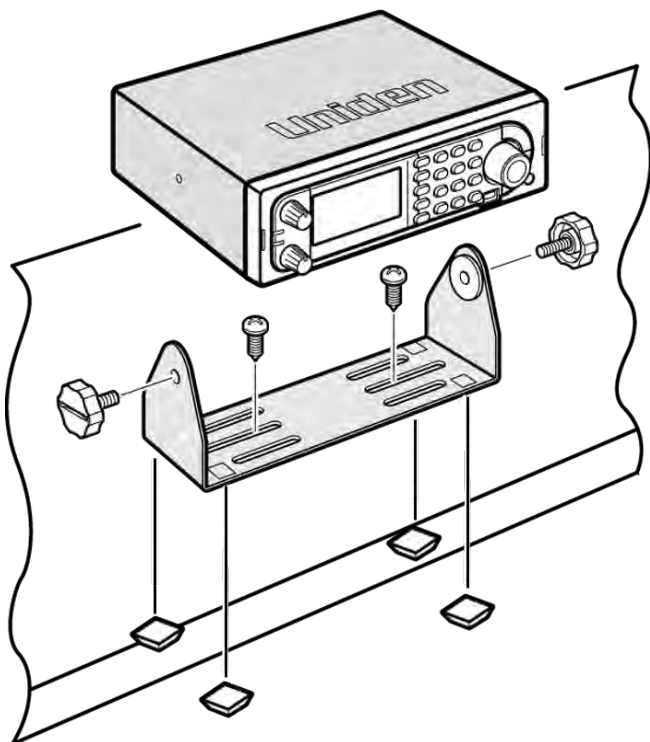

To secure the radio to a surface, by means of the mounting bracket, follow the steps below:

1. Attach the four protective mounting feet to the mounting bracket when you casually use the scanner on a flat surface. Should you desire to permanently mount the scanner, remove the feet and use wood screws through the bracket as described in Steps 2 and 3.
2. Use the bracket as a template to mark positions for the two mounting screws.
3. At the marked positions, drill holes slightly smaller than the screws.
4. Align the bracket with the threaded holes on the sides of the radio case so the bracket is beneath the radio. Secure the bracket using the two threaded knobs. Never overtighten the knobs.

Once the radio is positioned, connect it to a source of AC power using the supplied 13.8V, 750 mA AC adapter. Insert the barrel of the AC adapter to the jack on the rear, upper right side of the radio marked. Insert the connector of the supplied indoor telescoping antenna to the BNC Antenna Connector and apply moderate pressure to secure it.

## Setting Up an Audio Recording Device or Computer Recording

It is best if you plan ahead when you initiate the basic setup of the scanner if you include the components to record incoming reception. You need an audio recording device which can be controlled by a Voice Operated module (VOX) either externally or from within the unit and the correct connecting cable. The REC (record) jack on the rear apron provides a constant-level audio output which is not affected by the setting of the volume control. Use a mono or stereo cable that ends in a 3.5mm plug for the scanner. The recorder might have its own requirements as to the proper plug. Check the recorder's instructions to be sure. Connect the cable to an external or internal VOX control so that the recorder operates when audio is present.

You can also connect the cable to the appropriate input jack on your PC so that with controlling software, you can record to your hard disk.

In order for the function to operate, you must set the channel to record. You must also set the system's record option to either All Channel, which will record all channels regardless of any channel's setting, or Marked Channel which only lets recording occur if you have selected record for that channel. Which you choose will depend on various factors.

## Vehicle Installation

You can mount your scanner in your vehicle, using either the supplied bracket or the optional DIN-E sleeve.

### Mounting Using the Bracket

With the bracket removed from the radio, use the holes in the bracket as a template to initially mark the location you plan to use in your vehicle. Be absolutely certain of what might be behind the mounting surface before making any holes, be it above, or below, or in front of your dash, armrest console, or other location. If you drill carelessly, expensive damage can result. If in doubt, consult your vehicle dealer's service department or a qualified professional installer.

**Important: AVOID AIRBAG DEPLOYMENT ZONES.** Ignoring this installation concern may result in bodily harm and the inability of the airbag to perform properly.

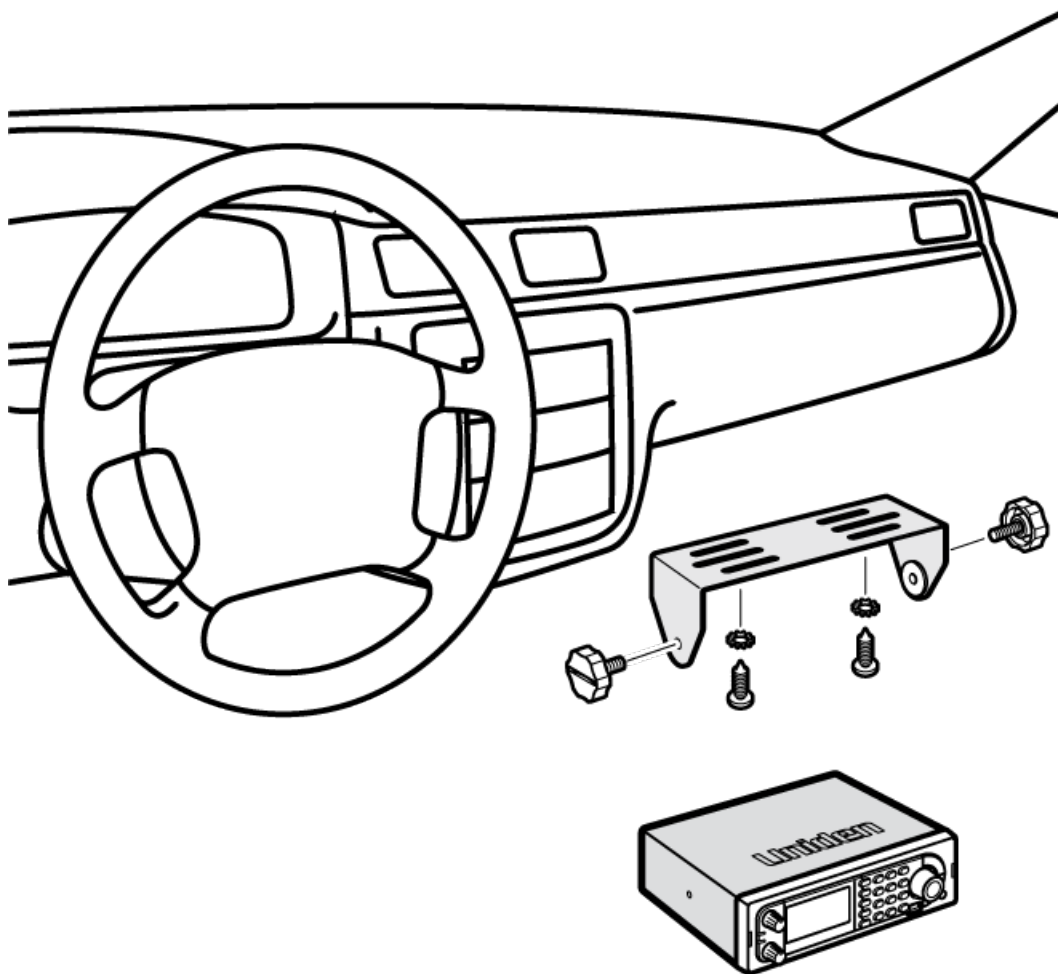

1. Using appropriate screws or other hardware, secure the bracket.
2. Insert the scanner and insert the bracket knobs to lock the scanner in position.
3. Attach the Cigarette Lighter Power Cord to the rear of the scanner and plug the adapter end into a dash mounted 12V DC socket.
4. Attach a suitable mounted mobile antenna to the antenna jack on the back of the scanner.

#### Mounting Using the DIN-E Sleeve (Option for [BCT15X](#))

If you are unsure about how to install your scanner in your vehicle using the optional DIN-E sleeve, consult your automobile manufacturer, dealer, or a qualified installer. Before installing, confirm that your scanner fits in the desired mounting area and you have all the necessary materials to complete the task. Your scanner requires a 2 x 7-1/8 x 5-5/16 inch (50 x 180 x 135 mm) mounting area. Allow an additional 2-3/8 inch (60mm) space behind the unit for connectors and wires.

To purchase the DIN-E sleeve and included Removal Keys, visit <http://www.unidendirect.com/> and order part number, DIN-0001.

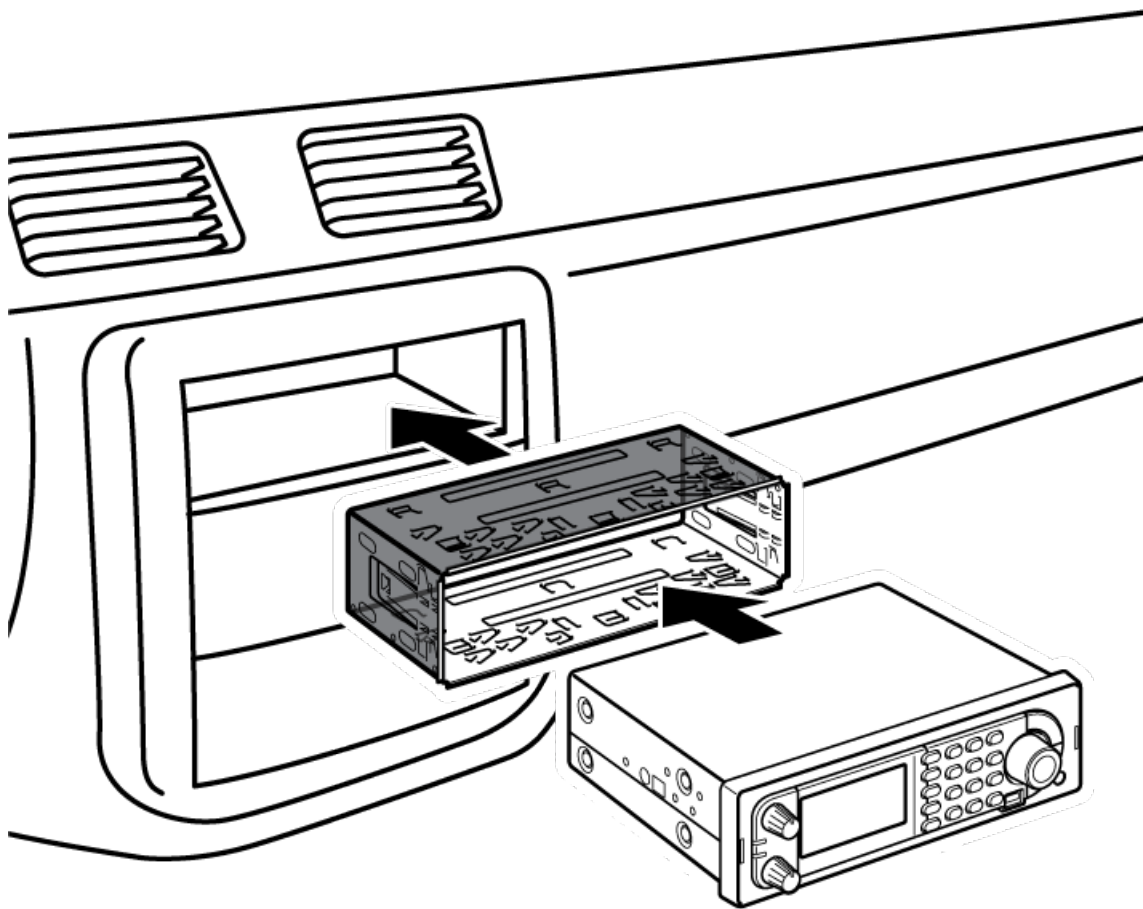

1. Remove the bracket if it is attached.
2. Remove the four Philips screws from four small tabs on the rear of the case that secure the outer metal case and pull off the case (toward the rear) with care.
3. Install the DIN sleeve into the opening in your dashboard, lip facing out.
4. Push out the top and bottom tabs to hold the sleeve firmly in place.
5. Before inserting the scanner in the sleeve, attach the cable from the previously mounted antenna. Attach the DC Power leads. RED goes to a positive (+) connection on your fuse block while BLACK connects to the vehicle's chassis ground (-).
6. Connect the ORANGE lead to one side of the headlamp switch so that when you activate the headlights, the scanner's LCD display changes intensity. Be sure all the connections are routed away from any potentially pinching or slicing sheet metal.
7. Slowly slide the scanner into the sleeve until it locks in place.
8. To remove the unit, fully insert the removal keys into each slot on the left and right edges of the front panel. Carefully slide the radio from the sleeve.

**Note:** If you plan to connect a GPS unit or external speaker at a later time, expect to remove the unit for ease of making those connections.

### Removing the Scanner from the DIN-E Sleeve

If you plan to connect other devices or wires to the radio, such as a GPS unit, at a later time, you should plan to remove the scanner from the DIN-E sleeve. This is easily done using the provided Removal Keys that come with the optional DIN-E sleeve.

Refer to the illustration that follows, showing the Removal Keys.

Fully insert both Removal Keys into the slots on the left and the right edges of the radio's dress panel. You cannot remove the radio with only one key. Press in fully, and do not twist the keys. The radio will unlock from the sleeve making withdrawal from the sleeve possible. Store the keys in a safe place for future use.

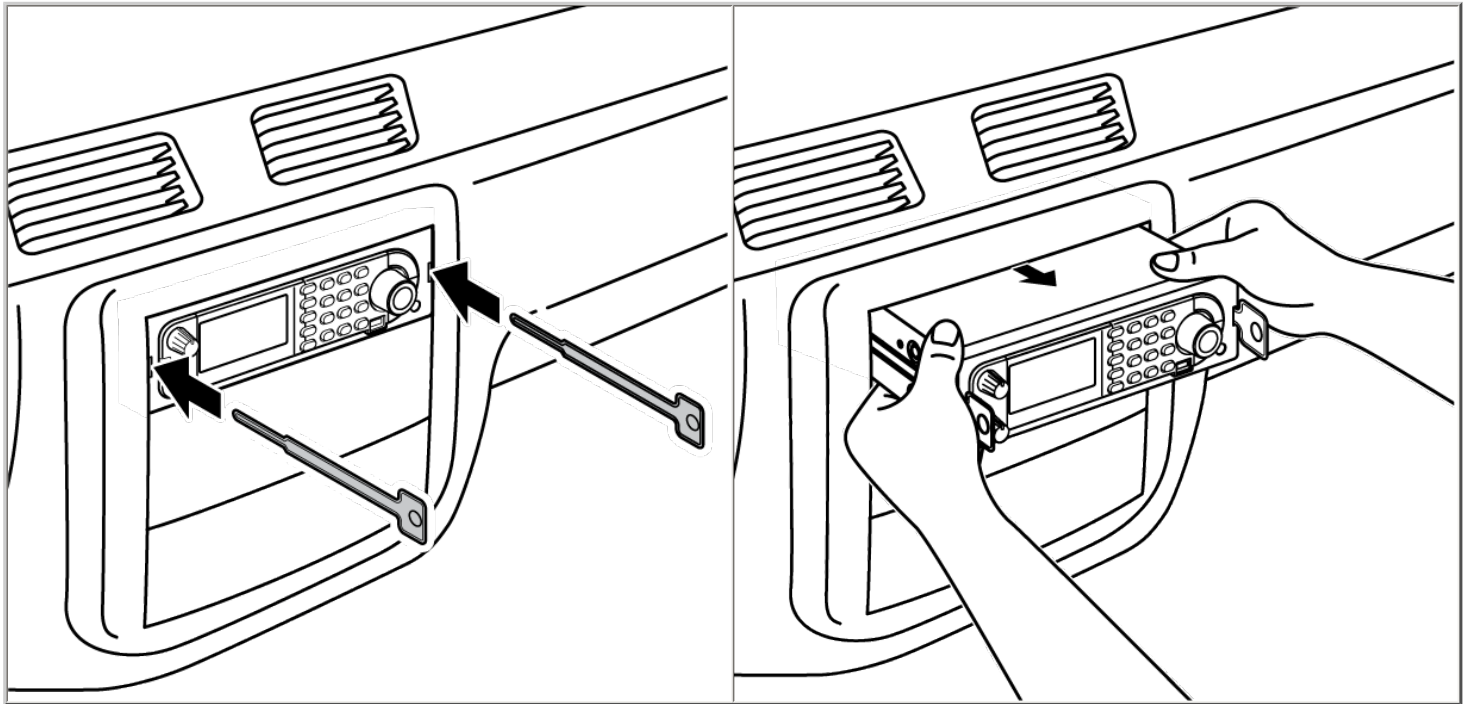

### Mounting Using ISO Technique

Some vehicles can take advantage of another approach to mounting a radio in a vehicle, called the ISO technique. However, this technique requires a very detailed and thorough knowledge of the technique. Therefore, we strongly suggest that if you have any doubt about your experience and abilities, please consult with a professional installer who is familiar with the ISO approach to radio installation.

To begin the process, it is first necessary to remove the scanner's outer metal sleeve from the inner chassis. Unthread the four screws in the rear of the unit. Slide the cover toward the rear and off. Once the sleeve is removed, you will see threaded, metric machine screw holes on either side of the chassis cabinet. Uniden does not supply these screws. Their diameter, length, and screw type should be chosen by a qualified installer based on the internal vehicle bracket which will be used in securing the scanner chassis.

Once the original radio is removed from the vehicle dash and the fit of the scanner is correct, be sure to connect all the power, audio, antenna, and any other cables or wires, to the scanner before the scanner is secured.

The following illustration is a typical example of the ISO technique and the general side mounting screw holes often encountered. It does not actually represent the Uniden scanner nor your vehicle's mounting bracket. Only a professional installer will be able to determine the best and correct approach.

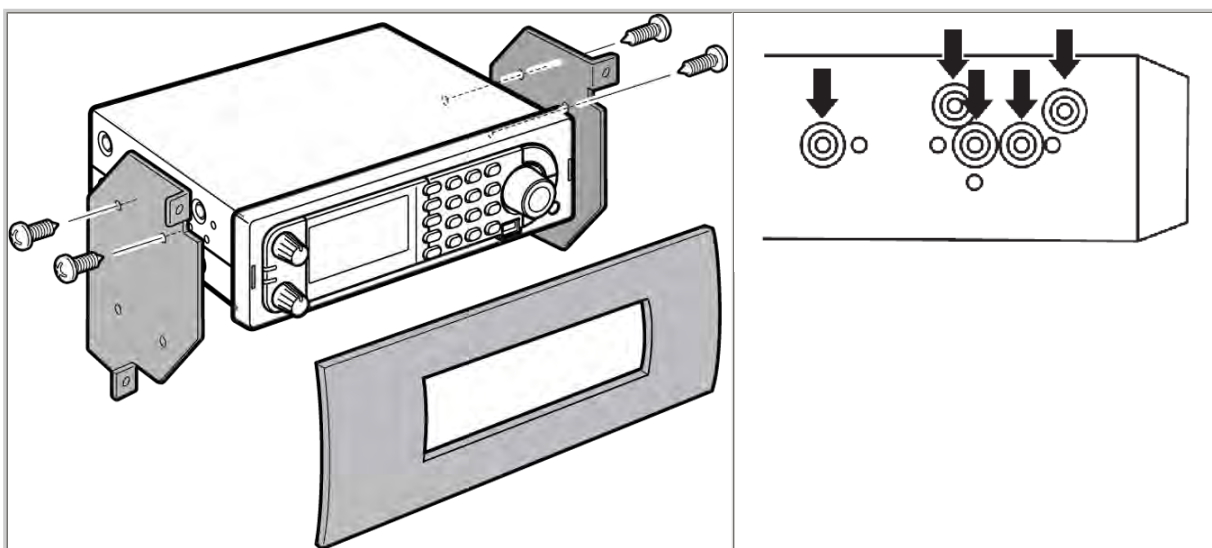

### Removing the Display Sticker

Before you use the scanner for the first time, remove the protective plastic film over the display.

## Connecting an Optional Antenna

The scanner's BNC connector makes it easy to connect a variety of optional antennas, including an external mobile antenna or outdoor base station antenna.

**Note:** Always use 50-ohm, RG-58, or RG-8, BNC terminated coaxial cable to connect an outdoor antenna. If the antenna is over 50 feet from the scanner, use RG-8 low-loss dielectric coaxial cable. Cable loss increases with higher frequency.

## Connecting an Earphone/Headphone

For private listening, you can plug a 1/8-inch (3.5 mm) mini-plug earphone or headphones (not supplied) into the headphone jack on the front of your scanner. This automatically disconnects the internal speaker. See the [Earphone Warning](#) for important information about using an earphone/headphone.

### **WARNING!**

Never connect anything other than the recommended amplified extension speaker to the scanner's headphone jack. Damage to the scanner might occur.

## Connecting an Extension Speaker

In a noisy area, an optional amplified extension speaker, positioned in the right place, might provide more comfortable listening. Plug the speaker cable's 1/8-inch (3.5-mm) mini-plug into your scanner's back-panel Ext. Sp. Jack.

### **WARNING!**

Never connect any part of the headphone jack to the antenna jack or connect the radio to an installation where the antenna and audio connection are grounded. This might also damage the scanner.

This page applies to the following scanner(s): [BCD996XT BCT15X Users Guide](#)

# Connecting a GPS receiver

To determine whether the information on this page applies to your scanner, see the tags at the bottom of the page.

- [Compatible GPS receivers](#)
- [Configuring your scanner](#)
- [Connecting the receiver](#)
- [Troubleshooting](#)

## Compatible GPS receivers

You can connect your scanner to any GPS receiver that meets the following criteria:

- Outputs NMEA-0183 v3.01-compliant location data
- Outputs both the Global Positioning System Fix ( *GGA* ) and Recommended Minimum Specific GNSS ( *RMC* ) data sentences
- Provides a serial data (RS-232) connection

## Configuring your scanner

1. Go to the [Settings](#) menu and select *Set Serial Port* .
2. Select *Set Baud Rate*.
3. Select *Set Rear Port*.
4. Select *4800* bps for the baud rate.

## Connecting the receiver



1. Plug your GPS receiver's RS232 cable directly into the DB9 connector on the back of the scanner.
2. When the scanner recognizes the GPS input, it displays a confirmation message and shows the GPS icon on the display.
3. If the GPS receiver does not have a lock on the satellites, the scanner displays *Searching for Satellite* .

## Troubleshooting

If you can't get the scanner to recognize the GPS receiver:

- Check the receiver's baud rate. Most compatible GPS receivers use a baud rate of 4800 bps, but it's possible your receiver is using a non-standard baud rate. Set the scanner's baud rate to match the GPS receiver's.
- Check the receiver's output mode. Some receivers have proprietary signalling modes that are not NMEA compliant, but you can usually set them to use a NMEA compliant mode.

If the scanner recognizes the GPS receiver but doesn't lockout systems as you expected:

- Make sure the GPS receiver has a lock on the satellites.
- Check the location configuration for the sites and channel groups in the system.
  1. For each site or channel group, go to the [Set LocationInfo](#) menu.



2. Check the range, latitude, and longitude settings to make sure they are correct.
3. Make sure the *Set GPS Enable* option is set to *Yes* .

This page applies to the following scanner(s): [BCD996XT](#) [BCT15X](#) [Users Guide](#)

# Number Tags

- Number Tags let you quickly navigate to a specific system or channel.
- You can assign Number Tags at the system level ( *System Number Tag* , or *SNT*), at the channel level ( *CHannel Number Tag* , or *CHNT*), or at both levels.
- You can assign an SNT to the temporary system *Close Call Hits* that is created during [Close Call](#) searches. This system and its SNT operate like any other system.
- You can assign Number Tags to service searches and custom search ranges. These search Number Tags operate like regular SNTs.
- [Programming Number Tags](#)
  - [Assigning an SNT](#)
  - [Assigning a CHNT](#)
- [Using Number Tags](#)

## Programming Number Tags

### Assigning an SNT

- SNTs can range from 0 to 999 .
- Systems can have the same SNT, but you will get a warning when you create multiples. (This includes SNTs assigned to the Close Call Hits system or any search ranges.)

#### To a system :

1. Open the [Program System](#) menu.
2. Select the system you want to assign the number tag to.
3. Select [Edit Sys Option](#), then select [Set Number Tag](#).
4. Enter the number tag you want to use for this system.

#### To the Close Call Hits system :

1. Open the [Close Call](#) menu.
2. Select [Hits with Scan](#), then select [Set Number Tag](#).

3. Enter the number tag you want to use for the Close Call Hits system.

### To a service search range :

1. Open the [Search for...](#) menu.
2. Select [Edit Service](#), then select the service search range you want to assign the number tag to.
3. Select [Search with Scan](#), then select [Set Number Tag](#).
4. Enter the number tag you want to use for this search range.

### To a custom search range :

1. Open the [Search for...](#) menu.
2. Select [Edit Custom](#), then select the custom search range you want to assign the number tag to.
3. Select [Search with Scan](#), then select [Set Number Tag](#).
4. Enter the number tag you want to use for this custom search range.

## Assigning a CHNT

- You can assign CHNTs to channels even if the system does not have an assigned SNT. However, without an SNT, you can only navigate to these channels from within that system itself.
- CHNTs can be duplicated within their own system, but you will see a warning when you create multiples.
- CHNTs can range from 0 to 999 .

1. Open the [Program System](#) menu.
2. Select the system containing the channel you want to assign the number tag to.
3. Select [Edit Group](#), then select the channel group you want.
4. Select [Edit Channel](#), then select the channel you want to assign the number tag to.
5. Select [Set Number Tag](#).
6. Enter the number tag you want to use for this channel.

## Using Number Tags

To navigate directly to:	Key Sequence	Example
<b>A system or search range</b>	<ol style="list-style-type: none"> <li>1. Tap <b>HOLD</b>.</li> <li>2. Enter the SNT + •.</li> <li>3. Tap <b>MENU</b>.</li> </ol>	If the SNT is 4 , enter <b>HOLD / 4 / • / MENU</b> .
<b>A channel in the current system</b>	<ol style="list-style-type: none"> <li>1. Tap <b>HOLD</b>.</li> <li>2. Enter the CHNT.</li> <li>3. Tap <b>MENU</b>.</li> </ol>	If the CHNT is 27, enter <b>HOLD / 27 / MENU</b> .
<b>A channel in a different system</b>	<ol style="list-style-type: none"> <li>1. Tap <b>HOLD</b>.</li> <li>2. Enter the SNT <i>followed by the decimal point</i>.</li> <li>3. Enter the CHNT.</li> <li>4. Tap <b>MENU</b>.</li> </ol>	If the SNT is 4 and the CHNT is 27, enter <b>HOLD / 4 / • / 27 / MENU</b> .

## Notes:

- If two systems have the same SNT, they will be selected in sequence (i.e. the first time you select the SNT, the scanner will go to the first system assigned with that SNT; if you select the same SNT again, it will go to the 2nd system assigned with that SNT, and so on).
- If two channels in the same system have the same CHNT, they will be selected in sequence (i.e. the first time you select the CHNT, the scanner will go to the first channel in that system assigned with that CHNT; if you select the same CHNT again, it will go to the 2nd channel assigned with that CHNT, and so on).

This page applies to the following scanner(s): [BCD996XT](#) [BCT15X](#) [BCD396XT](#) [BC346XT](#) [Users Guide](#)

# Quick Keys

- Quick Keys let you enable or disable systems and channel groups during a scan. Disabled systems and channel groups are ignored during scans.
- You can assign Quick Keys at the system/site level ( *System/site Quick Key* , or *SQK* ), at the channel group level ( *Group Quick Key* , or *GQK* ), or at both levels.
- You can assign an SQK to the temporary system *Close Call Hits* that is created during [Close Call](#) searches. This system and its SQK operate like any other system.
- You can assign Quick Keys to service searches and custom search ranges. These search Quick Keys operate like regular SQKs.
- [Programming Quick Keys](#)
  - [Assigning an SQK](#)
  - [Assigning a GQK](#)
- [Using Quick Keys](#)
  - [To use SQK 0 through 9](#)
  - [To use SQK 10 through 99](#)
  - [To use a GQK](#)

## Programming Quick Keys

### Assigning an SQK

- Multiple systems, sites, and search ranges can share the same SQK.
- All systems and sites assigned to the same SQK will be enabled (or disabled) when you enter the Quick Key.
- SQKs range from 0 to 99 .

#### To a conventional system:

1. Open the [Program System](#) menu.
2. Select the system you want to assign the Quick Key to.
3. Select [Edit Sys Option](#), then select [Set Quick Key](#).
4. Enter the Quick Key you want to use for this system.

### **To a trunked system:**

1. Open the [Program System](#) menu.
2. Select the system you want to assign the Quick Key to.
3. Select [Edit Site](#), then select the site you want.
4. Select [Set Quick Key](#), then enter the Quick Key you want to use for this site.

### **To the Close Call Hits system :**

1. Open the [Close Call](#) menu.
2. Select [Hits with Scan](#), then select Set Quick Key? .
3. Enter the Quick Key you want to use for the Close Call Hits system.

### **To a service search range :**

1. Open the [Search for...](#) menu.
2. Select [Edit Service](#), then select the service search range you want to assign the Quick Key to.
3. Select [Search with Scan](#), then select [Set Quick Key](#).
4. Enter the Quick Key you want to use for this search range.

### **To a custom search range :**

1. Open the [Search for...](#) menu.
2. Select [Edit Custom](#), then select the custom search range you want to assign the Quick Key to.
3. Select [Search with Scan](#), then select [Set Quick Key](#).
4. Enter the Quick Key you want to use for this custom search range.

## **Assigning a GQK**

- All channels in the channel group will be enabled (or disabled) when you enter the GQK.
- Multiple channel groups in the same system can share the same GQK. However, all of these channel groups will be enabled (or disabled) when you enter the GQK from within that system.
- You can assign GQKs to channel groups even if their system does not have an assigned SQK.

- You can only use GQKs within the current system: the GQK will not affect a channel group in another system.
  - GQKs range from 0 to 9 .
1. Open the [Program System](#) menu.
  2. Select the system containing the channel group you want to assign the Quick Key to.
  3. Select [Edit Group](#), then select the channel group you want.
  4. Select [Set Quick Key](#), then enter the Quick Key you want to use for this channel group.

## Using Quick Keys

- Quick Keys only work in Scan mode.
- Entering the Quick Key toggles the enabled/disabled state of the system/site/search range or channel group (i.e., if the system is currently enabled, entering the Quick Key will disable it, and vice-versa).

### To use SQK 0 through 9

- Enter Scan mode.
- Tap the number key that matches the SQK. (For example, if the SQK is 4, just enter 4.)
- Any systems, sites, or search ranges assigned to this SQK become disabled. (If they were already disabled, they become enabled.)

### To use SQK 10 through 99

- Enter Scan mode.
- Tap the decimal point ( **.NO** ), then enter the SQK. (For example, if the SQK is 32 , enter **.NO / 32.**)
- Any systems, sites, or search ranges assigned to this SQK become disabled. (If they were already disabled, they become enabled.)

### To use a GQK

- Enter Scan mode.
- Go to the system that contains the channel group you want to enable or disable.

- Tap **FUNCTION** , then tap the number key that matches the GQK. (For example, if the GQK is 7 , enter **FUNCTION / 7**.)
- Any channel groups assigned to this GQK *within the current system only* become disabled. (If they were already disabled, they become enabled.)

This page applies to the following scanner(s): [BCD996XT](#) [BCT15X](#) [BCD396XT](#)  
[BC346XT Users Guide](#)



## Search Keys

The scanner has three Search Keys that you can assign to a special search range; the Search Keys are set to number keys **1** , **2** , and **3** :



Search Key 1



Search Key 2



Search Key 3

## Programming Search Keys

1. Open the [Search for...](#) menu.
2. Select [Set Search Key](#), then select the search key you want to program.
3. Select the search range you want to assign to this Search Key. Choose one of the pre-programmed service search ranges, one of the 10 custom search ranges, a Tone-Out search, or a Band Scope search.

## Using Search Keys

To start the search assigned to a Search Key, **FUNCTION** + tap that Search Key. For example, to start the search assigned to Search Key 2, **FUNCTION** + tap **2** .

(You can't use the Search Keys when the scanner is in Scan mode or GPS mode.)

If the Search Key you select starts a Tone-Out search, the scanner switches to Tone-Out mode and searches the most-recently-used Tone-Out channel (out of the 10 available). If you want to search a different Tone-Out channel, use the **SELECT-VOLUME-SQUELCH** knob on handheld models or the **SCROLL / FUNCTION** knob on mobile models to select the Tone-Out channel you want to use.

This page applies to the following scanner(s): [BCD996XT](#) [BCT15X](#) [BCD396XT](#)  
[BC346XT](#) [Users Guide](#)

# Programming locations

To use [Location-based Scanning](#) with a particular system, you will need to program your scanner with the geographic coordinates you want to use for each site or channel group. You can also program your scanner to alert you when you approach particular locations.

- [Programming a location for a site](#)
- [Programming a location for a channel group](#)
- [Programming general locations](#)
  - [To create a new location](#)
  - [For Dangerous Xing and Dangerous Roads only](#)
  - [Edit an existing location](#)

## Programming a location for a site

Each system site can have separate location information.

1. Open the [Program System](#) menu.
2. Select the system you want to program for location based scanning.
3. Select [Edit Site](#), then select the first site you want to assign a location to.
4. Select the [Set LocationInfo](#) menu and enter the latitude, longitude, and range for this site.
5. Change the *Set GPS Enable* field to *On* .
6. Go back to the [Edit Site](#) menu and repeat these steps with any other sites you want to program for this system.

## Programming a location for a channel group

Each channel group in a system can have separate location information.

1. Open the [Program System](#) menu.
2. Select the system you want to program for location based scanning.
3. Select [Edit Group](#), then select the first channel group you want to assign a location to.
4. Select the [Set LocationInfo](#) menu and enter the latitude, longitude, and range for this site.
5. Change the *Set GPS Enable* field to *On* .
6. Go back to the [Edit Group](#) menu and repeat these steps with any other sites you want to program for this system.

Remember: You have to turn on *Set GPS Enable* before the location information

can effect that site or channel group.

## Programming general locations

You can program general locations (i.e., locations that are not associated with a site or channel group). There are three types of general locations:

- points of interest ( *POI* )
- intersections ( *Dangerous Xing* )
- roads ( *Dangerous Road* )

You can program the scanner to alert you when you come within a designated distance of that location.

### To create a new location

1. Open the [Program Location](#) menu.
2. Select the type of location you want to create.
3. Select *New Location* to create a new location of this type.
4. \*If you want to create a different type of location, go back to the [Program Location](#) menu and select that location type.
5. If you want to change the default location name, select *Edit Name?* and enter a new name.
6. Select *Set LocationInfo?* and enter the latitude and longitude for this location.
7. Select *Set Range* and enter the distance from this location you want the scanner to alert you.
8. Choose the *Alert Tone* and *Alert Light* you want the scanner to use when you come within range of this location.

### For Dangerous Xing and Dangerous Roads only

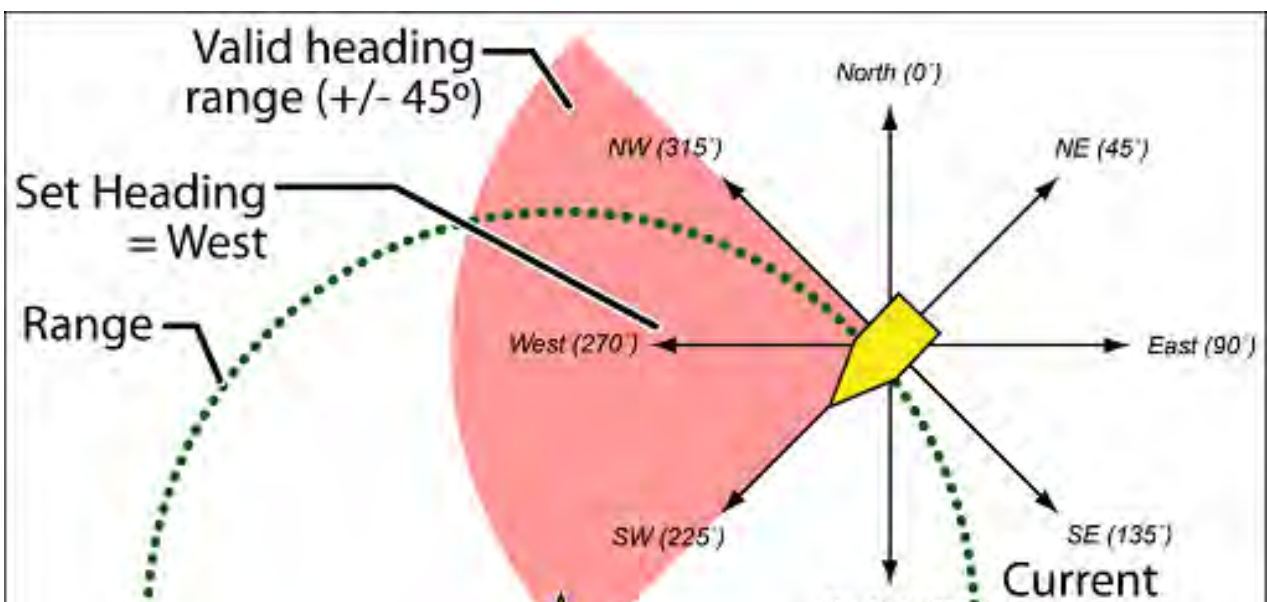

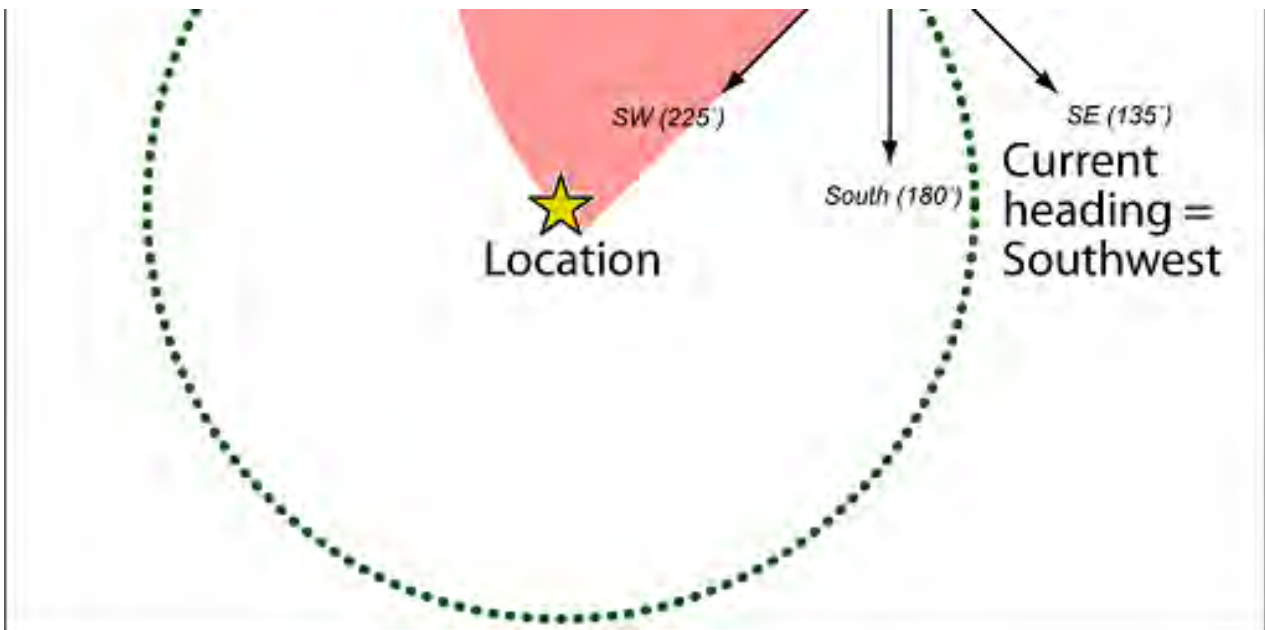

In addition to range, you can specify a heading and a speed limit for these types of locations:

- If you set a speed limit, the scanner will only trigger an alert when you are within the location's range *and* your current speed is over the programmed speed limit.
- If you set a heading, the scanner will only trigger an alert when you are within the location's range *and* your current heading is +/- 45 degrees from the programmed heading. (For example, if you set the heading as *North* , the scanner will trigger an alert if your current heading is *North-east* but not if your current heading is due *East* .)

## Edit an existing location

1. Open the [Program Location](#) menu.
2. Select the type of location you want to edit; the scanner lists the existing locations of that type in alphabetical order.
3. Select the location you want to edit, then change any of the location settings you want.

This page applies to the following scanner(s): [BCD996XT](#) [BCT15X](#) [BCD396XT](#) [BC346XT](#)  
[Users Guide](#)

# Setting alerts

Your scanner can trigger alerts for several different events. The table below shows the different alerts and how to program them:

To sound an alert when	Follow these steps
A channel becomes active	Edit the channel properties ( <a href="#">Edit Channel#Set Alert</a> ): <ol style="list-style-type: none"> <li>1. Go to the <i>Program System</i> menu and select the system that contains the channel you want set the alert for.</li> <li>2. Select <i>Edit Group</i> , then select the group you want.</li> <li>3. Select <a href="#">Edit Channel</a>, then select the channel you want to set the alert for.</li> <li>4. Select <i>Set Alert</i> .</li> <li>5. Choose the <i>Alert Tone</i> and <i>Alert Light</i> you want the scanner to use.</li> </ol>
An active Talk Group on a system contains an emergency flag	Edit the system properties ( <a href="#">Edit Sys Option#Emergency Alert</a> ): <ol style="list-style-type: none"> <li>1. Go to the <i>Program System</i> menu and select the system you want set the alert for.</li> <li>2. Select <a href="#">Edit Sys Option</a>, then select <i>Emergency Alert</i> .</li> <li>3. Choose the <i>Alert Tone</i> and <i>Alert Light</i> you want the scanner to use.</li> </ol>

<p>The scanner detects a Close Call hit</p>	<p>Edit the <a href="#">Close Call</a> properties:</p> <ol style="list-style-type: none"> <li>1. Go to the <i>Close Call</i> menu.</li> <li>2. Select <i>Set CC Alert</i> .</li> <li>3. Choose the <i>Alert Tone</i> and <i>Alert Light</i> you want the scanner to use.</li> <li>4. For Close Call Alerts, you can also have the scanner pause before it resumes searching. Select <i>Set CC Pause</i> to activate this feature.</li> </ol>
<p>The scanner gets a hit on a Tone-Out channel</p>	<p>Edit the Tone-Out channel properties:</p> <ol style="list-style-type: none"> <li>1. Go to the <a href="#">Tone-Out for...</a> menu.</li> <li>2. Select <i>Tone-Out Setup</i> , then select the Tone-Out channel you want to set the alert for.</li> <li>3. Select <i>Set Alert</i> .</li> <li>4. Choose the <i>Alert Tone</i> and <i>Alert Light</i> you want the scanner to use.</li> </ol>
<p>You approach a particular location</p> <ul style="list-style-type: none"> <li>● Point of Interest( <i>POI</i> )</li> <li>● Dangerous Road</li> <li>● Dangerous Intersection ( <i>Dangerous Xing</i> )</li> </ul>	<p>Edit the location properties:</p> <ol style="list-style-type: none"> <li>1. Go to the <a href="#">Program Location</a> menu and select the type of location you want set the alert for.</li> <li>2. Select the particular location.</li> <li>3. For a POI, select <i>Set Alert</i> , then choose the Alert Tone and the Alert Light you want to use.</li> <li>4. For a Dangerous Road or Xing, the alert tone is preset. Select the Alert Volume and the Alert Light you want to use.</li> </ol>

NOTE: The scanner also triggers alerts for Weather Alerts ([WX Operation#Weather Alerts](#)), but you can't edit the alert tone and light.

This page applies to the following scanner(s): [BCD996XT](#) [BCT15X](#) [BC346XT](#)  
[BCD396XT Users Guide](#)



# Using Quick Keys, Startup Keys, and Search Keys

The different shortcut keys have different functions:

## Quick Keys

- Quick keys let you enable and disable systems and channel groups (disabled systems and channel groups are ignored during scans).
- You must be in Scan mode to use Quick Keys.
- System Quick Keys (SQKs) let you enable or disable systems, sites or search ranges: just enter the SQK from the number pad.
- Group Quick Keys (GQKs) let you enable or disable channel groups inside the current system: Tap **FUNCTION** , then enter the GQK from the number pad.

## Startup Keys

- Startup Keys let you lock and unlock several systems, sites, and search ranges all at the same time.
- When you activate a Startup Key, the scanner unlocks all systems, sites, and search ranges that are assigned to that same Startup Key; the scanner also locks all systems, sites, and search ranges that are assigned to a different Startup Key.
- To activate a Startup Key, press & hold the number key while you power the scanner on.

## Search Keys

- Search Keys let you quickly start one of 3 programmed searches.
- To start the search assigned to a Search Key, **FUNCTION** + tap that Search Key.

This page applies to the following scanner(s): [BCD996XT](#) [BCT15X](#) [BCD396XT](#)  
[BC346XT](#) [Users Guide](#)

# BCT15X Features

## Limits

- Channels: 9,000 maximum
- Systems: 500 maximum
- Sites: 1000 maximum, 256 maximum per system
- Groups per system: 20 maximum
- Talkgroups per trunked system: 500 maximum
- Scan Rate: 100 channels per second (conventional mode)
- System Quick Key range: 0-99
- Group Quick Key range: 0-9
- Custom Search Ranges: 10
- Startup Keys: 10
- Channel Number Tags: 999
- System Number Tags: 999
- Preprogrammed Service Search Bands: 12
- Band Scope Range: 0.2 to 500 MHz
- Band Scope Steps: 5 kHz to 100 kHz

## Frequency Coverage

- 25 - 512 MHz
- 758 - 823.9875 MHz
- 849.0125 - 868.9875 MHz
- 894.0125 - 960 MHz
- 1240 - 1300 MHz

## Features

- TrunkTracker III -- tracks the following trunked systems:
  - Motorola Type I 800
  - Motorola Type II 800, 900, UHF, VHF (including rebanded 800 MHz systems)
  - EDACS Wide (standard), Narrow, SCAT (including systems that use an EDACS System Key)

## ○ LTR

- BearTracker warning system
- Location-Based scanning automatically selects programmed systems based on your location when connected to a compatible GPS receiver.
- Temporary lockout automatically unlocks channels when you cycle power.
- Startup Configurations let you automatically lock out or unlock systems on power up to quickly configure the scanner for a different area or application.
- Alert Plus mode -- silences the scanner except for channels that have assigned alerts.
- Channel Number Tagging -- lets you quickly select a channel.
- State-by-State Preprogrammed Channels - let you easily keep up with activity on local police, Department of Transportation, and Highway Patrol frequencies when you travel, without having to program any channels.
- Close Call, with Close Call Do Not Disturb, Close Call Priority (or Primary), and Close Call Temporary Store.
- Fire Tone Out Alert
- Fire Tone-Out Search -- determines the tones received for easy tone-out programming.
- Motorola Control Channel Only trunking
- DCS/CTCSS Rapid Decode
- Channel Volume Offset
- Band Scope
- Search with Scan
- Frequency/ID AutoStore - automatically store frequencies from a service or limit search into a conventional system or store talk group IDs into a trunked system
- 16 character text tagging for each system, site, group, channel, talkgroup, search range, GPS location, tone-out, and SAME group
- Compatible with BC-RH96 Remote Head
- Quick Search
- Service Search - lets you select from Public Safety, News, HAM Radio, Marine, Railroad, Air, Citizens Band Radio, FRS/GMRS, Racing, FM Broadcast, Military Air, and Special (Itinerant)
- Custom Search - lets you program up to 10 search ranges
- 500 (250 Temporary + 250 Permanent) Search Lockouts
- SAME Weather Alert
- Weather Priority
- Priority Scan with Priority Plus
- Signal Strength display
- Trunking Activity Indicators
- Adjustable scan delay

- Negative Channel Dropout Delay (Forced Resume)
- Adjustable Hold (scan duration 0-255 sec) per system, custom or service search
- Strong signal attenuation
- Upgradeable firmware
- Channel Alert
- Independent Alert Tone Volume - lets you set the volume level of the following tones: Key Beep, Emergency Alert, Channel Alert, and Close Call Alert.
- Repeater Reverse
- Broadcast signal ignore while searching (TV and radio station frequencies, pagers, etc)
- Quick Recall - quickly navigates to a specific Channel by choosing the System, Group, and Channel.
- DIN-E and ISO Vehicle Mountable (DIN-E sleeve not included optional)
- Reversible Display - Lets you reverse the display to mount unit upside down (and hear the speaker from the top)
- Record Out - you can connect an output jack to a VOX controlled recorder or PC sound input to record the received audio.
- Duplicate Channel Alert
- PC Programming and Control
- Wired Cloning
- Power requirements: 11.0V to 16.6V DC
- Antenna Connector: BNC

# BCT15X Specs

To determine whether the information on this page applies to your scanner, see the tags at the bottom of the page.

- Certified in accordance with FCC Rules and Regulations Part 15 Subpart C as of date of manufacture. (See [FCC Information](#) for more details.)
- FCC ID: AMWUB361
- [BCT15X Specs](#)
  - [General](#)
  - [Frequency Range](#)
  - [Special Functions](#)
    - [Band Scope Function](#)
    - [Two-Tone-Sequential](#)
    - [WX Alert](#)
  - [Supported trunking systems](#)
  - [Dynamic memory allocation capacity](#)
  - [Heterodyne System](#)
  - [CTCSS and DCS Tones](#)

## General

<b>Attenuation</b>	20dB nominal
<b>Audio Output Power</b>	3W nominal into 8 $\Omega$ speaker
	30mW nominal into 32 $\Omega$ stereo headphone
<b>Scan Rate</b>	100 channels per second max (Conventional mode)
<b>Search Rate</b>	300 steps per second max (5kHz steps only)
<b>External Jacks</b>	Antenna Jack: BNC Type

	Phone Jack: 3.5mm (1/8 in.) Stereo Type
	Ext.SP Jack: 3.5mm (1/8 in.) Monaural Type
	REC.Out Jack: 3.5mm (1/8 in.) Stereo Type
	Ext. DC Power and Orange Wire Jack 3 pin (Center Orange Wire)
	DC Power Jack: 5.5mm (1/5 in.) (Center Positive)
	GPS/Remote Interface Jack: D Sub 9pin Male Type
	Remote Interfase Jack (front panel): 4-pin Mini Custom Type
<b>Internal Speaker</b>	8.0Ω 5.0W Max. 77mm (3.0 in.)
<b>Power Requirements</b>	DC:11V to 16.6V(Ext.DC Power Jack or DC Power Jack)
	AC Adapter (13.8V DC 750mA Regulated) (AD-1009)
<b>Operating Temperature</b>	Nominal: -20°C to +60°C -4°F to +140°F
	Close Call: -10°C to +60°C +14°F to +140°F
<b>Size</b>	7.2 in.(W) x 5.9 in.(D) x 2.2 in.(H)
<b>Weight</b>	3.42 lbs
<b>Remote Functions</b>	Direct PC control
	Database management
	Wired cloning
<b>Display</b>	64 x 128 Full Dot Matrix LCD with Orange-color back light

<b>Sensitivity (nominal) 12dB SINAD</b>		
0.4•V	25-27.995 MHz	AM
0.3•V	28-53.98 MHz	NFM
0.6•V	54-71.95 MHz	WFM
0.2•V	72-75.995 MHz	FM
0.5•V	76-107.9 MHz	FMB
0.3•V	108-136.9916 MHz	AM
0.3•V	137-173.9875 MHz	NFM
0.5•V	174-215.95 MHz	WFM
0.3•V	216-224.98 MHz	NFM
0.3•V	225-379.975 MHz	AM
0.3•V	380-512 MHz	NFM
0.3•V	758-960 MHz	NFM
0.4•V	1240-1300 MHz	NFM

<b>Signal Noise Ratio (nominal)</b>		
48dB	25-27.995 MHz	AM
41dB	28-53.98 MHz	NFM

54dB	54-71.95 MHz	WFM
48dB	72-75.995 MHz	FM
60dB	76-107.9 MHz	FMB
50dB	108-136.9916 MHz	AM
41dB	137-173.9875 MHz	NFM
54dB	174-215.95 MHz	WFM
41dB	216-224.98 MHz	NFM
50dB	225-379.975 MHz	AM
40dB	380-512 MHz	NFM
41dB	758-960 MHz	NFM
37dB	1240-1300 MHz	NFM

<b>Close Call Sensitivity (nominal)</b>	
160•V	VHF Low1 Band
110•V	VHF Low2 Band
90•V	Air Band
90•V	VHF High1 Band
100•V	VHF High2 Band



110•V	UHF Band
160•V	800MHz+ Band

## Frequency Range

Frequency Range (MHz)	Modulation	Step (kHz)	Name
25.0000-26.9600	AM	5	Petroleum Products & Broadcast Pickup
26.9650-27.4050	AM	5	CB Class D Channel
27.4100-27.9950	AM	5	Business & Forest Products
28.0000-29.6800	NFM	20	10 Meter Amateur Band
29.7000-49.9900	NFM	10	VHF Low Band
50.0000-53.9800	NFM	20	6 Meter Amateur Band
54.0000-71.9500	WFM	50	VHF TV
72.0000-75.9950	FM	5	Intersystem & Astronomy
76.0000-87.9500	WFM	50	VHF TV
88.0000-107.9000	FMB	100	FM Broadcast
108.0000-136.9916	AM	8.33	Aircraft Band
137.0000-143.9875	NFM	12.5	Military Land Mobile
144.0000-147.9950	NFM	5	2 Meter Amateur Band

148.0000-150.7875	NFM	12.5	Military Land Mobile
150.8000-161.9950	NFM	5	VHF High Band
162.0000-173.9875	NFM	12.5	Federal Government
174.0000-215.9500	WFM	50	VHF TV
216.0000-224.9800	NFM	20	1.25 Meter Amateur Band
225.0000-379.9750	AM	25	Military Aircraft Band
380.0000-399.9875	NFM	12.5	Military Land Mobile
400.0000-405.9875	NFM	12.5	Miscellaneous
406.0000-419.9875	NFM	12.5	Federal Government Land Mobile
420.0000-449.9875	NFM	12.5	70 cm Amateur Band
450.0000-469.9875	NFM	12.5	UHF Standard Band
470.0000-512.0000	NFM	12.5	UHF TV
758.0000-787.99375	NFM	6.25	Public Service Band
788.0000-805.99375	NFM	6.25	Public Service Band
806.0000-823.9875	NFM	12.5	Public Service Band
849.0125-868.9875	NFM	12.5	Public Service Band
894.0125-960.0000	NFM	12.5	Public Service Band
1240.0000-1300.0000	NFM	25	25 cm Amateur Band

## Special Functions

### Band Scope Function

- Frequency Span 0.2 MHz To 500 MHz
- Frequency Step 5 kHz To 100 kHz

### Two-Tone-Sequential

- 250.0-3500.0Hz , 0.1Hz Step Programmable

### WX Alert

- 1050 Hz Tone System
- NWR-SAME System (Warning / Watch / Advisory)

## Supported trunking systems

- Motorola Systems: Type I, II, II/I (hybrid)
- EDACS Systems: FM, NFM, and SCAT
- LTR Systems

## Dynamic memory allocation capacity

- Systems: 500 max
- Groups: 20 per system
- Site: 1000 max (All) 256 per system
- Channels: 9000 max (21120 memory blocks)
- Channels per Trunked System: 500 max

## Heterodyne System

- 1st IF: 380.7 to 380.8 MHz / 265.5 to 265.6 MHz
- 2nd IF: 10.8 MHz
- 3rd IF: 450 kHz

## CTCSS and DCS Tones

**CTCSS Tone Frequencies - 50 frequencies total (Hz)**

67.0	69.3	71.9	74.4	77.0	79.7	82.5	85.4	88.5	91.5
94.8	97.4	100.0	103.5	107.2	110.9	114.8	118.8	123.0	127.3
131.8	136.5	141.3	146.2	151.4	156.7	159.8	162.2	165.5	167.9
171.3	173.8	177.3	179.9	183.5	186.2	189.9	192.8	196.6	199.5
203.5	206.5	210.7	218.1	225.7	229.1	233.6	241.8	250.3	254.1

**DCS Tone Codes - 104 codes total**

023	025	026	031	032	036	043	047
051	053	054	065	071	072	073	074
114	115	116	122	125	131	132	134
143	145	152	155	156	162	165	172
174	205	212	223	225	226	243	244
245	246	251	252	255	261	263	265
266	271	274	306	311	315	325	331
332	343	346	351	356	364	365	371
411	412	413	423	431	432	445	446
452	454	455	462	464	465	466	503
506	516	523	526	532	546	565	606

612	624	627	631	632	654	662	664
703	712	723	731	732	734	743	754

---

This page applies to the following scanners: [BCT15X Users Guide](#)

# Menu tree

## BCT15X main menu

- [Program System](#)
- [Program Location](#)
- [Srch/CloCall Opt](#)
- [Search for...](#)
- [Set Bear Tracker](#)
- [Close Call](#)
- [Priority Scan](#)
- [WX Operation](#)
- [Tone-Out for...](#)
- [Wired Clone](#)
- [Settings](#)

## Using the menu

- To open the menu, tap **MENU** .
- Turn the **Scroll/Function** knob to move the cursor and highlight menu items. The currently highlighted item appears in reversed-out text.
- To select the highlighted item or confirm an option setting, tap **E-YES** or press down on the **Scroll/Function** knob.
- To cancel an option setting, press **NO** .
- To go back one level in the menu, tap **MENU** .
- To exit the menu, press **LOCKOUT** . The scanner goes back to the operating mode it was in before you entered the menu.

This page applies to the following scanner(s): [BCT15X Users Guide](#)

## Keys and their functions

- [Key Overview](#)
- [Operating the controls](#)
  - [Using the FUNCTION button](#)
- [Key functions in different operation modes](#)

### Key Overview

The diagram below shows the keys and what they are called throughout the guide:

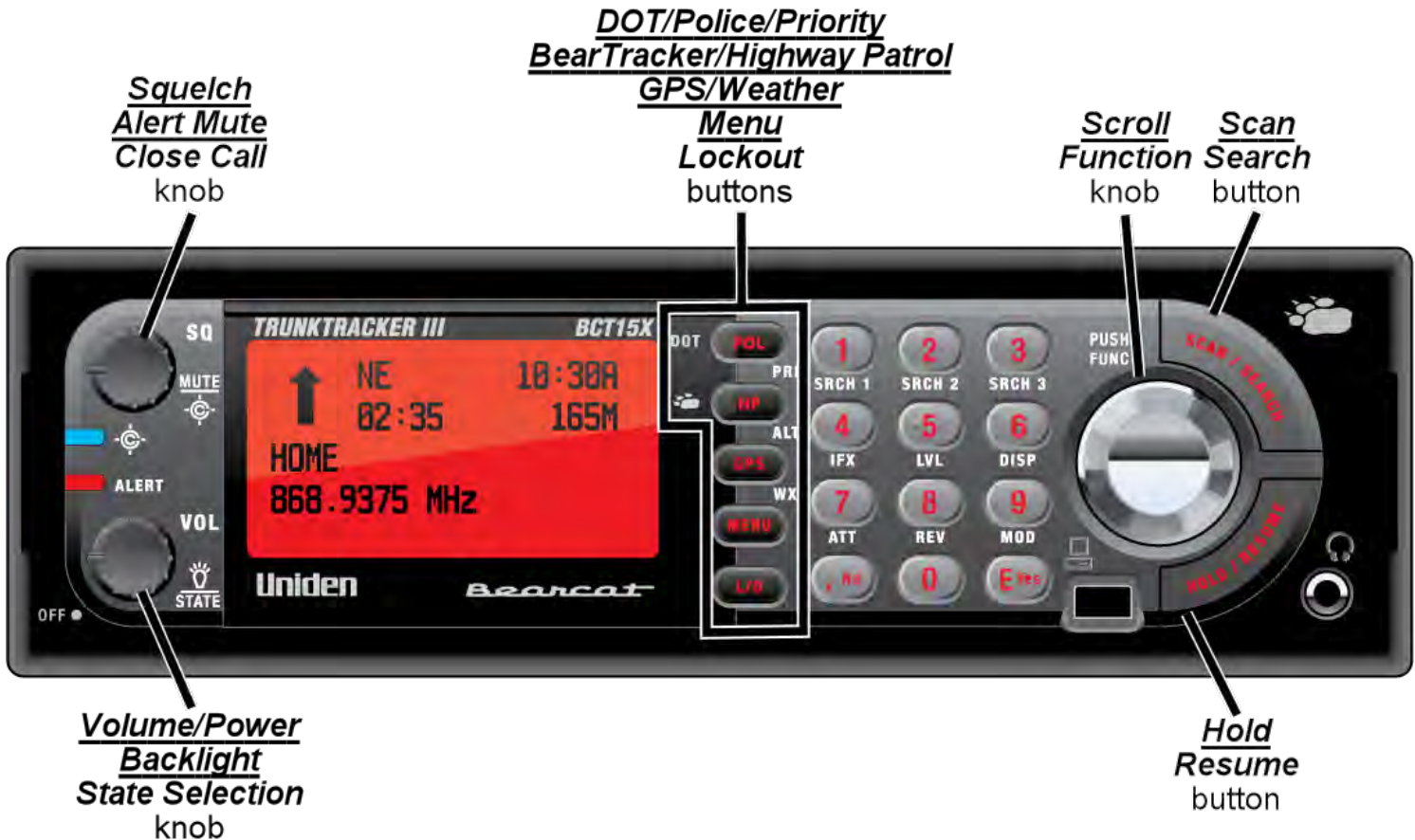

### Operating the controls

Each button has at least two different actions which you control using the key combinations explained below.

- **Tap** : press the button and release it immediately
- **Double tap** : press the button twice, as quickly as possible (within 1 second)
- **Press & hold** : press the button and keep it pressed for at least 2 seconds before releasing it
- **FUNCTION + tap** : press and release **FUNCTION** , then tap the button
- **FUNCTION + Double tap** : press and release **FUNCTION** , then double tap the button
- **FUNCTION + Press & hold** : press and release **FUNCTION** , then press and hold the button

### Using the FUNCTION button

When you tap FUNCTION (the scroll knob), the scanner remembers the **FUNCTION** + key combination for the next 3 seconds; during this time, it displays an *F* icon at the top of the screen.

If you want the scanner to maintain the **FUNCTION** + key combination longer, press & hold FUNCTION. The scanner remembers the **FUNCTION** + key combination until the next time you tap FUNCTION; during this time, it displays *Function Key Holding* and flashes the *F* icon at the top of the screen.

## Key functions in different operation modes

The keys have different functions in each operation mode:

- [Scan and Search mode key functions](#)
- [Hold mode key functions](#)
- [Close Call mode key functions](#)
- [Priority Scan mode key functions](#)
- [GPS mode key functions](#)
- [Tone Out mode key functions](#)
- [Band Scope mode key functions](#)
- [Available functions in Key Safe mode](#)

This page applies to the following scanner(s): [BCT15X Users Guide](#)



# BCT15X displays

This page applies to the [BCT15X](#). For other models, see:

- [BCD396XT and BCD996XT Reading the Display](#)
- [BC346XT Reading the Display](#)

The display icons vary depending on the status of the scanner and what you're doing at any given time. The diagram shows common icon locations, and table below lists the most common icons and their meanings:

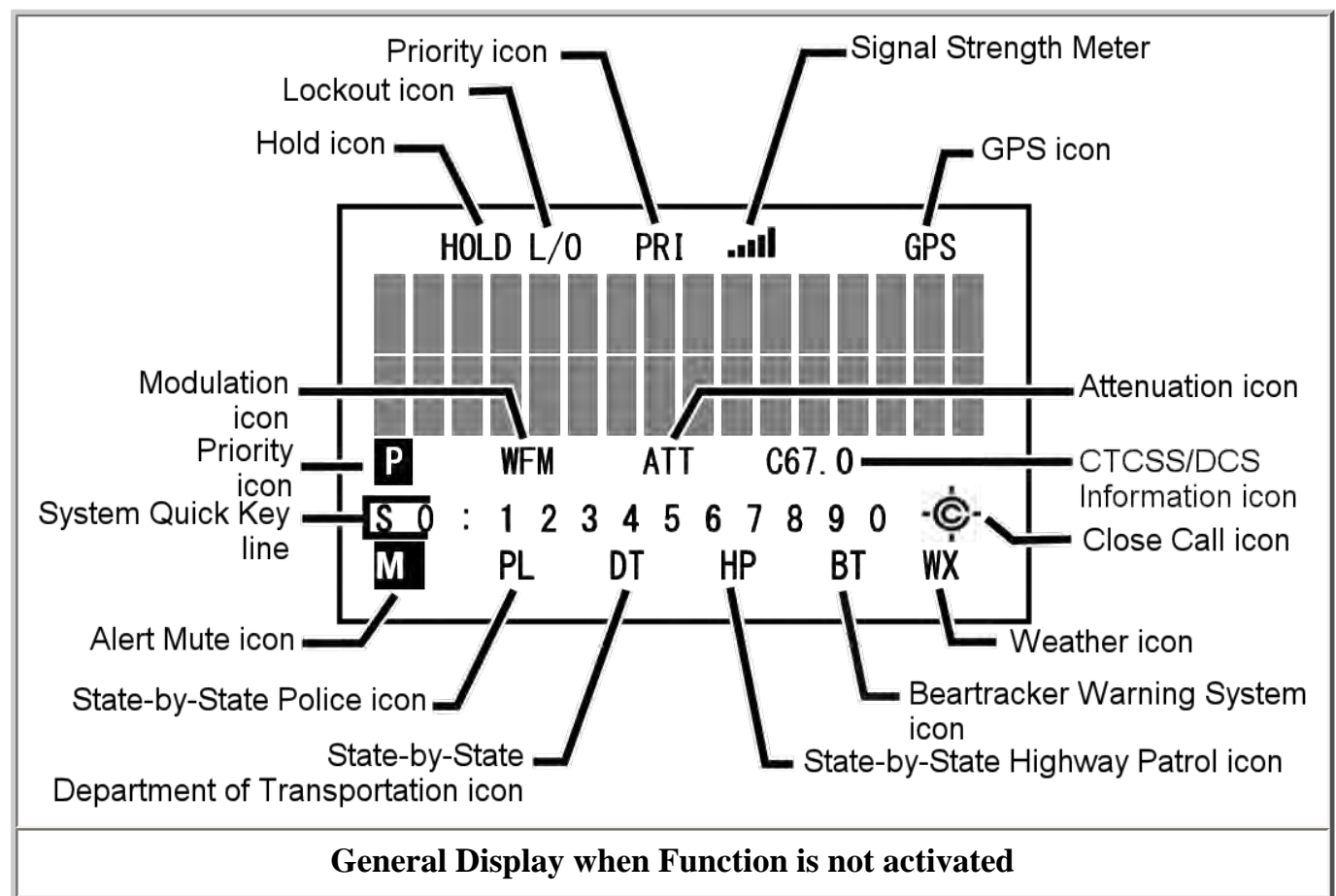

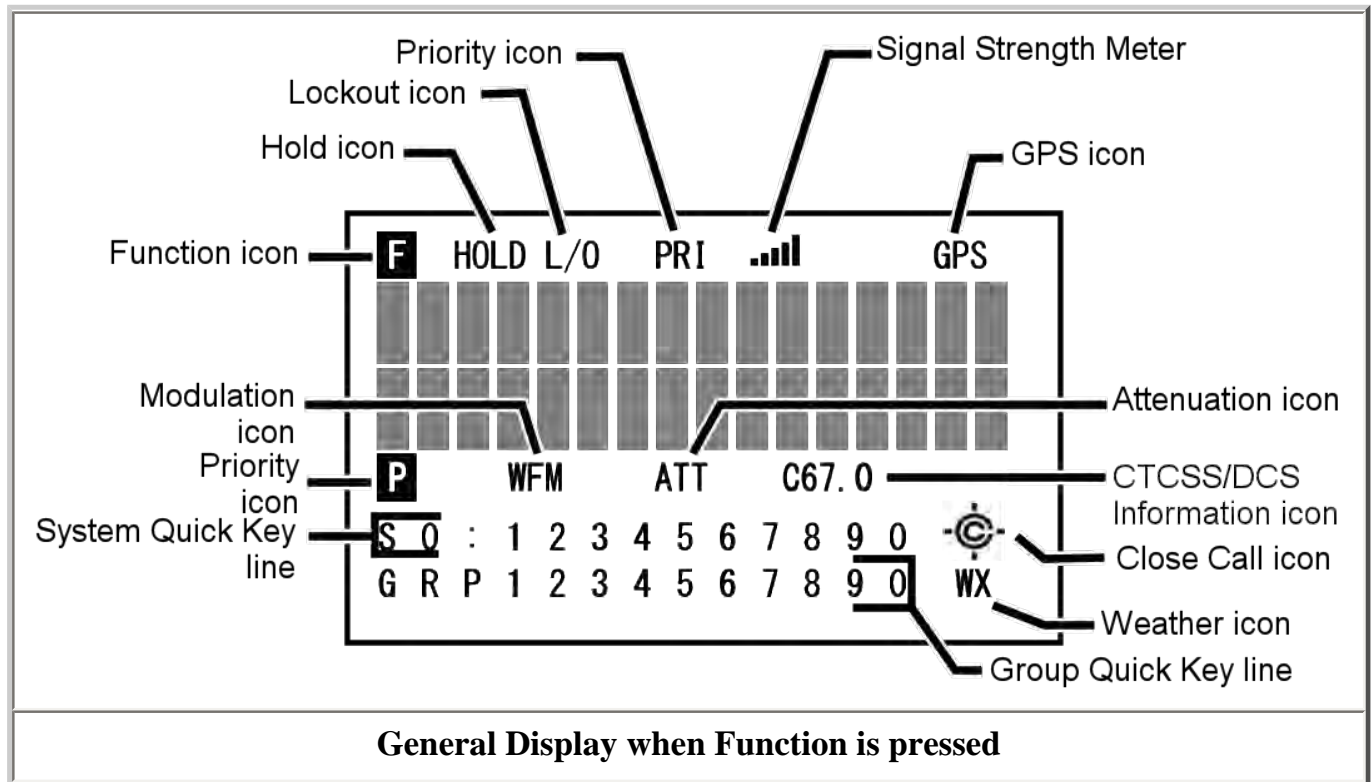

<b>Alert Mute icon</b>	Steady: You have turned on permanent alert mute.
	Blinking: Temporary alert mute is activated.
<b>Attenuator icon</b>	Steady: The attenuator is turned on for the current channel.
	Blinking: The attenuator is turned on globally (for all channels).
<b>Channel Info icon</b>	Cxx.x: The scanner has detected a CTCSS code; the received code is displayed in place of the Xs.
	DCSxxx: The scanner has detected a DCS code; the received code is displayed in place of the Xs.
<b>Close call icon</b>	Normal (open) icon:
	<ul style="list-style-type: none"> <li>Steady: Close call priority mode is on.</li> <li>Blinking: Close Call Only mode is on, or the scanner has detected a close call signal.</li> </ul>

	<p>Reversed (filled) icon:</p> <ul style="list-style-type: none"> <li>• Steady: Close call DND mode is on.</li> <li>• Blinking: Close call DND mode is on, and the scanner has detected a close call signal.</li> </ul>
<b>Function icon</b>	Steady: You tapped the <b>FUNCTION</b> key; the scanner will remember the <b>FUNCTION</b> + key combination for the next 3 seconds.
	Blinking: You pressed & held the <b>FUNCTION</b> key: the scanner will remember the <b>FUNCTION</b> + key combination until you tap <b>FUNCTION</b> again.
<b>Group number line (GRP)</b>	In Scan mode: The group Quick Key numbers (GQK) of any unlocked groups in the current system or site are displayed on this line. The GQK number of the group that is currently being scanned blinks.
	In Hold mode: This line displays the GQK number of the current group only.
	In Custom Search mode: The numbers of any programmed search ranges are display on this line. The number of the custom range that is currently being searched blinks.
<b>Hold icon</b>	The scanner is in Hold mode.
<b>IFX icon</b>	You switched to the intermediate frequency (IF exchange). This icon appears above the System Number Line in the Function mode. (Not illustrated.)
<b>GPS icon</b>	GPS: The scanner is receiving data from the GPS device.
<b>Lockout icon</b>	The current channel is locked out.
<b>Modulation icon</b>	This icon displays the modulation type of the current channel: AM, FM, NFM, FMB, or WFM.
<b>Priority icon</b>	The current channel is set as a priority channel.
<b>Priority scan icon (PRI)</b>	Steady: Priority scan is turned on.
	Blinking: Priority Plus scan is turned on.

<b>REP icon</b>	The Repeater Find feature is turned on.
<b>Signal level icon</b>	This icon displays the strength of the current signal; the icon ranges from zero bars (no signal) to five bars (strong signal).
<b>State-by-State icons</b>	<p><b>PL:</b> Indicates the Local Police search is turned on.</p> <p><b>DT:</b> Indicates the Department of Transportation search is turned on.</p> <p><b>HP:</b> Indicates the Highway Patrol search is turned on.</p> <p><b>BT:</b> Indicates the Beartracker Warning System is turned on.</p> <p>When any of these modes are turned on, the scanner will interrupt other communications periodically to check for activity.</p>
<b>System number line (Sx:)</b>	In Scan mode: The system/site Quick Key numbers (SQK) of any unlocked systems or sites are displayed on this line. The SQK number of the system or site that is currently being scanned blinks. For SQK numbers above 9, the tens digit replaces the X in the icon; the ones digits are shown on this line.
	In Hold mode: This line displays the SQK number of the current system or site only. For SQK numbers above 9, the tens digit replaces the X in the icon; the ones digit is displayed on this line.
	In Service Search mode: The icon SCR replaces the System numbers if the broadcast screen feature is turned on.
<b>V+0</b>	Indicates the volume offset for the current channel (-3 to +3). This icon appears above the System Number Line in the Function mode. (Not illustrated.)
<b>Weather alert icon</b>	Weather Alert Priority scan is turned on.

## Special displays

In some operation modes, the display can be very different from the main display. These modes

also have 2 or 3 different displays you can cycle through.

- [Band Scope mode display](#)
- [Hold mode displays](#)
- [GPS mode display](#)

This page applies to the following scanner(s): [BCT15X Users Guide](#)

# State-by-State Scanning

The [BCT15X](#) comes preprogrammed with many of the channels used by local police, department of transportation, and highwaypatrol agencies, organized by state. You can also assign a state to the systems you program so that they can be included in State-by-State scanning.

## Selecting your State

To select your state, tap **FUNCTION** (the scroll knob) then tap the Volume control. Rotate the scroll knob to select your state, then press **E** to make your selection. The scanner unlocks any systems you have set to the selected state, locks out systems that are set to a different state, and uses the current state preprogrammed data during state-by-state scanning.

## Using the Built-In State-by-State Agencies

To use the built-in State-by-State agencies, repeatedly tap **DOT/POL/PRI** and **(Bear Paw)/HP/ALT** until the desired agency type's icon shows in the bottom row of the display:

- PL** — Local Police
- DT** — Department of Transportation
- HP** — Highway Patrol
- BT** — [BearTracker Warning System](#)

After scanning your programmed systems, the [BCT15X](#) will scan the enabled state-by-state agencies, then resume scanning your programmed systems.

This page applies to the following scanner(s): [BCT15X Users Guide](#)

# BearTracker Warning System

The BearTracker Warning System (BWS) alerts you to nearby public safety radio activity. This can give you an advanced warning of police activity and other hazards when you are driving.

The earliest BWS implementations primarily monitored for the frequencies used by mobile radio extenders -- radio units installed in patrol cars that extended the range of the officer's handheld radio. BWS has been extended to now include the "input" frequencies used by public safety agencies in your state. These frequencies are typically only receivable when you are up to 2 miles from the unit transmitting.

Because the frequencies used vary from location to location, we've set up the scanner so that all you need to do is select what state you are in. From that point, BWS will use frequencies most often used in your state to alert you to nearby activity.

## Selecting your State

To select the frequencies for your state, tap **FUNC** (the scroll knob) then the Volume knob. Use the scroll knob to select your state or Canadian province, then press **E** (or tap the scroll knob) to use your selection.

## Turning on the BearTracker Warning System

To turn on the BearTracker Warning System, repeatedly press the **(Bear Paw)/HP/ALT** button until BT is displayed in the bottom line in the display.

When BWS is turned on, you will notice received audio cutting out about every 2 seconds as the scanner checks for public safety radio activity. If the scanner detects such activity, it alerts you using the alert you set in the [Set Bear Tracker](#) menus.

## Muting BearTracker Alerts

To temporarily mute BWS alerts, tap the Squelch knob during an alert. Alerts will be muted until you tap Squelch again.

This page applies to the following scanner(s): [BCT15X Users Guide](#)



# Tone Out mode

This page applies only to the [BCT15X](#). For other models see:

- [BCD396XT and BC346XT Tone Out Mode](#)
- [BCD996XT Tone Out Mode](#)

With the tone out feature, the scanner monitors up to 10 different channels for paging tones (two-tone sequential, single tone, and group tone). Normally, the scanner monitors each of the 10 channels in turn. However, if any tone-out channels share the same frequency, modulator, and attenuator settings, the scanner checks these channels simultaneously.

## Configuring Tone Out channels

To configure Tone-Out channels:

1. *MENU* --> *Tone-Out for...* --> *Tone-Out Setup*.
2. Select the Tone-Out channel ( *Tone-Out 1* through *Tone-Out 10* ) you want to configure.
3. Press **E** to enter the configuration menu and set the properties as desired.

<b>Required</b>	Frequencies ( <a href="#">Set Frequencies</a> )  Tone A and Tone B ( <a href="#">Set Tones</a> )
<b>Recommended</b>	Name ( <a href="#">Edit Name</a> )
<b>Optional</b>	Delay Time ( <a href="#">Set Delay Time</a> )  Alert ( <a href="#">Set Alert</a> )  Record Flag ( <a href="#">Set Record</a> )













## Using Tone-Out Mode



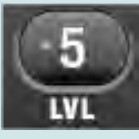



To start a Tone-Out search, *MENU* --> *Tone-Out for...* --> *Tone-Out Standby*. The scanner starts searching the most recently-used Tone-Out channel (and any other Tone-Out Channels that have the same frequency, modulation, and attenuator settings).

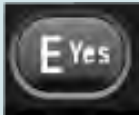

- If you want to search a different channel, just turn the **SCROLL** knob until you find the channel you want.
- To exit Tone-Out mode, tap **SCAN**.

- To hear all transmissions on a tone-out frequency, even when a tone-out has not been activated, press **HOLD**. To return to Tone-Out Search mode, press **HOLD** again.

## Key Operation in Tone Out Mode

<b>Key Name</b> (2nd operation) <b>Action On</b>	 <b>Police / PRIORITY</b>	 <b>1 (Search 1)</b>	 <b>2 (Search 2)</b>	 <b>3 (Search 3)</b>
Tap	Go to Scan mode.	Enter a digit in Direct Entry mode.		
<b>FUNCTION</b> + Tap	NA	Start the search range assigned to this Search Key.		
<b>Key Name</b> (2nd operation) <b>Action on:</b>	 <b>Highway Patrol / Alert Plus</b>	 <b>4 (IF exchange)</b>	 <b>5 (Level offset)</b>	 <b>6 (Display mode)</b>
Tap	Go to Scan mode.	Enter a digit in Direct Entry mode.		
<b>FUNCTION</b> + Tap	Start scanning in Alert Plus mode.	Toggle the IF for that the current frequency.	NA	NA
<b>Key Name</b> (2nd operation) <b>Action on:</b>	 <b>GPS / Weather</b>	 <b>7 (Attenuation)</b>	 <b>8 (Reverse freq.)</b>	 <b>9 (Modulation)</b>
Tap	Switch to the GPS Navigation display.	Enter a digit in Direct Entry mode.		
<b>FUNCTION</b> + Tap	Toggle Weather Alert Priority mode.	Toggle the attenuator state.	NA	Change the modulation.
<b>FUNCTION</b> + Press & hold	Go to Weather Scan mode.	Toggle the attenuator state for all signals.	NA	NA

<b>Key Name</b>  (2nd operation)  <b>Action on:</b>	  <b>Menu</b>	  <b>./ No (Decimal)</b>	  <b>0</b>	  <b>Yes (Enter)</b>
Tap	Enter the Menu Mode.	Enter a decimal point or "i" in Direct Entry mode.	Enter a digit in Direct Entry mode.	Go to the configuration settings for the selected tone-out.
<b>Function + Tap</b>	Enter the Menu Mode at the "Tone-Out for..." menu.	NA		Go to the configuration settings for the selected tone-out.
<b>Key Name</b>  (2nd operation)  <b>Action on:</b>	  <b>SQUELCH</b>	  <b>VOLUME</b>	  <b>SCAN/SEARCH</b>	  <b>HOLD/RESUME</b>
Rotate	Adjust Squelch.	Adjust volume. Turn fully counterclockwise past click to turn off scanner.	NA	NA
Tap	Temporarily mute alerts. Tap again to restore.	Change backlight level.	Go to Scan mode.	Toggle Tone Out Hold mode.
Press & Hold	Permanently mut alerts. Tap again to restore.	NA	NA	NA
<b>FUNCTION + Tap</b>	Toggle Close Call modes.	Select the state to use for state-by-state searches.	Prompt to go to Quick Search mode.	Toggle Tone Out Hold mode.
<b>FUNCTION + Press &amp; Hold</b>	Go to Close Call Only mode.	NA		

<b>Key Name</b> <b>(2nd operation)</b> <b>Action on:</b>	 <b>LOCKOUT</b>	 <b>SCROLL - FUNCTION</b>
Rotate	NA	Select the Tone Out to use.
Tap	NA	Activate the FUNCTION mode for the next keypress.
Press & Hold	NA	Lock the FUNCTION mode.

This page applies to the following scanner(s): [BCT15X UsersGuide](#)

# Close Call Mode

This page applies only to the [BCT15X](#). For other models see:

- [BCD396XT and BC346XT Close Call Mode](#)
- [BCD996XT Close Call Mode](#)









When the scanner is in Close Call mode, it performs a close call check every 2 seconds. The scanner switches to the selected bands and searches for unusually strong signals (indicating the transmitter is probably somewhere close by). After the close call check, the scanner returns to its previous function.





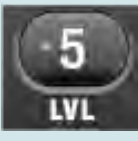

In *Close Call Do Not Disturb* mode, the scanner does not perform a Close Call check if it is already receiving an audio transmission. This prevents the audio from cutting out every 2 seconds.





In *Close Call Only* mode, the scanner only performs Close Call checks.

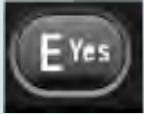

The [Close Call](#) menu lets you change the operation settings of the Close Call feature. You can change the overall Close Call options through the [Srch/CloCall Opt](#) menu.

## Key Operation in Close Call Mode

<b>Key Name</b>  (2nd operation)  <b>Action On</b>	  <b>DOT / Police / PRIORITY</b>	  <b>1 (Search 1)</b>	  <b>2 (Search 2)</b>	  <b>3 (Search 3)</b>
Tap	Go to Scan mode.	Turn on/off the associated Close Call range.		
<b>FUNCTION</b> + Tap	NA	Start the search range assigned to this Search Key.		
When holding on a frequency	Go to Scan mode.	Input the corresponding number in Direct Entry mode.		
<b>Key Name</b>  (2nd operation)  <b>Action on:</b>	  <b>BearTracker / Highway Patrol / Alert</b>	  <b>4 (IF exchange)</b>	  <b>5 (Level offset)</b>	  <b>6 (Display mode)</b>
Tap	Go to Scan mode.	Turn on/off the associated Close Call range.		

<b>FUNCTION</b> + Tap	Start scanning in Alert Plus mode.	When monitoring a frequency, toggle the IF for that frequency.	NA	NA
Press & Hold	NA	NA	NA	NA
When holding on a frequency	Same functions as normal Close Call mode.	Input the corresponding number in Direct Entry mode.		
<b>Key Name</b>  (2nd operation)  <b>Action on:</b>	  <b>GPS / Weather</b>	  <b>7 (Attenuation)</b>	  <b>8 (Reverse freq.)</b>	  <b>9 (Modulation)</b>
Tap	Switch to the GPS Navigation display.	Turn off the associated Close Call range.	NA	NA
<b>FUNCTION</b> + Tap	Toggle Weather Alert Priority mode.	Toggle the attenuator state.	NA	Change the modulation.
<b>FUNCTION</b> + Press & hold	Go to Weather Scan mode.	Toggle the attenuator state for all signals.	If stopped on a frequency that has a valid reverse (input) frequency, show the repeater reverse frequency for the current frequency (the scanner returns to the original frequency when you release the key).	NA
When holding on a frequency	Same functions as normal Close Call mode.	Input the corresponding number in Direct Entry mode.		
<b>Key Name</b>  (2nd operation)  <b>Action on:</b>	  <b>Menu</b>	  <b>./ No (Decimal)</b>	  <b>0</b>	  <b>Yes (Enter)</b>
Tap	Enter the Menu Mode.	NA	NA	If stopped on a frequency, store the current frequency.

<b>FUNCTION</b> + Tap	Enter the Close Call Menu.	NA	NA	NA
When holding on a frequency	Enter the Menu Mode.	Input the corresponding key in Direct Entry mode.		Accept entered value for Direct Entry mode.
<b>Key Name</b>  (2nd operation)  <b>Action on:</b>	  <b>SQUELCH</b>	  <b>VOLUME</b>	  <b>SCAN/SEARCH</b>	  <b>HOLD/RESUME</b>
Rotate	Adjust Squelch.	Adjust volume. Turn fully counterclockwise past click to turn off scanner.	NA	NA
Tap	Stop an alert tone and set temporary alert mute. Tap to release mute.	Change backlight level.	Go to Scan mode	Hold on the most recent Close Call hit frequency. If you have not received a Close Call hit, NA.
Press & Hold	Set permanent alert mute. Tap to release mute.	NA	NA	NA
<b>FUNCTION</b> + Tap	Turn off Close Call mode and return to scan.	Select the State.	Go to the Quick Search prompt.	If on a Close Call hit, hold on the current frequency. Otherwise, NA.

<b>Key Name</b>  (2nd operation)  <b>Action on:</b>	  <b>LOCKOUT</b>	  <b>SCROLL - FUNCTION</b>
---	---	--

Rotate	NA	If stopped on a Close Call, resume Close Call.
Tap	If stopped on a frequency, temporarily lockout the frequency.	Activate the FUNCTION mode for the next keypress.
<b>Function</b> + Tap	Go to the lockout review mode.	NA
Double Tap	If stopped on a frequency, permanently lockout the frequency.	NA
Press & Hold	If stopped on a frequency, unlock all search frequencies.	"Latch" the FUNCTION mode. Scanner stays on the current system and all keypresses use the FUNCTION mode until you tap the control again.

This page applies to the following scanner(s): [BCT15X Users Guide](#)



This page applies only to the [BCT15X](#). For other models see:

- [BCD396XT and BC346XT Band Scope Mode](#)
- [BCD996XT Band Scope Mode](#)

## Band Scope mode

Band Scope mode is a special type of Search mode where the scanner displays the strength of any signal it finds.

- In a band scope search, the scanner starts at the lowest frequency in the range and moves up the search range.
- In *Max Hold* Search mode, the scanner displays the strongest signal that it found.
- If you manually set the mode to NFM or FM, the scanner will not reliably detect signals that are modulated in either FMB or WFM.





### **To turn on Band Scope mode:**

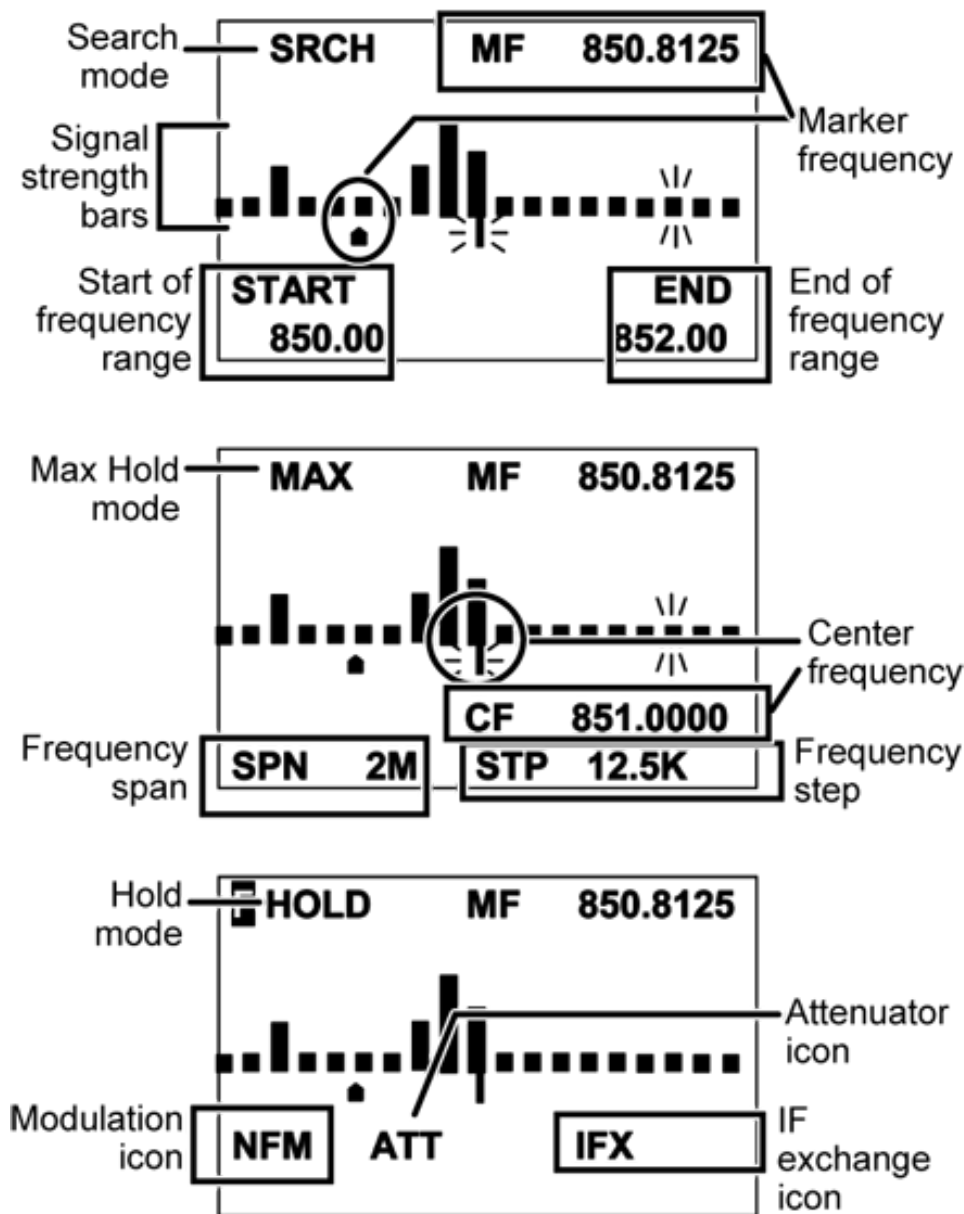









Band Scope mode is the default setting for Search Key 3. To turn on Band Scope mode, enter Hold or Search mode, then tap **FUNCTION + 3 (SR3)** . (To change the Search Key assignment, see [Search Keys#Programming Search Keys](#).)





### **Reading the display in Band Scope mode**



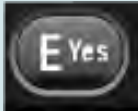

## Key Operation in Band Scope Mode

<b>Key Name</b>  (2nd operation)				
<b>Action On</b>	Police/DOT/ PRIORITY	1 (Search 1)	2 (Search 2)	3 (Search 3)
Tap	Go to Scan Mode.	NA		
<b>FUNCTION + Tap</b>	NA	Start the search range assigned to this Search Key.		

<b>Key Name</b> (2nd operation) <b>Action on:</b>	 <b>Highway Patrol / &lt;nop&gt;BearTracker / Alert</b>	 <b>4 (IF exchange)</b>	 <b>5 (Level offset)</b>	 <b>6 (Display mode)</b>
Tap	Go to Scan Mode.	NA		
<b>FUNCTION</b> + Tap	Go into Alert Plus mode and start scanning.	Toggle the IF for that the current frequency.	NA	NA
<b>Key Name</b> (2nd operation) <b>Action on:</b>	 <b>GPS / Weather</b>	 <b>7 (Attenuation)</b>	 <b>8 (Reverse freq.)</b>	 <b>9 (Modulation)</b>
Tap	Switch to the GPS Navigation display.	NA		
<b>FUNCTION</b> + Tap	Toggle the Weather Alert Priority mode.	Toggle the attenuator state.	NA	Change the modulation.
<b>FUNCTION</b> + Press & hold	Start Weather Scan.	Toggle the attenuator state for all signals.	NA	NA
<b>Key Name</b> (2nd operation) <b>Action on:</b>	 <b>Menu</b>	 <b>. / No (Decimal)</b>	 <b>0</b>	 <b>Yes (Enter)</b>
Tap	Enter the Menu Mode.	Press to enter the Band Scope Setting mode and select a setting. The selected setting flashes.  In Band Scope Setting mode, selects the next setting.	NA	Set the marker frequency as the center frequency.  In Band Scope Setting mode, with CF selected edit the center frequency.
<b>FUNCTION</b> + Tap	Enter the Menu Mode.	NA	NA	NA

<b>Key Name</b> (2nd operation) <b>Action on:</b>	 <b>SQUELCH</b>	 <b>VOLUME</b>	 <b>SCAN/SEARCH</b>	 <b>HOLD/RESUME</b>
Rotate	Adjust Squelch.	Adjust volume. Turn fully counterclockwise past click to turn off scanner.	NA	NA
Tap	Stop the alert tone and set the scanner to temporary mute alerts. Press again to cancel.	Change backlight level.	Resume scanning.	Hold on the current frequency. Press again to resume.
Press & Hold	Permanently mute alerts. Press again to cancel.	NA	NA	NA
<b>FUNCTION + Tap</b>	Toggle Close Call Modes.	Select the current state.	Switch between Max Hold Search mode and Search Mode.	Hold on the current frequency. Press again to resume.

<b>Key Name</b> (2nd operation) <b>Action on:</b>	 <b>LOCKOUT</b>	 <b>SCROLL - FUNCTION</b>
Rotate	NA	Change the marker frequency one step frequency per click.  In Band Scope Setting mode, change the selected parameter (except CF).
<b>Function + Rotate</b>	NA	Change the marker frequency one "bar" per click.

Tap	In Band Scope setting mode, return to the normal Band Scope mode.	Activate the FUNCTION mode for the next keypress.
<b>Function</b> + Tap	Restart the Band Scope.	NA

This page applies to the following scanner(s): [BCT15X UsersGuide](#)

# GPS Mode

This page applies only to the [BCT15X](#). For other models see:

- [BCD396XT and BC346XT GPS Mode](#)
- [BCD996XT GPS Mode](#)

You must have a [compatible GPS receiver](#) connected!

- [GPS Mode](#)
  - [See Also](#)
  - [Reading the display in GPS mode](#)
    - [GPS Data display](#)
    - [ETA / Clock / Elevation / Speed Display](#)
    - [Location Display](#)
    - [Location Alert display](#)
    - [Location review display](#)
    - [Keypad controls in GPS Review Location Mode](#)
    - [Keypad controls in GPS Mode](#)

## See Also

GPS mode is only one small part of location-based scanning. For more information on using your scanner with a GPS receiver, see the following links:

[Location-based Scanning](#) contains

- an overview of why you might want to use a GPS receiver with your scanner
- an explanation of two different approaches to location-based scanning
- some information on finding antenna locations

[Programming locations](#) contains

- details on how to program locations for systems, sites, and channels
- details on how to program Points of Interest ( *POI* ), Dangerous Roads, and Dangerous Intersections ( *Dangerous Xing* )
- information on reviewing and editing locations

[Connecting a GPS receiver](#) contains

- details on which GPS receivers are compatible
- instructions on connecting a GPS receiver
- troubleshooting tips if you can't the receiver working with the scanner





## Reading the display in GPS mode

There are several displays available in GPS mode.

### GPS Data display

<p><b>SW 01:23P</b></p> <p><b>39 mph 544 ft</b></p> <p><b>OFF</b></p> <hr/> <p><b>SCAN           ↑</b></p>	<ul style="list-style-type: none"> <li>• Direction of Travel</li> <li>• Current Time</li> <li>• Current Speed</li> <li>• Current Elevation</li> <li>• OFF indicates no POI is selected</li> </ul>
--	---

**ETA / Clock / Elevation / Speed Display**

 <p><b>SW 1h 10m</b></p> <p><b>15.03 mi</b></p> <p><b>HOME</b></p> <hr/> <p><b>SCAN           ↑</b></p>	<p>These displays are available if you select a POI.</p> <ul style="list-style-type: none"> <li>• Large arrow shows direction to the POI</li> <li>• Current Direction of Travel</li> <li>• Distance to the POI</li> <li>• Upper right corner depends on display mode:             <ul style="list-style-type: none"> <li>○ ETA to POI</li> <li>○ Current time</li> <li>○ Current elevation</li> <li>○ Current speed</li> </ul> </li> </ul>
 <p><b>SW 13:23</b></p> <p><b>15.03 mi</b></p> <p><b>HOME</b></p> <hr/> <p><b>SCAN           ↑</b></p>	
 <p><b>SW 166 m</b></p> <p><b>24.19 km</b></p> <p><b>HOME</b></p> <hr/> <p><b>SCAN           ↑</b></p>	
 <p><b>SW 62 kph</b></p> <p><b>24.19 km</b></p> <p><b>HOME</b></p> <hr/> <p><b>SCAN           ↑</b></p>	

**Location Display**

<p>N 32° 57' 33.60 W 97° 05' 34.18</p> <hr/> <p>HOME</p> <p>SCAN      ↑</p>	<ul style="list-style-type: none"> <li>• Latitude of current location</li> <li>• Longitude of current location</li> <li>• OFF if no POI selected, otherwise the name of the POI</li> </ul>
---	--

**Location Alert display**

 <p>ALERT for Road 0.500mi R183 at Beltline</p> <hr/> <p>SCAN      ↑</p>	<ul style="list-style-type: none"> <li>• Location Alert Type</li> <li>• Distance to Alert location</li> <li>• Location Alert Name</li> <li>• Direction to Alert location</li> <li>• ALERT indicator also flashes when you approach a Dangerous Crossing or Dangerous Road</li> </ul>
---	--





**Location review display**

<p>POI L/O GPS Review Location Hollywood RANGE: 0.10 MILE N 00° 00' 00.00 W 000° 00' 00.00</p>	<p>DXG L/O GPS Review Location Crossroad HEAD: ALL LS: 75M N 00° 00' 00.00 W 000° 00' 00.00</p>	<p> DRD L/O GPS Review Location Crossroad HEAD: NW LS: 75K N 00.000000 W 000.000000</p>
--	---	--

These displays show the details of each location you've set. **SCROLL** to go to the next location.

**Keypad controls in GPS Review Location Mode**

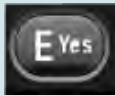
Keys not listed have no function in this mode.





<p><b>Key Name</b>  (2nd operation)  <b>Action on:</b></p>	 GPS / Weather	 MENU	 Yes (Enter)	 LOCKOUT	
<p>Tap</p>	<p>NA</p>	<p>Return to GPS Mode</p>	<p>Go to the menu mode.</p>	<p>Change the lockout status of the current location.</p>	







Press & Hold	Overwrite the selected location with the current location.	NA	NA	Unlock all locations of the current type (POI, Dangerous Road, Dangous Crossing)	
<b>FUNCTION</b> + Press & Hold	NA	NA	NA	Display "Unlock All Locations?" If you press <b>E/YES</b> all locations of all types are unlocked.	
<b>Key Name</b>  (2nd operation)  <b>Action on:</b>	 <b>SQUELCH</b>	 <b>VOLUME</b>	 <b>SCROLL - FUNCTION</b>	 <b>SCAN/SEARCH</b>	 <b>HOLD/RESUME</b>
Rotate	Adjust Squelch.	Adjust volume. Turn fully counterclockwise past click to turn off scanner.	Select a location.	NA	NA
Tap	NA	Change backlight level.	Activate the FUNCTION mode for the next keypress.	Go to Scan Mode	Go to Scan Hold mode.
Press & Hold	NA	NA	"Latch" the FUNCTION mode. Scanner stays on the current system and all keypresses use the FUNCTION mode until you tap the control again.	NA	NA

## Keypad controls in GPS Mode

Keys not listed have no function in this mode.

<b>Key Name</b>  (2nd operation)  <b>Action on:</b>	 <b>GPS / Weather</b>	 <b>MENU</b>	 <b>Yes (Enter)</b>	 <b>LOCKOUT</b>	 <b>6 / DISPLAY</b>
Tap	NA	Go to the Menu mode.	Go to the review location mode.	Temporarily lockout the current location alert if it one is active.	NA
Double Tap	NA	NA	NA	Permanently lockout the current location alert if it one is active.	NA
Press & Hold	Store the current location.	NA	NA	NA	NA

<b>Function</b> + Tap	NA	Go to the menu mode to edit the current location.	NA	Temporary lockout the current location alert if one is active.	Switch between GPS display modes.
<b>Key Name</b>  (2nd operation)  <b>Action on:</b>	 <b>SQUELCH</b>	 <b>VOLUME</b>	 <b>SCROLL - FUNCTION</b>	 <b>SCAN/SEARCH</b>	 <b>HOLD/RESUME</b>
Rotate	Adjust Squelch.	Adjust volume. Turn fully counterclockwise past click to turn off scanner.	Select a POI.	NA	NA
Tap	NA	Change backlight level.	Activate the FUNCTION mode for the next keypress.	Return to previous operation.	Hold on the current channel.
Press & Hold	NA	NA	"Latch" the FUNCTION mode. Scanner stays on the current system and all keypresses use the FUNCTION mode until you tap the control again.	NA	Hold on the current system.  If already holding on a system, resume normal scanning when in scan mode.
<b>Function</b> + Rotate	NA	NA	Quickly skip to the location starting with the next alphabetic character.	Return to previous operation.	NA

This page applies to the following scanner(s): [BCT15X Users Guide](#)

# Edit Sys Option

To determine whether the information on this page applies to your scanner, see the tags at the bottom of the page.

System options vary depending on the system type.

- [Global system options](#)
  - [Set Number Tag](#)
  - [Set Delay Time](#)
  - [Set Audio AGC](#)
  - [Set Record \(BCD996XT and BCT15X Only\)](#)
  - [Set State \(BCT15X Only\)](#)
- [Conventional system options](#)
  - [Set Quick Key](#)
  - [Set Startup Key](#)
  - [Set Lockout](#)
  - [Set Hold Time](#)
  - [P25 Waiting Time \(BCD396XT and BCD996XT Only\)](#)
- [Trunked system options](#)
  - [ID Scan/Search](#)
  - [Priority ID Scan](#)
  - [Emergency Alert](#)
  - [Set ID Format \(DEC/HEX\) or \(AFS/DEC\)](#)
  - [Rvw ID:Srch L/O](#)
  - [Clr All L/O IDs](#)
- [Motorola system options](#)
  - [Edit Fleet Map](#)
  - [Set Status Bit](#)
  - [Set End Code](#)
- [P25 System options \(BCD396XT and BCD996XT Only\)](#)
  - [P25 NAC Option](#)

## Global system options

The following options are available for all types of systems.

## Set Number Tag

Assign a number to this system or channel that you can use to tune directly to a specific channel. Choose a number from 0 to 999. (For more information, see [Number Tags](#).)

## Set Delay Time

Set the number of seconds the scanner should wait after a transmission stops before moving on to the next channel. Select 0, 1, 2 (default), 5, 10, or 30 *seconds*.

To have scanner leave the channel after a designated number of seconds whether the transmission stops or not, select one of the negative values. Choose -10 seconds to have the scanner leave the channel after 10 seconds even if the transmission is still going on; choose -5 *seconds* or -2 *seconds* to have the scanner leave after 5 seconds or 2 seconds, respectively.

## Set Audio AGC

Turn on Automatic Gain Control (AGC) for this system. When you activate this feature, the scanner automatically adjusts the volume for each channel based on the signal strength. You can turn on the gain control for *Analog* and *Digital* signals separately.

To change the settings for the audio AGC, see [Adjust Audio AGC](#)

## Set Record ([BCD996XT](#) and [BCT15X](#) Only)

Set whether the audio from channels on the system come out the RECORD OUT jack on the back of the scanner. You have three options:

- All Channel -- All channels in the system go to the RECORD OUT jack.
- Marked Channel -- Only those channels that have the RECORD option turned on go to the RECORD OUT jack.
- Off -- No channels in the system go to the RECORD OUT jack (even those with the RECORD option turned on).

## Set State ([BCT15X](#) Only)

Sets the U.S. State or Canadian Province associated with the system. If selected, the system will be unlocked when you set the scanner to the state and locked out when you select a different state.

## Conventional system options

The following options are available when you're editing a conventional system:

### Set Quick Key

Assign this system or site to a Quick Key so you can easily enable or disable it during scanning. Enter a number from 0 to 99; tap NO (the decimal point) if you don't want to assign this system or site to a Quick Key. (For more information, see [Quick Keys](#).)

### Set Startup Key

Assign this system or site to a Startup Key so you can lock or unlock it during power up. Enter a number from 0 to 9; tap NO (the decimal point) if you don't want to assign this system or site to a Startup Key. (For more information, see [Startup Keys](#).)

### Set Lockout

Decide whether you want to lock out the system so the scanner will ignore it during Scan and Search modes. If you lock out a system, all channels within that system are locked out. Choose one of the following options:

- Unlocked: The system is not locked out.
- Temporary L/O: The system is locked out until you turn the scanner off and back on.
- Lockout: The system is permanently locked out.

### Set Hold Time

Set the minimum number of seconds the scanner should spend checking this system or site even if there is no traffic on any channel. (The scanner always checks each channel

in a system or site once even if the hold time is set to 0 seconds.) Select the number of seconds from 0 through 255 (0 is the default).

## **P25 Waiting Time ([BCD396XT](#) and [BCD996XT](#) Only)**

On channels that contain a mix of analog and digital signals (i.e., where the *Audio Mode* is set to *All*), it is possible to have *false decode* problems caused by digital noise at the beginning of transmissions. To prevent this, a user-configurable P25 wait time (from 0 to 1000 ms) has been added.

During the wait time, the scanner evaluates the received signal; if it detects P25 data, the scanner opens squelch immediately. If it does not detect any P25 data, the scanner opens squelch as soon as the wait time expires.

Note: Any analog transmissions on this channel will lose the first part of the transmission, up to the wait time you set here.

Select the number of milliseconds (after the start of a transmission) the scanner should wait while checking for P25 data. Choose a number from 0 through 1000 ms in 100 ms increments. The scanner only applies the wait time setting to Conventional or Motorola (non P25) systems, and only when the channel's *Audio Mode* setting is *All*.

## **Trunked system options**

The following options are available when you're editing a trunked system:

### **ID Scan/Search**

Choose whether the scanner only checks the Talk Group IDs that you program ( *ID Scan* ) or checks all the Talk Group IDs it can find ( *ID Search* ) when scanning this site.

### **Priority ID Scan**

Choose *On* to have the scanner check any priority-labeled channels in this system during Priority ID Scan mode. Choose *Off* if you want the scanner to ignore this system when scanning priority channels.

### **Emergency Alert**

This menu lets you configure whether the scanner triggers an alert tone and light when it detects an emergency flag within an active Talk Group. (Compare this to the channel setting [Set Alert](#), which can trigger an alert tone and light whenever a channel becomes active.) The settings for [Set Alert Tone](#) and [Set Alert Light](#) are common to both types of alerts.

## Set ID Format (DEC/HEX) or (AFS/DEC)

Trunked systems have three different formats for the Talk Group ID, but not all formats are used by each system type. Choose the Talk Group ID format used by this system:

- *Dec* : The system uses a decimal (base 10) format for the Talk Group IDs (available for all trunked systems)
- *Hex* : The system uses a hexadecimal (base 16) format for the Talk Group IDs (available for P25 and Motorola systems only)
- *AFS* : The system uses the Agency-Fleet-Subfleet format for the Talk Group IDs (available for EDACS wide or narrow systems only)

## Rvw ID:Src h L/O

This feature displays a list of all locked out Talk Group IDs. If you want to unlock a Talk Group ID, just select it from the list and press **YES** .

## Clr All L/O IDs

Choose yes to unlock all the Talk Group IDs in this system or site. (Choose no to cancel and go back to the previous screen.)

## Motorola system options

The following options are available when only when you're editing a Motorola system:

### Edit Fleet Map

(Motorola Type I or Hybrid systems only) This menu lets you choose one of the 16 pre-programmed fleet maps; select *Custom* to manually program your own fleet map

information. (See [Motorola fleet maps](#) for more information.)

## Set Status Bit

Choose *Yes* to have the scanner check the status bit in each TalkGroup ID, or choose *Ignore* to ignore all status bits in this system.

## Set End Code

Choose whether the scanner recognizes any end transmission codes when deciding to leave a channel. You have the following options:

[BCD396XT](#) and [BCD996XT](#):

- *Analog*: The scanner recognizes only analog end transmission codes.
- *Analog-Digital*: The scanner recognizes both analog and digital end codes.
- *Ignore*: The scanner waits for the carrier to drop before leaving a channel.

[BC346XT](#) and [BCT15X](#)

- *Yes*: The scanner recognizes end transmission codes.
- *Ignore*: The scanner waits for the carrier to drop before leaving a channel.

## P25 System options ([BCD396XT](#) and [BCD996XT](#) Only)

The following options are available when only when you're editing a P25 system:

### P25 NAC Option

(P25 single frequency systems only) Choose whether the scanner limits reception to transmissions that include a specific Network Access Code (NAC) for this system or frequency.

- *Search*: The scanner opens squelch for any digital signal, but displays the NAC being used.
- *Set P25 NAC*: The scanner opens squelch only for signals that include the NAC you enter here. Enter a hexadecimal number between *0* and *FFF*.



This page applies to the following scanner(s): [BCD996XT](#) [BCT15X](#) [BCD396XT](#)  
[BC346XT Users Guide](#)

# Edit Group

To determine whether the information on this page applies to your scanner, see the tags at the bottom of the page.

When you create a new channel group, the scanner automatically assigns a default name of Group XX, where XX is a 2-digit sequential number (1 through 20).

- [Options available for all groups:](#)
  - [Edit Name](#)
  - [Set Quick Key](#)
  - [Edit Channel](#)
  - [Set LocationInfo](#)
  - [Set Lockout](#)
  - [Delete Group](#)
  - [New Group](#)

## Options available for all groups:

You have the following options for channel groups:

### Edit Name

Enter a name or edit the existing one. Names can be 16 characters long, and they can contain upper and lower case letters, punctuation, and spaces. Turn the **SELECT-VOLUME-SQUELCH** knob on the handheld scanners or the **SCROLL / FUNCTION** knob on mobile scanners to choose the character you want, then press **6** (right cursor) to move the cursor to the next character.

### Set Quick Key

Assign this group to a Quick Key so you can easily enable or disable it during scanning. Enter a number from 0 to 9; tap NO (the decimal point) if you don't want to assign this group to a Quick Key. (For more information, see [Quick Keys](#).)

## Edit Channel

Use this menu to program channel information for this group. Click on your scanner model below to go the correct Edit channel menu:

- [BCD396XT and BCD996XT Edit Channel](#) menu
- [BC346XT and BCT15X Edit Channel](#) menu

## Set LocationInfo

Use this menu to program location information for this group.

## Set Lockout

Decide whether you want to lock out the channel group so the scanner will ignore it during Scan and Search modes. If you lock out the channel group, all channels in the group are also ignored during Scan and Search. Choose one of the following options:

- Unlocked: The channel group is not locked out.
- Temporary L/O: The channel group is locked out until you turn the scanner off and back on.
- Lockout: The channel group is permanently locked out.

## Delete Group

Delete this group and all its settings, including any channels and frequencies.

## New Group

Create a new group.

This page applies to the following scanner(s): [BCD996XT](#) [BCT15X](#) [BCD396XT](#)  
[BC346XT](#) [Users Guide](#)

# Set LocationInfo

Use this menu to configure geographic information for each system or site. With this information and a standard NMEA GPS input, the scanner can automatically change which systems, sites and channel groups it scans as you change location. You must set the location information if you want to use Location-based Scanning.

## Set Latitude and Set Longitude

Enter the latitude and longitude of the center of this system or site. You can use any geographical coordinates as the center, but most often it will be the physical location of the antenna, the center of a city, county, or other geopolitical territory, or some combination of the two.

Geographical coordinates can be represented in a few different ways. The two most common representations are DMS and Deg.

DMS breaks the coordinate into Degrees, Minutes, and Seconds. This is typically represented like: 44° 58' 12.79" N. Your scanner uses this format.

Decimal degrees simply use the degrees expressed as a decimal number. 44° 59' 12" equates to 44.97381 Degrees. Mathematically, you can change DMS to Deg using the formula  $DDD + MM/60 + SS.ss/3600$ . You would perform the reverse calculation to convert Deg to DMS.

To more easily convert Decimal Degrees to the DDD° MM' SS.sss" format or vice versa, see the converter at this [link](#).

## Set Range

Enter the maximum distance from the center that this site or channel will be active. As long as your position is within the radius you enter here, the scanner monitors this site or channel; when you leave the channel range, the scanner locks out this site or channel. The scanner treats the number you enter here as miles or kilometers depending on the value you selected in the Set Unit field in the Set GPS Format menu (under the main Settings menu). Enter a range from 0.5 through 125.0 mi/km, in 0.5 mi/km steps.

## Set GPS Enable

(A GPS unit must be connected)

Turn this feature on if you want the scanner to lock out this site or channel group when you leave the range and enable the site or channel group when you are within the range.

This page applies to the following scanner(s): [BCD996XT](#) [BCT15X](#) [BCD396XT](#)  
[BC346XT Users Guide](#)

The scanner can automatically adjust the volume when it tunes to this channel or frequency. Enter one of the following options:

Softer	No Change	Louder
-3, -2, - 1	0 (default)	+1, +2, +3

<b>System Name:</b>	Medley City Public Safety
<b>Location:</b>	Medley, FL
<b>County:</b>	Dade
<b>System Type:</b>	EDACS SCAT
<b>System Voice:</b>	Analog
<b>Last Updated:</b>	<i>Updated Function Tag assignments for 3 talkgroups</i>
<b>Hits:</b>	1742

### System Frequencies

**Red (c)** are Primary Control Channels | **Blue (a)** are alternate control channels | Click a Site Name for additional site information | Site Map: [FCC Callsigns](#) [RR Locations](#)

<b>Site Name</b>	
000	Police 01 855.13750c

### System Talkgroups

Updated in the last 7 days     Updated in the last 24 hours    [List All](#) in one table    [Show New](#) Talkgroups

#### POLICE Talkgroups ▾

DEC	AFS	Mode	Alpha Tag	Description	Tag
100	00-124	A	DISPATCH	Police Dispatch	Law Dispatch

# EDACS SCAT System

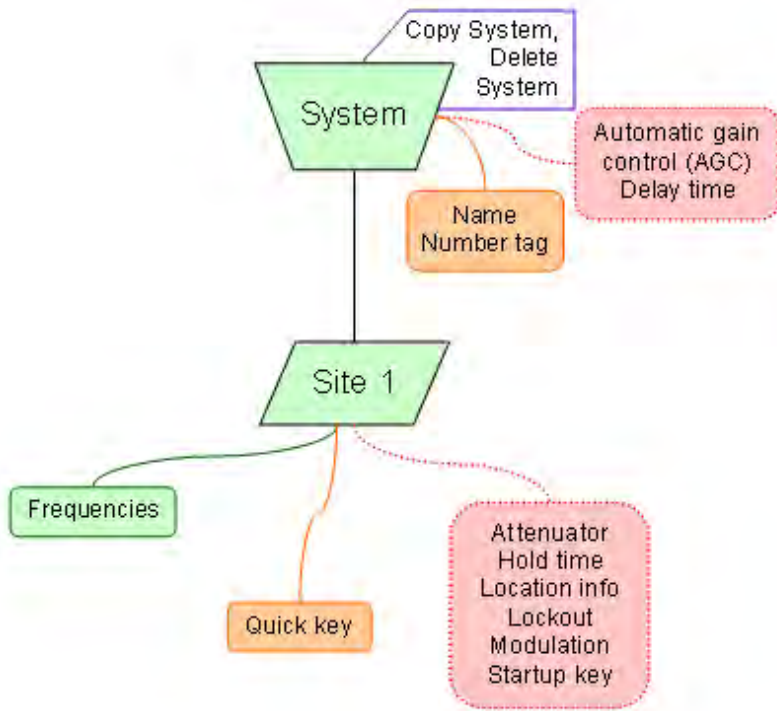



# System Layout Legend

## Items

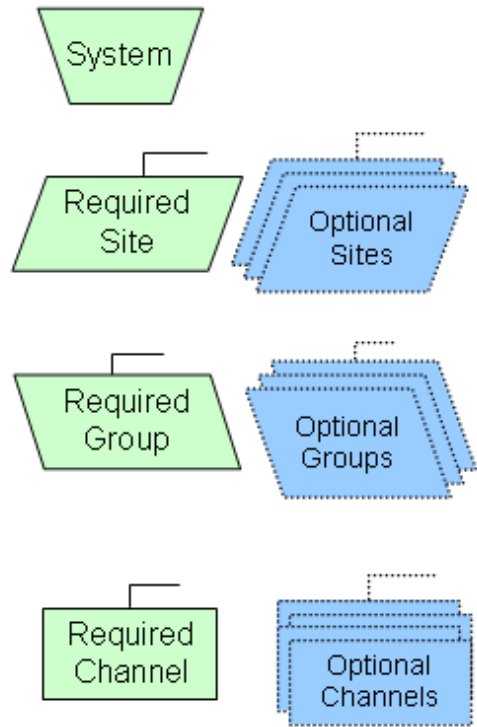

## Properties

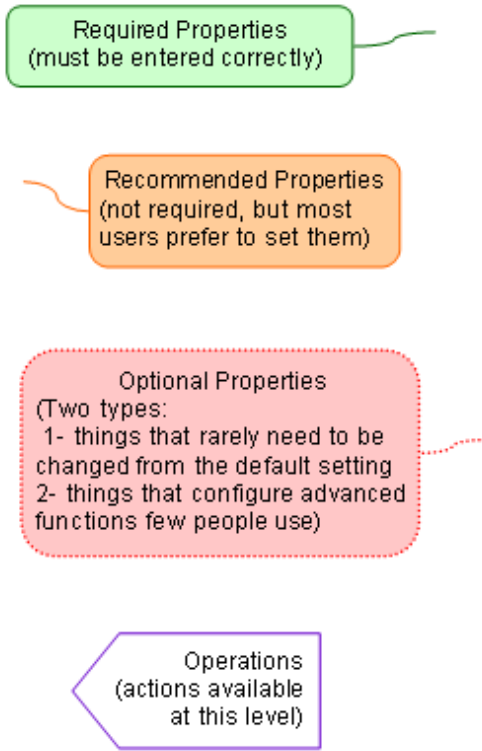

# Edit Site

To determine whether the information on this page applies to your scanner, see the tags at the bottom of the page.

When you create a new site, the scanner automatically assigns a default site name using the following pattern

*Site XXX-YYY TTT*

where *XXX* is a 3-digit system index number, *YYY* is a sequential site number (1 through 256), and *TTT* is one of the following 3-letter type codes:

- *EDC* (any EDACS system)
- *LTR* (any LTR system)
- *MOT* (any Motorola system)
- *P25* (a standard P25 system)
- *1FQ* (a single-frequency P25 system)
  
- Options available for all sites:
  - [Edit Name](#)
  - [Set Quick Key](#)
  - [Set Startup Key](#)
  - [Set Frequencies](#)
  - [Set Modulation](#)
  - [Set Attenuator](#)
  - [Set Lockout](#)
  - [Set Hold Time](#)
  - [Set LocationInfo](#)
  - [Set State \(BCT15X Only\)](#)
  - [Delete Site](#)
  - [New Site](#)
  
- Options available for Motorola systems
  - [Edit Band Plan](#)
  - [P25 Waiting Time \(BCD396XT and BCD996XT Only\)](#)
  
- Options available for P25 systems (BCD396XT and BCD996XT Only)

- [Edit Band Plan \(P25\)](#)
- [Options available for EDACS systems](#)
  - [Set Site Type](#)
  - [Volume Offset \(EDACS SCAT Only\)](#)

## Options available for all sites:

You have the following options for sites:

### Edit Name

Enter a name or edit the existing one. Names can be 16 characters long, and they can contain upper and lower case letters, punctuation, and spaces. Turn the **SELECT-VOLUME-SQUELCH** knob on the handheld scanners or the **SCROLL / FUNCTION** knob on mobile scanners to choose the character you want, then press **6** (right cursor) to move the cursor to the next character.

### Set Quick Key

Assign this system or site to a Quick Key so you can easily enable or disable it during scanning. Enter a number from 0 to 99; tap NO (the decimal point) if you don't want to assign this system or site to a Quick Key. (For more information, see [Quick Keys](#).)

### Set Startup Key

Assign this system or site to a Startup Key so you can lock or unlock it during power up. Enter a number from 0 to 9; tap NO (the decimal point) if you don't want to assign this system or site to a Startup Key. (For more information, see [Startup Keys](#).)

### Set Frequencies

Use this menu to program frequencies for this site.

### Set Modulation

Select what type of modulation the scanner should use for this frequency or channel. (Only the modulation types available for this frequency or channel are displayed.)

<b>Auto</b>	The scanner uses the default modulation type for this frequency's band.
<b>NFM</b>	The scanner treats the frequency as a Narrowband FM band.
<b>FM</b>	The scanner treats the frequency as an FM band.

## Set Attenuator

Turn on attenuation to reduce the signal strength by 20 dB. You can turn on attenuation for individual frequencies and channels or for entire sites. If you turn on attenuation for a site, all frequencies within that site will be attenuated.

## Set Lockout

Decide whether you want to lock out the site so the scanner will ignore it during Scan and Search modes. Choose one of the following options:

- Unlocked: The site is not locked out.
- Temporary L/O: The site is locked out until you turn the scanner off and back on.
- Lockout: The site is permanently locked out.

## Set Hold Time

Set the minimum number of seconds the scanner should spend checking this system or site even if there is no traffic on any channel. (The scanner always checks each channel in a system or site once even if the hold time is set to 0 seconds.) Select the number of seconds from 0 through 255 (0 is the default).

## [Set LocationInfo](#)

Use this menu to program location information for this site.

## Set State ([BCT15X](#) Only)

Sets the U.S. State or Canadian Province associated with the system. If selected, the system will be unlocked when you set the scanner to the state and locked out when you

select a different state.

## Delete Site

Delete this site and all its settings; this includes any frequencies.

## New Site

Create a new site.

## Options available for Motorola systems

### [Edit Band Plan](#)

### [P25 Waiting Time](#) ([BCD396XT](#) and [BCD996XT](#) Only)

## Options available for P25 systems ([BCD396XT](#) and [BCD996XT](#) Only)

### Edit Band Plan (P25)

Most P25 systems include the band plan information in the control channel data. However, if a system does not include this information, you can program it manually.

The scanner will prompt you for the following information:

<b>Band plan number</b>	Select one of the 16 available band plan slots.
<b>Input Base Freq</b>	Enter the lower limit of the band frequency. Valid frequencies are between 25.00000 MHz and 1300.00000 MHz at each 5.0 Hz step (25.000000 MHz, 25.000005 MHz, 25.000010 MHz, etc.).

<b>Input Spacing</b>	Enter the number of kHz between each channel. Valid spacings range between 125 kHz and 128 kHz at each 125 Hz step (125.000 kHz, 125.125 kHz, 125.250 kHz, etc.)
----------------------	--

When you're finished, the scanner renames the band plan in the following pattern:

*{band plan number} : {base frequency} / {spacing}*

So a band plan label of 6:534.02585/127.750 means this is band plan number 6, with a base frequency of 534.02585 MHz and 127.750 kHz between each channel.

## Options available for EDACS systems

### Set Site Type

Select *Wide (standard)* or *Narrow* according to the EDACS site type.

### Volume Offset (EDACS SCAT Only)

The scanner can automatically adjust the volume when it tunes to this channel or frequency. Enter one of the following options:

Softer	No Change	Louder
-3, -2, - 1	0 (default)	+1, +2, +3

This page applies to the following scanner(s): [BCD996XT](#) [BCT15X](#) [BCD396XT](#) [BC346XT](#) [Users Guide](#)

# Set Frequencies

To determine whether the information on this page applies to your scanner, see the tags at the bottom of the page.

This menu lets you create frequencies and edit existing ones. All existing frequencies are listed in the order they were created: select the frequency you want to edit, or select New Frequency to create a new one. When creating frequencies, keep the following rules in mind:

- You can't duplicate frequencies within a site.
- You can store at least 500 frequencies per site.
- You can store up to 1000 frequencies per site, depending on the number of TGID in the entire system.
- [Set Frequencies](#)
  - [Edit Frequency](#)
  - [Set Lockout](#)
  - [Delete Frequency](#)
  - [New Frequency](#)
- [LTR and EDACS system options](#)
  - [LCN \(Logical Channel Number\)](#)
- [EDACS SCAT system options](#)
  - [Set Number Tag](#)
  - [Volume Offset](#)
  - [Set Record \(BCD996XT and BCT15X Only\)](#)

## Edit Frequency

Enter a valid frequency for this band. If the frequency is invalid or if it already exists, the scanner sounds an error tone and prompts you to re-enter the frequency.

## Set Lockout

Determines whether the frequency will be scanned. If you lock out the frequency and the frequency is used as the control channel, the system will not be scanned.

- Temporary Lockout - The lockout will be cleared when you cycle power.
- Lockout - The lockout must be manually cleared.
- Unlocked - The scanner will use the frequency when monitoring the system.

## Delete Frequency

Delete this frequency or channel and all associated settings.

## New Frequency

Create a new frequency.

## LTR and EDACS system options

When you're editing site frequencies within an LTR or EDACS wide or narrow system, you have the following additional options:

### LCN (Logical Channel Number)

When you enter a new frequency or edit an existing frequency, the scanner prompts you enter a logical channel number (LCN). Enter a number from 1 through 20 for an LTR system or a number from 1 through 30 for an EDACS wide or narrow system.

## EDACS SCAT system options

When you're editing site frequencies within an EDACS SCAT system, you have the following additional options:

### Set Number Tag

Assign a number to this system or channel that you can use to tune directly to a specific channel. Choose a number from 0 to 999. (For more information, see [Number Tags](#).)

### Volume Offset

The scanner can automatically adjust the volume when it tunes to this channel or



frequency. Enter one of the following options:

Softer	No Change	Louder
-3, -2, - 1	0 (default)	+1, +2, +3

### **Set Record (BCD996XT and BCT15X Only)**

Turn on this option to have the scanner output transmissions from the RECORD OUT jack.

This page applies to the following scanner(s): [BCD996XT](#) [BCT15X](#) [BCD396XT](#)  
[BC346XT](#) [Users Guide](#)

<b>System Name:</b>	Irving Public Safety System
<b>Location:</b>	Irving, TX
<b>County:</b>	Dallas
<b>System Type:</b>	EDACS Standard
<b>System Voice:</b>	Analog
<b>Last Updated:</b>	11-08-2007 03:40

---

**System Frequencies**  
Red are Primary Control Channels      Blue are Secondary Control Channels

Site	Description							
001	Primary	01-868.53750*	02-868.08750	03-868.58750	04-855.46250	05-868.63750	06-857.21250	07-868.73750
		08-868.83750	09-868.58750	10-868.91250				

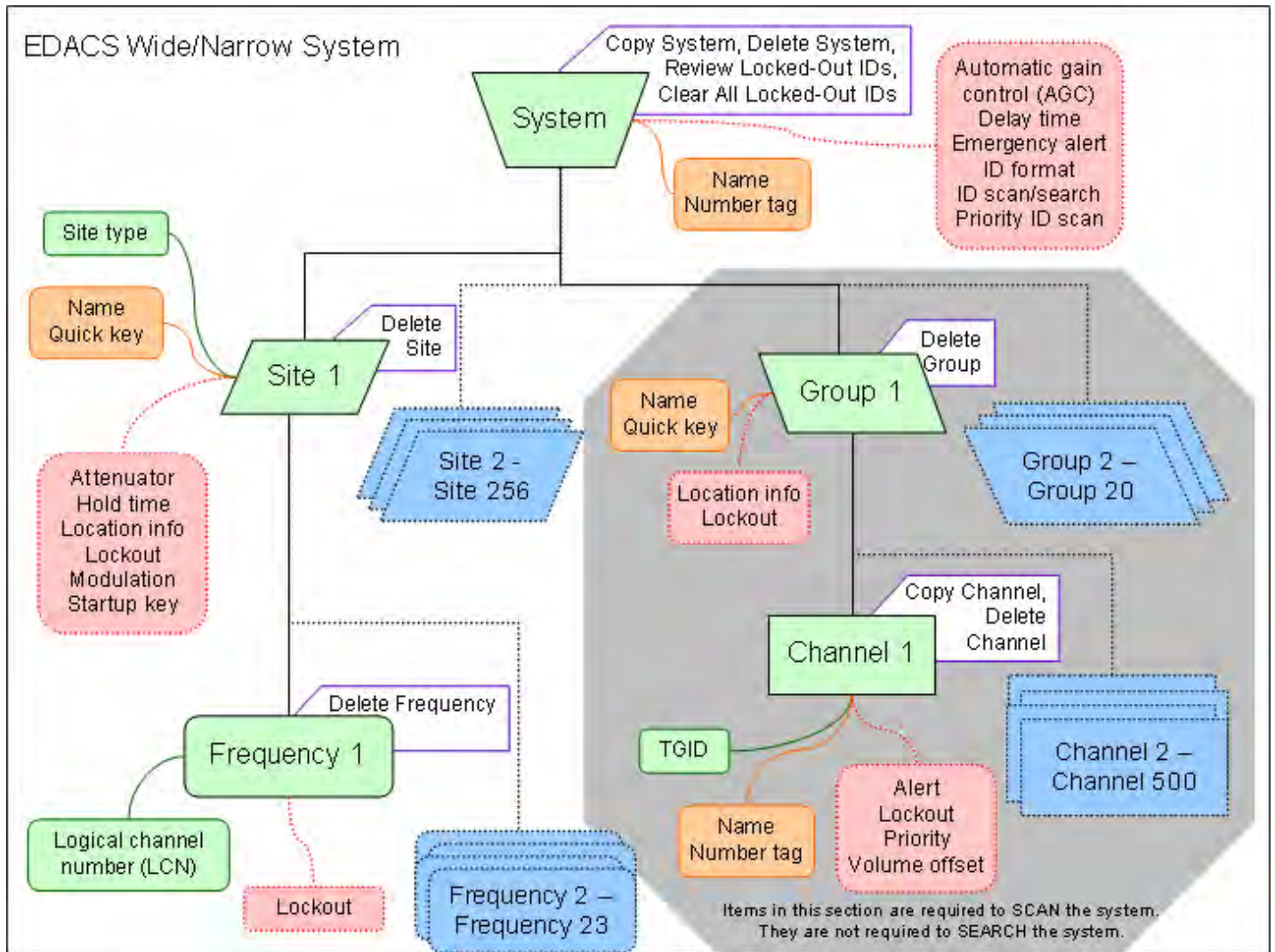





# Edit Talk Group ID

To determine whether the information on this page applies to your scanner, see the tags at the bottom of the page.

All Talk Group IDs must be in the proper format for each system type.

- [Motorola Type I Systems](#)
- [Motorola Type II Systems](#)
- [P25 Single Frequency Systems \(BCD396XT and BCD996XT only\) or Standard System Trunk Site](#)
- [EDACS Wide or Narrow Systems](#)
  - [AFS format](#)
- [I-Call channel \(Motorola, P25 \(BCD396XT and BCD996XT Only\), or EDACS\)](#)
- [LTR systems](#)

## Motorola Type I Systems

Enter the Talk Group ID in the following format:

BFFF-SS

- B = Block # (1 digit)
- F = Fleet # (2-3 digits)
- S = Sub-Fleet # (1-2 digits)

Press the decimal key to enter the hyphen.

(If you try to enter a hexadecimal TGID for a Type I system, the scanner treats the entry as a decimal number.)

## Motorola Type II Systems

- Decimal format: Enter the TGID in numbers only, up to 5 digits
- Hexadecimal format: up to 3 characters

Select the first Hex character (0 through F), then move the cursor to the right and select the second character. Press yes when you're finished.

## **P25 Single Frequency Systems ([BCD396XT](#) and [BCD996XT](#) only) or Standard System Trunk Site**

- Decimal format: Enter the TGID in numbers only, up to 8 digits
- Hexadecimal format: up to 6 characters

Select the first Hex character (0 through F), then move the cursor to the right and select the second character. Press yes when you're finished.

## **EDACS Wide or Narrow Systems**

### **AFS format**

Enter the Talk Group ID in the following format:

AA-FFS

- A = Agency # (00 - 15)
- F = Fleet # (00 - 15)
- S = Sub-fleet # (0 - 7)

Press the decimal key to enter the hyphen.

Leave the Fleet or Sub-Fleet # empty to treat it as a wildcard (any Sub-Fleet within that Fleet). For example, "15-" will match all TGIDs for Agency 15. "15-04-" will match all TGIDs for Agency 15, Fleet 4.

## **I-Call channel (Motorola, P25 ([BCD396XT](#) and [BCD996XT](#) Only), or EDACS)**

Enter the Talk Group ID in the following format:

i { ID number }

Press the decimal key to enter the lower-case i, then enter the ID number.

To monitor all iCalls, enter the iCall wildcard i0 in decimal or i in HEX.

## LTR systems

Enter the Talk Group ID in the following format:

AHHUUU

- A = Area Code (0 or 1)
- H = Home repeater (01 - 20)
- U = User ID (000 - 254)

Press the decimal key to enter the hyphen.

Leave the User ID empty to treat it as a wildcard. For example, "1-15-" will match all User IDs for Area Code 1, Home repeater 15.

This page applies to the following scanner(s): [BCD996XT](#) [BCT15X](#) [BCD396XT](#)  
[BC346XT](#) [Users Guide](#)



<b>System Name:</b>	American Airlines Center System							
<b>Location:</b>	Dallas, TX							
<b>County:</b>	Dallas							
<b>System Type:</b>	LTR Standard							
<b>System Voice:</b>	Analog							
<b>Last Updated:</b>	08-15-2004 21:23							
<b>System Frequencies</b>								
Site	Description							
001	Site-1	01-461.50000	02-N/A	03-461.70000	04-N/A	05-462.17500	06-N/A	07-463.87500
		08-N/A	09-N/A	10-N/A	11-464.40000	12-N/A	13-N/A	14-463.33750
		15-N/A	16-464.08750	17-N/A	18-464.18750			

# LTR System

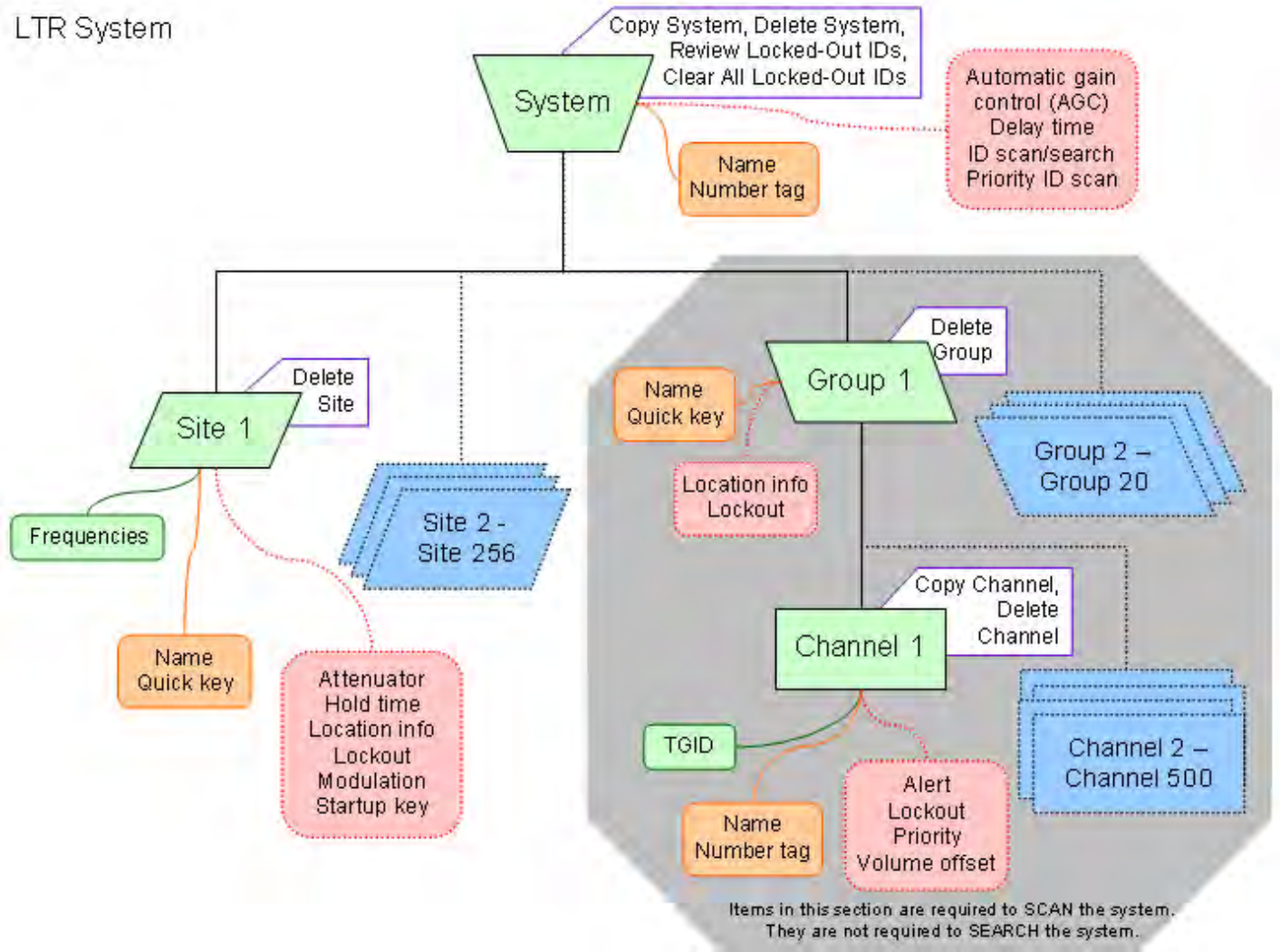

<b>System Name:</b>	Grand Prairie System
<b>Location:</b>	Grand Prairie, TX
<b>County:</b>	Dallas
<b>System Type:</b>	Motorola Type II SmartZone
<b>System Voice:</b>	Analog and APCO-25 Common Air Interface
<b>Last Updated:</b>	06-19-2006 16:37

Sysid	CT	WACN
2515	105.88	

### System Frequencies

**Red\*** are Primary Control Channels      **Blue\*** are Secondary Control Channels

Site	Description	Freqs								
001	Primary	856.96250	857.96250*	858.96250*	859.96250*	860.96250*	868.23750	868.51250	868.76250	868.96250

<b>System Name:</b>	Arlington System
<b>Location:</b>	Arlington, TX
<b>County:</b>	Tarrant
<b>System Type:</b>	Motorola Type II Smartnet
<b>System Voice:</b>	Analog
<b>Last Updated:</b>	09-12-2006 14:37

Sysid	CT	WACN
162A	105.88	

**System Frequencies**

**Red\*** are Primary Control Channels      **Blue\*** are Secondary Control Channels

Site	Description	Freqs									
001	Primary	856.48750	856.71250	857.48750	857.71250*	858.48750	858.71250*	859.48750	859.71250*	860.48750	
		860.71250*	867.56250	868.26250							

<b>System Name:</b>	United Parcel Service (DFW Airport) System		
<b>Location:</b>	DFW Airport, TX		
<b>County:</b>	2 counties		
<b>System Type:</b>	Motorola Type II Smartnet		
<b>System Voice:</b>	Analog		
<b>Last Updated:</b>	06-04-2007 18:42		

System ID Table		
Sysid	CT	WACN
7507	116.13	

Custom Frequency Table		
Base	Spacing	Offset
461.5000	380	12.5
451.0000	560	12.5

---

**System Frequencies**  
Red\* are Primary Control Channels      Blue\* are Secondary Control Channels

Site	Description	Freqs								
001	Primary	451.31250	451.66250	451.68750	452.03750	452.53750	452.68750*	452.88750*	462.18750*	462.48750*

<b>System Name:</b>	Staffordshire Fire & Rescue System
<b>Location:</b>	Staffordshire, EN
<b>County:</b>	Staffordshire
<b>System Type:</b>	Motorola Type II Smartnet
<b>System Voice:</b>	Analog
<b>Last Updated:</b>	02-01-2008 11:17

System ID	CT	WACN
1533		

Base	Spacing	Offset
152.0000	380	12.5
154.0000	461	12.5

### System Frequencies

**Red\*** are Primary Control Channels      **Blue\*** are Secondary Control Channels

Site	Description	Freqs								
001	North Simulcast	153.82500 155.61250	154.08750	154.72500	154.88750	155.07500	155.30000	155.41250*	155.43750	155.56250
002	South Simulcast	152.15000*	152.26250	152.31250	152.53750	152.82500	155.21250	155.52500	155.55000	155.87500
006	Site-6	152.83750 155.81250	154.08750	154.72500	154.88750	155.07500	155.30000	155.41250*	155.43750	155.56250
011	Site-11	152.02500*	154.57500	154.75000						

# Motorola System

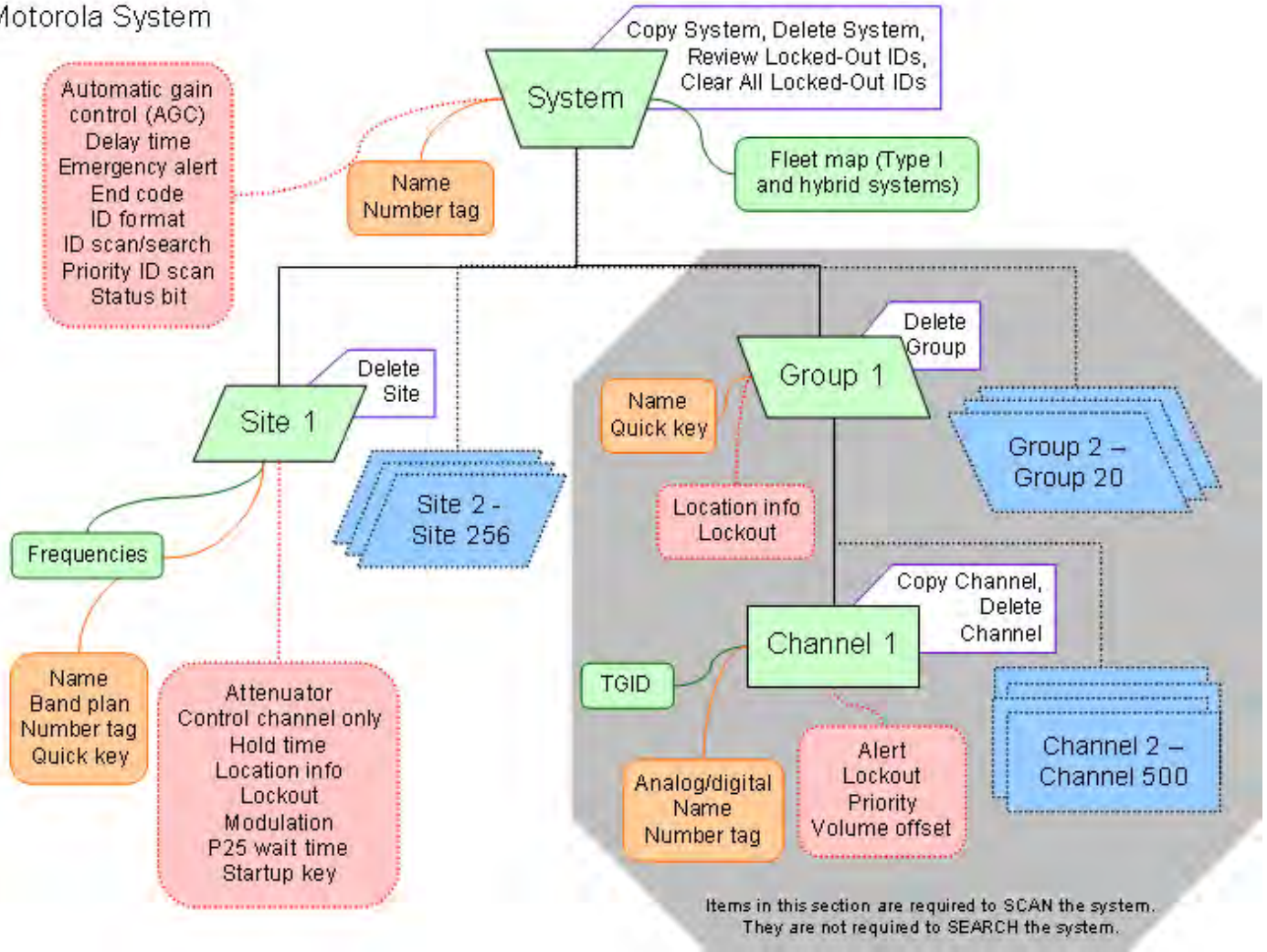







### Motorola System Worksheet B (Fleet Maps)

<b>Fleet Map #:</b>	
<b>Block Information:</b>	
<b>Block</b>	<b>Size Code</b>
Block 0	
Block 1	
Block 2	
Block 3	
Block 4	
Block 5	
Block 6	
Block 7	

<b>Fleet Map #:</b>	
<b>Block Information:</b>	
<b>Block</b>	<b>Size Code</b>
Block 0	
Block 1	
Block 2	
Block 3	
Block 4	
Block 5	
Block 6	
Block 7	

<b>Fleet Map #:</b>	
<b>Block Information:</b>	
<b>Block</b>	<b>Size Code</b>
Block 0	
Block 1	
Block 2	
Block 3	
Block 4	
Block 5	
Block 6	
Block 7	

<b>Fleet Map #:</b>	
<b>Block Information:</b>	
<b>Block</b>	<b>Size Code</b>
Block 0	
Block 1	
Block 2	
Block 3	
Block 4	
Block 5	
Block 6	
Block 7	

<b>Fleet Map #:</b>	
<b>Block Information:</b>	
<b>Block</b>	<b>Size Code</b>
Block 0	
Block 1	
Block 2	
Block 3	
Block 4	
Block 5	
Block 6	
Block 7	

<b>Fleet Map #:</b>	
<b>Block Information:</b>	
<b>Block</b>	<b>Size Code</b>
Block 0	
Block 1	
Block 2	
Block 3	
Block 4	
Block 5	
Block 6	
Block 7	

<b>Fleet Map #:</b>	
<b>Block Information:</b>	
<b>Block</b>	<b>Size Code</b>
Block 0	
Block 1	
Block 2	
Block 3	
Block 4	
Block 5	
Block 6	
Block 7	

<b>Fleet Map #:</b>	
<b>Block Information:</b>	
<b>Block</b>	<b>Size Code</b>
Block 0	
Block 1	
Block 2	
Block 3	
Block 4	
Block 5	
Block 6	
Block 7	

# Edit Band Plan

(Motorola systems only) The scanner prompts you to choose one of the two standard band plan types: *800/900 Standard* or *800 Splinter*. Choose *Custom* if you need to create your own band plan.

- [Creating a custom band plan](#)
  - [Band plan number](#)
  - [Set Base Freq](#)
  - [Set Offset](#)
  - [Set Spacing](#)
  - [Rebanded Motorola Systems](#)

## Creating a custom band plan

You will need to create a custom band plan for a Motorola VHF, UHF, and 800 MHz Rebanded system. When you select *Custom*, the scanner prompts you for the following information:

### Band plan number

Select one of the 6 available band plan numbers, from *Band Plan 1* through *Band Plan 6*.

### Set Base Freq

1. Input the lower limit of the band frequency.
2. Input the upper limit of the band frequency.

(See [Calculating upper base frequencies](#) for more information.)

### Set Offset

Enter the offset.

## Set Spacing

Select the number of kHz between each channel. Your options are:

5.00	6.25	10.00	12.50	15.00	18.75	20.00	25.00
30.00	31.25	35.00	37.50	40.00	43.75	45.00	50.00
55.00	56.25	60.00	62.50	65.00	68.75	70.00	75.00
80.00	81.25	85.00	87.50	90.00	93.75	95.00	100.00

## Rebanded Motorola Systems

When you create a system that has been rebanded to use the frequencies newly added for use by the FCC, you have the option now of selecting 800MHz Custom as the Motorola system type.

Once you create the system, you can set the custom band plan as follows:

1. Edit System Option --> Edit Band Plan
2. Select the band plan entry to edit.
3. Set each of the following entries for the band plan:
  - a. Set Base Freq (Lower and Upper)
  - b. Set Offset
  - c. Set Spacing

For standard rebanded systems, you need to set Band Plan 1 and Band Plan 2 as:

Band Plan	Base Freq (Lower)	Base Freq (Upper)	Offset	Polarity	Spacing
1	851.025MHz	854.000MHz	440	+	25 kHz
2	851.0125MHz	868.9875MHz	0	+	25 kHz

This page applies to the following scanner(s): [BCD996XT](#) [BCT15X](#) [BCD396XT](#)  
[BC346XT Users Guide](#)

<b>System Name:</b>	Austin / Travis County / Williamson County / Middle Rio Grande System
<b>Location:</b>	Austin, TX
<b>County</b>	10 counties
<b>System Type:</b>	Project 25 Standard
<b>System Voice:</b>	APCO-25 Common Air Interface Exclusive
<b>Last Updated:</b>	02-28-2008 09:44

### System Frequencies

**Red\*** are Primary Control Channels      **Blue\*** are Secondary Control Channels

Site	Description	Freqs									
101	Simulcast 1	866.16250*	866.28750*	866.41250*	866.56250*	866.71250	866.81250	866.92500	867.08750	867.11250	
		867.31250	867.33750	867.57500	867.60000	867.82500	867.85000	868.10000	868.12500	868.36250	
		868.42500	868.62500	868.68750	868.95000						
102	Simulcast 2	866.13750*	866.31250*	866.38750*	866.58750*	866.73750	866.83750	867.16250	867.18750	867.41250	
		867.63750	867.68750	867.95000	868.05000	868.27500	868.32500	868.55000	868.57500	868.85000	
103	Marble Falls IR	866.46250	866.88750	867.28750	867.80000*	868.15000	868.75000				
104	Honeycomb IR	867.26250	867.72500*	868.17500	868.77500						
105	Burleson Manor IR	867.87500	868.22500*	868.50000	868.92500						
106	USGS Shingle IR	867.66250	867.92500*	868.40000	868.80000						

# P25 Standard System

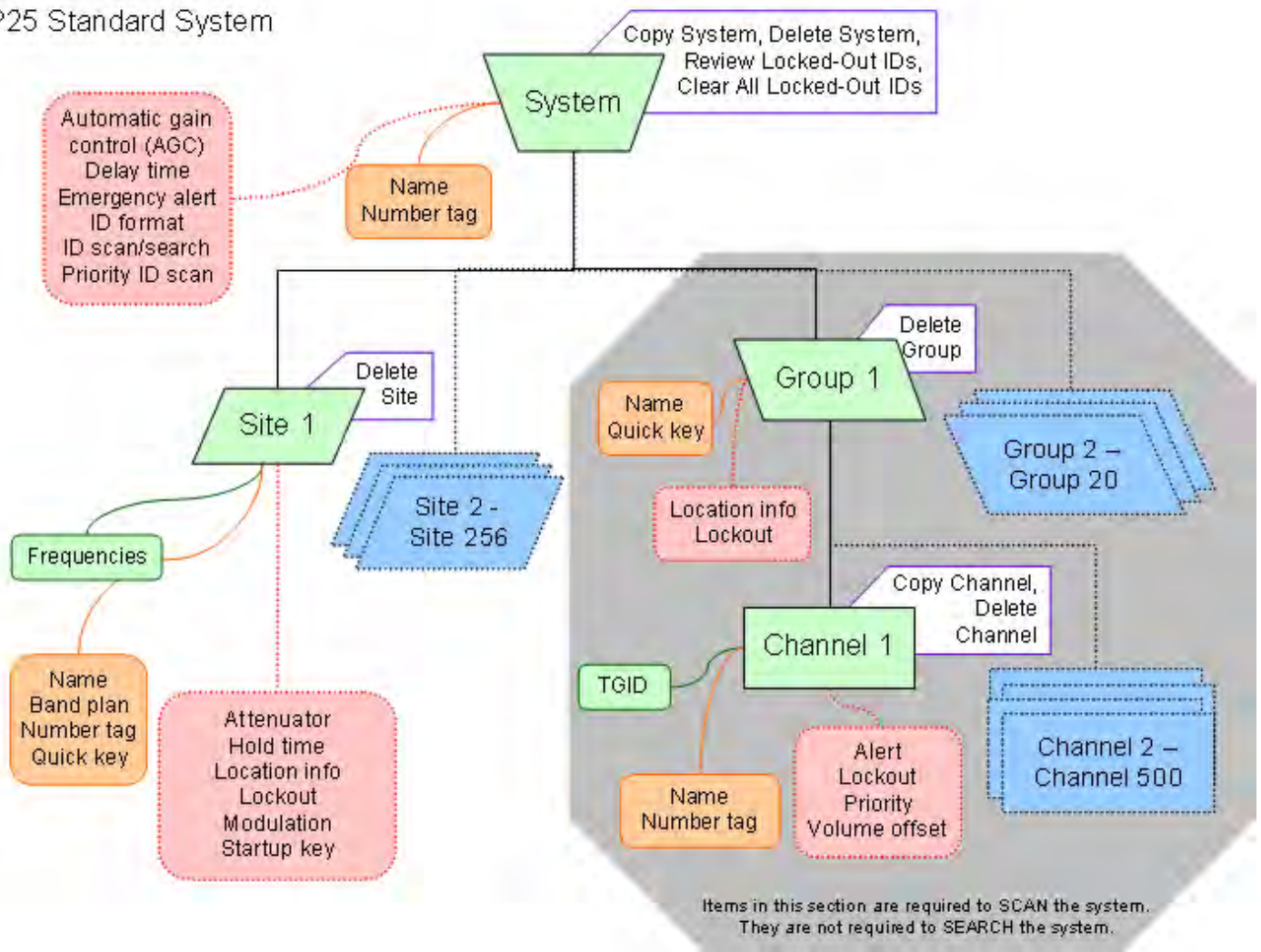

# P25 Single Frequency System

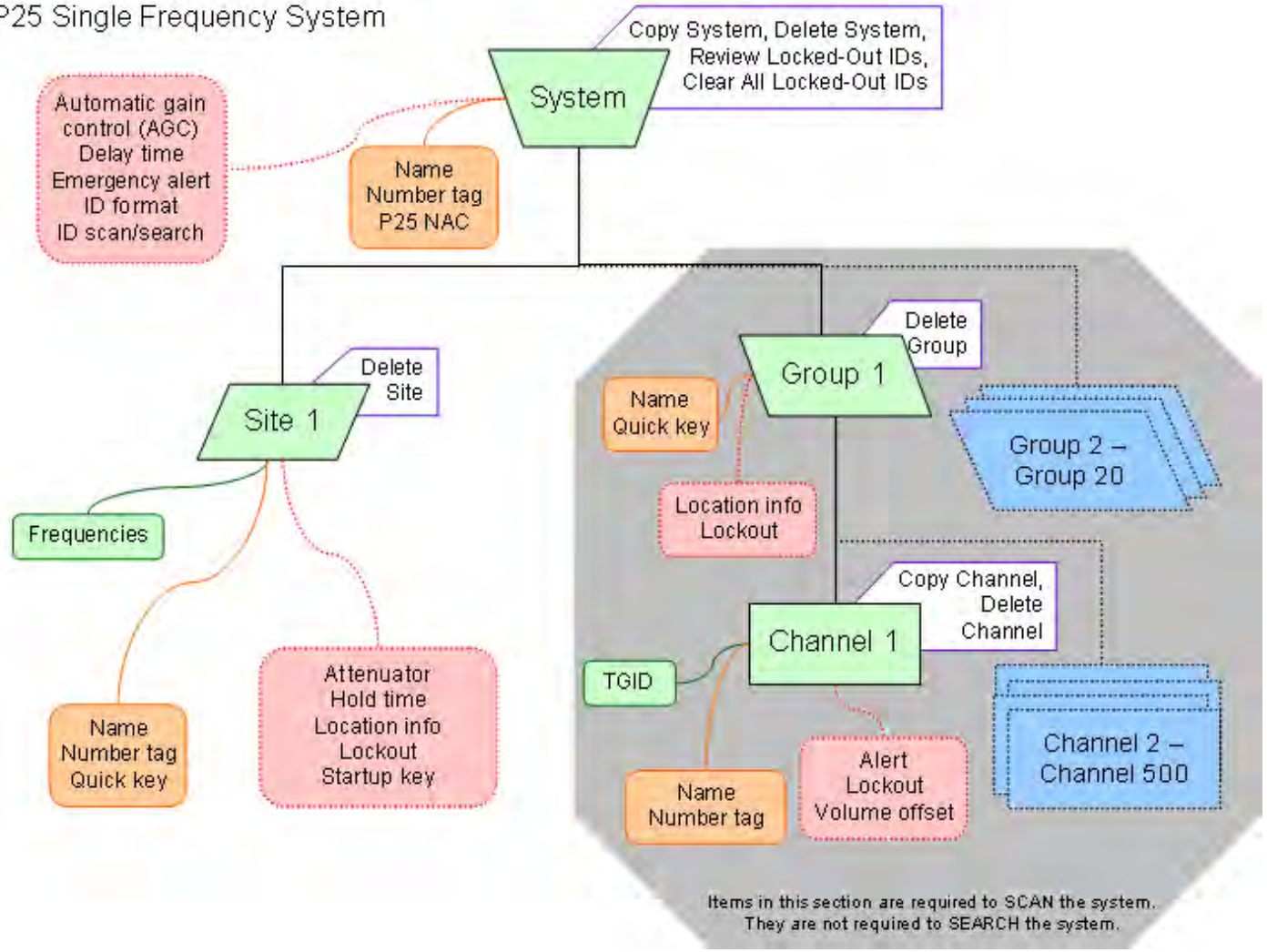



# Calculating upper base frequencies

Custom Band Plans (800 Custom, VHF, UHF) require that you enter both a lower and an upper base frequency value. Here's how to determine these values.

The *Lower Base Frequency* (or *Base* ) is always the base frequency as provided in the RRDB. The *Upper Base Frequency* is calculated from the following formulas:

## For sites with a single band plan:

$$Base + ( (759 - Offset) \times Step )$$

Where:

- *Base* = the lower base frequency listed in RRDB.
- *Offset* = the offset for this entry.
- *Step* = the step for this entry.

## For sites with multiple band plans:

$$Upper\ Base_n = Base_n + ( Offset_{n+1} - 1 - Offset_n ) \times Step_n$$

Where:

- *Base<sub>n</sub>* is the lower base frequency for the entry.
- *Offset<sub>n+1</sub>* is the Offset for the next band plan (for the last table, use 760)
- *Offset<sub>n</sub>* is the offset for this band plan
- *Step<sub>n</sub>* is the step for this band.

For example:

## Custom Frequency Table

Entry	Base	Spacing	Offset
A	155.4150	15.0	380
B	157.2000	12.5	436
C	157.4700	15.0	454

Plugging these values into our formula, we get:

<i>For entry A:</i>					
Upper Base <sub>A</sub>	=	$Base_A +$	$( Offset_B -$	$-$	$\times Step_A$
Upper Base <sub>A</sub>	=	155.415 MHz	1	$Offset_A )$	
Upper Base <sub>A</sub>	=	+	(436 - 1	- 380)	× 15kHz
Upper Base <sub>A</sub>	=	155.415 MHz	55		× 0.015 MHz
Upper Base <sub>A</sub>	=	+	0.825 MHz		
Upper Base <sub>A</sub>	=	<b>156.240 MHz</b>			

<i>For entry B:</i>					
Upper Base <sub>B</sub>	=	$Base_B +$	$( Offset_C -$	$-$	$\times Step_B$
Upper Base <sub>B</sub>	=		1	$Offset_B )$	

Upper Base <sub>B</sub>	=	157.200 MHz +	(454 – 1	– 436)	× 12.5 kHz
Upper Base <sub>B</sub>	=	157.200 MHz +	17		× 0.0125 MHz
Upper Base <sub>B</sub>	=	157.200 MHz +	0.2125 MHz		
Upper Base <sub>B</sub>	=	<b>157.4125 MHz</b>			

<i>For entry C:</i>					
Upper Base <sub>C</sub>	=	<i>Base<sub>C</sub></i> +	( <i>Offset<sub>C+1</sub></i> –	–	× <i>Step<sub>C</sub></i>
Upper Base <sub>C</sub>	=	157.470 MHz +	(760 – 1	– 454)	× 15 kHz
Upper Base <sub>C</sub>	=	157.470 MHz +	305		× 0.015 MHz
Upper Base <sub>C</sub>	=	157.470 MHz +	4.575 MHz		
Upper Base <sub>C</sub>	=	<b>162.045 MHz</b>			

( [Click here](#) to download a spreadsheet that will do all the math for you.)

This page applies to the following scanner(s): [BCD996XT](#) [BCT15X](#) [BCD396XT](#) [BC346XT](#) [Users Guide](#)

# Close Call

To determine whether the information on this page applies to your scanner, see the tags at the bottom of the page.

The Close Call (CC) feature searches for signals that are stronger than other signals on the band (indicating the transmitter is probably somewhere close by). This menu lets you change the operation settings of the close call feature; you can change the overall close call options through the [Srch/CloCall Opt](#) menu.

- [Close Call Only](#)
- [CC Auto Store](#)
- [Hits with Scan](#)
  - [Set Quick Key](#)
  - [Set Number Tag](#)
  - [Set Lockout](#)
  - [Set Hold Time](#)
- [Set CC Mode](#)
- [Set CC Override](#)
- [Set CC Alert](#)
  - [Set Alert Tone](#)
  - [Set Alert Light](#)
  - [Set CC Pause](#)
- [Set CC Bands](#)

## Close Call Only

Search the selected bands for close call hits; the scanner stops all other scanning for a close call only search.

## CC Auto Store

Start a close call search. When a close call hit is detected, the scanner stores that frequency in the system named *Close Call* in the *Found Channels* group. The scanner saves found channels until it reaches the number set in the *Max Auto Store* setting on the

[Srch/CloCall Opt](#) menu.

## Hits with Scan

The scanner stores the 10 most recent close call hits to a temporary system; you can set the options for this temporary system, just like you can for permanent systems. The scanner deletes the 10 saved frequencies in this temporary system when you turn the power off. If you want to save any of these frequencies permanently, you need to store them to a programmed system or use the CC Auto Store feature.

## Set Quick Key

Assign this system or site to a Quick Key so you can easily enable or disable it during scanning. Enter a number from 0 to 99; tap NO (the decimal point) if you don't want to assign this system or site to a Quick Key. (For more information, see [Quick Keys](#).)

## Set Number Tag

Assign a number to this system you can use to tune directly to the system. Choose a number from 0 to 999. (For more information, see [Number Tags](#).) Note that you can only set a system number tag for the Close Call system.

## Set Lockout

Decide whether you want to lock out the system so the scanner will ignore it during Scan and Search modes. If you lock out the system none of the found channels will be scanned conventionally.

*Unlocked:* The system is not locked out.

*Temporary L/O:* The system is locked out until you turn the scanner off and back on.

*Lockout:* The system is permanently locked out.

## Set Hold Time

Set the minimum number of seconds the scanner should spend checking this system or

site even if there is no traffic on any channel. (The scanner always checks each channel in a system or site once even if the hold time is set to 0 seconds.) Select the number of seconds from 0 through 255 (0 is the default).

## Set CC Mode

Choose whether scanner runs close call checks in the background, while you're performing other scans or searches. (The scanner never runs close call checks when you're in weather mode or tone-out mode.)

- *Off*: The scanner does not run close call checks in the background.
- *CC DND*: The scanner runs close call checks every 2 seconds, but it will not leave an active channel for a close call check.
- *CC Pri*: The scanner runs close call checks every 2 seconds, even if the current channel is active. The scanner runs the close call check even while you are monitoring a transmission.

## Set CC Override

Choose *On* if you want the scanner to stop its current operation and automatically jump to the frequency when it detects a close call hit. Choose *Off* if you want the scanner to alert you to the close call hit and prompt you to change frequency; if you choose not to change frequency, the scanner times out and returns to its previous operation.

## Set CC Alert

Decide whether the scanner triggers an alert tone and light when it detects a close call hit. (Compare this to the system setting [Emergency Alert](#), which triggers a tone and light when a Talk Group contains an emergency flag.) The available options for [Set Alert Tone](#) and [Set Alert Light](#) are common to both types of alerts.

### [Set Alert Tone](#)

### [Set Alert Light](#)

## Set CC Pause

Choose how long you want the scanner to pause on a close call hit before going back to its previous operation; this setting only applies when the Set CC Override feature is turned off. Choose a pause time of 3, 5, 10, 15, 30, 45, or 60 seconds. If you want the scanner to wait for your input whenever it detects a close call hit, select Infinite.

## Set CC Bands

Choose whether you want the scanner to search for close call hits on the frequency bands listed below. Select each band you want to search, then press **YES** to turn that band *On* . The scanner only searches for close call hits on bands that are turned on.

<b>Band</b>	<b>BCD396XT and BCD996XT frequencies</b>	<b>BC346XT frequencies</b>	<b>BCT15X frequencies</b>
<i>VHF Low 1</i>	25.0000–53.9800 MHz	25.0000–53.9800 MHz	25.0000-53.9800 MHz
<i>VHF Low 2</i>	54.0000–107.9000 MHz	54.0000–107.9000 MHz	54.0000-107.9000 MHz
<i>Air Band</i>	108.0000–136.9916 MHz	108.0000–136.9916 MHz	108.0000-136.9916 MHz
<i>VHF High 1</i>	137.0000–224.9800 MHz	137.0000–224.9800 MHz	137.0000-224.9800 MHz
<i>VHF High 2</i>	225.0000–319.9500 MHz	Not available	225.0000-319.9500 MHz
<i>UHF</i>	320.0000–512.0000 MHz	400.0000–512.0000 MHz	320.0000-512.0000 MHz

<p>800 MHz +</p>	<p>758.0000–823.9875 MHz 849.0125–868.9875 MHz 894.0125–960.0000 MHz 1240.0000– 1300.0000 MHz</p>	<p>806.0000–823.9875 MHz 849.0125–868.9875 MHz 894.0125–960.0000 MHz 1240.0000– 1300.0000 MHz</p>	<p>758.0000-823.9875 MHz 849.0125-868.9875 MHz 894.0125-960.0000 MHz 1240.0000- 1300.0000 MHz</p>
----------------------	---	---	---

This page applies to the following scanner(s): [BCD996XT](#) [BCT15X](#) [BCD396XT](#)  
[BC346XT Users Guide](#)



# Introduction to SAME messages

Hazard alerts are transmitted with Specific Area Message Encoding (SAME) data, which includes:

- Nature of the alert
- Hazard level
- Affected counties
- Expiration time

Receivers that can decode the SAME data can filter alerts by area and/or hazard level and show details about the alert on a display. For a table of all the alerts and the code meanings, [click here](#).

## FIPS Codes

The US National Weather Service uses 6-digit Federal Information Processing System (FIPS) codes to issue hazard alerts in specific areas. You can choose which areas you want to hear alerts for by programming the appropriate FIPS codes into your receiver: the receiver only sounds the alert tone if an incoming FIPS code matches one of the areas you entered.

Each county (or parish, etc.) is designated by a 5-digit FIPS code; parts of a county are marked by a section code inserted at the front:

Code	Country area
0	Entire County (default)
1	Northwest
2	North Central
3	Northeast
4	West Central

5	Central
6	East Central
7	Southwest
8	South Central
9	Southeast

- Very few counties are large enough to use the section code; most counties just code all hazards as 0 for the entire county.
- If you use 0 for the section code, you will receive all alerts for that county regardless of the transmitted section code (because the entire county includes all sections of the county).
- If you use any other section code, you will only receive alerts for that section and entire county alerts. For example, if you program the section code as 5 (Central), you will receive alerts transmitted with section code 0 and section code 5. You will not receive alerts that are transmitted with section codes 1 through 4 or 6 through 9.

For a complete index of the FIPS codes used in SAME broadcasts, see the [United States and Territories Table](#) at the National Weather Radio website, or call **1-888-NWR-SAME (1-888-697-7263)** for a voice menu.

This page applies to the following scanner(s): [BCD996XT](#) [BCT15X](#) [BCD396XT](#) [BC346XT](#) [Users Guide](#)

## Wired Clone

This feature allows you to copy all the settings from one scanner to another of the same model:

1. Use one of the included data cables to connect the two scanners. Plug the DB9 end into the rear port of one scanner and the other end into the front port of the other scanner.
2. On the scanner you want to copy from, go to the *Wired Clone* menu and select *Master* then select the port (*Front Port* or *Rear Port*) that the cable is connected to on that scanner .
3. On the scanner you want to copy to, go to the *Wired Clone* menu and select *Slave* then select the port (*Front Port* or *Rear Port*) that the cable is connected to on that scanner .

The master scanner checks to make sure the slave is properly connected and ready to receive, then begins the data transfer. **Do not disconnect the data cable or turn off either scanner during the transfer.**

When the transfer is finished, both scanners display a *Complete* message. Reboot the slave scanner to load the new settings.

**All settings and data saved on the Slave scanner will be erased!**

This page applies to the following scanner(s): [BCD996XT](#) [BCT15X](#) [Users Guide](#)

# Motorola fleet maps

- [Preset Fleet Maps](#)
- [Custom Fleet Maps](#)
- [How Fleet Maps Work](#)
  - [Blocks](#)
  - [Size Codes](#)

## Preset Fleet Maps

The scanner contains 16 pre-programmed fleet maps you can select. The table below gives the size code for each block of the preset fleet maps:

<b>Block number</b>	<b>0</b>	<b>1</b>	<b>2</b>	<b>3</b>	<b>4</b>	<b>5</b>	<b>6</b>	<b>7</b>
Preset 1	11	11	11	11	11	11	11	11
Preset 2	4	4	4	4	4	4	4	4
Preset 3	4	4	4	4	4	4	12	
Preset 4	12		4	4	4	4	4	4
Preset 5	4	4	12		4	4	4	4
Preset 6	3	10	4	4	12		12	
Preset 7	10	10	11	4	4	4	4	4
Preset 8	1	1	2	2	3	3	4	4
Preset 9	4	4	0	0	0	0	0	0
Preset 10	0	0	0	0	0	0	4	4
Preset 11	4	0	0	0	0	0	0	0

Preset 12	0	0	0	0	0	0	0	4
Preset 13	3	3	11	4	4	0	0	0
Preset 14	4	3	10	4	4	4	12	
Preset 15	4	4	4	11	11	0	12	
Preset 16	3	10	10	11	0	0	12	

## Custom Fleet Maps

To program a custom fleet map, select *Custom* under the *Edit Fleet Map* option. Then, select the appropriate size code for each block. Remember, not all size codes are available for all blocks:

Block	Valid Size Codes
Block 0	0 - 14
Block 1	0 - 13 (14 not valid)
Block 2	0 - 13 (14 not valid)
Block 3	0 - 13 (14 not valid)
Block 4	0 - 13 (14 not valid)
Block 5	0 - 12 (13, 14 not valid)
Block 6	0 - 12 (13, 14 not valid)

Block 7	0 - 11 (12, 13, 14 not valid)
------------	----------------------------------

## How Fleet Maps Work

### Blocks

Talk Group IDs can range from 0 to 65,535. To make it easier to handle this many IDs, the system divides the TGID range into 8 equal *blocks* :

Block	Starting ID	Ending ID
Block 0	0	8191
Block 1	8192	16383
Block 2	16384	24575
Block 3	24576	32767
Block 4	32768	40959
Block 5	40960	49151
Block 6	49152	57343
Block 7	57344	65535

### Size Codes

Each block is assigned a *size code* based on the way the control channel sends the TGID data. Note that codes 12, 13, and 14 take up more than one block:

<b>Size Code</b>	<b>Fleet / SubFleet? / ID</b>	<b>Number of Blocks Needed</b>
0	(as Type II ID)	1
1	128 / 4 / 16	1
2	16 / 8 / 64	1
3	8 / 8 / 128	1
4	1 / 16 / 512	1
5	64 / 4 / 32	1
6	32 / 8 / 32	1
7	32 / 4 / 64	1
8	16 / 4 / 128	1
9	8 / 4 / 256	1
10	4 / 8 / 256	1
11	2 / 16 / 256	1
12	1 / 16 / 1024	2
13	1 / 16 / 2048	4
14	1 / 16 / 4096	8

This page applies to the following scanner(s): [BCD996XT](#) [BCT15X](#) [BCD396XT](#) [BC346XT](#) [Users Guide](#)

# Priority Scan

To determine whether the information on this page applies to your scanner, see the tags at the bottom of the page.

This section applies to conventional system priority mode only. For priority on trunked systems, turn on the Priority ID system option and set the desired channels as priority channels.

Priority mode has two "sub modes" (similar to Close Call and Close Call Only):

- In *Priority Scan* mode, the scanner pauses the current operation at a designated interval to check for activity on any unlocked channels set as priority channels. After the priority channel check is complete, the scanner resumes the previous operation.
- In *Priority Plus Scan* mode, the scanner stops the current operation and only checks the priority channels.
- [Priority Scan menu](#)
  - [Set Priority](#)
  - [Set Interval](#)
  - [MaxCHs/Pri-Scan](#)

## Priority Scan menu

Use the *Priority Scan* menu to control how Priority mode operates:

### Set Priority

Choose one of the following priority scan methods:

- *On* : Enter Priority Scan mode; also, the scanner performs a normal priority scan whenever you enter Priority mode in the future.
- *Plus On* : Enter Priority Plus Scan mode; also, the scanner performs a priority plus scan whenever you enter Priority mode in the future.
- *Off* : Exit Priority mode, and do not go into Priority mode in the future.



## Set Interval

Decide how many seconds you want the scanner to wait between priority channel checks. Enter a number between 1 and 10 seconds. (This setting is used in normal priority scans only.)

## MaxCHs/Pri-Scan

Decide how many priority channels the scanner checks during each interval. Enter a number between 1 and 100. If the number of priority channels is greater than the number you enter here, the scanner divides them into groups. For example, if you set the maximum channels to 20 and there are 100 priority channels, the scanner checks those 100 channels in groups of 20 and takes a total of 5 intervals to complete the priority scan.

This page applies to the following scanner(s): [BCD996XT](#) [BCT15X](#) [BCD396XT](#)  
[BC346XT Users Guide](#)

# Program Location

The *Program Location* menu lets you create and edit points of interest ( *POI* ), intersections( *Dangerous Xing* ), and roads ( *Dangerous Road* ). The available settings vary for each location type.

- [POI](#)
  - [Edit Name](#)
  - [Set Type](#)
  - [Set Alert](#)
    - [Set Alert Light](#)
    - [Set Alert Tone](#)
  - [Set Location Info](#)
  - [Set Range](#)
  - [Set Lockout](#)
  - [Delete Location](#)
  - [New Location](#)
- [Dangerous Xing and Dangerous Road menus](#)
  - [Edit Name](#)
  - [Set Type](#)
  - [Set Alert Volume](#)
  - [Set Alert Light](#)
  - [Set Location Info](#)
  - [Set Heading](#)
  - [Set Speed Limit](#)
  - [Set Lockout](#)
  - [Delete Location](#)
  - [New Location](#)

## POI

### Edit Name

Enter a name or edit the existing one. Names can be 16 characters long, and they can contain upper and lower case letters, punctuation, and spaces. Turn the **SELECT-**

**VOLUME-SQUELCH** knob on the handheld scanners or the **SCROLL / FUNCTION** knob on mobile scanners to choose the character you want, then press **6** (right cursor) to move the cursor to the next character.

## Set Type

When you create a location, the location is created as the type you are currently viewing (POI, Dangerous Xing, or Dangerous Road). If you want to change the location type, you can select the new location type here.

When you change the location type, the scanner goes back to the *Program Location* menu. Select the new location type to edit this location; the scanner resets the available options based on the new location type.

## Set Alert

This menu lets you configure whether the scanner triggers an alert tone and light when you approach this location.

### [Set Alert Light](#)

This setting is exactly the same as its counterpart on the system, site, and channel menus. Click on the setting for a complete explanation.

## Set Alert Tone

Choose one of the available alert tones for this POI:

- *Alert 1* :

1047 Hz for 125 ms / Silence for 50 ms / 1047 Hz for 125 ms / Silence for 50 ms / 1319 Hz for 125 ms / Silence for 50 ms / 1568 Hz for 125 ms / Silence for 175 ms / 1319 Hz for 125 ms / Silence for 50 ms / 1568 Hz for 125 ms

- *Alert 2* :

1047 Hz for 200 ms / Silence for 200 ms / 1760 Hz for 250 ms / Silence

for 100 ms / 1397 Hz for 250 ms

- *Alert 3 :*

2093 Hz for 125 ms / Silence for 50 ms / 1976 Hz for 125 ms / Silence for 50 ms / 2093 Hz for 125 ms

- *Alert 4 :*

1319 Hz for 25 ms / Silence for 50 ms / 1397 Hz for 25 ms / Silence for 50 ms / 1175 Hz for 25 ms / Silence for 50 ms / 1319 Hz for 25 ms

- *Off* (No alert tone sounded).

If you select an alert tone, the scanner prompts you to select the volume level ( *Level 1* through *Level 15* ) you want to the alert tone to use; leave the volume at *Auto* to have the scanner sound the alert tone without changing the volume.

## Set Location Info

Enter the latitude and longitude for this location.

## Set Range

Enter how far out from this location you want the scanner to alert you. You can configure the scanner to sound an alert tone and flash a light when you reach the radius entered here. The scanner treats the number you enter here as miles or kilometers depending on the value you selected in the *Set Unit* field in the *Set GPS Format* menu (under the main [Settings](#) menu). Enter a range from 0.05 through 4.0 mi/km, in 0.05 mi/km steps.

## Set Lockout

Decide whether you want to lock out this location so the scanner no longer checks it.

Choose *Unlocked* (default), *Temporary L/O* (the location is locked out until you turn the scanner off and back on), or *Lockout* (the location is locked out until you change this setting).

## Delete Location

Delete this location and its settings, including any alert settings.

## New Location

Create a new location.

## Dangerous Xing and Dangerous Road menus

(The settings and available options for dangerous crossings and dangerous roads are exactly the same.)

## Edit Name

Enter a name or edit the existing one. Names can be 16 characters long, and they can contain upper and lower case letters, punctuation, and spaces. Turn the **SELECT-VOLUME-SQUELCH** knob on the handheld scanners or the **SCROLL / FUNCTION** knob on mobile scanners to choose the character you want, then press **6** (right cursor) to move the cursor to the next character.

## Set Type

When you create a location, the location is created as the type you are currently viewing (POI, Dangerous Xing, or Dangerous Road). If you want to change the location type, you can select the new location type here. When you change the location type, the scanner goes back to the *Program Location menu* . Select the new location type to edit this location; the scanner resets the available options based on the new location type.

## Set Alert Volume

Activate the alert tone for this location. Select the volume level ( *Level 1* through *Level 15* ) you want to the alert tone to use, or select *Auto* to have the scanner sound the alert tone without changing the volume. If you don't want the scanner to sound an alert as you approach this location, select *Off* .

The tone pattern varies depending on what type of location this is:

- Dangerous Xing alert tone:

1175 Hz for 250 ms / Silence for 50 ms / 1319 Hz for 50 ms / Silence for 50 ms / 1397 Hz for 250 ms

- Dangerous Road alert tone

1568 Hz for 250 ms / Silence for 50 ms / 1760 Hz for 50 ms / Silence for 50 ms / 1976 Hz for 250 ms / Silence for 50 ms / 2093 Hz for 50 ms / Silence for 50 ms / 1047 Hz for 250 ms

## [Set Alert Light](#)

This setting is exactly the same as its counterpart on the system, site, and channel menus. Click on the setting for a complete explanation.

## **Set Location Info**

Enter the latitude and longitude for this location.

## **Set Heading**

Decide whether the scanner alerts you of this Dangerous Xing or Road each time you approach it or only when you are traveling in a particular direction. To make the alert direction-dependent, select the direction from the list; select *All Range* to be alerted regardless of your direction.

## **Set Speed Limit**

Decide whether the scanner alerts you of this Dangerous Xing or Road each time you approach it or only when you are traveling above a certain speed. To make the alert speed-dependent, enter the speed limit for this location; leave the speed limit blank to be alerted regardless of your speed. The scanner treats the number you enter here as miles or kilometers depending on the value you selected in the Set Unit field in the Set GPS Format menu (under the main Settings menu). Enter a range from 0 through 200 mi/km, in 1 mi/km steps.

## Set Lockout

Decide whether you want to lock out this location so the scanner no longer checks it.

Choose *Unlocked* (default), *Temporary L/O* (the location is locked out until you turn the scanner off and back on), or *Lockout* (the location is locked out until you change this setting).

## Delete Location

Delete this location and its settings, including any alert settings.

## New Location

Create a new location.

This page applies to the following scanner(s): [BCD996XT](#) [BCT15X](#) [BCD396XT](#)  
[BC346XT Users Guide](#)

# Search and Store

To determine whether the information on this page applies to your scanner, see the tags at the bottom of the page.

With this feature, the scanner searches a system and saves any frequencies it finds activity on. When the scanner detects activity on a frequency, it verifies that the frequency has not already been stored, then adds the frequency to the *Found Channels* group. (Since these frequencies are stored with individual systems, you must have at least one programmed system to use the Search and Store feature.)

The scanner displays a list of all programmed systems. Select the system you want to search and add found channels to. The options you have depend on the type of system you select:

- If the system you selected is a **conventional system** , the scanner prompts you to select a custom search or a preset service search range.
- If the system you selected is a **trunked system** , the scanner prompts you to select a site within that system. The scanner searches the site for active Talk Groups and stores the Talk Group ID to the *Found Channels* group. (If the site you selected is locked, the scanner automatically unlocks it and begins the search.)
- If the system you selected is an **EDACS SCAT system** , the scanner displays an error message: the search and store feature can't be used on EDACS SCAT systems.

[Back to Search menu](#)

This page applies to the following scanner(s): [BCD996XT](#) [BCT15X](#) [BCD396XT](#)  
[BC346XT](#) [Users Guide](#)



# Search for...

To determine whether the information on this page applies to your scanner, see the tags at the bottom of the page.

Use this menu to start a search, to change the options for the three different types of searches, and program the 3 search keys.

- [Service Search](#)
- [Edit Service](#)
  - [Set Delay Time](#)
  - [Set Attenuator](#)
  - [Set Audio AGC \(BCD996XT and BCD396XT Only\)](#)
  - [Set Record \(BCD996XT and BCT15X Only\)](#)
  - [P25 Waiting Time \(BCD996XT and BCD396XT Only\)](#)
  - [Search with Scan](#)
- [Custom Search](#)
- [Edit Custom](#)
  - [Edit Name](#)
  - [Edit Srch Limit](#)
  - [Set Delay Time](#)
  - [Set Modulation](#)
  - [Set Attenuator](#)
  - [Set Step](#)
  - [Set C-Ch Only](#)
    - [Set MOT Band Plan](#)
  - [Set Audio AGC \(BCD996XT and BCD396XT Only\)](#)
  - [Set Record \(BCD996XT and BCT15X Only\)](#)
  - [P25 Waiting Time \(BCD996XT and BCD396XT Only\)](#)
  - [Search with Scan](#)
- [Search and Store](#)
- [Set Search Key](#)

## Service Search

Start a search of one of the 12 preset service bands. Choose from *Public Safety, News, HAM Radio, Marine, Railroad, Air, CB Radio, FRS/GMRS/MURS, Racing, FM Broadcast, Military Air* , or *Special* .

## Edit Service

This menu lets you change the default settings for the 12 preset service bands. Select the service you want to edit from the list, then set the following options:

### Set Delay Time

Set the number of seconds the scanner should wait after a transmission stops before moving on to the next channel. Select *0, 1, 2 (default), 5, 10, or 30 seconds*.

To have scanner leave the channel after a designated number of seconds whether the transmission stops or not, select one of the negative values. Choose *-10* seconds to have the scanner leave the channel after 10 seconds even if the transmission is still going on; choose *-5 seconds* or *-2 seconds* to have the scanner leave after 5 seconds or 2 seconds, respectively.

### Set Attenuator

Turn on attenuation to reduce the signal strength by 20 dB. All frequencies in the search range are attenuated during search.

### Set Audio AGC (BCD996XT and BCD396XT Only)

Turn on Automatic Gain Control (AGC) for this system. When you activate this feature, the scanner automatically adjusts the volume for each channel based on the signal strength. You can turn on the gain control for *Analog* and *Digital* signals separately.

To change the settings for the audio AGC, see [Adjust Audio AGC](#)

### Set Record (BCD996XT and BCT15X Only)

Set the scanner to provide the audio from found transmissions to the RECORD OUT jack on the back of the scanner.

## P25 Waiting Time (BCD996XT and BCD396XT Only)

When searching in a band that has a mix of analog and digital signals (i.e., where the *Audio Mode* is set to *All*), it is possible to have *false decode* problems that results in digital noise at the beginning of transmissions. To prevent this, a user-configurable P25 wait time (from 0 to 1000 ms) has been added.

During the wait time, the scanner evaluates the received signal; if it detects P25 data, the scanner opens squelch immediately. If it does not detect any P25 data, the scanner opens squelch as soon as the wait time expires.

Note: Any analog transmissions on this channel will lose the first part of the transmission, up to the wait time you set here.

Select the number of milliseconds (after the start of a transmission) the scanner should wait while checking for P25 data. Choose a number from 0 through 1000 ms in 100 ms increments. The scanner only applies the wait time when *Tone/Code Search* in *Srch/CloCall Opt* is set to *Off*.

### [Search with Scan](#)

## Custom Search

Start a search of the 10 custom search ranges.

## Edit Custom

This menu lets you program the ten custom search ranges. Select the custom search you want to edit from the list, then set the following options:

### Edit Name

Enter a name or edit the existing one. Names can be 16 characters long, and they can contain upper and lower case letters, punctuation, and spaces. Turn the **SELECT-VOLUME-SQUELCH** knob on the handheld scanners or the **SCROLL / FUNCTION** knob on mobile scanners to choose the character you want, then press **6** (right cursor) to

move the cursor to the next character.

## Edit Srch Limit

Change the range of frequencies covered by this custom search. The scanner prompts you to input the lower frequency limit and then the upper frequency limit.

## Set Delay Time

Set the number of seconds the scanner should wait after a transmission stops before moving on to the next channel. Select *0*, *1*, *2* (default), *5*, *10*, or *30 seconds*.

To have scanner leave the channel after a designated number of seconds whether the transmission stops or not, select one of the negative values. Choose *-10* seconds to have the scanner leave the channel after 10 seconds even if the transmission is still going on; choose *-5 seconds* or *-2 seconds* to have the scanner leave after 5 seconds or 2 seconds, respectively.

## Set Modulation

Select what type of modulation the scanner should use for this frequency or channel. (Only the modulation types available for this frequency or channel are displayed.)

<b>Auto</b>	The scanner uses the default modulation type for this frequency's band.
<b>AM</b>	The scanner treats the frequency as an AM band.
<b>NFM</b>	The scanner treats the frequency as a Narrowband FM band.
<b>FM</b>	The scanner treats the frequency as an FM band.
<b>WFM</b>	The scanner treats the frequency as a Wideband FM band.
<b>FMB</b>	The scanner treats the frequency as an FM broadcast band.

## Set Attenuator

Turn on attenuation to reduce the signal strength by 20 dB. All frequencies in the search range are attenuated during search.

## Set Step

Select the number of kHz between each channel. Choose *5.0, 6.25, 7.5, 8.33, 10.0, 12.5, 15.0, 20.0, 25.0, 50.0* or *100.0 kHz*. Select *Auto* to use the default step for this band.

## Set C-Ch Only

If you set C-Ch Only Mode to On, the scanner will only search for control channel data. If it detects such data it will stop on the control channel and display channel activity for the found system. For Motorola systems, it will try to follow voice channel traffic using the Motorola Band Plan you select in the next setting. It will also display the name of the found system if the system's ID matches a known system.

## Set MOT Band Plan

If this custom search is a Motorola system, you need to select a band plan, just like you do when you program a Motorola system for scanning. See [Edit Band Plan](#) for more information.

## Set Audio AGC (BCD996XT and BCD396XT Only)

Turn on Automatic Gain Control (AGC) for this system. When you activate this feature, the scanner automatically adjusts the volume for each channel based on the signal strength. You can turn on the gain control for *Analog* and *Digital* signals separately.

To change the settings for the audio AGC, see [Adjust Audio AGC](#)

## Set Record (BCD996XT and BCT15X Only)

Set the scanner to provide the audio from found transmissions to the RECORD OUT jack on the back of the scanner.

## P25 Waiting Time (BCD996XT and BCD396XT Only)

When searching in a band that has a mix of analog and digital signals (i.e., where the *Audio Mode* is set to *All*), it is possible to have *false decode* problems that results in digital noise at the beginning of transmissions. To prevent this, a user-configurable P25 wait time (from 0 to 1000 ms) has been added.

During the wait time, the scanner evaluates the received signal; if it detects P25 data, the scanner opens squelch immediately. If it does not detect any P25 data, the scanner opens squelch as soon as the wait time expires.

Note: Any analog transmissions on this channel will lose the first part of the transmission, up to the wait time you set here.

Select the number of milliseconds (after the start of a transmission) the scanner should wait while checking for P25 data. Choose a number from 0 through 1000 ms in 100 ms increments. The scanner only applies the wait time when *Tone/Code Search* in *Srch/CloCall Opt* is set to *Off*.

## [Search with Scan](#)

## [Search and Store](#)

Search a stored system and save the frequency information of any active channels.

## **Set Search Key**

The scanner has three one-touch search keys (number keys **1** , **2** , and **3** ) that you can assign to any saved search range.

1. Select the search key you want to program ( *Search Key 1* through *Search Key 3* ).
2. Select the search range you want to assign to this key. The search range can be a service search, a custom search, a tone-out search, or a band scope search.
3. Press **YES** to confirm the selection.

Once you assign a search range to a key, you can start the search just by pressing the appropriate key.

This page applies to the following scanner(s): [BCD996XT](#) [BCD396XT](#) [BCT15X](#) [Users Guide](#)

# Search with Scan

To determine whether the information on this page applies to your scanner, see the tags at the bottom of the page.

- [Set Quick Key](#)
- [Set Startup Key](#)
- [Set Number Tag](#)
- [Set Lockout](#)
- [Set Hold Time](#)

## **Set Quick Key**

Assign this search range to a Quick Key so you can easily enable or disable it during scanning. Enter a number from 0 to 99; tap NO (the decimal point) if you don't want to assign this search range to a Quick Key. (For more information, see [Quick Keys](#).)

## **Set Startup Key**

Assign this search range to a Startup Key so you can lock or unlock it during power up. Enter a number from 0 to 9; tap NO (the decimal point) if you don't want to assign this search range to a Startup Key. (For more information, see [Startup Keys](#).)

## **Set Number Tag**

Assign a number to this search range that you can use to quickly access the first frequency of the the search range. Choose a number from 0 to 999. (For more information, see [Number Tags](#).)

## **Set Lockout**

Decide whether you want to lock out the search so the scanner will ignore it during Scan and Search modes. Choose one of the following options:

- *Unlocked*: The search range is included while scanning.
- *Temporary L/O*: The search range is locked out until you turn the scanner off and

back on.

- *Lockout*: The search range is permanently locked out.

## Set Hold Time

Set how long the scanner spends checking this search range before moving to the next search range or system. (2 seconds is the default).

This page applies to the following scanner(s): [BCD996XT](#) [BCT15X](#) [BCD396XT](#)  
[BC346XT Users Guide](#)



## Set Alert Tone

Choose one of the 9 different tone patterns for the scanner to use for the alert tone:

<b>Alert 1</b>	4000 Hz for 50 ms » Silence for 20 ms » 4000 Hz for 50 ms » Silence for 20 ms » 4000 Hz for 50 ms
<b>Alert 2</b>	800 Hz for 50 ms » Silence for 20 ms » 1050 Hz for 50 ms » Silence for 20 ms » (repeat twice)
<b>Alert 3</b>	800 Hz for 50 ms » Silence for 20 ms » 1050 Hz for 50 ms » Silence for 20 ms » 4000 Hz for 100 ms
<b>Alert 4</b>	120 Hz for 10 ms » 800 Hz for 10 ms » 1200 Hz for 10 ms (repeat 5 times)
<b>Alert 5</b>	1200 Hz for 150 ms
<b>Alert 6</b>	1200 Hz for 70 ms » Silence for 50 ms » 1200 Hz for 70 ms
<b>Alert 7</b>	2000 Hz for 200 ms » Silence for 10 ms » 800 Hz for 150 ms (repeat 3 times)
<b>Alert 8</b>	500 Hz for 40 ms » Silence for 10 ms » 500 Hz for 40 ms » Silence for 10 ms » 500 Hz for 40 ms
<b>Alert 9</b>	2400 Hz for 70 ms » Silence for 20 ms » 3000 Hz for 70 ms » Silence for 70 ms (repeat twice)
<b>Off</b>	No alert tone sounded.

If you select an alert tone, the scanner prompts you to select the volume level ( *Level 1* through *Level 15* ) you want the alert tone to use; leave the volume at *Auto* to have the scanner sound the alert tone without changing the volume.

This page applies to the following scanner(s): [BCD996XT](#) [BCT15X](#) [BCD396XT](#) [BC346XT](#) [Users Guide](#)

# Srch/CloCall Opt

To determine whether the information on this page applies to your scanner, see the tags at the bottom of the page.

This menu lets you set general options for how the scanner operates in Search and Close Call modes.

- [Freq Lockouts](#)
- [Broadcast Screen](#)
  - [Set All Band On](#)
  - [Set All Band Off](#)
  - [Set Each Band](#)
  - [Program Band](#)
- [Tone/Code Search \(BCD396XT and BCD996XT\)](#)
- [CTCSS / DCS Search \(BC346XT and BCT15X\)](#)
- [Repeater Find](#)
- [Max Auto Store](#)
- [Set Delay Time](#)
- [Set Attenuator](#)
- [Set Audio AGC \(BCD996XT and BCD396XT only\)](#)
- [Set Record \(BCD996XT and BCT15X only\)](#)
- [P25 Waiting Time \(BCD396XT and BCD996XT only\)](#)

## Freq Lockouts

- *Rvw Search L/O* : This option displays a list of all locked out frequencies. To unlock any frequency on the list, just select it and press **YES** .
- *Unlock All* : This option removes the locks on all frequencies at once.

## Broadcast Screen

Choose whether you want the scanner to screen out common broadcast bands and ignore hits on these bands. You can screen out signals on 5 preset bands and up to 10 custom

bands. The preset bands are:

- *Pager*
- *FM* (88.1000 - 107.9000 MHz)
- *UHF TV* (470.0000 - 512.0000 MHz)
- *VHF TV* (54.0000 - 72.0000, 76.0000 - 88.0000, and 174.0000 - 216.0000 MHz)
- *NOAA WX* (161.6500, 161.7750, 162.4000, 162.4250, 162.4500, 162.4750, 162.5000, 162.5250, 162.5500, and 163.2750 MHz)

Your options for broadcast screening are listed below:

## **Set All Band On**

Turn on screening for all broadcast bands and ignore any hits on these frequencies.

## **Set All Band Off**

Turn off screening for all broadcast bands, and treat hits on these frequencies the same as any other band.

## **Set Each Band**

Turn screening on or off for each band individually. The scanner displays the bands listed above. Select the band you want to change, then press **YES** to toggle the setting.

## **Program Band**

Create up to 10 custom bands that you want the scanner to screen out hits on.

1. Select a custom band slot (Band 1 through Band 10).
2. When the scanner prompts you, input the lower frequency limit.
3. When the scanner prompts you, input the upper frequency limit.
4. Once you create the custom band, turn screening on or off the same way you did for the preset bands.

## **Tone/Code Search (BCD396XT and BCD996XT)**

Choose whether the scanner searches an active frequency for CTCSS/DCS tones

( *CTCSS/DCS Search*), P25 NAC codes ( *P25 NAC Search*), or neither ( *Off*). (The scanner ignores this setting in AM, WFM, and FMB bands.)

## CTCSS / DCS Search (BC346XT and BCT15X)

Choose whether the scanner searches an active frequency for CTCSS/DCS tones ( *On*) or not ( *Off*). (The scanner ignores this setting in AM, WFM, and FMB bands.)

## Repeater Find

If you turn this feature on, whenever the scanner detects a signal on a common repeater input frequency, it automatically searches for that signal on the output frequency. If it finds the signal on the output frequency, the scanner displays *Repeater Found* and switches to monitor the output frequency.

## Max Auto Store

Enter the maximum number of hits you want the scanner to store during Search and Store mode or Close Call Auto Store mode. When the number of stored hits reaches the number you enter here, the scanner stops storing hits. Enter a number from *1* to *256* .

## Set Delay Time

This setting is used to set the delay time for Quick Search, Close Call, and the CC Hits system.

Set the number of seconds the scanner should wait after a transmission stops before moving on to the next channel. Select *0*, *1*, *2* (default), *5*, *10*, or *30 seconds*.

To have scanner leave the channel after a designated number of seconds whether the transmission stops or not, select one of the negative values. Choose *-10* seconds to have the scanner leave the channel after 10 seconds even if the transmission is still going on; choose *-5 seconds* or *-2 seconds* to have the scanner leave after 5 seconds or 2 seconds, respectively.

## Set Attenuator

Turn on attenuation to reduce the signal strength by 20 dB. When you turn on this

setting, all frequencies in Quick Search mode, Close Call mode, and the Band Scope will be attenuated.

## Set Audio AGC (BCD996XT and BCD396XT only)

Turn on Automatic Gain Control (AGC) for this system. When you activate this feature, the scanner automatically adjusts the volume for each channel based on the signal strength. You can turn on the gain control for *Analog* and *Digital* signals separately.

To change the settings for the audio AGC, see [Adjust Audio AGC](#)

## Set Record (BCD996XT and BCT15X only)

Set this to *On* to have the audio from active frequencies included on the scanners rear RECORD OUT jack.

## P25 Waiting Time (BCD396XT and BCD996XT only)

During search and Close Call operation, it is possible to have *false decode* problems that result in digital noise at the beginning of transmissions. To prevent this, a user-configurable P25 wait time (from 0 to 1000 ms) has been added.

During the wait time, the scanner evaluates the received signal; if it detects P25 data, the scanner opens squelch immediately. If it does not detect any P25 data, the scanner opens squelch as soon as the wait time expires.

Note: Any analog transmissions will lose the first part of the transmission, up to the wait time you set here.

Select the number of milliseconds (after the start of a transmission) the scanner should wait while checking for P25 data. Choose a number from 0 through 1000 ms in 100 ms increments. This setting will be applied in Close Call, Quick Search, and Band Scope modes.

This page applies to the following scanner(s): [BCD996XT](#) [BCD396XT](#) [BCT15X](#)  
[BC346XT Users Guide](#)

# Startup Keys

Startup Keys let you change the lockout state for several systems, sites, and search ranges all at the same time. When you activate the Startup Key, the scanner checks all systems, sites, or search ranges and locks or unlocks them according to these rules:

- If any systems, sites, or search ranges *do not have* a Startup Key assigned, the scanner does not change their locked/unlocked state (i.e., if they are unlocked, it leaves them unlocked).
- If any systems, sites, or search ranges *do have* an assigned Startup Key, the scanner compared the assigned Startup Key to the one you activated:
  - If a system's Startup Key *does not match* the one you activated, the scanner *locks* that system.
  - If a system's Startup Key *matches* the one you activated, the scanner *unlocks* that system and enables all of its Quick Keys.

## Assigning Startup Keys

- Multiple systems, sites, and search ranges can share the same Startup Key.
- Startup Keys range from 0 to 9 .
- If you do not want a system, site, or search range to be affected by any Startup Keys, enter the decimal point for the Startup Key (this is the default setting).

### To a conventional system:

1. Open the [Program System](#) menu.
2. Select the system you want to assign the Startup Key to.
3. Select [Edit Sys Option](#), then select [Set Startup Key](#).
4. Enter the Startup Key you want to use for this system.

### To a trunked system:

1. Open the [Program System](#) menu.
2. Select the system you want to assign the Startup Key to.
3. Select [Edit Site](#), then select the site you want.
4. Select [Set Startup Key](#), then enter the Startup Key you want to use for this site.

**To a service search range :**

1. Open the [Search for...](#) menu.
2. Select [Edit Service](#), then select the service search range you want to assign the Startup Key to.
3. Select [Search with Scan](#), then select [Set Startup Key](#).
4. Enter the Startup Key you want to use for this search range.

**To a custom search range :**

1. Open the [Search for...](#) menu.
2. Select [Edit Custom](#), then select the custom search range you want to assign the Startup Key to.
3. Select [Search with Scan](#), then select [Set Startup Key](#).
4. Enter the Startup Key you want to use for this custom search range.

## Using Startup Keys

To activate a Startup Key:

1. Turn the scanner off.
2. Press & hold the number key that corresponds to the Startup Key while you power the scanner on. (e.g. To activate Startup Key configuration # 2, press & hold **2** on the number pad while turning the scanner on.)
3. Continue holding the number key until the scanner display shows the number of the Startup Key configuration (In the example above, the display shows *Startup Config. Key No. 2* ).

For example, say you have 4 systems programmed according to the table below:

Assigned Startup Key	State
3	Locked
None (.)	Unlocked
None (.)	Locked

9	Unlocked
---	----------

Here is the result if you power on the scanner while you press and hold **3** :

Assigned Startup Key	Previous state	Resulting state
3	Locked	Unlocked
None (.)	Unlocked	Unlocked (no change)
None (.)	Locked	Locked (no change)
9	Unlocked	Locked

Here is the result if you power on the scanner while you press and hold **5** :

Assigned Startup Key	Previous state	Resulting state
3	Locked	Locked
None (.)	Unlocked	Unlocked (no change)
None (.)	Locked	Locked (no change)
9	Unlocked	Locked

This page applies to the following scanner(s): [BCD996XT](#) [BCT15X](#) [BCD396XT](#) [BC346XT](#) [Users Guide](#)



## Tone A and Tone B Settings

You can configure the scanner to search for tones in several different ways, based on the values you enter for Tone A and Tone B:

	<b>Tone A setting</b>	Positive number	<b>Tone B Setting</b>	Positive number
Operation	Monitor the channel for two-tone pages only. The scanner opens squelch and displays the tone information when the following occur: <ol style="list-style-type: none"> <li>1. The scanner detects a tone that matches the value you set for Tone A.</li> <li>2. The tone is at least 250 ms long.</li> <li>3. Within 500 ms, the scanner detects a second tone that matches the value set for Tone B.</li> <li>4. The second tone is at least 100 ms long.</li> </ol>			
	<b>Tone A setting</b>	Positive number	<b>Tone B Setting</b>	0.0 Hz
Operation	Monitor the channel for single-tone pages only. The scanner opens squelch and displays the tone information when the following occur: <ol style="list-style-type: none"> <li>1. The scanner detects a tone that matches the value you set for Tone A.</li> <li>2. The tone is at least 1.25 seconds long and not more than 3.75 seconds long.</li> </ol>			
	<b>Tone A setting</b>	0.0 Hz	<b>Tone B Setting</b>	Positive number

Operation	<p>Monitor the channel for group tones only. The scanner opens squelch and displays the tone information when the following occur:</p> <ol style="list-style-type: none"> <li>1. The scanner detects a tone that matches the value you set for Tone B.</li> <li>2. The tone is at least 3.75 seconds long.</li> </ol>			
	<b>Tone A setting</b>	0.0 Hz	<b>Tone B Setting</b>	0.0 Hz
Operation	<p>Monitor the channel for two-tone pages, single-tone pages, and group tones. This tone out search mode works as follows:</p> <ol style="list-style-type: none"> <li>1. All detected tones are compared to the three criteria listed above.</li> <li>2. If the tone meets any one of the criteria, the scanner checks to see if this tone frequency is already saved to a tone out channel with the same frequency, modulation, and attenuator settings.</li> <li>3. If the detected tone matches a saved tone, the scanner opens squelch.</li> <li>4. If the detected tone does not match any saved tones, the scanner opens squelch, flashes the tone information on the display, and asks if you want to save the tone information.</li> </ol>			

This page applies to the following scanner(s): [BCD996XT](#) [BCT15X](#) [BCD396XT](#) [BC346XT](#) [Users Guide](#)

# Tone-Out for...

To determine whether the information on this page applies to your scanner, see the tags at the bottom of the page.

- [Tone-Out Standby](#)
- [Tone-Out Setup](#)
  - [Edit Name](#)
  - [Set Frequencies](#)
  - [Set Tone](#)
  - [Set Delay Time](#)
  - [Set Alert](#)
    - [Set Alert Tone](#)
    - [Set Alert Light](#)
  - [Set Audio AGC \(BCD396XT and BCD996XT Only\)](#)
  - [Set Record \(BCD996XT and BCT15X Only\)](#)
- [Tone-Out Search](#)

## Tone-Out Standby

Check the tone out channels for paging tones, according to each channel's individual settings.

## Tone-Out Setup

This menu lets you configure the 10 tone-out channels. Select the channel you want to edit from the list, then set the frequency, tone, and other options for that channel.

### Edit Name

Enter a name or edit the existing one. Names can be 16 characters long, and they can contain upper and lower case letters, punctuation, and spaces. Turn the **SELECT-VOLUME-SQUELCH** knob on the handheld scanners or the **SCROLL / FUNCTION** knob on mobile scanners to choose the character you want, then press **6** (right cursor) to move the cursor to the next character.

## [Set Frequencies](#)

Use this menu to program frequencies for this Tone Out channel.

### **Set Tone**

This menu lets you configure the type of tone out search. Select the tone you want to edit (*Edit Tone A* or *Edit Tone B*), then set the frequency for that tone. Enter a frequency between 250 Hz and 3500 Hz, or set the frequency to 0 Hz. (See [Tone A and Tone B Settings](#) for more information.)

### **Set Delay Time**

Set the number of seconds the scanner should wait after a transmission stops before moving on to the next channel. Select *0*, *1*, *2* (default), *5*, *10*, or *30 seconds*. To have the scanner wait for your input before moving on to the next channel, select *Infinite*.

### **Set Alert**

Decide whether the scanner triggers an alert tone and light when it detects a tone on this channel. (Compare this to the system setting [Emergency Alert](#), which triggers a tone and light when a Talk Group contains an emergency flag.) The available options for [Set Alert Tone](#) and [Set Alert Light](#) are common to both types of alerts.

### [Set Alert Tone](#)

### [Set Alert Light](#)

### **Set Audio AGC (BCD396XT and BCD996XT Only)**

Turn on Automatic Gain Control (AGC) for this Tone-Out channel. When you activate this feature, the scanner automatically adjusts the volume for the channel based on the signal strength.

To change the settings for the audio AGC, see [Settings#Adjust Audio AGC](#).

## Set Record (BCD996XT and BCT15X Only)

Turn this setting on to have the audio from received tone-outs included on the rear RECORD OUT jack.

## Tone-Out Search

You can set the scanner to search for and identify the tones used in tone-outs. To do so, you set both the A and B tones to a value of "0". See [Tone A and Tone B Settings](#) for more information.

This page applies to the following scanner(s): [BCD996XT](#) [BCT15X](#) [BCD396XT](#)  
[BC346XTUsers Guide](#)

# Weather mode

Since the 10 NOAA weather channels now cooperate with the FCC and DHS to alert you of other hazards besides weather, it's important to understand how weather mode works:

- Weather channels cannot be locked out.
- The scanner does not run close call checks in the background while monitoring the weather channels.
- *Normal weather scan* treats the weather channels like any other channel: the scanner cycles through the channels, pausing whenever it detects a signal. In normal weather scan, the scanner does not react to alert tones on these channels.
- With a *Weather alert scan*, the scanner checks the weather channels for alert tones and only opens squelch when it detects one. You can program the scanner to filter alerts by region through the Weather Alert menu.
- With a *Weather alert priority scan*, the scanner checks the weather channels every 5 seconds when you are in scan or search mode or close call mode. Weather alert priority scan does not function in the search and store modes ([Search and Store](#) or [Close Call Auto Store](#)), in [Tone Out mode](#), or in [Band Scope mode](#).

## Weather menus

- [BCD396XT and BCD996XT WX Operation](#) menu
- [BC346XT and BCT15X WX Operation](#) menu

This page applies to the following scanner(s): [BCD996XT](#) [BCT15X](#) [BCD396XT](#)  
[BCD346XT Users Guide](#)

To determine whether the information on this page applies to your scanner, see the tags at the bottom of the page.

This menu lets you create channels and edit existing channels. All existing channels are listed in the order they were created: select the channel you want to edit, or select New Channel to create a new one. You can have up to up to 1000 channels in a conventional system and 500 channels in a trunked system.

When you create a new channel, the scanner prompts you to enter the frequency (in a conventional system) or the Talk Group ID (in a trunked system) for the channel: you can edit these at any time through this menu.

- [Edit Frequency \(conventional systems\)](#)
- [Edit Talk Group ID \(trunked systems\)](#)
- [Global channel options](#)
  - [Edit Name](#)
  - [Set Number Tag](#)
  - [Set Priority](#)
  - [Set Alert](#)
  - [Set Record \(BCT15X Only\)](#)
  - [Set Lockout](#)
  - [Volume Offset](#)
  - [Copy Channel](#)
  - [Delete Channel](#)
  - [New Channel](#)
- [Conventional system channel options](#)
  - [Set CTCSS/DCS](#)
  - [Set Modulation](#)
  - [Set Attenuator](#)

## Edit Frequency (conventional systems)

Enter a valid frequency for this band. If the frequency is invalid or if it already exists, the scanner sounds an error tone and prompts you enter the frequency again.

## Edit Talk Group ID (trunked systems)

- [Edit Talk Group ID](#) menu

## Global channel options

You have the following options when editing channels in any system:

### Edit Name

Enter a name or edit the existing one. Names can be 16 characters long, and they can contain upper and lower case letters, punctuation, and spaces. Turn the **SELECT-VOLUME-SQUELCH** knob on the handheld scanners or the **SCROLL / FUNCTION** knob on mobile scanners to choose the character you want, then press **6** (right cursor) to move the cursor to the next character.

### Set Number Tag

Assign a number to this system or channel that you can use to tune directly to a specific channel. Choose a number from 0 to 999. (For more information, see [Number Tags](#).)

### Set Priority

Choose whether this channel should be flagged as a priority channel so the scanner checks it during priority scans and searches.

### Set Alert

This menu lets you configure whether the scanner triggers an alert tone and light whenever this channel or frequency becomes active. (Compare this to the system setting [Emergency Alert](#), which triggers a tone and light when a Talk Group contains an emergency flag.) The available options for [Set Alert Tone](#) and [Set Alert Light](#) are common to both types of alerts.

### Set Record ([BCT15X](#) Only)

This item lets you select whether the channel's audio is output from the RECORD OUT jack on the back of the scanner. Note that you must also set the RECORD --> Marked



Channel System Option to fully enable this function.

## Set Lockout

Decide whether you want to lock out a system, site, or channel so the scanner will ignore it during Scan and Search modes. If you lock out a system or site, all channels within that system or site will be locked out. Choose one of the following options:

- *Unlocked*: The system, site, or channel is not locked out.
- *Temporary L/O*: The system, site or channel is locked out until you turn the scanner off and back on.
- *Lockout*: The system, site, or channel is permanently locked out.

## Volume Offset

The scanner can automatically adjust the volume when it tunes to this channel or frequency. Enter one of the following options:

Softer	No Change	Louder
-3, -2, - 1	0 (default)	+1, +2, +3

## Copy Channel

Copy this channel and all its settings into the buffer. When a channel is stored in the buffer, the scanner adds *Paste Channel* to the bottom of the *Program Channel* menu whenever you are editing a compatible system (that is, a system that is the same type as the one you copied the channel from).

## Delete Channel

Delete this frequency or channel and all associated settings.

## New Channel

Create a new channel.

## Conventional system channel options

You have the following additional options when editing channels in a conventional system:

### Set CTCSS/DCS

(Conventional systems only) Choose one of the following CTCSS/DCS options for this channel:

<b>Off</b>	The scanner ignores all CTCSS and DCS tones and opens squelch on any signal.
<b>Search</b>	The scanner displays any received CTCSS and DCS tones, but it opens squelch on any signal.
<b>CTCSS</b>	The scanner prompts you to enter a CTCSS code; it will only open squelch if the received signal contains a CTCSS tone that matches the one you enter here.
<b>DCS</b>	The scanner prompts you to enter a DCS code; it will only open squelch if the received signal contains a DCS tone that matches the one you enter here.
<b>Set Lockout</b>	The scanner prompts you to enter a CTCSS or DCS code that you want to lockout for this channel. The scanner will not open squelch if the received signal contains a matching CTCSS or DCS tone.

### Set Modulation

Select what type of modulation the scanner should use for this frequency or channel. (Only the modulation types available for this frequency or channel are displayed.)

<b>Auto</b>	The scanner uses the default modulation type for this frequency's band.
<b>AM</b>	The scanner treats the frequency as an AM band.
<b>NFM</b>	The scanner treats the frequency as a Narrowband FM band.
<b>FM</b>	The scanner treats the frequency as an FM band.
<b>WFM</b>	The scanner treats the frequency as a Wideband FM band.

**FMB** The scanner treats the frequency as an FM broadcast band.

## Set Attenuator

Turn on attenuation to reduce the signal strength by 20 dB. You can turn on attenuation for individual frequencies and channels or for entire sites. If you turn on attenuation for a site, all frequencies within that site will be attenuated.

This page applies to the following scanner(s): [BCT15X](#) [BC346XT](#) [Users Guide](#)

# WX Operation

To determine whether the information on this page applies to your scanner, see the tags at the bottom of the page.

This menu lets you configure how the scanner operates in Weather (WX) mode and Weather Alert (WX Alert) mode.

- [Weather Scan](#)
- [Weather Alert](#)
  - [Alert Only](#)
  - [SAME 1 through SAME 5](#)
  - [All FIPS](#)
- [Program SAME](#)
  - [Edit Name \(SAME\)](#)
  - [Edit County](#)
- [Set Delay Time](#)
- [Set Attenuator](#)
- [Set Record \(BCT15 Only\)](#)
- [WX Alt Priority](#)

## Weather Scan

Start a normal weather scan. In normal weather scan mode, the scanner does not react to alert tones on weather channels.

## Weather Alert

Choose how you want the scanner to filter any alerts it detects on the weather channels:

### Alert Only

The scanner responds to all alert tones detected on the weather channels, regardless of region or hazard level. When an alert is detected, the scanner sounds an alert siren and opens squelch on the weather channel.

## **SAME 1 through SAME 5**

Choose one of 5 programmable regions to filter alerts by. The scanner only responds to alerts that affect the selected region you select here, and only if the hazard level is an Advisory, a Watch, or a Warning. When an alert is detected, the scanner sounds an alert siren, displays available information (hazard level, type, etc.) on the screen, and opens squelch on the weather channel.

## **All FIPS**

The scanner responds to alerts regardless of region, but only if the hazard level is an Advisory, a Watch, or a Warning. When an alert is detected, the scanner sounds an alert siren, displays available information (hazard level, type, etc.) on the screen, and opens squelch on the weather channel.

## **Program SAME**

You can pre-program up to 5 regions for filtering hazard alerts, then select one of these regions on the Weather Alert menu. The scanner will only respond to alerts in the selected region.

## **Edit Name (SAME)**

Enter the name you want to use for each region. The default names are SAME 1 through SAME 5.

## **Edit County**

Enter the designated FIPS code for up to 8 counties. To edit a FIPS code, select it from the list. Use the number keypad to enter the 6-digit code, and press YES when you're finished. If you don't enter all 6 digits, the scanner can't store the code and displays it as "-----" on the county list.

(See [Introduction to SAME messages](#) for more information.)

## **Set Delay Time**

Set the number of seconds the scanner should wait after a transmission stops before moving on to the next channel. Select *0*, *1*, *2* (default), *5*, *10*, or *30 seconds*.

To have scanner leave the channel after a designated number of seconds whether the transmission stops or not, select one of the negative values. Choose *-10* seconds to have the scanner leave the channel after 10 seconds even if the transmission is still going on; choose *-5 seconds* or *-2 seconds* to have the scanner leave after 5 seconds or 2 seconds, respectively.

## Set Attenuator

Turn on attenuation to reduce the signal strength by 20 dB. You can turn on attenuation for individual frequencies and channels or for entire sites. If you turn on attenuation for a site, all frequencies within that site will be attenuated.

## Set Record (BCT15 Only)

Turn on this option if you want the weather mode audio to be included on the rear RECORD OUT jack.

## WX Alt Priority

Select *On* if you want the scanner to check the weather channels in the background during Scan, Search, or Close Call mode. The scanner can't run Weather Alert Priority check in Search and Store, Close Call Auto Store, Band Scope, or Tone-Out modes.

This page applies to the following scanner(s): [BCT15X BC346XT Users Guide](#)

## Hold mode











This page applies only to the [BCT15X](#). For other models see:





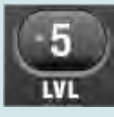
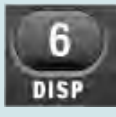



- [BCD396XT and BC346XT Hold Mode](#)
- [BCD996XT Hold Mode](#)

Hold mode lets you edit the current frequency, system, site, or channel. You can access these functions by using the different key operations:



- [Key Operation in Hold Mode](#)
- [Reading the displays in Hold mode](#)
  - [Conventional system display](#)
  - [Trunked system display](#)
  - [Hold on a trunked system control channel](#)
  - [Service search with scan hold display](#)

### Key Operation in Hold Mode

<b>Key Name</b> (2nd operation)				
<b>Action On</b>	<b>DOT / Police/ PRIORITY</b>	<b>1 (Search 1)</b>	<b>2 (Search 2)</b>	<b>3 (Search 3)</b>
Tap	Toggle DOT and Police State-by-State search mode.	Enter the digit in Direct Entry.		
<b>FUNCTION + Tap</b>	Toggle priority mode.	Start the search range assigned to this Search Key.		
<b>Key Name</b> (2nd operation)				
<b>Action on:</b>	<b>BearTracker / Highway Patrol / Alert</b>	<b>4 (IF exchange)</b>	<b>5 (Level offset)</b>	<b>6 (Display mode)</b>
Tap	Toggle the BearTracker Warning System and Highway Patrol State-by-State search mode.	Enter the digit in Direct Entry.		
<b>FUNCTION + Tap</b>	Start scanning in Alert Plus mode.	Toggle the IF for that the current frequency.	Change the volume offset for the current channel.	Change the display mode.
<b>FUNCTION + Press &amp; Hold</b>	NA	NA	NA	NA
<b>Key Name</b> (2nd operation)				
<b>Action on:</b>	<b>GPS / Weather</b>	<b>7 (Attenuation)</b>	<b>8 (Reverse freq.)</b>	<b>9 (Modulation)</b>
Tap	Switch to the GPS Navigation display.	Enter the digit in Direct Entry.		

<b>FUNCTION + Tap</b>	Toggle the Weather Priority mode.	Toggle the attenuator state.	NA	Change the modulation.
<b>FUNCTION + Press &amp; hold</b>	Go to Weather Scan mode.	Toggle the attenuator state for all signals.	If on a channel that has a valid reverse (input) frequency, show the repeater reverse frequency for the current frequency (the scanner returns to the original frequency when you release the key).	NA
<b>Key Name (2nd operation)</b> <b>Action on:</b>	 <b>Menu</b>	 <b>./ No (Decimal)</b>	 <b>0</b>	 <b>Yes (Enter)</b>
Tap	Enter the Menu Mode. If you've entered a system number tag/channel number tag in Direct Entry, go to the specified system and channel.	Enter a decimal point, hyphen, or "i" for Direct Entry.	Enter 0 in Direct Entry.	Go to edit mode for the current channel or, if set to a trunked system frequency go to the edit mode for the system.
<b>FUNCTION + Tap</b>	Enter the Menu for the current system or search range.	NA	NA	NA
<b>Key Name (2nd operation)</b> <b>Action on:</b>	 <b>SQUELCH</b>	 <b>VOLUME</b>	 <b>SCAN/SEARCH</b>	 <b>HOLD/RESUME</b>
Rotate	Adjust Squelch.	Adjust volume. Turn fully counterclockwise past click to turn off scanner.	NA	NA
Tap	Stop an alert tone and temporarily mute alerts. Tap again to unmute.	Change backlight level.	Resume scanning.	Resume scanning.
Press & Hold	Permanently mute alerts. Tap to unmute.	NA	NA	Hold on the current system and resume scanning.
<b>FUNCTION + Tap</b>	Toggle Close Call modes.	Select the state for state-by-state search modes.	Go to the Quick Search prompt.	Resume Scanning.
<b>FUNCTION + Press and Hold</b>	Start Close Call Only mode.	NA	NA	Hold on the current system and resume scanning.

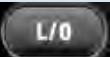

<b>Key Name</b>  <b>(2nd operation)</b>  <b>Action on:</b>	  <b>LOCKOUT</b>	  <b>SCROLL - FUNCTION</b>
Rotate	NA	Scroll through channels.
<b>Function</b> + Rotate	NA	Scroll through systems.
Tap	Temporary lockout the current channel. If the current channel is temporarily or permanently locked out, unlock it.	Activate the FUNCTION mode for the next keypress.
<b>FUNCTION</b> + Tap	Temporarily lockout the current system. If the current system is temporarily or permanently locked out, unlock it.	NA
Double Tap	Permanently lockout the current channel.	NA
<b>FUNCTION</b> + Double Tap	Permanently lockout the current system.	NA
Press & Hold	Unlock all channels in the current system.	"Latch" the FUNCTION mode. Scanner stays on the current system and all keypresses use the FUNCTION mode until you tap the control again.
<b>FUNCTION</b> + Press & Hold	Prompt to <b>Unlock All Systems (Y/N)?</b> If you press <b>E/Yes</b> the scanner unlocks and enables all systems, sites, and searches.	NA

## Reading the displays in Hold mode

The display information in Hold mode varies depending on the type of system the scanner is Holding on.

### Conventional system display

When the scanner is holding on a conventional system, it displays the following screens:



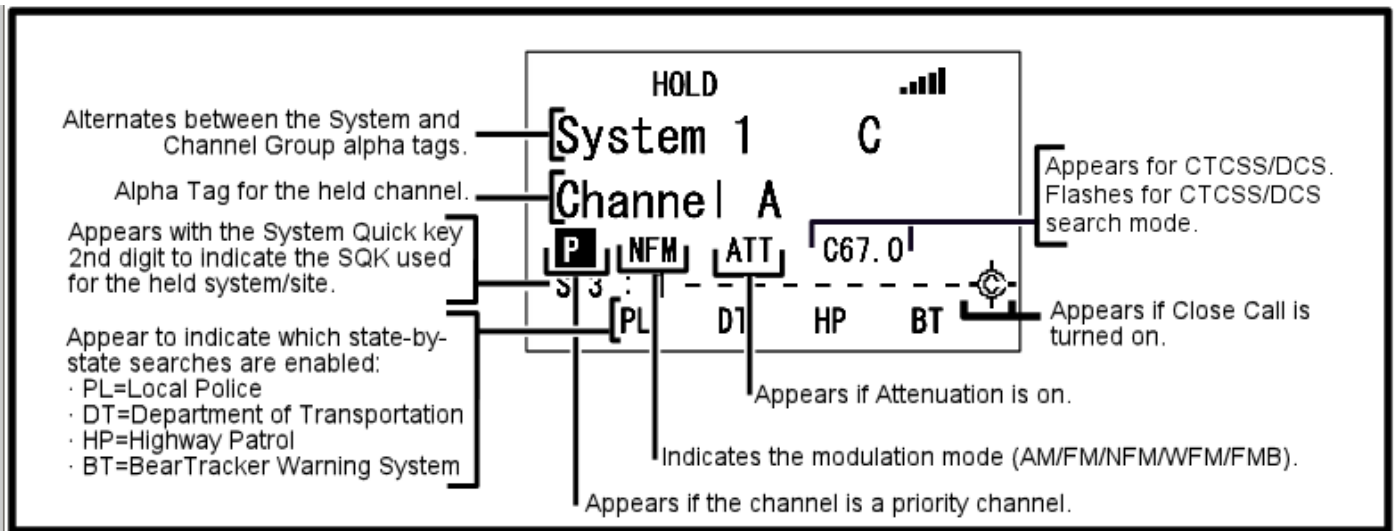

Display Modes 1 and 3

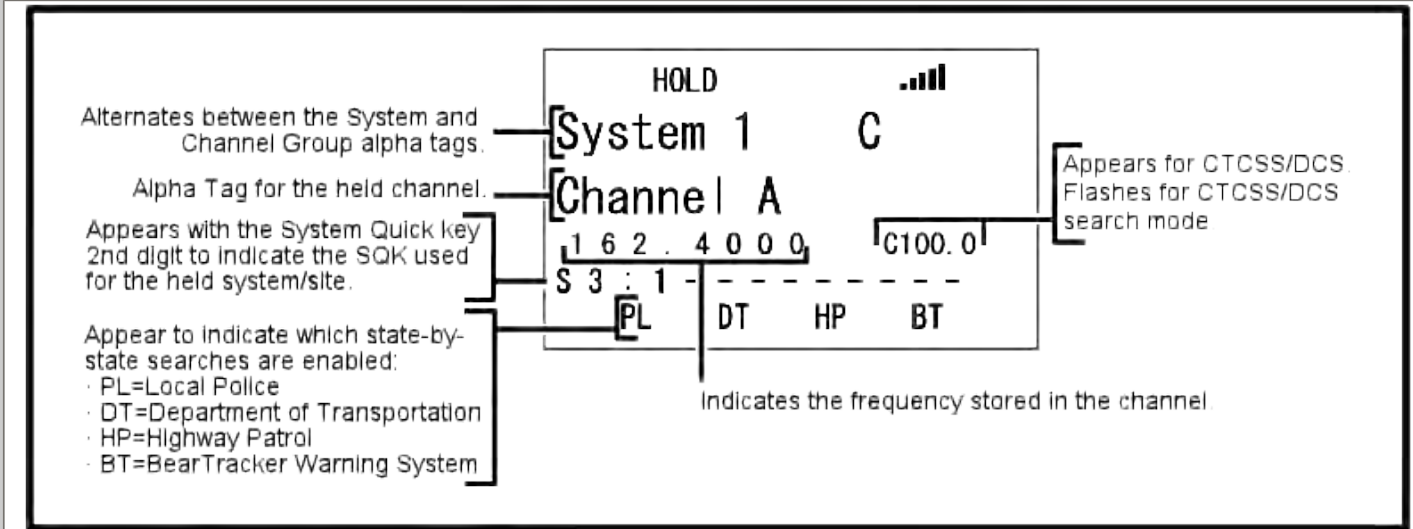

Display Mode 2

- To see the alternate information on the display at the top, cycle through the display modes by pressing **FUNCTION + 6/DISP**.
- To see the display at the bottom of the diagram, tap **FUNCTION**.
- For an explanation of System and Channel Number Tags, see [Number Tags](#).
- For an explanation of the volume offset level, see [Volume Offset](#).

### Trunked system display

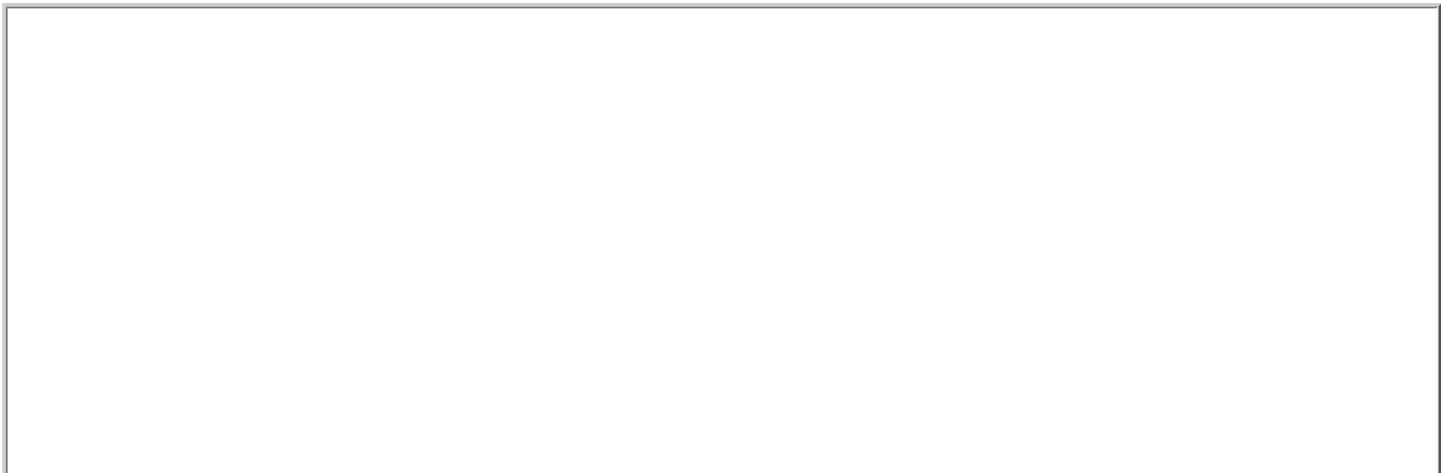

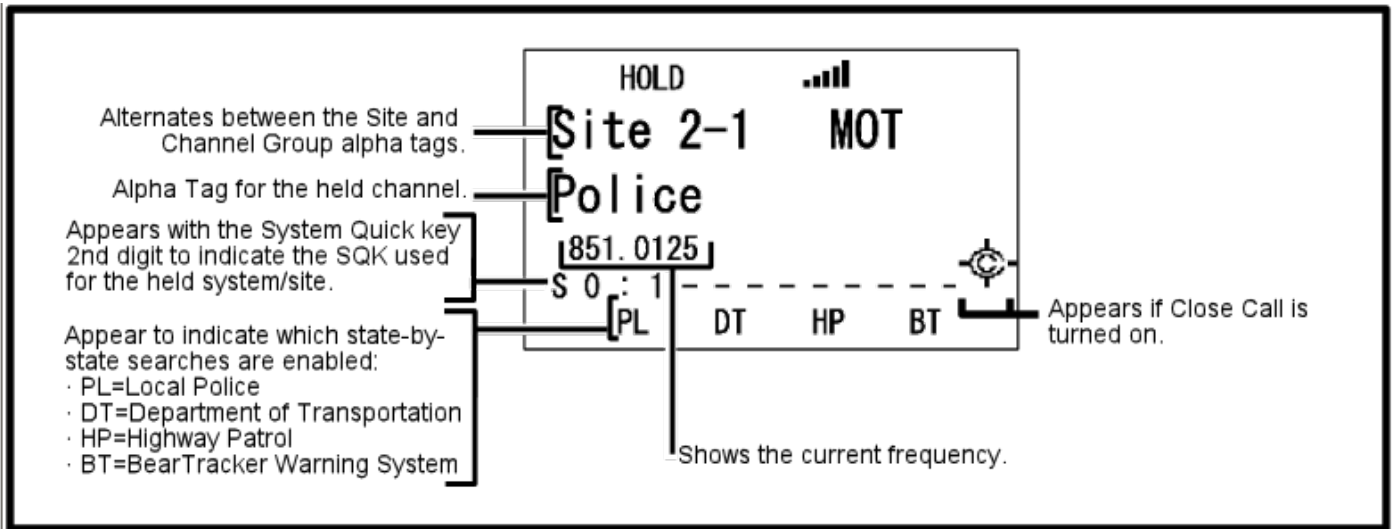

Display Mode 1

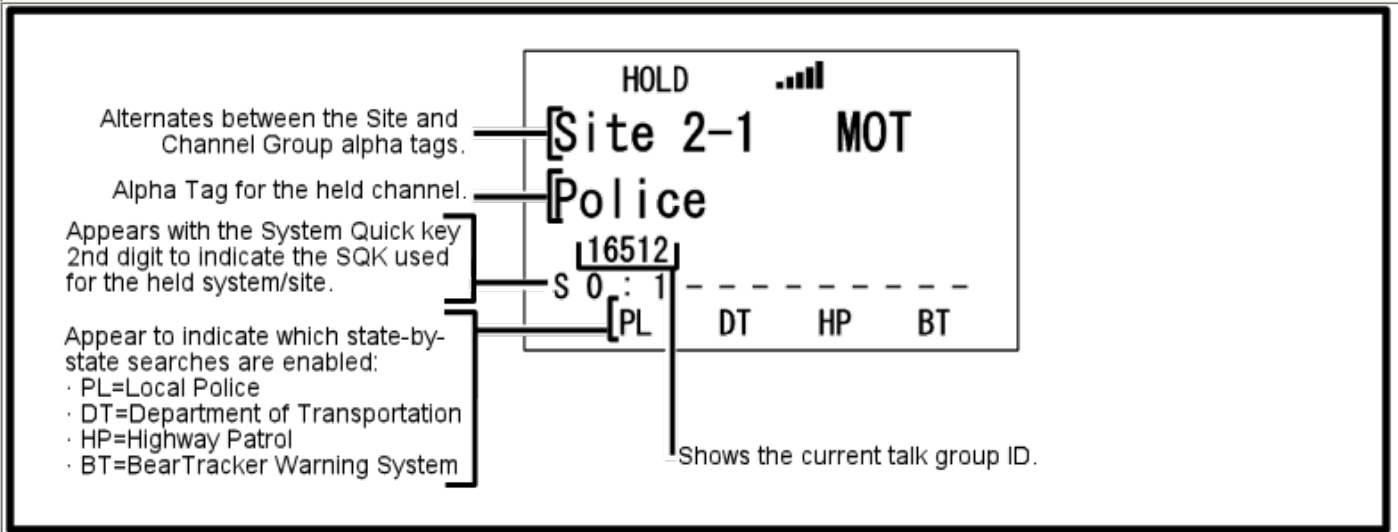

Display Mode 2

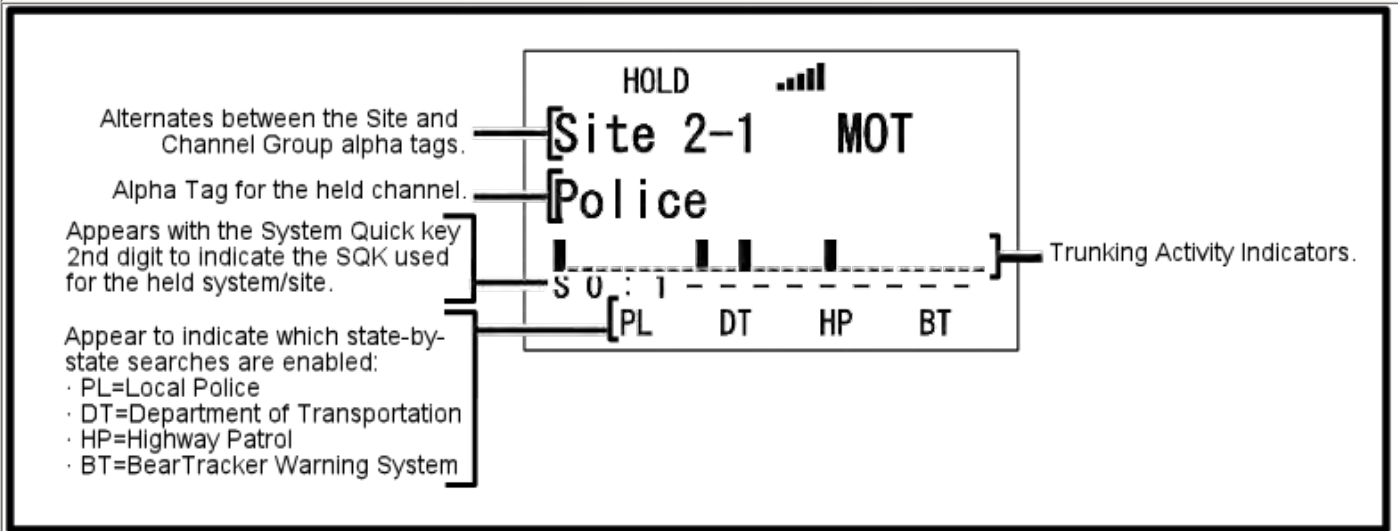

Display Mode 3

### Hold on a trunked system control channel

If you press **HOLD** while the scanner is scanning an idle trunked system, the scanner will hold on the active control channel.

For Motorola systems, the Site name will alternate with the System/Site ID.

As channels become active, their TGID or Channel Alsph Tag will appear.

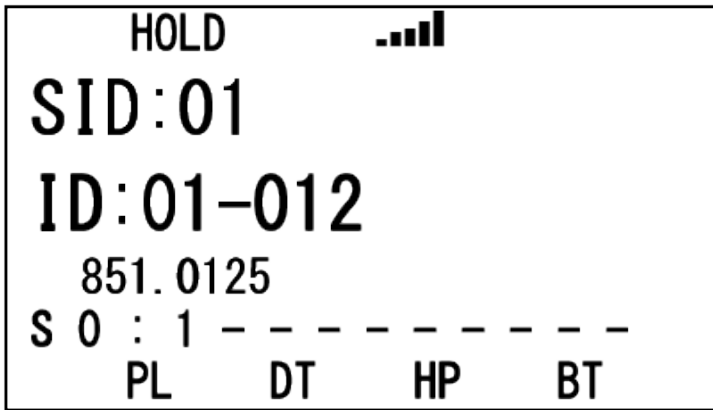

**Service search with scan hold display**

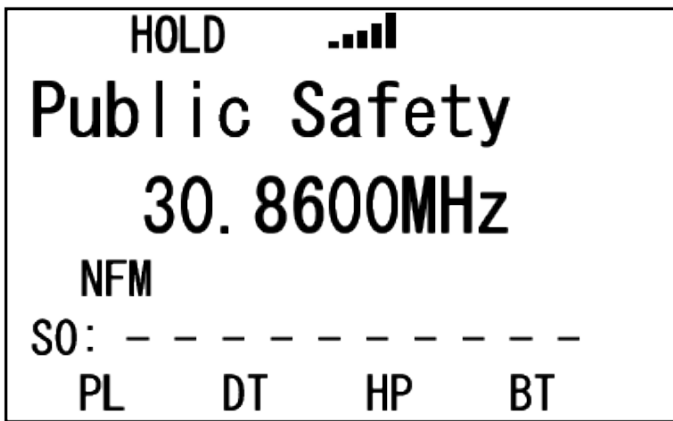

This page applies to the following scanner(s): [BCT15X Users Guide](#)

# Key Safe Mode

This page applies only to the [BCT15X](#). For other models see:





- [BCD396XT and BC346XT Key Safe Mode](#)
- [BCD996XT Key Safe Mode](#)













Key Safe mode locks out the programming menu and more advanced functions so the user can't accidentally "break" the scanner. This mode is ideal for any situation where you want another person to be able to use the scanner without changing any of the settings.





## To turn Key Safe mode on (or off)



- Turn the scanner off.
- Press and hold **FUNCTION** while you turn the scanner back on.
- The scanner display shows *Key Safe Mode On* (or *Key Safe Mode Off*), then returns to the operation it was performing when you turned it off.
- While Key Safe mode is on, **MENU** is disabled along with the key combinations described in the table below.
- When you try to use a disabled key combination, the scanner display shows *Key Safe Mode. Press FUNC while Power On for Full Operation*.

The table below shows which key combinations are disabled and which ones operate normally (depending on the operating mode the scanner is in):

Key Name (2nd operation) Action On	 DOT / Police / PRIORITY	 1 (Search 1)	 2 (Search 2)	 3 (Search 3)
Tap	Normal Operation			
<b>FUNCTION</b> + Tap while holding	Scan mode: Normal Operation Other modes: Disabled	Disabled		
<b>FUNCTION</b> + Tap while scanning	Scan mode: Normal Operation Other modes: Disabled	Normal Operation		

<b>Key Name</b> (2nd operation) <b>Action on:</b>	 <b>Beartracker / Highway Patrol / Alert</b>	 <b>4 (IF exchange)</b>	 <b>5 (Level offset)</b>	 <b>6 (Display mode)</b>
Tap	Normal Operation			
<b>FUNCTION</b> + Tap while holding	Scan mode: Normal Operation Other modes: Disabled	Disabled		Normal Operation
<b>FUNCTION</b> + Tap while scanning	Scan mode: Normal Operation Other modes: Disabled	Normal Operation		
<b>Key Name</b> (2nd operation) <b>Action on:</b>	 <b>GPS / Weather</b>	 <b>7 (Attenuation)</b>	 <b>8 (Reverse freq.)</b>	 <b>9 (Modulation)</b>
Tap	Disabled	Normal Operation		
Press & hold	Disabled	NA		
<b>FUNCTION</b> + Tap while holding	Normal Operation	Disabled	Normal Operation	Disabled
<b>FUNCTION</b> + Tap while scanning	Normal Operation	Normal Operation		
<b>FUNCTION</b> + Press & hold	Disabled	Disabled	Normal Operation	NA
<b>Key Name</b> (2nd operation) <b>Action on:</b>	 <b>Menu</b>	 <b>./ No (Decimal)</b>	 <b>0</b>	 <b>Yes (Enter)</b>
Tap	Disabled	Normal Operation		

FUNCTION + Tap	Disabled	Normal Operation		NA
<b>Key Name</b>  (2nd operation)  <b>Action on:</b>	  <b>SQUELCH</b>	  <b>VOLUME</b>	  <b>SCAN/SEARCH</b>	  <b>HOLD/RESUME</b>
Rotate	Normal Operation		NA	NA
Tap	Normal Operation		In Close Call, Tone-Out, WX, GPS, and Band Scope modes, this key is disabled. In Search mode, this operates as the Resume function.	Normal Operation
Press & Hold	NA	NA	NA	Normal Operation
FUNCTION + Tap	Normal Operation	Disabled	Disabled	Normal Operation
FUNCTION + Press & Hold	Disabled	NA	NA	NA

<b>Key Name</b>  (2nd operation)  <b>Action on:</b>	  <b>LOCKOUT</b>	  <b>SCROLL - FUNCTION</b>
Rotate	NA	Normal Operation

Tap	Normal Operation (temporary lockout only)	Normal Operation
<b>Function</b> + Tap	Normal Operation (temporary lockout only)	NA
Press & Hold	Disabled	Normal Operation

This page applies to the following scanner(s): [BCT15X Users Guide](#)



# Scan mode

This page applies only to the [BCT15X](#). For other models see:

- [BCD396XT and BC346XT Scan Mode](#)
- [BCD996XT Scan Mode](#)
- [Scanning vs. Searching](#)
  - [Scanning trunked systems](#)
  - [Searching trunked systems](#)
  - [State-by-State and Beartracker Warning System](#)
- [Default Scan Mode](#)
- [Locked Items](#)
- [Key operation in Scan mode](#)
  - [Special keys](#)
  - [Keypad controls](#)
- [Key operation in Search mode](#)
  - [Special keys](#)
  - [Keypad controls](#)

## Scanning vs. Searching

Scan and Search mode have very similar operations. In both Scan and Search modes, the scanner steps through a set of frequencies and checks for activity. For Scan mode, you program each individual frequency or Talk Group ID you want the scanner to check; for Search mode, you designate a range of frequencies, and the scanner will check each individual frequency that falls within that range.

With trunked systems, Scan mode and Search mode are very similar, so the scanner can combine the two in a single operation, switching from one to the other depending on the settings of each individual system:

### Scanning trunked systems

- The scanner *scans* a system if the *ID Scan Search* option is set to *ID Scan*
- The scanner only checks for activity on unlocked Talk Group IDs *that are programmed for this system*.
- If any programmed Talk Group ID becomes active, the scanner switches to the voice channel and monitors the transmission until it ends or until the *Delay Time* expires.
- The scanner checks each unlocked Talk Group ID at least once; if the hold time has expired, it moves on to the next system.

### Searching trunked systems

- The scanner *searches* a system if the *ID Scan Search* option is set to *ID Search* .
- When any Talk Group ID becomes active, the scanner checks to see if that ID is locked out.
- If the ID is unlocked, the scanner switches to the voice channel and monitors the transmission until it

ends or until the *Delay Time* expires.

- The scanner monitors the system until the hold time expires, then moves on to the next system.

## State-by-State and Beartracker Warning System

If any of the state-by-state searches are enabled, normal reception will be interrupted periodically (as set by the Set Interval setting in the Priority Scan menu) to search for signals in the enabled searches. The number of channels checked during state-by-state searches is set in the MaxCHs/Pri-Scan setting in the Priority Scan menu. The more channels you have the scanner check during a priority check, the longer the audio dropout during reception of other channels.

If the Beartracker Warning system is enabled, the scanner sounds an alert tone if it detects a transmission on a frequency identified as a short-range frequency commonly used by law enforcement.

## Default Scan Mode

In the default Scan mode, the scanner checks frequencies in the following order:

1. Scans or searches any unlocked systems programmed to system Quick Keys (SQKs) in ascending order starting with the system or site assigned to SQK #1.
  - In the system, the scanner first checks any unlocked groups assigned to group Quick Keys (GQKs) in ascending order starting with the system or site assigned to SQK #1 (through GQK #0).
  - The scanner then checks any remaining unlocked groups in that system in the order in which you created them. If none of the groups in the system have been assigned to GQKs, the scanner checks all unlocked groups in the order in which you created them.
  - The scanner does not check systems if the SQK is disabled off.
  - The scanner does not check groups if the GQK is turned off.
2. Scans any remaining unlocked conventional systems (not assigned to an SQK) in alphabetical order based on the system's Name. (The scanner checks groups within each system as described in step 1.)
3. Checks all unlocked trunked systems (not assigned to an SQK) in alphabetical order based on the system's Name. (The scanner checks groups within each system as described in step 1.)
4. Searches through the designated general service frequencies (Public safety, Military, Air, etc.).
5. Searches through any unlocked frequencies saved in the Custom Search list.
6. Checks any frequencies saved in the Close Call Hits list.

## Locked Items

The scanner does not check locked out items in either scanning or searching:

- A *system* or *site* is considered locked if
  - its SQK is turned off
  - its [Set Lockout](#) field is set to *Locked Out* or *Temporary L/O*
- A *group* is considered locked if
  - the system or site containing it is locked
  - its GQK is turned off
  - its [Set Lockout](#) field is set to *Locked Out* or *Temporary L/O*
- A *channel* or *frequency* is considered locked if









- o the group containing it is locked
- o its [Set Lockout](#) field is set to *Locked Out* or *Temporary L/O*





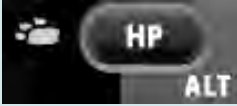







## Key operation in Scan mode

### Special keys



- Turn the **SCROLL** knob to change the direction of the scan.
- While monitoring a channel, rotate the **SCROLL** knob or press **SCAN** to resume scanning.
- **FUNCTION** + turn the **SCROLL** knob to select a system. The scanner starts scanning at the system you select here.
- **FUNCTION** + tap **MENU** to edit the current system.

### Keypad controls

<b>Key Name</b>  (2nd operation)  <b>Action On</b>	  <b>Police / Priority</b>	  <b>1 (Search 1)</b>	  <b>2 (Search 2)</b>	  <b>3 (Search 3)</b>
Tap	Toggle DOT and Police State-by-State search mode.	Disable the systems or sites assigned to this System/Site Quick Key (SQK). Tap again to enable.		
<b>FUNCTION</b> + Tap	Toggle priority modes.	Disable the channel groups in the current system assigned to this Group Quick Key (GQK). Tap again to enable.		
<b>Key Name</b>  (2nd operation)  <b>Action on:</b>	  <b>Highway Patrol / Alert</b>	  <b>4 (IF exchange)</b>	  <b>5 (Level offset)</b>	  <b>6 (Display mode)</b>
Tap	Toggle Highway Patrol / Beartrack Warning System modes.	Disable the systems or sites assigned to this System/Site Quick Key (SQK). Tap again to enable.		
<b>FUNCTION</b> + Tap	Toggle Alert Plus mode.	Disable the channel groups in the current system assigned to this Group Quick Key (GQK). Tap again to enable.		

<b>Key Name</b>  (2nd operation)  <b>Action on:</b>	  GPS / Weather	  7 (Attenuation)	  8 (Reverse freq.)	  9 (Modulation)
Tap	Change to GPS Mode.	Disable the systems or sites assigned to this System/Site Quick Key (SQK). Tap again to enable.		
<b>FUNCTION</b> + Tap	Toggle Weather Priority mode.	Disable the channel groups in the current system assigned to this Group Quick Key (GQK). Tap again to enable.		
<b>FUNCTION</b> + Press & Hold	Start Weather Scan mode.	NA		
<b>Key Name</b>  (2nd operation)  <b>Action on:</b>	  MENU	  . / No	  0	  Yes (Enter)
Tap	Go to the Menu Mode	Start a 2-digit SQK entry. The next two digits will be treated as the SQK. During a system message: Cancel the message and exit that screen.	Disable the systems or sites assigned to System/Site Quick Key 0. Tap again to enable.	If stopped on a channel, edit the current channel.
<b>FUNCTION</b> + Tap	Go to the editing menu for the current system.	Start a 2-digit SQK entry. The next two digits will be treated as the SQK. During a system message: Cancel the message and exit that screen.	Disable or enable the channel groups in the current system assigned to Group Quick Key 0 (GQK 0). Tap again to enable.	If stopped on a channel, edit the current channel.
<b>Key Name</b>  (2nd operation)  <b>Action on:</b>	  SQUELCH	  VOLUME	  SCAN/SEARCH	  HOLD/RESUME

Rotate	Adjust Squelch.	Adjust volume. Turn fully counterclockwise past click to turn off scanner.	NA	NA
Tap	Temporarily stop alert tone. Tap again to restore.	Change backlight level.	Resume scanning (if stopped on a channel).	Hold on the current channel.
Press & Hold	Permanently stop alert tone. Tap again to restore.	NA	NA	Hold on the current system.  If already holding on a system, resume normal scanning.
<b>FUNCTION</b> + Tap	Toggle close call modes.	Select the state to use for state-by-state searches.	When scanning a trunked system, toggle between ID Scan and ID Search mode.  When scanning a conventional system, go to Quick Search mode.	Hold on the current channel.
<b>FUNCTION</b> + Press & hold	Start Close Call Only mode.	NA		

<p><b>Key Name</b></p> <p><b>(2nd operation)</b></p> <p><b>Action on:</b></p>	 <p><b>LOCKOUT</b></p>	 <p><b>SCROLL - FUNCTION</b></p>
---	---	---





Rotate	NA	Change scan direction.  If stopped on a channel, resume scanning.
Tap	If stopped on a channel, temporarily lockout the channel.	Activate the FUNCTION mode for the next keypress.
Double Tap	If stopped on a channel, permanently lockout the channel.	NA
Press & Hold	If stopped on a channel, unlock all channels in the current system.	"Latch" the FUNCTION mode. Scanner stays on the current system and all keypresses use the FUNCTION mode until you tap the control again.
<b>FUNCTION</b> + Tap	Temporarily lockout the current system.	NA
<b>FUNCTION</b> + Double Tap	Permanently lockout the current system.	NA
<b>FUNCTION</b> + Press & Hold	Unlock all items, regardless of type.	NA





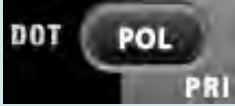





## Key operation in Search mode





### Special keys

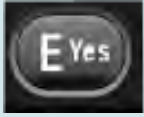

- Turn the **SCROLL** knob to change the direction of the search.
- While monitoring a channel, rotate the **SCROLL** knob to resume searching.
- In Custom Search mode, **FUNCTION** + turn the **SCROLL** knob to select a custom search range. The scanner starts at the custom search range you select here.
- **FUNCTION**+ tap **MENU** to go to the *Search for...* menu.
- During a Quick Search, **FUNCTION**+ tap **MENU** to go to the *Srch/CloCall Opt* menu.

### Keypad controls

<b>Key Name</b>  (2nd operation)  <b>Action On</b>	  Police / Priority	  1 (Search 1)	  2 (Search 2)	  3 (Search 3)
Tap	Go to scan mode	Disable the custom search range assigned to this key. Tap again to enable.		
<b>FUNCTION</b> + Tap	NA	Start the search range assigned to this Search Key.		

<b>Key Name</b> (2nd operation) <b>Action on:</b>	 <b>Highway Patrol / Alert</b>	 <b>4 (IF exchange)</b>	 <b>5 (Level offset)</b>	 <b>6 (Display mode)</b>
Tap	Go to scan mode.	Disable the custom search range assigned to this key. Tap again to enable.		
<b>FUNCTION</b> + Tap	Go to Alert Plus scanning.	When monitoring a frequency, toggle the IF for that frequency.	NA	Switch the display mode.
<b>Key Name</b> (2nd operation) <b>Action on:</b>	 <b>GPS / Weather</b>	 <b>7 (Attenuation)</b>	 <b>8 (Reverse freq.)</b>	 <b>9 (Modulation)</b>
Tap	Switch to the GPS Navigation display.	Disable the custom search range assigned to this key. Tap again to enable.		
<b>FUNCTION</b> + Tap	Toggle Weather Priority mode.	Toggle the attenuator state.	NA	Change the modulation.
<b>FUNCTION</b> + Press & hold	Go to Weather Scan mode.	Toggle the attenuator state for all signals.	If stopped on a frequency that has a valid reverse (input) frequency, show the repeater reverse frequency for the current frequency (the scanner returns to the original frequency when you release the key).	NA
<b>Key Name</b> (2nd operation) <b>Action on:</b>	 <b>Menu</b>	 <b>./ No (Decimal)</b>	 <b>0</b>	 <b>Yes (Enter)</b>
Tap	Enter the Menu Mode.	NA	Disable the search range assigned to this key. Tap again to enable.	If stopped on a frequency, store the current frequency.

<b>FUNCTION</b> + Tap	Enter the "Search for..." Menu.	NA	NA	If stopped on a frequency, store the current frequency.
<b>Key Name</b>  (2nd operation)  <b>Action on:</b>	  <b>SQUELCH</b>	  <b>VOLUME</b>	  <b>SCAN/SEARCH</b>	  <b>HOLD/RESUME</b>
Rotate	Adjust Squelch.	Adjust volume. Turn fully counterclockwise past click to turn off scanner.	NA	NA
Tap	Temporarily mute alerts. Tap again to restore.	Change backlight level.	Go to Scan mode.	Hold on the current frequency.
Press & Hold	Permanently mute alerts. Tap again to restore.	NA	NA	NA
<b>FUNCTION</b> + Tap	Toggle Close Call modes.	Change the state for state-by-state searches.	Resume Searching.	Hold on the current frequency.
<b>FUNDTION</b> + Press & hold	Go to Close Call Only mode.	NA		

<b>Key Name</b>  (2nd operation)  <b>Action on:</b>	  <b>LOCKOUT</b>	  <b>SCROLL - FUNCTION</b>
---	---	--



Rotate	NA	Change search direction.  If stopped on a frequency, resume searching.
Tap	If stopped on a frequency, temporarily lockout the frequency.	Activate the FUNCTION mode for the next keypress.
Double Tap	If stopped on a frequency, permanently lockout the frequency.	NA
<b>FUNCTION</b> + Tap	Review the list of locked out frequencies.	NA
Press & Hold	If stopped on a frequency, unlock all search frequencies.	"Latch" the FUNCTION mode. Scanner stays on the current system and all keypresses use the FUNCTION mode until you tap the control again.

This page applies to the following scanner(s): [BCT15X Users Guide](#)

# BCT15X Settings

This page applies only to the [BCT15X](#). For other models see:

- [BCD996XT Settings](#)
- [BCD396XT and BC346XT Settings](#)
  
- [Set Backlight](#)
  - [Set Dimmer](#)
    - [Auto: Select Polarity](#)
    - [Manual](#)
- [Adjust Key Beep](#)
- [Set Upside-down](#)
- [Adjust Contrast](#)
- [Set C-CH Output](#)
- [Set GPS Format](#)
  - [Set Pos Format](#)
  - [Set Time Format](#)
  - [Set Time Zone](#)
  - [Set Unit](#)
- [Set Serial Port](#)
- [Band Defaults](#)
  - [Set Modulation](#)
  - [Set Step](#)
- [See Scanner Info](#)
  - [% Memory Used](#)
  - [Firmware Version](#)

## Set Backlight

This menu lets you configure the display and key backlight.

## Set Dimmer

Selects whether the backlight brightness is set automatically or manually.

### Auto: Select Polarity

+ Polarity	The backlight dims when +12V is applied to the orange lead.
- Polarity	The backlight dims when +12V is not being applied to the orange lead.

### Manual

Manually select the brightness of the backlight. Your options are high (brightest), middle, and low (dimmiest).

### Adjust Key Beep

Select the volume level (Level 1 through Level 15) you want the keybeep to use, or select *Auto* to have the scanner sound the keybeep without changing the volume. If you don't want the scanner to beep when you press the keys, select *Off*.

### Set Upside-down

Lets you invert the display. Useful if you are mounting the scanner in an overhead space.

### Adjust Contrast

Select one of the 15 available contrast levels for the display. As you scroll through the options, the display adjusts to the highlighted contrast level; press **YES** when you see the display contrast you want to use.

### Set C-CH Output

Choose how you want the scanner to handle control channel data:

- *Off*: The scanner will not output the control channel data.
- *On*: The scanner will output the control channel data.
- *Extend*: The scanner will output the control channel data along with any

description.

## Set GPS Format

Configure how the scanner displays position coordinates, time, and units during GPS operation:

### Set Pos Format

Select how the scanner displays longitude and latitude:

- *DMS: DDD° MM' SS.ss* : Display coordinates in degrees (DDD), minutes (MM), and seconds (SS.ss).
- *DEG: DDD.ddddd* : Display coordinates as decimal degrees.

### Set Time Format

Select 12H for 12-hour (am/pm) time format or 24H for 24-hour time format.

### Set Time Zone

Set the number of hours your local time zone differs from universal time (GMT/UTC). Select from -14 hours to +14 hours in half-hour (0.5 h) increments.

### Set Unit

Select the unit used for distance: mile or kilometer (km).

## Set Serial Port

Select the port you are adjusting ( **Set Front Port** or **Set Rear Port**) Then, set the baud rate for the selected serial port. Choose from *4800, 9600, 19200, 38400, 57600* , or *115200* bps; select *Off* to disable the serial port.

The front port defaults to 115200 bps. The rear port defaults to 4800 bps to maintain compatibility with GPS units.

## Band Defaults

Use this menu to change the default modulation and frequency step or spacing used for each band. The scanner displays the list of available bands in the following format:

{Frequency} : {modulation type} / {step}

Select the frequency band you want to edit. The scanner prompts you for the following information:

### Set Modulation

Select the type of modulation you want the scanner to use as the default for this band: AM, Narrowband FM (NFM), FM, Wideband FM (WFM), or FM broadcast (FMB).

### Set Step

Select the number of kHz between each frequency or channel step: 5.0, 6.25, 7.5, 8.33, 10.0, 12.5, 15.0, 20.0, 25.0, 50.0, or 100.0 kHz.

## See Scanner Info

This menu lets you see detailed information about the memory and firmware, including the ESN and ESN Checksum.

### % Memory Used

See the percent of overall memory used ( *Memory Used*) along with the number of programmed *Systems*, *Sites* , and channels ( *CHN*) and the percent of available memory positions used for each.

### Firmware Version

See the firmware version ( *Version*), the electronic serial number ( *ESN*), checksum ( *SUM*), and major firmware version number ( *M-Ver*) of the scanner.

This page applies to the following scanner(s): [BCT15X Users Guide](#)

# Set Bear Tracker

To determine whether the information on this page applies to your scanner, see the tags at the bottom of the page.

The menu items under Set Bear Tracker affect how the Beartracker Warning System operates. The Bear Tracker Warning system is turned on by repeatedly pressing HP/ALT until BT appears in the bottom row of the display.

When Bear Tracker Warning System is turned on the scanner will check the Bear Tracker state-by-state frequencies every 2 seconds. You will hear a brief break in transmissions when the scanner makes the check. You select the state to use by **FUNCTION** + Tap Volume, then rotate the scroll control to select your state. These frequencies are frequencies typically used by Highway Patrol, State Police, State Patrol, and Air Patrol that are typically receivable from short ranges (<2 miles). If the scanner detects a transmission in Bear Tracker mode, it sounds an alert to let you know of nearby law enforcement activities.

- [Set Hold Time](#)
- [Set Delay Time](#)
- [Set Alert](#)
  - [Set Alert Tone](#)
  - [Set Alert Light](#)
- [Set Record](#)

## Set Hold Time

This sets how long the scanner checks for BearTracker alerts before returning to programmed scanning.

## Set Delay Time

This sets how long the scanner stays on a frequency after a transmission ends before resuming scanning.

## Set Alert

This sets the alert tone and light for BearTracker Warning System alerts.

### Set Alert Tone

First, select the alert pattern to sound. As you scroll through options, the scanner sounds the selected tone. Press **E** to make your selection. The scanner then prompts you to select the tone level. As you scroll through options, the scanner sounds at the selected volume level. If you select *AUTO*, the alert level will match the volume control setting. Press **E** to make your selection. The scanner returns to the *Set Alert Tone* menu.

### Set Alert Light

First, select the alert flash speed. As you scroll through options, the scanner flashes at the selected speed. Press **E** to make your selection. The scanner returns to the *Set Alert Tone* menu.

## Set Record

Sets the scanner to send the BearTracker alerts audio out the RECORD OUT jack on the back of the scanner.

This page applies to the following scanner(s): [BCT15X Users Guide](#)



To determine whether the information on this page applies to your scanner, see the tags at the bottom of the page.

The *Program System* menu lets you create systems and edit existing systems. All existing systems are listed in the order they were created: select the system you want to edit, or select *New System* to create a new one.

When you create a new system, the scanner prompts you to select a system type; the system type you select controls what options are available for the system setup. You can't change a system type once the system is created: if you need to change the system type, delete the system and create it all over again as a new system.

The *System Type* options are:

- *MOT* : Use for any Motorola system.
- *EDCS* : Use for any EDACs system. When you select this system type, the scanner prompts you to choose *WIDE/NARROW* or *SCAT* .
- *LT* : Use for any LTR system.
- *Conventional* : Use for any non-trunked system.

**REMEMBER: Once you select a system type, you can't change it!**

- [Edit Name](#)
- [Edit Sys Option](#)
- [Edit Site](#)
- [Edit Group](#)
- [Copy System](#)
- [Delete System](#)
- [New System](#)

## Edit Name

Enter a name or edit the existing one. Names can be 16 characters long, and they can contain upper and lower case letters, punctuation, and spaces. Turn the **SELECT-VOLUME-SQUELCH** knob on the handheld scanners or the **SCROLL / FUNCTION** knob on mobile scanners to choose the character you want, then press **6** (right cursor) to move the cursor to the next character.

## Edit Sys Option

This menu lets you set the options for each system.

## Edit Site

(trunked systems only) This menu lets you create sites and edit existing sites. All existing sites are listed in the order they were created: select the site you want to edit, or select New Site to create a new one.

## Edit Group

This menu lets you create groups and edit existing groups. All existing groups are listed in group quick key order: select the group you want to edit, or select New Group to create a new one. You can have up to 20 groups in each system.

## **Copy System**

Make a copy of this system and all its settings including all sites, groups, channels, and frequencies. The scanner prompts you to enter a new system name.

## **Delete System**

Delete this system and all its settings; this includes sites, groups, channels, and frequencies.

## **New System**

Create a new system.

This page applies to the following scanner(s): [BCT15X BC346XT Users Guide](#)

## Monocolor backlights

The following scanners have only one backlight color

- [BC346XT](#)
- [BCT15X](#)

For these scanners, decide whether it triggers a light when the alert condition occurs. Choose the flash pattern (steady *On*, *Slow Blink*, or *Fast Blink*) you want the scanner to use for the alert light. Leave this option at *Off* if you don't want the scanner to flash an alert light.

## Multicolor backlights

The following scanners have 7 different backlight colors (blue, red, magenta, green, cyan, yellow, or white)

- [BCD396XT](#)
- [BCD996XT](#)

For these scanners, choose one of backlight colors for the scanner to use for the alert light. Leave this option at *Off* if you don't want the scanner to flash an alert light.

If you select a light color, the scanner prompts you to select the flash pattern (steady *On*, *Slow Blink*, or *Fast Blink*) you want to the alert light to use.

On channels that contain a mix of analog and digital signals (i.e., where the *Audio Mode* is set to *All*), it is possible to have *false decode* problems caused by digital noise at the beginning of transmissions. To prevent this, a user-configurable P25 wait time (from 0 to 1000 ms) has been added.

During the wait time, the scanner evaluates the received signal; if it detects P25 data, the scanner opens squelch immediately. If it does not detect any P25 data, the scanner opens squelch as soon as the wait time expires.

Note: Any analog transmissions on this channel will lose the first part of the transmission, up to the wait time you set here.

Select the number of milliseconds (after the start of a transmission) the scanner should wait while checking for P25 data. Choose a number from 0 through 1000 ms in 100 ms increments. The scanner only applies the wait time setting to Conventional or Motorola (non P25) systems, and only when the channel's *Audio Mode* setting is *All*.

Decide whether you want to lock out a system, site, or channel so the scanner will ignore it during Scan and Search modes. If you lock out a system or site, all channels within that system or site will be locked out. Choose one of the following options:

- *Unlocked*: The system, site, or channel is not locked out.
- *Temporary L/O*: The system, site or channel is locked out until you turn the scanner off and back on.
- *Lockout*: The system, site, or channel is permanently locked out.

**CEA Specific Area Message Encoding (SAME) Event Codes**

<b>Received Code</b>	<b>Event Name</b>	<b>Event Level</b>	<b>Short Name (Scanner Display)</b>
ADR	Administrative Message	Advisory	Admin Message
AVA	Avalanche Watch	Watch	Avalanche
AVW	Avalanche Warning	Warning	Avalanche
BHW	Biological Hazard Warning	Warning	Biological
BWW	Boil Water Warning	Warning	Boil Water
BZW	Blizzard Warning	Warning	Blizzard
CAE	Child Abduction Emergency	Advisory	Child Emergency
CDW	Civil Danger Warning	Warning	Civil Danger
CEM	Civil Emergency Message	Warning	Civil Emergency
CFA	Coastal Flood Watch	Watch	Coastal Flood
CFW	Coastal Flood Warning	Warning	Coastal Flood
CHW	Chemical Hazard Warning	Warning	Chemical Hazard
CWW	Contaminated Water Warning	Warning	Contam. Water
DBA	Dam Watch	Watch	Dam Break
DBW	Dam Break Warning	Warning	Dam Break
DEW	Contagious Disease Warning	Warning	Contagious
DMO	Practice/demo	Advisory	System Demo
DSW	Dust Storm Warning	Warning	Dust Storm
EAN	Emergency Action Notification	Warning	EMG Notify
EAT	Emergency Action Termination	Advisory	EMG End
EQW	Earthquake Warning	Warning	Earthquake
EVA	Evacuation Watch	Watch	Evacuate Note
EVI	Immediate Evacuation	Warning	Evacuate Note
FCW	Food Contamination Warning	Warning	Food
FFA	Flash Flood Watch	Watch	Flash Flood
FFS	Flash Flood Statement	Advisory	Flash Flood
FFW	Flash Flood Warning	Warning	Flash Flood
FLA	Flood Watch	Watch	Flood
FLS	Flood Statement	Advisory	Flood
FLW	Flood Warning	Warning	Flood
FRW	Fire Warning	Warning	Fire
FSW	Flash Freeze Warning	Warning	Flash Freeze
FZW	Freeze Warning	Warning	Freeze
HLS	Hurricane Statement	Advisory	Hurricane
HMW	Hazardous Material Warning	Warning	Hazardous
HUW	Hurricane Watch	Watch	Hurricane
HWA	High Wind Watch	Watch	High Wind
HWW	High Wind Warning	Warning	High Wind
IBW	Iceberg Warning	Warning	Iceberg
IFW	Industrial Fire Warning	Warning	Industrial Fire

Received Code	Event Name	Event Level	Short Name (Scanner Display)
LAE	Local Area Emergency	Advisory	Local EMG
LEW	Law Enforcement Warning	Warning	Law Enforcement
LSW	Land Slide Warning	Warning	Land Slide
NAT	National Audible Test	Advisory	National Audible
NIC	National Information Center	Advisory	National Info
NMN	Network Notification Message	Advisory	Network Message
NPT	National Periodic Test	Advisory	Nation Periodic
NST	National Silent Test	Advisory	Nation Silent
NUW	Nuclear Power Plant Warning	Warning	Nuclear Plant
POS	Power Outage Advisory	Advisory	Power Outage
RHW	Radiological Hazard	Warning	Radiological
RMT	Required Monthly Test	Advisory	Monthly
RWT	Required Weekly Test	Advisory	Weekly
SMW	Special Marine Warning	Warning	Special Marine
SPS	Special Weather Statement	Advisory	Special WX
SPW	Shelter In-place Warning	Warning	Shelter
SVA	Severe Thunderstorm Watch	Watch	Thunderstorm
SVR	Severe Thunderstorm Warning	Warning	Thunderstorm
SVS	Severe Weather Statement	Advisory	Severe WX
TOA	Tornado Watch	Watch	Tornado
TOE	911 Telephone Outage Emergency	Advisory	911 Phone Outage
TOR	Tornado Warning	Warning	Tornado
TRA	Tropical Storm Watch	Watch	Tropic Storm
TRW	Tropical Storm Warning	Warning	Tropic Storm
TSA	Tsunami Watch	Watch	Tsunami
TSW	Tsunami Warning	Warning	Tsunami
TXB	Transmitter Backup On	Advisory	TX Backup On
TXF	Transmitter Carrier Off	Advisory	TX Carrier Off
TXO	Transmitter Carrier On	Advisory	TX Carrier On
TXP	Transmitter Primary On	Advisory	TX Primary On
VOW	Volcano Warning	Warning	Volcano
WFA	Wild Fire Watch	Watch	Wild Fire
WFW	Wild Fire Warning	Warning	Wild Fire
WSA	Winter Storm Watch	Watch	Winter Storm
WSW	Winter Storm Warning	Warning	Winter Storm
* * A	Unrecognized Watch	Watch	Unrecognized
* * E	Unrecognized Emergency	Advisory	Unrecognized
* * S	Unrecognized Statement	Advisory	Unrecognized
* * W	Unrecognized Warning	Warning	Unrecognized

Assign this system or site to a Startup Key so you can lock or unlock it during power up. Enter a number from 0 to 9; tap NO (the decimal point) if you don't want to assign this system or site to a Startup Key. (For more information, see [Startup Keys](#).)