





TEST REPORT

KCTL Inc. 65, Sinwon-ro, Yeongtong-gu, Suwon-si, Gyeonggi-do, 16677, Korea Tel: 82-31-285-0894 Fax: 82-505-299-8311 www.kctl.co.kr	Report No.: KR21-SEF0143 Page (1) of (18)	
<p>1. Client</p> <ul style="list-style-type: none"> ◦ Name : Uniden America Corporation ◦ Address : 6225 N. State highway 161, Suite 300, Irving Texas 75038 ◦ Date of Receipt : 2021-09-10 <p>2. Use of Report : -</p> <p>3. Name of Product / Model : RADAR DETECTOR / R3</p> <p>4. Manufacturer / Country of Origin : ATTOWAVE Co., Ltd. / Korea</p> <p>5. Date of Test : 2021-09-13 to 2021-09-14</p> <p>6. Location of Test : <input checked="" type="checkbox"/> Permanent Testing Lab <input type="checkbox"/> On Site Testing (Address: 65, Sinwon-ro, Yeongtong-gu, Suwon-si, Gyeonggi-do, 16677, Korea)</p> <p>7. Test method used : ANSI C63.4:2014, Class B</p> <p>8. FCC ID : AMWUA1702</p> <p>9. Test Results : Refer to the test result in the test report</p>		
Affirmation	Tested by  Name : Byunghwan Min (Signature)	Technical Manager  Name : Gunsu Park (Signature)
2021-09-30		
<h2>KCTL Inc.</h2>		
<p>As a test result of the sample which was submitted from the client, this report does not guarantee the whole product quality. This test report should not be used and copied without a written agreement by KCTL Inc.</p>		

REPORT REVISION HISTORY

Date	Revision	Page No
2021-09-30	Originally issued	-

This report shall not be reproduced except in full, without the written approval of KCTL Inc. This document may be altered or revised by KCTL Inc. personnel only, and shall be noted in the revision section of the document. Any alteration of this document not carried out by KCTL Inc. will constitute fraud and shall nullify the document. This test report is a general report that does not use the KOLAS accreditation mark and is not related to KS Q ISO/IEC 17025 and KOLAS accreditation.

General remarks for test reports

Statement concerning the uncertainty of the measurement systems used for the tests

(may be required by the product standard or client)

Internal procedure used for type testing through which traceability of the measuring uncertainty has been established:

Procedure number, issue date and title:

Calculations leading to the reported values are on file with the testing laboratory that conducted the testing.

Statement not required by the standard or client used for type testing

Contents

1. Applicant information	4
2. Laboratory information	5
3. Test system configuration	6
3.1 Operation environment.....	6
3.2 Measurement Uncertainty	7
4. Description of EUT	9
4.1 General information.....	9
4.2 Product description.....	10
4.3 Auxiliary equipments	10
4.4 Test configuration	11
4.5 Operating conditions	11
5. Summary of test results	12
5.1 Summary of EMI emission test results	12
6. Test results	13
6.1 Conducted Emissions.....	13
6.2 Radiated Emission	16

KCTL Inc.

65, Sinwon-ro, Yeongtong-gu,
Suwon-si, Gyeonggi-do, 16677, Korea
Tel: 82-31-285-0894 Fax: 82-505-299-8311
www.kctl.co.kr

Report No.:
KR21-SEF0143
Page (4) of (18)



1. Applicant information

Applicant: Uniden America Corporation
Address: 6225 N. State highway 161, Suite 300, Irving Texas 75038

Manufacturer: ATTOWAVE Co., Ltd.
Address: 1005, 10F Leader's Tower, 60-15 Gasan-dong, Gumchun-gu,
Seoul, 153-801 Korea

KCTL Inc.

65, Sinwon-ro, Yeongtong-gu,
Suwon-si, Gyeonggi-do, 16677, Korea
Tel: 82-31-285-0894 Fax: 82-505-299-8311
www.kctl.co.kr

Report No.:
KR21-SEF0143
Page (5) of (18)

KCTL

2. Laboratory information

Address

KCTL Inc. (Suwon Lab.)

65, Sinwon-ro, Yeongtong-gu, Suwon-si, Gyeonggi-do, 16677, Korea

Telephone Number: 82 31 285 0894

Facsimile Number: 82 505 299 8311

FCC Site Designation No: KR0040

VCCI Registration No.: R-20080, G-20078, C-20059, T-20056

Industry Canada Registration No. : 8035A

KOLAS NO.: KT231

SITE MAP

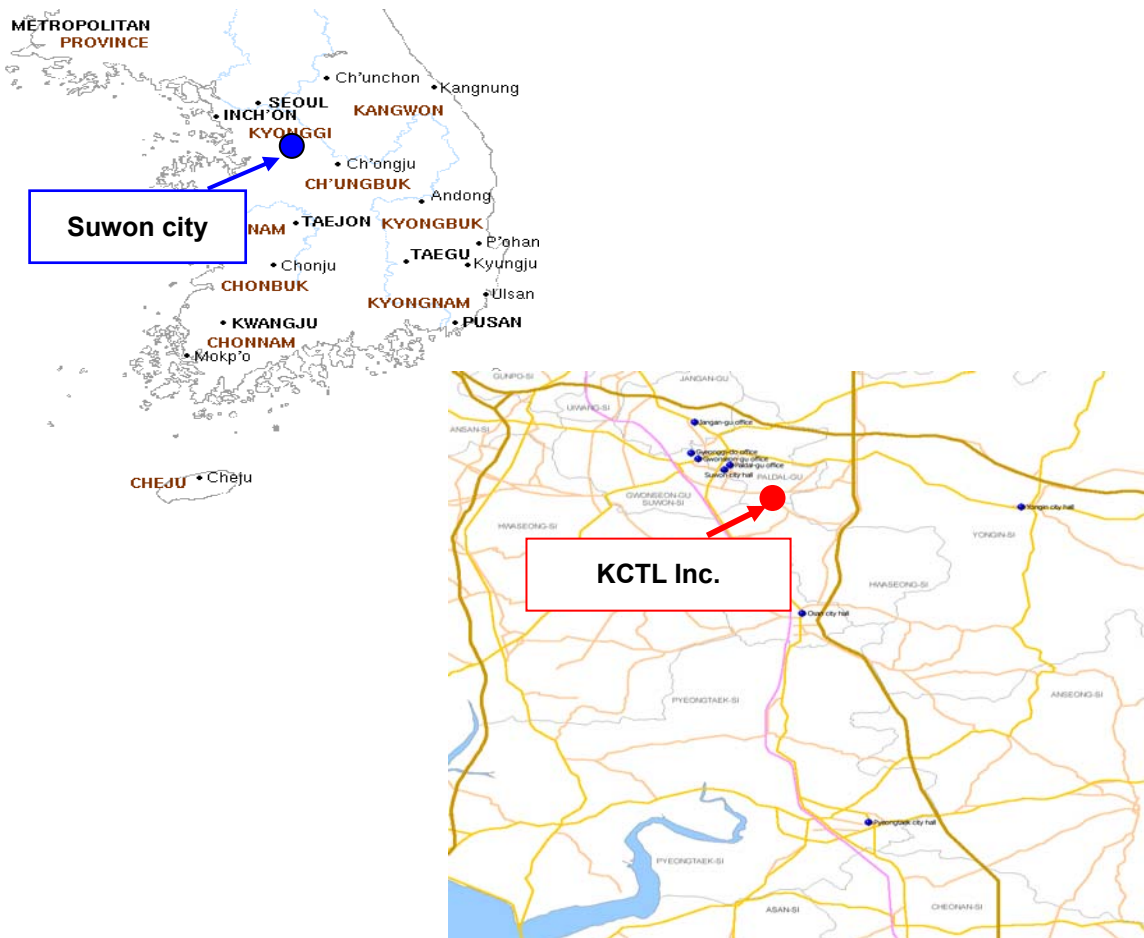

3. Test system configuration

3.1 Operation environment

	Temperature	Humidity	Pressure
Chamber 10 m (RE)	21.4 °C	44.5 % R.H.	-
Shielded room(CE)	21.7 °C	46.8 % R.H.	-

Test site

These testing items were performed following locations;

Test item	Test site
Conducted Emission	Shielded Room
Radiated Emission	10 m Chamber

KCTL Inc.

65, Sinwon-ro, Yeongtong-gu,
Suwon-si, Gyeonggi-do, 16677, Korea
Tel: 82-31-285-0894 Fax: 82-505-299-8311
www.kctl.co.kr

Report No.:
KR21-SEF0143
Page (7) of (18)



3.2 Measurement Uncertainty

All measurements involve certain levels of uncertainties, especially in field of EMC.

The factors contributing to uncertainties are test receiver, cable loss, antenna factor calibration, Antenna directivity, antenna factor variation with height, antenna phase center variation, antenna frequency interpolation, measurement distance variation, site imperfection, mismatch, and system repeatability. Based on CISPR 16-4-2, the measurement uncertainty level with a 95 % confidence level was applied.

Conducted Emission measurement (Confidence level about 95 %, $k = 2$)			
Shielded Room (CE#1)	9 kHz ~ 150 kHz:	3.50 dB	
	150 kHz ~ 30 MHz:	3.06 dB	
Shielded Room (CE#2)	9 kHz ~ 150 kHz:	3.05 dB	
	150 kHz ~ 30 MHz:	3.06 dB	
Radiated Emission measurement (Confidence level about 95 %, $k = 2$)			
10 m Chamber (4F)	30 MHz ~ 300 MHz	3 m:	5.36 dB
		10 m:	5.34 dB
	300 MHz ~ 1 000 MHz	3 m:	5.46 dB
		10 m:	5.44 dB
	1 GHz ~ 6 GHz	3 m:	6.24 dB
	6 GHz ~ 18 GHz	3 m:	6.60 dB
	18 GHz ~ 30 GHz	3 m:	6.72 dB
30 GHz ~ 40 GHz	3 m:	6.14 dB	
10 m Chamber (2F)	30 MHz ~ 300 MHz	3 m:	4.88 dB
		10 m:	4.86 dB
	300 MHz ~ 1 000 MHz	3 m:	4.94 dB
		10 m:	4.94 dB
1 GHz ~ 6 GHz	3 m:	6.28 dB	

3.3 Measurement Program

These test items were performed by software programs;

Test item	Measurement Program		Used
Conducted Emission	EP5CE_V 5.4.0(TOYO)		☒
Radiated Emission	2F	EP10/RE_Ver 2021.01.000 (TOYO)	☒
	4F	EP5RE_V 5.11.10(TOYO)	

KCTL Inc.

65, Sinwon-ro, Yeongtong-gu,
Suwon-si, Gyeonggi-do, 16677, Korea
Tel: 82-31-285-0894 Fax: 82-505-299-8311
www.kctl.co.kr

Report No.:
KR21-SEF0143
Page (9) of (18)



4. Description of EUT

4.1 General information

Radar

Receiver type : Dual conversion super-heterodyne
Antenna type : Linear polarized, self-contained
Detector type : Scanning frequency discriminator
Frequency operation : X-band; 10.525 GHz \pm 0.025 GHz
K-band; 24.150 GHz \pm 0.100 GHz
Ka-band (super-wide); 34.700 GHz \pm 1.300 GHz

Laser

Receiver type : Pulsed laser signal receiver
Detector type : Digital signal processor pulse width discriminator
Optical sensor : Dual convex condenser lens and high speed photo diode detector,
950nm \pm 150 nm (nanometers)

General

Operating Temperature Range : -20° C to +85° C
Storage Temperature Range : -30° C to +95° C
Power requirements : 11V to 16V DC, 350 mA, negative ground
Dimensions HxWxL : 110.00 mm x 69.00 mm x 29.50 mm

4.2 Product description

Type of product	RADAR DETECTOR
Model name (Basic)	R3
Model name (Variant)	-
Difference	-
Serial no	-
Testing voltage	120 V, 60 Hz (Power supplied from Note PC)
Input rating	DC 11 V ~ DC 16 V
Internal clock frequency	22 MHz
Note	-

4.3 Auxiliary equipments

Type	Model / Part #	S/N	Manufacturer	SDoC & FCC ID
Note PC	R73G	-	DELL	SDoC
Adapter #1	LA65NM130	-	(MFG)Lite-On Technology (Changzhou) Co.,Ltd.	-
USB Mouse	AA-SM7PCP	CN57BA5903634 ADV8J3852692	SAMSUNG	SDoC
USB Keyboard	K120	1833SC52GXU8	Logitech	SDoC
Monitor	UN22D5003	23SJ3CR	SAMSUNG	SDoC

4.4 Test configuration

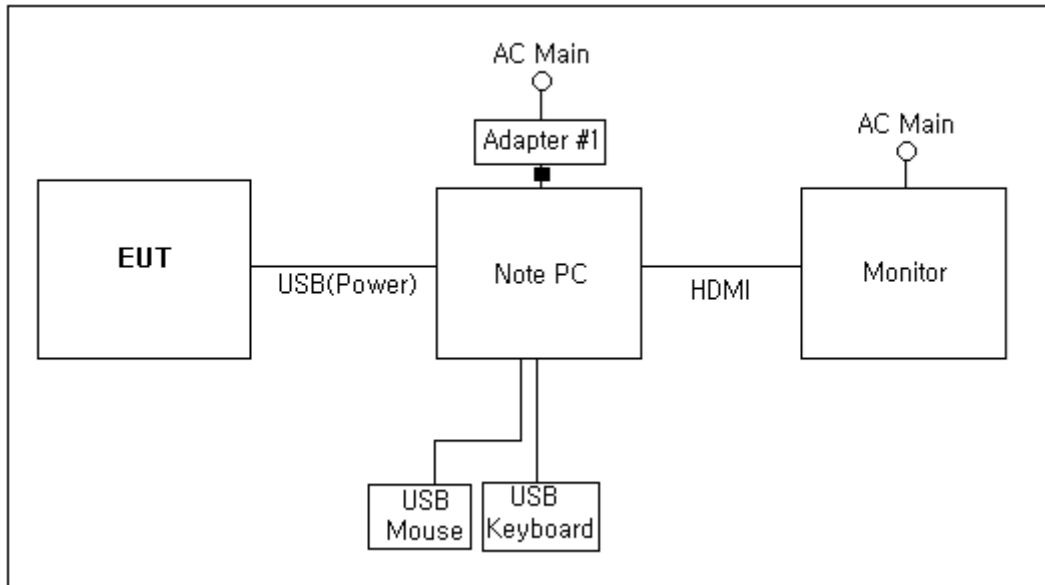

	Start		End		Cable	
	Name	I/O port	Name	I/O port	Length (m)	Spec.
1	EUT	USB(Power)	Note PC	USB	2.0	Shield
2	Note PC	Power	Adapter #1	-	1.5	Unshield (Core)
3		HDMI	Monitor	HDMI	2.0	Shield
4		USB	USB Mouse	-	1.5	Unshield
5		USB	USB Keyboard	-	1.5	Shield

4.5 Operating conditions

The EUT was configured as normal intended use.

Test mode	Normal operating
Test #1	Connect with a USB Cable between EUT and Note PC and use the 'Uniden FCC Tool' program to check and test data communication.

5. Summary of test results

5.1 Summary of EMI emission test results

Applied	Test items	Test method	Result
☒	Conducted Emission	ANSI C63.4:2014, Class B FCC Part 15 Subpart B	Pass
☒	Radiated Emission	ANSI C63.4:2014, Class B FCC Part 15 Subpart B	Pass

The data collected shows that EUT the complied with technical requirements of above rules part 15.107(a), (d) and 15.109(a).

6. Test results

6.1 Conducted Emissions

Testing voltage	120 V, 60 Hz		
Test facility	Shielded room (CE#2)		
Date	2021-09-13		
Temperature (°C)	21.7 °C	Humidity (% R.H.)	46.8 % R.H.
Remarks	Pass		

6.1.1 Limits of conducted emissions measurement

Frequency [MHz]	Class A (dB(μ V))		Class B (dB(μ V))	
	Quasi-peak	Average	Quasi-peak	Average
0.15 ~ 0.5	79	66	66 ~ 56 ¹⁾	56 ~ 46 ¹⁾
0.5 ~ 5	73	60	56	46
5 ~ 30	73	60	60	50

¹⁾ The limit decreases linearly with the logarithm of frequency

6.1.2 Measurement procedure

The measurements were performed in a shielded room. EUT was setup as shown in photograph and placed on a non-metallic table height of 0.8 m above the reference ground plane. The rear of table was located 0.4 m to the vertical conducted plane. EUT was power through the LISN, which was bonded to the ground plane. The LISN power was filtered. Each EUT power lead, except ground (safety) lead was individually connected through a LISN to input power source. EUT signal cables that hung closer than 0.4 m to the Horizontal metal ground 0.3 m ~ 0.4 m long. The power cord was bundles in the center. All peripheral equipment was powered from a sub LISN. The LISN and ISN were positioned 0.8 m from the EUT. Peak and Average detection were used in preliminary testing and Quasi-peak and Average detections were used at final measurement.

6.1.3 Used equipments

Equipment	Model no.	Serial no.	Makers	Next Cal. Date	Used
EMI TEST RECEIVER	ESCI	100710	R&S	2022.04.14	☒
TWO-LINE V-NETWORK	ENV216	101584	R&S	2022.04.05	☒
TWO-LINE V-NETWORK	NNLK8121	8121-472	SCHWARZBECK	2022.08.19	☒

KCTL Inc.

65, Sinwon-ro, Yeongtong-gu,
Suwon-si, Gyeonggi-do, 16677, Korea
Tel: 82-31-285-0894 Fax: 82-505-299-8311
www.kctl.co.kr

Report No.:
KR21-SEF0143
Page (15) of (18)



6.1.4 Conducted emissions measurement result

AC Main

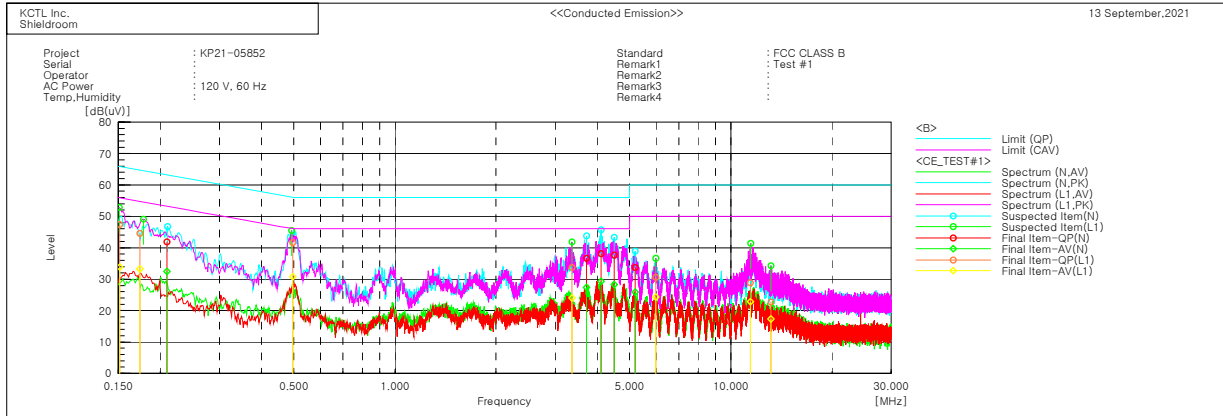

Final Result

--- N Phase ---

No.	Frequency [MHz]	Reading QP [dB(uV)]	Reading CAV [dB(uV)]	c. f [dB]	Result QP [dB(uV)]	Result CAV [dB(uV)]	Limit QP [dB(uV)]	Limit AV [dB(uV)]	Margin QP [dB]	Margin CAV [dB]
1	0.20955	32.0	22.7	9.8	41.8	32.5	63.2	53.2	21.4	20.7
2	3.72298	26.9	17.6	9.7	36.6	27.3	56.0	46.0	19.4	18.7
3	4.10672	28.4	19.6	9.7	38.1	29.3	56.0	46.0	17.9	16.7
4	4.49852	28.0	18.6	9.7	37.7	28.3	56.0	46.0	18.3	17.7
5	5.19257	24.0	16.3	9.7	33.7	26.0	60.0	50.0	26.3	24.0

--- L1 Phase ---

No.	Frequency [MHz]	Reading QP [dB(uV)]	Reading CAV [dB(uV)]	c. f [dB]	Result QP [dB(uV)]	Result CAV [dB(uV)]	Limit QP [dB(uV)]	Limit AV [dB(uV)]	Margin QP [dB]	Margin CAV [dB]
1	0.1514	37.7	24.1	9.7	47.4	33.8	65.9	55.9	18.5	22.1
2	0.1741	34.6	23.2	10.0	44.6	33.2	64.8	54.8	20.2	21.6
3	0.49589	31.8	21.0	9.8	41.6	30.8	56.1	46.1	14.5	15.3
4	3.36733	24.0	14.3	9.7	33.7	24.0	56.0	46.0	22.3	22.0
5	5.97739	20.8	14.6	9.7	30.5	24.3	60.0	50.0	29.5	25.7
6	11.44462	19.0	13.0	9.8	28.8	22.8	60.0	50.0	31.2	27.2
7	13.16114	12.8	7.4	9.9	22.7	17.3	60.0	50.0	37.3	32.7

6.2 Radiated Emission

Testing voltage	120 V, 60 Hz		
Test facility	10 m Chamber (4F)		
Test distance	3 m		
Date	2021-09-14		
Temperature (°C)	21.4 °C	Humidity (% R.H.)	44.5 % R.H.
Remarks	Pass		

6.2.1 Limits of radiated emission measurement

Frequency [MHz]	Class A at 10 m QP(dB(μV/m))		Class B at 3 m QP(dB(μV/m))	
	FCC ¹⁾	ISED (ICES Issue 7)	FCC ¹⁾	ISED (ICES Issue 7)
30-88	39.1	40.0	40.0	40.0
88-216	43.5	43.5	43.5	43.5
216-230	46.4	46.4	46.0	46.0
230-960	46.4	47.0	46.0	47.0
Above 960	49.5	49.5	54.0	54.0

- ¹⁾: Alternative standard: CISPR, Pub. 22

- Test data in this section has been taken against the FCC 15.109(a) or (B) Limit as it is the most stringent limit.

By complying with more restrictive FCC 15.109 Limit compliance with the ICES-003 Issue 7 limit also demonstrated.

6.2.2 Measurement procedure

The test was done at a 10 m chamber with a quasi-peak detector. EUT was placed on a non-metallic table height of 0.8 m above the reference ground plane. Cables were folded back and forth forming a bundle 0.3 m to 0.4 m long and were hanged at a 0.4 m height to the ground plane.

Cables connected to EUT were fixed to cause maximum emission. Test was made with the antenna positioned in both the horizontal and vertical planes of polarization. The measurement antenna was varied in height above the conducting ground plane to obtain the maximum signal strength.

6.2.3 Used equipments

Equipment	Model no.	Serial no.	Makers	Next Cal. Date	Used
EMI TEST RECEIVER	ESC17	100732	R&S	2022.03.05	☒
Bilog Antenna	CBL 6112D	55545	TESEQ	2022.04.24	☒
AMPLIFIER	310N	284608	SONOMA	2022.08.19	☒
ATTENUATOR	8491B-6dB	MY39271060	KEYSIGHT	-	☒
Antenna Mast	MA4640/800-XP-ET	-	Innco Systems	-	☒
Turn Table	DT2000	79	Innco Systems	-	☒

6.2.4 Sample calculation

The field strength is calculated adding the antenna Factor, cable loss and, Antenna pad adding, subtracting the amplifier gain from the measured reading.

The sample calculation is as follow:

$$\text{Result} = \text{M.R} + \text{C.F}(\text{A.F} + \text{C.L} + 6 \text{ dB Att} - \text{A.G})$$

M.R = Meter Reading

C.F = Correction Factor

A.F = Antenna Factor

C.L = Cable Loss

A.G = Amplifier Gain

6 dB Att = 6 dB Attenuator

If M.R is 30 dB, A.F 12 dB, C.L 5 dB, 6 dB, A.G 35 dB

The result is $30 + 12 + 5 + 6 - 35 = 18 \text{ dB } (\mu\text{V/m})$

Bilog Antenna and ATTENUATOR (6 dB) were calibrated together.

AV = CAV : Abbreviation of CISPR Average

KCTL Inc.

65, Sinwon-ro, Yeongtong-gu,
Suwon-si, Gyeonggi-do, 16677, Korea
Tel: 82-31-285-0894 Fax: 82-505-299-8311
www.kctl.co.kr

Report No.:
KR21-SEF0143
Page (18) of (18)



6.2.5 Radiated emission measurement result

30 MHz ~ 1 GHz

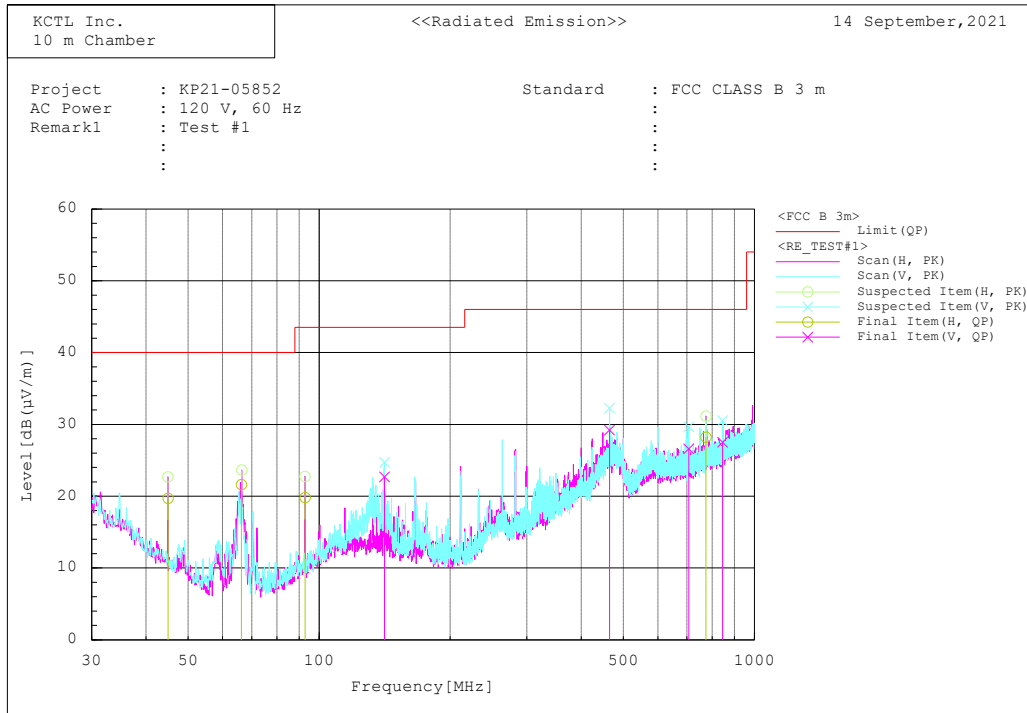

Final Result

Frequency	Pol.	Reading	Factor	Level	Limit	Margin	Height	Angle
MHz		dB(µV)	dB(1/m)	dB(µV/m)	dB(µV/m)	dB	cm	deg
		QP		QP	QP			
44.994	H	33.5	-13.8	19.7	40.0	20.3	212.0	359.0
66.313	H	38.9	-17.3	21.6	40.0	18.4	359.0	0.0
92.877	H	33.6	-13.8	19.8	43.5	23.7	317.0	359.0
141.350	V	33.5	-10.8	22.7	43.5	20.8	190.0	219.0
464.883	V	30.2	-1.0	29.2	46.0	16.8	123.0	29.0
706.933	V	23.4	3.2	26.6	46.0	19.4	157.0	346.0
774.401	H	23.6	4.6	28.2	46.0	17.8	227.0	221.0
845.070	V	21.8	5.7	27.5	46.0	18.5	172.0	3.0