



RF TEST REPORT

Applicant Quectel Wireless Solutions Co., Ltd
FCC ID XMR201910BG95M3
Product LTE Cat M1 & Cat NB2 & EGPRS Module
Brand Quectel
Marketing Quectel BG95-M3
Model BG95-M3
Report No. R1907A0446-R5
Issue Date September 11, 2019

TA Technology (Shanghai) Co., Ltd. tested the above equipment in accordance with the requirements in **FCC CFR47 Part 2 (2018)/ FCC CFR 47 Part 24E (2018)**. The test results show that the equipment tested is capable of demonstrating compliance with the requirements as documented in this report.

Performed by: Peng Tao

Approved by: Kai Xu

TA Technology (Shanghai) Co., Ltd.

No.145, Jintang Rd, Tangzhen Industry Park, Pudong Shanghai, China

TEL: +86-021-50791141/2/3

FAX: +86-021-50791141/2/3-8000



TABLE OF CONTENT

1. Test Laboratory	4
1.1. Notes of the test report.....	4
1.2. Test facility.....	4
1.3. Testing Location	5
2. General Description of Equipment under Test.....	6
3. Applied Standards.....	7
4. Test Configuration.....	8
5. Test Case Results.....	9
5.1. RF Power Output.....	9
5.2. Effective Isotropic Radiated Power	11
5.3. Occupied Bandwidth	14
5.4. Band Edge Compliance.....	21
5.5. Peak-to-Average Power Ratio (PAPR)	26
5.6. Frequency Stability	28
5.7. Spurious Emissions at Antenna Terminals	33
5.8. Radiates Spurious Emission	37
6. Main Test Instruments	43

Summary of measurement results

No.	Test Case	Clause in FCC rules	Verdict
1	RF power output	2.1046	PASS
2	Effective Isotropic Radiated power	24.232(c)	PASS
3	Occupied Bandwidth	2.1049	PASS
4	Band Edge Compliance	2.1051 /24.238(a)	PASS
5	Peak-to-Average Power Ratio	24.232/KDB 971168 D01(5.7)	PASS
6	Frequency Stability	2.1055 / 24.235	PASS
7	Spurious Emissions at Antenna Terminals	2.1051 / 24.238(a)	PASS
8	Radiates Spurious Emission	2.1053 / 24.238(a)	PASS
Note: PASS: The EUT complies with the essential requirements in the standard. FAIL: The EUT does not comply with the essential requirements in the standard.			
Date of Testing: August 12, 2019~ September 5, 2019			



1. Test Laboratory

1.1. Notes of the test report

This report shall not be reproduced in full or partial, without the written approval of **TA technology (shanghai) co., Ltd.** The results documented in this report apply only to the tested sample, under the conditions and modes of operation as described herein. Measurement Uncertainties were not taken into account and are published for informational purposes only. This report is written to support regulatory compliance of the applicable standards stated above.

1.2. Test facility

FCC (Designation number: CN1179, Test Firm Registration Number: 446626)

TA Technology (Shanghai) Co., Ltd. has been listed on the US Federal Communications Commission list of test facilities recognized to perform electromagnetic emissions measurements.

IC (recognition number is 8510A)

TA Technology (Shanghai) Co., Ltd. has been listed by industry Canada to perform electromagnetic emission measurement.

VCCI (recognition number is C-4595, T-2154, R-4113, G-10766)

TA Technology (Shanghai) Co., Ltd. has been listed by industry Japan to perform electromagnetic emission measurement.

A2LA (Certificate Number: 3857.01)

TA Technology (Shanghai) Co., Ltd. has been listed by American Association for Laboratory Accreditation to perform electromagnetic emission measurement.



1.3. Testing Location

Company: TA Technology (Shanghai) Co., Ltd.
Address: No.145, Jintang Rd, Tangzhen Industry Park, Pudong
City: Shanghai
Post code: 201201
Country: P. R. China
Contact: Xu Kai
Telephone: +86-021-50791141/2/3
Fax: +86-021-50791141/2/3-8000
Website: <http://www.ta-shanghai.com>
E-mail: xukai@ta-shanghai.com

2. General Description of Equipment under Test

Client Information

Applicant	Quectel Wireless Solutions Co., Ltd
Applicant address	Building 5, Shanghai Business Park Phase III (Area B), No.1016 Tianlin Road, Minhang District, Shanghai, China 200233
Manufacturer	Quectel Wireless Solutions Co., Ltd
Manufacturer address	Building 5, Shanghai Business Park Phase III (Area B), No.1016 Tianlin Road, Minhang District, Shanghai, China 200233

General information

EUT Description			
Model	BG95-M3		
IMEI	864475040001835		
Hardware Version	R2.1		
Software Version	BG95M3LAR02A01		
Power Supply	External Power Supply		
Antenna Type	External Antenna		
Antenna Gain	NB-IOT 2:1.6dBi NB-IOT 25:1.7dBi		
Test Mode(s)	NB-IOT Band 2/25;		
Test Modulation:	BPSK, QPSK		
Category	NB2		
Deployment:	stand-alone		
Sub-carrier spacing:	3.75KHz, 15KHz		
Ntones:	single, multi-tone		
Maximum E.I.R.P	NB-IOT Band 2	22.17dBm	
	NB-IOT Band 25	21.68dBm	
Rated Power Supply Voltage	3.8V		
Extreme Voltage	Minimum: 3.3V Maximum: 4.3V		
Extreme Temperature	Lowest: -40°C Highest: +85°C		
Operating Frequency Range(s)	Band	Tx (MHz)	Rx (MHz)
	NB-IOT Band 2	1850 ~ 1910	1930 ~ 1990
	NB-IOT Band 25	1850 ~ 1915	1930 ~ 1995
Note: 1. The information of the EUT is declared by the manufacturer.			



3. Applied Standards

According to the specifications of the manufacturer, it must comply with the requirements of the following standards:

FCC CFR47 Part 2 (2018)

FCC CFR 47 Part 24E (2018)

ANSI C63.26 (2015)

KDB 971168 D01 Power Meas License Digital Systems v03r01

4. Test Configuration

Radiated measurements are performed by rotating the EUT in three different orthogonal test planes. EUT stand-up position (Z axis), lie-down position (X, Y axis). Receiver antenna polarization (horizontal and vertical), the worst emission was found in position (X axis, horizontal polarization) and the worst case was recorded.

All modes as Subcarrier Spacing, modulations, Channel were investigated.

Subsequently, only the worst case emissions are reported.

The following testing in NB-IOT is set based on the maximum RF Output Power.

The following testing in different mode is set to detail in the following table:

Test modes are chosen to be reported as the worst case configuration below for NB-IOT Band 2/25

Test items	Deployment mode	Subcarrier Spacing (kHz)		Modulation		Test Channel		
	Stand-alone	3.75	15	BPSK	QPSK	L	M	H
RF power output	O	O	O	O	O	O	O	O
Effective Isotropic Radiated power	O	O	O	O	O	O	O	O
Occupied Bandwidth	O	O	O	O	O	O	O	O
Band Edge Compliance	O	O	O	O	O	O	-	O
Peak-to-Average Power Ratio	O	O	O	O	O	-	O	-
Frequency Stability	O	O	O	O	O	O	O	O
Conducted Spurious Emissions	O	-	O	-	O	O	O	O
Radiates Spurious Emission	O	-	O	-	O	O	O	O
<p>Note</p> <p>1. The mark "O" means that this configuration is chosen for testing.</p> <p>2. The mark "-" means that this configuration is not testing.</p>								

5. Test Case Results

5.1. RF Power Output

Ambient condition

Temperature	Relative humidity	Pressure
23°C ~25°C	45%~50%	101.5kPa

Methods of Measurement

During the process of the testing, The EUT is controlled by the Base Station Simulator to ensure max power transmission and proper modulation.

Test Setup

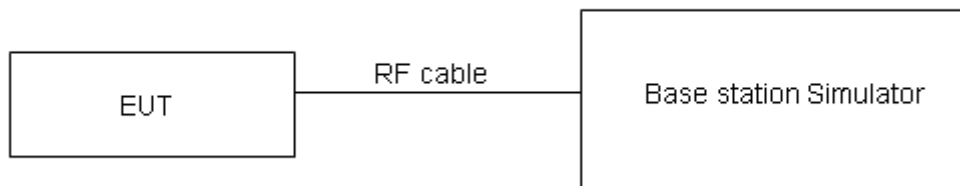

The loss between RF output port of the EUT and the input port of the tester has been taken into consideration.

Limits

No specific RF power output requirements in part 2.1046.

Measurement Uncertainty

The assessed measurement uncertainty to ensure 95% confidence level for the normal distribution is with the coverage factor $k = 2$, $U = 0.4$ dB.

Test Results

Mode	Modulation	Sub-carrier spacing (KHz)	Ntones	Conducted Power (dBm) for low/mid/high channel		
				18601/1850.1	18900/1880.0	19199/1909.9
Band 2 Standalone	BPSK	3.75	1@0	20.30	20.45	20.48
			1@47	20.22	20.34	20.36
		15	1@0	20.37	20.31	20.44
			1@11	20.30	20.20	20.34
	QPSK	3.75	1@0	20.05	20.40	20.27
			1@47	19.92	20.30	20.09
		15	1@0	20.32	20.57	20.50
			1@11	20.19	20.50	20.37
		15	12@0	18.92	19.21	19.06
		Mode	Modulation	Sub-carrier spacing (KHz)	Ntones	Conducted Power (dBm) for low/mid/high channel
26041/1850.1	26365/1882.5					26689/1914.9
Band 25 Standalone	BPSK	3.75	1@0	19.64	19.04	18.09
			1@47	19.52	18.85	17.90
		15	1@0	19.98	19.32	18.37
			1@11	19.91	19.24	18.31
	QPSK	3.75	1@0	19.67	19.26	18.13
			1@47	19.55	19.14	18.00
		15	1@0	19.91	19.35	18.73
			1@11	19.82	19.26	18.70
		15	12@0	18.52	18.02	17.17

5.2. Effective Isotropic Radiated Power

Ambient condition

Temperature	Relative humidity	Pressure
23°C ~25°C	45%~50%	101.5kPa

Methods of Measurement

The testing follows FCC KDB 971168 v03r01 Section 5.8 and ANSI C63.26 (2015).

- a) Connect the equipment as illustrated. Mount the equipment with the manufacturer specified antenna in a vertical orientation on a manufacturer specified mounting surface located on a non-conducting rotating platform of a RF anechoic chamber (preferred) or a standard radiation site.
- b) Key the transmitter, then rotate the EUT 360° azimuthally and record spectrum analyzer power level (LVL) measurements at angular increments that are sufficiently small to permit resolution of all peaks. If a standard radiation test site is used, raise and lower the test antenna to obtain a maximum reading at each angular increment. (Note: several batteries may be needed to offset the effect of battery voltage droop, which should not exceed 5% of the manufactured specified battery voltage during transmission).
- c) Replace the transmitter under test with a vertically polarized half-wave dipole (or an antenna whose gain is known relative to an ideal half-wave dipole). The center of the antenna should be at the same location as the center of the antenna under test.
- d) Connect the antenna to a signal generator with a known output power and record the path loss (in dB) as LOSS. If a standard radiation test site is used, raise and lower the test antenna to obtain a maximum reading. $LOSS = \text{Generator Output Power (dBm)} - \text{Analyzer reading (dBm)}$
- e) Determine the effective radiated output power at each angular position from the readings in steps b) and d) using the following equation: $ERP \text{ (dBm)} = \text{LVL (dBm)} + \text{LOSS (dB)}$
- f) The maximum ERP is the maximum value determined in the preceding step.
- g) When calculating ERP, in addition to knowing the antenna radiation and matching characteristics, it is necessary to know the loss values of all elements (e.g. transmission line attenuation, mismatches, filters, combiners) interposed between the point where transmitter output power is measured, and the point where power is applied to the antenna. ERP can then be calculated as follows:
 $EIRP \text{ (dBm)} = \text{Output Power (dBm)} - \text{Losses (dB)} + \text{Antenna Gain (dBi)}$
where: dBd refers to gain relative to an ideal dipole.
 $EIRP \text{ (dBm)} = ERP \text{ (dBm)} + 2.15 \text{ (dB)}$

The RB allocation refers to section 5.1, using the maximum output power configuration.

Test setup

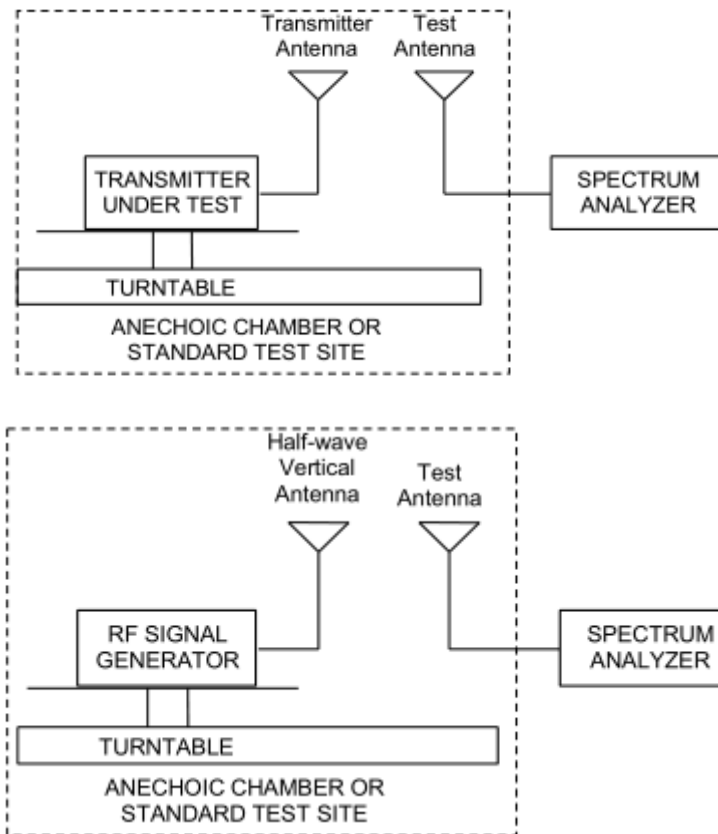

Limits

Rule Part 24.232(c) Mobile and portable stations are limited to 2 watts EIRP.

Rule Part 24.232(e) Peak transmit power must be measured over any interval of continuous transmission using instrumentation calibrated in terms of an rms-equivalent voltage.

Limit	$\leq 2\text{ W}$ (33 dBm)
-------	----------------------------

Measurement Uncertainty

The assessed measurement uncertainty to ensure 95% confidence level for the normal distribution is with the coverage factor $k = 2$, $U = 1.19\text{ dB}$

Test Results:

The measurement is performed for both of horizontal and vertical antenna Polarization, and only the data of worst mode is recorded in this report.

Mode	Modulation	Sub-carrier spacing (KHz)	Ntones	EIRP(dBm)			Limit (dBm)	Conclusion
				18601/1850.1	18900/1880.0	19199/1909.9		
Band 2 Standalone	BPSK	3.75	1@0	21.90	22.05	22.08	33	Pass
			1@47	21.82	21.94	21.96	33	Pass
		15	1@0	21.97	21.91	22.04	33	Pass
			1@11	21.90	21.80	21.94	33	Pass
	QPSK	3.75	1@0	21.65	22.00	21.87	33	Pass
			1@47	21.52	21.90	21.69	33	Pass
		15	1@0	21.92	22.17	22.10	33	Pass
			1@11	21.79	22.10	21.97	33	Pass
		15	12@0	20.52	20.81	20.66	33	Pass
Mode	Modulation	Sub-carrier spacing (KHz)	Ntones	EIRP(dBm)			Limit (dBm)	Conclusion
				26041/1850.1	26365/1882.5	26689/1914.9		
Band 25 Standalone	BPSK	3.75	1@0	21.34	20.74	19.79	33	Pass
			1@47	21.22	20.55	19.60	33	Pass
		15	1@0	21.68	21.02	20.07	33	Pass
			1@11	21.61	20.94	20.01	33	Pass
	QPSK	3.75	1@0	21.37	20.96	19.83	33	Pass
			1@47	21.25	20.84	19.70	33	Pass
		15	1@0	21.61	21.05	20.43	33	Pass
			1@11	21.52	20.96	20.40	33	Pass
		15	12@0	20.22	19.72	18.87	33	Pass

5.3.Occupied Bandwidth

Ambient condition

Temperature	Relative humidity	Pressure
23°C ~25°C	45%~50%	101.5kPa

Method of Measurement

The EUT was connected to Spectrum Analyzer and Base Station Simulator via power Splitter. The occupied bandwidth is measured using spectrum analyzer.

RBW is set to 2kHz, VBW is set to 6.2kHz for NB-IOT Band 2/25.

99% power and -26dBc occupied bandwidths are recorded. Spectrum analyzer plots are included on the following pages.

Test Setup

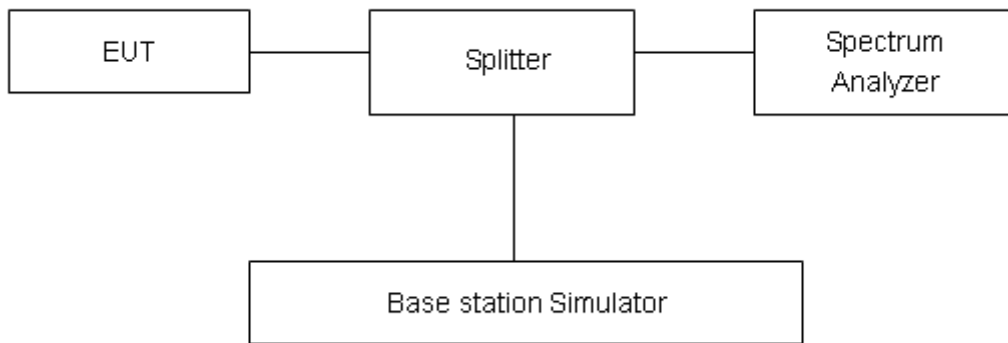

Limits

No specific occupied bandwidth requirements in part 2.1049.

Measurement Uncertainty

The assessed measurement uncertainty to ensure 95% confidence level for the normal distribution is with the coverage factor $k = 2$, $U = 624\text{Hz}$.



Test Result

Mode	Modulation	Sub-carrier spacing (KHz)	Ntones	Bandwidth(KHz) for low/mid/high channel					
				18601/1850.1		18900/1880.0		19199/1909.9	
				99% Power	-26dBc	99% Power	-26dBc	99% Power	-26dBc
Band 2 Standalone	BPSK	3.75	1@0	61.98	38.67	60.81	40.51	61.16	40.14
	QPSK	3.75	1@0	68.84	40.87	70.87	42.53	69.45	40.17
	BPSK	15	1@0	119.67	103.40	128.08	116.40	128.39	112.10
	QPSK	15	1@0	117.80	117.50	115.79	115.30	121.04	118.20
	QPSK	15	12@0	182.91	239.00	184.41	236.90	183.41	246.30

Mode	Modulation	Sub-carrier spacing (KHz)	Ntones	Bandwidth(KHz) for low/mid/high channel					
				26041/1850.1		26365/1882.5		26689/1914.9	
				99% Power	-26dBc	99% Power	-26dBc	99% Power	-26dBc
Band 25 Standalone	BPSK	3.75	1@0	64.31	41.50	62.19	41.19	61.11	40.49
	QPSK	3.75	1@0	72.99	40.60	68.77	40.15	70.55	40.58
	BPSK	15	1@0	130.18	118.10	126.48	116.30	121.43	103.70
	QPSK	15	1@0	116.55	103.40	119.62	114.60	117.05	116.90
	QPSK	15	12@0	183.87	240.30	184.52	249.40	182.93	250.50



NB-IOT Band 2 BPSK 3.75kHz 1@0 CH-Low

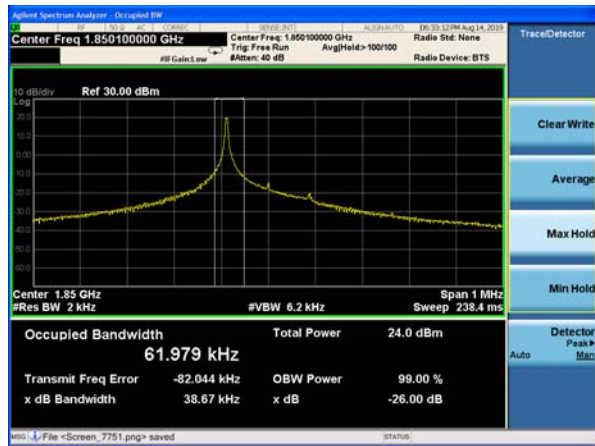

NB-IOT Band 2 BPSK 15kHz 1@0 CH-Low



NB-IOT Band 2 BPSK 3.75kHz 1@0 CH-Middle

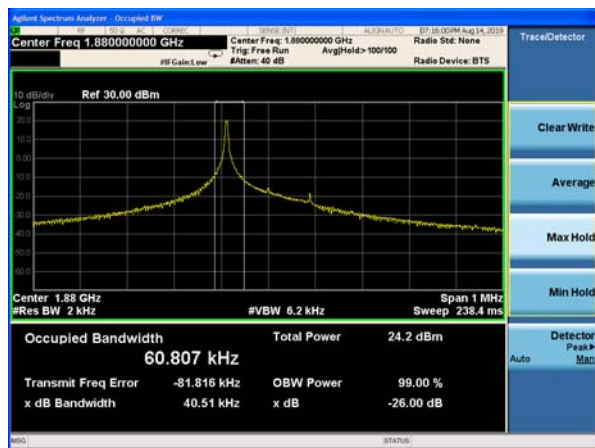

NB-IOT Band 2 BPSK 15kHz 1@0 CH-Middle

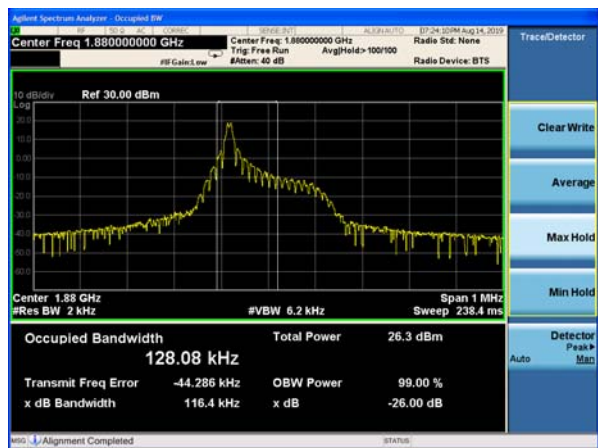

NB-IOT Band 2 BPSK 3.75kHz 1@0 CH-High

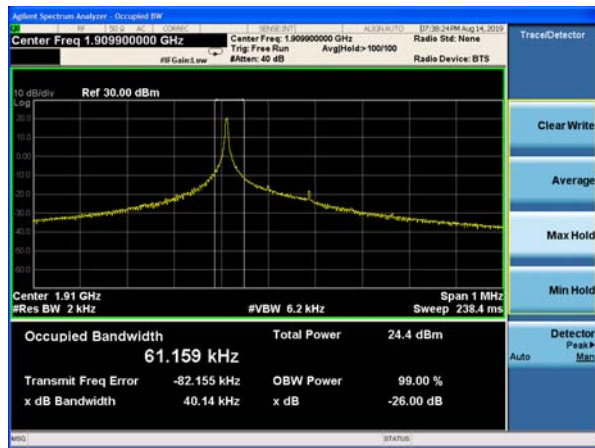

NB-IOT Band 2 BPSK 15kHz 1@0 CH-High



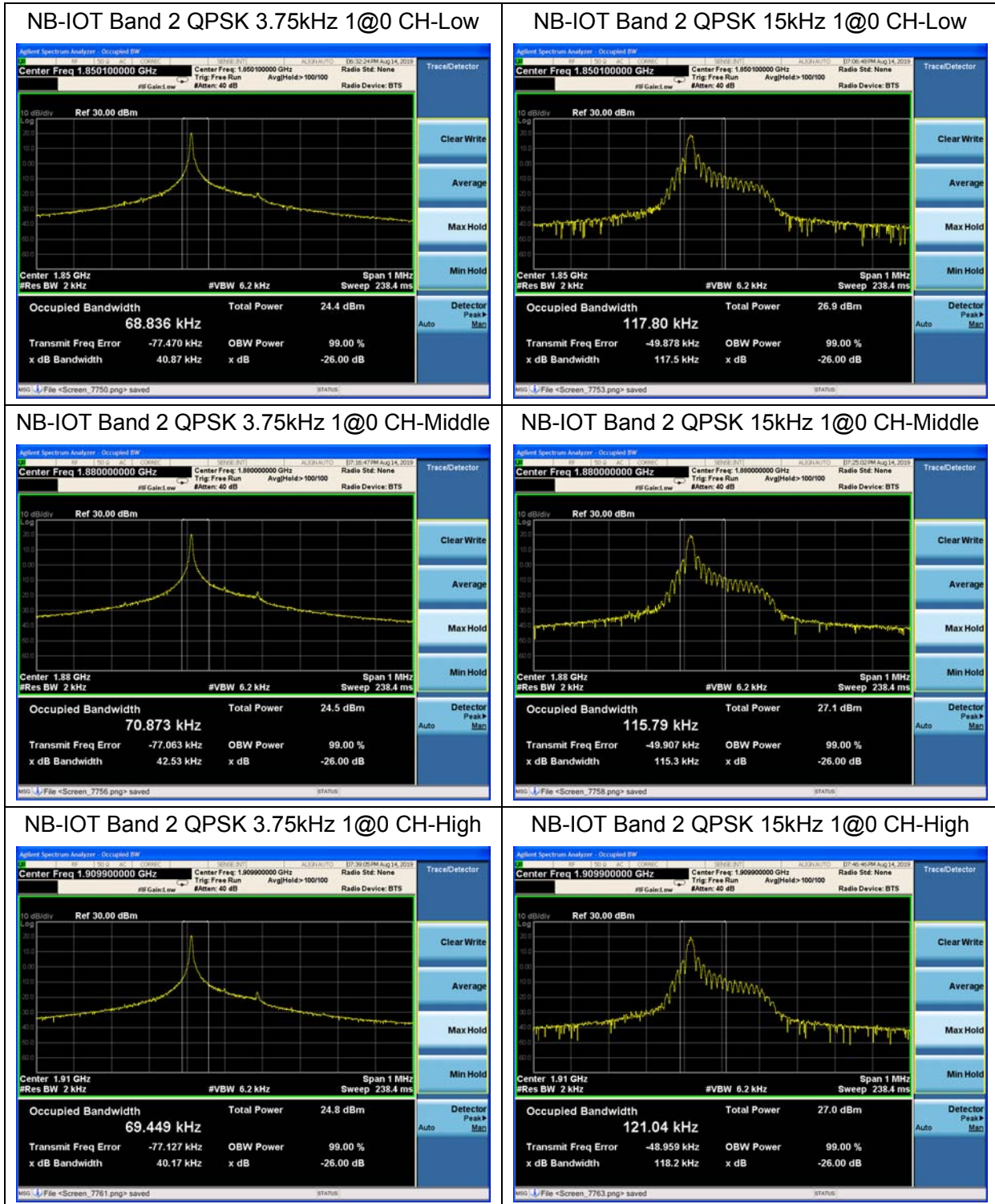

NB-IOT Band 2 QPSK 15kHz 12@0 CH-Low

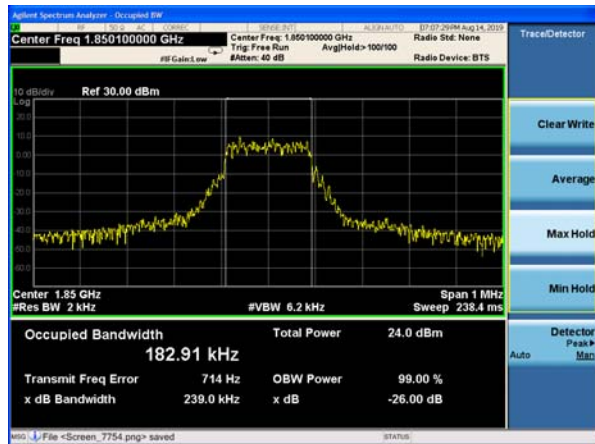

NB-IOT Band 25 BPSK 3.75kHz 1@0 CH-Low

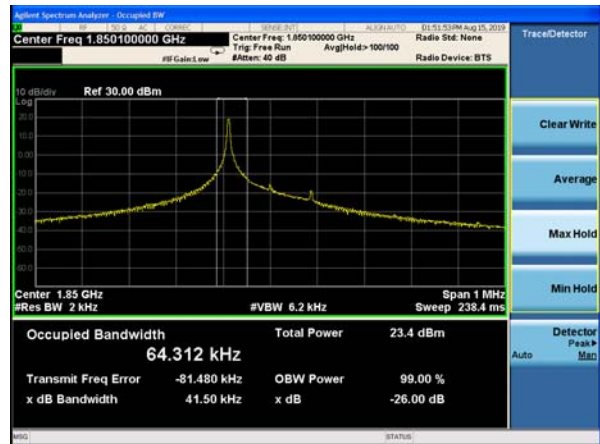

NB-IOT Band 2 QPSK 15kHz 12@0 CH-Middle

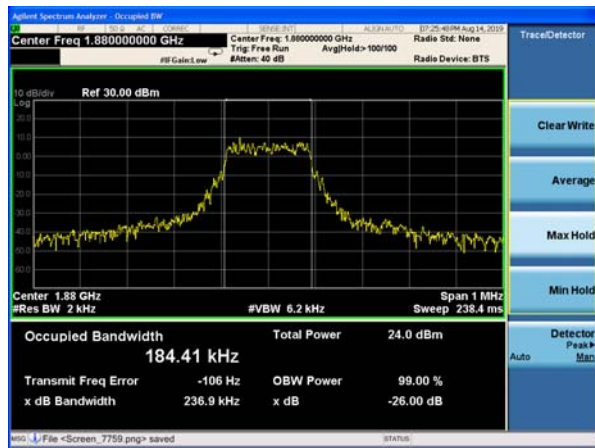

NB-IOT Band 25 BPSK 3.75kHz 1@0 CH-Middle

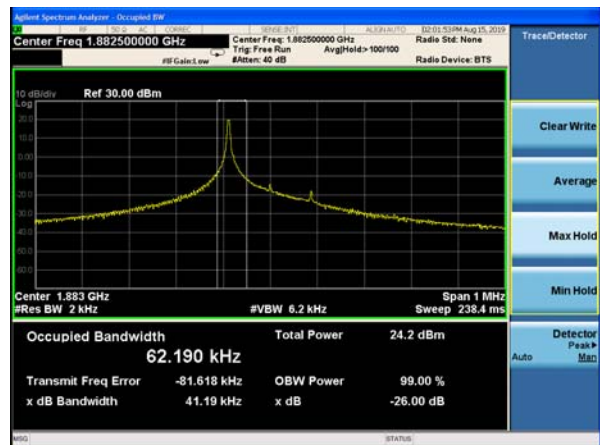

NB-IOT Band 2 QPSK 15kHz 12@0 CH-High

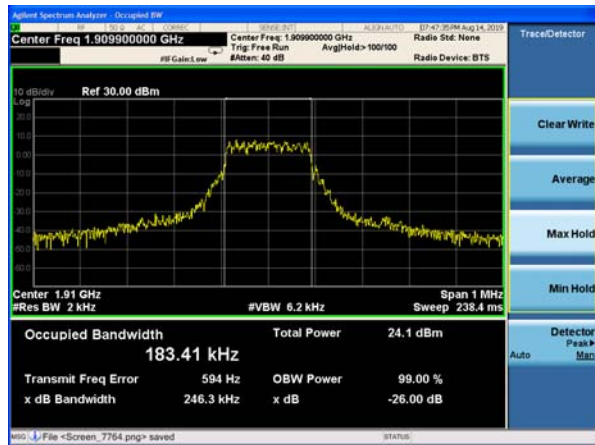

NB-IOT Band 25 BPSK 3.75kHz 1@0 CH-High

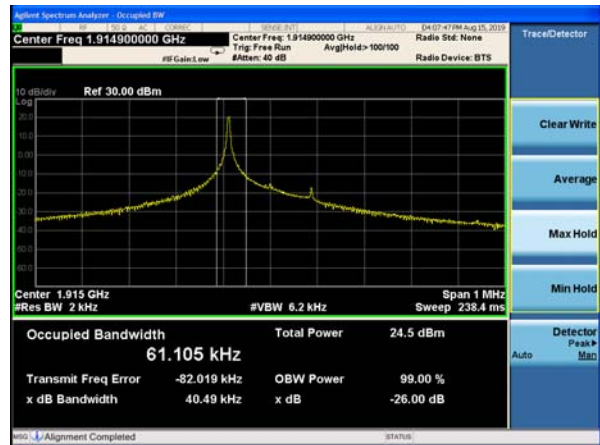



NB-IOT Band 25 BPSK 15kHz 1@0 CH-Low

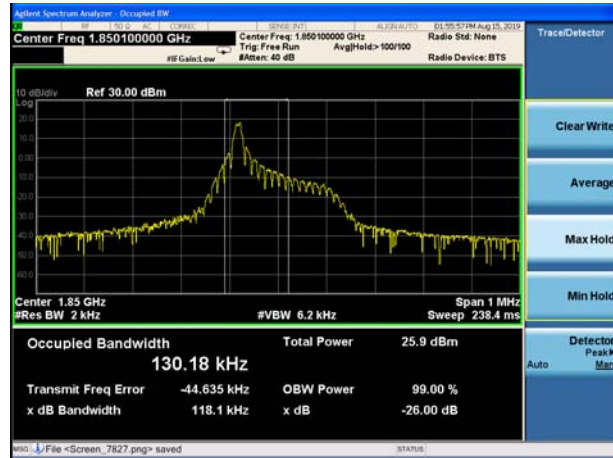

NB-IOT Band 25 QPSK 3.75kHz 1@0 CH-Low

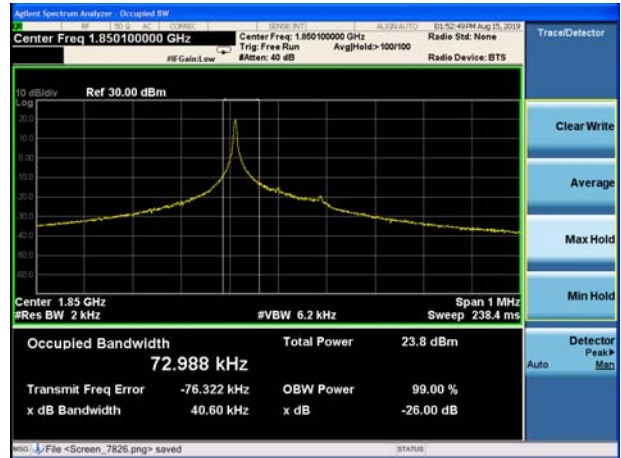

NB-IOT Band 25 BPSK 15kHz 1@0 CH-Middle



NB-IOT Band 25 QPSK 3.75kHz 1@0 CH-Middle

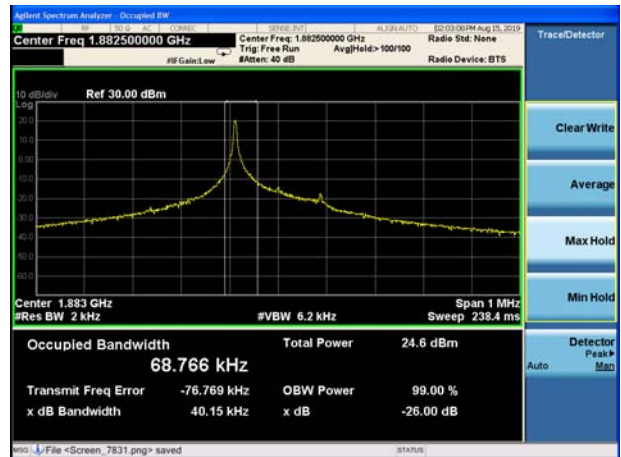

NB-IOT Band 25 BPSK 15kHz 1@0 CH-High



NB-IOT Band 25 QPSK 3.75kHz 1@0 CH-High

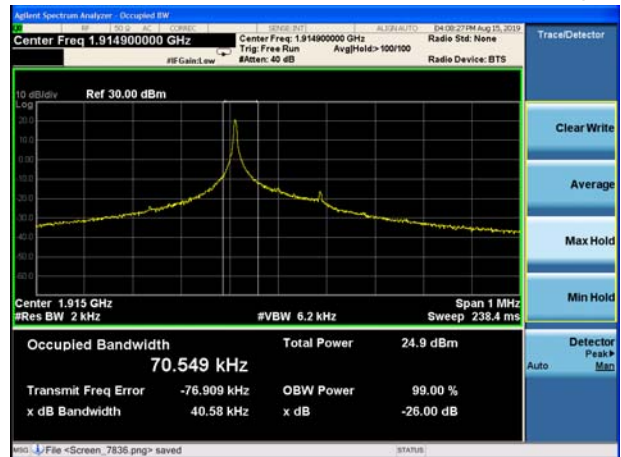

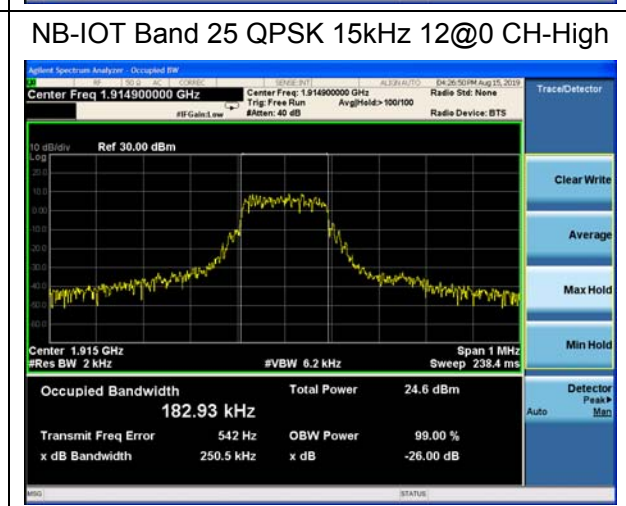
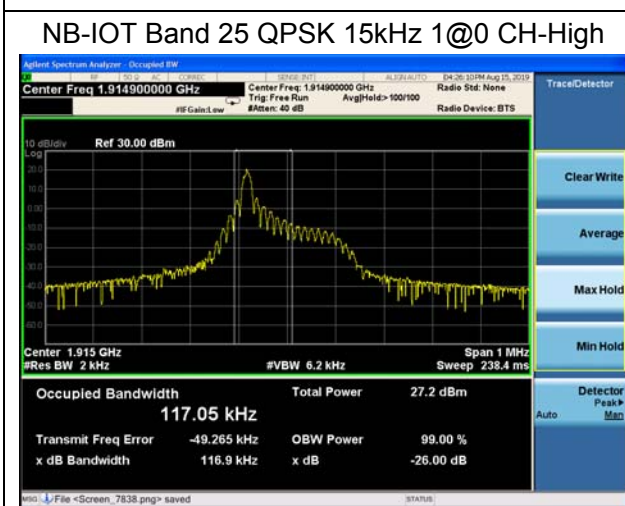
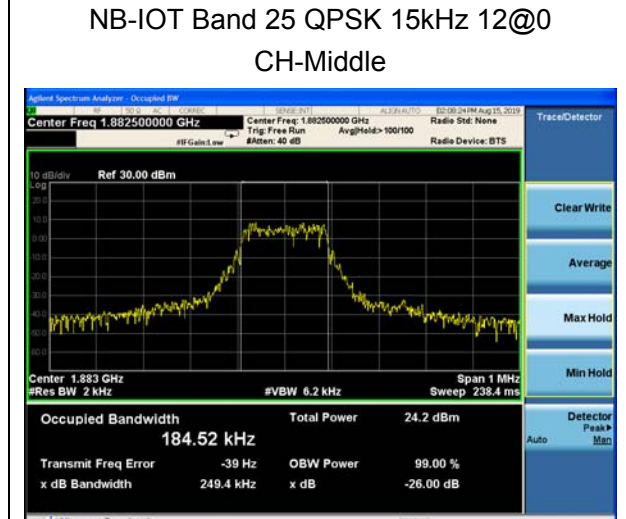
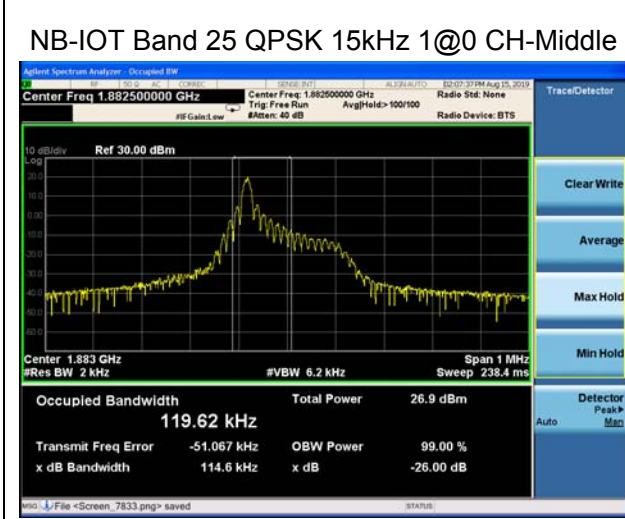
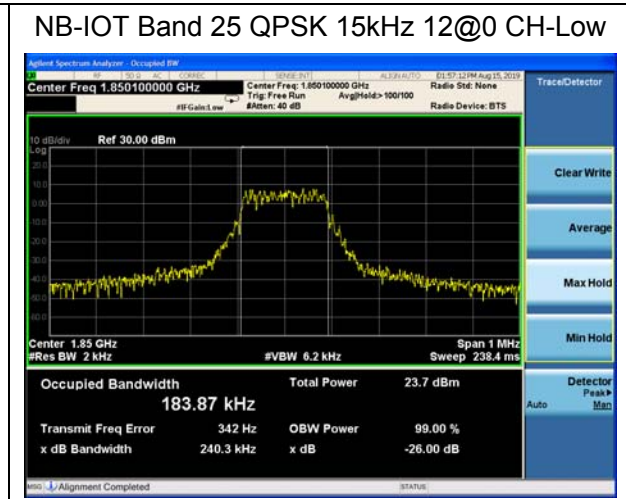
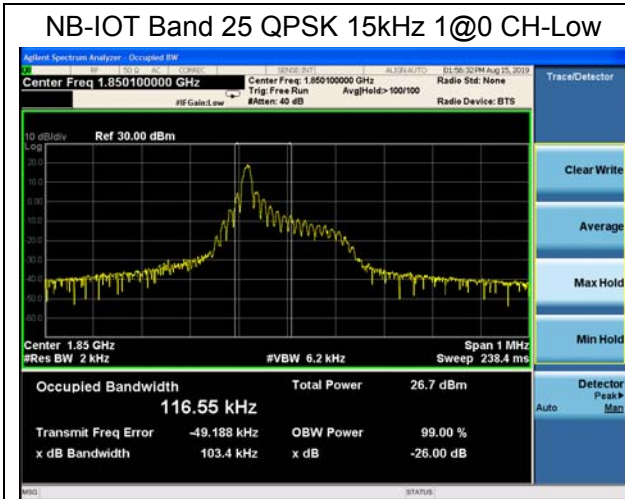

5.4. Band Edge Compliance

Ambient condition

Temperature	Relative humidity	Pressure
23°C ~25°C	45%~50%	101.5kPa

Method of Measurement

The EUT was connected to Spectrum Analyzer and Base Station Simulator via power Splitter. The band edge of the lowest and highest channels were measured. The Average detector is used and RBW is set to 750kHz, VBW is set to 2.4kHz for 3.75KHz single carrier, RBW is set to 1.5kHz, VBW is set to 4.7kHz for 15KHz single carrier, RBW is set to 1.2kHz, VBW is set to 3.6kHz for 15KHz single carrier, RBW is set to 2kHz, VBW is set to 6.2KHz for 15KHz full carrier. Spectrum analyzer plots are included on the following pages.

Test Setup

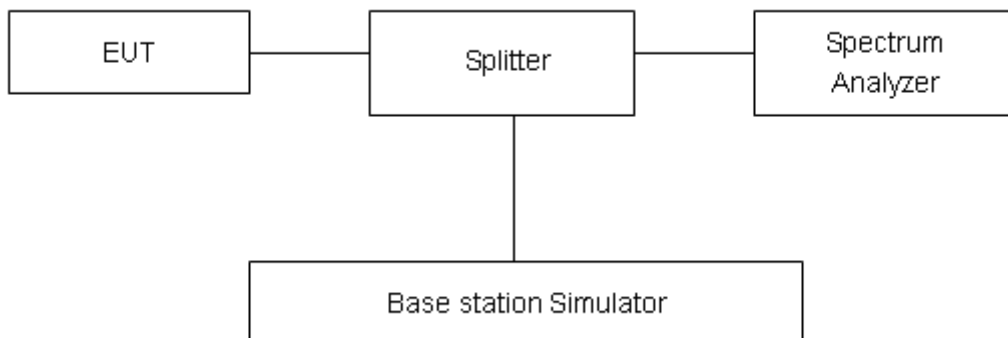

Limits

Rule Part 24.238(a) specifies that “on any frequency outside a licensee’s frequency block, the power of any emission shall be attenuated below the transmitter power (P) by at least 43 + 10 log₁₀ (P) dB.”

Limit	-13 dBm
-------	---------

Measurement Uncertainty

The assessed measurement uncertainty to ensure 95% confidence level for the normal distribution is with the coverage factor $k = 1.96$, $U=0.684$ dB.

Test Result:

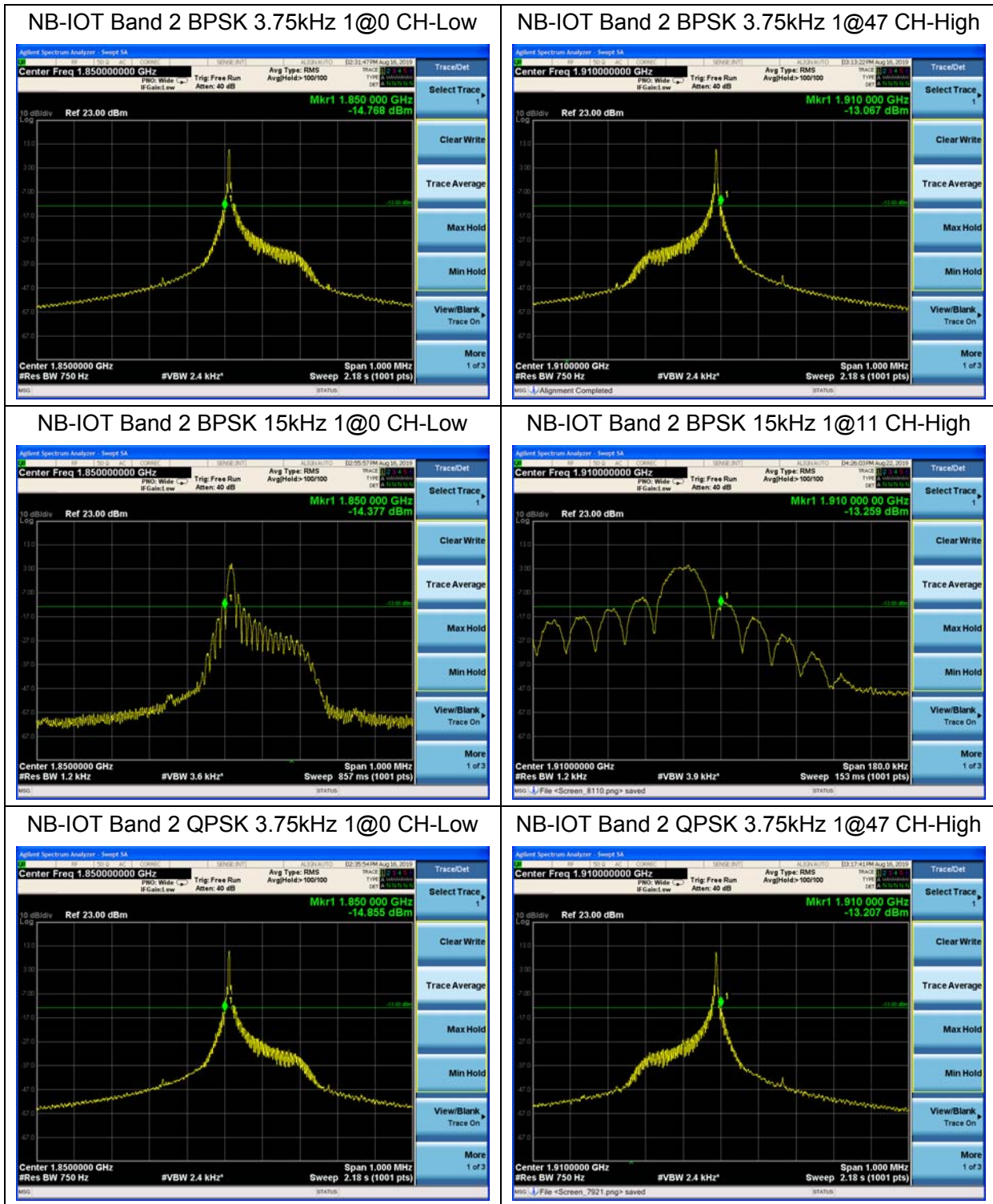

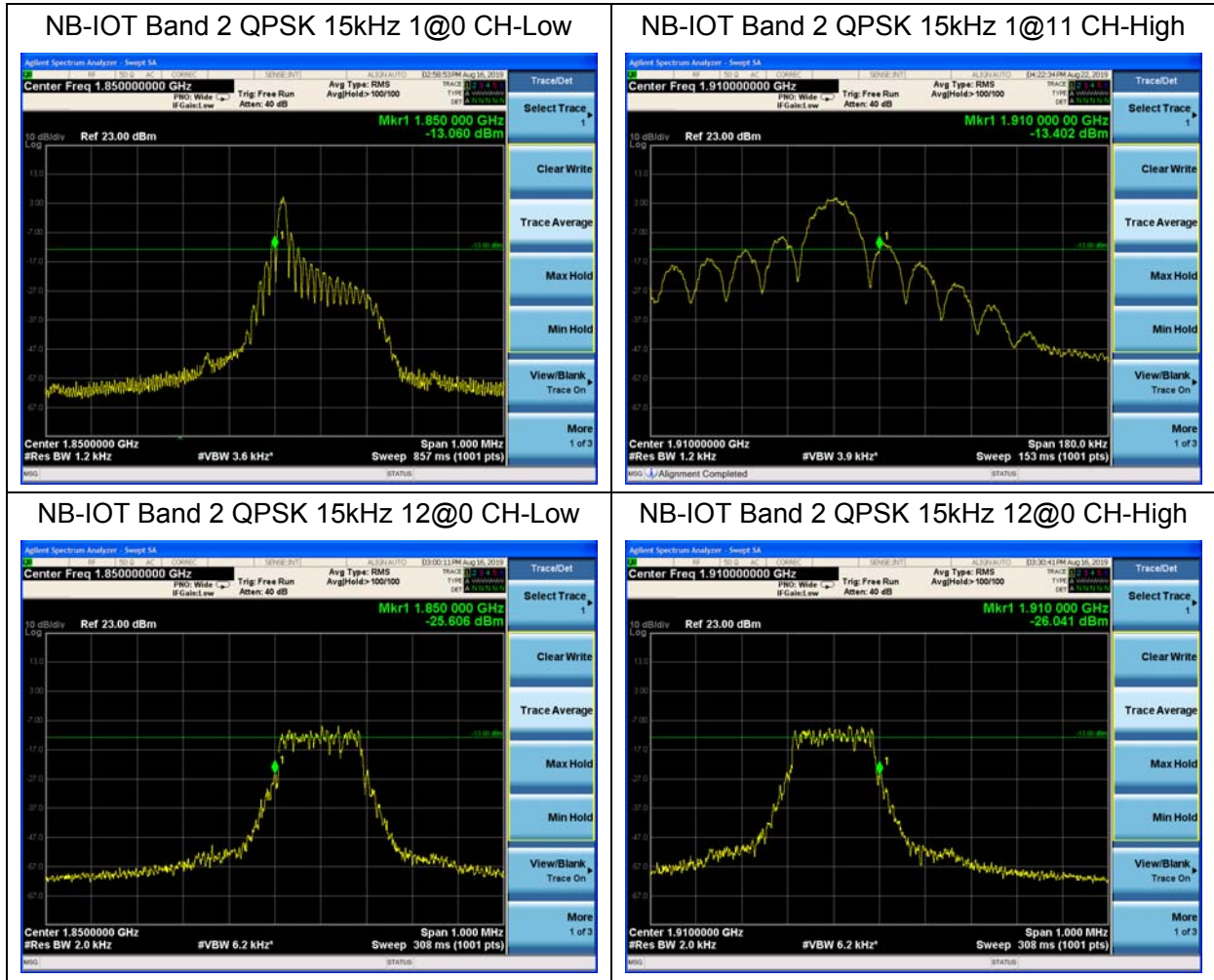

NB-IOT Band 25 BPSK 3.75kHz 1@0 CH-Low

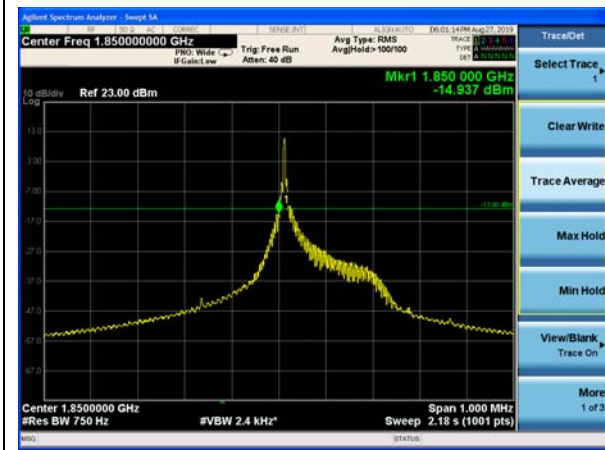

NB-IOT Band 25 BPSK 3.75kHz 1@47 CH-High

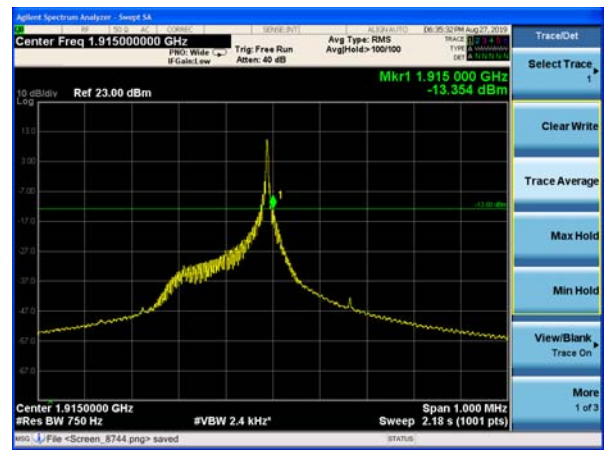

NB-IOT Band 25 BPSK 15kHz 1@0 CH-Low

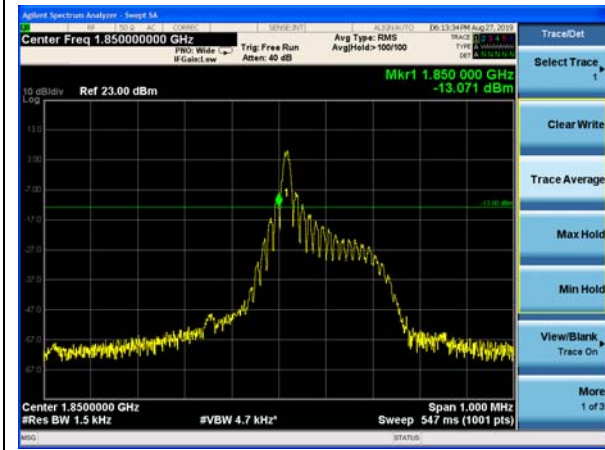

NB-IOT Band 25 BPSK 15kHz 1@11 CH-High



NB-IOT Band 25 QPSK 3.75kHz 1@0 CH-Low

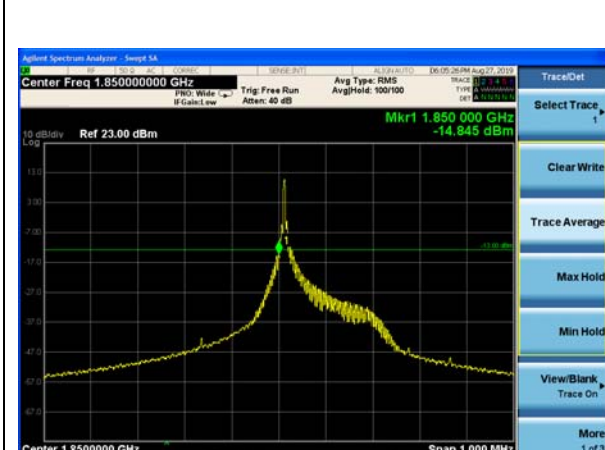

NB-IOT Band 25 QPSK 3.75kHz 1@47 CH-High

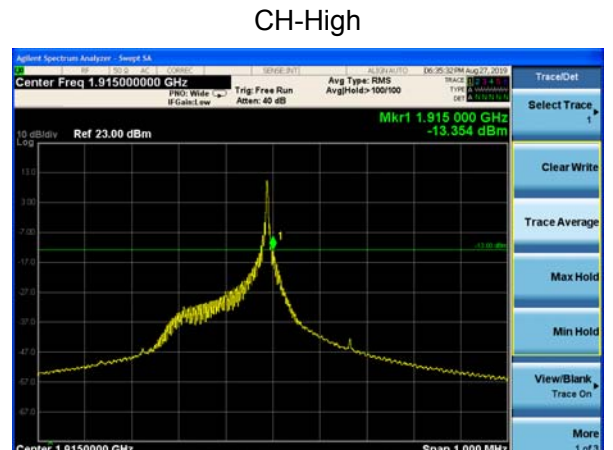



5.5. Peak-to-Average Power Ratio (PAPR)

Ambient condition

Temperature	Relative humidity	Pressure
23°C ~25°C	45%~50%	101.5kPa

Methods of Measurement

Measure the total peak power and record as PPk. And measure the total average power and record as PAvg. Both the peak and average power levels must be expressed in the same logarithmic units (e.g., dBm). Determine the PAPR from:

$$PAPR (dB) = PPk (dBm) - PAvg (dBm).$$

Test Setup

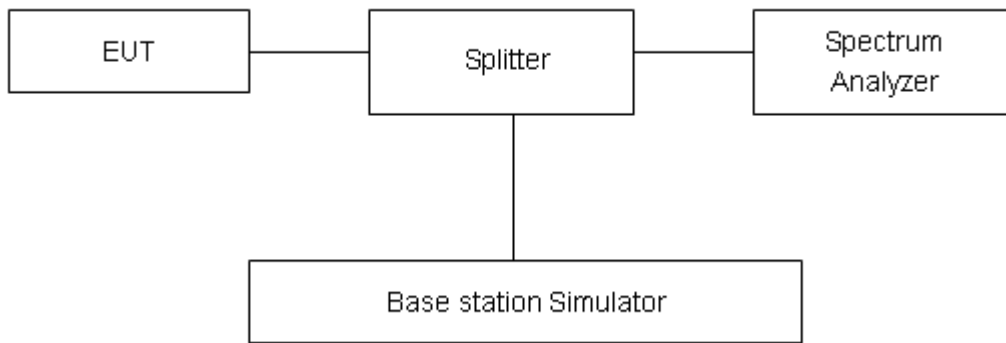

Limits

In measuring transmissions in this band using an average power technique, the peak-to-average ratio (PAR) of the transmission may not exceed 13 dB in 24.232(d).

Measurement Uncertainty

The assessed measurement uncertainty to ensure 95% confidence level for the normal distribution is with the coverage factor $k = 2$, $U = 0.4$ dB.

Test Results

Mode	Modulation	Sub-carrier spacing (KHz)	Channel/Frequency (MHz)	Peak-to-Average Power Ratio (PAPR)			Limit (dB)	Conclusion
				Peak(dBm)	Avg(dBm)	PAPR(dB)		
Band 2 Standalone	BPSK	3.75	18900/1880.0	21.62	17.76	3.86	≤13	PASS
	QPSK	3.75	18900/1880.0	21.19	17.75	3.44	≤13	PASS
	BPSK	15	18900/1880.0	21.91	15.55	6.36	≤13	PASS
	QPSK	15	18900/1880.0	21.84	15.41	6.43	≤13	PASS

Mode	Modulation	Sub-carrier spacing (KHz)	Channel/Frequency (MHz)	Peak-to-Average Power Ratio (PAPR)			Limit (dB)	Conclusion
				Peak(dBm)	Avg(dBm)	PAPR(dB)		
Band 25 Standalone	BPSK	3.75	26683/1882.5	21.52	17.67	3.85	≤13	PASS
	QPSK	3.75	26683/1882.5	21.04	17.61	3.43	≤13	PASS
	BPSK	15	26683/1882.5	21.60	15.13	6.47	≤13	PASS
	QPSK	15	26683/1882.5	21.53	15.16	6.37	≤13	PASS

5.6. Frequency Stability

Ambient condition

Temperature	Relative humidity	Pressure
23°C ~25°C	45%~50%	101.5kPa

Method of Measurement

Frequency Stability (Temperature Variation)

The temperature inside the climate chamber is varied from -40°C to +85°C in 10°C step size,

(1) With all power removed, the temperature was decreased to 0°C and permitted to stabilize for three hours.

(2) Measure the carrier frequency with the test equipment in a “call mode”. These measurements should be made within 1 minute of powering up the mobile station, to prevent significant self warming.

(3) Repeat the above measurements at 10°C increments from -40°C to +85°C. Allow at least 1.5 hours at each temperature, un-powered, before making measurements.

Frequency Stability (Voltage Variation)

The frequency stability shall be measured with variation of primary supply voltage as follows:

(1) Vary primary supply voltage from 85 to 115 percent of the nominal value for other than hand carried battery equipment.

(2) For hand carried, battery powered equipment, reduce primary supply voltage to the battery-operating end point which shall be specified by the manufacturer.

This transceiver is specified to operate with an input voltage of between 3.3 V and 4.3V, with a nominal voltage of 3.8V.

Test setup

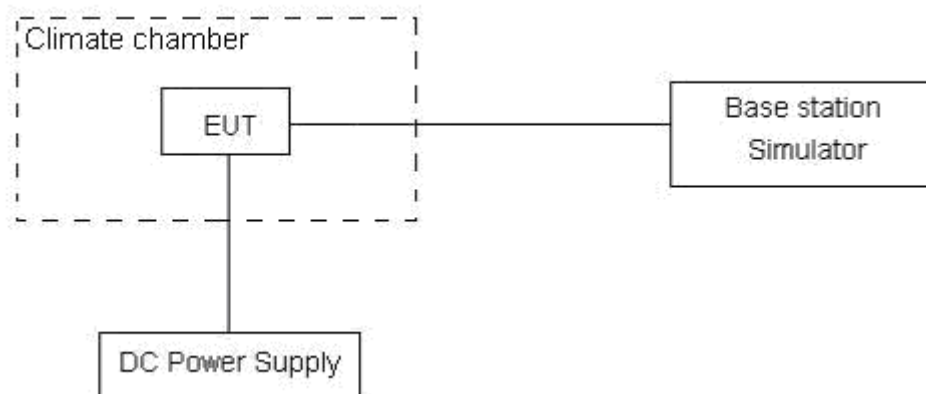

**Limits**

The frequency stability shall be sufficient to ensure that the fundamental emission stays within the authorized frequency block

Measurement Uncertainty

The assessed measurement uncertainty to ensure 99.75% confidence level for the normal distribution is with the coverage factor $k = 3$, $U = 0.01\text{ppm}$.



Test Result

NB-IOT Band 2						
Condition		Freq.Error (Hz)	Freq.Error (Hz)	Frequency Stability (ppm)	Frequency Stability (ppm)	Verdict
BANDWIDTH	3.75	BPSK	QPSK	BPSK	QPSK	
Temperature	Voltage					
Normal (25°C)	Normal	1.12	2.08	0.00059	0.00111	PASS
Extreme (85°C)		1.23	7.51	0.00066	0.00399	PASS
Extreme (80°C)		17.48	5.07	0.00930	0.00269	PASS
Extreme (70°C)		1.76	17.32	0.00094	0.00921	PASS
Extreme (60°C)		12.41	6.87	0.00660	0.00365	PASS
Extreme (50°C)		10.00	4.73	0.00532	0.00251	PASS
Extreme (40°C)		15.15	5.39	0.00806	0.00287	PASS
Extreme (30°C)		17.81	7.45	0.00947	0.00396	PASS
Extreme (20°C)		14.80	14.38	0.00787	0.00765	PASS
Extreme (10°C)		8.18	2.31	0.00435	0.00123	PASS
Extreme (0°C)		11.47	17.70	0.00610	0.00941	PASS
Extreme (-10°C)		15.22	17.25	0.00809	0.00917	PASS
Extreme (-20°C)		1.28	15.65	0.00068	0.00833	PASS
Extreme (-30°C)		11.69	1.74	0.00622	0.00092	PASS
Extreme (-40°C)		12.01	17.11	0.00639	0.00910	PASS
25°C	LV	11.31	8.61	0.00602	0.00458	PASS
	HV	14.24	7.82	0.00758	0.00416	PASS
Condition		Freq.Error (Hz)	Freq.Error (Hz)	Frequency Stability (ppm)	Frequency Stability (ppm)	Verdict
BANDWIDTH	15	BPSK	QPSK	BPSK	QPSK	
Temperature	Voltage					
Normal (25°C)	Normal	11.52	9.23	0.00613	0.00491	PASS
Extreme (85°C)		10.63	8.55	0.00565	0.00455	PASS
Extreme (80°C)		8.50	8.56	0.00452	0.00455	PASS
Extreme (70°C)		5.35	15.97	0.00285	0.00849	PASS
Extreme (60°C)		1.80	7.30	0.00096	0.00388	PASS
Extreme (50°C)		11.76	2.18	0.00625	0.00116	PASS
Extreme (40°C)		7.99	14.62	0.00425	0.00778	PASS
Extreme (30°C)		8.76	6.94	0.00466	0.00369	PASS
Extreme (20°C)		11.60	11.23	0.00617	0.00597	PASS
Extreme (10°C)		2.10	6.56	0.00112	0.00349	PASS
Extreme (0°C)		6.26	12.41	0.00333	0.00660	PASS
Extreme (-10°C)		3.75	10.77	0.00199	0.00573	PASS
Extreme (-20°C)		12.54	12.94	0.00667	0.00689	PASS
Extreme (-30°C)		4.34	2.08	0.00231	0.00111	PASS



Extreme (-40°C)		13.45	14.57	0.00715	0.00775	PASS
25°C	LV	15.69	7.32	0.00835	0.00390	PASS
	HV	17.41	13.46	0.00926	0.00716	PASS

NB-IOT Band 25						
Condition		Freq.Error (Hz)	Freq.Error (Hz)	Frequency Stability (ppm)	Frequency Stability (ppm)	Verdict
BANDWIDTH	3.75	BPSK	QPSK	BPSK	QPSK	
Temperature	Voltage					
Normal (25°C)	Normal	4.22	3.31	0.00225	0.00176	PASS
Extreme (85°C)		11.90	17.38	0.00633	0.00925	PASS
Extreme (80°C)		13.57	11.47	0.00722	0.00610	PASS
Extreme (70°C)		10.26	3.64	0.00546	0.00194	PASS
Extreme (60°C)		11.57	4.51	0.00615	0.00240	PASS
Extreme (50°C)		14.40	11.23	0.00766	0.00597	PASS
Extreme (40°C)		15.71	3.41	0.00835	0.00181	PASS
Extreme (30°C)		11.67	10.82	0.00621	0.00576	PASS
Extreme (20°C)		1.27	10.60	0.00068	0.00564	PASS
Extreme (10°C)		1.01	10.99	0.00054	0.00585	PASS
Extreme (0°C)		11.17	12.59	0.00594	0.00670	PASS
Extreme (-10°C)		14.67	11.49	0.00781	0.00611	PASS
Extreme (-20°C)		11.92	6.00	0.00634	0.00319	PASS
Extreme (-30°C)		3.31	11.49	0.00176	0.00611	PASS
Extreme (-40°C)		4.82	8.08	0.00256	0.00430	PASS
25°C	LV	15.30	7.86	0.00814	0.00418	PASS
	HV	15.73	1.28	0.00837	0.00068	PASS
Condition		Freq.Error (Hz)	Freq.Error (Hz)	Frequency Stability (ppm)	Frequency Stability (ppm)	Verdict
BANDWIDTH	15	BPSK	QPSK	BPSK	QPSK	
Temperature	Voltage					
Normal (25°C)	Normal	9.88	6.40	0.00526	0.00340	PASS
Extreme (85°C)		5.23	13.57	0.00278	0.00722	PASS
Extreme (80°C)		11.21	13.53	0.00596	0.00720	PASS
Extreme (70°C)		16.54	14.46	0.00880	0.00769	PASS
Extreme (60°C)		1.24	7.13	0.00066	0.00379	PASS
Extreme (50°C)		10.74	13.04	0.00571	0.00694	PASS
Extreme (40°C)		6.07	9.62	0.00323	0.00512	PASS
Extreme (30°C)		16.76	17.60	0.00891	0.00936	PASS
Extreme (20°C)		2.62	11.76	0.00139	0.00625	PASS
Extreme (10°C)		1.95	6.89	0.00104	0.00366	PASS
Extreme (0°C)		16.99	7.48	0.00904	0.00398	PASS



Extreme (-10°C)		5.21	13.82	0.00277	0.00735	PASS
Extreme (-20°C)		14.20	12.20	0.00755	0.00649	PASS
Extreme (-30°C)		3.36	1.21	0.00179	0.00064	PASS
Extreme (-40°C)		16.15	12.83	0.00859	0.00683	PASS
25°C	LV	10.17	10.96	0.00541	0.00583	PASS
	HV	12.36	14.36	0.00657	0.00764	PASS

5.7.Spurious Emissions at Antenna Terminals

Ambient condition

Temperature	Relative humidity	Pressure
23°C ~25°C	45%~50%	101.5kPa

Method of Measurement

The EUT was connected to Spectrum Analyzer and Base Station Simulator via power Splitter. The measurement is carried out using a spectrum analyzer. The spectrum analyzer scans from 9kHz to the 10th harmonic of the carrier. The peak detector is used.

RBW is set to 100kHz, VBW is set to 300kHz for 30MHz~1GHz

RBW is set to 1MHz, VBW is set to 3MHz for above 1GHz, Sweep is set to ATUO.

The modulation mode and RB allocation refer to section 5.1, using the maximum output power configuration.

Test setup

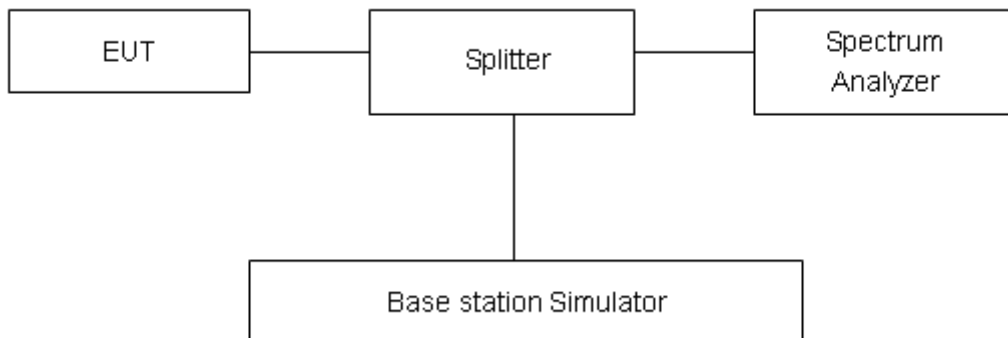

Limits

Rule Part 24.238(a) specifies that “on any frequency outside a licensee's frequency block, the power of any emission shall be attenuated below the transmitter power (P) by at least 43 + 10 log₁₀ (P) dB.”

Limit	-13 dBm
-------	---------

Measurement Uncertainty

The assessed measurement uncertainty to ensure 99.75% confidence level for the normal distribution is with the coverage factor $k = 1.96$.

Frequency	Uncertainty
9kHz-1GHz	0.684 dB
1GHz-20GHz	1.407 dB



Test Result

Sweep the whole frequency band through the range from 9kHz to the 10th harmonic of the carrier, the emissions more than 20 dB below the limit are not reported.

The signal beyond the limit is carrier.

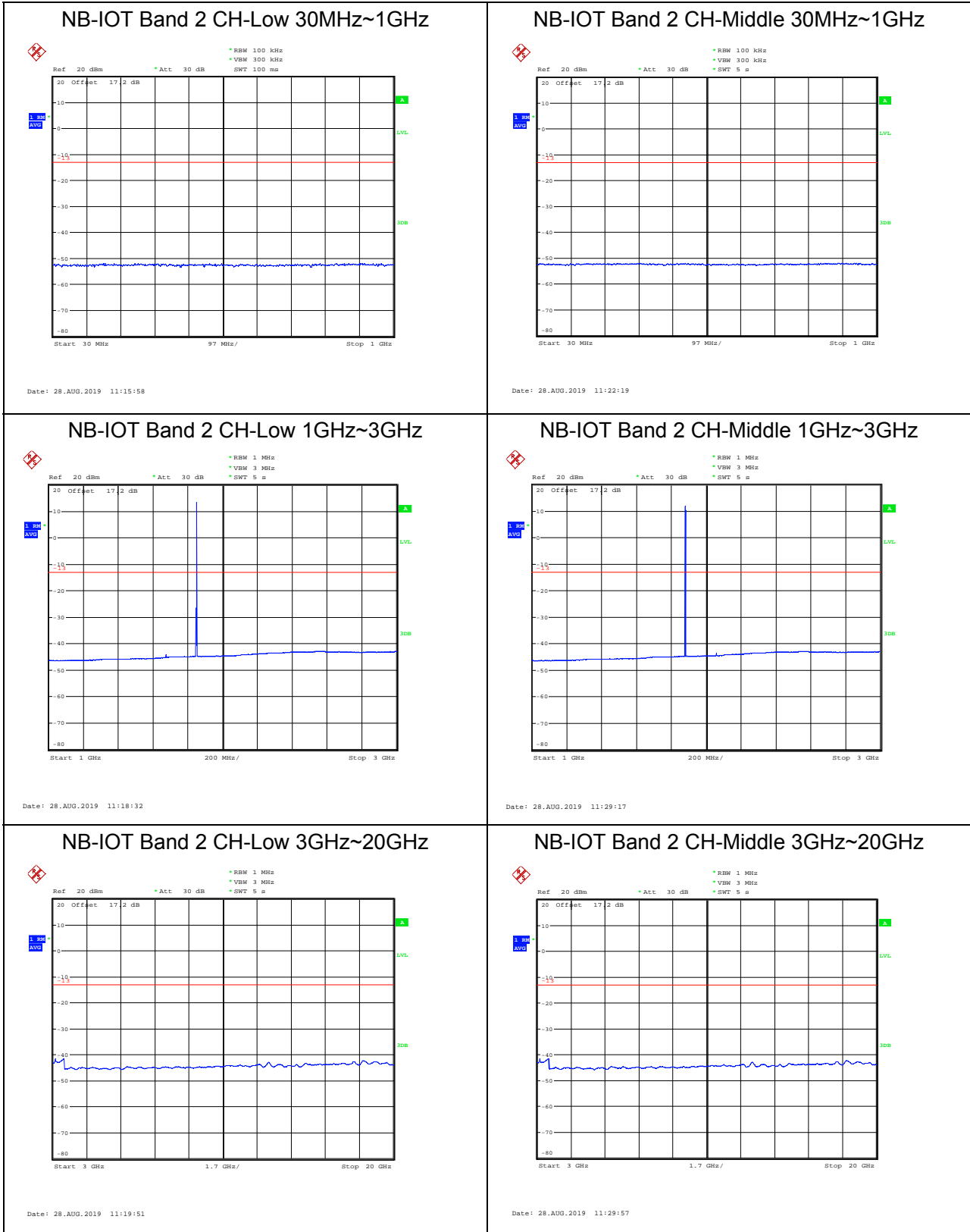



NB-IOT Band 2 CH-High 30MHz~1GHz

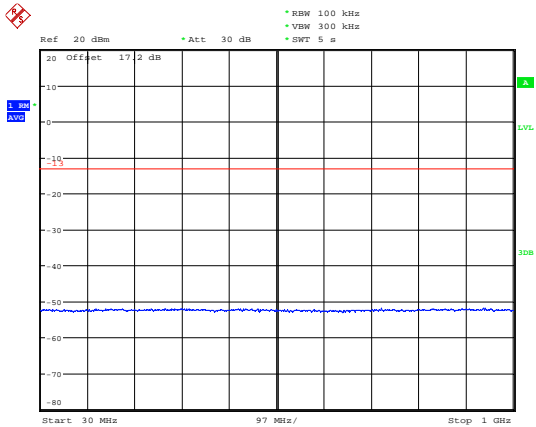

Date: 28.AUG.2019 11:31:53

NB-IOT Band 25 CH-Low 30MHz~1GHz

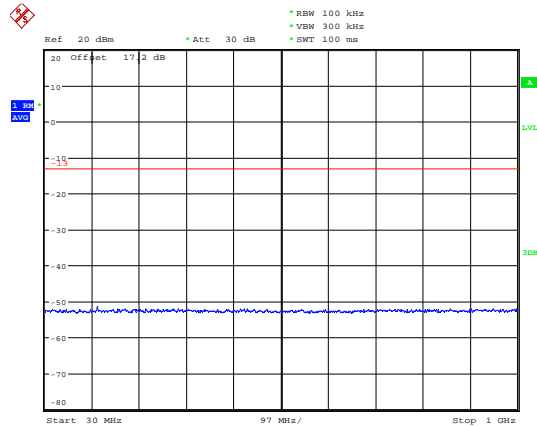

Date: 28.AUG.2019 11:43:33

NB-IOT Band 2 CH-High 1GHz~3GHz

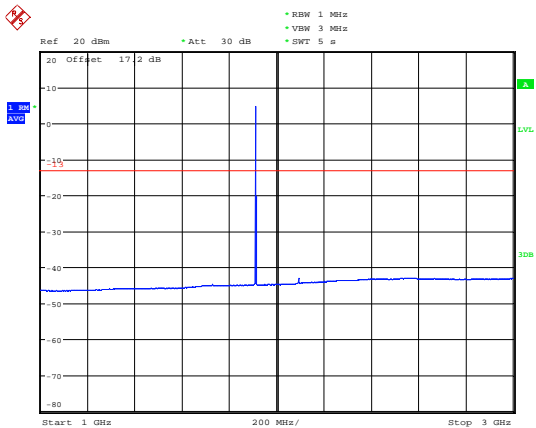

Date: 28.AUG.2019 11:32:40

NB-IOT Band 25 CH-Low 1GHz~3GHz

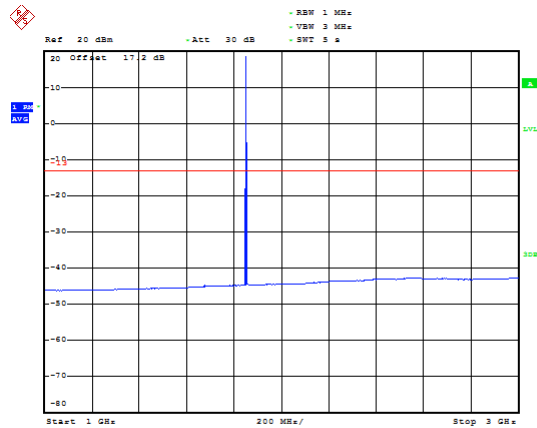

Date: 28.AUG.2019 13:18:47

NB-IOT Band 2 CH-High 3GHz~20GHz

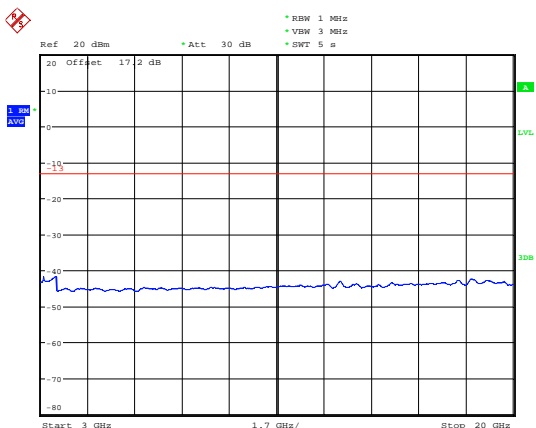

Date: 28.AUG.2019 11:33:11

NB-IOT Band 25 CH-Low 3GHz~20GHz

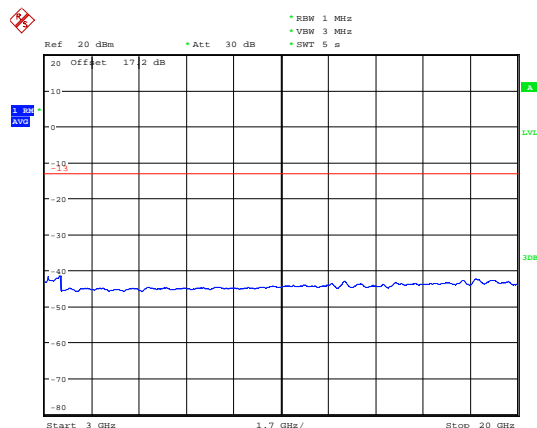

Date: 28.AUG.2019 13:24:43



NB-IOT Band 25 CH-Middle 30MHz~1GHz

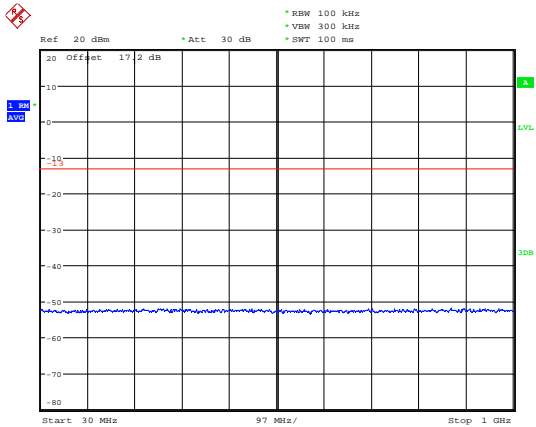

Date: 28.AUG.2019 11:49:10

NB-IOT Band 25 CH-High 30MHz~1GHz

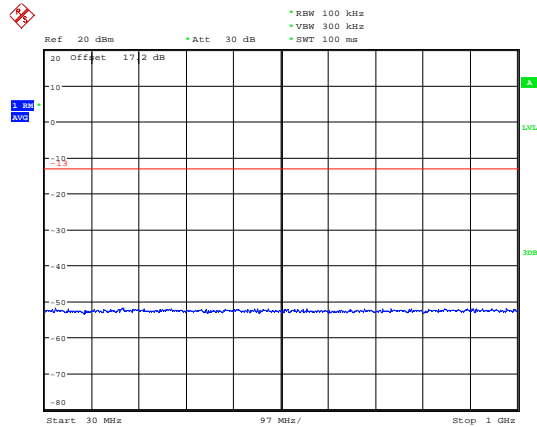

Date: 28.AUG.2019 11:50:58

NB-IOT Band 25 CH-Middle 1GHz~3GHz

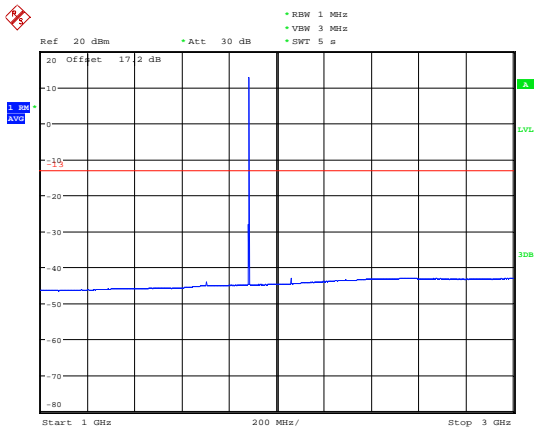

Date: 28.AUG.2019 13:22:17

NB-IOT Band 25 CH-High 1GHz~3GHz

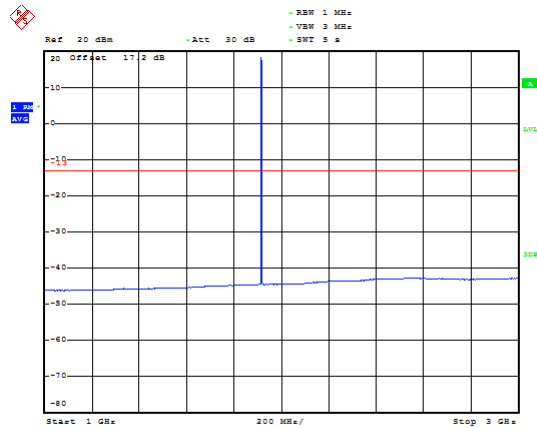

Date: 28.AUG.2019 13:23:21

NB-IOT Band 25 CH-Middle 3GHz~20GHz

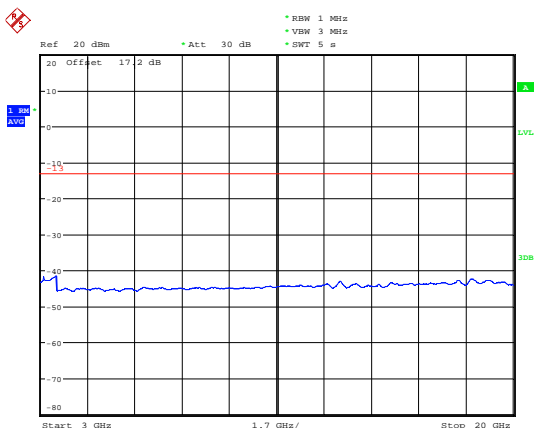

Date: 28.AUG.2019 13:30:52

NB-IOT Band 25 CH-High 3GHz~20GHz

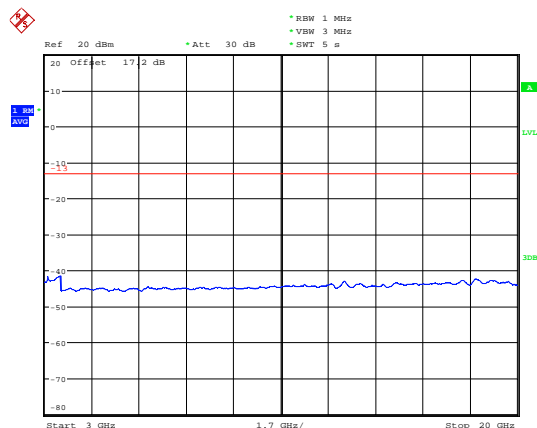

Date: 28.AUG.2019 13:31:32

5.8. Radiates Spurious Emission

Ambient condition

Temperature	Relative humidity	Pressure
23°C ~25°C	45%~50%	101.5kPa

Method of Measurement

- The testing follows FCC KDB 971168 v03r01 Section 5.8 and ANSI C63.26 (2015).
- Below 1GHz: The EUT is placed on a turntable 0.8 meters above the ground in the chamber, 3 meter away from the antenna. The maximal emission value is acquired by adjusting the antenna height, polarisation and turntable azimuth. Normally, the height range of antenna is 1 m to 4 m, the azimuth range of turntable is 0° to 360°, and the receive antenna has two polarizations Vertical (V) and Horizontal (H). Above 1GHz: (Note: the FCC's permission to use 1.5m as an alternative per TCBC Conf call of Dec. 2, 2014.) The EUT is placed on a turntable 1.5 meters above the ground in the chamber, 3 meter away from the antenna. The maximal emission value is acquired by adjusting the antenna height, polarisation and turntable azimuth. Normally, the height range of antenna is 1 m to 4 m, the azimuth range of turntable is 0° to 360°, and the receive antenna has two polarizations Vertical (V) and Horizontal (H).
- A loop antenna, A log-periodic antenna or horn antenna shall be substituted in place of the EUT. The log-periodic antenna will be driven by a signal generator and the level will be adjusted till the same power value on the spectrum analyzer or receiver. The level of the spurious emissions can be calculated through the level of the signal generator, cable loss, the gain of the substitution antenna and the reading of the spectrum analyzer or receiver.
- The EUT is then put into continuously transmitting mode at its maximum power level during the test. Set Test Receiver or Spectrum RBW=200Hz,VBW=600Hz for 9kHz150kHz , RBW=10kHz, VBW=30kHz 150kHz-30MHz , RBW=100kHz,VBW=300kHz for 30MHz to 1GHz and RBW=1MHz, VBW=3MHz for above 1GHz, And the maximum value of the receiver should be recorded as (Pr).
- The EUT shall be replaced by a substitution antenna. In the chamber, an substitution antenna for the frequency band of interest is placed at the reference point of the chamber. An RF Signal source for the frequency band of interest is connected to the substitution antenna with a cable that has been constructed to not interfere with the radiation pattern of the antenna. A power (PMea) is applied to the input of the substitution antenna, and adjust the level of the signal generator output until the value of the receiver reach the previously recorded (Pr). The power of signal source (PMea) is recorded. The test should be performed by rotating the test item and adjusting the receiving antenna polarization.
- A amplifier should be connected to the Signal Source output port. And the cable should be connect between the Amplifier and the Substitution Antenna. The cable loss (Pcl) ,the Substitution Antenna Gain (Ga) and the Amplifier Gain (PAg) should be recorded after test.
- The measurement results are obtained as described below:

$$\text{Power(EIRP)} = \text{PMea} - \text{PAg} - \text{Pcl} + \text{Ga}$$
 The measurement results are amend as described below:

$$\text{Power(EIRP)} = \text{PMea} - \text{Pcl} + \text{Ga}$$
- This value is EIRP since the measurement is calibrated using an antenna of known gain (2.15 dBi)

and known input power. ERP can be calculated from EIRP by subtracting the gain of the dipole, $ERP = EIRP - 2.15\text{dBi}$.

The modulation mode and RB allocation refer to section 5.1, using the maximum output power configuration.

Test setup

9KHz ~ 30MHz

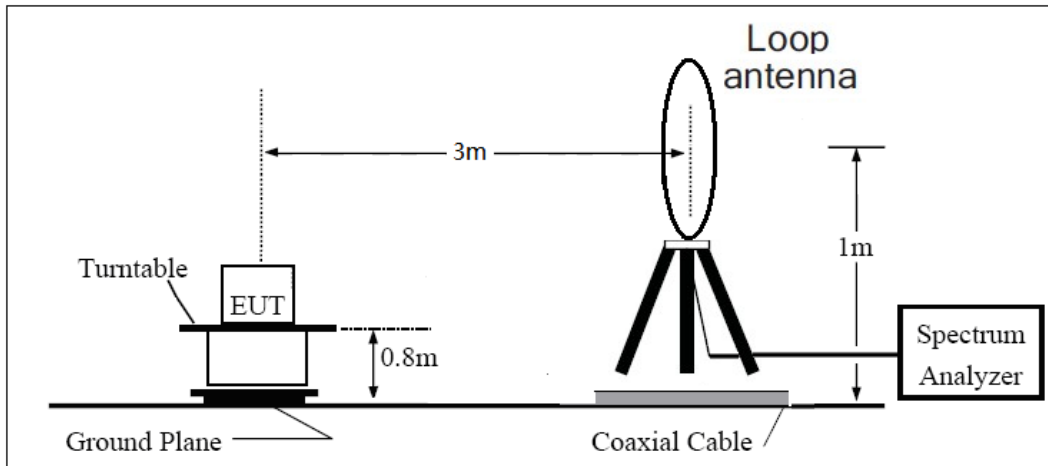

30MHz ~ 1GHz

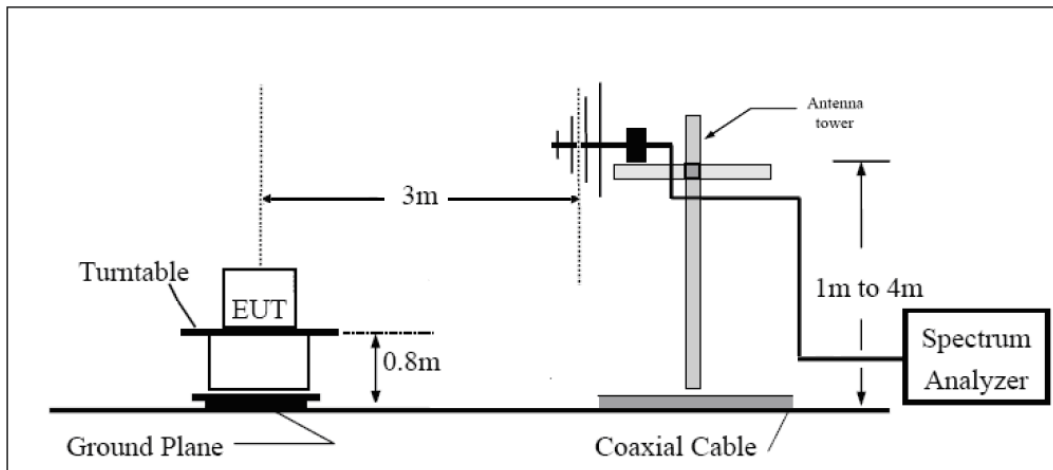

Above 1GHz

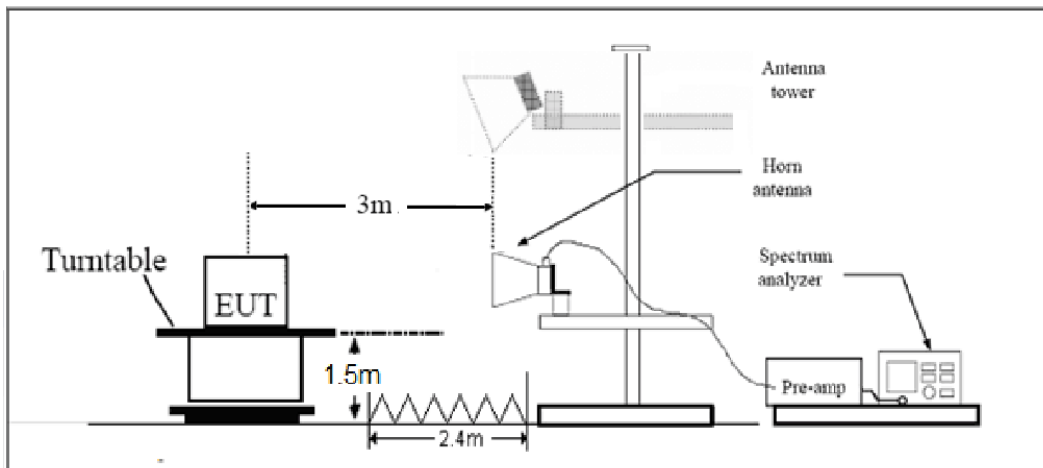



Note: Area side: 2.4mX3.6m

Limits

Rule Part 24.238(a) specifies that “on any frequency outside a licensee's frequency block, the power of any emission shall be attenuated below the transmitter power (P) by at least $43 + 10 \log_{10} (P)$ dB.”

Limit	-13 dBm
-------	---------

Measurement Uncertainty

The assessed measurement uncertainty to ensure 95% confidence level for the normal distribution is with the coverage factor $k = 1.96$, $U = 3.55$ dB.

Test Result

Sweep the whole frequency band through the range from 9kHz to the 10th harmonic of the carrier, the emissions below the noise floor will not be recorded in the report.

NB-IOT Band 2 CH-Low

Harmonic	Frequency (MHz)	SG (dBm)	Cable Loss (dB)	Gain (dBi)	Antenna Polarization	EIRP Level (dBm)	Limit (dBm)	Margin (dB)	Azimuth (deg)
2	3700.5	-58.36	5.10	11.05	Horizontal	-52.41	-13.00	39.41	225
3	5550.8	-56.43	5.42	12.65	Horizontal	-49.20	-13.00	36.20	180
4	7402.8	-54.65	6.70	13.85	Horizontal	-47.50	-13.00	34.50	180
5	9253.5	-52.94	7.01	14.75	Horizontal	-45.20	-13.00	32.20	90
6	11104.2	-52.97	7.48	15.95	Horizontal	-44.50	-13.00	31.50	45
7	12954.9	-52.84	7.51	16.55	Horizontal	-43.80	-13.00	30.80	90
8	14805.6	-48.71	8.24	15.35	Horizontal	-41.60	-13.00	28.60	135
9	16656.3	-47.44	8.41	14.95	Horizontal	-40.90	-13.00	27.90	180
10	18507.0	--	--	--	--	--	--	--	--

Note: 1.The other Spurious RF Radiated emissions level is no more than noise floor.
 2. The worst emission was found in the antenna is Horizontal position.

NB-IOT Band 2 CH-Middle

Harmonic	Frequency (MHz)	SG (dBm)	Cable Loss (dB)	Gain (dBi)	Antenna Polarization	EIRP Level (dBm)	Limit (dBm)	Margin (dB)	Azimuth (deg)
2	3759.8	-57.81	5.10	11.05	Horizontal	-51.86	-13.00	38.86	315
3	5638.9	-57.09	5.42	12.65	Horizontal	-49.86	-13.00	36.86	135
4	7520.0	-55.06	6.70	13.85	Horizontal	-47.91	-13.00	34.91	225
5	9400.0	-53.63	7.01	14.75	Horizontal	-45.89	-13.00	32.89	90
6	11280.0	-52.95	7.48	15.95	Horizontal	-44.48	-13.00	31.48	90
7	13160.0	-52.04	7.51	16.55	Horizontal	-43.00	-13.00	30.00	45
8	15040.0	-48.62	8.24	15.35	Horizontal	-41.51	-13.00	28.51	270
9	16920.0	-47.37	8.41	14.95	Horizontal	-40.83	-13.00	27.83	315
10	18800.0	--	--	--	--	--	--	--	--

Note: 1.The other Spurious RF Radiated emissions level is no more than noise floor.
 2. The worst emission was found in the antenna is Horizontal position.

NB-IOT Band 2 CH-High

Harmonic	Frequency (MHz)	SG (dBm)	Cable Loss (dB)	Gain (dBi)	Antenna Polarization	EIRP Level (dBm)	Limit (dBm)	Margin (dB)	Azimuth (deg)
2	3817.5	-57.21	5.10	11.05	Horizontal	-51.26	-13.00	38.26	180
3	5726.6	-56.53	5.42	12.65	Horizontal	-49.30	-13.00	36.30	180
4	7637.2	-54.37	6.70	13.85	Horizontal	-47.22	-13.00	34.22	90
5	9546.5	-52.84	7.01	14.75	Horizontal	-45.10	-13.00	32.10	45
6	11455.8	-52.72	7.48	15.95	Horizontal	-44.25	-13.00	31.25	90
7	13365.1	-52.95	7.51	16.55	Horizontal	-43.91	-13.00	30.91	135
8	15274.4	-48.41	8.24	15.35	Horizontal	-41.30	-13.00	28.30	180
9	17183.7	-46.79	8.41	14.95	Horizontal	-40.25	-13.00	27.25	45
10	19093.0	--	--	--	--	--	--	--	--

Note: 1.The other Spurious RF Radiated emissions level is no more than noise floor.
2. The worst emission was found in the antenna is Horizontal position.

NB-IOT Band 25 CH-Low

Harmonic	Frequency (MHz)	SG (dBm)	Cable Loss (dB)	Gain (dBi)	Antenna Polarization	EIRP Level (dBm)	Limit (dBm)	Margin (dB)	Azimuth (deg)
2	3700.13	-60.88	5.10	11.05	Horizontal	-54.93	-13.00	41.93	180
3	5550.38	-61.83	5.42	12.65	Horizontal	-54.60	-13.00	41.60	90
4	7230.00	-57.45	6.70	13.85	Horizontal	-50.30	-13.00	37.30	45
5	9255.38	-55.84	7.01	14.75	Horizontal	-48.10	-13.00	35.10	90
6	11109.37	-53.97	7.48	15.95	Horizontal	-45.50	-13.00	32.50	135
7	12942.0	-53.91	7.51	16.55	Horizontal	-44.87	-13.00	31.87	180
8	14831.63	-51.82	8.24	15.35	Horizontal	-44.71	-13.00	31.71	90
9	16666.50	-49.09	8.41	14.95	Horizontal	-42.55	-13.00	29.55	45
10	18515.00	--	--	--	--	--	--	--	--

Note: 1.The other Spurious RF Radiated emissions level is no more than noise floor.
2. The worst emission was found in the antenna is Horizontal position.



NB-IOT Band 25 CH-Middle

Harmonic	Frequency (MHz)	SG (dBm)	Cable Loss (dB)	Gain (dBi)	Antenna Polarization	EIRP Level (dBm)	Limit (dBm)	Margin (dB)	Azimuth (deg)
2	3764.63	-62.76	5.10	11.05	Horizontal	-56.81	-13.00	43.81	180
3	5647.50	-62.50	5.42	12.65	Horizontal	-55.27	-13.00	42.27	90
4	7444.88	-57.34	6.70	13.85	Horizontal	-50.19	-13.00	37.19	45
5	9459.75	-56.07	7.01	14.75	Horizontal	-48.33	-13.00	35.33	90
6	11296.50	-54.92	7.48	15.95	Horizontal	-46.45	-13.00	33.45	135
7	13294.50	-54.73	7.51	16.55	Horizontal	-45.69	-13.00	32.69	180
8	14991.38	-54.92	8.24	15.35	Horizontal	-47.81	-13.00	34.81	90
9	16900.80	-48.31	8.41	14.95	Horizontal	-41.77	-13.00	28.77	45
10	18800.00	--	--	--	--	--	--	--	--

Note: 1. The other Spurious RF Radiated emissions level is no more than noise floor.

2. The worst emission was found in the antenna is Horizontal position.

NB-IOT Band 25 CH-High

Harmonic	Frequency (MHz)	SG (dBm)	Cable Loss (dB)	Gain (dBi)	Antenna Polarization	EIRP Level (dBm)	Limit (dBm)	Margin (dB)	Azimuth (deg)
2	3829.50	-62.62	5.10	11.05	Horizontal	-56.67	-13.00	43.67	180
3	5743.88	-62.42	5.42	12.65	Horizontal	-55.19	-13.00	42.19	315
4	7659.60	-57.86	6.70	13.85	Horizontal	-50.71	-12.00	38.71	0
5	9570.75	-56.33	7.01	14.75	Horizontal	-48.59	-13.00	35.59	135
6	11503.13	-53.79	7.48	15.95	Horizontal	-45.32	-13.00	32.32	225
7	13398.30	-53.02	7.51	16.55	Horizontal	-43.98	-13.00	30.98	90
8	15316.50	-52.83	8.24	15.35	Horizontal	-45.72	-13.00	32.72	135
9	17247.30	-49.93	8.41	14.95	Horizontal	-43.39	-13.00	30.39	45
10	19085.00	--	--	--	--	--	--	--	--

Note: 1. The other Spurious RF Radiated emissions level is no more than noise floor.

2. The worst emission was found in the antenna is Horizontal position.

6. Main Test Instruments

Name	Manufacturer	Type	Serial Number	Calibration Date	Expiration Date
Base Station Simulator	R&S	CMU200	118133	2019-05-19	2020-05-18
Base Station Simulator	R&S	CMW500	113824	2019-05-19	2020-05-18
Power Splitter	Hua Xiang	SHX-GF2-2-13	10120101	/	/
Spectrum Analyzer	Key sight	N9010A	MY50210259	2019-05-19	2020-05-18
Universal Radio Communication Tester	Key sight	E5515C	MY48367192	2019-05-19	2020-05-18
Signal Analyzer	R&S	FSV30	100815	2018-12-16	2019-12-15
Loop Antenna	SCHWARZBECK	FMZB1519	1519-047	2017-09-26	2019-09-25
Trilog Antenna	SCHWARZBECK	VUBL 9163	9163-201	2017-11-18	2019-11-17
Horn Antenna	R&S	HF907	100126	2018-07-07	2020-07-06
Horn Antenna	ETS-Lindgren	3160-09	00102643	2018-06-20	2020-06-19
Signal generator	R&S	SMB 100A	102594	2019-05-19	2020-05-18
Climatic Chamber	ESPEC	SU-242	93000506	2017-12-17	2020-12-16
Preampflier	R&S	SCU18	102327	2019-05-19	2020-05-18
MOB COMMS DC SUPPLY	Keysight	66319D	MY43004105	2019-05-19	2020-05-18
RF Cable	Agilent	SMA 15cm	0001	2019-06-14	2019-09-13
Software	R&S	EMC32	9.26.0	/	/
Wireless Test Set	StarPoint	SP8315	SP8315-1202	2019-05-19	2020-05-18
Wireless Test Set	StarPoint	SP8315	SP8315-1203	2019-05-19	2020-05-18

*****END OF REPORT *****