



FCC RADIO TEST REPORT

FCC ID: AMB-JN7

Product : Wireless USB Adapter

Trade Name : BearExtender

Model Name : JN7

Serial Model : N/A

Report No. : BZT13081512ER

Prepared for

BearExtender

1406 Henry Street, Berkeley, California, 94709, USA

Prepared by

BZT Testing Technology Co., Ltd

Add. : 1/F, Building E, Fenda Science Park, Sanwei Community, Xixiang Street, Bao'an District,
Shenzhen P.R. China.

TEST RESULT CERTIFICATION

Applicant's name : BearExtender
 Address : 1406 Henry Street, Berkeley, California, 94709, USA
Manufacture's Name : HK YUNLINK TECHNOLOGY LTD
 Address : A9 Building, Longwangmiao Industrial Zone, Baishixia
 East,Fuyong Town, Baoan, Shenzhen Guangdong Province China

Product description

Product name..... : Wireless USB Adapter
 Model and/or type reference : JN7
 Serial Model : N/A
 DIFF : N/A

Standards : FCC Part15.247

Test procedure ANSI C63.4-2003

This device described above has been tested by BZT, and the test results show that the equipment under test (EUT) is in compliance with the FCC requirements. And it is applicable only to the tested sample identified in the report.

This report shall not be reproduced except in full, without the written approval of BZT, this document may be altered or revised by BZT, personal only, and shall be noted in the revision of the document.

Date of Test :
 Date (s) of performance of tests : 10 August. 2013 ~14 August. 2013
 Date of Issue..... : 15 August. 2013
 Test Result..... : **Pass**

Testing Engineer : Apple Huang
 (Apple Huang)

Technical Manager : Tom Zhang
 (Tom Zhang)

Authorized Signatory : Bovey Yang
 (Bovey Yang)

Table of Contents

	Page
1 . SUMMARY OF TEST RESULTS	5
1.1 TEST FACILITY	6
1.2 MEASUREMENT UNCERTAINTY	6
2 . GENERAL INFORMATION	7
2.1 GENERAL DESCRIPTION OF EUT	7
2.2 DESCRIPTION OF TEST MODES	9
2.3 BLOCK DIGRAM SHOWING THE CONFIGURATION OF SYSTEM TESTED	10
2.4 DESCRIPTION OF SUPPORT UNITS(CONDUCTED MODE)	11
2.5 EQUIPMENTS LIST FOR ALL TEST ITEMS	12
3 . EMC EMISSION TEST	13
3.1 CONDUCTED EMISSION MEASUREMENT	13
3.1.1 POWER LINE CONDUCTED EMISSION LIMITS	13
3.1.2 TEST PROCEDURE	14
3.1.3 DEVIATION FROM TEST STANDARD	14
3.1.4 TEST SETUP	14
3.1.5 EUT OPERATING CONDITIONS	14
3.1.6 TEST RESULTS	15
3.2 RADIATED EMISSION MEASUREMENT	17
3.2.1 RADIATED EMISSION LIMITS	17
3.2.2 TEST PROCEDURE	18
3.2.3 DEVIATION FROM TEST STANDARD	18
3.2.4 TEST SETUP	19
3.2.5 EUT OPERATING CONDITIONS	20
3.2.6 TEST RESULTS (BETWEEN 9KHZ – 30 MHZ)	21
3.2.7 TEST RESULTS (BETWEEN 30MHZ – 1GHZ)	22
3.2.8 TEST RESULTS (ABOVE 1000 MHZ)	24
3.2.9 TEST RESULTS (RESTRICTED BANDS REQUIREMENTS)	36
4 . POWER SPECTRAL DENSITY TEST	52
4.1 APPLIED PROCEDURES / LIMIT	52
4.1.1 TEST PROCEDURE	52
4.1.2 DEVIATION FROM STANDARD	52
4.1.3 TEST SETUP	52
4.1.4 EUT OPERATION CONDITIONS	52
4.1.5 TEST RESULTS	53
5 . BANDWIDTH TEST	61
5.1 APPLIED PROCEDURES / LIMIT	61

Table of Contents		Page
5.1.1 TEST PROCEDURE		61
5.1.2 DEVIATION FROM STANDARD		61
5.1.3 TEST SETUP		61
5.1.4 EUT OPERATION CONDITIONS		61
5.1.5 TEST RESULTS		62
6 . PEAK OUTPUT POWER TEST		70
6.1 APPLIED PROCEDURES / LIMIT		70
6.1.1 TEST PROCEDURE		70
6.1.2 DEVIATION FROM STANDARD		70
6.1.3 TEST SETUP		70
6.1.4 EUT OPERATION CONDITIONS		70
6.1.5 TEST RESULTS		71
7 . ANTENNA REQUIREMENT		72
7.1 STANDARD REQUIREMENT		72
7.2 EUT ANTENNA		72
8 . EUT TEST PHOTO		73
APPENDIX-PHOTOGRAPHS OF EUT CONSTRUCTIONAL DETAILS		

1. SUMMARY OF TEST RESULTS

Test procedures according to the technical standards:

FCC Part15 (15.247) , Subpart C			
Standard Section	Test Item	Judgment	Remark
15.207	Conducted Emission	PASS	
15.247 (a)(2)	6dB Bandwidth	PASS	
15.247 (b)	Peak Output Power	PASS	
15.247 (c)	Radiated Spurious Emission	PASS	
15.247 (d)	Power Spectral Density	PASS	
15.205	Band Edge Emission	PASS	
15.203	Antenna Requirement	PASS	

NOTE:

(1) "N/A" denotes test is not applicable in this Test Report

1.1 TEST FACILITY

BZT Testing Technology Co., Ltd

Add.:1/F, Building E, Fenda Science Park, Sanwei Community, Xixiang Street, Bao'an District, Shenzhen P.R. China.

FCC Registration No.: 701733

1.2 MEASUREMENT UNCERTAINTY

The reported uncertainty of measurement $y \pm U$, where expanded uncertainty U is based on a standard uncertainty multiplied by a coverage factor of $k=2$, providing a level of confidence of approximately **95 %**.

No.	Item	Uncertainty
1	Conducted Emission Test	$\pm 1.38\text{dB}$
2	RF power,conducted	$\pm 0.16\text{dB}$
3	Spurious emissions,conducted	$\pm 0.21\text{dB}$
4	All emissions,radiated(<1G)	$\pm 4.68\text{dB}$
5	All emissions,radiated(>1G)	$\pm 4.89\text{dB}$
6	Temperature	$\pm 0.5^{\circ}\text{C}$
7	Humidity	$\pm 2\%$

2. GENERAL INFORMATION

2.1 GENERAL DESCRIPTION OF EUT

Equipment	Wireless USB Adapter	
Trade Name	BearExtender	
Model Name	JN7	
Serial Model	N/A	
Model Difference	N/A	
Product Description	The EUT is a Wireless USB Adapter	
	Operation Frequency:	802.11b/g/n 20:2412~2462 MHz 802.11n 40: 2422~2452MHz
	Modulation Type:	CCK/OFDM/DBPSK/DAPSK
	Bit Rate of Transmitter	802.11b:11/5.5/2/1 Mbps 802.11g:54/48/36/24/18/12/9/6Mbps 802.11n(20/40MHz):300/150/144.44/130/117/115.56/104/86.67/78/52/6.5 Mbps
	Number Of Channel	802.11b/g/n20: 11CH 802.11n 40: 7CH
	Antenna Designation:	Please see Note 3.
	Peak Output Power(Conducted):	802.11b: 25.42 dBm (Max.) 802.11g: 24.81 dBm (Max.) 802.11n(20MHz): 23.18 dBm (Max.) 802.11n(40MHz): 20.21 dBm (Max.)
	Antenna Gain (dBi)	1.5 dBi
	Based on the application, features, or specification exhibited in User's Manual, the EUT is considered as an ITE/Computing Device. More details of EUT technical specification, please refer to the User's Manual.	
	Channel List	Please refer to the Note 2.
Ratings	DC 5V from PC with AC 120V/60Hz	
Adapter	N/A	
Battery	N/A	
Connecting I/O Port(s)	Please refer to the User's Manual	

Note:

1. For a more detailed features description, please refer to the manufacturer's specifications or the User's Manual.

2.

Channel List for 802.11b/g/n(20MHz)							
Channel	Frequency (MHz)	Channel	Frequency (MHz)	Channel	Frequency (MHz)	Channel	Frequency (MHz)
01	2412	04	2427	07	2442	10	2457
02	2417	05	2432	08	2447	11	2462
03	2422	06	2437	09	2452		

Channel List for 802.11n(40MHz)							
Channel	Frequency (MHz)	Channel	Frequency (MHz)	Channel	Frequency (MHz)	Channel	Frequency (MHz)
03	2422	06	2437	09	2452		
04	2427	07	2442				
05	2432	08	2447				

3.

Table for Filed Antenna

Ant	Brand	Model Name	Antenna Type	Connector	Gain (dBi)	NOTE
A	N/A	N/A	Reverse SMA connector	N/A	1.5	N/A

2.2 DESCRIPTION OF TEST MODES

To investigate the maximum EMI emission characteristics generates from EUT, the test system was pre-scanning tested base on the consideration of following EUT operation mode or test configuration mode which possible have effect on EMI emission level. Each of these EUT operation mode(s) or test configuration mode(s) mentioned above was evaluated respectively.

Pretest Mode	Description
Mode 1	802.11b CH1/ CH6/ CH11
Mode 2	802.11g CH1/ CH6/ CH11
Mode 3	802.11n(20)CH1/ CH6/ CH11
Mode 4	802.11n(40) CH3/ CH6/ CH9
Mode 5	Link Mode

For Conducted Emission	
Final Test Mode	Description
Mode 5	Link Mode

For Radiated Emission	
Final Test Mode	Description
Mode 1	802.11b CH1/ CH6/ CH11
Mode 2	802.11g CH1/ CH6/ CH11
Mode 3	802.11n CH1/ CH6/ CH11
Mode 4	802.11n(40) CH3/ CH6/ CH9
Mode 5	Link Mode

Note:

- (1) The measurements are performed at the highest, middle, lowest available channels.
- (2) The measurements are performed at all Bit Rate of Transmitter, the worst data was reported

2.3 BLOCK DIGRAM SHOWING THE CONFIGURATION OF SYSTEM TESTED

Conducted Measurement:

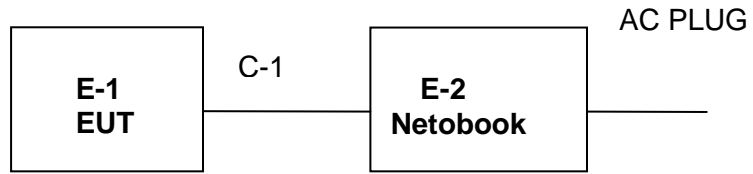

Radiated Measurement:

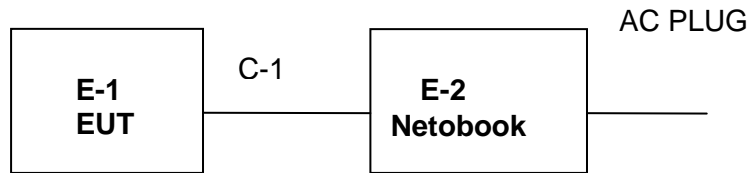

2.4 DESCRIPTION OF SUPPORT UNITS(CONDUCTED MODE)

The EUT has been tested as an independent unit together with other necessary accessories or support units. The following support units or accessories were used to form a representative test configuration during the tests.

Item	Equipment	Mfr/Brand	Model/Type No.	Series No.	Note
E-1	Wireless USB Adapter	N/A	JN7	N/A	EUT
E-2	Notebook	Acer	455G	N/A	

Item	Shielded Type	Ferrite Core	Length	Note
C-1	NO	NO	1.4m	Usb cable

Note:

- (1) The support equipment was authorized by Declaration of Confirmation.
- (2) For detachable type I/O cable should be specified the length in cm in 『Length』 column.

2.5 EQUIPMENTS LIST FOR ALL TEST ITEMS**Radiation Test equipment**

Item	Kind of Equipment	Manufacturer	Type No.	Serial No.	Calibrated until
1	Spectrum Analyzer	Agilent	E4407B	160400005	Jul. 06. 2014
2	Test Receiver	R&S	ESPI	101318	Jul. 06. 2014
3	Bilog Antenna	TESEQ	CBL6111D	31216	Mar.12. 2014
4	50Ω Coaxial Switch	Anritsu	MP59B	6200264416	Jul. 06. 2014
5	Spectrum Analyzer	ADVANTEST	R3132	150900201	Jul. 06. 2014
6	Horn Antenna	EM	EM-AH-10180	2011071402	Mar.12. 2014
7	Horn Ant	Schwarzbeck	BBHA 9170	9170-181	Mar.12. 2014
8	Amplifier	EM	EM-30180	060538	Jul. 06. 2014
9	Loop Antenna	ARA	PLA-1030/B	1029	Mar.12. 2014
10	Power Meter	R&S	NRVS	100696	Jul. 06. 2014
11	Power Sensor (Peak)	R&S	NRV-Z31	0396.0101.1 9	Jul. 06. 2014

Conduction Test equipment

Item	Kind of Equipment	Manufacturer	Type No.	Serial No.	Calibrated until
1	Test Receiver	R&S	ESCI	101160	Jul. 06. 2014
2	LISN	R&S	ENV216	101313	Jul. 06. 2014
3	LISN	EMCO	3816/2	00042990	Jul. 06. 2014
4	50Ω Coaxial Switch	Anritsu	MP59B	6200264417	Jul. 06. 2014
5	Passive Voltage Probe	R&S	ESH2-Z3	100196	Jul. 06. 2014
6	Absorbing clamp	R&S	MOS-21	100423	Jul. 06. 2014

3. EMC EMISSION TEST

3.1 CONDUCTED EMISSION MEASUREMENT

3.1.1 POWER LINE CONDUCTED EMISSION Limits (Frequency Range 150KHz-30MHz)

FREQUENCY (MHz)	Class A (dBuV)		Class B (dBuV)		Standard
	Quasi-peak	Average	Quasi-peak	Average	
0.15 -0.5	79.00	66.00	66 - 56 *	56 - 46 *	CISPR
0.50 -5.0	73.00	60.00	56.00	46.00	CISPR
5.0 -30.0	73.00	60.00	60.00	50.00	CISPR

0.15 -0.5	79.00	66.00	66 - 56 *	56 - 46 *	FCC
0.50 -5.0	73.00	60.00	56.00	46.00	FCC
5.0 -30.0	73.00	60.00	60.00	50.00	FCC

Note:

- (1) The tighter limit applies at the band edges.
- (2) The limit of " * " marked band means the limitation decreases linearly with the logarithm of the frequency in the range.

The following table is the setting of the receiver

Receiver Parameters	Setting
Attenuation	10 dB
Start Frequency	0.15 MHz
Stop Frequency	30 MHz
IF Bandwidth	9 kHz

3.1.2 TEST PROCEDURE

- The EUT was placed 0.4 meters from the horizontal ground plane with EUT being connected to the power mains through a line impedance stabilization network (LISN). All other support equipments powered from additional LISN(s). The LISN provide 50 Ohm/ 50uH of coupling impedance for the measuring instrument.
- Interconnecting cables that hang closer than 40 cm to the ground plane shall be folded back and forth in the center forming a bundle 30 to 40 cm long.
- I/O cables that are not connected to a peripheral shall be bundled in the center. The end of the cable may be terminated, if required, using the correct terminating impedance. The overall length shall not exceed 1 m.
- LISN at least 80 cm from nearest part of EUT chassis.
- For the actual test configuration, please refer to the related Item –EUT Test Photos.

3.1.3 DEVIATION FROM TEST STANDARD

No deviation

3.1.4 TEST SETUP

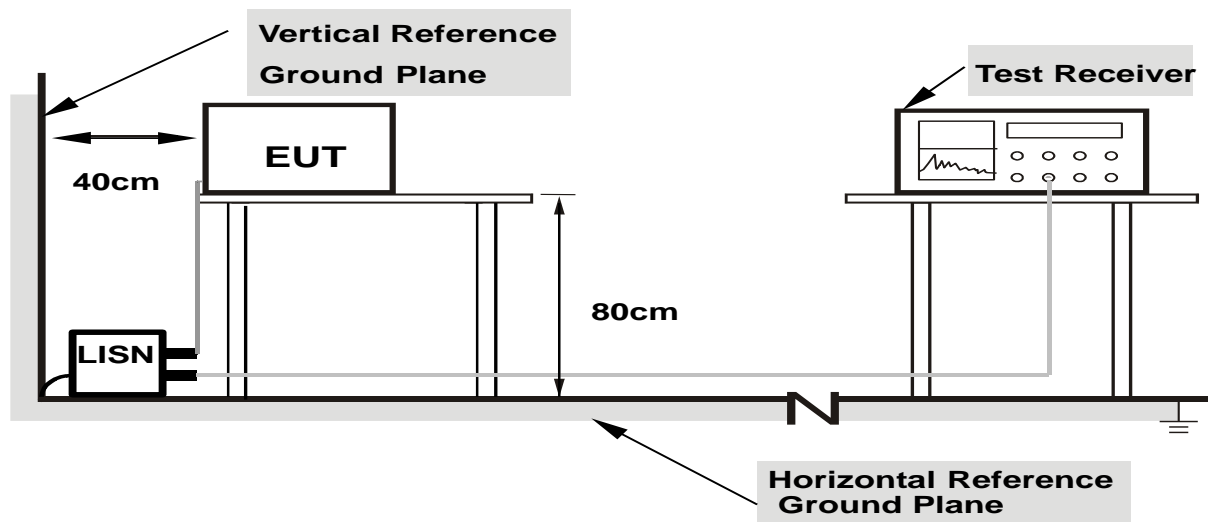

Note: 1. Support units were connected to second LISN.

2. Both of LISNs (AMN) are 80 cm from EUT and at least 80 from other units and other metal planes

3.1.5 EUT OPERATING CONDITIONS

The EUT was configured for testing in a typical fashion (as a customer would normally use it). The EUT has been programmed to continuously transmit during test. This operating condition was tested and used to collect the included data.

3.1.6 TEST RESULTS

EUT :	Wireless USB Adapter	Model Name. :	JN7
Temperature :	26 °C	Relative Humidity :	54%
Pressure :	1010hPa	Phase :	L
Test Voltage :	DC 5 V from PC with AC 120V/60Hz	Test Mode :	Mode 5

Frequency (MHz)	Meter Reading (dB μ V)	Factor (dB)	Emission Level (dB μ V/m)	Limits (dB μ V/m)	Margin (dB)	Detector Type
0.178	43.81	10.03	53.84	64.57	-10.73	QP
0.178	34.02	10.03	44.05	54.57	-10.52	AVG
0.242	37.29	10.2	47.49	62.02	-14.53	QP
0.242	27.23	10.2	37.43	52.02	-14.59	AVG
0.658	32.14	10.24	42.38	56	-13.62	QP
0.658	22.79	10.24	33.03	46	-12.97	AVG
1.014	34.18	10.15	44.33	56	-11.67	QP
1.014	23.9	10.15	34.05	46	-11.95	AVG
1.738	36.61	10.22	46.83	56	-9.17	QP
1.738	29.22	10.22	39.44	46	-6.56	AVG
6.2859	27.2	10.33	37.53	60	-22.47	QP
6.2859	19.44	10.33	29.77	50	-20.23	AVG

Remark:

1. Factor = Antenna Factor + Cable Loss – Pre-amplifier.

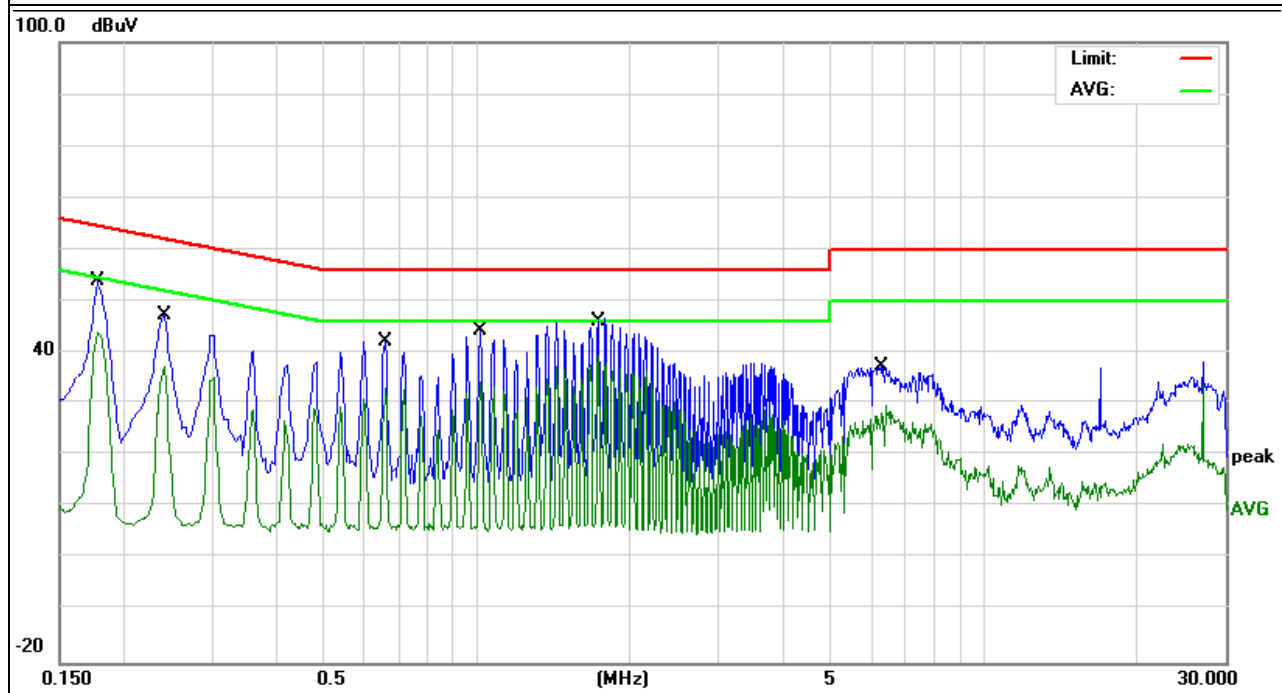

EUT :	Wireless USB Adapter	Model Name. :	JN7
Temperature :	26 °C	Relative Humidity :	54%
Pressure :	1010hPa	Phase :	N
Test Voltage :	DC 5 V from PC with AC 120V/60Hz	Test Mode :	Mode 5

Frequency (MHz)	Meter Reading (dB μ V)	Factor (dB)	Emission Level (dB μ V/m)	Limits (dB μ V/m)	Margin (dB)	Detector Type
0.178	42.25	10.03	52.28	64.57	-12.29	QP
0.178	32.12	10.03	42.15	54.57	-12.42	AVG
0.238	39.83	10.2	50.03	62.16	-12.13	QP
0.238	22.62	10.2	32.82	52.16	-19.34	AVG
0.654	33.61	10.24	43.85	56	-12.15	QP
0.654	22.52	10.24	32.76	46	-13.24	AVG
1.074	33.75	10.16	43.91	56	-12.09	QP
1.074	22.24	10.16	32.4	46	-13.6	AVG
1.85	34	10.23	44.23	56	-11.77	QP
1.85	25.27	10.23	35.5	46	-10.5	AVG
6.1419	26.08	10.34	36.42	60	-23.58	QP
6.1419	15.03	10.34	25.37	50	-24.63	AVG

Remark:

1. Factor = Antenna Factor + Cable Loss – Pre-amplifier.

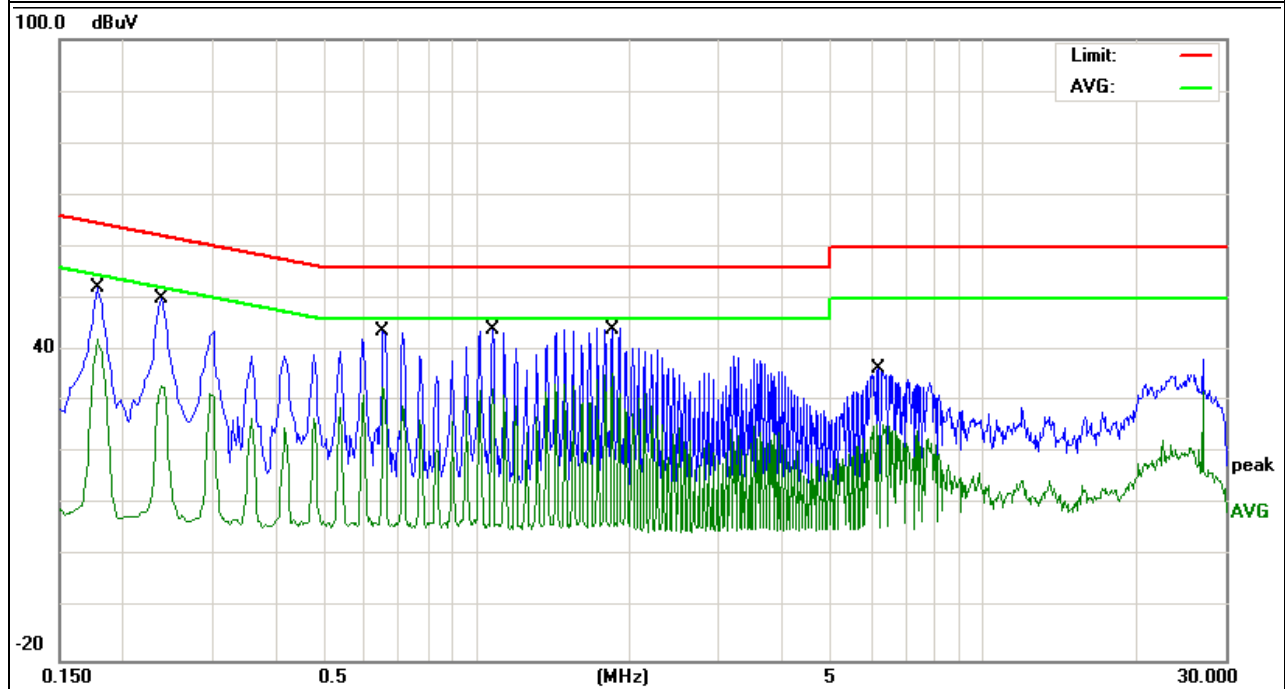

3.2 RADIATED EMISSION MEASUREMENT

3.2.1 RADIATED EMISSION LIMITS (Frequency Range 9kHz-1000MHz)

20dBc in any 100 kHz bandwidth outside the operating frequency band. In case the emission fall within the restricted band specified on 15.205(a), then the 15.209(a) limit in the table below has to be followed.

Frequencies (MHz)	Field Strength (micorvolts/meter)	Measurement Distance (meters)
0.009~0.490	2400/F(KHz)	300
0.490~1.705	24000/F(KHz)	30
1.705~30.0	30	30
30~88	100	3
88~216	150	3
216~960	200	3
Above 960	500	3

LIMITS OF RADIATED EMISSION MEASUREMENT (Above 1000MHz)

FREQUENCY (MHz)	Class A (dBuV/m) (at 3M)		Class B (dBuV/m) (at 3M)	
	PEAK	AVERAGE	PEAK	AVERAGE
Above 1000	80	60	74	54

Notes:

- (1) The limit for radiated test was performed according to FCC PART 15C.
- (2) The tighter limit applies at the band edges.
- (3) Emission level (dBuV/m)=20log Emission level (uV/m).

Spectrum Parameter	Setting
Attenuation	Auto
Start Frequency	1000 MHz
Stop Frequency	10th carrier harmonic
RB / VB (emission in restricted band)	1 MHz / 1 MHz for Peak, 1 MHz / 10Hz for Average

Receiver Parameter	Setting
Attenuation	Auto
Start ~ Stop Frequency	9kHz~150kHz / RB 200Hz for QP
Start ~ Stop Frequency	150kHz~30MHz / RB 9kHz for QP
Start ~ Stop Frequency	30MHz~1000MHz / RB 120kHz for QP

3.2.2 TEST PROCEDURE

- a. The measuring distance of at 3 m shall be used for measurements at frequency up to 1GHz. For frequencies above 1GHz, any suitable measuring distance may be used.
- b. The EUT was placed on the top of a rotating table 0.8 meters above the ground at a 3 meter open area test site. The table was rotated 360 degrees to determine the position of the highest radiation.
- c. The height of the equipment or of the substitution antenna shall be 0.8 m; the height of the test antenna shall vary between 1 m to 4 m. Both horizontal and vertical polarizations of the antenna are set to make the measurement.
- d. The initial step in collecting conducted emission data is a spectrum analyzer peak detector mode pre-scanning the measurement frequency range. Significant peaks are then marked and then Quasi Peak detector mode re-measured.
- e. If the Peak Mode measured value compliance with and lower than Quasi Peak Mode Limit, the EUT shall be deemed to meet QP Limits and then no additional QP Mode measurement performed.
- f. For the actual test configuration, please refer to the related Item –EUT Test Photos.

Note:

Both horizontal and vertical antenna polarities were tested and performed pretest to three orthogonal axis. The worst case emissions were reported

3.2.3 DEVIATION FROM TEST STANDARD

No deviation

3.2.4 TEST SETUP

(A) Radiated Emission Test-Up Frequency Below 30MHz

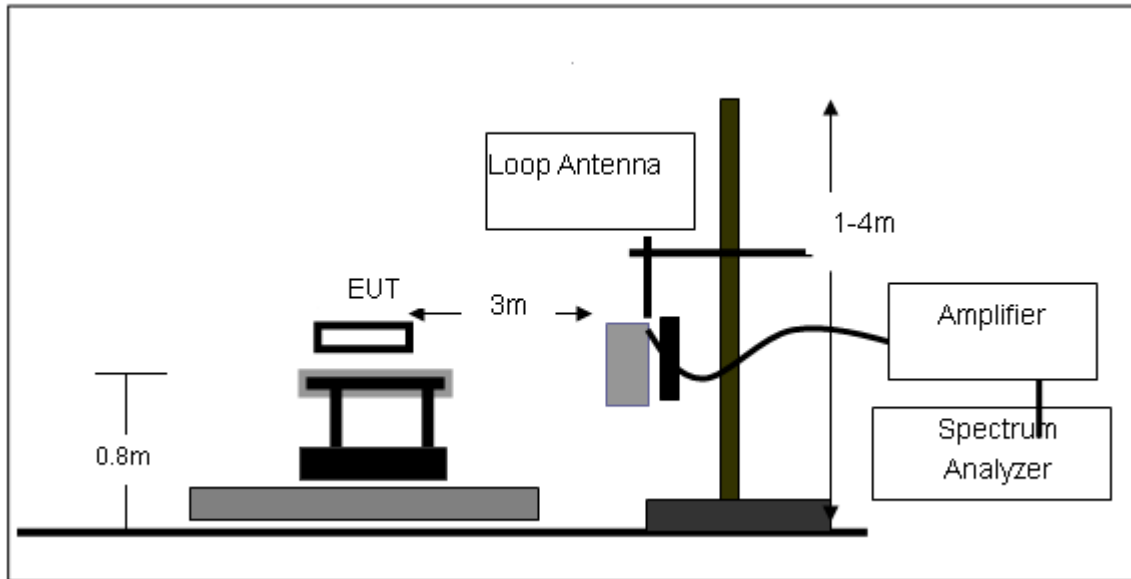

(B) Radiated Emission Test-Up Frequency 30MHz~1GHz

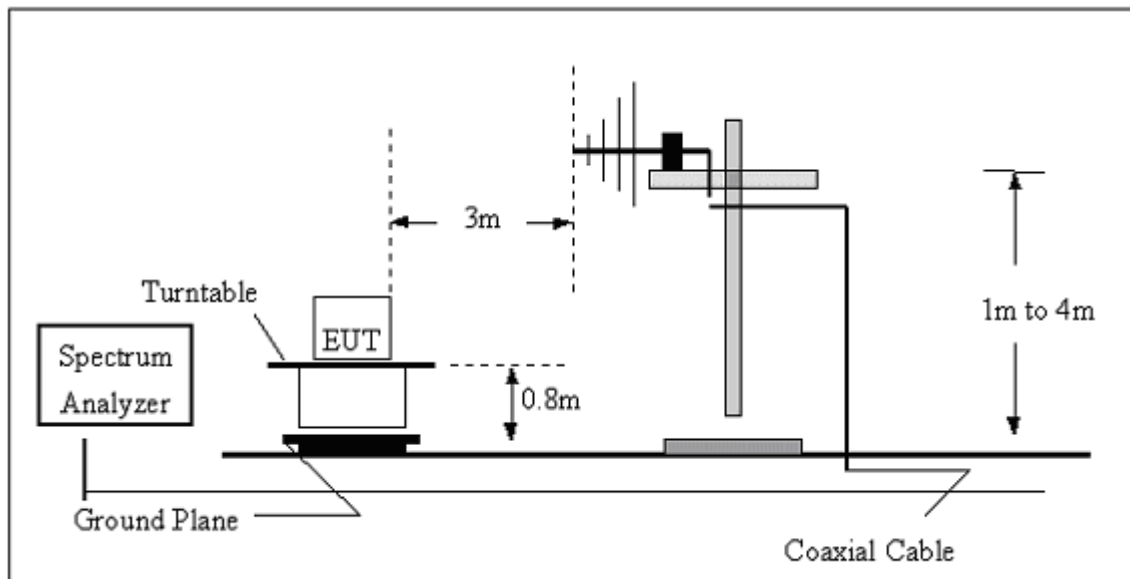

(C) Radiated Emission Test-Up Frequency Above 1GHz

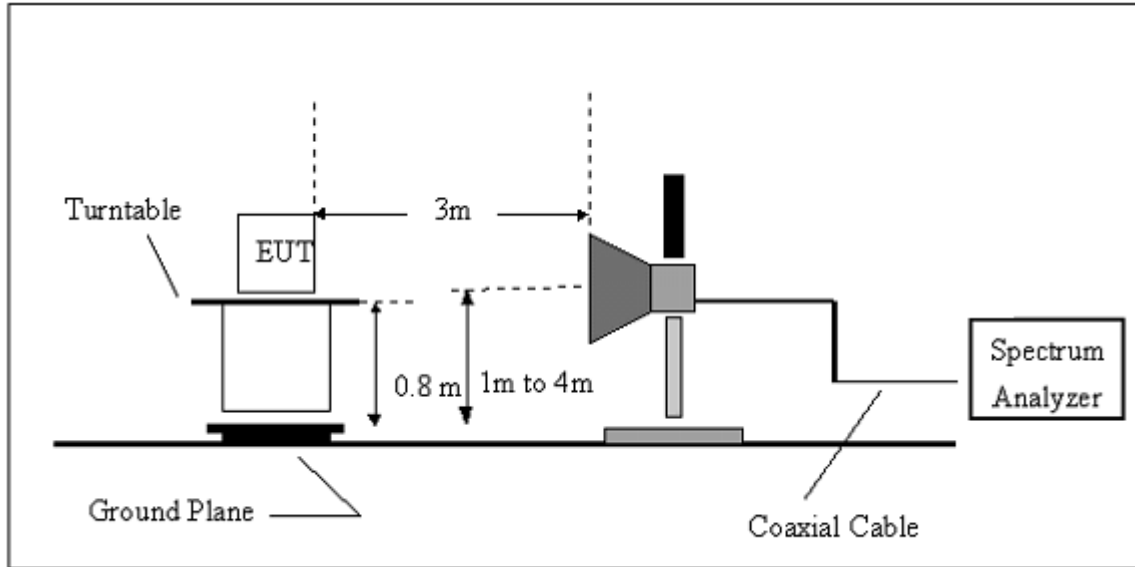
**3.2.5 EUT OPERATING CONDITIONS**

The EUT tested system was configured as the statements of 2.3 Unless otherwise a special operating condition is specified in the follows during the testing.

3.2.6 TEST RESULTS (BETWEEN 9KHZ – 30 MHZ)

EUT:	Wireless USB Adapter	Model Name. :	JN7
Temperature:	20 °C	Relative Humidity:	48%
Pressure:	1010 hPa	Test Voltage :	DC 5 V from PC with AC 120V/60Hz
Test Mode :	Link mode	Polarization :	--

Freq.	Reading	Limit	Margin	State
(MHz)	(dBuV/m)	(dBuV/m)	(dB)	P/F
--	--	--	--	PASS
--	--	--	--	PASS

NOTE:

The amplitude of spurious emissions which are attenuated by more than 20dB below the permissible value has no need to be reported.

Distance extrapolation factor = $40 \log (\text{specific distance}/\text{test distance})(\text{dB})$;

Limit line = specific limits(dBuv) + distance extrapolation factor.

3.2.7 TEST RESULTS (BETWEEN 30MHZ – 1GHZ)

EUT :	Wireless USB Adapter	Model Name :	JN7
Temperature :	20 °C	Relative Humidity :	48%
Pressure :	1010 hPa	Test Voltage :	DC 5 V from PC with AC 120V/60Hz
Test Mode :	Link mode	Polarization :	Horizontal

Frequency (MHz)	Meter Reading (dB μ V)	Factor (dB)	Emission Level (dB μ V/m)	Limits (dB μ V/m)	Margin (dB)	Detector Type
36.2541	18.27	15.24	33.51	40	-6.49	QP
57.1914	30.73	5.75	36.48	40	-3.52	QP
90.2205	30.05	9.47	39.52	43.5	-3.98	QP
154.2786	26.25	11.5	37.75	43.5	-5.75	QP
315.4806	18.59	15.26	33.85	46	-12.15	QP
406.088	12.17	18.54	30.71	46	-15.29	QP

Remark:

1. Factor = Antenna Factor + Cable Loss – Pre-amplifier.

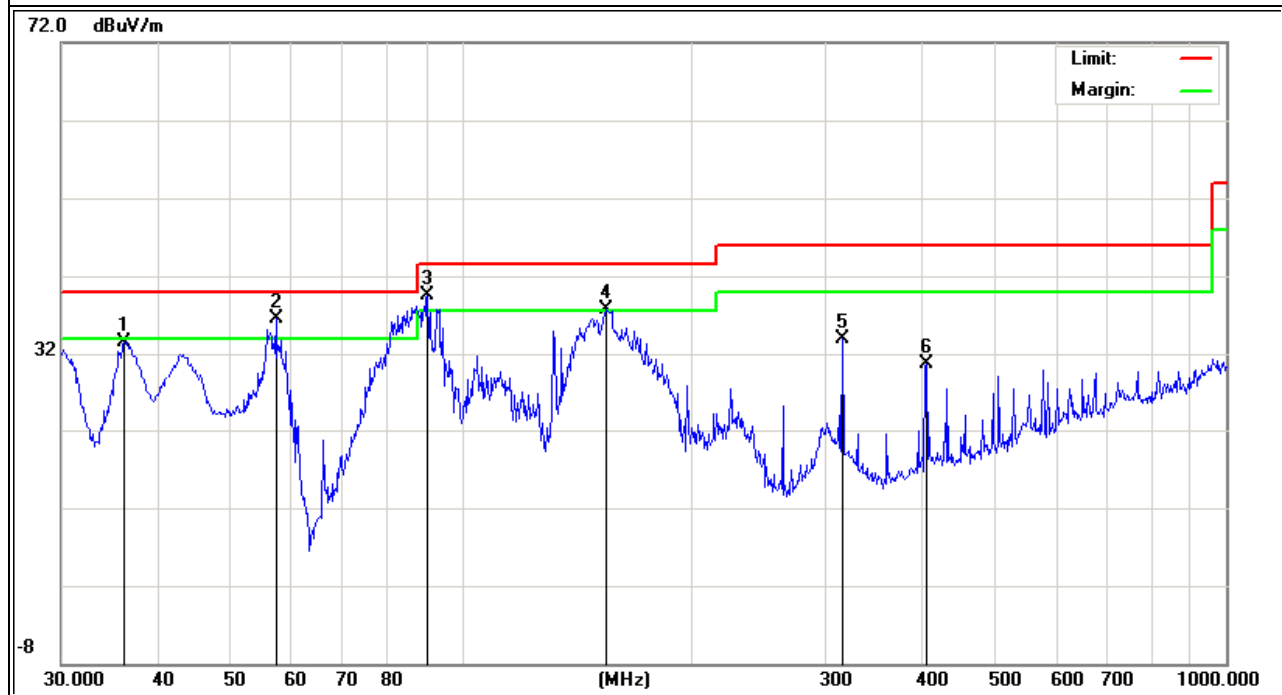

EUT :	Wireless USB Adapter	Model Name :	JN7
Temperature :	20 °C	Relative Humidity :	48%
Pressure :	1010 hPa	Test Voltage :	DC 5 V from PC with AC 120V/60Hz
Test Mode :	Link mode	Polarization :	Vertical

Frequency (MHz)	Meter Reading (dBμV)	Factor (dB)	Emission Level (dBμV/m)	Limits (dBμV/m)	Margin (dB)	Detector Type
98.1419	27.4	10.4	37.8	43.5	-5.7	QP
131.7574	25.28	12.22	37.5	43.5	-6	QP
164.9071	26.19	10.81	37	43.5	-6.5	QP
315.4806	21.83	15.26	37.09	46	-8.91	QP
406.088	22.72	18.54	41.26	46	-4.74	QP
815.9678	10.66	26.46	37.12	46	-8.88	QP

Remark:

- Factor = Antenna Factor + Cable Loss – Pre-amplifier.

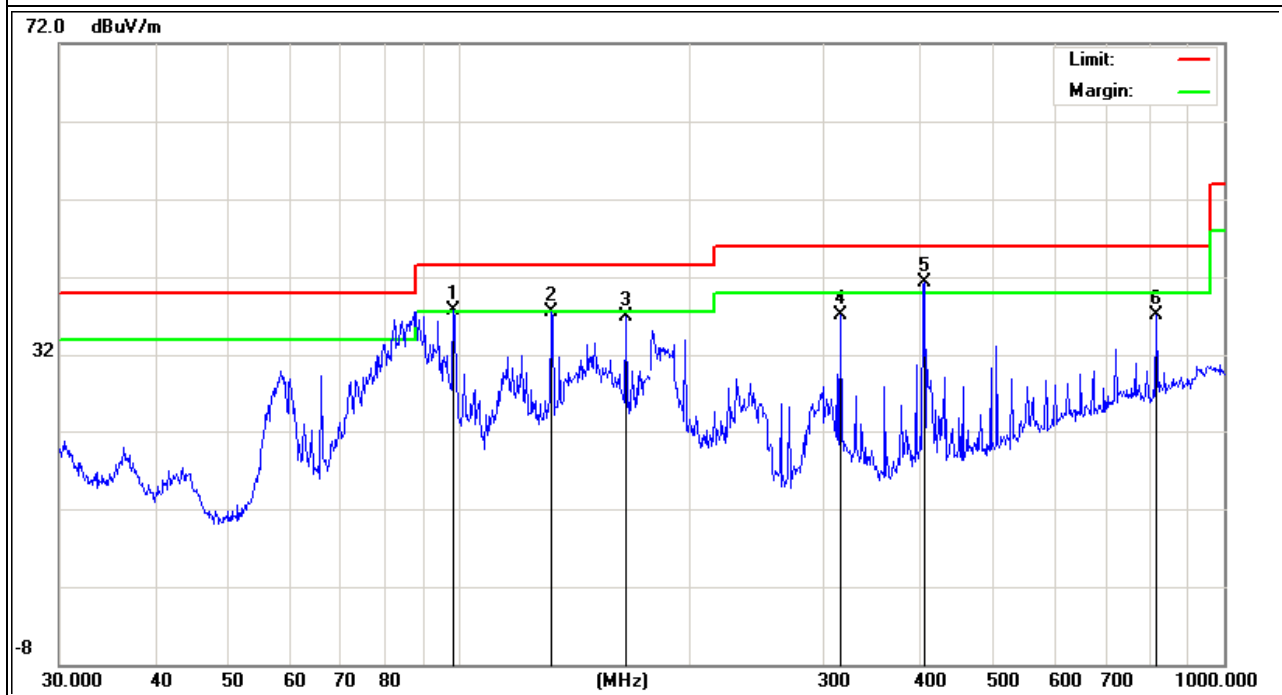

3.2.8 TEST RESULTS (1GHZ-26GHZ)

EUT :	Wireless USB Adapter	Model Name :	JN7
Temperature :	20 °C	Relative Humidity :	48%
Pressure :	1010 hPa	Test Voltage :	DC 5 V from PC with AC 120V/60Hz
Test Mode :	CH1 (802.11b Mode)/2412	Polarization :	Horizontal

Frequency (MHz)	Meter Reading (dBμV)	Factor (dB)	Emission Level (dBμV/m)	Limits (dBμV/m)	Margin (dB)	Value Type
4824.15	46.84	10.44	57.28	74	-16.72	peak
4824.15	38.58	10.44	49.02	54	-4.98	AVG
7236.149	42.40	12.39	54.79	74	-19.21	peak
7236.149	35.82	12.39	48.21	54	-5.79	AVG

Remark:

Factor = Antenna Factor + Cable Loss – Pre-amplifier.

EUT :	Wireless USB Adapter	Model Name :	JN7
Temperature :	20 °C	Relative Humidity :	48%
Pressure :	1010 hPa	Test Voltage :	DC 5 V from PC with AC 120V/60Hz
Test Mode :	CH1 (802.11b Mode)/2412	Polarization :	Vertical

Frequency (MHz)	Meter Reading (dBμV)	Factor (dB)	Emission Level (dBμV/m)	Limits (dBμV/m)	Margin (dB)	Value Type
4874.145	47.22	10.4	57.62	74	-16.38	peak
4874.145	36.86	10.4	47.26	54	-6.74	AVG
7311.163	43.72	12.75	56.47	74	-17.53	peak
7311.163	35.27	12.75	48.02	54	-5.98	AVG

Remark:

Factor = Antenna Factor + Cable Loss – Pre-amplifier.

EUT :	Wireless USB Adapter	Model Name :	JN7
Temperature :	20 °C	Relative Humidity :	48%
Pressure :	1010 hPa	Test Voltage :	DC 5 V from PC with AC 120V/60Hz
Test Mode :	CH6 (802.11b Mode)/2437	Polarization :	Horizontal

Frequency (MHz)	Meter Reading (dBμV)	Factor (dB)	Emission Level (dBμV/m)	Limits (dBμV/m)	Margin (dB)	Value Type
4874.159	46.92	10.4	57.32	74	-16.68	peak
4874.159	36.16	10.4	46.56	54	-7.44	AVG
7311.136	43.3	12.75	56.05	74	-17.95	peak
7311.136	32.49	12.75	45.24	54	-8.76	AVG

Remark:

Factor = Antenna Factor + Cable Loss – Pre-amplifier.

EUT :	Wireless USB Adapter	Model Name :	JN7
Temperature :	20 °C	Relative Humidity :	48%
Pressure :	1010 hPa	Test Voltage :	DC 5 V from PC with AC 120V/60Hz
Test Mode :	CH6 (802.11b Mode)/2437	Polarization :	Vertical

Frequency (MHz)	Meter Reading (dBμV)	Factor (dB)	Emission Level (dBμV/m)	Limits (dBμV/m)	Margin (dB)	Value Type
4924.146	46.33	10.39	56.72	74	-17.28	peak
4934.146	36.53	10.44	46.97	54	-7.03	AVG
7386.143	43.68	12.68	56.36	74	-17.64	peak
7386.143	32.46	12.68	45.14	54	-8.86	AVG

Remark:

- Factor = Antenna Factor + Cable Loss – Pre-amplifier.
- No emission detected above 18GHz

EUT :	Wireless USB Adapter	Model Name :	JN7
Temperature :	20 °C	Relative Humidity :	48%
Pressure :	1010 hPa	Test Voltage :	DC 5 V from PC with AC 120V/60Hz
Test Mode :	CH11 (802.11b Mode)/2462	Polarization :	Horizontal

Frequency (MHz)	Meter Reading (dBμV)	Factor (dB)	Emission Level (dBμV/m)	Limits (dBμV/m)	Margin (dB)	Value Type
4924.145	45.86	10.39	56.25	74	-17.75	peak
4924.145	36.68	10.39	47.07	54	-6.93	AVG
7386.142	45.04	12.68	57.72	74	-16.28	peak
7386.142	33.9	12.68	46.58	54	-7.42	AVG

Remark:

- Factor = Antenna Factor + Cable Loss – Pre-amplifier.
- No emission detected above 18GHz

EUT :	Wireless USB Adapter	Model Name :	JN7
Temperature :	20 °C	Relative Humidity :	48%
Pressure :	1010 hPa	Test Voltage :	DC 5 V from PC with AC 120V/60Hz
Test Mode :	CH11 (802.11b Mode)/2462	Polarization :	Vertical

Frequency (MHz)	Meter Reading (dBμV)	Factor (dB)	Emission Level (dBμV/m)	Limits (dBμV/m)	Margin (dB)	Value Type
4924.122	44.69	10.39	55.08	74	-18.92	peak
4924.122	33.84	10.39	44.23	54	-9.77	AVG
7386.143	45.04	12.68	57.72	74	-16.28	peak
7386.143	34.61	12.68	47.29	54	-6.71	AVG

Remark:

Factor = Antenna Factor + Cable Loss – Pre-amplifier.

EUT :	Wireless USB Adapter	Model Name :	JN7
Temperature :	20 °C	Relative Humidity :	48%
Pressure :	1010 hPa	Test Voltage :	DC 5 V from PC with AC 120V/60Hz
Test Mode :	CH1 (802.11g Mode)/2412	Polarization :	Horizontal

Frequency (MHz)	Meter Reading (dB μ V)	Factor (dB)	Emission Level (dB μ V/m)	Limits (dB μ V/m)	Margin (dB)	Value Type
4824.17	45.31	10.44	55.75	74	-18.25	peak
4824.17	33.49	10.44	43.93	54	-10.07	AVG
7236.224	44.27	12.39	56.66	74	-17.34	peak
7236.224	33.13	12.39	45.52	54	-8.48	AVG

Remark:

Factor = Antenna Factor + Cable Loss – Pre-amplifier.

EUT :	Wireless USB Adapter	Model Name :	JN7
Temperature :	20 °C	Relative Humidity :	48%
Pressure :	1010 hPa	Test Voltage :	DC 5 V from PC with AC 120V/60Hz
Test Mode :	CH1 (802.11g Mode)/2412	Polarization :	Vertical

Frequency (MHz)	Meter Reading (dB μ V)	Factor (dB)	Emission Level (dB μ V/m)	Limits (dB μ V/m)	Margin (dB)	Value Type
4824.155	46.63	10.44	57.07	74	-16.93	peak
4824.155	37.35	10.44	47.79	54	-6.21	AVG
7236.142	43.44	12.39	55.83	74	-18.17	peak
7236.142	32.15	12.39	44.54	54	-9.46	AVG

Remark:

Factor = Antenna Factor + Cable Loss – Pre-amplifier.

EUT :	Wireless USB Adapter	Model Name :	JN7
Temperature :	20 °C	Relative Humidity :	48%
Pressure :	1010 hPa	Test Voltage :	DC 5 V from PC with AC 120V/60Hz
Test Mode :	CH6 (802.11g Mode)/2437	Polarization :	Horizontal

Frequency (MHz)	Meter Reading (dB μ V)	Factor (dB)	Emission Level (dB μ V/m)	Limits (dB μ V/m)	Margin (dB)	Value Type
4874.14	46.11	10.4	56.51	74	-17.49	peak
4874.14	34.92	10.4	45.32	54	-8.68	AVG
7311.17	41.63	12.75	54.38	74	-19.62	peak
7311.17	31.51	12.75	44.26	54	-9.74	AVG

Remark:

Factor = Antenna Factor + Cable Loss – Pre-amplifier.

EUT :	Wireless USB Adapter	Model Name :	JN7
Temperature :	20 °C	Relative Humidity :	48%
Pressure :	1010 hPa	Test Voltage :	DC 5 V from PC with AC 120V/60Hz
Test Mode :	CH6 (802.11g Mode)/2437	Polarization :	Vertical

Frequency (MHz)	Meter Reading (dB μ V)	Factor (dB)	Emission Level (dB μ V/m)	Limits (dB μ V/m)	Margin (dB)	Value Type
4874.158	45.25	10.4	55.65	74	-18.35	peak
4874.158	35.67	10.4	46.07	54	-7.93	AVG
7311.137	43.99	12.75	56.74	74	-17.26	peak
7311.137	33.1	12.75	45.85	54	-8.15	AVG

Remark:

Factor = Antenna Factor + Cable Loss – Pre-amplifier.

EUT :	Wireless USB Adapter	Model Name :	JN7
Temperature :	20 °C	Relative Humidity :	48%
Pressure :	1010 hPa	Test Voltage :	DC 5 V from PC with AC 120V/60Hz
Test Mode :	CH11 (802.11g Mode)/2462	Polarization :	Horizontal

Frequency (MHz)	Meter Reading (dBμV)	Factor (dB)	Emission Level (dBμV/m)	Limits (dBμV/m)	Margin (dB)	Value Type
4924.138	44.38	10.39	54.77	74	-19.23	peak
4924.138	35.24	10.39	45.63	54	-8.37	AVG
7386.149	39.79	12.68	52.47	74	-21.53	peak
7386.149	29.65	12.68	42.33	54	-11.67	AVG

Remark:
Factor = Antenna Factor + Cable Loss – Pre-amplifier.

EUT :	Wireless USB Adapter	Model Name :	JN7
Temperature :	20 °C	Relative Humidity :	48%
Pressure :	1010 hPa	Test Voltage :	DC 5 V from PC with AC 120V/60Hz
Test Mode :	CH11(802.11g Mode)/2462	Polarization :	Vertical

Frequency (MHz)	Meter Reading (dBμV)	Factor (dB)	Emission Level (dBμV/m)	Limits (dBμV/m)	Margin (dB)	Value Type
4924.148	45.13	10.39	55.52	74	-18.48	peak
4924.148	34.37	10.39	44.76	54	-9.24	AVG
7386.13	43.53	12.68	56.21	74	-17.79	peak
7386.13	34.31	12.68	46.99	54	-7.01	AVG

Remark:
Factor = Antenna Factor + Cable Loss – Pre-amplifier.

EUT :	Wireless USB Adapter	Model Name :	JN7
Temperature :	20 °C	Relative Humidity :	48%
Pressure :	1010 hPa	Test Voltage :	DC 5 V from PC with AC 120V/60Hz
Test Mode :	CH1(802.11n Mode)/20MHz	Polarization :	Horizontal

Frequency (MHz)	Meter Reading (dBμV)	Factor (dB)	Emission Level (dBμV/m)	Limits (dBμV/m)	Margin (dB)	Value Type
4824.14	46.02	10.44	56.46	74	-17.54	peak
4824.14	35.58	10.44	46.02	54	-7.98	AVG
7236.122	42.34	12.39	54.73	74	-19.27	peak
7236.122	32.15	12.39	44.54	54	-9.46	AVG

Remark:
Factor = Antenna Factor + Cable Loss – Pre-amplifier.

EUT :	Wireless USB Adapter	Model Name :	JN7
Temperature :	20 °C	Relative Humidity :	48%
Pressure :	1010 hPa	Test Voltage :	DC 5 V from PC with AC 120V/60Hz
Test Mode :	CH1(802.11n Mode)/20MHz	Polarization :	Vertical

Frequency (MHz)	Meter Reading (dBμV)	Factor (dB)	Emission Level (dBμV/m)	Limits (dBμV/m)	Margin (dB)	Value Type
4824.141	44.73	10.44	55.17	74	-18.83	peak
4824.141	33.48	10.44	43.92	54	-10.08	AVG
7236.145	42.09	12.39	54.48	74	-19.52	peak
7236.145	32.35	12.39	44.74	54	-9.26	AVG

Remark:
Factor = Antenna Factor + Cable Loss – Pre-amplifier.

EUT :	Wireless USB Adapter	Model Name :	JN7
Temperature :	20 °C	Relative Humidity :	48%
Pressure :	1010 hPa	Test Voltage :	DC 5 V from PC with AC 120V/60Hz
Test Mode :	CH6(802.11n Mode)/20MHz	Polarization :	Horizontal

Frequency (MHz)	Meter Reading (dBμV)	Factor (dB)	Emission Level (dBμV/m)	Limits (dBμV/m)	Margin (dB)	Value Type
4874.16	46.31	10.4	56.71	74	-17.29	peak
4874.16	35.28	10.4	45.68	54	-8.32	AVG
7311.128	42.61	12.75	55.36	74	-18.64	peak
7311.128	31.09	12.75	43.84	54	-10.16	AVG

Remark:
Factor = Antenna Factor + Cable Loss – Pre-amplifier.

EUT :	Wireless USB Adapter	Model Name :	JN7
Temperature :	20 °C	Relative Humidity :	48%
Pressure :	1010 hPa	Test Voltage :	DC 5 V from PC with AC 120V/60Hz
Test Mode :	CH6(802.11n Mode)/20MHz	Polarization :	Vertical

Frequency (MHz)	Meter Reading (dBμV)	Factor (dB)	Emission Level (dBμV/m)	Limits (dBμV/m)	Margin (dB)	Value Type
4874.161	45.25	10.4	55.65	74	-18.35	peak
4874.161	35.22	10.4	45.62	54	-8.38	AVG
7311.166	42.11	12.75	54.86	74	-19.14	peak
7311.166	30.19	12.75	42.94	54	-11.06	AVG

Remark:
Factor = Antenna Factor + Cable Loss – Pre-amplifier.

EUT :	Wireless USB Adapter	Model Name :	JN7
Temperature :	20 °C	Relative Humidity :	48%
Pressure :	1010 hPa	Test Voltage :	DC 5 V from PC with AC 120V/60Hz
Test Mode :	CH11(802.11n Mode)/20MHz	Polarization :	Horizontal

Frequency (MHz)	Meter Reading (dBμV)	Factor (dB)	Emission Level (dBμV/m)	Limits (dBμV/m)	Margin (dB)	Value Type
4924.14	46.43	10.39	56.82	74	-17.18	peak
4924.14	36.12	10.39	46.51	54	-7.49	AVG
7386.183	40.97	12.68	53.65	74	-20.35	peak
7386.183	30.91	12.68	43.59	54	-10.41	AVG

Remark:
Factor = Antenna Factor + Cable Loss – Pre-amplifier.

EUT :	Wireless USB Adapter	Model Name :	JN7
Temperature :	20 °C	Relative Humidity :	48%
Pressure :	1010 hPa	Test Voltage :	DC 5 V from PC with AC 120V/60Hz
Test Mode :	CH11(802.11n Mode)/20MHz	Polarization :	Vertical

Frequency (MHz)	Meter Reading (dBμV)	Factor (dB)	Emission Level (dBμV/m)	Limits (dBμV/m)	Margin (dB)	Value Type
4924.15	45.54	10.39	55.93	74	-18.07	peak
4924.15	34.3	10.39	44.69	54	-9.31	AVG
7386.167	43.78	12.68	56.46	74	-17.54	peak
7386.167	32.5	12.68	45.18	54	-8.82	AVG

Remark:
Factor = Antenna Factor + Cable Loss – Pre-amplifier.

EUT :	Wireless USB Adapter	Model Name :	JN7
Temperature :	20 °C	Relative Humidity :	48%
Pressure :	1010 hPa	Test Voltage :	DC 5 V from PC with AC 120V/60Hz
Test Mode :	CH3(802.11n Mode)/40MHz	Polarization :	Horizontal

Frequency (MHz)	Meter Reading (dB μ V)	Factor (dB)	Emission Level (dB μ V/m)	Limits (dB μ V/m)	Margin (dB)	Value Type
4844.156	45.13	10.5	55.63	74	-18.37	peak
4844.156	33.86	10.5	44.36	54	-9.64	AVG
7266.319	41.35	12.5	53.85	74	-20.15	peak
7266.319	30.77	12.5	43.27	54	-10.73	AVG

Remark:

Factor = Antenna Factor + Cable Loss – Pre-amplifier.

EUT :	Wireless USB Adapter	Model Name :	JN7
Temperature :	20 °C	Relative Humidity :	48%
Pressure :	1010 hPa	Test Voltage :	DC 5 V from PC with AC 120V/60Hz
Test Mode :	CH3(802.11n Mode)/40MHz	Polarization :	Vertical

Frequency (MHz)	Meter Reading (dB μ V)	Factor (dB)	Emission Level (dB μ V/m)	Limits (dB μ V/m)	Margin (dB)	Value Type
4844.325	41.02	10.5	51.52	74	-22.48	peak
4844.325	31.88	10.5	42.38	54	-11.62	AVG
7266.258	37.91	12.5	50.41	74	-23.59	peak
7266.258	29.33	12.5	41.83	54	-12.17	AVG

Remark:

Factor = Antenna Factor + Cable Loss – Pre-amplifier.

EUT :	Wireless USB Adapter	Model Name :	JN7
Temperature :	20 °C	Relative Humidity :	48%
Pressure :	1010 hPa	Test Voltage :	DC 5 V from PC with AC 120V/60Hz
Test Mode :	CH6(802.11n Mode)/40MHz	Polarization :	Horizontal

Frequency (MHz)	Meter Reading (dB μ V)	Factor (dB)	Emission Level (dB μ V/m)	Limits (dB μ V/m)	Margin (dB)	Value Type
4874.238	42.85	10.4	53.25	74	-20.75	peak
4874.238	33.17	10.4	43.57	54	-10.43	AVG
7311.159	41.68	12.75	54.43	74	-19.57	peak
7311.159	32.91	12.75	45.66	54	-8.34	AVG

Remark:

Factor = Antenna Factor + Cable Loss – Pre-amplifier.

EUT :	Wireless USB Adapter	Model Name :	JN7
Temperature :	20 °C	Relative Humidity :	48%
Pressure :	1010 hPa	Test Voltage :	DC 5 V from PC with AC 120V/60Hz
Test Mode :	CH6(802.11n Mode)/40MHz	Polarization :	Vertical

Frequency (MHz)	Meter Reading (dB μ V)	Factor (dB)	Emission Level (dB μ V/m)	Limits (dB μ V/m)	Margin (dB)	Value Type
4874.535	45.36	10.4	55.76	74	-18.24	peak
4874.535	36.44	10.4	46.84	54	-7.16	AVG
7311.633	41.73	12.75	54.48	74	-19.52	peak
7311.633	32.34	12.75	45.09	54	-8.91	AVG

Remark:

Factor = Antenna Factor + Cable Loss – Pre-amplifier.

EUT :	Wireless USB Adapter	Model Name :	JN7
Temperature :	20 °C	Relative Humidity :	48%
Pressure :	1010 hPa	Test Voltage :	DC 5 V from PC with AC 120V/60Hz
Test Mode :	CH9(802.11n Mode)/40MHz	Polarization :	Horizontal

Frequency	Meter Reading	Factor	Emission Level	Limits	Margin	Value Type
(MHz)	(dBμV)	(dB)	(dBμV/m)	(dBμV/m)	(dB)	
4904.345	44.84	10.29	55.13	74	-18.87	peak
4904.345	33.55	10.29	43.84	54	-10.16	AVG
7356.247	38.86	12.79	51.65	74	-22.35	peak
7356.247	29.72	12.79	42.51	54	-11.49	AVG

Remark:
Factor = Antenna Factor + Cable Loss – Pre-amplifier.

EUT :	Wireless USB Adapter	Model Name :	JN7
Temperature :	20 °C	Relative Humidity :	48%
Pressure :	1010 hPa	Test Voltage :	DC 5 V from PC with AC 120V/60Hz
Test Mode :	CH9(802.11n Mode)/40MHz	Polarization :	Vertical

Frequency	Meter Reading	Factor	Emission Level	Limits	Margin	Value Type
(MHz)	(dBμV)	(dB)	(dBμV/m)	(dBμV/m)	(dB)	
4904.16	43.14	10.29	53.43	74	-20.57	peak
4904.16	33.64	10.29	43.93	54	-10.07	AVG
7356.423	38.05	12.79	50.84	74	-23.16	peak
7356.423	29.38	12.79	42.17	54	-11.83	AVG

Remark:
Factor = Antenna Factor + Cable Loss – Pre-amplifier.

3.2.9 TEST RESULTS (RESTRICTED BANDS REQUIREMENTS)

EUT :	Wireless USB Adapter	Model Name :	JN7
Temperature :	20 °C	Relative Humidity :	48%
Pressure :	1010 hPa	Test Voltage :	DC 5 V from PC with AC 120V/60Hz
Test Mode :	CH1(802.11b Mode)	Polarization :	Horizontal

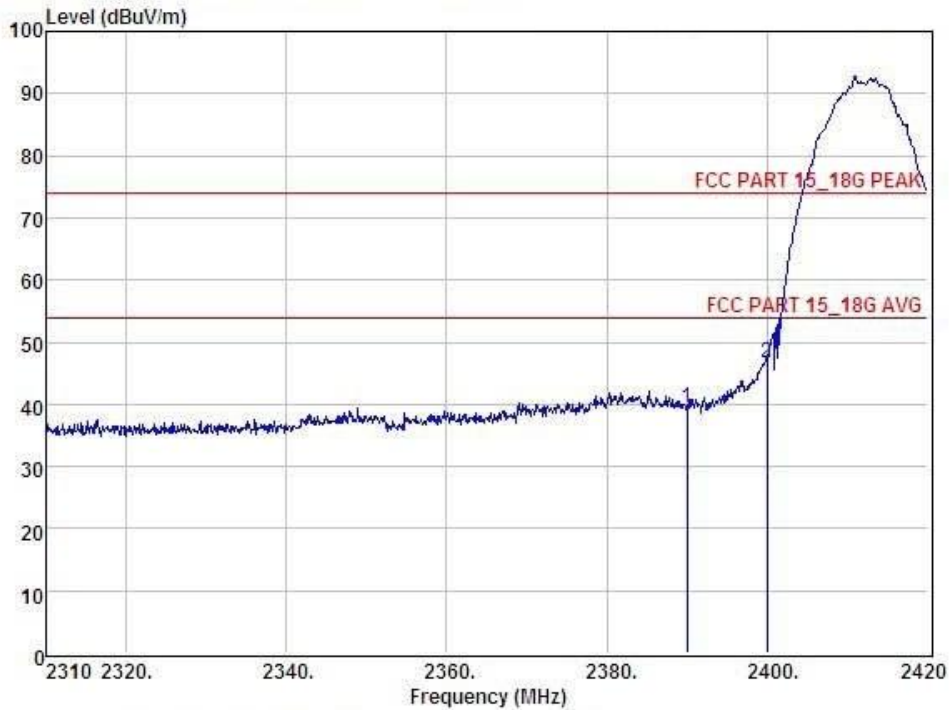

Condition : FCC PART 15_18G PEAK 3m POL: HORIZONTAL

Item	Freq MHz	Read Level dBuV	Antenna Factor dB	Preamp Factor dB	Cable Loss dB	Level dBuV	Limit dBuV	Margin dBuV	Remark
1	2390.00	42.95	27.62	34.97	3.92	39.52	74.00	-34.48	Peak
2	2400.00	50.14	27.62	34.97	3.94	46.73	74.00	-27.27	Peak

Remark: Level = Read Level + Antenna Factor - Preamp Factor + Cable Loss

EUT :	Wireless USB Adapter	Model Name :	JN7
Temperature :	20 °C	Relative Humidity :	48%
Pressure :	1010 hPa	Test Voltage :	DC 5 V from PC with AC 120V/60Hz
Test Mode :	CH1(802.11b Mode)	Polarization :	Vertical

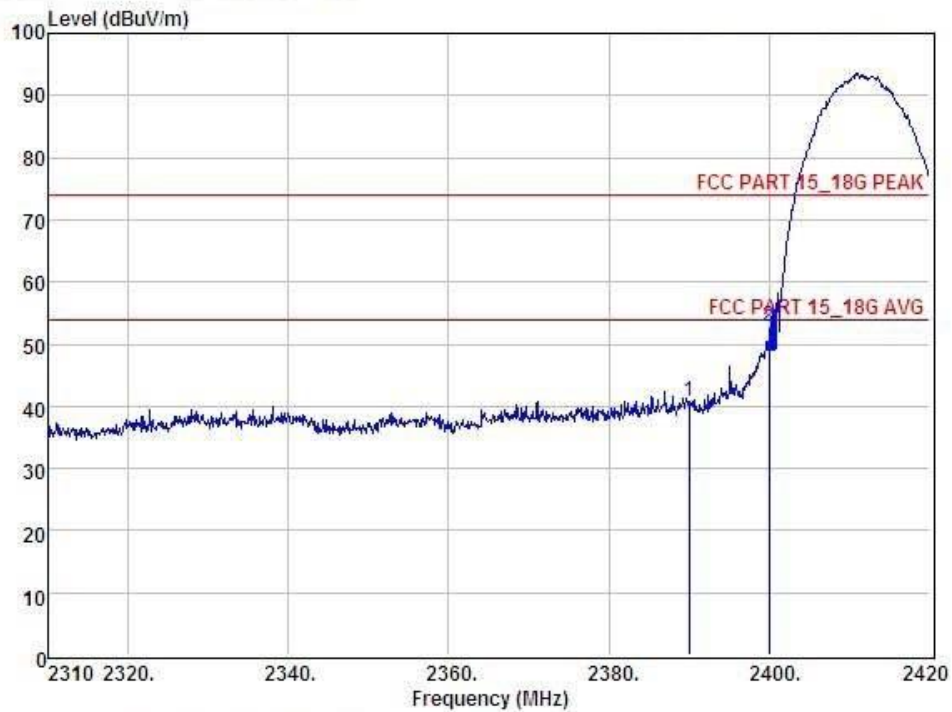

Condition : FCC PART 15_18G PEAK 3m POL: VERTICAL

Item	Freq MHz	Read Level dBuV	Antenna Factor dB	Preamp Factor dB	Cable Loss dB	Level dBuV	Limit dBuV	Margin dBuV	Remark
1	2390.00	44.07	27.62	34.97	3.92	40.64	74.00	-33.36	Peak
2	2400.00	56.27	27.62	34.97	3.94	52.86	74.00	-21.14	Peak

Remark: Level = Read Level + Antenna Factor - Preamp Factor + Cable Loss

EUT :	Wireless USB Adapter	Model Name :	JN7
Temperature :	20 °C	Relative Humidity :	48%
Pressure :	1010 hPa	Test Voltage :	DC 5 V from PC with AC 120V/60Hz
Test Mode :	CH11(802.11b Mode)	Polarization :	Horizontal

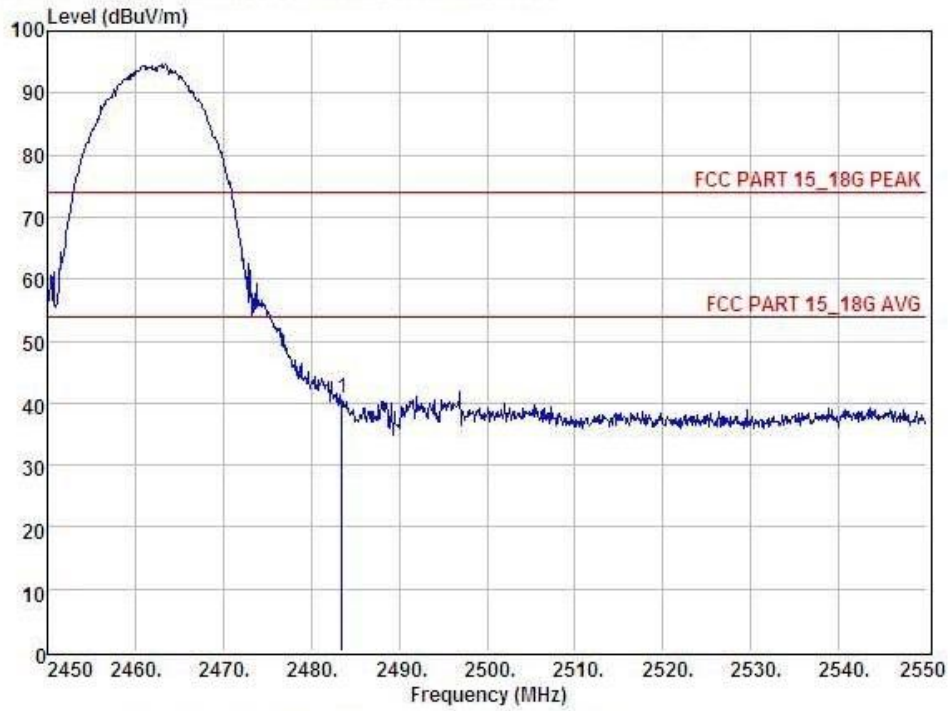

Condition : FCC PART 15_18G PEAK 3m POL: HORIZONTAL									
Item	Freq	Read Level	Antenna Factor	Preamp Factor	Cable Loss	Level	Limit	Margin	Remark
	MHz	dBuV	dB	dB	dB	dBuV	dBuV	dBuV	
1	2483.50	44.05	27.59	34.97	4.00	40.67	74.00	-33.33	Peak

Remark: Level = Read Level + Antenna Factor - Preamp Factor + Cable Loss

EUT :	Wireless USB Adapter	Model Name :	JN7
Temperature :	20 °C	Relative Humidity :	48%
Pressure :	1010 hPa	Test Voltage :	DC 5 V from PC with AC 120V/60Hz
Test Mode :	CH11(802.11b Mode)	Polarization :	Vertical

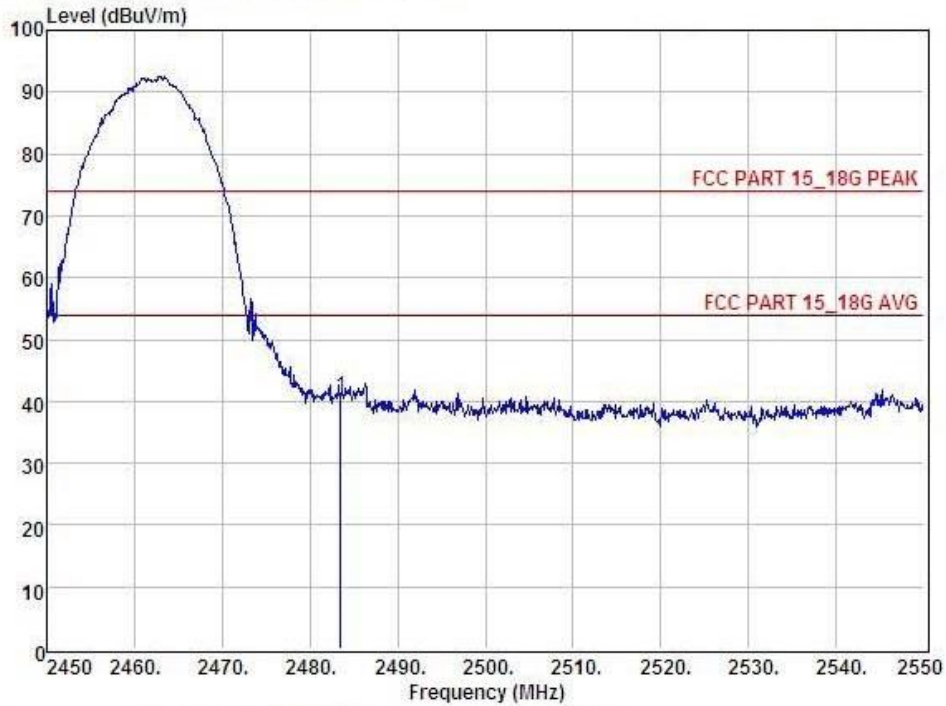

Condition : FCC PART 15_18G PEAK 3m POL: VERTICAL									
Item	Freq	Read Level	Antenna Factor	Preamp Factor	Cable Loss	Level	Limit	Margin	Remark
	MHz	dBuV	dB	dB	dB	dBuV	dBuV	dBuV	
1	2483.50	44.21	27.59	34.97	4.00	40.83	74.00	-33.17	Peak

Remark: Level = Read Level + Antenna Factor - Preamp Factor + Cable Loss

EUT :	Wireless USB Adapter	Model Name :	JN7
Temperature :	20 °C	Relative Humidity :	48%
Pressure :	1010 hPa	Test Voltage :	DC 5 V from PC with AC 120V/60Hz
Test Mode :	CH1(802.11g Mode)	Polarization :	Horizontal

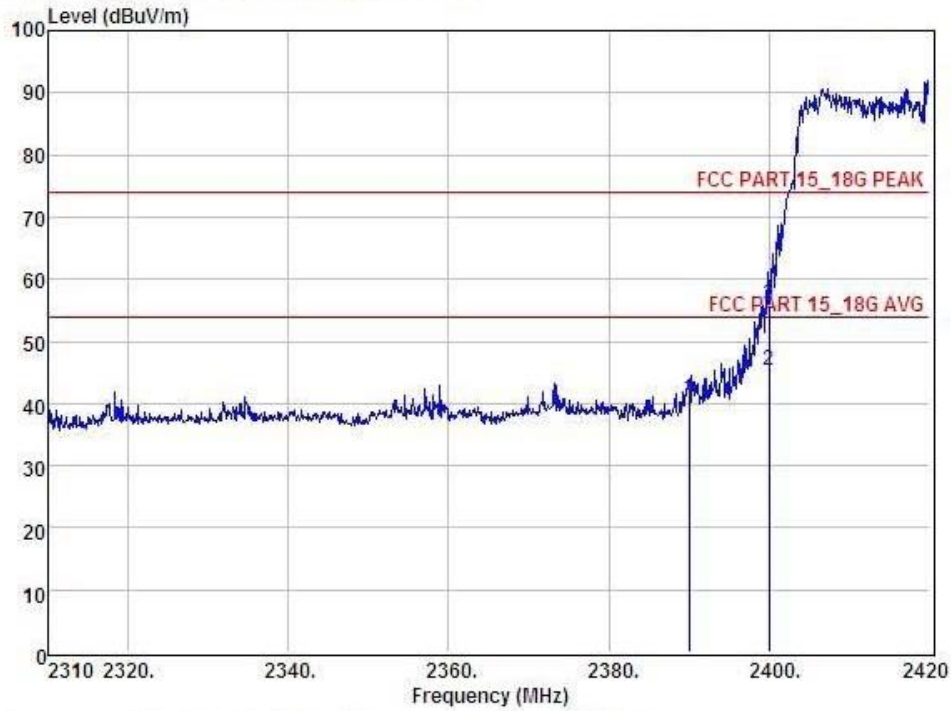

Condition : FCC PART 15_18G PEAK 3m POL: HORIZONTAL									
Item	Freq	Read	Antenna	Preamp	Cable	Level	Limit	Margin	Remark
	MHz	Level	Factor	Factor	Loss	dBuV	dBuV	dBuV	
		dBuV	dB	dB	dB				
1	2390.00	44.12	27.62	34.97	3.92	40.69	74.00	-33.31	Peak
2	2400.00	48.79	27.62	34.97	3.94	45.38	54.00	-8.62	Average
3	2400.00	59.30	27.62	34.97	3.94	55.89	74.00	-18.11	Peak

Remark: Level = Read Level + Antenna Factor - Preamp Factor + Cable Loss

EUT :	Wireless USB Adapter	Model Name :	JN7
Temperature :	20 °C	Relative Humidity :	48%
Pressure :	1010 hPa	Test Voltage :	DC 5 V from PC with AC 120V/60Hz
Test Mode :	CH1(802.11gMode)	Polarization :	Vertical

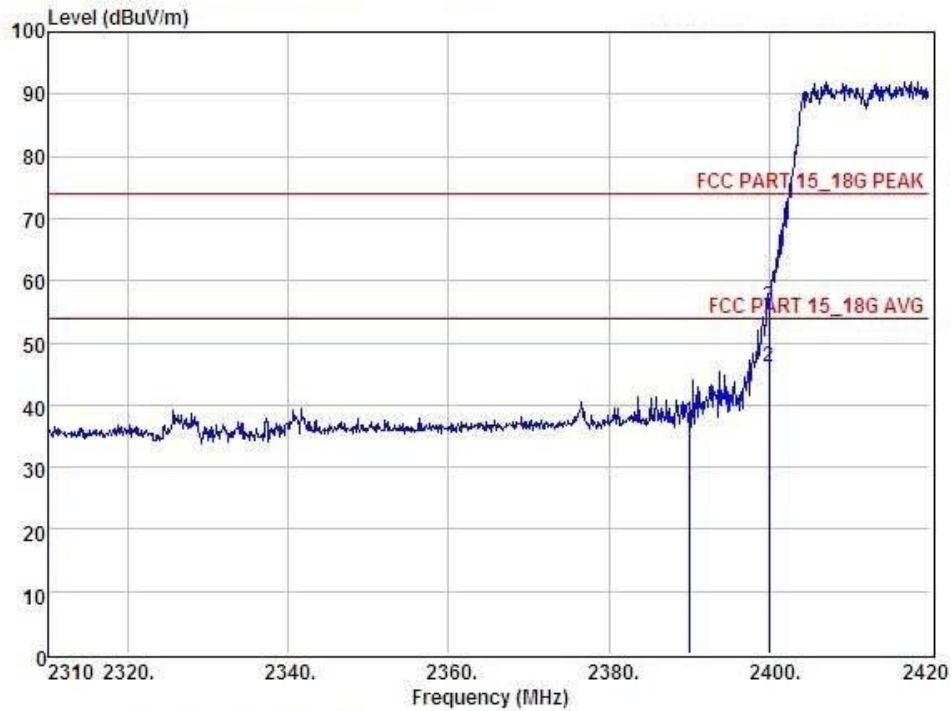

Condition		: FCC PART 15_18G PEAK 3m					POL: VERTICAL			
Item	Freq	Read	Antenna	Preamp	Cable	Level	Limit	Margin	Remark	
	MHz	Level	Factor	Factor	Loss	dBuV	dBuV	dBuV		
		dBuV	dB	dB	dB					
1	2390.00	40.79	27.62	34.97	3.92	37.36	74.00	-36.64	Peak	
2	2400.00	49.84	27.62	34.97	3.94	46.13	54.00	-7.87	Average	
3	2400.00	59.09	27.62	34.97	3.94	55.68	74.00	-18.32	Peak	

Remark: Level = Read Level + Antenna Factor - Preamp Factor + Cable Loss

EUT :	Wireless USB Adapter	Model Name :	JN7
Temperature :	20 °C	Relative Humidity :	48%
Pressure :	1010 hPa	Test Voltage :	DC 5 V from PC with AC 120V/60Hz
Test Mode :	CH11(802.11g Mode)	Polarization :	Horizontal

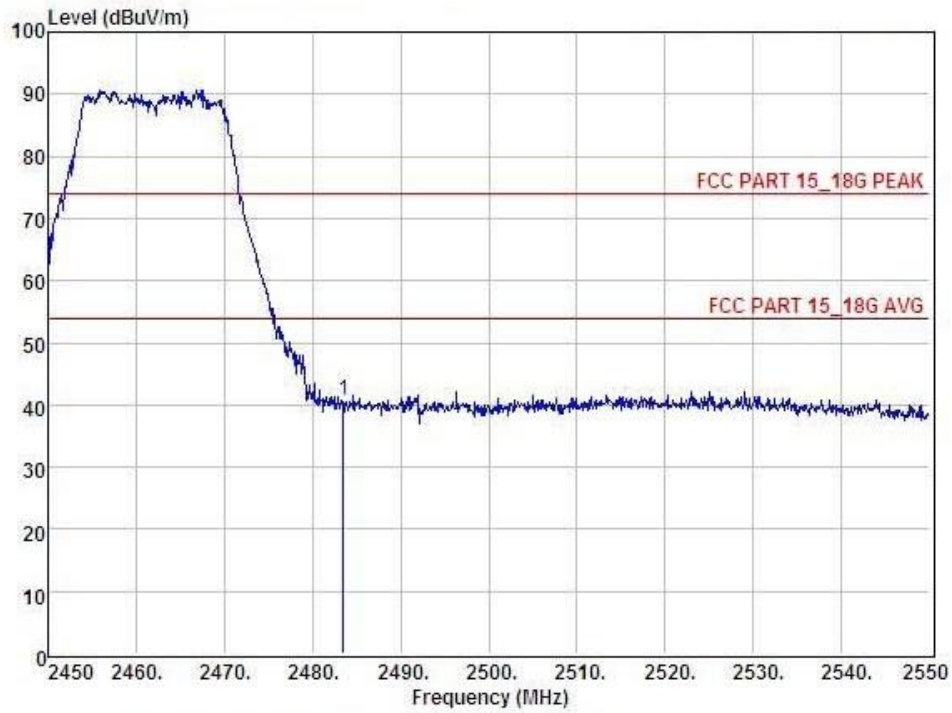

Condition : FCC PART 15_18G PEAK 3m POL: HORIZONTAL									
Item	Freq	Read	Antenna	Preamp	Cable	Level	Limit	Margin	Remark
	MHz	dBuV	Factor	Factor	Loss	dBuV	dBuV	dBuV	
1	2483.50	44.00	27.59	34.97	4.00	40.62	74.00	-33.38	Peak

Remark: Level = Read Level + Antenna Factor - Preamp Factor + Cable Loss

EUT :	Wireless USB Adapter	Model Name :	JN7
Temperature :	20 °C	Relative Humidity :	48%
Pressure :	1010 hPa	Test Voltage :	DC 5 V from PC with AC 120V/60Hz
Test Mode :	CH11(802.11g Mode)	Polarization :	Vertical

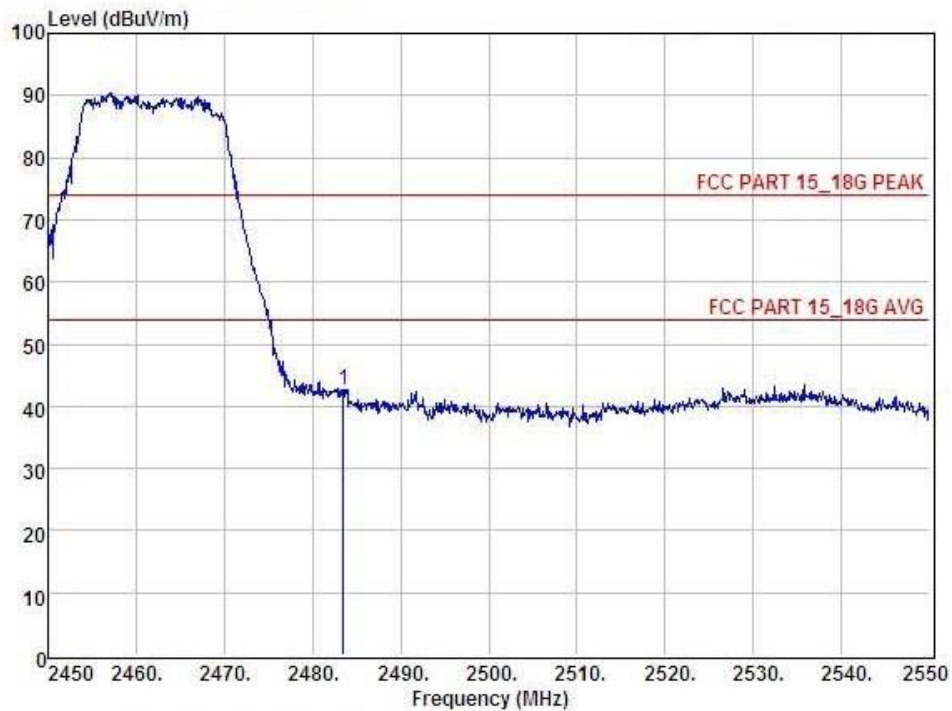

Condition : FCC PART 15_18G PEAK 3m POL: VERTICAL									
Item	Freq	Read	Antenna	Preamp	Cable	Level	Limit	Margin	Remark
	MHz	Level	Factor	Factor	Loss	dBuV	dBuV	dBuV	
		dBuV	dB	dB	dB				
1	2483.50	46.12	27.59	34.97	4.00	42.74	74.00	-31.26	Peak

Remark: Level = Read Level + Antenna Factor - Preamp Factor + Cable Loss

EUT :	Wireless USB Adapter	Model Name :	JN7
Temperature :	20 °C	Relative Humidity :	48%
Pressure :	1010 hPa	Test Voltage :	DC 5 V from PC with AC 120V/60Hz
Test Mode :	CH1(802.11n Mode)/20MHz	Polarization :	Horizontal

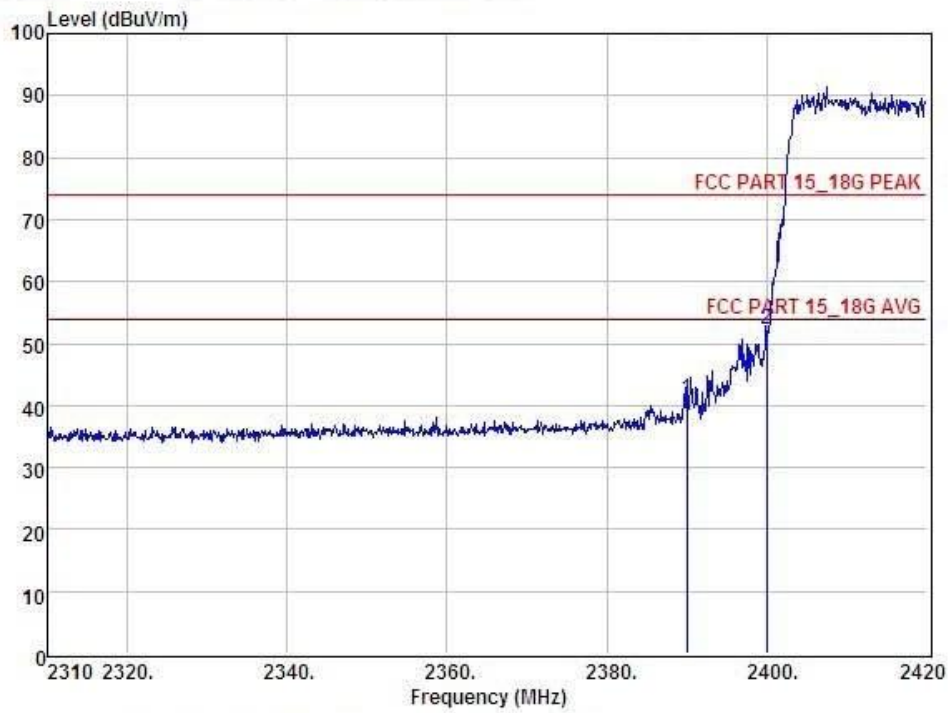

Condition : FCC PART 15_18G PEAK 3m POL: HORIZONTAL

Item	Freq MHz	Read Level dBuV	Antenna Factor dB	Preamp Factor dB	Cable Loss dB	Level dBuV	Limit dBuV	Margin dBuV	Remark
1	2390.00	44.40	27.62	34.97	3.92	40.97	74.00	-33.03	Peak
2	2400.00	55.60	27.62	34.97	3.94	52.19	74.00	-21.81	Peak

Remark: Level = Read Level + Antenna Factor - Preamp Factor + Cable Loss

EUT :	Wireless USB Adapter	Model Name :	JN7
Temperature :	20 °C	Relative Humidity :	48%
Pressure :	1010 hPa	Test Voltage :	DC 5 V from PC with AC 120V/60Hz
Test Mode :	CH1(802.11n Mode)/20M	Polarization :	Vertical

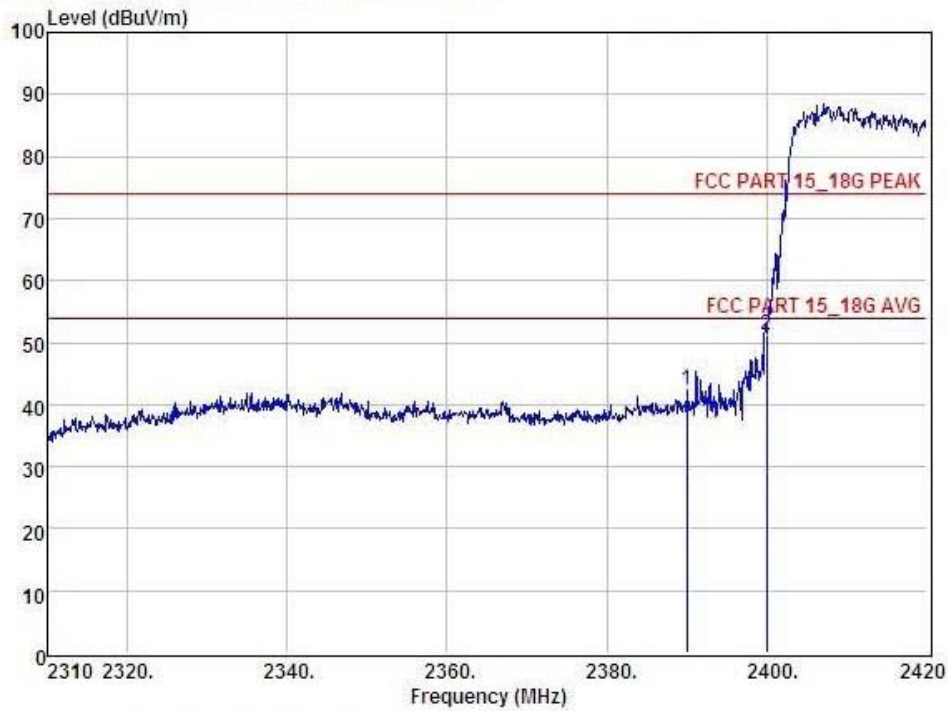

Condition : FCC PART 15_18G PEAK 3m POL: VERTICAL

Item	Freq MHz	Read Level dBuV	Antenna Factor dB	Preamp Factor dB	Cable Loss dB	Level dBuV	Limit dBuV	Margin dBuV	Remark
1	2390.00	45.84	27.62	34.97	3.92	42.41	74.00	-31.59	Peak
2	2400.00	54.69	27.62	34.97	3.94	51.28	74.00	-22.72	Peak

Remark: Level = Read Level + Antenna Factor - Preamp Factor + Cable Loss

EUT :	Wireless USB Adapter	Model Name :	JN7
Temperature :	20 °C	Relative Humidity :	48%
Pressure :	1010 hPa	Test Voltage :	DC 5 V from PC with AC 120V/60Hz
Test Mode :	CH11(802.11n Mode)/20MHz	Polarization :	Horizontal

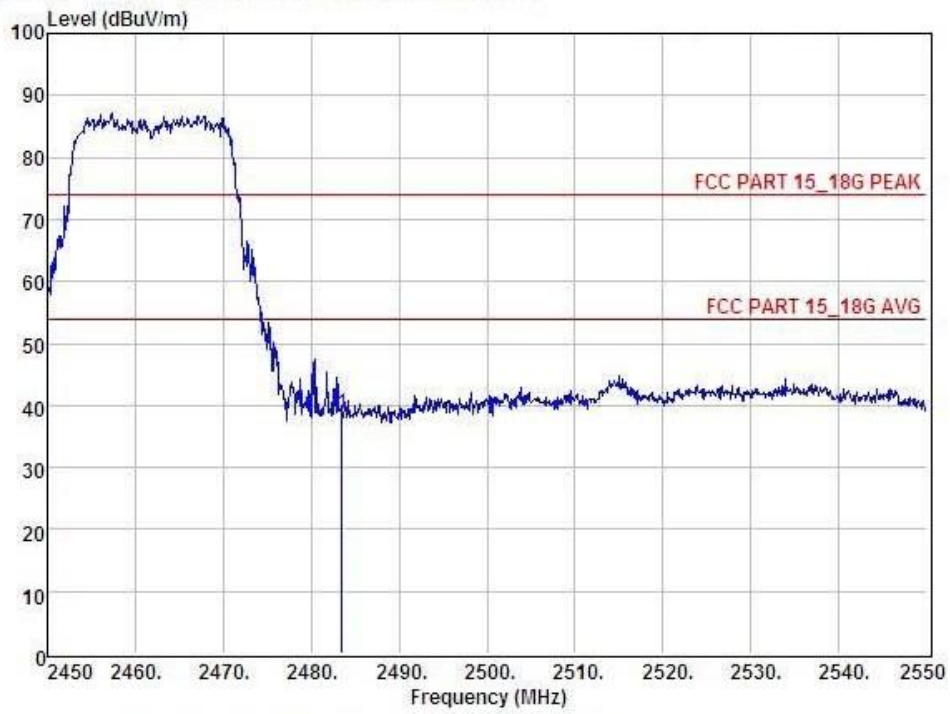

Condition : FCC PART 15_18G PEAK 3m POL: HORIZONTAL

Item	Freq MHz	Read Level dBuV	Antenna Factor dB	Preamp Factor dB	Cable Loss dB	Level dBuV	Limit dBuV	Margin dBuV	Remark
1	2483.50	42.00	27.59	34.97	4.00	38.62	74.00	-35.38	Peak

Remark: Level = Read Level + Antenna Factor - Preamp Factor + Cable Loss

EUT :	Wireless USB Adapter	Model Name :	JN7
Temperature :	20 °C	Relative Humidity :	48%
Pressure :	1010 hPa	Test Voltage :	DC 5 V from PC with AC 120V/60Hz
Test Mode :	CH11(802.11n Mode)/20MHz	Polarization :	Vertical

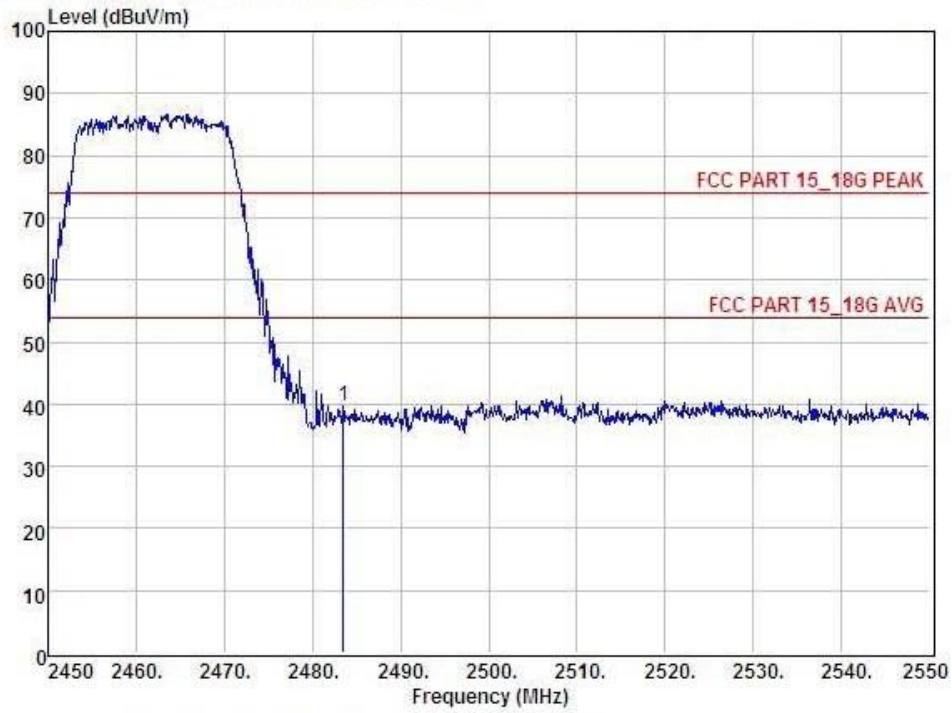

Condition : FCC PART 15_18G PEAK 3m POL: VERTICAL

Item	Freq MHz	Read Level dBuV	Antenna Factor dB	Preamp Factor dB	Cable Loss dB	Level dBuV	Limit dBuV	Margin dBuV	Remark
1	2483.50	43.06	27.59	34.97	4.00	39.68	74.00	-34.32	Peak

Remark: Level = Read Level + Antenna Factor - Preamp Factor + Cable Loss

EUT :	Wireless USB Adapter	Model Name :	JN7
Temperature :	20 °C	Relative Humidity :	48%
Pressure :	1010 hPa	Test Voltage :	DC 5 V from PC with AC 120V/60Hz
Test Mode :	CH3(802.11n Mode)/40M	Polarization :	Horizontal

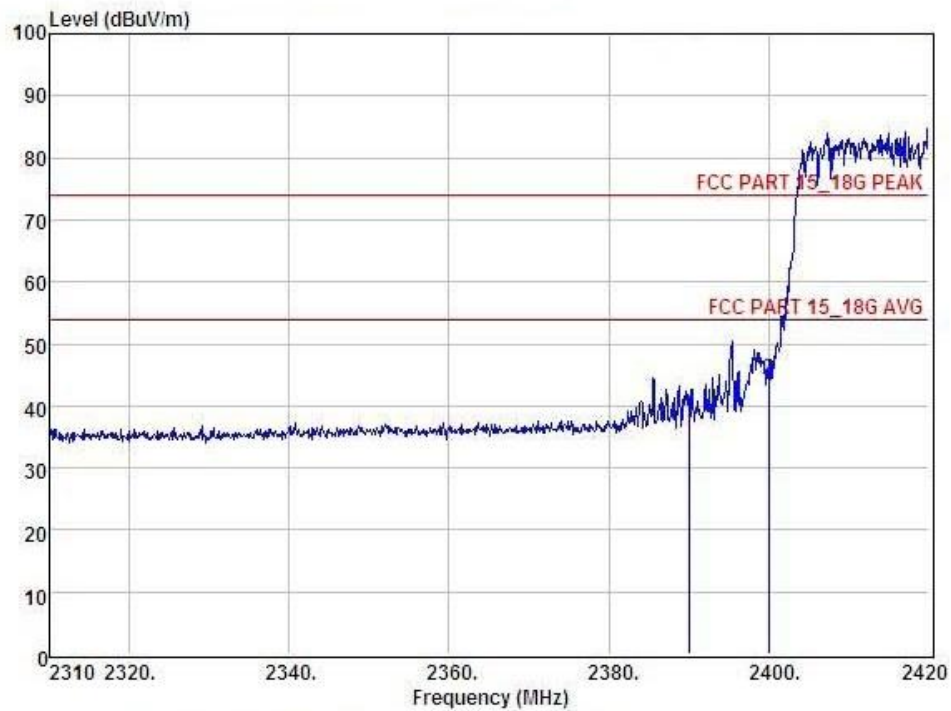

Condition : FCC PART 15_18G PEAK 3m POL: HORIZONTAL									
Item	Freq	Read Level	Antenna Factor	Preamp Factor	Cable Loss	Level	Limit	Margin	Remark
	MHz	dBuV	dB	dB	dB	dBuV	dBuV	dBuV	
1	2390.00	41.78	27.62	34.97	3.92	38.35	74.00	-35.65	Peak
2	2400.00	47.64	27.62	34.97	3.94	44.23	74.00	-29.77	Peak

Remark: Level = Read Level + Antenna Factor - Preamp Factor + Cable Loss

EUT :	Wireless USB Adapter	Model Name :	JN7
Temperature :	20 °C	Relative Humidity :	48%
Pressure :	1010 hPa	Test Voltage :	DC 5 V from PC with AC 120V/60Hz
Test Mode :	CH3(802.11n Mode)/40MHz	Polarization :	Vertical

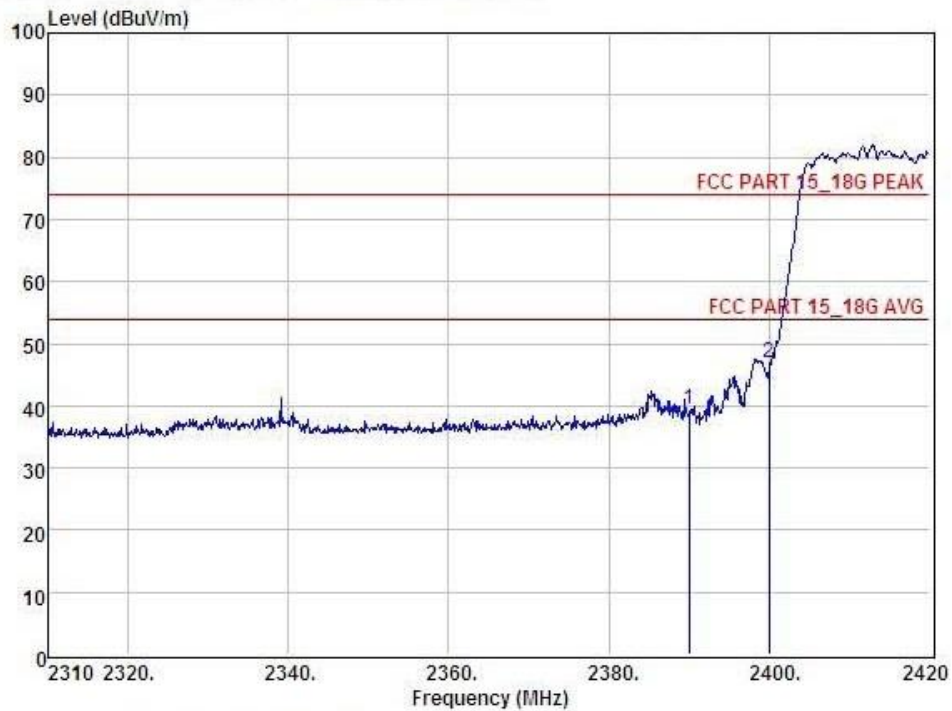

Condition : FCC PART 15_18G PEAK 3m POL: VERTICAL									
Item	Freq	Read Level	Antenna Factor	Preamp Factor	Cable Loss	Level	Limit	Margin	Remark
	MHz	dBuV	dB	dB	dB	dBuV	dBuV	dBuV	
1	2390.00	42.97	27.62	34.97	3.92	39.54	74.00	-34.46	Peak
2	2400.00	50.34	27.62	34.97	3.94	46.93	74.00	-27.07	Peak

Remark: Level = Read Level + Antenna Factor - Preamp Factor + Cable Loss

EUT :	Wireless USB Adapter	Model Name :	JN7
Temperature :	20 °C	Relative Humidity :	48%
Pressure :	1010 hPa	Test Voltage :	DC 5 V from PC with AC 120V/60Hz
Test Mode :	CH9(802.11n Mode)/40MHz	Polarization :	Horizontal

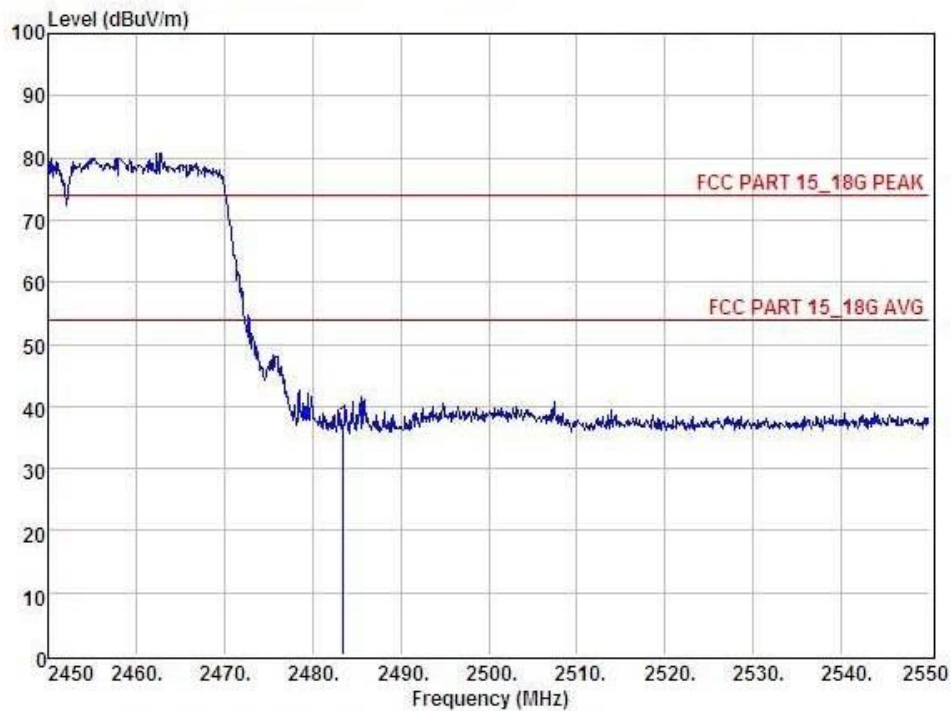

Item	Freq MHz	Read Level dBuV	Antenna Factor dB	Preamp Factor dB	Cable Loss dB	Level dBuV	Limit dBuV	Margin dBuV	Remark
1	2483.50	40.35	27.59	34.97	4.00	36.97	74.00	-37.03	Peak

Remark: Level = Read Level + Antenna Factor - Preamp Factor + Cable Loss

EUT :	Wireless USB Adapter	Model Name :	JN7
Temperature :	20 °C	Relative Humidity :	48%
Pressure :	1010 hPa	Test Voltage :	DC 5 V from PC with AC 120V/60Hz
Test Mode :	CH9(802.11n Mode)/40MHz	Polarization :	Vertical

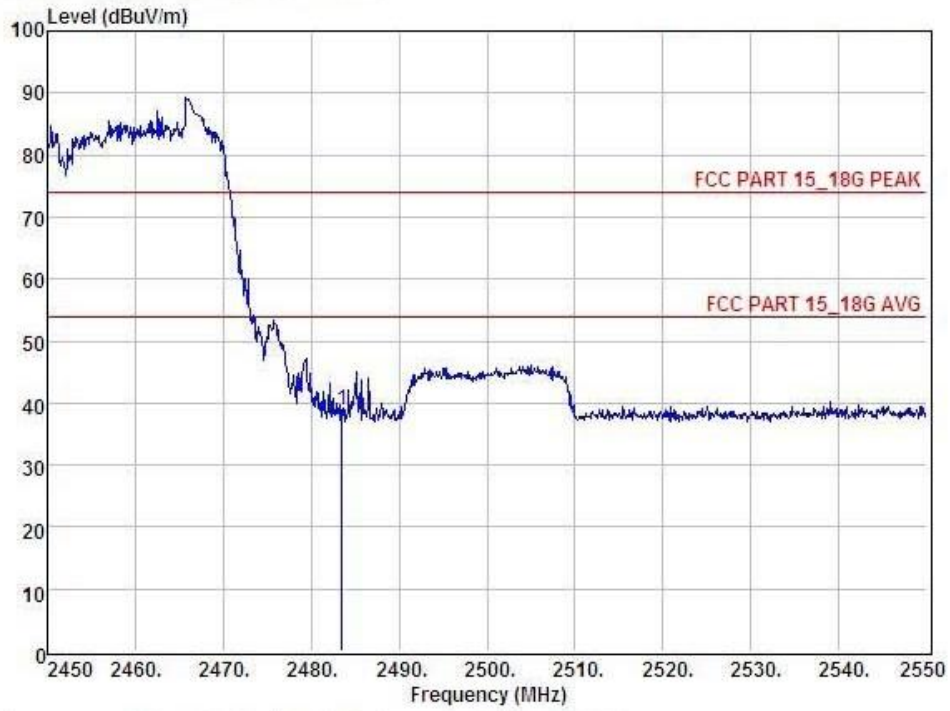

Condition : FCC PART 15_18G PEAK 3m POL: VERTICAL									
Item	Freq	Read	Antenna	Preamp	Cable	Level	Limit	Margin	Remark
	MHz	dBuV	Factor	Factor	Loss	dBuV	dBuV	dBuV	

1	2483.50	42.29	27.59	34.97	4.00	38.91	74.00	-35.09	Peak

Remark: Level = Read Level + Antenna Factor - Preamp Factor + Cable Loss

4. POWER SPECTRAL DENSITY TEST

4.1 APPLIED PROCEDURES / LIMIT

FCC Part15 (15.247) , Subpart C				
Section	Test Item	Limit	Frequency Range (MHz)	Result
15.247	Power Spectral Density	8 dBm (in any 3KHz)	2400-2483.5	PASS

4.1.1 TEST PROCEDURE

1. Set analyzer center frequency to DTS channel center frequency.
2. Set the span to 1.5 times the DTS channel bandwidth.
3. Set the RBW \geq 3 kHz.
4. Set the VBW \geq 3 x RBW.
5. Detector = peak.
6. Sweep time = auto couple.
7. Trace mode = max hold.
8. Allow trace to fully stabilize.
9. Use the peak marker function to determine the maximum amplitude level.
10. If measured value exceeds limit, reduce RBW (no less than 3 kHz) and repeat.

4.1.2 DEVIATION FROM STANDARD

No deviation.

4.1.3 TEST SETUP



4.1.4 EUT OPERATION CONDITIONS

The EUT tested system was configured as the statements of 2.3 Unless otherwise a special operating condition is specified in the follows during the testing.

4.1.5 TEST RESULTS

EUT :	Wireless USB Adapter	Model Name :	JN7
Temperature :	25 °C	Relative Humidity :	60%
Pressure :	1015 hPa	Test Voltage :	DC 5 V from PC with AC 120V/60Hz
Test Mode :	TX b Mode /CH01, CH06, CH11		

Frequency	Power Density (dBm)	Limit (dBm)	Result
2412 MHz	-3.01	8	PASS
2437 MHz	2.78	8	PASS
2462 MHz	-4.52	8	PASS

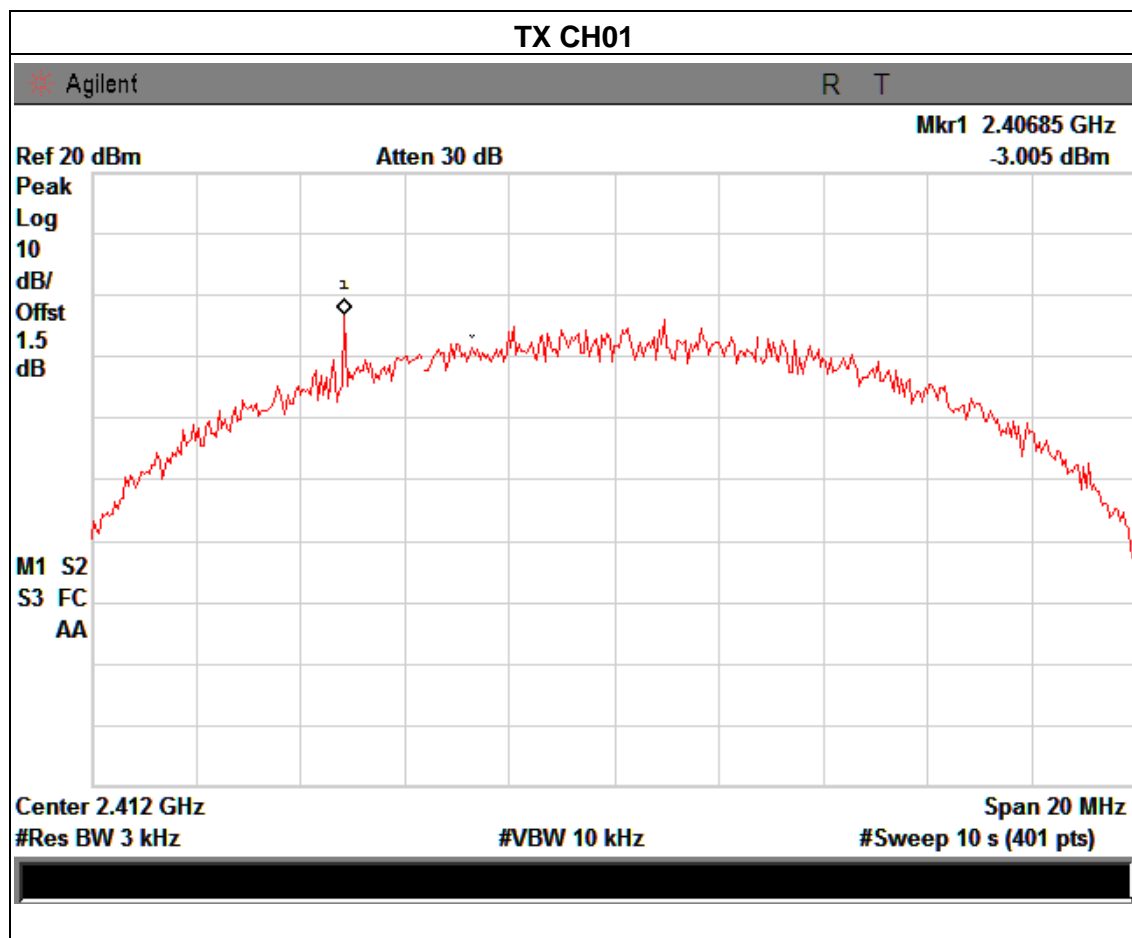

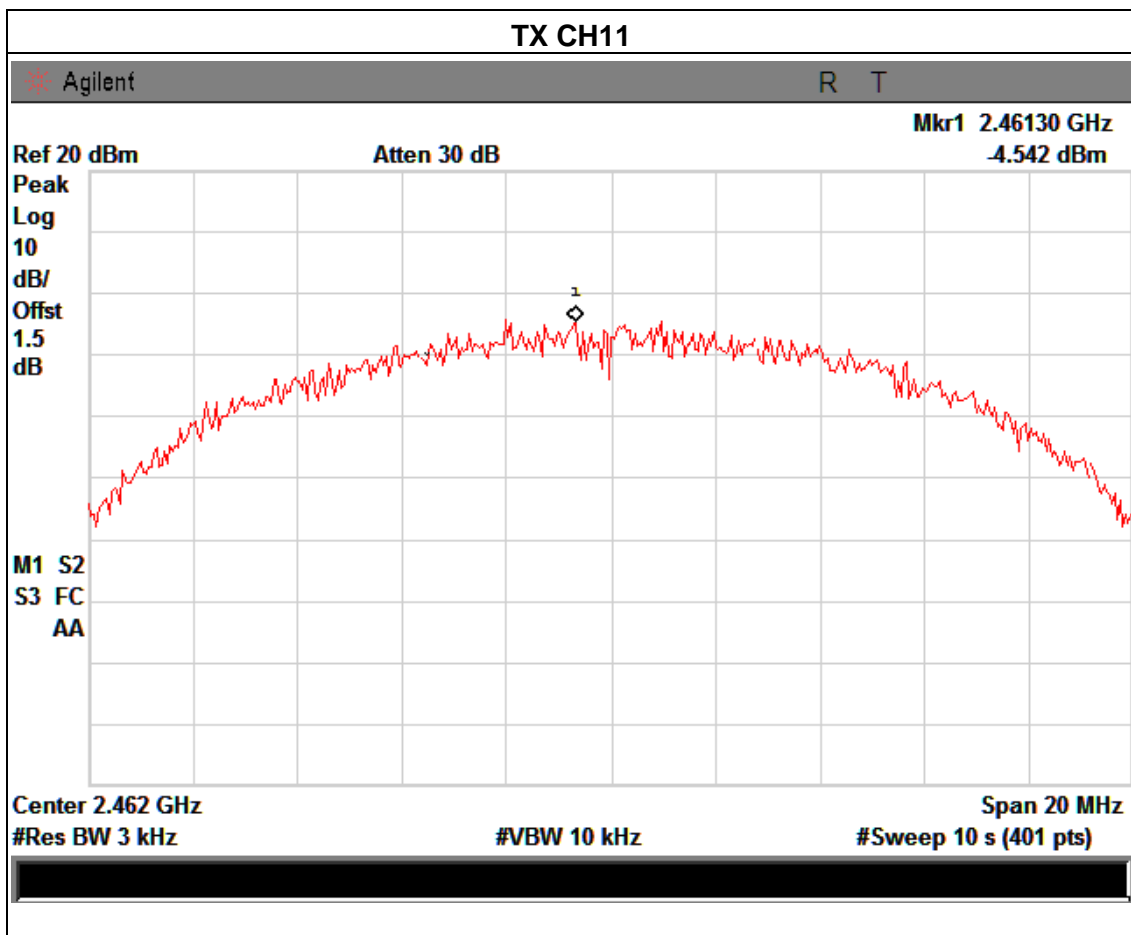
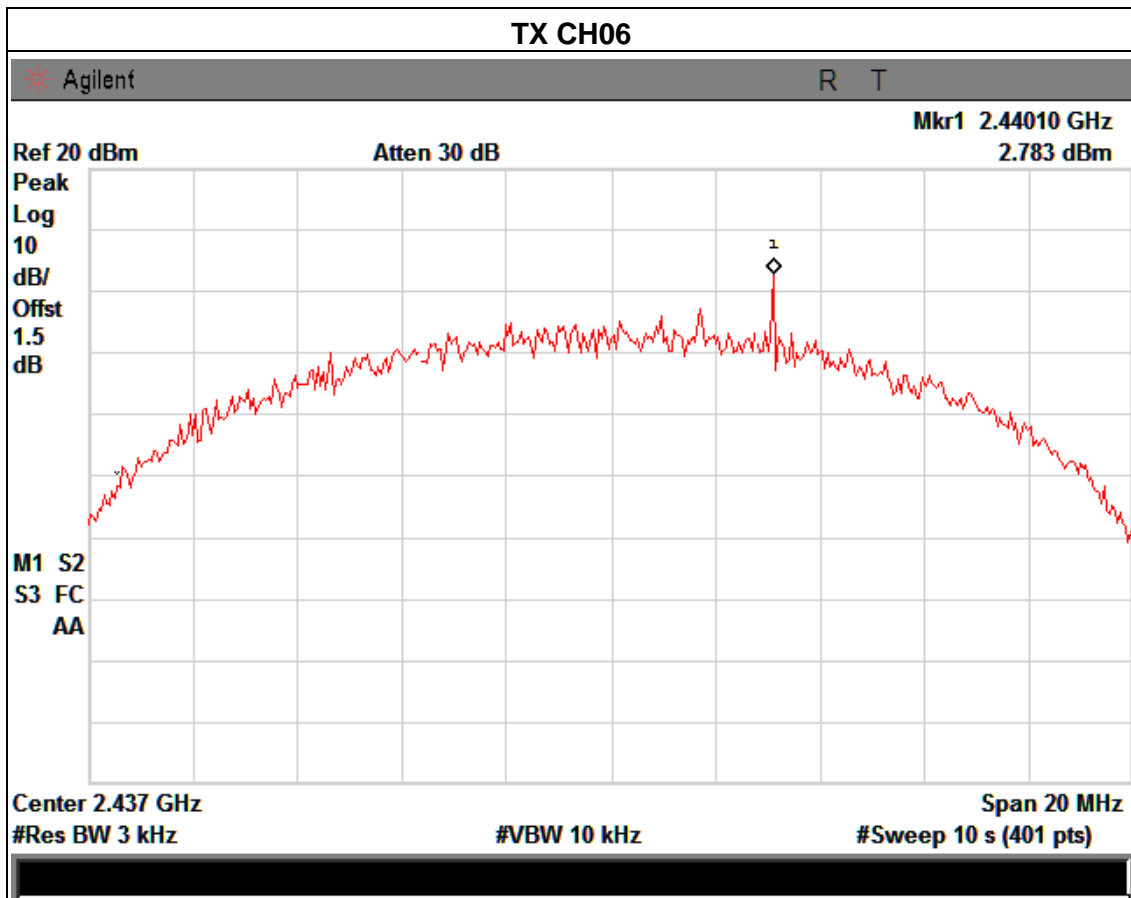

EUT :	Wireless USB Adapter	Model Name :	JN7
Temperature :	25 °C	Relative Humidity :	60%
Pressure :	1015 hPa	Test Voltage :	DC 5 V from PC with AC 120V/60Hz
Test Mode :	TX g Mode /CH01, CH06, CH11		

Frequency	Power Density (dBm)	Limit (dBm)	Result
2412 MHz	-12.19	8	PASS
2437 MHz	-12.27	8	PASS
2462 MHz	-11.31	8	PASS

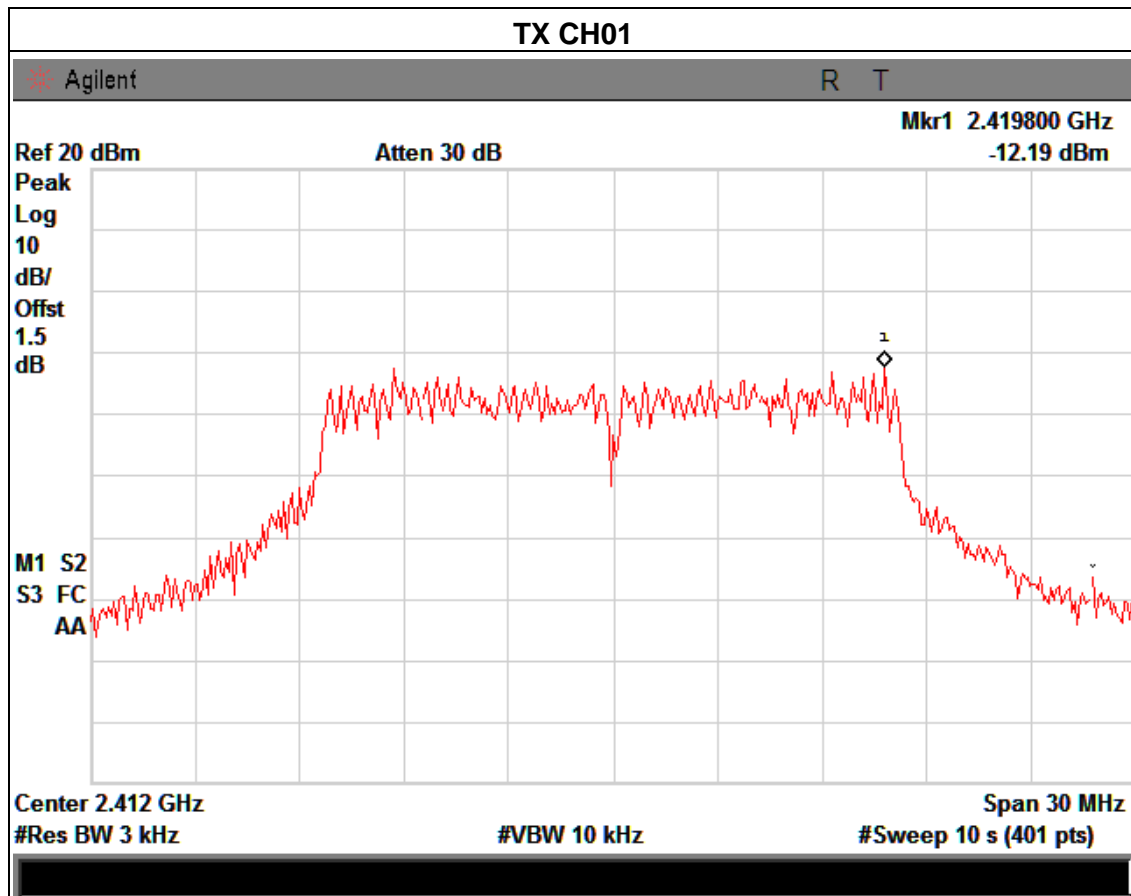

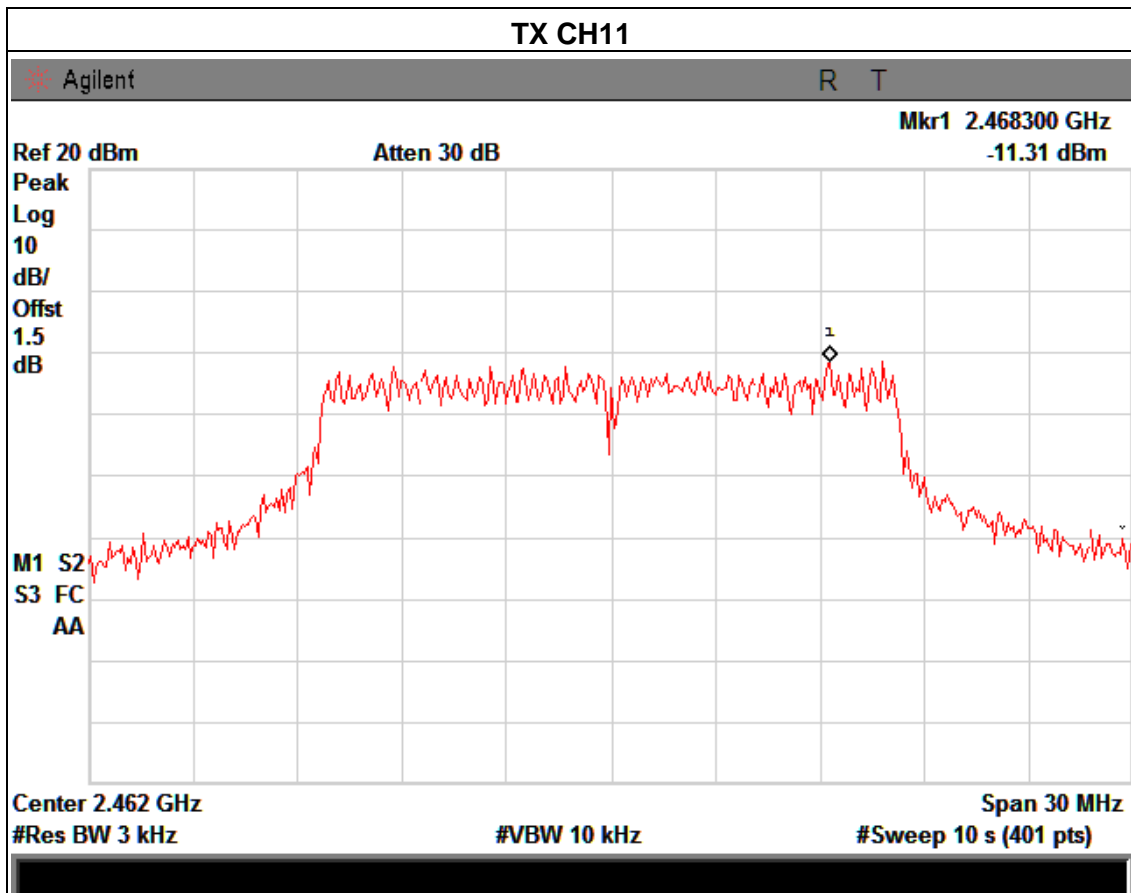
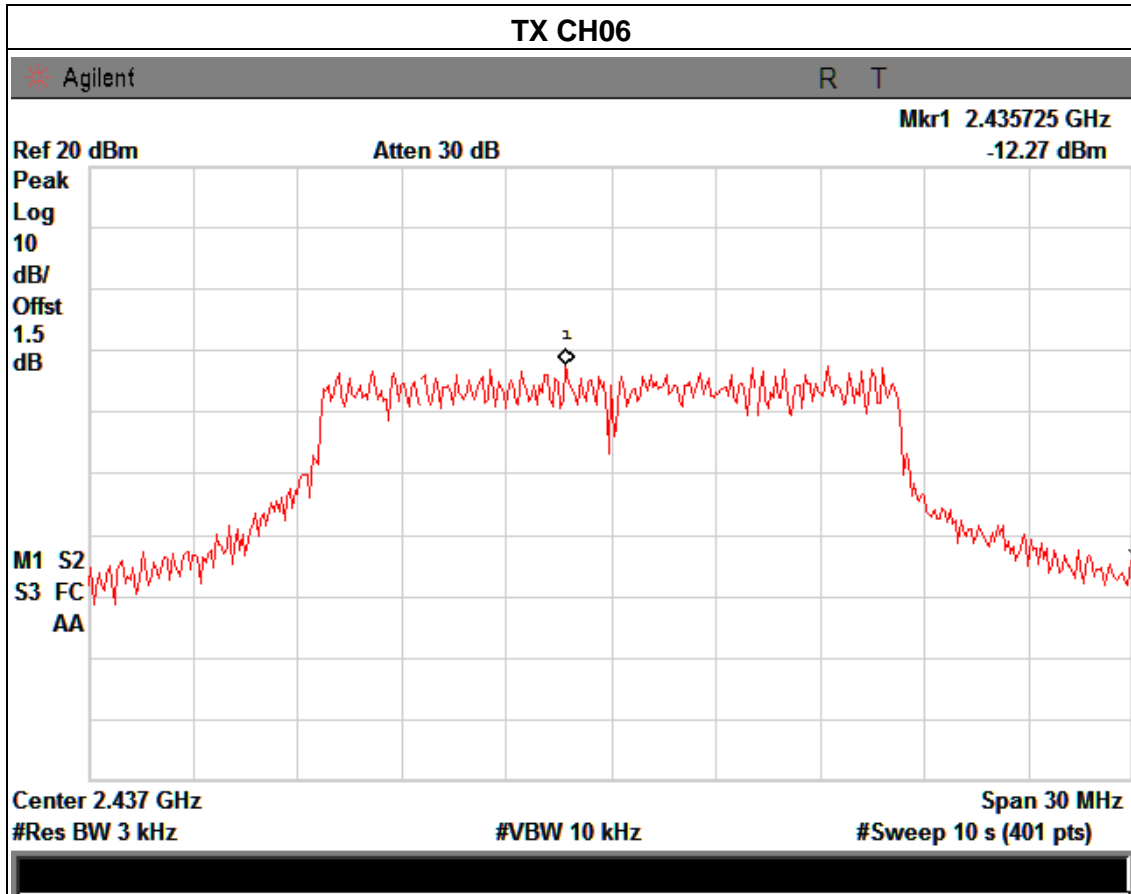

EUT :	Wireless USB Adapter	Model Name :	JN7
Temperature :	25 °C	Relative Humidity :	60%
Pressure :	1015 hPa	Test Voltage :	DC 5 V from PC with AC 120V/60Hz
Test Mode :	TX n Mode(20M) /CH01, CH06, CH11		

Frequency	Power Density (dBm)	Limit (dBm)	Result
2412 MHz	-12.02	8	PASS
2437 MHz	-11.75	8	PASS
2462 MHz	-10.51	8	PASS

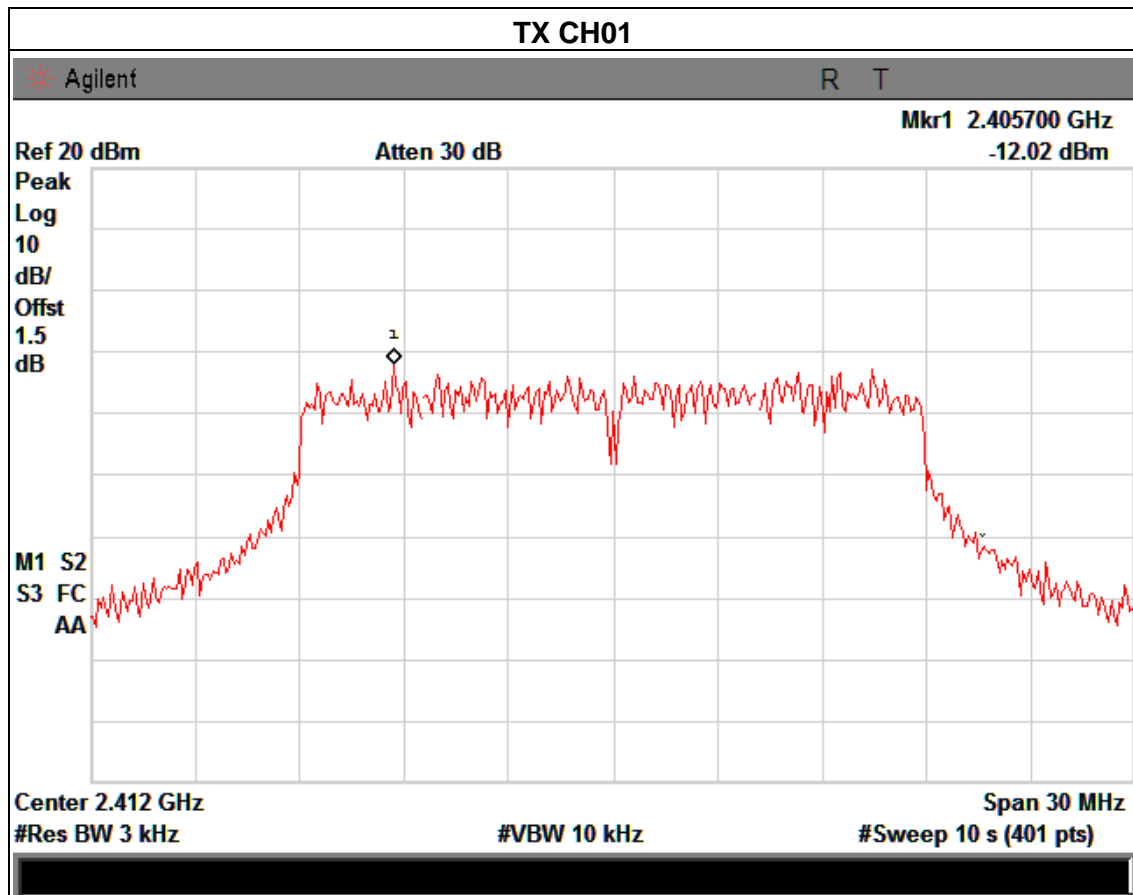

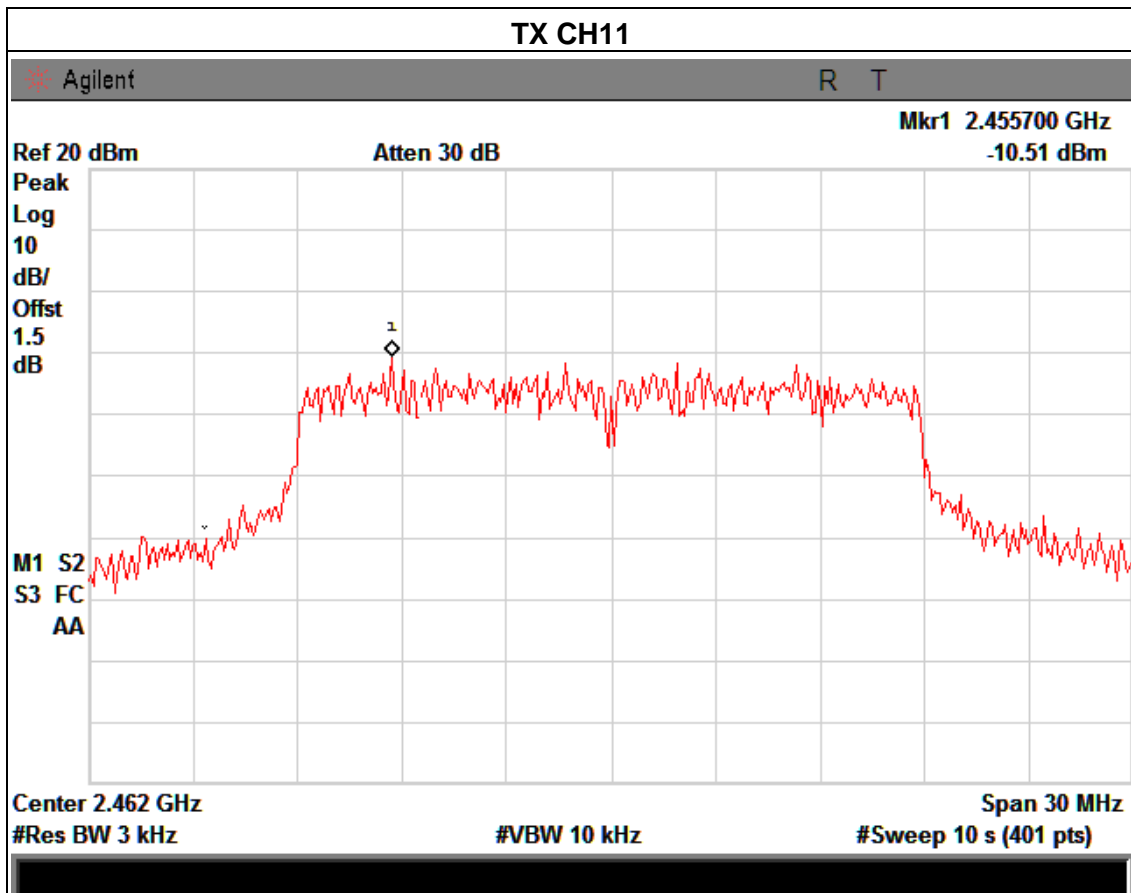
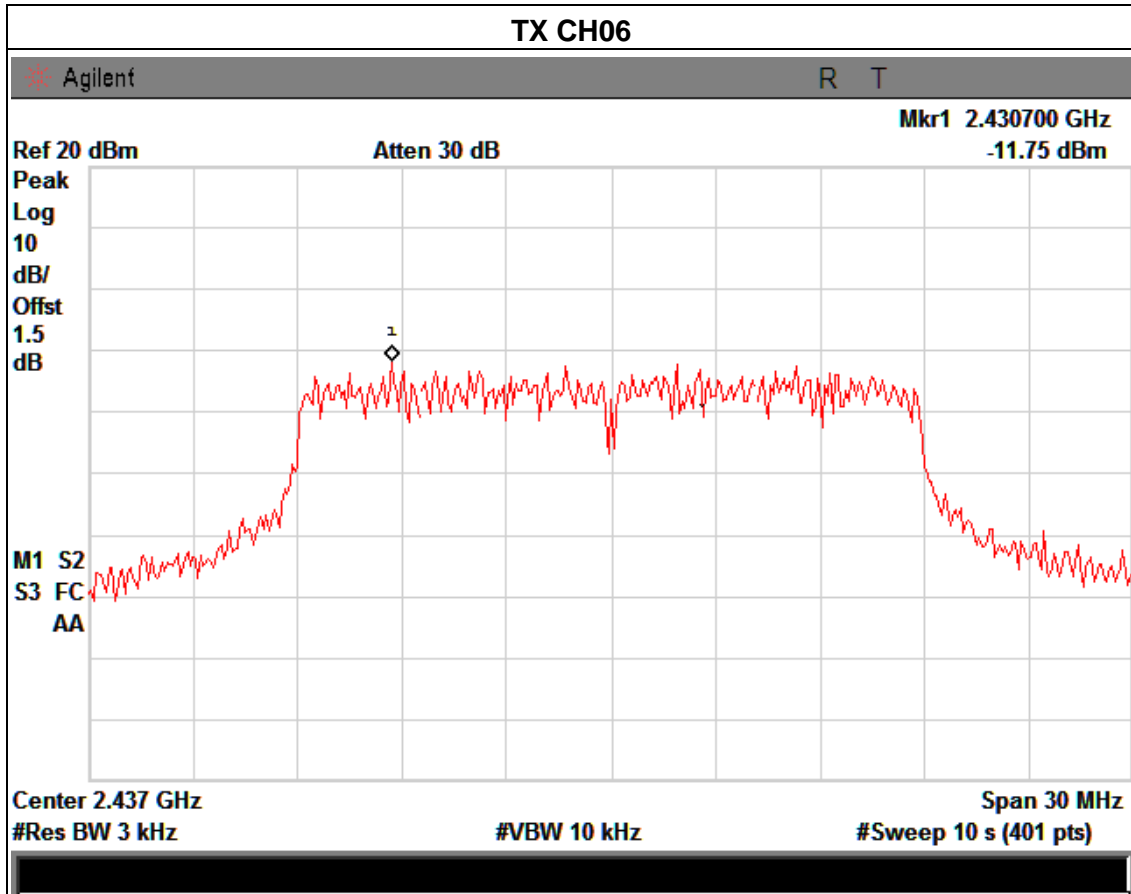

EUT :	Wireless USB Adapter	Model Name :	JN7
Temperature :	25 °C	Relative Humidity :	60%
Pressure :	1015 hPa	Test Voltage :	DC 5 V from PC with AC 120V/60Hz
Test Mode :	TX n Mode(40M) /CH03, CH06, CH09		

Frequency	Power Density (dBm)	Limit (dBm)	Result
2422 MHz	-12.05	8	PASS
2437 MHz	-11.90	8	PASS
2452 MHz	-12.55	8	PASS

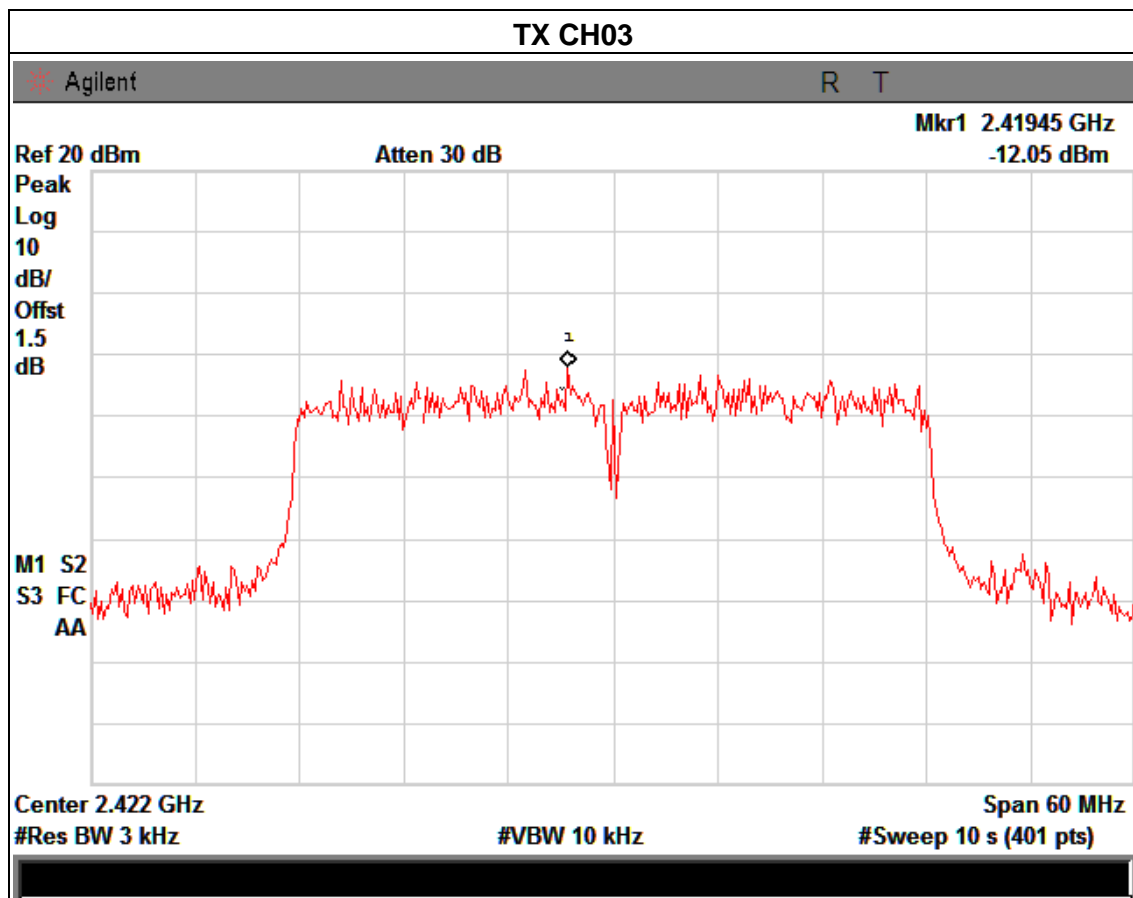

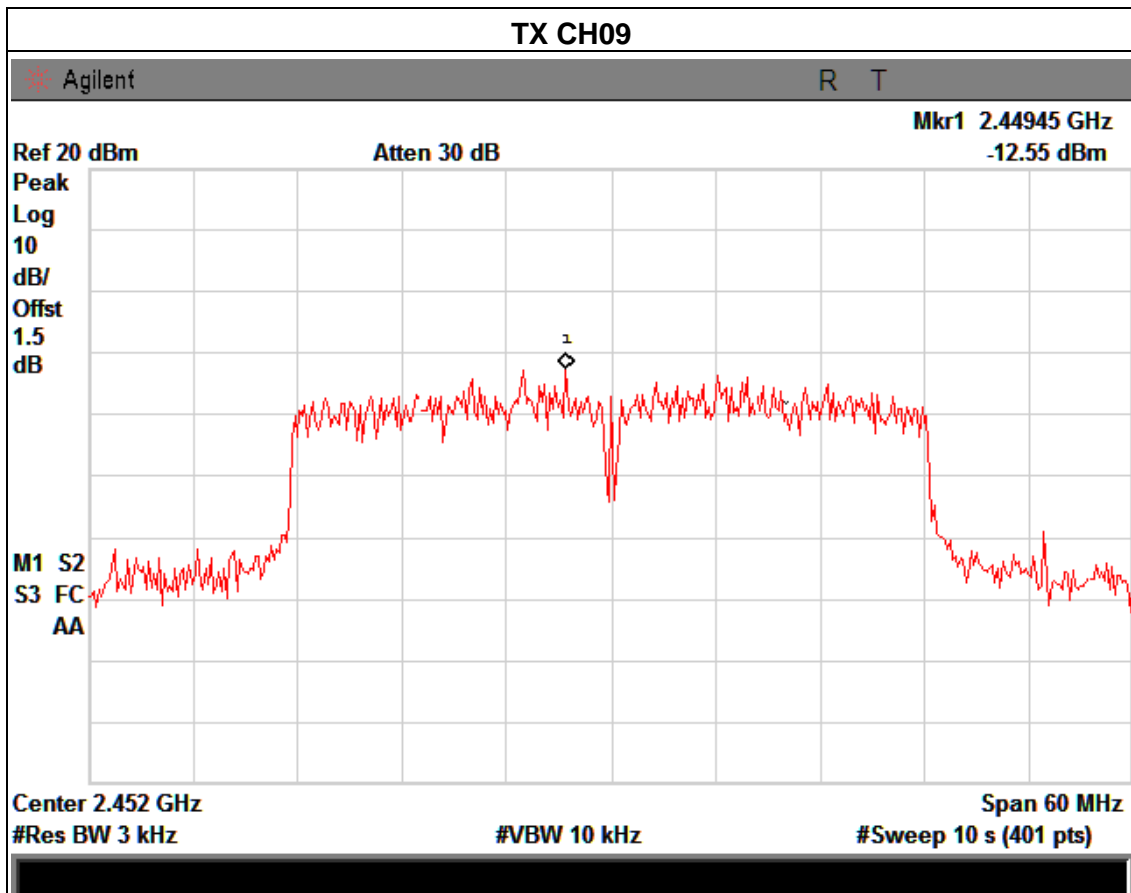
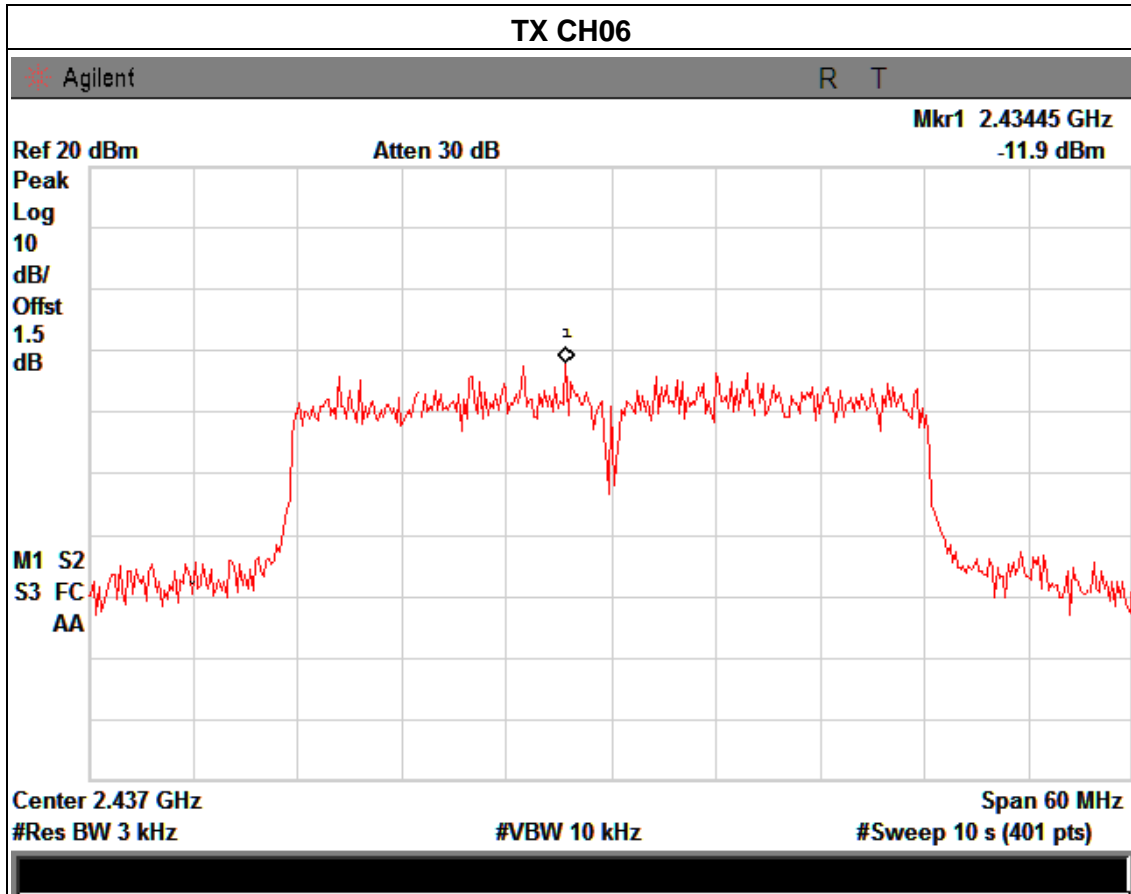

5. BANDWIDTH TEST

5.1 APPLIED PROCEDURES / LIMIT

FCC Part15 (15.247) , Subpart C				
Section	Test Item	Limit	Frequency Range (MHz)	Result
15.247(a)(2)	Bandwidth	$\geq 500\text{KHz}$ (6dB bandwidth)	2400-2483.5	PASS

5.1.1 TEST PROCEDURE

1. Set RBW = 100 kHz.
2. Set the video bandwidth (VBW) $\geq 3 \times$ RBW.
3. Detector = Peak.
4. Trace mode = max hold.
5. Sweep = auto couple.
6. Allow the trace to stabilize.
7. Measure the maximum width of the emission that is constrained by the frequencies associated with the two outermost amplitude points (upper and lower frequencies) that are attenuated by 6 dB relative to the maximum level measured in the fundamental emission.

5.1.2 DEVIATION FROM STANDARD

No deviation.

5.1.3 TEST SETUP

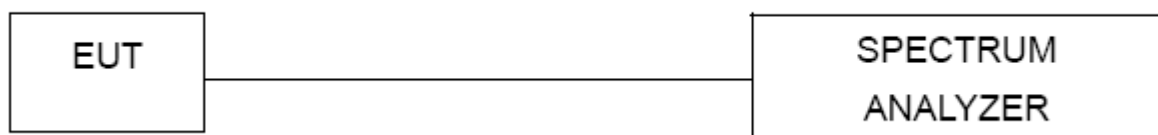

5.1.4 EUT OPERATION CONDITIONS

The EUT tested system was configured as the statements of 2.3 Unless otherwise a special operating condition is specified in the follows during the testing.

5.1.5 TEST RESULTS

EUT :	Wireless USB Adapter	Model Name :	JN7
Temperature :	25 °C	Relative Humidity :	60%
Pressure :	1012 hPa	Test Voltage :	DC 5 V from PC with AC 120V/60Hz
Test Mode :	TX b Mode /CH01, CH06, CH11		

Frequency	6dB Bandwidth (MHz)	99% Occupied BW (MHz)	Channel Separation (MHz)	Result
2412 MHz	10.01	14.92	>=500KHz	PASS
2437 MHz	9.41	15.08	>=500KHz	PASS
2462 MHz	10.03	15.42	>=500KHz	PASS

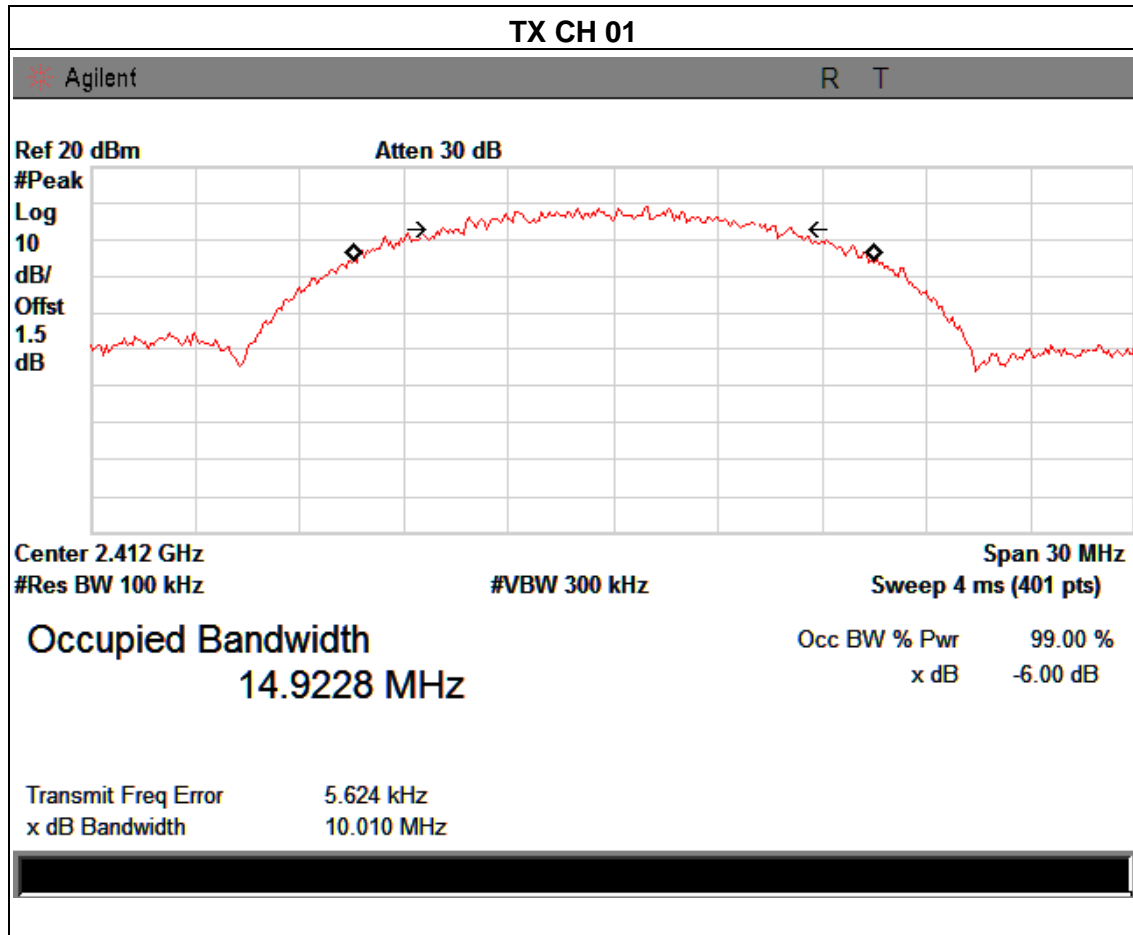

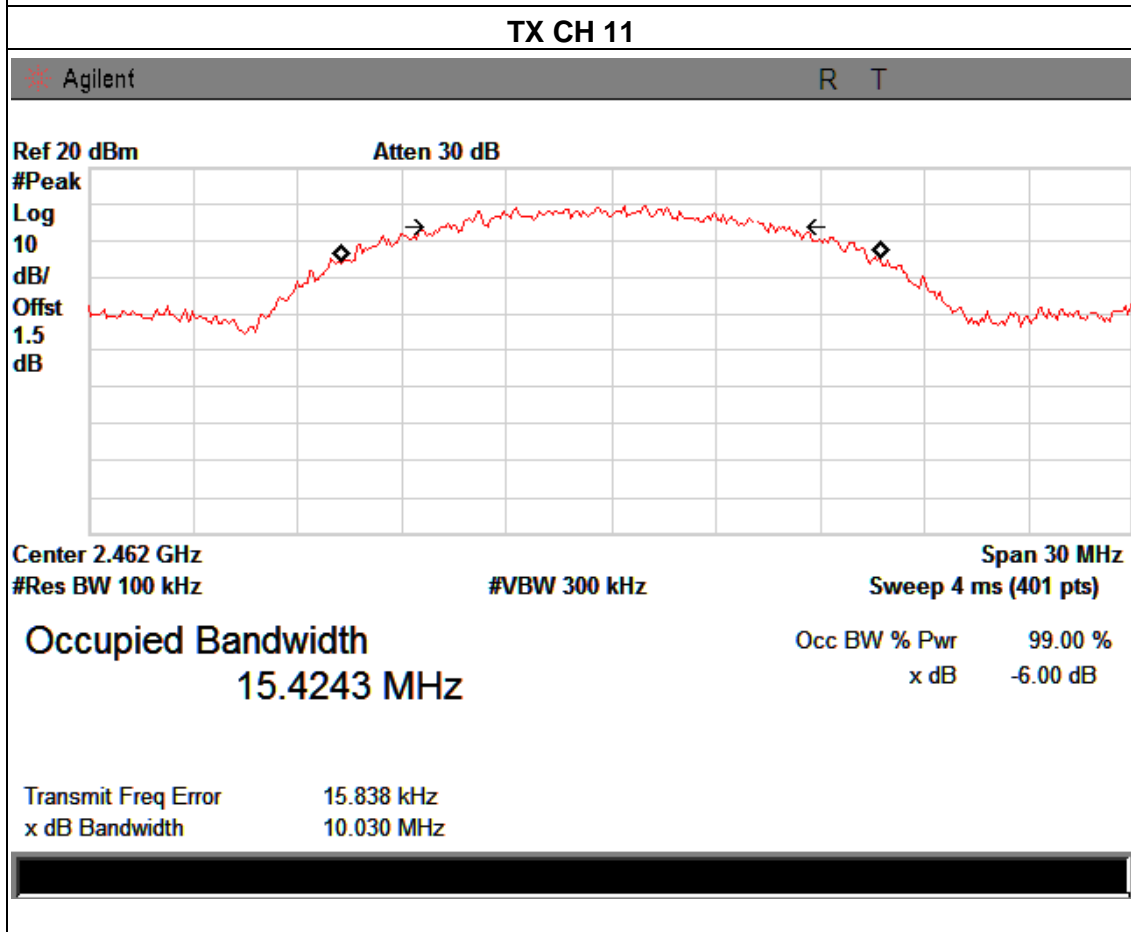
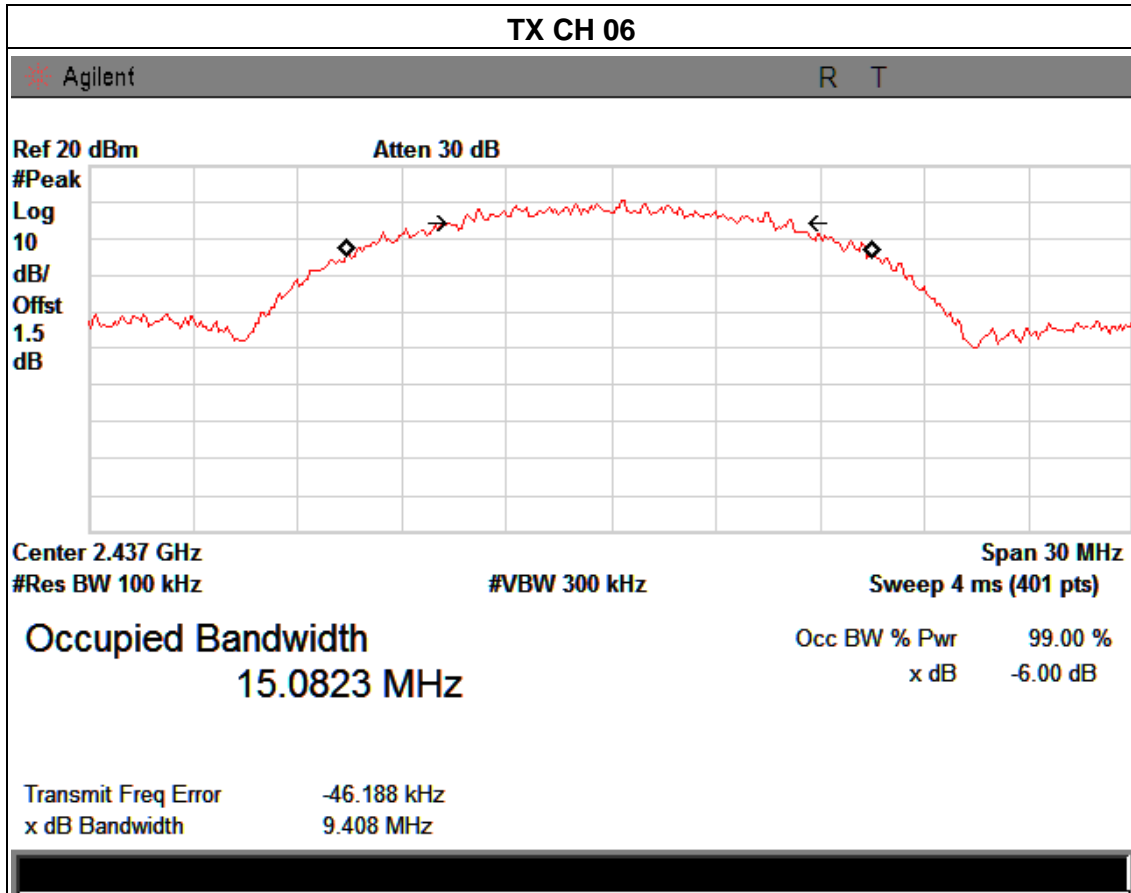

EUT :	Wireless USB Adapter	Model Name :	JN7
Temperature :	25 °C	Relative Humidity :	60%
Pressure :	1012 hPa	Test Voltage :	DC 5 V from PC with AC 120V/60Hz
Test Mode :	TX g Mode /CH01, CH06, CH11		

Frequency	6dB Bandwidth (MHz)	99% Occupied BW (MHz)	Channel Separation (MHz)	Result
2412 MHz	16.49	16.46	>=500KHz	PASS
2437 MHz	16.45	16.52	>=500KHz	PASS
2462 MHz	16.43	16.63	>=500KHz	PASS

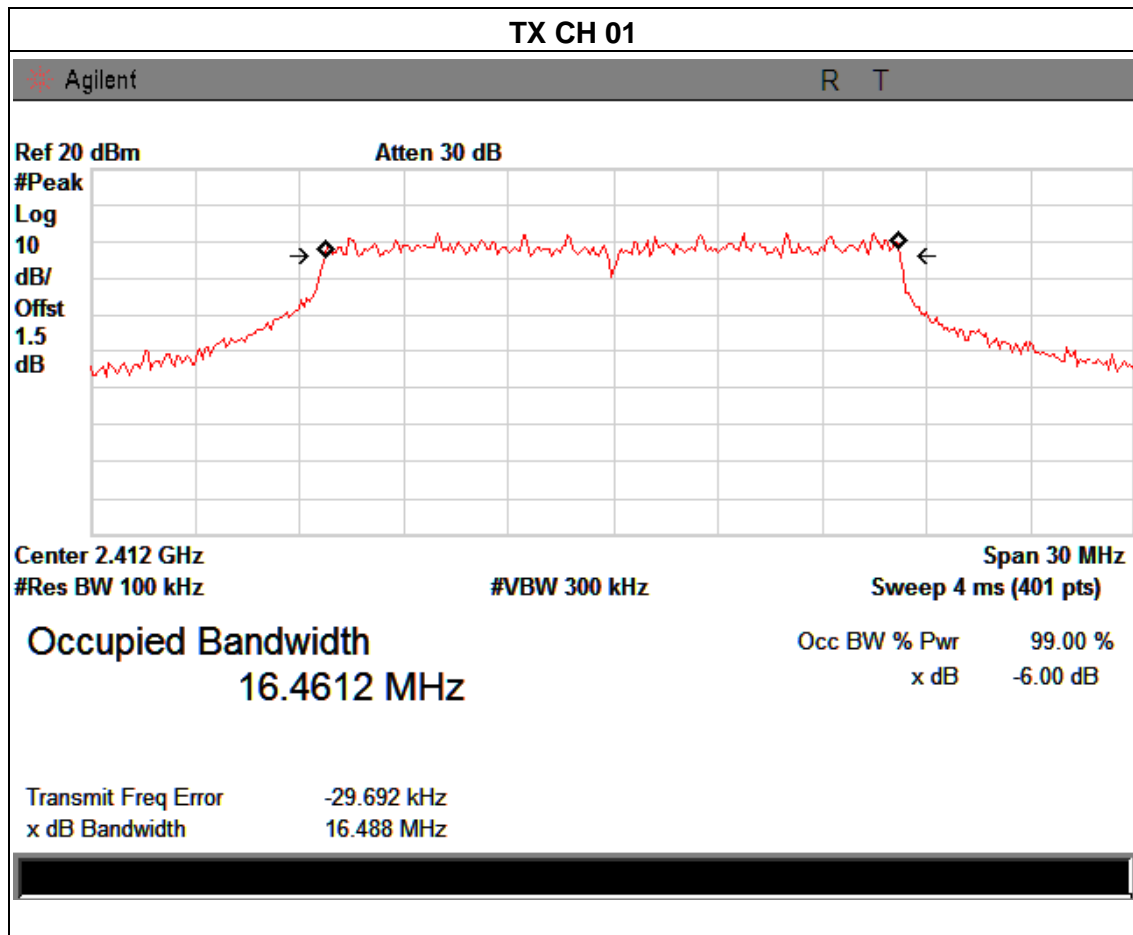

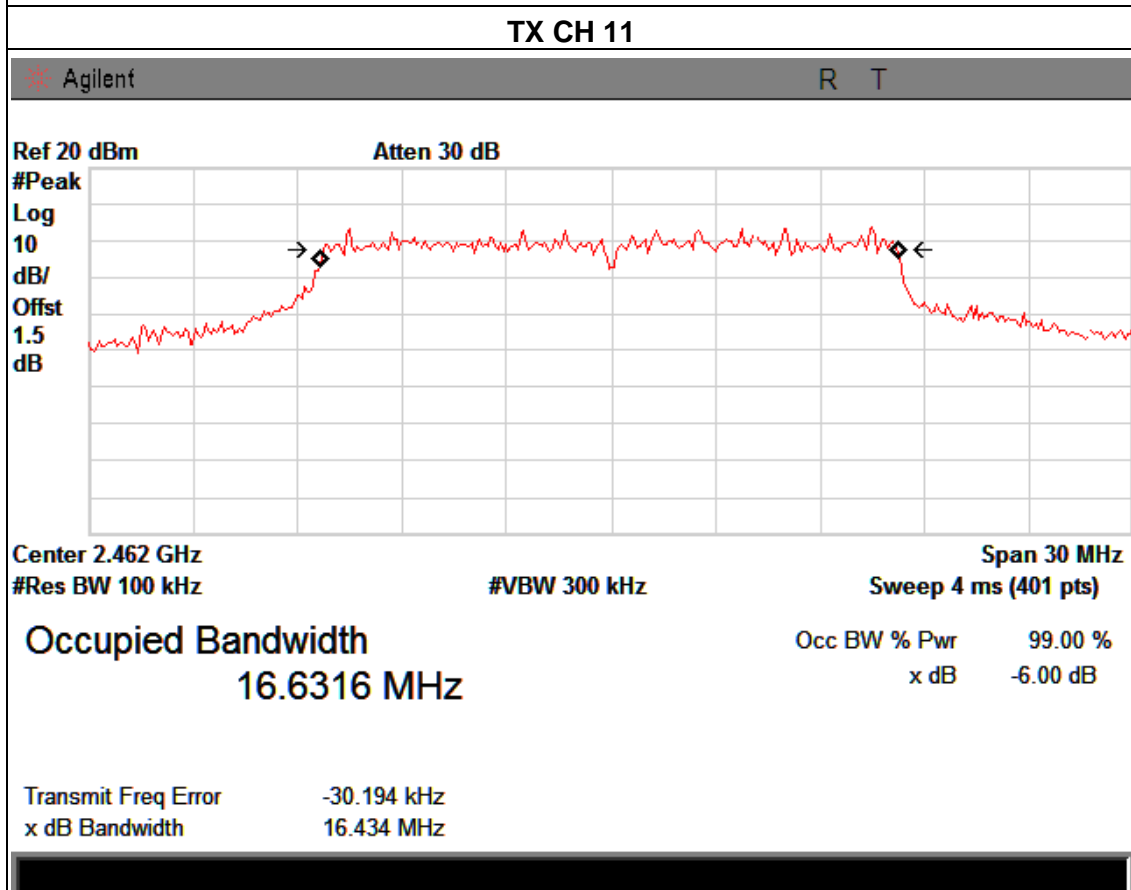
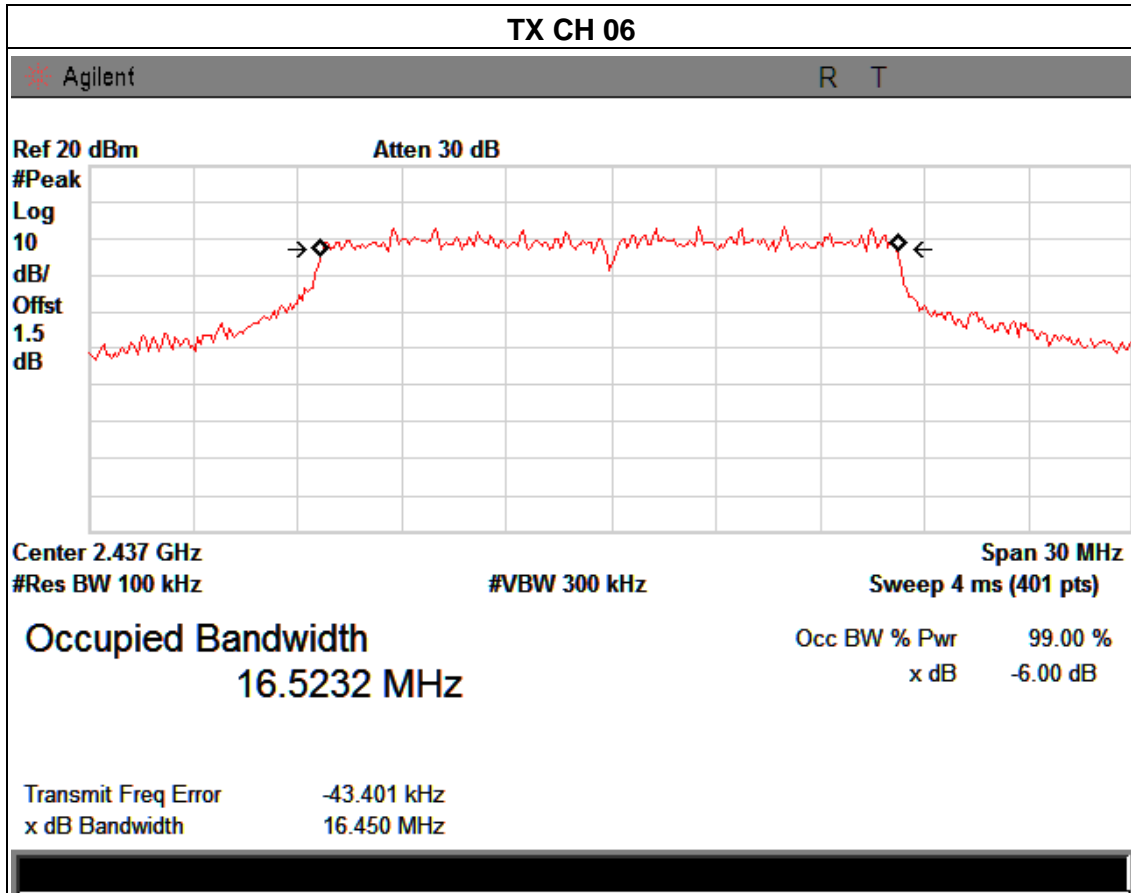

EUT :	Wireless USB Adapter	Model Name :	JN7
Temperature :	25 °C	Relative Humidity :	60%
Pressure :	1012 hPa	Test Voltage :	DC 5 V from PC with AC 120V/60Hz
Test Mode :	TX n Mode(20M) /CH01, CH06, CH11		

Frequency	6dB Bandwidth (MHz)	99% Occupied BW (MHz)	Channel Separation (MHz)	Result
2412 MHz	17.70	17.67	>=500KHz	PASS
2437 MHz	17.66	17.69	>=500KHz	PASS
2462 MHz	17.66	17.77	>=500KHz	PASS

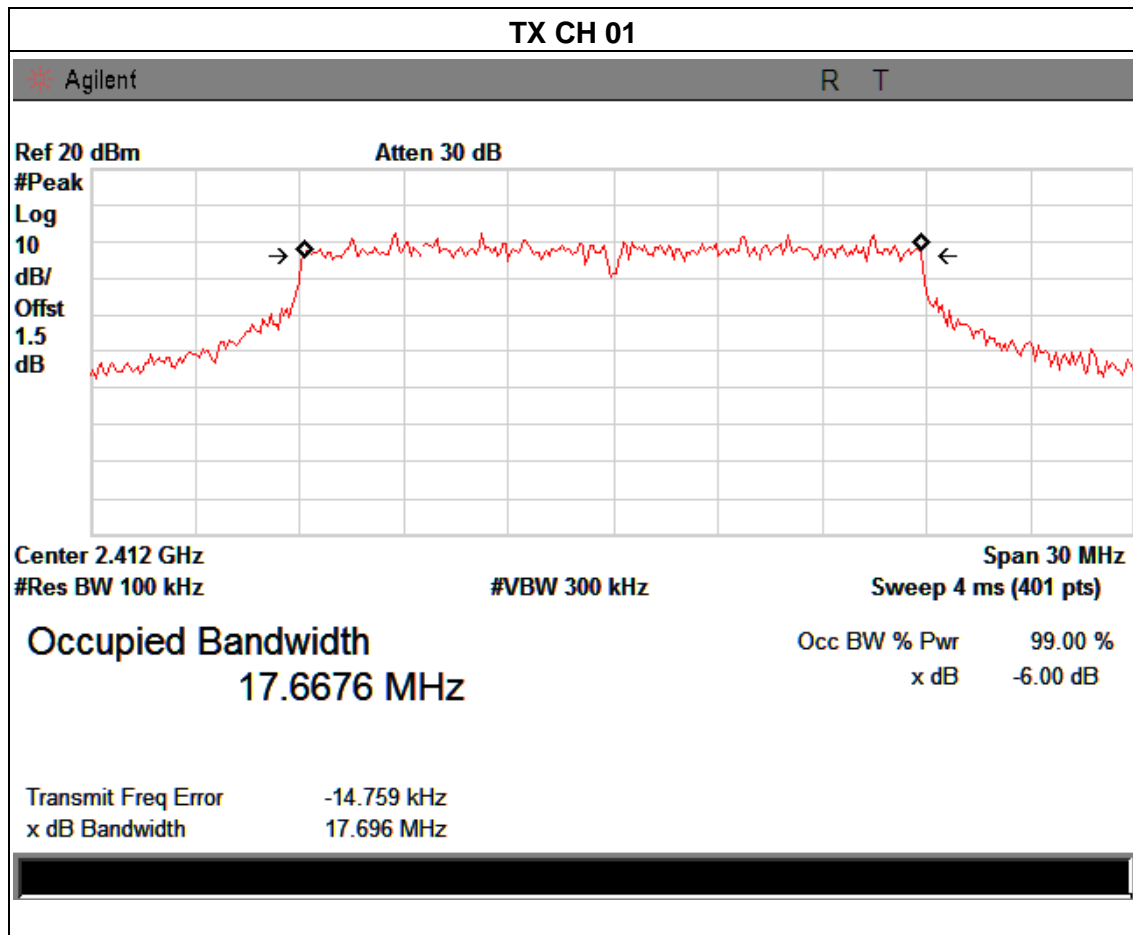

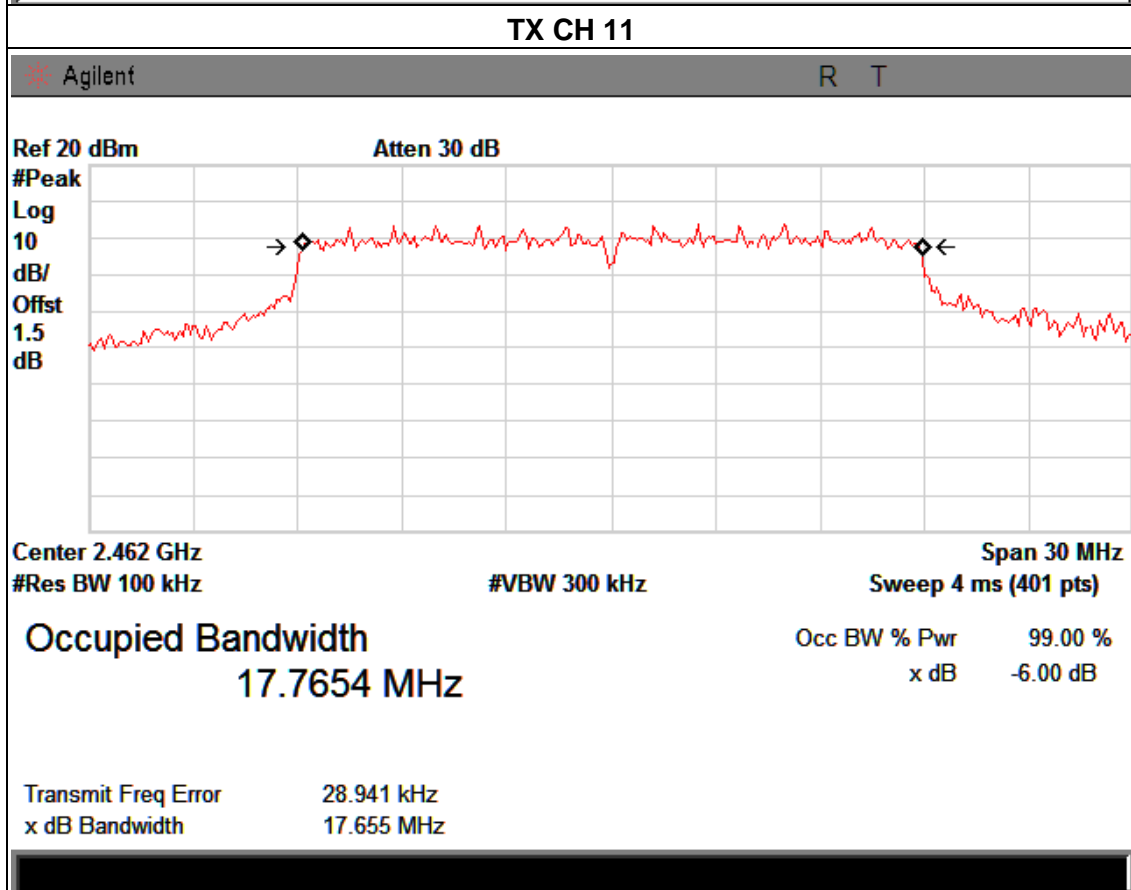
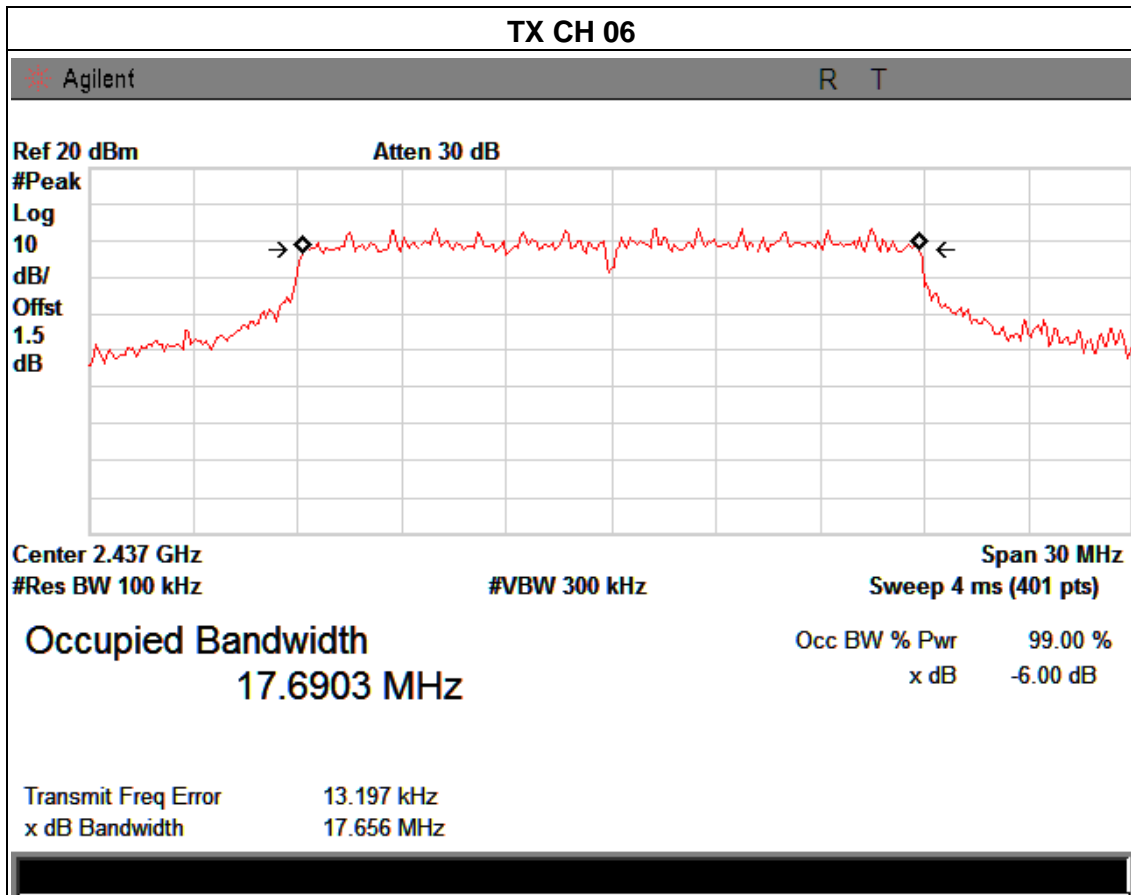

EUT :	Wireless USB Adapter	Model Name :	JN7
Temperature :	25 °C	Relative Humidity :	60%
Pressure :	1012 hPa	Test Voltage :	DC 5 V from PC with AC 120V/60Hz
Test Mode :	TX n Mode(40M) /CH03, CH06, CH09		

Frequency	6dB Bandwidth (MHz)	99% Occupied BW (MHz)	Channel Separation (MHz)	Result
2422 MHz	35.29	35.76	>=500KHz	PASS
2437 MHz	35.21	35.71	>=500KHz	PASS
2452 MHz	35.35	35.78	>=500KHz	PASS

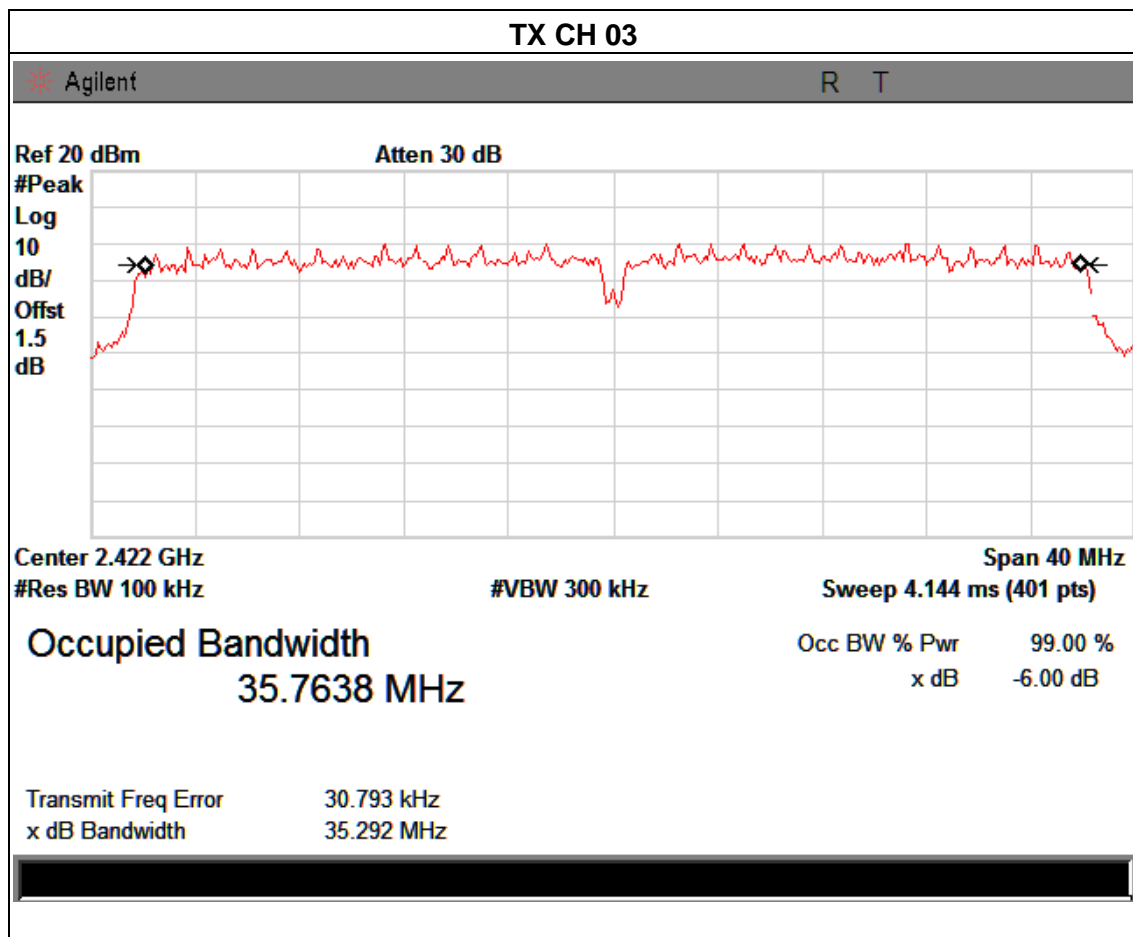

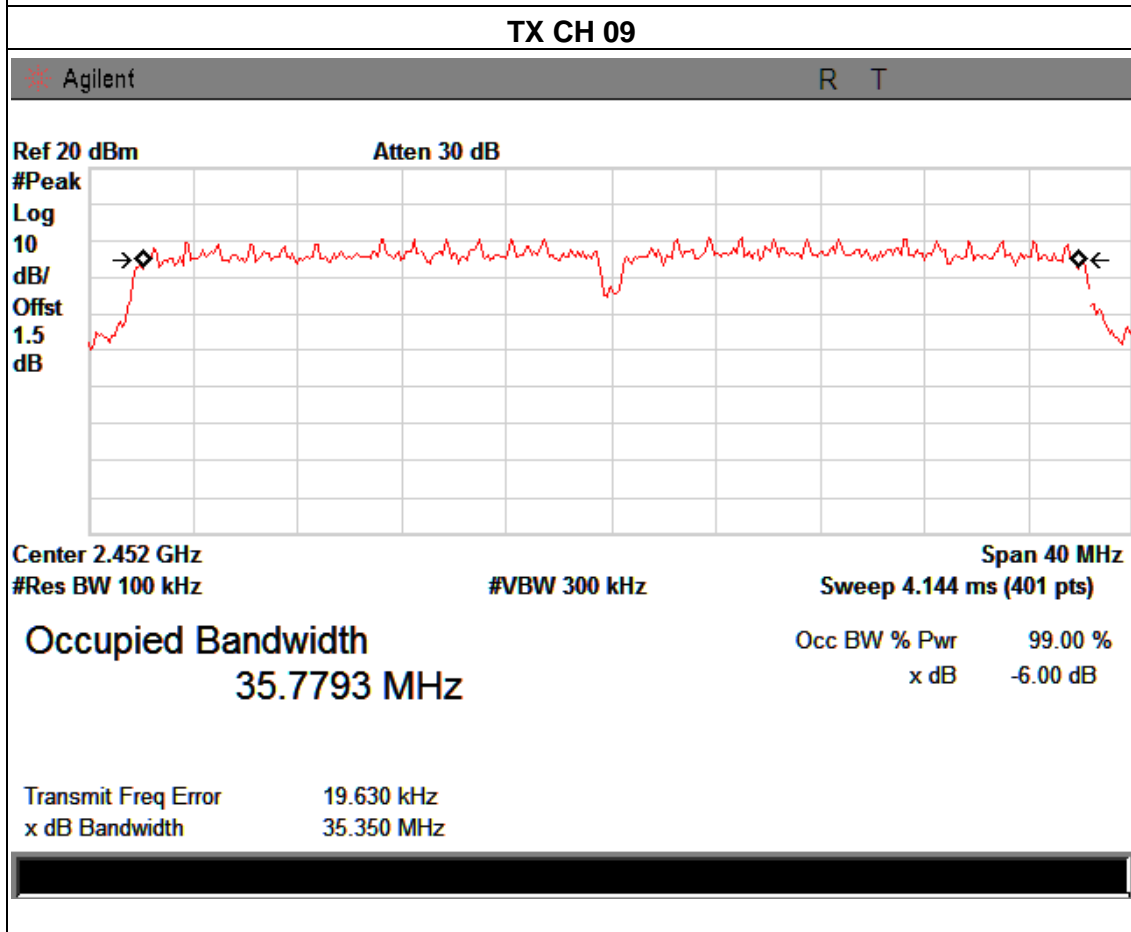
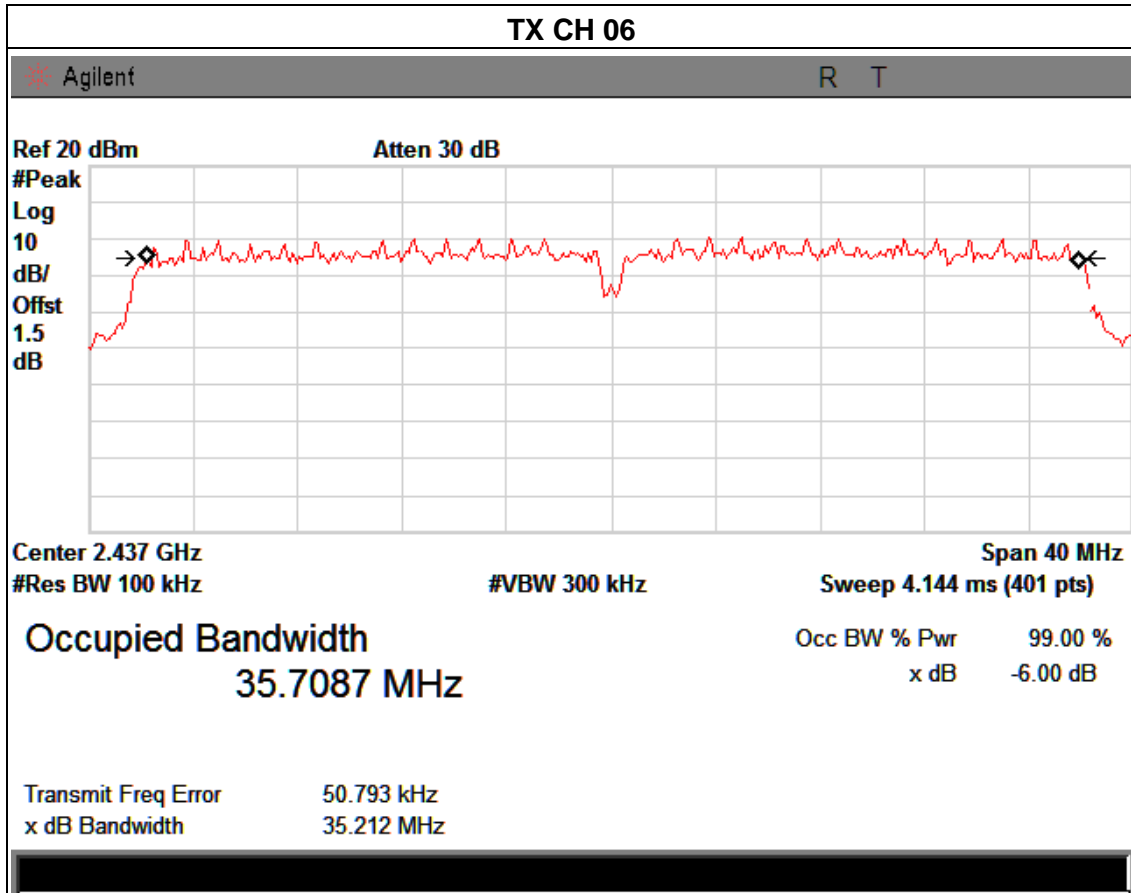

6. PEAK OUTPUT POWER TEST

6.1 APPLIED PROCEDURES / LIMIT

FCC Part15 (15.247) , Subpart C				
Section	Test Item	Limit	Frequency Range (MHz)	Result
15.247(b)(3)	Peak Output Power	1 watt or 30dBm	2400-2483.5	PASS

6.1.1 TEST PROCEDURE

- a. The EUT was directly connected to the Power meter

6.1.2 DEVIATION FROM STANDARD

No deviation.

6.1.3 TEST SETUP



6.1.4 EUT OPERATION CONDITIONS

The EUT tested system was configured as the statements of 2.3 Unless otherwise a special operating condition is specified in the follows during the testing.

6.1.5 TEST RESULTS

EUT :	Wireless USB Adapter	Model Name :	JN7
Temperature :	25 °C	Relative Humidity :	60%
Pressure :	1012 hPa	Test Voltage :	DC 5 V from PC with AC 120V/60Hz
Test Mode :	TX b/g/n(20M,40M) Mode /CH01, CH06, CH11		

TX 802.11b Mode			
Test Channel	Frequency	Peak Conducted Output Power	LIMIT
	(MHz)	(dBm)	dBm
CH01	2412	25.42	30
CH06	2437	25.31	30
CH11	2462	25.18	30
TX 802.11g Mode			
CH01	2412	24.81	30
CH06	2437	23.96	30
CH11	2462	24.14	30
TX 802.11n20 Mode			
CH01	2412	22.79	30
CH06	2437	23.18	30
CH11	2462	22.41	30
TX 802.11n40 Mode			
CH03	2422	19.03	30
CH06	2437	20.21	30
CH09	2452	19.74	30

7. ANTENNA REQUIREMENT

7.1 STANDARD REQUIREMENT

15.203 requirement: For intentional device, according to 15.203: an intentional radiator shall be designed to ensure that no antenna other than that furnished by the responsible party shall be used with the device.

7.2 EUT ANTENNA

The EUT antenna is Reverse SMA connector antenna . It comply with the standard requirement.

8. EUT TEST PHOTO

Radiated Measurement Photos



Conducted Measurement Photos

