



Compliance Testing, LLC

Previously Flom Test Lab

EMI, EMC, RF Testing Experts Since 1963

toll-free: (866) 311-3268

fax: (480) 926-3598

<http://www.ComplianceTesting.com>

info@ComplianceTesting.com

Test Report

Prepared for: Kenwood USA Corporation

Model: PKT-23-K

Description: UHF FM TRANSCEIVER

FCC ID: ALH460300

To

FCC Part 90

Date of Issue: August 21, 2013

On the behalf of the applicant:

Kenwood USA Corporation
Communications Division
3970 Johns Creek Court
Suite 100
Suwanee, GA 30024

Attention of:

Joel Berger, Research & Development
Ph: (678)474-4722
E-Mail: jberger@kenwoodusa.com

Prepared By
Compliance Testing, LLC
3356 N San Marcos Pl, Suite 107
Chandler, AZ 85225-7176
(866) 311-3268 phone / (480) 926-3598 fax
www.compliancetesting.com
Project No: p1380001

Alex Macon
Project Test Engineer

This report may not be reproduced, except in full, without written permission from Compliance Testing.
All results contained herein relate only to the sample tested.



Test Report Revision History

Revision	Date	Revised By	Reason for Revision
1.0	August 21, 2013	Alex Macon	Original Document
2.0	September, 16, 2013	Alex Macon	Corrected attenuation level in block diagram to 20 dB on page 20. Included Part 90 specification in test result summary page 7



Table of Contents

<u>Description</u>	<u>Page</u>
Standard Test Conditions and Engineering Practices	6
Test Result Summary	7
Carrier Output Power (Conducted)	8
Conducted Spurious Emissions	9
Field Strength of Spurious Radiation	13
Emission Masks (Occupied Bandwidth)	16
Transient Frequency Behavior	20
Audio Low Pass Filter (Voice Input)	22
Audio Frequency Response	23
Modulation Limiting	24
Frequency Stability (Temperature Variation)	25
Necessary Bandwidth Calculations	26
Test Equipment Utilized	27



ILAC / A2LA

Compliance Testing, LLC, has been accredited in accordance with the recognized International Standard ISO/IEC 17025:2005. This accreditation demonstrates technical competence for a defined scope and the operation of a laboratory quality management system (refer joint ISO-ILAC-IAF Communiqué dated January 2009).

The tests results contained within this test report all fall within our scope of accreditation, unless noted below.

Please refer to <http://www.compliancetesting.com/labscope.html> for current scope of accreditation.

Testing Certificate Number: **2152.01**



FCC OATS Reg, #933597

IC Reg. #2044A-1

Non-accredited tests contained in this report:

N/A



The Applicant has been cautioned as to the following:

15.21: Information to the User

The user's manual or instruction manual for an intentional radiator shall caution the user that changes or modifications not expressly approved by the party responsible for compliance could void the user's authority to operate the equipment.

15.27(a): Special Accessories

Equipment marketed to a consumer must be capable of complying with the necessary regulations in the configuration in which the equipment is marketed. Where special accessories, such as shielded cables and/or special connectors are required to enable an unintentional or intentional radiator to comply with the emission limits in this part, the equipment must be marketed with, i.e. shipped and sold with, those special accessories. However, in lieu of shipping or packaging the special accessories with the unintentional or intentional radiator, the responsible party may employ other methods of ensuring that the special accessories are provided to the consumer, without an additional charge.

Information detailing any alternative method used to supply the special accessories for a grant of equipment authorization or retained in the verification records, as appropriate. The party responsible for the equipment, as detailed in § 2.909 of this chapter, shall ensure that these special accessories are provided with the equipment. The instruction manual for such devices shall include appropriate instructions on the first page of text concerned with the installation of the device that these special accessories must be used with the device. It is the responsibility of the user to use the needed special accessories supplied with the equipment.



Test and Measurement Data

All tests and measurement data shown were performed in accordance with FCC Rules and Regulations, Volume II, Part 2, Subpart J, Sections 2.947, 2.1033(c), 2.1041, 2.1046, 2.1047, 2.1049, 2.1051, 2.1053, 2.1055, 2.1057, and the following individual Parts 90.

Standard Test Conditions and Engineering Practices

Except as noted herein, the following conditions and procedures were observed during the testing.

In accordance with ANSI/TIA 603C, and unless otherwise indicated in the specific measurement results, the ambient temperature of the actual EUT was maintained within the range of 10° to 40°C (50° to 104°F) unless the particular equipment requirements specify testing over a different temperature range. Also, unless otherwise indicated, the humidity levels were in the range of 10% to 90% relative humidity.

Environmental Conditions		
Temp (°C)	Humidity (%)	Pressure (mbar)
26.8 - 37.5	22.3 – 40.7	963.7 – 969.1

Measurement results, unless otherwise noted, are worst-case measurements.

EUT Description

Model: PKT-23-K

Description: UHF FM TRANSCEIVER

Additional Information: The EUT is a push to talk occupational radio.

EUT Operation during Tests

The EUT was in a normal operating condition for testing. Both a radiated and conducted sample were provided.

Accessories: None

Cables: None

Modifications: None



Test Result Summary

Specification	Test Name	Pass, Fail, N/A	Comments
2.1046	Carrier Output Power (Conducted)	Pass	
90.210, 2.1051.	Unwanted Emissions (Transmitter Conducted)	Pass	
90.210, 2.1053	Field Strength of Spurious Radiation	Pass	
90.210, 2.1049	Emission Masks (Occupied Bandwidth)	Pass	
2.1047	Audio Low Pass Filter (Voice Input)	Pass	
2.1047	Audio Frequency Response	Pass	
2.1047(a)	Modulation Limiting	Pass	
90.213	Frequency Stability (Temperature Variation)	Pass	
90.213	Frequency Stability (Voltage Variation)	Pass	
90.214	Transient Frequency Behavior	Pass	
2.202	Necessary Bandwidth Calculation	Pass	



Carrier Output Power (Conducted)

Name of Test: Carrier Output Power (Conducted)
Test Equipment Utilized: i00054, i00379

Engineer: Alex Macon
Test Date: 8/20/13

Measurement Procedure

The Equipment Under Test (EUT) was connected to a spectrum analyzer through a 20 dB Power attenuator. All cable and attenuator losses were input into the spectrum analyzer as a reference level offset to ensure accurate readings were obtained.

Test Setup

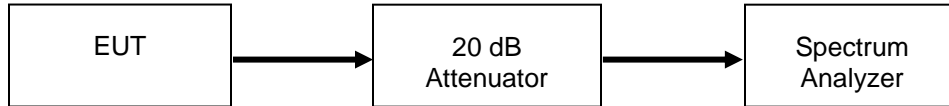

High Power Transmitter Peak Output Power

Tuned Frequency (MHz)	Recorded Measurement (dBm)	Recorded Measurement (Watts)	Result
440.05	31.67	1.5	Pass
460.05	31.66	1.5	Pass
479.95	31.68	1.5	Pass



Conducted Spurious Emissions

Name of Test: Conducted Spurious Emissions
Test Equipment Utilized: i00054, i00118, i00379

Engineer: Alex Macon
Test Date: 8/20/13

Test Procedure

The EUT was connected directly to a spectrum analyzer to verify that the UUT met the requirements for spurious emissions. A tunable notch filter was utilized to ensure the fundamental did not put the spectrum analyzer into compression. The resolution bandwidth was set for 1 MHz and the reference level was adjusted to ensure the system had sufficient dynamic range to measure spurious emissions. The frequency range from 30 MHz to the 10th harmonic of the fundamental transmitter was observed and plotted.

Test Setup

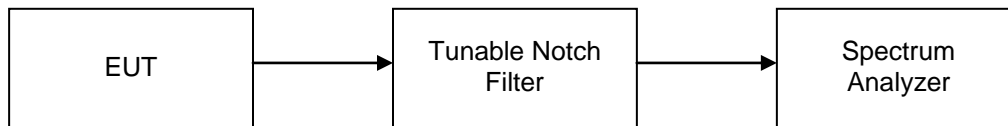

High Power Conducted Spurious Emissions Summary Test Table

Tuned Frequency (MHz)	Spurious Frequency (MHz)	Measured Spurious Level (dBm)	Specification Limit (dBm)	Result
440.05	880.16	-26.61	-13	Pass
460.05	1380.5	-25.75	-13	Pass
479.95	1439.9	-24.84	-13	Pass



Test Plots

440.05 MHz

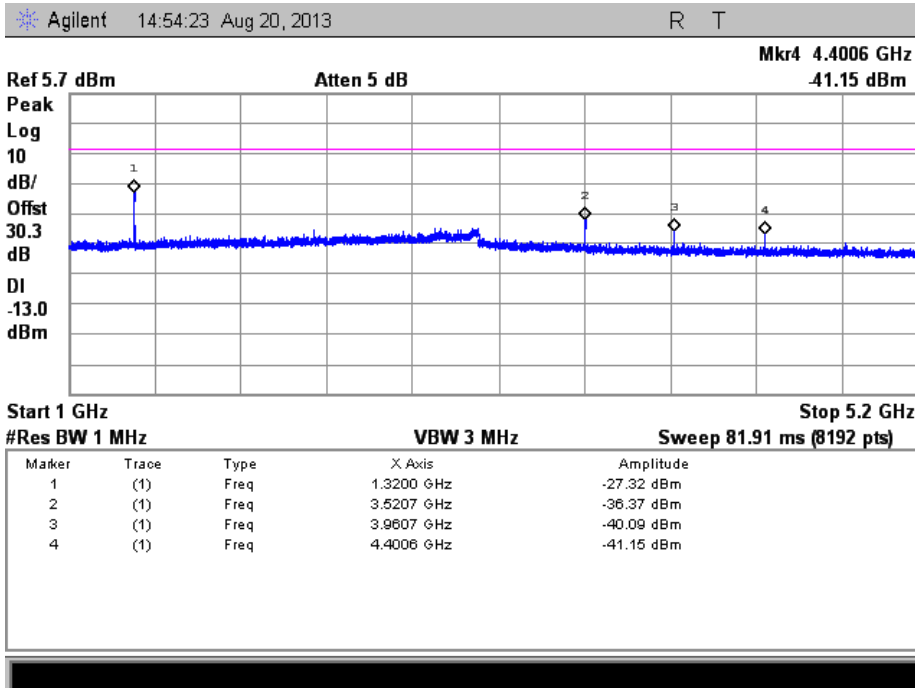
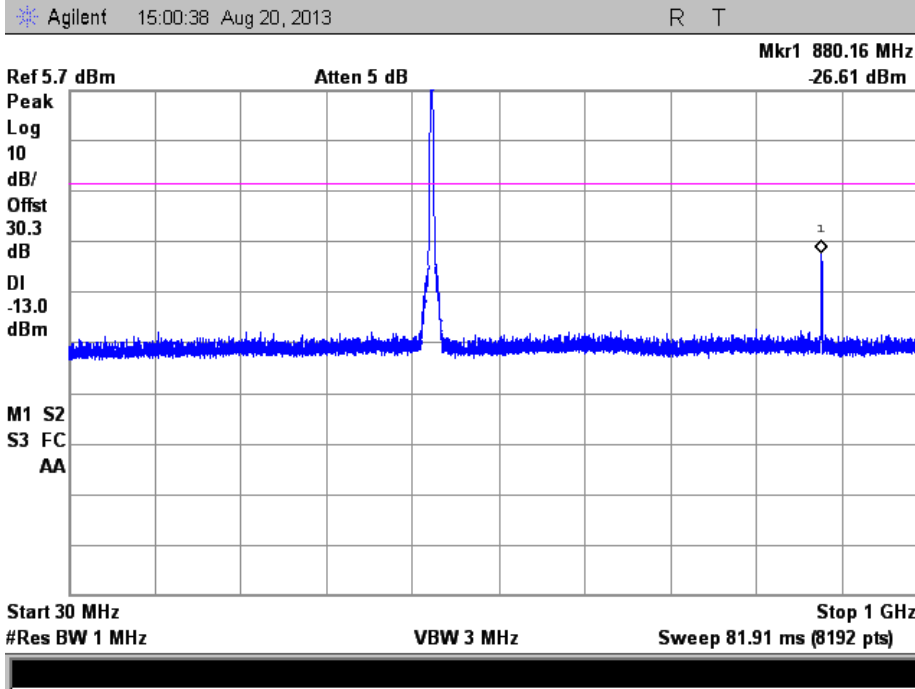



460.05 MHz

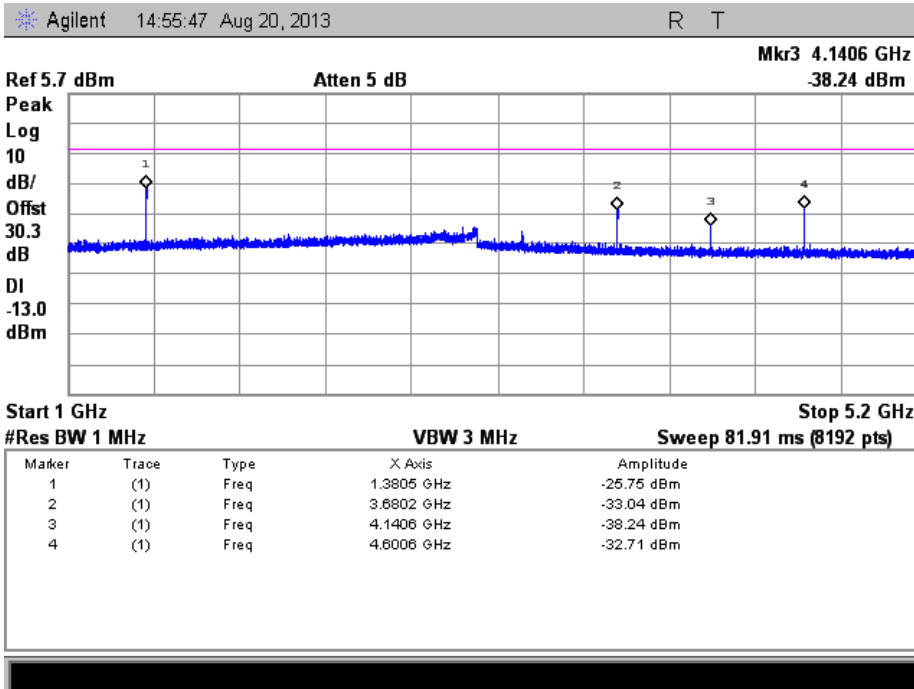
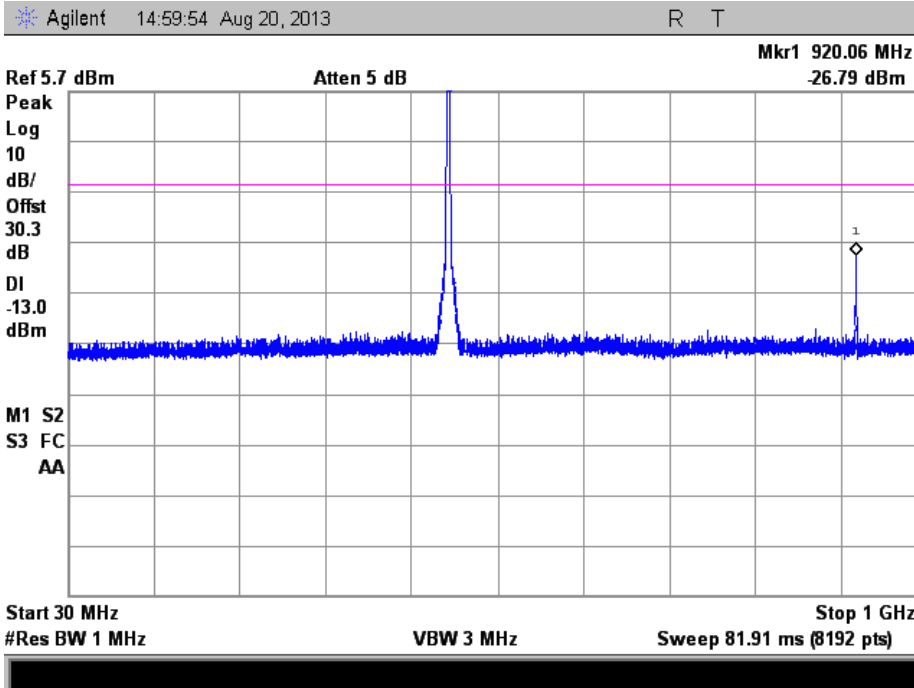



479.95 MHz

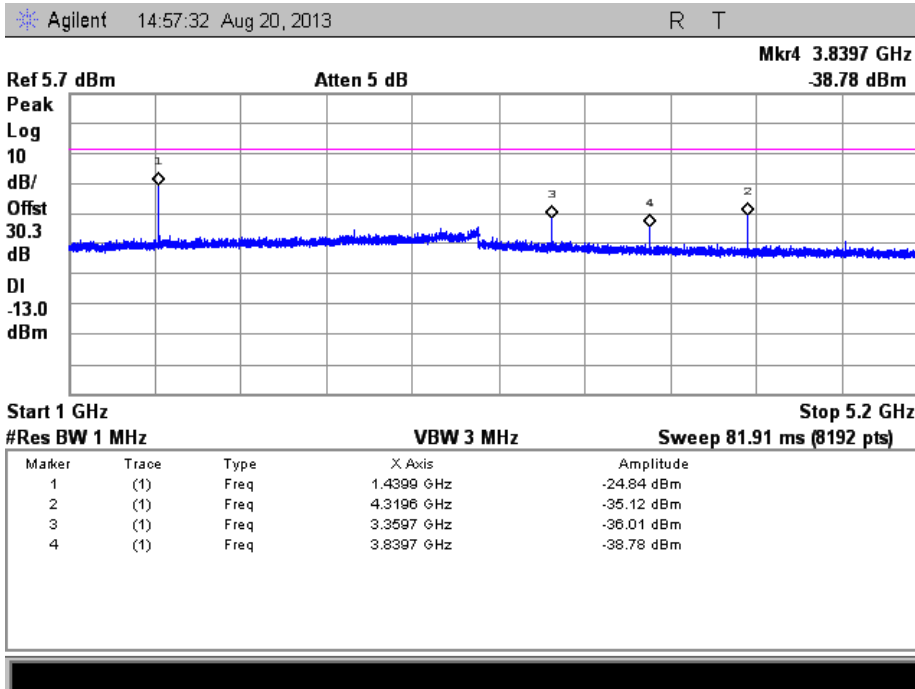
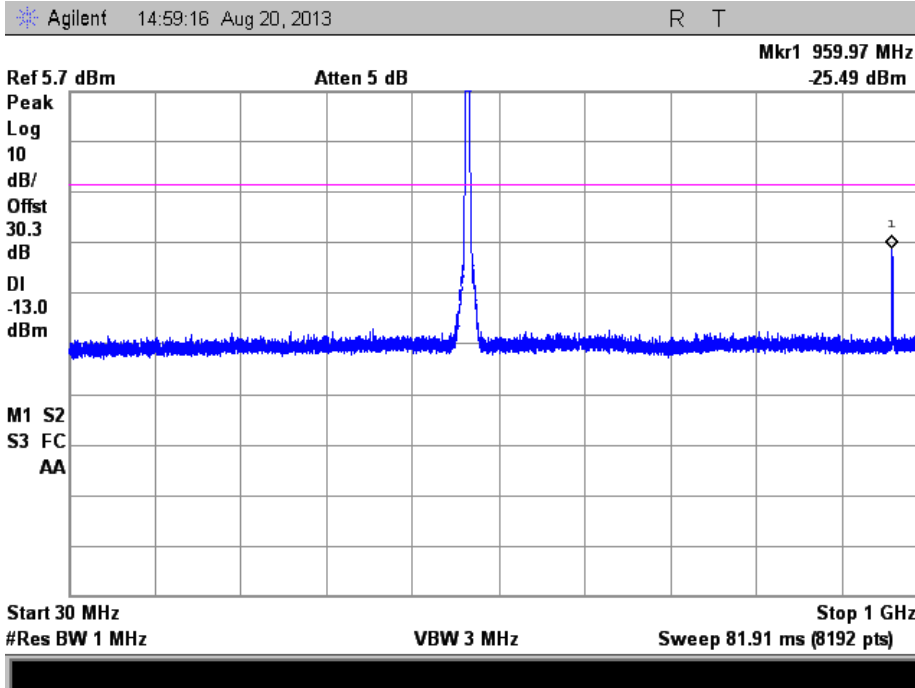



Field Strength of Spurious Radiation

Name of Test: Field Strength of Spurious Radiation
Test Equipment Utilized: i00267,i00271, i00379

Engineer: Alex Macon
Test Date: 8/21/13

Test Procedure

- A) Connect the equipment as illustrated below.
- B) Adjust the spectrum analyzer to the following settings:
 - 1) Resolution Bandwidth 100 kHz (< 1 GHz), 1 MHz (> 1GHz)
 - 2) Video Bandwidth ≥ 3 times Resolution Bandwidth, or 30 kHz
 - 3) Sweep Speed ≤ 2000 Hz/second
 - 4) Detector Mode = Mean or Average Power
- C) Place the transmitter to be tested on the turntable in the standard test site. The transmitter is transmitting into a non-radiating load that is placed on the turntable. The RF cable to this load should be of minimum length.
- D) For each spurious measurement the test antenna should be adjusted to the correct length for the frequency involved. This length may be determined from a calibration ruler supplied with the equipment. Measurements shall be made from the lowest radio frequency generated in the equipment to the tenth harmonic of the carrier, except for the region close to the carrier equal to \pm the test bandwidth (see Section 1.3.4.4).
- E) For each spurious frequency, raise and lower the test antenna from 1 m to 4 m to obtain a maximum reading on the spectrum analyzer with the test antenna at horizontal polarity. Repeat this procedure to obtain the highest possible reading. Record this maximum reading.
- F) Repeat Step E) for each spurious frequency with the test antenna polarized vertically.
- G) Reconnect the equipment as illustrated.
- H) Keep the spectrum analyzer adjusted as in Step B).
- I) Remove the transmitter and replace it with a substitution antenna (the antenna should be half wavelength for each frequency involved). The center of the substitution antenna should be approximately at the same location as the center of the transmitter. At lower frequencies, where the substitution antenna is very long, this will be impossible to achieve when the antenna is polarized vertically. In such case the lower end of the antenna should be 0.3 m above the ground.
- J) Feed the substitution antenna at the transmitter end with a signal generator connected to the antenna by means of a non-radiating cable. With the antennas at both ends horizontally polarized and with the signal generator tuned to a particular spurious frequency, raise and lower the test antenna to obtain a maximum reading at the spectrum analyzer. Adjust the level of the signal generator output until the previously recorded maximum reading for this set of conditions is obtained. This should be done carefully repeating the adjustment of the test antenna and generator output.
- K) Repeat Step J) with both antennas vertically polarized for each spurious frequency.
- L) Calculate power in dBm into a reference ideal half-wave dipole antenna by reducing the readings obtained in Steps J) and K) by the power loss in the cable between the generator and the antenna and further corrected for the gain of the substitution antenna used relative to an ideal half-wave dipole antenna.
- M) The levels recorded in Step L) are absolute levels of radiated spurious emissions in dBm. The radiated spurious emissions in dB can be calculated by the following:

$$\text{Radiated spurious emissions dB} = 10\log_{10} (\text{TX power in watts}/0.001) - \text{the levels in Step I)}$$

NOTE: It is permissible that the other antennas provided can be referenced to a dipole.



Test Setup

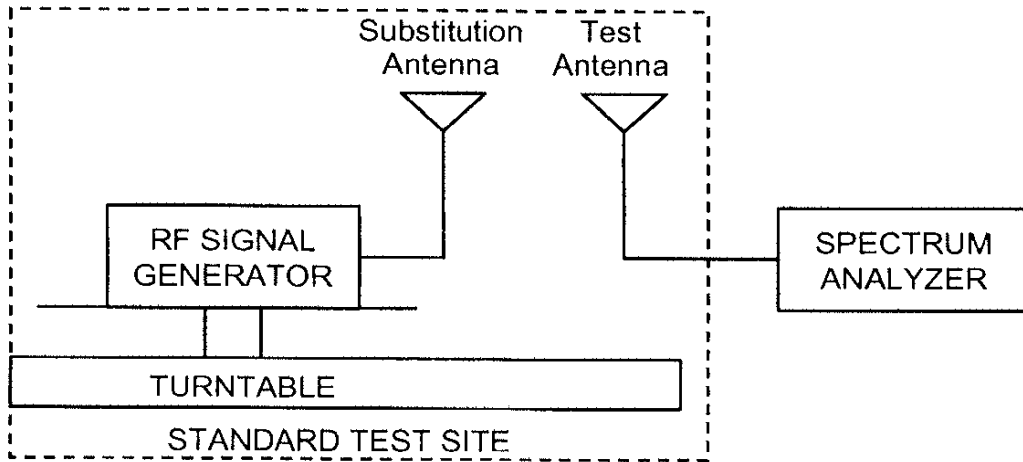
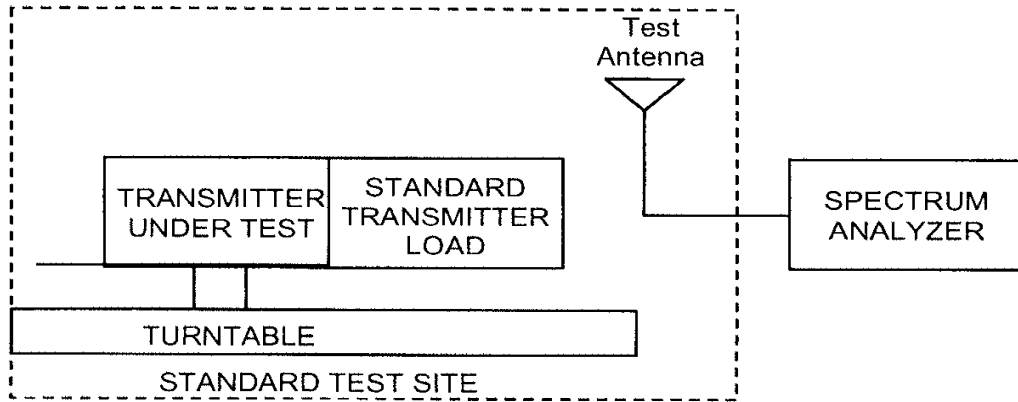



Test Results

440.05 MHz

Emission Frequency (MHz)	Measured Level (dBm)	Limit (dBm)	Result
880.1	-41.4	-13	Pass
1320.1	-48.82	-13	Pass
1760.2	-55.08	-13	Pass

460.05 MHz

Emission Frequency (MHz)	Measured Level (dBm)	Limit (dBm)	Result
920.1	-37.45	-13	Pass
1380.2	-56.17	-13	Pass
1840.2	-59.18	-13	Pass

479.95 MHz

Emission Frequency (MHz)	Measured Level (dBm)	Limit (dBm)	Result
959.9	-43.95	-13	Pass
1439.9	-54.07	-13	Pass
2399.7	-52.72	-13	Pass

No other emissions were detected. All emissions were less than -13 dBm.



Emission Masks (Occupied Bandwidth)

Name of Test: Emission Masks (Occupied Bandwidth)
Test Equipment Utilized i00054, i00118, i00379

Engineer: Alex Macon
Test Date: 8/20/13

Measurement Procedure

The EUT was connected directly to a spectrum analyzer to verify that the EUT meets the required emissions mask. A reference level plot is provided to verify that the peak power was established prior to testing the mask. A modulation frequency of 2.5 kHz at a level of 100 mVPP was input into the EUT.

Test Setup

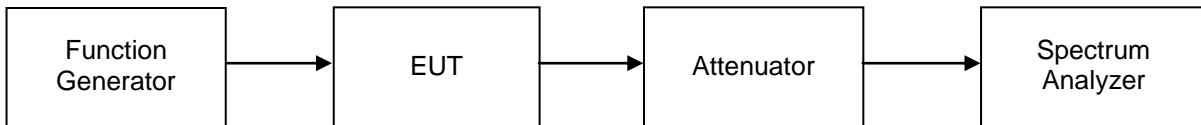



Occupied Bandwidth Plots

440.05 MHz

Reference

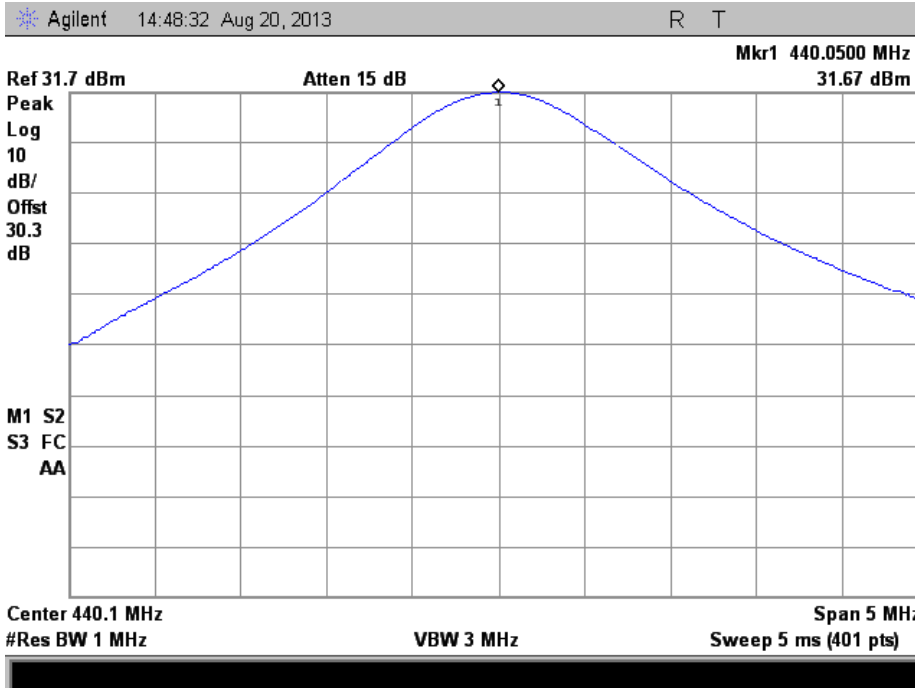

Mask D

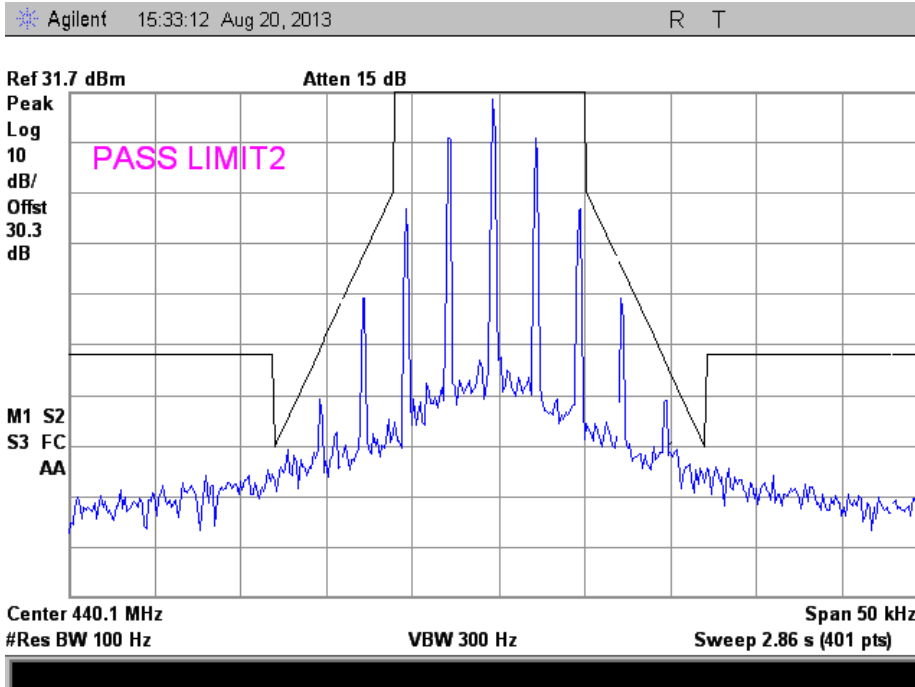



460.05 MHz

Reference

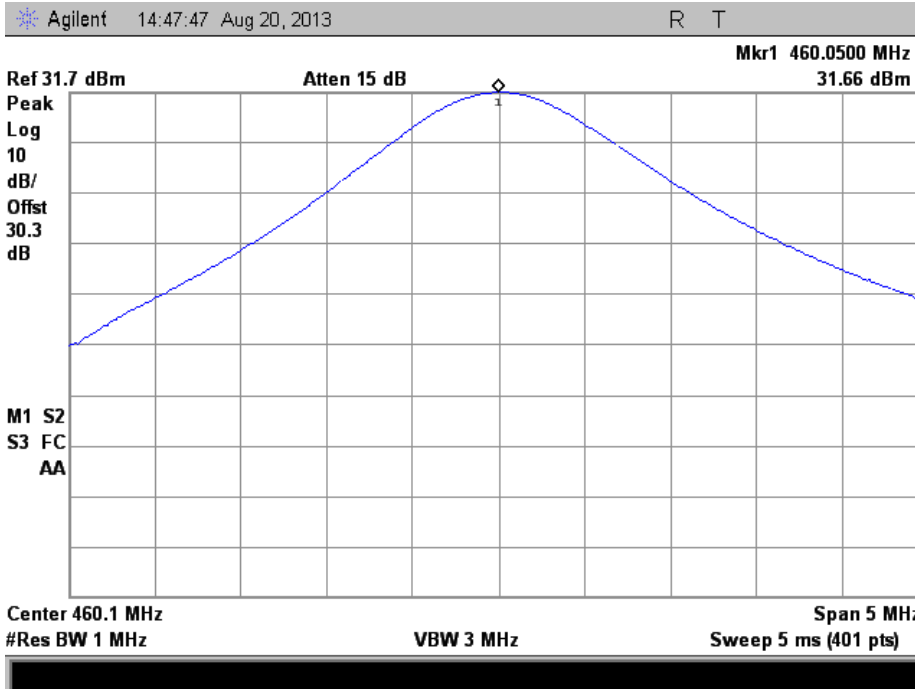

Mask D

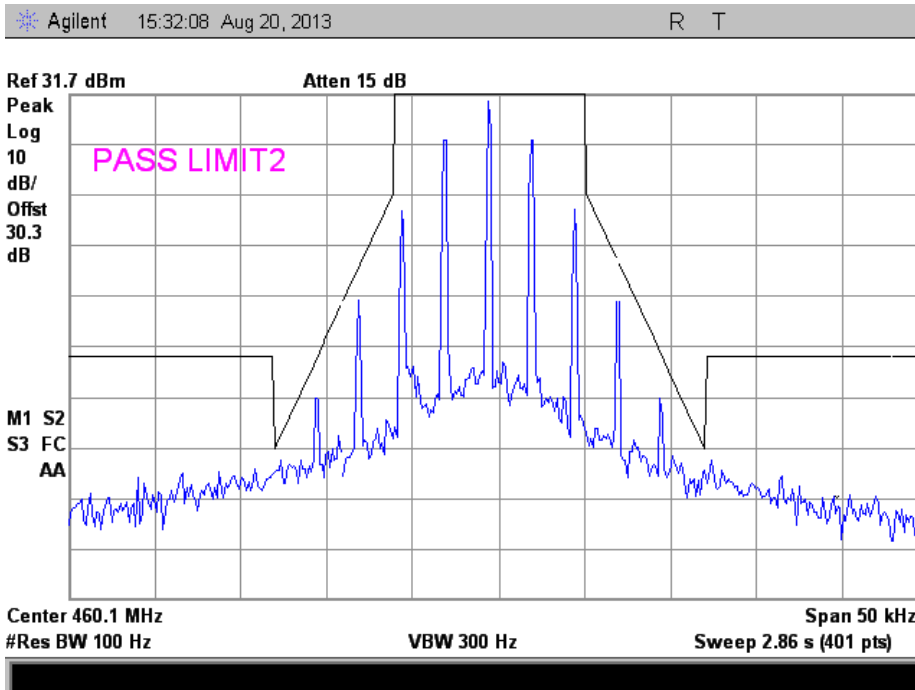



479.95 MHz

Reference

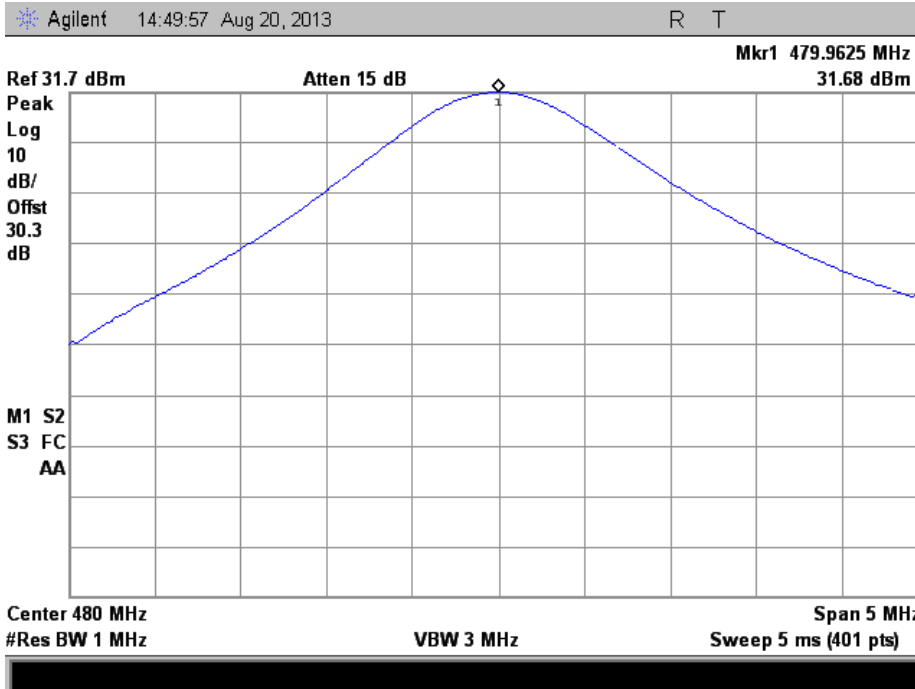

Mask D

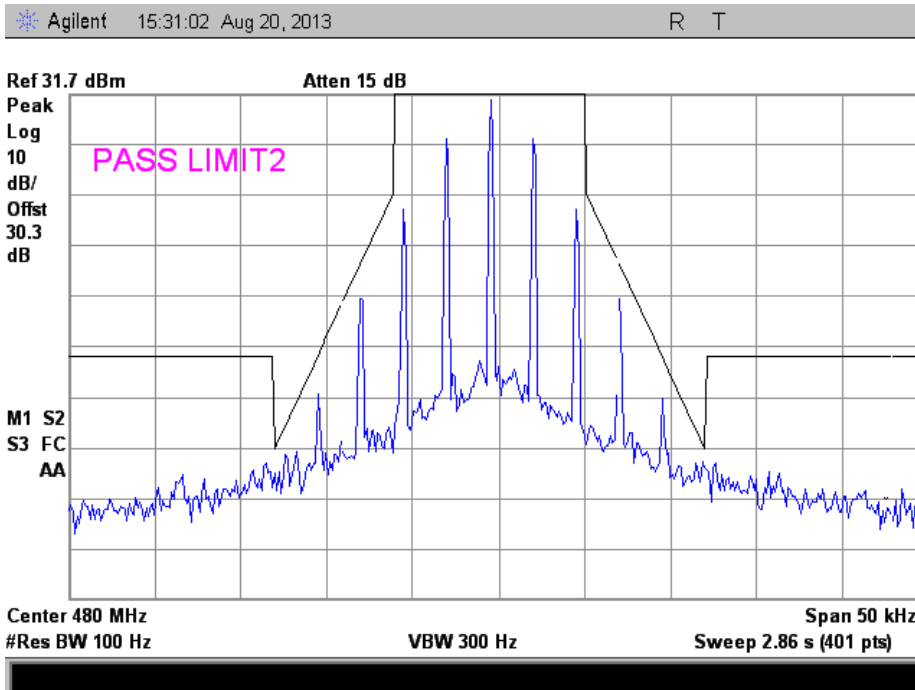



Transient Frequency Behavior

Name of Test: Transient Frequency Behavior
Test Equipment Utilized: i00345

Engineer: Alex Macon
Test Date: 8/20/13

Measurement Procedure

The EUT was connected directly to a modulation analyzer through a 20 dB attenuator to verify that the EUT meets the required Transient Frequency Behavior response per the specification. The modulation analyzer is a real time spectrum analyzer with integrated demodulation, audio measurement capabilities, and timing analysis. The turn on and turn off transient timing was measured and recorded.

Test Setup

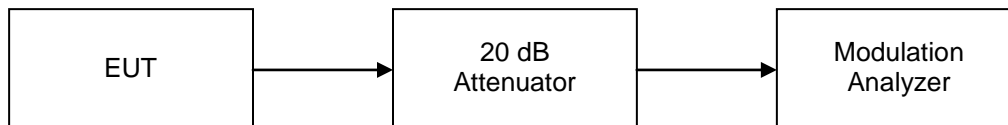



Test Results On Time

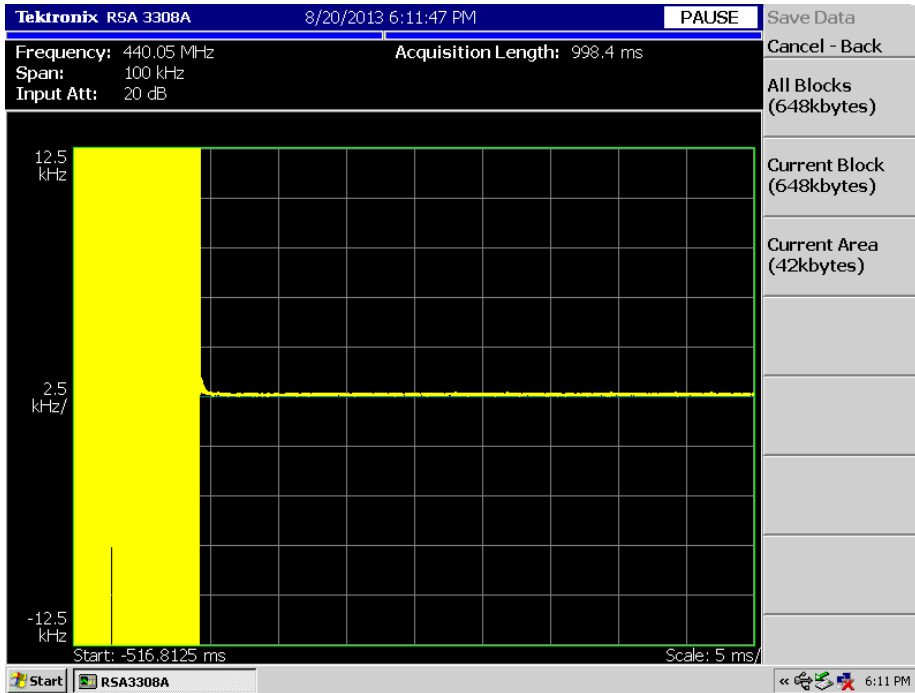

Test Results Off Time

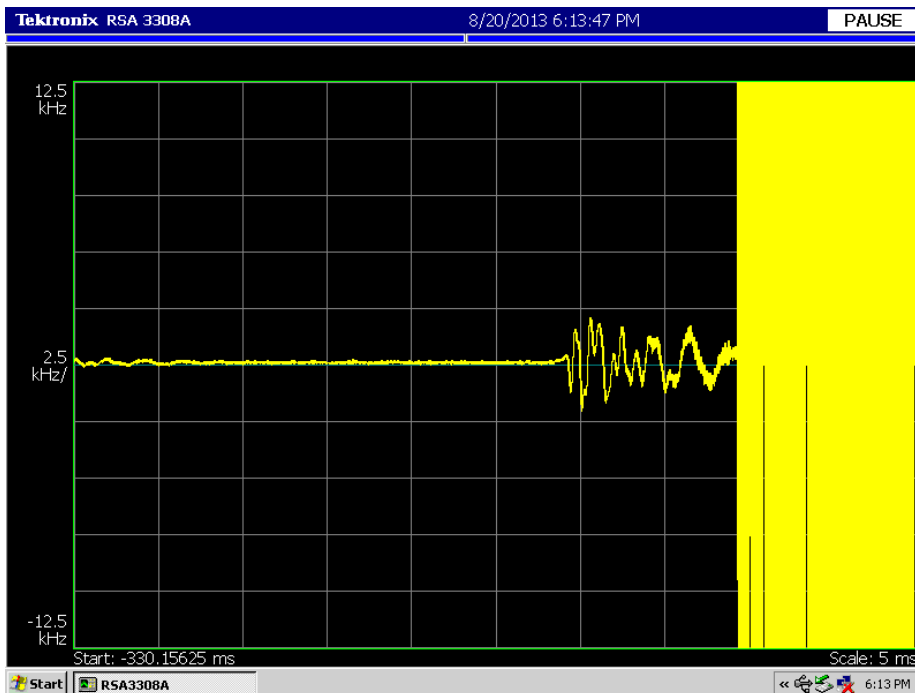



Audio Low Pass Filter (Voice Input)

Name of Test: Audio Low Pass Filter (Voice Input)
Test Equipment Utilized: i00118, i00345

Engineer: Alex Macon
Test Date: 8/20/13

Measurement Procedure

The EUT was connected directly to a modulation analyzer through an attenuator. The audio source was tuned across the required audio frequency range and the audio low pass filter response was measured and plotted. The modulation analyzer is a real time spectrum analyzer with integrated demodulation, audio measurement capabilities, and timing analysis.

Test Setup

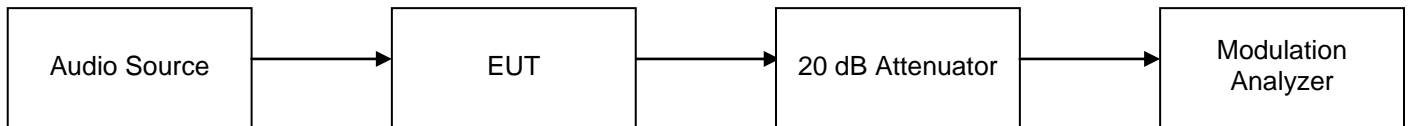

Measurement Results

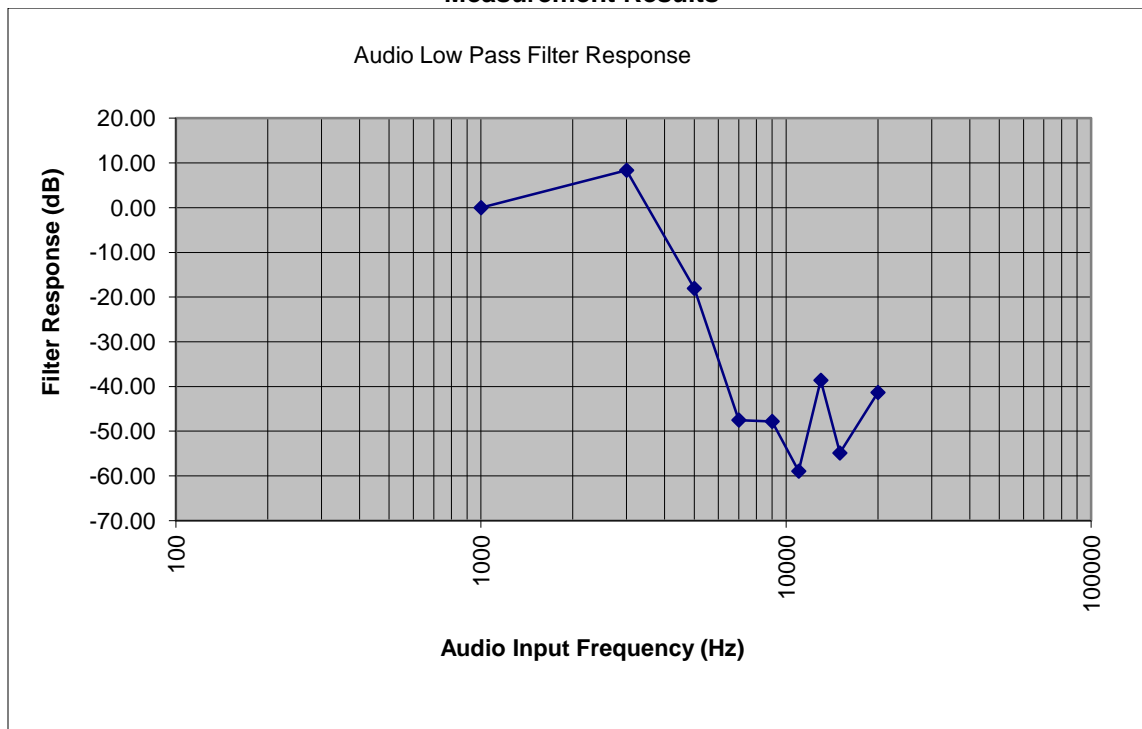

This unit is a digital radio and the roll-off for the filter is very linear in the operational band and sharp out of band.



Audio Frequency Response

Name of Tests: Audio Frequency Response
Test Equipment Utilized: i00118, i00345

Engineer: Alex Macon
Test Date: 8/20/13

Measurement Procedure

The EUT was connected directly to a modulation analyzer through an attenuator. The audio source was tuned across the required audio frequency range and the audio frequency response was measured and plotted. The modulation analyzer is a real time spectrum analyzer with integrated demodulation, audio measurement capabilities, and timing analysis.

Test Setup

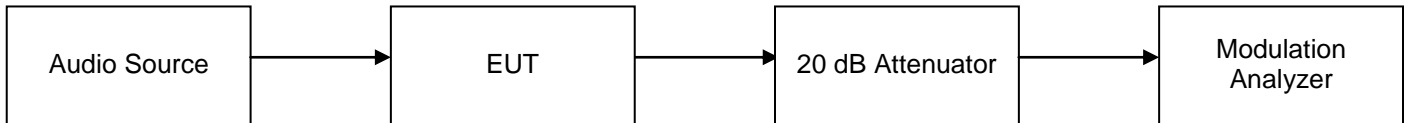

Test Results

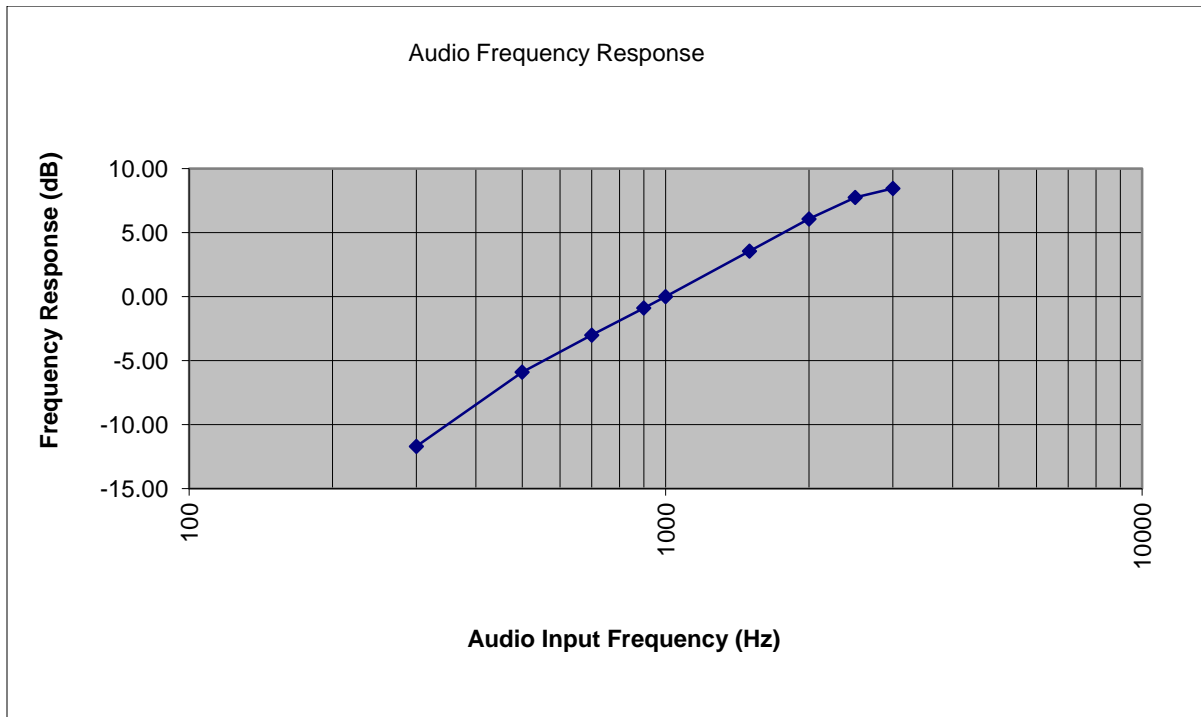



Modulation Limiting

Name of Test: Modulation Limiting
Test Equipment Utilized: i00118, i00345

Engineer: Alex Macon
Test Date: 8/20/13

Measurement Procedure

The EUT was connected directly to a modulation analyzer through an attenuator. The audio source was tuned across the required audio frequency range and the modulation limiting response was measured and plotted. The modulation analyzer is a real time spectrum analyzer with integrated demodulation, audio measurement capabilities, and timing analysis.

Test Setup

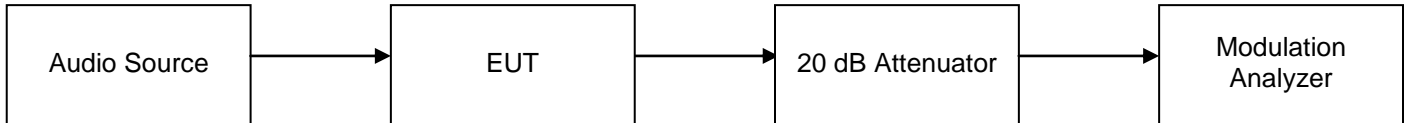

Positive Peak Deviation

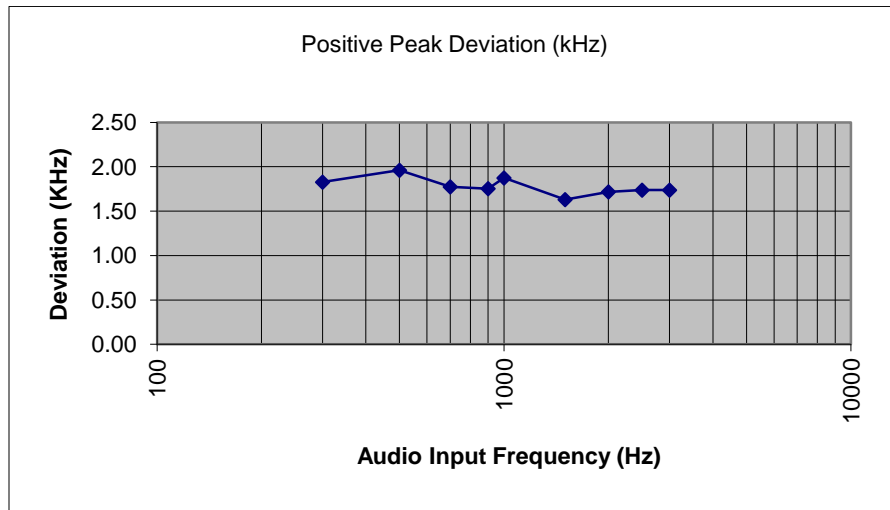

Negative Peak Deviation

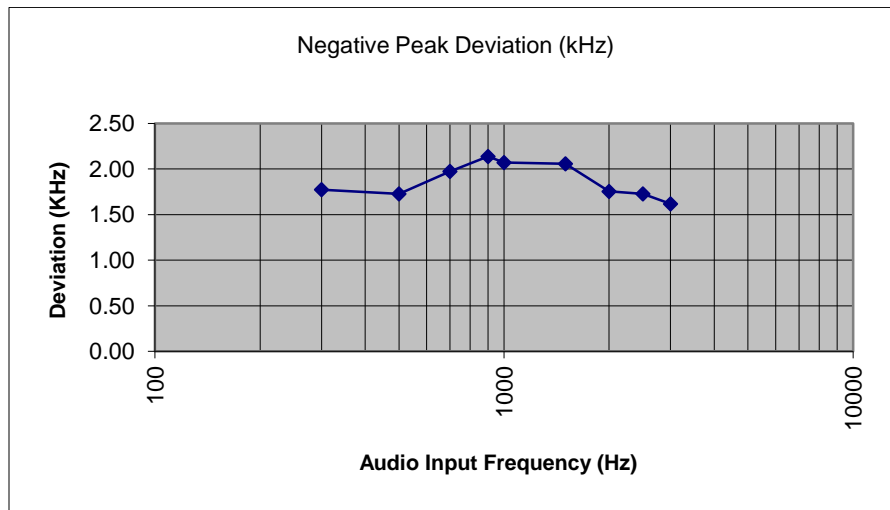



Frequency Stability (Temperature Variation)

Name of Test: Frequency Stability (Temperature Variation)

Engineer: Alex Macon

Test Equipment Utilized: i00054, i00027, i00320, i00343, i00345

Test Date: 8/22/13

Measurement Procedure

The EUT was placed in an environmental test chamber and the RF output was connected directly to a spectrum analyzer. The temperature was varied from -30°C to 50°C in 10°C increments. After a sufficient time for temperature stabilization the RF output frequency was measured. At 20°C the power supply voltage to the EUT was varied from 85% to 115% of the nominal value and the RF output was measured.

Tuned Frequency – 460.05 MHz
Tolerance – 2.5 ppm
Upper Limit – 460.051150 MHz
Lower Limit – 460.048850 MHz

Measurement Setup

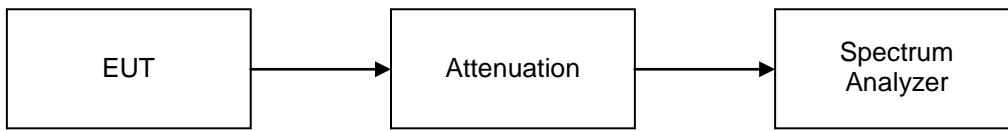

Measurement Results

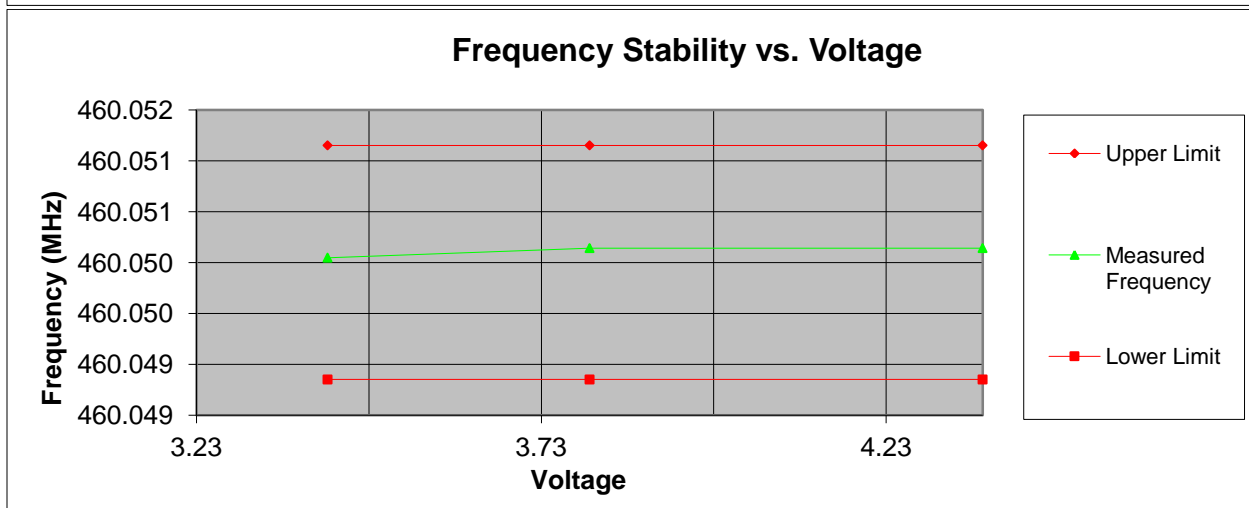
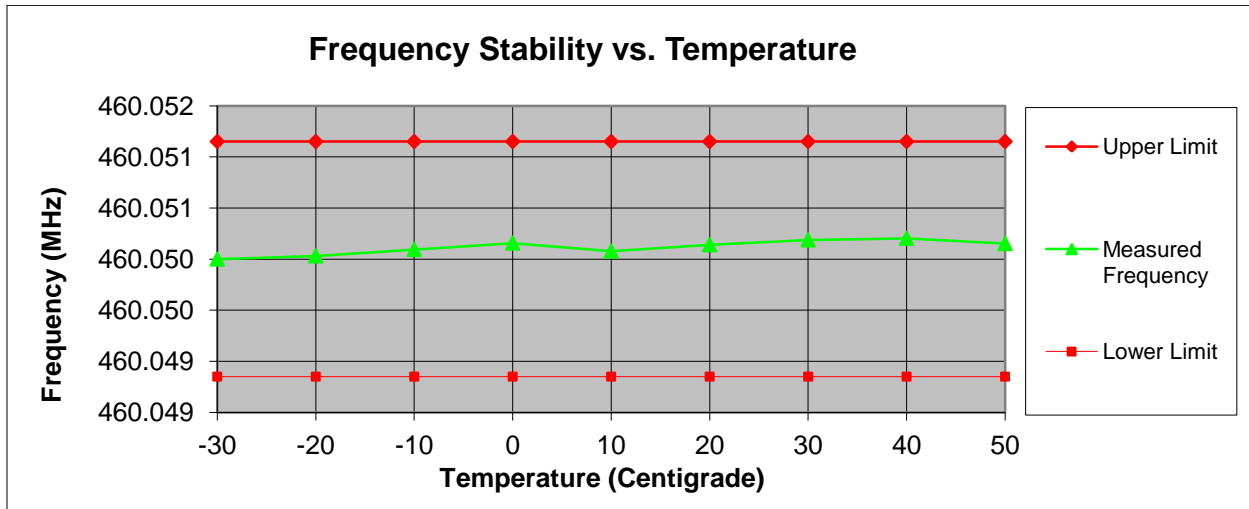

*Note: The minimum operating voltage of this device is 3.42 vdc.



Necessary Bandwidth Calculations

Name of Test: Necessary Bandwidth Calculations
Test Specification: 2.202

Engineer: Alex Macon
Test Date: 8/20/13

Modulation = 11K0F3E		
Necessary Bandwidth Calculation:		
Maximum Modulation (M), kHz	=	3
Maximum Deviation (D), kHz	=	2.5
Constant Factor (K)	=	1
Necessary Bandwidth (B _N), kHz	=	(2xM)+(2xDxK)
	=	11.0



Test Equipment Utilized

Description	MFG	Model Number	CT Asset Number	Last Cal Date	Cal Due Date
Power Supply	HP	6286A	i00054	NCR	NCR
Temperature Chamber	Tenney	Tenney Jr.	i00027	Verified on: 8/22/13	
Function Generator	HP	33120A	i00118	Verified on: 8/20/13	
Tunable Notch Filter	Eagle	TNF-1-(250-850MHz)	i00124	NCR	NCR
Bi-Log Antenna	Schaffner	CBL611C	i00267	12/19/11	12/19/13
Horn Antenna, Amplified	ARA	DRG-118/A	i00271	4/19/12	4/19/14
Humidity / Temp Meter	Newport	IBTHX-W-5	i00282	12/4/12	12/4/13
Voltmeter	Fluke	75III	i00320	2/1/13	2/1/14
Spectrum Analyzer	Agilent	E4407B	i00331	4/23/13	4/23/14
Data Logger	Fluke	Hydra Data Bucket	i00343	12/19/12	12/19/13
Spectrum Analyzer	Tektronix	RSA3308A	i00345	10/16/12	10/16/13
EMI Analyzer	Agilent	E7405A	i00379	11/21/12	11/21/13
Thermo Hygrometer	Omega	RH81	i00408	4/15/13	4/15/15

In addition to the above listed equipment standard RF connectors and cables were utilized in the testing of the described equipment. Prior to testing these components were tested to verify proper operation.

END OF TEST REPORT