

# KENWOOD

## NEXEDGE

NX-240

NX-240V

NX-340

NX-340U



VHF DIGITAL TRANSCEIVER

UHF DIGITAL TRANSCEIVER

### INSTRUCTION MANUAL

ÉMETTEUR-RÉCEPTEUR NUMÉRIQUE VHF

ÉMETTEUR-RÉCEPTEUR NUMÉRIQUE UHF

### MODE D'EMPLOI

TRANSCEPTOR DIGITAL VHF

TRANSCEPTOR DIGITAL UHF

### MANUAL DE INSTRUCCIONES

JVCKENWOOD Corporation

© B62-2580-00 (K, P)

09 08 07 06 05 04 03 02 01 00



VHF DIGITAL TRANSCEIVER  
UHF DIGITAL TRANSCEIVER

**NX-240**      **NX-240V**

**NX-340**      **NX-340U**

---

## INSTRUCTION MANUAL

JVCKENWOOD Corporation

ENGLISH

# THANK YOU

We are grateful you have chosen **KENWOOD** for your land mobile radio applications.

## NOTICES TO THE USER

- ◆ Government law prohibits the operation of unlicensed radio transmitters within the territories under government control.
- ◆ Illegal operation is punishable by fine and/or imprisonment.
- ◆ Refer service to qualified technicians only.

**Safety:** It is important that the operator is aware of, and understands, hazards common to the operation of any transceiver.

### Terminal Descriptions

#### Speaker/ Microphone Jacks

It is possible to use a resin-based cover for the Speaker/ Microphone jacks.

No.	Name	Description	Impedance	I/O
1	PTT / RXD	External PTT Input / Serial Data Input	CMOS	I
2	MIC INPUT	External MIC Input	1.8 k $\Omega$	I
3	MIC OUTPUT	Internal MIC Output	1.8 k $\Omega$	O
4	OPTDET	External Option Detect	High Impedance	I
5	50V	5V Output	100 $\Omega$	O
6	AE	GND	GND	-
7	TXD	Serial Data Output	CMOS	O
8	NC	No Connection	-	-
9	NC	No Connection	-	-
10	SPO	Received Audio Output	8 $\Omega$	O

#### Antenna Terminal

50  $\Omega$  impedance

#### Battery Terminal

The battery terminal uses a spring plate.

The negative terminal connects to the chassis ground.

The battery is mounted on the rear side of the transceiver using a latch mounting method.

**One or more of the following statements may be applicable:**

**FCC WARNING**

This equipment generates or uses radio frequency energy. Changes or modifications to this equipment may cause harmful interference unless the modifications are expressly approved in the instruction manual. The user could lose the authority to operate this equipment if an unauthorized change or modification is made.

**INFORMATION TO THE DIGITAL DEVICE USER REQUIRED BY THE FCC**

This equipment has been tested and found to comply with the limits for a Class B digital device, pursuant to Part 15 of the FCC Rules. These limits are designed to provide reasonable protection against harmful interference in a residential installation.

This equipment generates, uses and can generate radio frequency energy and, if not installed and used in accordance with the instructions, may cause harmful interference to radio communications. However, there is no guarantee that the interference will not occur in a particular installation. If this equipment does cause harmful interference to radio or television reception, which can be determined by turning the equipment off and on, the user is encouraged to try to correct the interference by one or more of the following measures:

- Reorient or relocate the receiving antenna.
- Increase the separation between the equipment and receiver.
- Connect the equipment to an outlet on a circuit different from that to which the receiver is connected.
- Consult the dealer for technical assistance.



### ATTENTION:

The RBRC Recycle seal found on **KENWOOD** lithium-ion (Li-ion) battery packs indicates **KENWOOD's** voluntary participation in an industry program to collect and recycle Li-ion batteries after their operating life has expired. The RBRC program is an alternative to disposing Li-ion batteries with your regular refuse or in municipal waste streams, which is illegal in some areas.

For information on Li-ion battery recycling in your area, call (toll free) 1-800-8-BATTERY (1-800-822-8837).

**KENWOOD's** involvement in this program is part of our commitment to preserve our environment and conserve our natural resources.

## PRECAUTIONS

- Do not charge the transceiver and battery pack when they are wet.
- Ensure that there are no metallic items located between the transceiver and the battery pack.
- Do not use options not specified by **KENWOOD**.
- If the die-cast chassis or other transceiver part is damaged, do not touch the damaged parts.
- If a headset or headphone is connected to the transceiver, reduce the transceiver volume. Pay attention to the volume level when turning the squelch off.
- Do not place the microphone cable around your neck while near machinery that may catch the cable.
- Do not place the transceiver on unstable surfaces.
- Ensure that the end of the antenna does not touch your eyes.
- When the transceiver is used for transmission for many hours, the radiator and chassis will become hot. Do not touch these locations when replacing the battery pack.
- Do not immerse the transceiver in water.
- Always switch the transceiver power off before installing optional accessories.
- The charger is the device that disconnects the unit from the AC mains line. The AC plug should be readily accessible.





## WARNING

Turn the transceiver power off in the following locations:

- In explosive atmospheres (inflammable gas, dust particles, metallic powders, grain powders, etc.).
- While taking on fuel or while parked at gasoline service stations.
- Near explosives or blasting sites.
- In aircraft. (Any use of the transceiver must follow the instructions and regulations provided by the airline crew.)
- Where restrictions or warnings are posted regarding the use of radio devices, including but not limited to medical facilities.
- Near persons using pacemakers.



## CAUTION

- Do not disassemble or modify the transceiver for any reason.
- Do not place the transceiver on or near airbag equipment while the vehicle is running. When the airbag inflates, the transceiver may be ejected and strike the driver or passengers.
- Do not transmit while touching the antenna terminal or if any metallic parts are exposed from the antenna covering. Transmitting at such a time may result in a high-frequency burn.
- If an abnormal odor or smoke is detected coming from the transceiver, switch the transceiver power off immediately, remove the battery pack from the transceiver, and contact your **KENWOOD** dealer.
- Use of the transceiver while you are driving may be against traffic laws. Please check and observe the vehicle regulations in your area.
- Do not expose the transceiver to extremely hot or cold conditions.
- Do not carry the battery pack (or battery case) with metal objects, as they may short the battery terminals.
- When operating the transceiver in areas where the air is dry, it is easy to build up an electric charge (static electricity). When using an earphone accessory in such conditions, it is possible for the transceiver to send an electric shock through the earphone and to your ear. We recommend you use only a speaker/microphone in these conditions, to avoid electric shocks.

## Information concerning the battery pack:

The battery pack includes flammable objects such as organic solvent. Mishandling may cause the battery to rupture producing flames or extreme heat, deteriorate, or cause other forms of damage to the battery. Please observe the following prohibitive matters.



**DANGER**

- **Do not disassemble or reconstruct battery!**

The battery pack has a safety function and protection circuit to avoid danger. If they suffer serious damage, the battery may generate heat or smoke, rupture, or burst into flame.

- **Do not short-circuit the battery!**

Do not join the + and – terminals using any form of metal (such as a paper clip or wire). Do not carry or store the battery pack in containers holding metal objects (such as wires, chain-necklaces or hairpins). If the battery pack is short-circuited, excessive current will flow and the battery may generate heat or smoke, rupture, or burst into flame. It will also cause metal objects to heat up.

- **Do not incinerate or apply heat to the battery!**

If the insulator is melted, the gas release vent or safety function is damaged, or the electrolyte is ignited, the battery may generate heat or smoke, rupture, or burst into flame.

- **Do not leave the battery near fire, stoves, or other heat generators (areas reaching over 80°C/ 176°F)!**

If the polymer separator is melted due to high temperature, an internal short-circuit may occur in the individual cells and the battery may generate heat or smoke, rupture, or burst into flame.

- **Do not immerse the battery in water or get it wet by other means!**

If the battery's protection circuit is damaged, the battery may charge at extreme current (or voltage) and an abnormal chemical reaction may occur. The battery may generate heat or smoke, rupture, or burst into flame.

- **Do not charge the battery near fire or under direct sunlight!**

If the battery's protection circuit is damaged, the battery may charge at extreme current (or voltage) and an abnormal chemical reaction may occur. The battery may generate heat or smoke, rupture, or burst into flame.





## DANGER

- **Use only the specified charger and observe charging requirements!**

If the battery is charged in unspecified conditions (under high temperature over the regulated value, excessive high voltage or current over regulated value, or with a remodeled charger), it may overcharge or an abnormal chemical reaction may occur. The battery may generate heat or smoke, rupture, or burst into flame.

- **Do not pierce the battery with any object, strike it with an instrument, or step on it!**

This may break or deform the battery, causing a short-circuit. The battery may generate heat or smoke, rupture, or burst into flame.

- **Do not jar or throw the battery!**

An impact may cause the battery to leak, generate heat or smoke, rupture, and/or burst into flame. If the battery's protection circuit is damaged, the battery may charge at an abnormal current (or voltage), and an abnormal chemical reaction may occur. The battery may generate heat or smoke, rupture, or burst into flame.

- **Do not use the battery pack if it is damaged in any way!**

The battery may generate heat or smoke, rupture, or burst into flame.

- **Do not solder directly onto the battery!**

If the insulator is melted or the gas release vent or safety function is damaged, the battery may generate heat or smoke, rupture, or burst into flame.

- **Do not reverse the battery polarity (and terminals)!**

When charging a reversed battery, an abnormal chemical reaction may occur. In some cases, an unexpected large amount of current may flow upon discharging. The battery may generate heat or smoke, rupture, or burst into flame.

- **Do not reverse-charge or reverse-connect the battery!**

The battery pack has positive and negative poles. If the battery pack does not smoothly connect with a charger or operating equipment, do not force it; check the polarity of the battery. If the battery pack is reverse-connected to the charger, it will be reverse-charged and an abnormal chemical reaction may occur. The battery may generate heat or smoke, rupture, or burst into flame.

**DANGER**

- **Do not touch a ruptured and leaking battery!**

If the electrolyte liquid from the battery gets into your eyes, wash your eyes with fresh water as soon as possible, without rubbing your eyes. Go to the hospital immediately. If left untreated, it may cause eye-problems.

**WARNING**

- **Do not charge the battery for longer than the specified time!**

If the battery pack has not finished charging even after the regulated time has passed, stop it. The battery may generate heat or smoke, rupture, or burst into flame.

- **Do not place the battery pack into a microwave or high pressure container!**

The battery may generate heat or smoke, rupture, or burst into flame.

- **Keep ruptured and leaking battery packs away from fire!**

If the battery pack is leaking (or the battery emits a bad odor), immediately remove it from flammable areas. Electrolyte leaking from battery can easily catch on fire and may cause the battery to generate smoke or burst into flame.

- **Do not use an abnormal battery!**

If the battery pack emits a bad odor, appears to have different coloring, is deformed, or seems abnormal for any other reason, remove it from the charger or operating equipment and do not use it. The battery may generate heat or smoke, rupture, or burst into flame.

# CONTENTS

UNPACKING AND CHECKING EQUIPMENT .....	1
PREPARATION.....	2
ORIENTATION .....	7
PROGRAMMABLE AUXILIARY FUNCTIONS.....	8
BASIC OPERATIONS.....	11
VOICE OPERATED TRANSMISSION (VOX).....	14
NXDN .....	15
BACKGROUND OPERATIONS .....	16

---

---

## UNPACKING AND CHECKING EQUIPMENT

---

---

Carefully unpack the transceiver. If any of the items listed below are missing or damaged, file a claim with the carrier immediately.

### SUPPLIED ACCESSORIES

• Antenna .....	1
• Battery charger/ AC adapter .....	1
K type: KSC-35S	
P type: KSC-43	
• Li-ion Battery pack (KNB-45L).....	1
• Speaker/ microphone jack cover .....	1
• Speaker/ microphone locking bracket .....	1
• Belt clip (KBH-10) .....	1
• Screw (M3 x 8 mm) .....	2
• Channel stopper .....	1
• Instruction manual .....	1

---

**Note:** Refer to “PREPARATION” starting on page 2 for accessory installation instructions.

---

---

---

## PREPARATION

---

---

### INSTALLING THE CHANNEL STOPPER

You can set the channel stopper position for channels 2, 4, 6, 8, 10, 12, and 14. Inserting the Channel stopper prevents unnecessarily selecting channels which do not exist.

- Selecting a channel which does not exist causes a continuous error tone to sound.
- 1 Set the Channel selector to channel 1, then pull the Channel selector knob off the transceiver.
    - If the Channel selector is not positioned at channel 1, the knob may not install correctly and the channel may be unable to change.
  - 2 Insert the channel stopper.
  - 3 Set the arrow of the Channel stopper to the highest channel number for the transceiver.
  - 4 Reinsert the Channel selector knob.

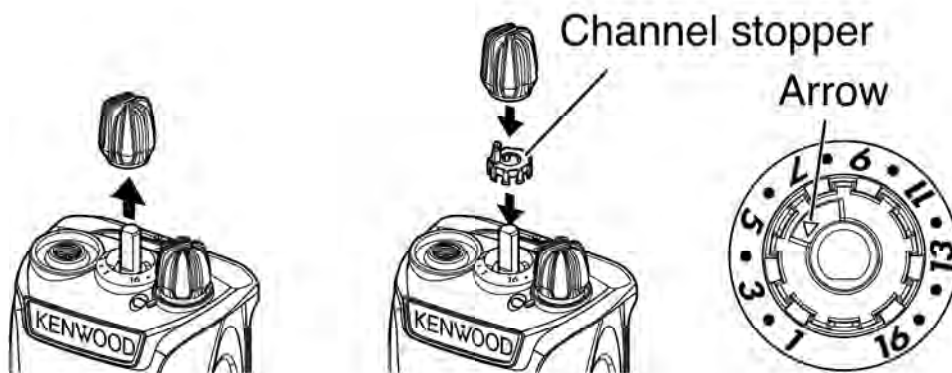

### INSTALLING THE ANTENNA

Antenna

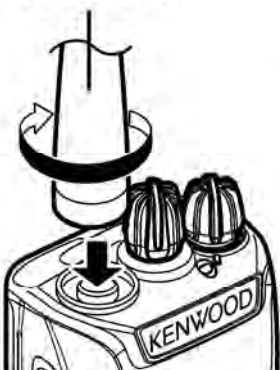

Screw the antenna into the connector on the top of the transceiver by holding the antenna at its base and turning it clockwise until secure.

---

**Note:** The antenna is neither a handle, a key ring retainer, nor a speaker/ microphone attachment point. Using the antenna in these ways may damage the antenna and degrade your transceiver's performance.

---



## INSTALLING/ REMOVING THE BATTERY PACK



### CAUTION

- ◆ Do not short the battery terminals or dispose of the battery by fire.
- ◆ Never attempt to remove the casing from the battery pack.

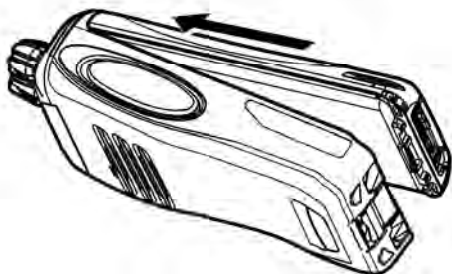

**1** Align the battery pack with the back of the transceiver, then press the battery pack and transceiver firmly together until the release latch on the base of the transceiver locks.

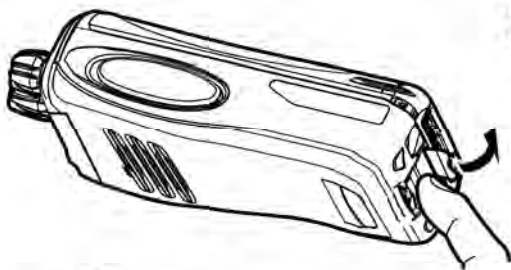

**2** To remove the battery pack, lift the safety catch on the base of the transceiver, then press the release latch underneath the safety catch.

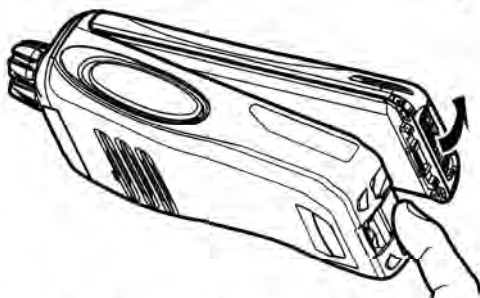

**3** While pressing the release latch, pull the battery pack away from the transceiver.

## INSTALLING THE BELT CLIP

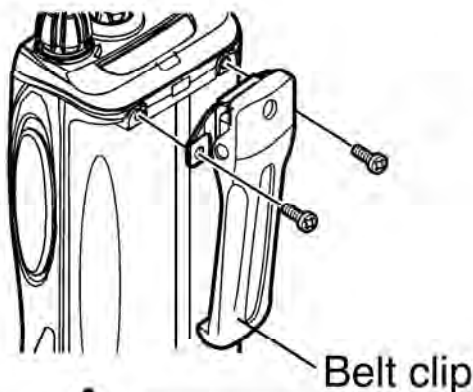

If necessary, attach the belt clip using the two supplied M3 x 8 mm screws.

**Note:** If the belt clip is not installed, its mounting location may get hot during continuous transmission or when left sitting in a hot environment.



### CAUTION

Do not use glue which is designed to prevent screw loosening when installing the belt clip, as it may cause damage to the transceiver. Acrylic ester, which is contained in these glues, may crack the transceiver's back panel.



# CHARGING THE BATTERY PACK

The battery pack is not charged at the factory; charge it before use.

---

**ATTENTION:** Always switch OFF a transceiver equipped with a battery pack before inserting the transceiver into the charger.

---

- 1 Plug the AC adapter cable into the jack located on the rear of the charger.
- 2 Plug the AC adapter into an AC outlet.
- 3 **KSC-43 Only:** Match the holder to the type of battery pack to be charged so that when inserting the holder, the battery type name can be seen on the bottom of the charger. After inserting the holder into the charger, press the locking tabs to secure it in place.
  - To remove the holder, squeeze the locking tabs together then pull the holder out of the charger.



- 4 Slide a battery pack or a transceiver equipped with a battery pack into the charging slot of the charger.
  - Make sure the metal contacts of the battery pack mate securely with the charger terminals.
  - The indicator lights red and charging begins.

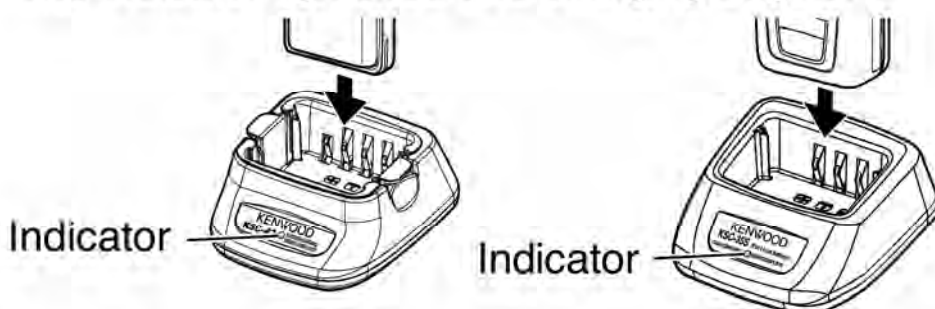

- 5 When charging is completed, the indicator lights green. Remove the battery pack or the transceiver from the charging slot of the charger.
- It takes approximately 3 hours to charge the battery pack.
  - When the charger will not be used for a long time, unplug the AC adapter from the AC outlet.

---

**Note:**

- ◆ When the indicator blinks red, the battery pack is either defective or the battery pack contacts are not properly mated with those of the charger.
  - ◆ When the indicator flashes green and orange, the battery pack has not satisfied the charging start temperature. Remove the battery pack from the charger and wait until it reaches a normal temperature before charging it again.
  - ◆ The ambient temperature should be between 41°F and 104°F (5°C and 40°C) while charging is in progress. Charging outside this range may not fully charge the battery.
  - ◆ The battery pack life is over when its operating time decreases even though it is fully and correctly charged. Replace the battery pack.
- 

## INSTALLING THE CAP OVER THE SPEAKER/ MICROPHONE JACKS

Install the cap over the speaker/ microphone jacks when not using an optional speaker/ microphone.

---

**Note:** To keep the transceiver water resistant, you must cover the speaker/ microphone jacks with the supplied cap.

---

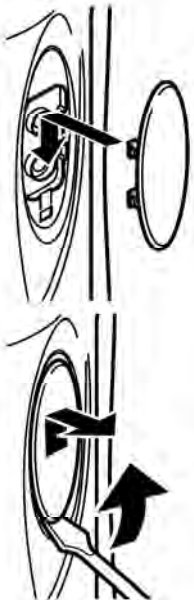

- 1 Place the cap over the jacks so that the locking tabs insert into the transceiver grooves.
- 2 While holding the cap in place, push it towards the bottom of the transceiver until the tabs on the cap click into place.
  - To remove the cap, hold the top of the cap in place with your finger while inserting a 2 mm or smaller flat blade screwdriver under the bottom of the cap. Slowly slide the screwdriver in until its tip touches the tab inside the cap, then gently pry the cap up (handle of screwdriver moving away from the transceiver) to remove the cap.

# INSTALLING THE OPTIONAL SPEAKER/ MICROPHONE (OR HEADSET)

---

**Note:** The transceiver is not fully water resistant when using a speaker/ microphone or headset.

---

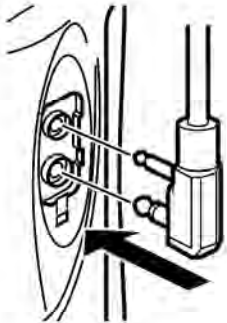

- 1 Insert the speaker/ microphone (or headset) plugs into the speaker/ microphone jacks of the transceiver.

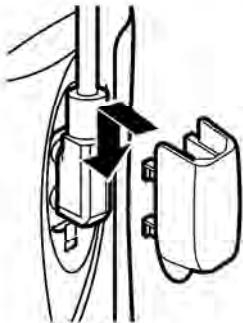

- 2 Place the locking bracket over the speaker/ microphone (or headset) plugs so that the locking tabs insert into the transceiver grooves.
  - Push down on the locking bracket to slide it into place.



- 3 While holding the locking bracket in place, push it towards the bottom of the transceiver until the tabs on the bracket click into place.
  - To remove the locking bracket, push the bracket up from the base.

---

# ORIENTATION

---

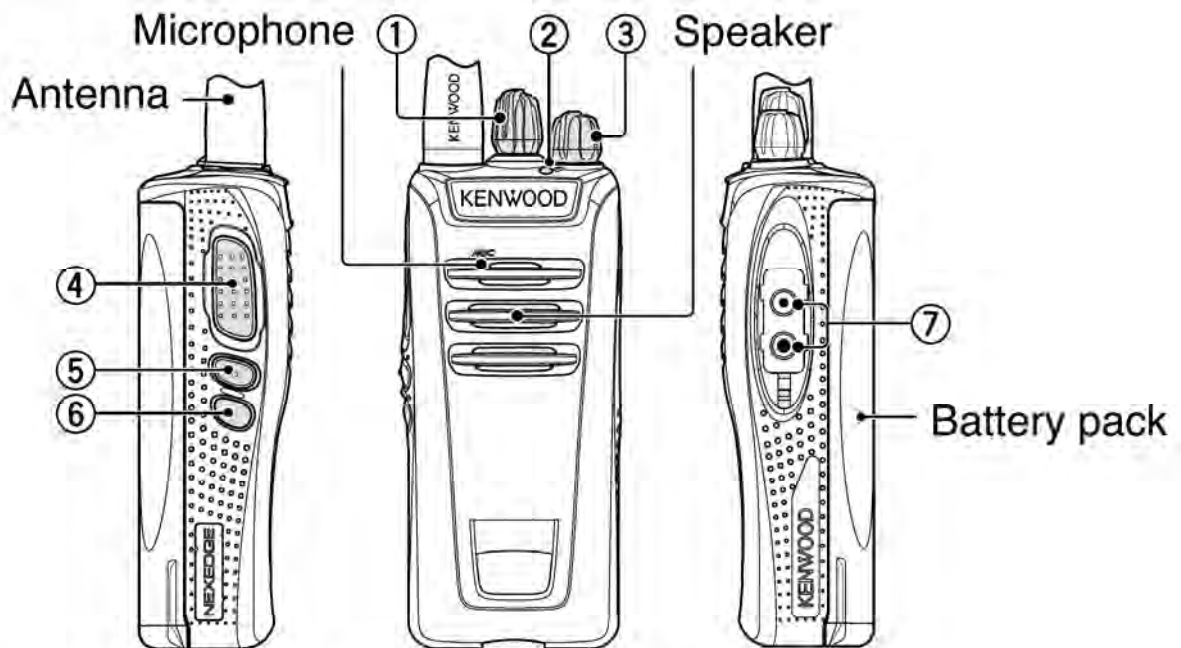

- ① **Channel selector**  
Rotate to change the operating channel.
- ② **LED indicator**  
For the LED indicator status, refer to page 13.
- ③ **Power switch/ Volume control**  
Turn clockwise to switch ON the transceiver. To switch OFF the transceiver, turn counterclockwise until a click sounds. Rotate to adjust the volume level.
- ④ **PTT (Push to Talk) switch**  
Press and hold, then speak into the microphone to transmit.
- ⑤ **Side 1 key**  
Press to activate its programmable function {page 8}.
- ⑥ **Side 2 key**  
Press to activate its programmable function {page 8}.
- ⑦ **Speaker/ microphone jacks**  
Insert the Speaker/ microphone or Headset plug into this jack {page 6}.



---

---

## PROGRAMMABLE AUXILIARY FUNCTIONS

---

---

Your dealer can program the **Side 1** and **Side 2** keys each with one of the functions listed below.

---

**Note:** The duration of pressing a key to activate a function is dependent on your dealer setting. Your dealer may have set some keys to be held down for a short duration instead of being momentarily pressed. Ask your dealer for details on which keys need to be held down to activate their functions.

---

- **None**  
No function has been programmed.
- **Autodial**<sup>1</sup>  
Autodial allows you to make a private DTMF call to another party.
- **Call 1/ Call 2**  
Press to send a FleetSync status, NXDN status, or 2-tone signaling call.
- **Calling Alert**<sup>1</sup>  
A calling alert tone allows you to alert party members that you are making a call. When making a call, first hold down this key.
  - While holding down the key, the calling alert tone will sound. Release the key to end the tone, then hold down the **PTT** switch and speak into the microphone to transmit.
- **CW Message**<sup>2</sup>  
Press to transmit the preset Morse code message on your current channel.
- **Emergency**  
Press and hold to enter (or exit) Emergency mode.
- **Key Lock**  
Press to lock/unlock the transceiver keys. Without Status Memory, when the transceiver power is turned OFF and then ON again, the Key Lock function will be cancelled.



## ■ **Key Lock with Status Memory**

This operates the same as Key Lock except that when the transceiver power is turned OFF and then ON again, the keys remains locked.

## ■ **Lone Worker**

Lone Worker Mode is a safety feature built into the transceiver. If the transceiver is not operated for a pre-programmed period of time, the transceiver will emit a tone and automatically enter Emergency operation. Press this key to toggle the Lone Worker function ON or OFF.

## ■ **Low Transmit Power**

Each channel is programmed with either high or low transmit power. On high transmit power channels, press this key to change the transmit power to low power (you cannot change low transmit power channels to use high power).

## ■ **Monitor**

Press to deactivate signaling (QT/DQT, FleetSync signaling, NXDN, etc.). Press this key again to return to normal operation.

## ■ **Monitor Momentary**

Continuously hold down this key to deactivate signaling (QT/DQT, FleetSync signaling, NXDN, etc.). Release this key to return to normal operation.

## ■ **Paging Call**

Press to send a FleetSync or NXDN paging call to an ID from the ID list.

## ■ **Priority Zone-Channel Select**

If the scan priority type is "Operator Selectable", press this key in normal mode to set the current channel as the Priority channel.

## ■ **Scan**

Press to start (or stop) scanning the transceiver channels.

## ■ **Scan Temporary Delete**

When scan pauses at an undesired channel, you can remove that channel from the scanning sequence by pressing or holding this key.

## ■ **Scrambler/Encryption**

The Scrambler (analog) and Encryption (NXDN) function allows you to hold a conversation in complete privacy. When activated, any other party listening in on your channel will be unable to understand your conversation. Press this key to toggle the Scrambler/Encryption function ON or OFF.

## ■ **Send the GPS data**

With the KMC-48GPS unit is connected, you can press this key to send your positioning data to the base station.

## ■ **Squelch Off**<sup>1</sup>

Press to hear background noise. Press this key again to return to normal operation.

## ■ **Squelch Off Momentary**<sup>1</sup>

Continuously hold down this key to hear background noise. Release this key to return to normal operation.

## ■ **Talk Around**

The Talk Around function allows you to communicate directly with other transceivers, without the use of a repeater. Press this key to toggle the Talk Around function ON or OFF.

## ■ **Zone Down**

Press to select the next zone.

## ■ **Zone Up**

Press to select the previous zone.

<sup>1</sup> Available only for Analog operation.

<sup>2</sup> Available only for NXDN operation.

---

---

# BASIC OPERATIONS

---

---

## SWITCHING POWER ON/OFF

Turn the **Power** switch/ **Volume** control clockwise to switch the transceiver ON.

Turn the **Power** switch/ **Volume** control counterclockwise fully to switch the transceiver OFF.

### ■ Transceiver Password

If your transceiver is password protected, the LED will light blue when you turn the transceiver ON. Enter the password (up to 4 digits) using the following procedure.

- 1 Set the **Channel** selector to position “1”.
- 2 Press the **Side 1** or **Side 2** key to enter the first digit.
  - The **Side 1** key increases the digit value and the **Side 2** key decreases it. The transceiver announces the digit number as it changes.
- 3 Repeat step 2 for **Channel** selector positions 2 ~ 4.
  - If there are less than 4 password digits, repeat for only the number of digits the password contains.
- 4 Press the **PTT** switch to confirm the password.
  - When the correct password is entered, the Blue LED turns off.

## ADJUSTING THE VOLUME

Rotate the **Power** switch/ **Volume** control to adjust the volume. Clockwise increases the volume and counterclockwise decreases it.

## SELECTING A ZONE AND CHANNEL

- 1 Select the desired zone using the key programmed as **[Zone Up]** or **[Zone Down]**.
  - Each zone contains a group of channels.
- 2 Select the desired channel using the **Channel** selector.
  - Each channel is programmed with settings for transmitting and receiving.

## TRANSMITTING

- 1 Select the desired zone and channel.
- 2 Press the key programmed as **[Monitor]** or **[Squelch Off]** to check whether or not the channel is free.
  - If the channel is busy, wait until it becomes free.
- 3 Press the **PTT** switch and speak into the microphone. Release the **PTT** switch to receive.
  - For best sound quality, hold the transceiver approximately 1.5 inches (3 ~ 4 cm) from your mouth.

## RECEIVING

Select the desired zone and channel. If signaling has been programmed on the selected channel, you will hear a call only if the received signal matches your transceiver settings.

---

**Note:** Signaling allows your transceiver to code your calls. This will prevent you from listening to unwanted calls. Refer to "SIGNALING" on page 17 for details.

---

## LED INDICATOR STATUS

Indicator Color	Meaning
Lights red	Transmitting
Lights green	Receiving a call
Blinks red	Battery power is low while transmitting
Blinks green	Scanning
Blinks orange or blue *	Receiving an encoded call (FleetSync signaling, etc.)
Blinks red/orange	The selected channel has not been programmed and cannot be used.

- \* Your dealer can set the LED to blink either orange or blue for FleetSync, DTMF, 2-tone, or NXDN operation.
- \* Lights orange in Analog mode.
- \* Lights blue in Digital mode.



---

---

## VOICE OPERATED TRANSMISSION (VOX)

---

---

VOX operation allows you to transmit hands-free. This feature must first be activated by your dealer, and can only be used if you are using a supported headset. VOX can be turned off for specific channels by your dealer. To activate VOX and set the VOX Gain level, perform the following steps:

- 1** Connect a headset to the transceiver.
  - The VOX function does not activate when a headset is not connected to the accessory terminal of the transceiver.
- 2** With the transceiver power OFF, press and hold the **Side 1** key while turning the transceiver power ON.
- 3** Continue to hold the **Side 1** key until a beep sounds.
  - The LED indicator lights orange.
  - When the **Side 1** key is released, the transceiver will announce the VOX Gain level.
- 4** Press the **Side 1** key to set the VOX Gain level, from 1 (least sensitive) to 10 (most sensitive).
  - Press the **Side 2** key to enable or disable the VOX function for the current channel (you can change this setting for each channel by selecting a channel with the **Channel** selector). When turned ON, a beep sounds. When turned OFF, a double beep sounds.
- 5** Press the **PTT** switch to save the setting.
  - A beep will sound.
  - The transceiver announces the new VOX Gain level.
- 6** Turn the transceiver power OFF and then ON again to activate VOX.

---

### Note:

- ◆ If key lock or key lock with status memory is ON, you will be unable to enter VOX setup mode.
  - ◆ If a headset is connected to the transceiver while the VOX function is switched ON and the VOX Gain level is configured to a higher, more sensitive level, louder received signals may cause the transceiver to start transmitting.
  - ◆ If no operation is performed for 20 seconds, the transceiver will exit VOX setup mode.
-

---

---

## NXDN

---

---

NXDN is a general term for the NXDN wireless communication protocol which uses 4 Level FSK. Various data communications, including individual and group voice communications, Status calls, and GPS data transmission, are possible.

### INDIVIDUAL/GROUP CALLS

Each channel is set up with an individual or group ID list number. To make a call, select the channel with the ID list number you wish to call, then press the **PTT** switch to start the call.

- Your dealer may also have set Selcall on PTT for Individual or Group calls, allowing you to make an Individual or Group call when pressing the **PTT** switch.
- To page the unit instead of initiating a voice call, press the key programmed as [**Paging Call**].
- If PTT Proceed tone is enabled, the Proceed tone will sound. After the tone ends, you can begin the call.

### ■ Receiving

When you receive an individual call, a ringing tone will sound. Respond to the call by pressing the **PTT** switch.

- If the auto reset timer expires before you respond to the call, the call will end. Your dealer can set the duration for the auto reset timer (default is 10 seconds).

When you receive a group call and the received group ID matches the ID set up on your transceiver, a ringing tone will sound and you can hear the caller's voice.

### STATUS CALL

You can transmit your status (preset by your dealer) to a unit by pressing the key programmed as [**Call 1**] or [**Call 2**], if they have been set up with an NXDN Status.

- Channels are set up with ID list numbers by your dealer. Select the desired channel before sending the status call.

---

---

## BACKGROUND OPERATIONS

---

---

### TIME-OUT TIMER (TOT)

The Time-out Timer prevents callers from using a channel for an extended duration. If you continuously transmit for the duration programmed by your dealer (default is 1 minute), transmission will stop and a warning tone will sound. To stop the tone, release the **PTT** switch.

### BATTERY SAVER

When activated by your dealer, the Battery Saver function decreases the amount of power used after no signal is present and no operations are being performed for 5 seconds. When a signal is received or an operation is performed, Battery Saver turns off.

---

**Note:** While the Battery Saver is operating, the LED may flash green when receiving a QT/DQT signal which does not match the QT/DQT tone/code set up in your transceiver.

---

### LOW BATTERY WARNING

While operating the transceiver, the Low Battery Warning sounds until the PTT switch is released and the LED indicator blinks red when the battery needs recharged or replaced.

### BUSY CHANNEL LOCKOUT (BCL)

When activated, BCL prevents you from interfering on a channel that is already in use. Pressing the **PTT** switch will cause an alert tone to sound and the transceiver will not transmit. Release the **PTT** switch to stop the tone.

---

**Note:** Ask your dealer for an explanation on how BCL functions when using QT, DQT, RAN, or Optional signaling.

---

If BCL Override has been programmed, you can transmit over the current signal:

- 1 Press and hold the **PTT** switch.
  - If the channel is already in use, a warning tone will sound.
- 2 Quickly release and then press the **PTT** switch again.
- 3 Speak into the transceiver as you would during a normal call.

## **PTT ID**

PTT ID is the transceiver unique ID code which is sent each time the **PTT** switch is pressed and/or released.

---

**Note:** PTT ID can be made only in analog operation.

---

## **SIGNALING**

### ■ **QT/ DQT**

The Encoder/Decoder function uses QT/ DQT to segregate talk groups, so users only hear calls from their own group.

### ■ **Radio Access Number (RAN)**

RAN is a signaling system designed for digital radio communications. When a channel is set up with a RAN, squelch will only open when a call containing a matching RAN is received. If a call containing a different RAN is made on the channel you are using, you will not hear the call. This allows you to ignore (not hear) calls from other parties who are using the same channel.

### ■ **NXDN ID**

NXDN ID is an optional signaling system available only for digital communications.

### ■ **DTMF**

A DTMF PTT ID is included for dispatch operations or simple remote control applications. The DTMF decode capabilities include Selective Call ID, Transpond with ID, and "Wild Card" Group Calling.



## ■ 2-Tone

2-tone Signaling opens the squelch only when your transceiver receives a call containing matching 2 tones.

## ■ FleetSync

Utilizing JVC KENWOOD's FleetSync digital signaling protocol, this transceiver has PTT ID and Selective Calling capabilities for managed dispatch operations. For hazardous/hostile duty environments, the **Side1** or **Side 2** key can be programmed for Emergency status to alert the dispatcher and/or operator in distress.

## ■ MDC-1200

The following features are available with the built-in MDC signaling: PTT ID Encode, Emergency Encode, Stun/Revive Decode, and Radio Check Decode.

---

**Note:** The transceiver cannot decode MDC-1200 if the FleetSync baud rate is 2400 bps.

---

## COMPANDER

If programmed by your dealer for a channel, the compander will remove excessive noise from transmitted signals, to provide higher clarity of signals.

---

**Note:** The compander is used only in analog operation.

---

## VOICE ANNUNCIATION

If enabled by your dealer, when changing the zone and channel, an audio voice will announce the new zone and channel number.



ÉMETTEUR-RÉCEPTEUR NUMÉRIQUE VHF  
ÉMETTEUR-RÉCEPTEUR NUMÉRIQUE UHF

**NX-240**      **NX-240V**

**NX-340**      **NX-340U**

---

**MODE D'EMPLOI**

JVCKENWOOD Corporation

**FRANÇAIS**

TRANSCEPTOR DIGITAL VHF  
TRANSCEPTOR DIGITAL UHF

**NX-240**      **NX-240V**

**NX-340**      **NX-340U**

---

## MANUAL DE INSTRUCCIONES

JVCKENWOOD Corporation

**ESPAÑOL**

**KENWOOD**

## RADIO FREQUENCY ENERGY SAFETY INFORMATION

This **KENWOOD** transceiver has been tested and complies with the standards listed below, in regards to **RADIO FREQUENCY (RF) energy and electromagnetic energy (EME)** generated by the transceiver.

- FCC RF exposure limits for *Occupational Use Only*. RF Exposure limits adopted by the FCC are generally based on recommendations from the National Council on Radiation Protection and Measurements, & the American National Standards Institute.
- FCC OET Bulletin 65 Edition 97-01 Supplement C
- American National Standards Institute (C95.1 – 1992)
- American National Standards Institute (C95.3 – 1992)

### WARNING

This **KENWOOD** transceiver generates RF EME while transmitting. RF EME (Radio Frequency Electric & Magnetic Energy) has the potential to cause slight thermal, or heating effects to any part of your body less than the recommended distance from this radio transmitter's antenna. RF energy exposure is determined primarily by the distance to and the power of the transmitting device. In general, RF exposure is minimized when the lowest possible power is used or transmission time is kept to the minimum required for consistent communications, and the greatest distance possible from the antenna to the body is maintained. The transceiver has been designed for and is classified for *Occupational Use Only*. Occupational/ controlled exposure limits are applicable to situations in which persons are exposed to RF energy as a consequence of their employment, and such persons have been made aware of the potential for exposure and can exercise control over their exposure. This means you can use the transceiver only if you are aware of the potential hazards of operating a transceiver and are familiar in ways to minimize these hazards. This transceiver is not intended for use by the general public in uncontrolled environments. Uncontrolled environment exposure limits are applicable to situations in which the general public may be exposed to RF energy, or in which the persons who are exposed as a consequence of their employment may not be fully aware of the potential for exposure or cannot exercise control over their exposure.

The following list provides you with the information required to ensure that you are aware of RF exposure and of how to operate this transceiver so that the FCC RF exposure limitations are not exceeded.

- While transmitting (holding the **PTT** switch or speaking with **VOX** enabled), always keep the antenna and the radio at least 3 cm (1 3/16 inches) from your body or face, as well as from any bystanders. A LED on the top of the radio shows red when the transmitter is operating in both **PTT** and **VOX** modes.
- Do not transmit for more than 50% of the total transceiver use time; transmitting over 50% of the total use time may exceed the limits in accordance to the FCC RF exposure requirements. Nominal transceiver operation is 5% transmission time, 5% reception time, and 90% stand-by time.
- Use only the specified antenna for this transceiver; this may be either the antenna provided with the transceiver or another antenna authorized by **KENWOOD**.

Use only **KENWOOD** authorized accessories (antennas, battery packs, belt clips, Speaker/ Mics or headsets etc.): When worn on the body, always place the radio in a **KENWOOD** recommended clip or carrying case meant for this product. The use of other than recommended or approved body- worn accessories may result in RF exposure levels which exceed the FCC's occupational/ controlled environment RF exposure limits.

### CAUTION

To ensure that your exposure to RF EME is within the FCC limits for occupational use, you must observe and adhere to the above points.

## Electromagnetic Interference Compatibility

Electronic devices are susceptible to electromagnetic interference (EMI) if they are not adequately shielded or designed for electromagnetic compatibility. Because this transceiver generates RF energy, it can cause interference to such equipment.

- Turn OFF your transceiver where signs are posted to do so. Hospitals and health care facilities use equipment that is sensitive to electromagnetic radiation.
- Turn OFF your transceiver while on board an aircraft when so instructed. Use of the transceiver must be in accordance with airline regulations and/or crew instructions.

B59-2687-00