



	<u>Date(s) of Evaluation</u> Aug 20-30, Oct 4-10, 2012	<u>Test Report Serial No.</u> 081612ALH-T1191-S90V	<u>Test Report Revision No.</u> Rev. 1.0 (1st Release)	
	<u>Test Report Issue Date</u> Oct. 22, 2012	<u>Description of Test(s)</u> Specific Absorption Rate	<u>RF Exposure Category</u> Occupational (Controlled)	

DECLARATION OF COMPLIANCE - SAR RF EXPOSURE EVALUATION (FCC/IC)

Test Lab Information	Name	CELLTECH LABS INC.			
	Address	21-364 Lougheed Road, Kelowna, B.C. V1X 7R8 Canada			
Test Lab Accreditation(s)	A2LA	ISO/IEC 17025:2005 (A2LA Test Lab Certificate No. 2470.01)			
Applicant Information	Name	KENWOOD USA CORPORATION			
	Address	3970 Johns Creek Court, Suite 100, Suwanee, GA 30024 United States			
Application Type(s)	FCC	TCB Certification	IC	CB Certification	
Standard(s) Applied	FCC	47 CFR §2.1093	IC	Health Canada Safety Code 6	
Procedure(s) Applied	FCC	OET Bulletin 65, Supplement C	FCC	KDB 447498 D01v04	
	FCC	KDB 643646 D01v01	IC	RSS-102 Issue 4	
	IEEE	1528-2003	IEC	62209-1:2005, 62209-2:2010	
Device Classification(s)	FCC	Licensed Non-Broadcast Transmitter Held to Face (TNF) - FCC Part 90			
	IC	Land Mobile Radio Transmitter/Receiver (27.41-960 MHz) - RSS-119 Issue 10			
Device Identifier(s)	FCC ID:	ALH435001	IC	282D-435001	
Device Model(s)	TK-3402-K2 (USA), TK-3402-P (Canada) (Models are electrically and mechanically identical)				
Device Model(s) Tested	TK-3402-P	Test Sample S/N		0421 (Identical Prototype)	
Test Sample Revision No.s	Hardware	1	Firmware	1.0	
Date of Sample Receipt	Aug. 16, 2012		Date(s) of SAR Evaluations	Aug. 20-22, 28- 30, Oct 5-10, 2012	
Device Description	Portable FM UHF Push-To-Talk (PTT) Radio Transceiver				
Transmit Frequency Range	FCC	406.1 - 470.0 MHz			
	IC	406.1 - 430.0; 450.0 - 470.0 MHz			
Manuf. Rated Output Power	5 Watts (Conducted)		Manuf. Tolerance Specification	+ 0 Watts	
Antenna Type(s) Tested	See manufacturer's accessory listing (Section 7.0)				
Battery Type(s) Tested	Li-ion	7.4 V	2000 mAh	P/N: KNB-45L	a
	Ni-MH	7.2 V	1500 mAh	P/N: KNB-9N	b
Body-worn Accessories Tested	Belt-Clip (contains metal)			P/N: KBH-10	1
Audio Accessories Tested	See manufacturer's accessory listing (Section 7.0)				
Max. SAR Level(s) Evaluated	Face-held	3.26 W/kg	1g	50% PTT duty cycle	Occupational / Controlled Exposure
	Body-worn	5.05 W/kg	1g	50% PTT duty cycle	Occupational / Controlled Exposure
FCC Spatial Peak SAR Limit	Head/Body	8.0 W/kg	1g	50% PTT duty cycle	Occupational / Controlled Exposure
Celltech Labs Inc. declares under its sole responsibility that this wireless portable device has demonstrated compliance with the Specific Absorption Rate (SAR) RF exposure requirements specified in FCC 47 CFR §2.1093 and Health Canada Safety Code 6 for the Occupational / Controlled Exposure environment. The device was tested in accordance with the measurement procedures specified in FCC OET Bulletin 65, Supplement C (Edition 01-01), Industry Canada RSS-102 Issue 4, IEEE Standard 1528-2003 and IEC International Standard 62209-1:2005. All measurements were performed in accordance with the SAR system manufacturer recommendations.					
I attest to the accuracy of data. All measurements were performed by me or were made under my supervision and are correct to the best of my knowledge and belief. I assume full responsibility for the completeness of these measurements and vouch for the qualifications of all persons taking them.					
This test report shall not be reproduced partially, or in full, without the prior written approval of Celltech Labs Inc.					
The results and statements contained in this report pertain only to the device(s) evaluated.					
Test Report Approved By			Mike Meaker	Engineering Technologist	Celltech Labs Inc.

Applicant:	Kenwood USA Corporation	FCC ID:	ALH435001	IC ID:	282D-435001	KENWOOD
DUT Type:	Portable UHF PTT Radio Transceiver	Models:	TK-3402-K2-P	406.1 - 470.0 MHz		
2012 Celltech Labs Inc.		This document is not to be reproduced in whole or in part without the prior written permission of Celltech Labs Inc.				Page 1 of 131



TABLE OF CONTENTS	
1.0 INTRODUCTION	4
2.0 SAR MEASUREMENT SYSTEM	4
3.0 RF CONDUCTED OUTPUT POWER MEASUREMENTS	4
4.0 FCC POWER THRESHOLDS FOR PTT DEVICES ($F < 0.5$ GHZ)	5
5.0 SAR PROBE CALIBRATION & MEASUREMENT FREQUENCIES	5
6.0 NO. OF TEST CHANNELS (N_c)	5
7.0 MANUFACTURER'S DISCLOSED ACCESSORY LISTING	6
8.0 FLUID DIELECTRIC PARAMETERS	7
9.0 SAR MEASUREMENT SUMMARY	15
10.0 SAR LEVEL ADJUSTMENT FOR FLUID SENSITIVITY	20
11.0 SAR TEST REDUCTION PROCEDURES APPLIED (FCC KDB 643646)	21
12.0 DETAILS OF SAR EVALUATION	22
13.0 SAR EVALUATION PROCEDURES	22
14.0 SYSTEM PERFORMANCE CHECK	23
15.0 SIMULATED EQUIVALENT TISSUES	24
16.0 SAR LIMITS	24
17.0 ROBOT SYSTEM SPECIFICATIONS	25
18.0 PROBE SPECIFICATION (ET3DV6)	26
19.0 BARSKI PLANAR PHANTOM	26
20.0 DEVICE HOLDER	26
21.0 TEST EQUIPMENT LIST	27
22.0 MEASUREMENT UNCERTAINTIES	28
24.0 REFERENCES	30
APPENDIX A - SAR MEASUREMENT PLOTS	31
APPENDIX B - SYSTEM PERFORMANCE CHECK PLOTS	71
APPENDIX C - MEASURED FLUID DIELECTRIC PARAMETERS	86
APPENDIX D - SAR TEST SETUP & DUT PHOTOGRAPHS	95
APPENDIX E - DIPOLE CALIBRATION	129
APPENDIX F - PROBE CALIBRATION	130
APPENDIX G - BARSKI PLANAR PHANTOM CERTIFICATE OF CONFORMITY	131

	<u>Date(s) of Evaluation</u> Aug 20-30, Oct 4-10, 2012	<u>Test Report Serial No.</u> 081612ALH-T1191-S90V	<u>Test Report Revision No.</u> Rev. 1.0 (1st Release)	 Test Lab Certificate No. 2470.01
	<u>Test Report Issue Date</u> Oct. 22, 2012	<u>Description of Test(s)</u> Specific Absorption Rate	<u>RF Exposure Category</u> Occupational (Controlled)	

REVISION HISTORY			
REVISION NO.	DESCRIPTION	IMPLEMENTED BY	RELEASE DATE
1.0	Initial Release	Mike Meaker	Oct. 22, 2012

TEST REPORT SIGN-OFF			
DEVICE TESTED BY	REPORT PREPARED BY	QA REVIEW BY	REPORT APPROVED BY
Mike Meaker	Cheri Frangiadakis	Mike Meaker	Mike Meaker

Applicant:	Kenwood USA Corporation	FCC ID:	ALH435001	IC ID:	282D-435001	KENWOOD
DUT Type:	Portable UHF PTT Radio Transceiver	Models:	TK-3402-K2-P	406.1 - 470.0 MHz		
2012 Celltech Labs Inc.		This document is not to be reproduced in whole or in part without the prior written permission of Celltech Labs Inc.				Page 3 of 131

	<u>Date(s) of Evaluation</u> Aug 20-30, Oct 4-10, 2012	<u>Test Report Serial No.</u> 081612ALH-T1191-S90V	<u>Test Report Revision No.</u> Rev. 1.0 (1st Release)	  Test Lab Certificate No. 2470.01
	<u>Test Report Issue Date</u> Oct. 22, 2012	<u>Description of Test(s)</u> Specific Absorption Rate	<u>RF Exposure Category</u> Occupational (Controlled)	

1.0 INTRODUCTION

This measurement report demonstrates that the Kenwood USA Corporation Models: TK-3402-K2 and TK-3402-P Portable UHF PTT Radio Transceivers comply with the SAR (Specific Absorption Rate) RF exposure requirements FCC 47 CFR §2.1093 (see reference [1]) and Health Canada's Safety Code 6 (see reference [2]) for the Occupational / Controlled Exposure environment. The measurement procedures described in FCC OET Bulletin 65, Supplement C 01-01 (see reference [3]), IC RSS-102 Issue 4 (see reference [4]), IEEE Standard 1528-2003 (see reference [5]) and IEC Standard 62209-1:2005 (see reference [6]) were employed. A description of the device, operating configuration, detailed summary of the test results, methodology and procedures used in the evaluation, equipment used and the various provisions of the rules are included within this test report.

2.0 SAR MEASUREMENT SYSTEM

Celltech Labs Inc. SAR measurement facility utilizes the Dosimetric Assessment System (DASY™) manufactured by Schmid & Partner Engineering AG (SPEAG™) of Zurich, Switzerland. The DASY4 measurement system is comprised of the measurement server, robot controller, computer, near-field probe, probe alignment sensor, specific anthropomorphic mannequin (SAM) phantom, and various planar phantoms for head and/or body SAR evaluations. The robot is a six-axis industrial robot performing precise movements to position the probe to the location (points) of maximum electromagnetic field (EMF). A cell controller system contains the power supply, robot controller, teach pendant (joystick), and remote control is used to drive the robot motors. The Staubli robot is connected to the cell controller to allow software manipulation of the robot. A data acquisition electronic (DAE) circuit performs the signal amplification, signal multiplexing, AD-conversion, offset measurements, mechanical surface detection, collision detection, etc. is connected to the Electro-optical coupler (EOC). The EOC performs the conversion from the optical into digital electric signal of the DAE and transfers data to the DASY4 measurement server. The DAE4 utilizes a highly sensitive electrometer-grade preamplifier with auto-zeroing, a channel and gain-switching multiplexer, a fast 16-bit AD-converter and a command decoder and control logic unit. Transmission to the DASY4 measurement server is accomplished through an optical downlink for data and status information and an optical uplink for commands and clock lines. The mechanical probe-mounting device includes two different sensor systems for frontal and sidewise probe contacts. The sensor systems are also used for mechanical surface detection and probe collision detection. The robot uses a controller with a built in VME-bus computer.

3.0 RF CONDUCTED OUTPUT POWER MEASUREMENTS

MEASURED RF CONDUCTED OUTPUT POWER LEVELS



Radio Model	Test Frequency	Mode	dBm	Watts	Method
TK-3402-P	406.1 MHz	CW	37.0	5.0	Average Conducted
	418.0 MHz	CW	37.0	5.0	Average Conducted
	420.7 MHz	CW	37.0	5.0	Average Conducted
	430.0 MHz	CW	37.0	5.0	Average Conducted
	435.4 MHz	CW	37.0	5.0	Average Conducted
	440.0 MHz	CW	37.0	5.0	Average Conducted
	450.0 MHz	CW	37.0	5.0	Average Conducted
	455.0 MHz	CW	37.0	5.0	Average Conducted
	460.0 MHz	CW	37.0	5.0	Average Conducted
	470.0 MHz	CW	37.0	5.0	Average Conducted

Notes

1. The test channels were selected in accordance with the procedures specified in FCC KDB 447498 Section 6) c) (see reference [8]).

2. The RF conducted output power levels of the DUT were measured by Celltech prior to the SAR evaluations using a Gigatronics 8652A Universal Power Meter at the external antenna connector of the radio in accordance with FCC 47 CFR §2.1046 (see reference [15]) and IC RSS-Gen (see reference [16]).

Applicant:	Kenwood USA Corporation	FCC ID:	ALH435001	IC ID:	282D-435001	KENWOOD
DUT Type:	Portable UHF PTT Radio Transceiver	Models:	TK-3402-K2-P	406.1 - 470.0 MHz		
2012 Celltech Labs Inc.	This document is not to be reproduced in whole or in part without the prior written permission of Celltech Labs Inc.					Page 4 of 131

	Date(s) of Evaluation Aug 20-30, Oct 4-10, 2012	Test Report Serial No. 081612ALH-T1191-S90V	Test Report Revision No. Rev. 1.0 (1st Release)	
	Test Report Issue Date Oct. 22, 2012	Description of Test(s) Specific Absorption Rate	RF Exposure Category Occupational (Controlled)	

4.0 FCC POWER THRESHOLDS FOR PTT DEVICES ($f \leq 0.5$ GHz)

FCC SAR Evaluation Power Thresholds for PTT Devices, $f \leq 0.5$ GHz*			Manufacturer's Rated RF Output Power	
Exposure Conditions	P mW (General Population)	P mW (Occupational)	100% PTT Duty Cycle	50% PTT Duty Cycle
Held to face, $d \geq 2.5$ cm	250	1250	5 Watts	2.5 Watts
Body-worn, $d \geq 1.5$ cm	200	1000		
Body-worn, $d \geq 1.0$ cm	150	750		
1. The time-averaged output power, corresponding to the required PTT duty factor, is compared with these thresholds. 2. The closest distance between the user and the device or its antenna is used to determine the power thresholds. * Per FCC KDB 447498 D01v04 Section 5)b)i) (see reference [8]).			1. The conducted output power level of the DUT exceeds the FCC threshold for SAR evaluation requirement.	

5.0 SAR PROBE CALIBRATION & MEASUREMENT FREQUENCIES

The following procedures are recommended for measurements at 150 MHz - 3 GHz to minimize probe calibration and tissue dielectric parameter discrepancies. In general, SAR measurements below 300 MHz should be within ± 50 MHz of the probe calibration frequency. At 300 MHz to 3 GHz, measurements should be within ± 100 MHz of the probe calibration frequency. Measurements exceeding 50% of these intervals, ± 25 MHz < 300 MHz and ± 50 MHz ≥ 300 MHz, require additional steps (per FCC KDB 450824 D01v01r01, SAR Probe Calibration and System Verification Considerations for Measurements at 150 MHz - 3 GHz - see reference [10]).

Probe Calibration Freq.	Device Measurement Freq.	Frequency Interval	± 50 MHz (≥ 300 MHz)
450 MHz	418.0 MHz	32.0 MHz	< 50 MHz ¹
	435.4 MHz	14.6 MHz	< 50 MHz ¹
	440.0 MHz	10.0 MHz	< 50 MHz ¹
	450.0 MHz	0 MHz	< 50 MHz ¹
	455.0 MHz	5.0 MHz	< 50 MHz ¹
	460.0 MHz	10.0 MHz	< 50 MHz ¹
	470.0 MHz	20.0 MHz	< 50 MHz ¹

1. The probe calibration and measurement frequency interval is < 50 MHz; therefore the additional steps were not required.

6.0 NO. OF TEST CHANNELS (N_c)

Antenna Part No.	Antenna Freq. Range	Test Freq. Range	N_c	Test Frequencies
1	KRA-17M	450 - 485 MHz	3	450.0, 460.0, 470.0 MHz
2	KRA-17M3	410 - 430 MHz	3	406.1, 418.0, 430.0 MHz
3	KRA-23M	440 - 490 MHz	3	440.0, 455.0, 470.0 MHz
4	KRA-23M3	400 - 450 MHz	4	406.1, 420.7, 435.4, 450.0 MHz
5	KRA-27M	440 - 490 MHz	3	440.0, 455.0, 470.0 MHz
6	KRA-27M3	400 - 450 MHz	4	406.1, 420.7, 435.4, 450.0 MHz
7	KRA-42M	440 - 490 MHz	3	440.0, 455.0, 470.0 MHz
8	KRA-42M3	400 - 450 MHz	4	406.1, 420.7, 435.4, 450.0 MHz

Note: The number of test channels (N_c) were calculated in accordance with the procedures specified in FCC KDB 447498 Section 6) c) (see reference [8]).

Applicant:	Kenwood USA Corporation	FCC ID:	ALH435001	IC ID:	282D-435001	KENWOOD
DUT Type:	Portable UHF PTT Radio Transceiver	Models:	TK-3402-K2-P	406.1 - 470.0 MHz		
2012 Celltech Labs Inc.		This document is not to be reproduced in whole or in part without the prior written permission of Celltech Labs Inc.				Page 5 of 131

7.0 MANUFACTURER'S DISCLOSED ACCESSORY LISTING

Accessory ID # for Test Report	ACCESSORY CATEGORY: ANTENNA			
	Part Number	Description	SAR Evaluation	
1	KRA-17M	Detachable Stub (450-470 MHz)	Yes	
2	KRA-17M3	Detachable Stub (406.1-430 MHz)	Yes	
3	KRA-23M	Detachable Helical LP (440-470 MHz)	Yes	
4	KRA-23M3	Detachable Helical LP (406.1-450 MHz)	Yes	
5	KRA-27M	Detachable Whip (440-470 MHz)	Yes	
6	KRA-27M3	Detachable Whip (406.1-450 MHz)	Yes	
7	KRA-42M	Detachable Stub (440-470 MHz)	Yes	
8	KRA-42M3	Detachable Stub (406.1-450 MHz)	Yes	
Accessory ID # for Test Report	ACCESSORY CATEGORY: BATTERY			
	Part Number	Description	SAR Evaluation	
a	KNB-45L	Li-ion (7.4V, 2000mAh)	Yes	
b	KNB-29N	Ni-MH (7.2V, 1500mAh)	Yes	
c	KNB-53N	Ni-MH (7.2V, 1400mAh)	No ¹	
Accessory ID # for Test Report	ACCESSORY CATEGORY: BODY-WORN			
	Part Number	Description	SAR Evaluation	
1	KBH-10	Belt-clip (contains metal)	Yes	
Accessory ID # for Test Report	ACCESSORY CATEGORY: AUDIO			
	Part Number	Description	Audio Accessory Grouping	SAR Evaluation
G1a	KMC-21	Compact Speaker-Mic	Group 1 (Speaker-mic)	Yes
G1b	KMC-45	Heavy Duty Speaker-Mic		No ²
G1c	KMC-48GPS	GPS Speaker-Mic		No ²
G2b	KHS-7	Single Muff Headset	Group 2 (Lightweight Headset)	No ²
G2c	KHS-7A	Single Muff Headset w/ PTT		No ²
G2d	KHS-21	Lightweight Headset		Yes
G2e	KHS-22	Behind-the-Head Headset w/ PTT		No ²
G3a	KHS-10-BH	Heavy-duty Headset - Behind the head	Group 3 (Heavy-duty Headset)	Yes
G3b	KHS-10-OH	Heavy-duty Headset - Over the head		No ²
G4a	KHS-23	2-Wire Ear-Bud w/ mic/PTT	Group 4 (Earpiece)	No ²
G4b	KHS-25	D-Ring Ear Headset		Yes
G4c	KHS-26	Earbud In-line Headset		No ²
G4d	KHS-27	D-Ring In-line PTT Headset		No ²
G5a	KHS-8BE/BL	2-Wire Palm Mic w/ Earphone	Group 5 (Palm-Mic)	No ²
G5b	KHS-9BE/BL	3-Wire Lapel Microphone w/ Earpiece		Yes

Manufacturer's disclosed accessory listing information provided by Kenwood USA Corporation

Notes:

- KNB-53N battery pack is identical in construction to KNB-29N.
- Audio accessories not evaluated for SAR in accordance with the procedures and provisions of FCC KDB 643646 D01v01r01 Page 10 Section 1).

8.0 FLUID DIELECTRIC PARAMETERS

FLUID DIELECTRIC PARAMETERS						
Date: 08/20/2012		Frequency: 450 MHz			Tissue: Body	
Freq	Test_e	Test_s	Target_e	Target_s	Deviation Permittivity	Deviation Conductivity
0.350	58.47	0.87	56.7	0.94	3.12%	-7.45%
0.360	57.31	0.87	56.7	0.94	1.08%	-7.45%
0.370	57.54	0.89	56.7	0.94	1.48%	-5.32%
0.380	57.41	0.86	56.7	0.94	1.25%	-8.51%
0.390	57.23	0.88	56.7	0.94	0.93%	-6.38%
0.400	57.14	0.88	56.7	0.94	0.78%	-6.38%
0.410	56.27	0.91	56.7	0.94	-0.76%	-3.19%
0.420	56.78	0.91	56.7	0.94	0.14%	-3.19%
0.430	56.46	0.92	56.7	0.94	-0.42%	-2.13%
0.440	56.39	0.93	56.7	0.94	-0.55%	-1.06%
0.450	56.1	0.93	56.7	0.94	-1.06%	-1.06%
0.455*	56.2	0.935	56.7	0.94	-0.88%	-0.53%
0.460	56.36	0.94	56.7	0.94	-0.60%	0.00%
0.470	55.83	0.95	56.7	0.94	-1.53%	1.06%
0.480	56.89	0.96	56.7	0.94	0.34%	2.13%
0.490	55.64	0.97	56.7	0.94	-1.87%	3.19%
0.500	55.19	0.98	56.7	0.94	-2.66%	4.26%
0.510	55.61	0.97	56.7	0.94	-1.92%	3.19%
0.520	55.77	0.99	56.7	0.94	-1.64%	5.32%
0.530	55.72	1.01	56.7	0.94	-1.73%	7.45%
0.540	55.03	1.02	56.7	0.94	-2.95%	8.51%
0.550	55.35	1.03	56.7	0.94	-2.38%	9.57%

*interpolated using DASY4 software

Test Date	Fluid Type	Ambient Temperature	Fluid Temperature	Fluid Depth	Atmospheric Pressure	Relative Humidity	ρ (Kg/m ³)
Aug 20	450 Body	24.0°C	22.8°C	≥ 15 cm	101.1 kPa	31%	1000

FLUID DIELECTRIC PARAMETERS						
Date: 08/21/2012		Frequency: 450 MHz			Tissue: Body	
Freq	Test_e	Test_s	Target_e	Target_s	Deviation Permittivity	Deviation Conductivity
0.350	57.7	0.84	56.7	0.94	1.76%	-10.64%
0.360	56.84	0.84	56.7	0.94	0.25%	-10.64%
0.370	57.29	0.86	56.7	0.94	1.04%	-8.51%
0.380	57.1	0.87	56.7	0.94	0.71%	-7.45%
0.390	56.98	0.89	56.7	0.94	0.49%	-5.32%
0.400	56.68	0.88	56.7	0.94	-0.04%	-6.38%
0.410	56.52	0.9	56.7	0.94	-0.32%	-4.26%
0.420	57.24	0.91	56.7	0.94	0.95%	-3.19%
0.430	56.48	0.92	56.7	0.94	-0.39%	-2.13%
0.4354*	56.6	0.92	56.7	0.94	-0.18%	-2.13%
0.440	56.63	0.92	56.7	0.94	-0.12%	-2.13%
0.450	56.53	0.93	56.7	0.94	-0.30%	-1.06%
0.460	56.03	0.94	56.7	0.94	-1.18%	0.00%
0.470	55.9	0.93	56.7	0.94	-1.41%	-1.06%
0.480	55.82	0.94	56.7	0.94	-1.55%	0.00%
0.490	55.37	0.96	56.7	0.94	-2.35%	2.13%
0.500	55.46	0.96	56.7	0.94	-2.19%	2.13%
0.510	55.57	0.97	56.7	0.94	-1.99%	3.19%
0.520	55.33	0.99	56.7	0.94	-2.42%	5.32%
0.530	54.61	1	56.7	0.94	-3.69%	6.38%
0.540	55.3	1	56.7	0.94	-2.47%	6.38%
0.550	55.28	1.02	56.7	0.94	-2.50%	8.51%

*interpolated using DASY4 software

Test Date	Fluid Type	Ambient Temperature	Fluid Temperature	Fluid Depth	Atmospheric Pressure	Relative Humidity	ρ (Kg/m ³)
Aug 21	450 Body	24.0°C	22.5°C	≥ 15 cm	101.1 kPa	31%	1000

FLUID DIELECTRIC PARAMETERS						
Date: 08/22/2012		Frequency: 450 MHz			Tissue: Head	
Freq	Test_e	Test_s	Target_e	Target_s	Deviation Permittivity	Deviation Conductivity
0.350	45.34	0.76	43.5	0.87	4.23%	-12.64%
0.360	45.64	0.77	43.5	0.87	4.92%	-11.49%
0.370	45.43	0.76	43.5	0.87	4.44%	-12.64%
0.380	45.6	0.78	43.5	0.87	4.83%	-10.34%
0.390	44.47	0.8	43.5	0.87	2.23%	-8.05%
0.400	44.59	0.8	43.5	0.87	2.51%	-8.05%
0.410	44.44	0.8	43.5	0.87	2.16%	-8.05%
0.420	44.35	0.81	43.5	0.87	1.95%	-6.90%
0.430	44.34	0.81	43.5	0.87	1.93%	-6.90%
0.4354*	44.4	0.826	43.5	0.87	2.07%	-5.06%
0.440	44.36	0.84	43.5	0.87	1.98%	-3.45%
0.450	43.62	0.83	43.5	0.87	0.28%	-4.60%
0.455*	43.6	0.84	43.5	0.87	0.23%	-3.45%
0.460	43.61	0.85	43.5	0.87	0.25%	-2.30%
0.470	43.21	0.85	43.5	0.87	-0.67%	-2.30%
0.480	42.74	0.86	43.5	0.87	-1.75%	-1.15%
0.490	42.99	0.86	43.5	0.87	-1.17%	-1.15%
0.500	42.55	0.89	43.5	0.87	-2.18%	2.30%
0.510	42.41	0.88	43.5	0.87	-2.51%	1.15%
0.520	42.34	0.89	43.5	0.87	-2.67%	2.30%
0.530	42.16	0.91	43.5	0.87	-3.08%	4.60%
0.540	42.1	0.91	43.5	0.87	-3.22%	4.60%
0.550	42.15	0.92	43.5	0.87	-3.10%	5.75%

*interpolated using DASY4 software

Test Date	Fluid Type	Ambient Temperature	Fluid Temperature	Fluid Depth	Atmospheric Pressure	Relative Humidity	ρ (Kg/m ³)
Aug 22	450 Head	24.0°C	23.3°C	≥ 15 cm	101.1 kPa	32%	1000

FLUID DIELECTRIC PARAMETERS						
Date: 08/28/2012		Frequency: 450 MHz			Tissue: Head	
Freq	Test_e	Test_s	Target_e	Target_s	Deviation Permittivity	Deviation Conductivity
0.350	47.03	0.78	43.5	0.87	8.11%	-10.34%
0.360	45.87	0.79	43.5	0.87	5.45%	-9.20%
0.370	46.15	0.78	43.5	0.87	6.09%	-10.34%
0.380	45.83	0.79	43.5	0.87	5.36%	-9.20%
0.390	46.03	0.79	43.5	0.87	5.82%	-9.20%
0.400	45.13	0.81	43.5	0.87	3.75%	-6.90%
0.410	45.15	0.83	43.5	0.87	3.79%	-4.60%
0.418*	45.1	0.83	43.5	0.87	3.68%	-4.60%
0.420	45.11	0.83	43.5	0.87	3.70%	-4.60%
0.430	45.09	0.84	43.5	0.87	3.66%	-3.45%
0.440	44.75	0.85	43.5	0.87	2.87%	-2.30%
0.450	44.88	0.87	43.5	0.87	3.17%	0.00%
0.460	43.9	0.86	43.5	0.87	0.92%	-1.15%
0.470	43.83	0.88	43.5	0.87	0.76%	1.15%
0.480	44.45	0.88	43.5	0.87	2.18%	1.15%
0.490	43.19	0.9	43.5	0.87	-0.71%	3.45%
0.500	43.56	0.9	43.5	0.87	0.14%	3.45%
0.510	43.31	0.91	43.5	0.87	-0.44%	4.60%
0.520	43.15	0.93	43.5	0.87	-0.80%	6.90%
0.530	42.83	0.93	43.5	0.87	-1.54%	6.90%
0.540	42.87	0.95	43.5	0.87	-1.45%	9.20%
0.550	42.32	0.95	43.5	0.87	-2.71%	9.20%

*interpolated using DASY4 software

Test Date	Fluid Type	Ambient Temperature	Fluid Temperature	Fluid Depth	Atmospheric Pressure	Relative Humidity	ρ (Kg/m ³)
Aug 28	450 Head	23.0°C	23.3°C	≥ 15 cm	101.1 kPa	35%	1000

FLUID DIELECTRIC PARAMETERS						
Date: 08/28&29/2012		Frequency: 450 MHz			Tissue: Body	
Freq	Test_e	Test_s	Target_e	Target_s	Deviation Permittivity	Deviation Conductivity
0.350	57.73	0.84	56.7	0.94	1.82%	-10.64%
0.360	57.39	0.83	56.7	0.94	1.22%	-11.70%
0.370	56.75	0.84	56.7	0.94	0.09%	-10.64%
0.380	56.98	0.86	56.7	0.94	0.49%	-8.51%
0.390	56.79	0.85	56.7	0.94	0.16%	-9.57%
0.400	56.44	0.87	56.7	0.94	-0.46%	-7.45%
0.410	56.32	0.88	56.7	0.94	-0.67%	-6.38%
0.418*	56.3	0.896	56.7	0.94	-0.71%	-4.68%
0.420	56.32	0.9	56.7	0.94	-0.67%	-4.26%
0.430	56.28	0.91	56.7	0.94	-0.74%	-3.19%
0.440	56.05	0.91	56.7	0.94	-1.15%	-3.19%
0.450	55.87	0.93	56.7	0.94	-1.46%	-1.06%
0.460	54.74	0.93	56.7	0.94	-3.46%	-1.06%
0.470	55.43	0.93	56.7	0.94	-2.24%	-1.06%
0.480	55.1	0.94	56.7	0.94	-2.82%	0.00%
0.490	54.08	0.94	56.7	0.94	-4.62%	0.00%
0.500	54.56	0.95	56.7	0.94	-3.77%	1.06%
0.510	54.54	0.96	56.7	0.94	-3.81%	2.13%
0.520	54.87	0.98	56.7	0.94	-3.23%	4.26%
0.530	54.88	0.99	56.7	0.94	-3.21%	5.32%
0.540	53.94	1	56.7	0.94	-4.87%	6.38%
0.550	54.32	1	56.7	0.94	-4.20%	6.38%

*interpolated using DASY4 software

Test Date	Fluid Type	Ambient Temperature	Fluid Temperature	Fluid Depth	Atmospheric Pressure	Relative Humidity	ρ (Kg/m ³)
Aug 28	450 Body	23.0°C	23.2°C	≥ 15 cm	101.1 kPa	35%	1000
Aug 29	450 Body	23.0°C	23.6°C	≥ 15 cm	101.1 kPa	30%	1000

FLUID DIELECTRIC PARAMETERS						
Date: 08/30/2012		Frequency: 450 MHz			Tissue: Body	
Freq	Test_e	Test_s	Target_e	Target_s	Deviation Permittivity	Deviation Conductivity
0.350	57.97	0.85	56.7	0.94	2.24%	-9.57%
0.360	57.87	0.87	56.7	0.94	2.06%	-7.45%
0.370	57.11	0.9	56.7	0.94	0.72%	-4.26%
0.380	57.4	0.89	56.7	0.94	1.23%	-5.32%
0.390	57.18	0.89	56.7	0.94	0.85%	-5.32%
0.400	56.21	0.9	56.7	0.94	-0.86%	-4.26%
0.410	57.07	0.9	56.7	0.94	0.65%	-4.26%
0.420	56.58	0.91	56.7	0.94	-0.21%	-3.19%
0.430	56.9	0.91	56.7	0.94	0.35%	-3.19%
0.440	56.17	0.92	56.7	0.94	-0.93%	-2.13%
0.450	55.81	0.93	56.7	0.94	-1.57%	-1.06%
0.455*	56.1	0.94	56.7	0.94	-1.06%	0.00%
0.460	56.48	0.95	56.7	0.94	-0.39%	1.06%
0.470	56.48	0.95	56.7	0.94	-0.39%	1.06%
0.480	55.94	0.97	56.7	0.94	-1.34%	3.19%
0.490	55.46	0.97	56.7	0.94	-2.19%	3.19%
0.500	55.65	0.97	56.7	0.94	-1.85%	3.19%
0.510	55.09	0.98	56.7	0.94	-2.84%	4.26%
0.520	55.07	1	56.7	0.94	-2.87%	6.38%
0.530	55.09	1	56.7	0.94	-2.84%	6.38%
0.540	55.29	1.03	56.7	0.94	-2.49%	9.57%
0.550	55.07	1.02	56.7	0.94	-2.87%	8.51%

*interpolated using DASY4 software

Test Date	Fluid Type	Ambient Temperature	Fluid Temperature	Fluid Depth	Atmospheric Pressure	Relative Humidity	ρ (Kg/m ³)
Aug 30	450 Body	23.0°C	23.8°C	≥ 15 cm	101.1 kPa	30%	1000

FLUID DIELECTRIC PARAMETERS						
Date: 10/04&05/2012		Frequency: 450 MHz			Tissue: Head	
Freq	Test_e	Test_s	Target_e	Target_s	Deviation Permittivity	Deviation Conductivity
0.350	47.06	0.75	43.5	0.87	8.18%	-13.79%
0.360	47.31	0.76	43.5	0.87	8.76%	-12.64%
0.370	46.29	0.77	43.5	0.87	6.41%	-11.49%
0.380	46.45	0.79	43.5	0.87	6.78%	-9.20%
0.390	46.28	0.79	43.5	0.87	6.39%	-9.20%
0.400	45.49	0.81	43.5	0.87	4.57%	-6.90%
0.410	45.41	0.83	43.5	0.87	4.39%	-4.60%
0.420	45.74	0.85	43.5	0.87	5.15%	-2.30%
0.430	45.57	0.85	43.5	0.87	4.76%	-2.30%
0.4354*	45.4	0.85	43.5	0.87	4.37%	-2.30%
0.440	45.18	0.85	43.5	0.87	3.86%	-2.30%
0.450	45.47	0.86	43.5	0.87	4.53%	-1.15%
0.455*	45.1	0.865	43.5	0.87	3.68%	-0.57%
0.460	44.8	0.87	43.5	0.87	2.99%	0.00%
0.470	44.79	0.86	43.5	0.87	2.97%	-1.15%
0.484	44.5	0.89	43.5	0.87	2.30%	2.30%
0.490	44.56	0.89	43.5	0.87	2.44%	2.30%
0.500	44.34	0.88	43.5	0.87	1.93%	1.15%
0.510	44.23	0.9	43.5	0.87	1.68%	3.45%
0.520	43.95	0.92	43.5	0.87	1.03%	5.75%
0.530	43.87	0.92	43.5	0.87	0.85%	5.75%
0.540	43.56	0.93	43.5	0.87	0.14%	6.90%
0.550	43.42	0.93	43.5	0.87	-0.18%	6.90%

*interpolated using DASY4 software

Test Date	Fluid Type	Ambient Temperature	Fluid Temperature	Fluid Depth	Atmospheric Pressure	Relative Humidity	ρ (Kg/m ³)
Oct 4	450 Head	23.0°C	21.4°C	≥ 15 cm	101.1 kPa	30%	1000
Oct 5	450 Head	23.0°C	21.4°C	≥ 15 cm	101.1 kPa	30%	1000

FLUID DIELECTRIC PARAMETERS						
Date: 10/09&10/2012		Frequency: 450 MHz			Tissue: Body	
Freq	Test_e	Test_s	Target_e	Target_s	Deviation Permittivity	Deviation Conductivity
0.350	58.64	0.81	57.7	0.93	1.63%	-12.90%
0.360	57.64	0.83	57.7	0.93	-0.10%	-10.75%
0.370	58.32	0.84	57.7	0.93	1.07%	-9.68%
0.380	57.4	0.83	57.7	0.93	-0.52%	-10.75%
0.390	57.28	0.84	57.7	0.93	-0.73%	-9.68%
0.400	56.72	0.84	57.7	0.93	-1.70%	-9.68%
0.410	56.58	0.87	57.7	0.93	-1.94%	-6.45%
0.420	57.12	0.87	57.7	0.93	-1.01%	-6.45%
0.430	56.47	0.89	57.7	0.93	-2.13%	-4.30%
0.4354*	56.3	0.89	57.7	0.94	-2.43%	-5.32%
0.440	56.23	0.89	57.7	0.93	-2.55%	-4.30%
0.450	56.91	0.91	57.7	0.93	-1.37%	-2.15%
0.455*	56.4	0.915	57.7	0.94	-2.25%	-2.66%
0.460	55.82	0.92	57.7	0.93	-3.26%	-1.08%
0.470	55.67	0.92	57.7	0.93	-3.52%	-1.08%
0.480	55.94	0.93	57.7	0.93	-3.05%	0.00%
0.490	55.61	0.93	57.7	0.93	-3.62%	0.00%
0.500	54.75	0.95	57.7	0.93	-5.11%	2.15%
0.510	55.24	0.94	57.7	0.93	-4.26%	1.08%
0.520	54.65	0.96	57.7	0.93	-5.29%	3.23%
0.530	54.78	0.97	57.7	0.93	-5.06%	4.30%
0.540	54.72	0.98	57.7	0.93	-5.16%	5.38%
0.550	54.96	0.99	57.7	0.93	-4.75%	6.45%

*interpolated using DASY4 software



Test Date	Fluid Type	Ambient Temperature	Fluid Temperature	Fluid Depth	Atmospheric Pressure	Relative Humidity	ρ (Kg/m ³)
Oct 9	450 Body	22.0°C	21.7°C	≥ 15 cm	101.1 kPa	30%	1000
Oct 10	450 Body	22.0°C	21.6°C	≥ 15 cm	101.1 kPa	30%	1000

9.0 SAR MEASUREMENT SUMMARY

Table 1

FACE-HELD SAR EVALUATION RESULTS

Test Date: Aug. 22, 28 & Oct 5., 2012				1	2	3	4	5	6	7	8								
C	R	Antenna Tested	Test Freq. (MHz)	Cond. Pwr (W)	SAR W/kg 1g				SAR W/kg 1g										
					Default Battery (a)				Battery (b)										
					100% ptt d/f	50% ptt d/f	Drift (dB)	50%+droop	100% ptt d/f	50% ptt d/f	Drift dB	50%+droop							
1	ANT. 1 KRA-17M	450.0	5.0	N/A				N/A											
2		460.0	5.0	F1	6.51	3.26	-0.507	3.66	F9	1.80	0.900	-0.458	1.00						
3		470.0	5.0	N/A				N/A											
4	ANT. 2 KRA-17M3	406.1	5.0	N/A				N/A											
5		418.0	5.0	F2	5.01	2.51	-0.721	2.96	N/A										
6		430.0	5.0	N/A				N/A											
7	ANT. 3 KRA-23M	440.0	5.0	N/A				N/A											
8		455.0	5.0	F3	5.97	2.99	-0.487	3.34	N/A										
9		470.0	5.0	N/A				N/A											
10	ANT. 4 KRA-23M3	406.1	5.0	N/A				N/A											
11		420.7	5.0	N/A				N/A											
12		435.4	5.0	F4	3.92	1.96	-0.861	2.39	N/A										
13	ANT. 5 KRA-27M	450.0	5.0	N/A				N/A											
14		440.0	5.0	N/A				N/A											
15		455.0	5.0	F5	6.46	3.23	-0.535	3.65	N/A										
16	ANT. 6 KRA-27M3	470.0	5.0	N/A				N/A											
17		406.1	5.0	N/A				N/A											
18		420.7	5.0	N/A				N/A											
19	ANT. 7 KRA-42M	435.4	5.0	F6	4.79	2.40	-0.460	2.66	N/A										
20		450.0	5.0	N/A				N/A											
21		440.0	5.0	N/A				N/A											
22	ANT. 8 KRA-42M3	455.0	5.0	F7	4.52	2.26	-0.356	2.45	N/A										
23		470.0	5.0	N/A				N/A											
24		406.1	5.0	N/A				N/A											
25		420.7	5.0	N/A				N/A											
26		435.4	5.0	F8	3.73	1.87	-0.569	2.13	N/A										
27		450.0	5.0	N/A				N/A											
SAR LIMITS				HEAD				SPATIAL PEAK				RF EXPOSURE CATEGORY							
FCC 47 CFR 2.1093				Health Canada Safety Code 6				8.0 W/kg				1g averaging				Occupational / Controlled			
Notes																			
Test Mode = CW (Unmodulated Continuous Wave)						Phantom = Barski Planar Phantom													
Front of DUT Distance to Planar Phantom (see Appendix D)				Antenna Distance to Planar Phantom (see Appendix D)															
2.5 cm				1	2	3	4	5	6	7	8								
				3.2 cm	3.2 cm	3.2 cm	3.2 cm	3.2 cm	3.2 cm	3.2 cm	3.2 cm								
C = Column; R = Row				F1-Fx (F = Face) denotes the corresponding Face SAR Plot # as shown in Appendix A															

	<u>Date(s) of Evaluation</u> Aug 20-30, Oct 4-10, 2012	<u>Test Report Serial No.</u> 081612ALH-T1191-S90V	<u>Test Report Revision No.</u> Rev. 1.0 (1st Release)	 Test Lab Certificate No. 2470.01
	<u>Test Report Issue Date</u> Oct. 22, 2012	<u>Description of Test(s)</u> Specific Absorption Rate	<u>RF Exposure Category</u> Occupational (Controlled)	

Test Procedures applied in accordance with FCC KDB 643646 D01v01 (see reference [9])
1. For face-held configuration, the highest capacity battery was selected as the default battery (battery "a").
2. The SAR evaluations commenced at the highest output power channel per antenna and frequency range.
3. When the head SAR of an antenna tested on the highest output power channel using the default battery is ≤ 3.5 W/kg (50% PTT duty factor), testing of all other required channels is not necessary.
4. When the SAR for all antennas tested using the default battery is ≤ 4.0 W/kg, test additional batteries using the antenna and channel configuration that resulted in the highest SAR.
5. When test reduction applies, the slots for such configurations are denoted with N/A (Not Applicable).

Applicant:	Kenwood USA Corporation	FCC ID:	ALH435001	IC ID:	282D-435001	KENWOOD
DUT Type:	Portable UHF PTT Radio Transceiver	Models:	TK-3402-K2-P	406.1 - 470.0 MHz		
2012 Celltech Labs Inc.	This document is not to be reproduced in whole or in part without the prior written permission of Celltech Labs Inc.					Page 16 of 131

Table 2

BODY-WORN SAR EVALUATION RESULTS

C	Test Date: Aug. 20, 21, 29, 30, Oct 9 & 10., 2012				1	2	3	4	5	6	7	8	
	R	Antenna Tested	Test Freq. (MHz)	Cond. Pwr (W)	SAR W/kg 1g				SAR W/kg 1g				
Default Battery (a)					Battery (b)								
Default Body-worn Acc. (1)					Default Body-worn Acc. (1)								
Default Audio Acc. (G2d)					Default Audio Acc. (G2d)								
100% ptt d/f					50% ptt d/f	Drift (dB)	50%+droop	100% ptt d/f	50% ptt d/f	Drift dB	50%+droop		
1	ANT. 1 KRA-17M	450.0	5.0	B1	8.01	4.01	-0.356	4.35	N/A				
2		460.0	5.0	B2	9.85	4.93	-0.424	5.43	N/A				
3		470.0	5.0	B3	10.1	5.05	-0.423	5.57	B15	9.35	4.68	-0.566	5.33
4	ANT. 2 KRA-17M3	406.1	5.0	N/A				N/A					
5		418.0	5.0	B4	6.28	3.14	-0.737	3.72	N/A				
6		430.0	5.0	N/A				N/A					
7	ANT. 3 KRA-23M	440.0	5.0	B5	7.99	4.00	-0.510	4.49	N/A				
8		455.0	5.0	B6	8.96	4.48	-0.570	5.11	B16	8.97	4.49	-0.891	5.51
9		470.0	5.0	B7	8.04	4.02	-0.617	4.63	N/A				
10	ANT. 4 KRA-23M3	406.1	5.0	N/A				N/A					
11		420.7	5.0	N/A				N/A					
12		435.4	5.0	B8	5.66	2.83	-0.484	3.16	N/A				
13	ANT. 5 KRA-27M	450.0	5.0	N/A				N/A					
14		440.0	5.0	B9	7.64	3.82	-0.457	4.24	N/A				
15		455.0	5.0	B10	8.80	4.40	-0.496	4.93	B17	8.93	4.47	-0.902	5.50
16	470.0	5.0	B11	8.31	4.16	-0.519	4.68	N/A					
17	ANT. 6 KRA-27M3	406.1	5.0	N/A				N/A					
18		420.7	5.0	N/A				N/A					
19		435.4	5.0	B12	6.65	3.33	-0.530	3.76	N/A				
20	ANT. 7 KRA-42M	450.0	5.0	N/A				N/A					
21		440.0	5.0	N/A				N/A					
22		455.0	5.0	B13	6.68	3.34	-0.352	3.62	N/A				
23	ANT. 8 KRA-42M3	470.0	5.0	N/A				N/A					
24		406.1	5.0	N/A				N/A					
25		420.7	5.0	N/A				N/A					
26	435.4	5.0	B14	4.79	2.40	-0.514	2.70	N/A					
27	450.0	5.0	N/A				N/A						

SAR LIMITS

FCC 47 CFR 2.1093

Health Canada Safety Code 6

BODY

8.0 W/kg

SPATIAL PEAK

1g averaging

RF EXPOSURE CATEGORY

Occupational / Controlled

Notes

Test Mode = CW (Unmodulated Continuous Wave)

Phantom = Barski Planar Phantom



DUT Spacing to Planar Phantom per Battery (see Appendix D)

Antenna Distance to Planar Phantom (see Appendix D)

Battery (a)	Battery (b)	1	2	3	4	5	6	7	8
1.2 cm	1.2 cm	3.1 cm	3.1 cm	3.1 cm	3.1 cm	3.1 cm	3.1 cm	3.1 cm	3.1 cm

C = Column; R = Row

B1-Bx (B = Body) denotes the corresponding Body SAR Plot # as shown in Appendix A

	<u>Date(s) of Evaluation</u> Aug 20-30, Oct 4-10, 2012	<u>Test Report Serial No.</u> 081612ALH-T1191-S90V	<u>Test Report Revision No.</u> Rev. 1.0 (1st Release)	 Test Lab Certificate No. 2470.01
	<u>Test Report Issue Date</u> Oct. 22, 2012	<u>Description of Test(s)</u> Specific Absorption Rate	<u>RF Exposure Category</u> Occupational (Controlled)	

Test Procedures applied in accordance with FCC KDB 643646 D01v01 (see reference [9])
1. For body-worn configuration, the thinnest standard battery was selected as the default battery (battery "a"). (Both batteries are the same thickness)
2. The SAR evaluations commenced at the highest output power channel per antenna and frequency range.
3. When the SAR of an antenna tested on the highest output power channel using the default battery is ≤ 3.5 W/kg (50% PTT duty factor), testing of all other required channels is not necessary.
3. When the body SAR of an antenna tested on the highest output power channel with the default battery, default body-worn accessory and default audio accessory is > 4.0 W/kg and ≤ 6.0 W/kg, body SAR should be measured for that antenna on the required immediately adjacent channels.
5. When the highest SAR of an antenna tested with the thinnest (default) battery is > 4.0 W/kg and ≤ 6.0 W/kg, test additional batteries with the default body-worn and audio accessory on the channel that resulted in the highest SAR for that antenna.
5. Audio accessory (G2d) was selected as the default audio accessory based on preliminary evaluations with the most conservative SAR.
6. When test reduction applies, the slots for such configurations are denoted with N/A (Not Applicable).

Applicant:	Kenwood USA Corporation	FCC ID:	ALH435001	IC ID:	282D-435001	KENWOOD
DUT Type:	Portable UHF PTT Radio Transceiver	Models:	TK-3402-K2-P	406.1 - 470.0 MHz		
2012 Celltech Labs Inc.	This document is not to be reproduced in whole or in part without the prior written permission of Celltech Labs Inc.					Page 18 of 131





	<u>Date(s) of Evaluation</u> Aug 20-30, Oct 4-10, 2012	<u>Test Report Serial No.</u> 081612ALH-T1191-S90V	<u>Test Report Revision No.</u> Rev. 1.0 (1st Release)	
	<u>Test Report Issue Date</u> Oct. 22, 2012	<u>Description of Test(s)</u> Specific Absorption Rate	<u>RF Exposure Category</u> Occupational (Controlled)	

TABLE 3		ADDITIONAL AUDIO ACC'S SAR EVALUATION RESULTS							
C	Test Date(s): Oct 9 & 10, 2012					1	2		
R	Antenna Tested	Audio Accessory Grouping	Audio Accessory ID	Test Frequency (MHz)	Conducted Power (W)	1g SAR (W/kg)			
						Battery (a)			
						Body-worn Acc. (1)			
						Plot #	100% ptt d/f SAR Drift dB	50% ptt d/f 50%+droop	
1	ANT. 1 KRA-17M	G1	G1a	470.0	5.0	A1	9.26	4.63	
2							-0.514	5.21	
3								8.53	4.27
4		G3	G3a	470.0	5.0	A2	-0.440	4.72	
5								8.87	4.44
6		G4	G4b	470.0	5.0	A3	-0.597	5.09	
7								9.14	4.57
8		G5	G5b	470.0	5.0	A4	-0.546	5.18	
SAR LIMITS				BODY	SPATIAL PEAK	RF EXPOSURE CATEGORY			
FCC 47 CFR 2.1093		Health Canada Safety Code 6		8.0 W/kg	1g average	Occupational / Controlled			
Notes									
Test Mode = CW (Unmodulated Continuous Wave)					DUT Distance to Phantom		Antenna Distance to Phantom		
Phantom = Barski Planar Phantom					1.2 cm		3.1 cm		
C = Column; R = Row									
Audio accessories do not contain any built-in radiating element									

Applicant:	Kenwood USA Corporation	FCC ID:	ALH435001	IC ID:	282D-435001	KENWOOD
DUT Type:	Portable UHF PTT Radio Transceiver	Models:	TK-3402-K2-P	406.1 - 470.0 MHz		
2012 Celltech Labs Inc.		This document is not to be reproduced in whole or in part without the prior written permission of Celltech Labs Inc.				Page 19 of 131

	<u>Date(s) of Evaluation</u> Aug 20-30, Oct 4-10, 2012	<u>Test Report Serial No.</u> 081612ALH-T1191-S90V	<u>Test Report Revision No.</u> Rev. 1.0 (1st Release)	 Test Lab Certificate No. 2470.01
	<u>Test Report Issue Date</u> Oct. 22, 2012	<u>Description of Test(s)</u> Specific Absorption Rate	<u>RF Exposure Category</u> Occupational (Controlled)	

10.0 SAR LEVEL ADJUSTMENT FOR FLUID SENSITIVITY

The measured fluid dielectric properties for 450 MHz body tissue simulant were outside the 5% measurement protocol tolerance as reported in the table below.

Measured Fluid Parameters:

Test Date	Freq (GHz)	Test e	Test s	Target e	Target s	Deviation Permittivity	Deviation Conductivity
Aug 22	0.4354*	44.4	0.826	43.5	0.87	2.07%	-5.06%
Oct 9	0.4354*	56.3	0.89	57.7	0.94	-2.43%	-5.32%

*interpolated using DASY4 software

1. Chapter 22 of the SAR system manufacturer's DASY4 Manual (see reference [13]) provides the following calculation formula for making fluid sensitivity adjustments to the measured SAR values:

$$\% \text{ Change in SAR} = \text{Sensitivity} * \% \text{ Change in Value}$$

$$\text{Aug 22} \quad \% \text{ Change in SAR} = (-0.46 * 2.07\%) + (0.43 * -5.06\%)$$

$$\% \text{ Change in SAR} = -3.13\%$$

$$\text{Oct 9} \quad \% \text{ Change in SAR} = (-0.46 * 3.06\%) + (0.43 * -5.56\%)$$

$$\% \text{ Change in SAR} = -3.80\%$$

Since the calculated changes in SAR are negative values, the measured SAR values are adjusted.

$$\text{Adjusted SAR} = \text{SAR} * \Delta \text{SAR}$$

Plot #	Measured SAR	Adjusted SAR
F4	1.96	2.02
F6	2.40	2.48
B14	2.40	2.49

2. IEC 62209-2:2010 (see reference [7]) provides a formula for making fluid sensitivity adjustments to the measured SAR values:

$$\Delta \text{SAR} = C_e * \Delta E + C_\sigma * \Delta \sigma$$

Calculations as per IEC 62209-2:



Date	Aug 22	Oct 9
Frequency (GHz)	0.4354	0.4354
C _e	-0.2128	-0.2128
C _σ	0.7803	0.7803
Δ E	2.07%	2.43%
Δ σ	-5.06%	-5.32%
Δ SAR	-4.39%	-4.67%

Since the calculated changes in SAR are negative values, the measured SAR values are adjusted.

$$\text{Adjusted SAR} = \text{SAR} * \Delta \text{SAR}$$

Plot #	Measured SAR	Adjusted SAR
F4	1.96	2.05
F6	2.40	2.51
B14	2.40	2.51



Applicant:	Kenwood USA Corporation	FCC ID:	ALH435001	IC ID:	282D-435001	KENWOOD
DUT Type:	Portable UHF PTT Radio Transceiver	Models:	TK-3402-K2-P	406.1 - 470.0 MHz		
2012 Celltech Labs Inc.	This document is not to be reproduced in whole or in part without the prior written permission of Celltech Labs Inc.					Page 20 of 131

	<u>Date(s) of Evaluation</u> Aug 20-30, Oct 4-10, 2012	<u>Test Report Serial No.</u> 081612ALH-T1191-S90V	<u>Test Report Revision No.</u> Rev. 1.0 (1st Release)	 Test Lab Certificate No. 2470.01
	<u>Test Report Issue Date</u> Oct. 22, 2012	<u>Description of Test(s)</u> Specific Absorption Rate	<u>RF Exposure Category</u> Occupational (Controlled)	

11.0 SAR TEST REDUCTION PROCEDURES APPLIED (FCC KDB 643646)

- a. Face-held Configuration - Default Battery Selection per FCC KDB 643646, Page 2, Section 1) A): *"When multiple standard batteries are supplied with a radio, the battery with the highest capacity is considered the default battery for making head SAR measurements."*
- b. Body-worn Configuration - Default Battery and Body-worn Accessory Selection per FCC KDB 643646, Page 5, Section 1) A): *"Start by testing a PTT radio with the thinnest battery and a standard (default) body-worn accessory that are both supplied with the radio and, if applicable, a default audio accessory....."*
- c. Body-worn Configuration - Default Audio Accessory Selection - According to the manufacturer, the radio is not supplied to the end user with a standard default audio accessory (as referenced in FCC KDB 643646, Page 4, Section "Body SAR Test Considerations for Body-worn Accessories"); therefore the procedures described in note (f) below were applied in order to establish the default audio accessory.
- d. Body-worn Configuration - Selection of Remaining Default Audio Accessories by Category - the Remaining Default Audio Accessories by Category were selected based on the guidance provided in FCC KDB 643646, Section "Body SAR Test Considerations for Audio Accessories without Built-in Antenna", Page 10: *"For audio accessories with similar construction and operating requirements, test only the audio accessory within the group that is expected to result in the highest SAR, with respect to changes in RF characteristics and exposure conditions for the combination. If it is unclear which audio accessory within a group of similar accessories is expected to result in the highest SAR, good engineering judgment and preliminary testing should be applied to select the accessory that is expected to result in the highest SAR."* Please refer to note (i) below for the procedure implemented to establish the Default Audio Accessory by Category (Grouping). The Remaining Default Audio Accessories by Category were evaluated on the highest SAR channel and antenna combination from the Default Audio Accessory
- e. Body-worn Configuration - Selection of Additional Audio Accessories by Category - the Additional Audio Accessories by Category were selected based on the guidance provided in FCC KDB 643646, Section "Body SAR Test Considerations for Audio Accessories without Built-in Antenna", Page 10.
- f. According to the manufacturer, all the optional audio accessories can be used with any accessory combination (antenna, battery & body-worn accessory). Therefore, in order to determine the default audio accessory (in accordance with FCC KDB 643646, Page 4, footnote 8), preliminary SAR evaluations (area scans with belt-clip and thinnest battery) were performed by Celltech with all of the optional audio accessories connected to the radio consecutively in order to select the audio accessory expected to result in the highest SAR level for the final compliance evaluations.

Applicant:	Kenwood USA Corporation	FCC ID:	ALH435001	IC ID:	282D-435001	KENWOOD
DUT Type:	Portable UHF PTT Radio Transceiver	Models:	TK-3402-K2-P	406.1 - 470.0 MHz		
2012 Celltech Labs Inc.		This document is not to be reproduced in whole or in part without the prior written permission of Celltech Labs Inc.				Page 21 of 131

	<u>Date(s) of Evaluation</u> Aug 20-30, Oct 4-10, 2012	<u>Test Report Serial No.</u> 081612ALH-T1191-S90V	<u>Test Report Revision No.</u> Rev. 1.0 (1st Release)	
	<u>Test Report Issue Date</u> Oct. 22, 2012	<u>Description of Test(s)</u> Specific Absorption Rate	<u>RF Exposure Category</u> Occupational (Controlled)	

12.0 DETAILS OF SAR EVALUATION

- The number of test frequencies and the test channels evaluated for SAR were selected in accordance with the procedures described in FCC KDB 447498 Section 6) c) (see reference [8]).
- The DUT was evaluated for SAR in accordance with the procedures described in FCC KDB 643646 D01v01 (see reference [9]).
- Each SAR evaluation was performed with a fully charged battery.
- The SAR droop of the DUT was measured by the DASY4 system for the duration of the SAR evaluations. The measured SAR droop was added to the measured SAR levels to report scaled SAR levels as shown in the SAR test data tables. A SAR-versus-Time power droop evaluation was performed (see Appendix A).
- The fluid temperature was measured prior to and after the SAR evaluations. The fluid temperature remained within +/-2°C during the SAR evaluations.
- The dielectric parameters of the simulated tissue mixtures were measured prior to the SAR evaluations using a Dielectric Probe Kit and a Network Analyzer (see Appendix C).
- The DUT was tested at the maximum conducted output power level preset by the manufacturer in unmodulated continuous transmit operation (Continuous Wave mode at 100% duty cycle) with the transmit key constantly depressed. For a push-to-talk device the 50% duty cycle compensation reported assumes a transmit/receive cycle of equal time base.

13.0 SAR EVALUATION PROCEDURES

- The evaluation was performed in the applicable area of the phantom depending on the type of device being tested. For devices held to the ear during normal operation, both the left and right ear positions were evaluated using the SAM phantom.
 - For body-worn and face-held devices a planar phantom was used.
- The SAR was determined by a pre-defined procedure within the DASY4 software. Upon completion of a reference and optical surface check, the exposed region of the phantom was scanned near the inner surface with a grid spacing of 15mm x 15mm.
An area scan was determined as follows:
- Based on the defined area scan grid, a more detailed grid is created to increase the points by a factor of 10. The interpolation function then evaluates all field values between corresponding measurement points.
- A linear search is applied to find all the candidate maxima. Subsequently, all maxima are removed that are >2 dB from the global maximum. The remaining maxima are then used to position the cube scans.
A 1g and 10g spatial peak SAR was determined as follows:
- Extrapolation is used to find the points between the dipole center of the probe and the surface of the phantom. This data cannot be measured, since the center of the dipoles is 2.7 mm away from the tip of the probe and the distance between the surface and the lowest measuring point is 1.4 mm (see probe calibration document in Appendix F). The extrapolation was based on trivariate quadratics computed from the previously calculated 3D interpolated points nearest the phantom surface.
- Interpolated data is used to calculate the average SAR over 1g and 10g cubes by spatially discretizing the entire measured cube. The volume used to determine the averaged SAR is a 1mm grid (42875 interpolated points).
- A zoom scan volume of 30 mm x 30 mm x 30 mm (5 x 5 x 7 points) centered at the peak SAR location determined from the area scan is used for all zoom scans for devices with a transmit frequency < 800 MHz. Zoom scans for frequencies ≥ 800 MHz are determined with a scan volume of 30 mm x 30 mm x 30 mm (7 x 7 x 7) to ensure complete capture of the peak spatial-average SAR.

Applicant:	Kenwood USA Corporation	FCC ID:	ALH435001	IC ID:	282D-435001	KENWOOD
DUT Type:	Portable UHF PTT Radio Transceiver	Models:	TK-3402-K2-P	406.1 - 470.0 MHz		
2012 Celltech Labs Inc.	This document is not to be reproduced in whole or in part without the prior written permission of Celltech Labs Inc.					Page 22 of 131

14.0 SYSTEM PERFORMANCE CHECK



Prior to the SAR evaluations, system checks were performed with a planar phantom and SPEAG 450 MHz dipole (see Appendix B) in accordance with the procedures described in IEEE Standard 1528-2003 (see reference [5]) and IEC Standard 62209-1:2005 (see reference [6]). The dielectric parameters of the simulated tissue mixture were measured prior to the system performance check using a Dielectric Probe Kit and a Network Analyzer (see Appendix C for measured fluid dielectric parameters). A forward power of 398 mW was applied to the dipole and the system was verified to a tolerance of $\pm 10\%$ from the SAR system manufacturer's dipole calibration target SAR value (see Appendix E for system manufacturer's dipole calibration procedures).

SYSTEM PERFORMANCE CHECK EVALUATIONS																
Test Date	Equiv. Tissue	SAR 1g (W/kg)			Dielectric Constant ϵ_r			Conductivity σ (mho/m)			ρ (Kg/m ³)	Amb. Temp. (°C)	Fluid Temp. (°C)	Fluid Depth (cm)	Humid. (%)	Barom. Press. (kPa)
		Freq. (MHz)	SPEAG Target	Meas.	Dev.	SPEAG Target	Meas.	Dev.	SPEAG Target	Meas.						
Aug 20	Body 450	1.81 $\pm 10\%$	1.92	+6.1%	56.7 $\pm 5\%$	56.1	-1.1%	0.94 $\pm 5\%$	0.93	-1.1%	1000	24.0	22.8	≥ 15	31	101.1
Aug 22	Head 450	1.87 $\pm 10\%$	1.83	-2.1%	43.5 $\pm 5\%$	43.6	+0.2%	0.87 $\pm 5\%$	0.83	+4.6%	1000	24.0	23.3	≥ 15	32	101.1
Aug 28	Head 450	1.87 $\pm 10\%$	1.90	+1.6%	43.5 $\pm 5\%$	44.9	+3.2%	0.87 $\pm 5\%$	0.87	0.0%	1000	23.0	23.3	≥ 15	35	101.1
Aug 28	Body 450	1.81 $\pm 10\%$	1.85	+2.2%	56.7 $\pm 5\%$	55.9	-1.4%	0.94 $\pm 5\%$	0.93	-1.1%	1000	23.0	23.2	≥ 15	35	101.1
Aug 30	Body 450	1.81 $\pm 10\%$	1.84	+1.7%	56.7 $\pm 5\%$	55.8	-1.6%	0.94 $\pm 5\%$	0.93	-1.1%	1000	23.0	23.8	≥ 15	30	101.1
Oct 4	Head 450	1.87 $\pm 10\%$	1.90	+1.6%	43.5 $\pm 5\%$	45.5	+4.6%	0.87 $\pm 5\%$	0.86	-1.1%	1000	23.0	21.4	≥ 15	30	101.1
Oct 9	Body 450	1.81 $\pm 10\%$	1.77	-2.2%	56.7 $\pm 5\%$	56.9	+0.4%	0.94 $\pm 5\%$	0.91	-3.2%	1000	22.0	21.7	≥ 15	30	101.1

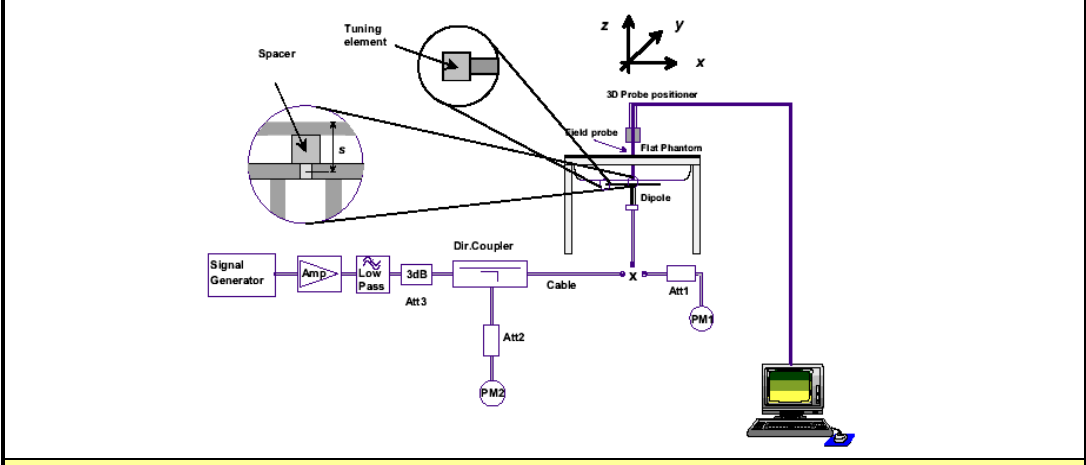
- | | | |
|--------------|----|---|
| Notes | 1. | The target SAR values are the measured values from the SAR system manufacturer's dipole calibration (see Appendix E). |
| | 2. | The target dielectric parameters are the nominal values from the SAR system manufacturer's dipole calibration (see Appendix E). |
| | 3. | The fluid temperature was measured prior to and after the system performance check evaluations. The fluid temperature remained within $\pm 2^\circ\text{C}$ during the system performance check evaluations. |
| | 4. | The dielectric parameters of the simulated tissue mixture were measured prior to the system performance check using a Dielectric Probe Kit and a Network Analyzer (see Appendix C). |
| | 5. | System Performance Checks were not performed for each SAR evaluation test date based on compliance with the following provision per TCBC Workshop Presentation April 5-7, 2011 (Kwok Chan Presentation File 04-06-2011-FCC 4 RF Exposure Guidance 040611- KC):
SAR System Verification
when head and body tissue dielectric parameters are required to test a device, separate SAR system verifications are required
- daily verification of each liquid is usually not necessary when liquid parameter tolerances are maintained in a controlled environment
- typically every few days is sufficient or when liquid is changed |



System Performance Check Measurement Setup (IEEE Standard 1528-2003) **SPEAG 450 MHz Validation Dipole Setup**

	<u>Date(s) of Evaluation</u> Aug 20-30, Oct 4-10, 2012	<u>Test Report Serial No.</u> 081612ALH-T1191-S90V	<u>Test Report Revision No.</u> Rev. 1.0 (1st Release)	
	<u>Test Report Issue Date</u> Oct. 22, 2012	<u>Description of Test(s)</u> Specific Absorption Rate	<u>RF Exposure Category</u> Occupational (Controlled)	

15.0 SIMULATED EQUIVALENT TISSUES



The simulated equivalent tissue recipes in the table below are derived from the SAR system manufacturer's suggested recipes in the DASY4 manual (see references [11] and [12]) in accordance with the procedures and requirements specified in IEEE Standard 1528-2003 (see reference [5]) and IEC Standard 62209-1:2005 (see reference [6]). The ingredient percentage may have been adjusted minimally in order to achieve the appropriate target dielectric parameters within the specified tolerance.

SIMULATED TISSUE MIXTURES		
INGREDIENT	450 MHz HEAD	450 MHz BODY
Water	38.56 %	52.00 %
Sugar	56.32 %	45.65 %
Salt	3.95 %	1.75 %
HEC	0.98 %	0.50 %
Bactericide	0.19 %	0.10 %

16.0 SAR LIMITS

SAR RF EXPOSURE LIMITS			
FCC 47 CFR 2.1093	Health Canada Safety Code 6	(General Population / Uncontrolled Exposure)	(Occupational / Controlled Exposure)
Spatial Average (averaged over the whole body)		0.08 W/kg	0.4 W/kg
Spatial Peak (averaged over any 1 g of tissue)		1.6 W/kg	8.0 W/kg
Spatial Peak (hands/wrists/feet/ankles averaged over 10 g)		4.0 W/kg	20.0 W/kg
The Spatial Average value of the SAR averaged over the whole body.			
The Spatial Peak value of the SAR averaged over any 1 gram of tissue (defined as a tissue volume in the shape of a cube) and over the appropriate averaging time.			
The Spatial Peak value of the SAR averaged over any 10 grams of tissue (defined as a tissue volume in the shape of a cube) and over the appropriate averaging time.			
Uncontrolled environments are defined as locations where there is potential exposure of individuals who have no knowledge or control of their potential exposure.			
Controlled environments are defined as locations where there is potential exposure of individuals who have knowledge of their potential exposure and can exercise control over their exposure.			



Applicant:	Kenwood USA Corporation	FCC ID:	ALH435001	IC ID:	282D-435001	KENWOOD
DUT Type:	Portable UHF PTT Radio Transceiver	Models:	TK-3402-K2-P	406.1 - 470.0 MHz		
2012 Celltech Labs Inc.		This document is not to be reproduced in whole or in part without the prior written permission of Celltech Labs Inc.				Page 24 of 131

	<u>Date(s) of Evaluation</u> Aug 20-30, Oct 4-10, 2012	<u>Test Report Serial No.</u> 081612ALH-T1191-S90V	<u>Test Report Revision No.</u> Rev. 1.0 (1st Release)	
	<u>Test Report Issue Date</u> Oct. 22, 2012	<u>Description of Test(s)</u> Specific Absorption Rate	<u>RF Exposure Category</u> Occupational (Controlled)	

17.0 ROBOT SYSTEM SPECIFICATIONS

<u>Specifications</u>	
Positioner	Stäubli Unimation Corp. Robot Model: RX60L
Repeatability	0.02 mm
No. of axis	6
<u>Data Acquisition Electronic (DAE) System</u>	
<u>Cell Controller</u>	
Processor	AMD Athlon XP 2400+
Clock Speed	2.0 GHz
Operating System	Windows XP Professional
<u>Data Converter</u>	
Features	Signal Amplifier, multiplexer, A/D converter, and control logic
Software	Measurement Software: DASY4, V4.7 Build 44
	Postprocessing Software: SEMCAD, V1.8 Build 171
Connecting Lines	Optical downlink for data and status info., Optical uplink for commands and clock
<u>DASY4 Measurement Server</u>	
Function	Real-time data evaluation for field measurements and surface detection
Hardware	PC/104 166MHz Pentium CPU; 32 MB chipdisk; 64 MB RAM
Connections	COM1, COM2, DAE, Robot, Ethernet, Service Interface
<u>E-Field Probe</u>	
Model	ET3DV6
Serial No.	1590
Construction	Triangular core fiber optic detection system
Frequency	10 MHz to 6 GHz
Linearity	±0.2 dB (30 MHz to 3 GHz)
<u>Phantom</u>	
Type	Barski Planar Phantom
Shell Material	Fiberglass
Thickness	2.0 ±0.1 mm
Volume	Approx. 70 liters

Applicant:	Kenwood USA Corporation	FCC ID:	ALH435001	IC ID:	282D-435001	KENWOOD
DUT Type:	Portable UHF PTT Radio Transceiver	Models:	TK-3402-K2-P	406.1 - 470.0 MHz		
2012 Celltech Labs Inc.		This document is not to be reproduced in whole or in part without the prior written permission of Celltech Labs Inc.				Page 25 of 131

	<u>Date(s) of Evaluation</u> Aug 20-30, Oct 4-10, 2012	<u>Test Report Serial No.</u> 081612ALH-T1191-S90V	<u>Test Report Revision No.</u> Rev. 1.0 (1st Release)	
	<u>Test Report Issue Date</u> Oct. 22, 2012	<u>Description of Test(s)</u> Specific Absorption Rate	<u>RF Exposure Category</u> Occupational (Controlled)	

18.0 PROBE SPECIFICATION (ET3DV6)

<p>Construction: Symmetrical design with triangular core; Built-in shielding against static charges PEEK enclosure material (resistant to organic solvents, glycol)</p> <p>Calibration: In air from 10 MHz to 2.5 GHz In head simulating tissue at frequencies of 900 MHz and 1.8 GHz (accuracy $\pm 8\%$)</p> <p>Frequency: 10 MHz to > 6 GHz; Linearity: ± 0.2 dB (30 MHz to 3 GHz)</p> <p>Directivity: ± 0.2 dB in head tissue (rotation around probe axis) ± 0.4 dB in head tissue (rotation normal to probe axis)</p> <p>Dynamic Range: $5 \mu\text{W/g}$ to $> 100 \text{ mW/g}$; Linearity: ± 0.2 dB</p> <p>Surface Detect: ± 0.2 mm repeatability in air and clear liquids over diffuse reflecting surfaces</p> <p>Dimensions: Overall length: 330 mm; Tip length: 16 mm; Body diameter: 12 mm; Tip diameter: 6.8 mm Distance from probe tip to dipole centers: 2.7 mm</p> <p>Application: General dosimetry up to 3 GHz; Compliance tests of mobile phone</p>	
ET3DV6 E-Field Probe	



19.0 BARSKI PLANAR PHANTOM

<p>The Barski Planar Phantom is a fiberglass shell phantom with a 2.0 mm (+/-0.2mm) thick device measurement area at the center of the phantom for SAR evaluations of devices with a larger surface area than the planar section of the SAM phantom. The planar phantom is integrated in a wooden table. The planar phantom was used for the DUT SAR evaluations and the system performance check evaluations. See Appendix G for dimensions and specifications of the Barski Planar Phantom.</p>	
Barski Planar Phantom	

20.0 DEVICE HOLDER

<p>The DASY4 device holder has two scales for device rotation (with respect to the body axis) and the device inclination (with respect to the line between the ear openings). The plane between the ear openings and the mouth tip has a rotation angle of 65°. The bottom plate contains three pair of bolts for locking the device holder. The device holder positions are adjusted to the standard measurement positions in the three sections. For evaluations of larger devices a Plexiglas platform is attached to the device holder.</p>	
Device Holder	



Applicant: Kenwood USA Corporation	FCC ID: ALH435001	IC ID: 282D-435001	KENWOOD
DUT Type: Portable UHF PTT Radio Transceiver	Models: TK-3402-K2-P	406.1 - 470.0 MHz	
2012 Celltech Labs Inc.	This document is not to be reproduced in whole or in part without the prior written permission of Celltech Labs Inc.		Page 26 of 131

	<u>Date(s) of Evaluation</u> Aug 20-30, Oct 4-10, 2012	<u>Test Report Serial No.</u> 081612ALH-T1191-S90V	<u>Test Report Revision No.</u> Rev. 1.0 (1st Release)	
	<u>Test Report Issue Date</u> Oct. 22, 2012	<u>Description of Test(s)</u> Specific Absorption Rate	<u>RF Exposure Category</u> Occupational (Controlled)	

21.0 TEST EQUIPMENT LIST

TEST EQUIPMENT		ASSET NO.	SERIAL NO.	DATE CALIBRATED	CALIBRATION INTERVAL
USED	DESCRIPTION				
x	Schmid & Partner DASY4 System	-	-	-	-
x	-DASY4 Measurement Server	00158	1078	CNR	CNR
x	-Robot	00046	599396-01	CNR	CNR
x	-DAE4	00019	353	19-Apr-12	Biennial
x	-ET3DV6 E-Field Probe	00017	1590	24-Apr-12	Annual
x	-D450V3 Validation Dipole	00221	1068	27-Apr-12	Triennial
x	-Barski Planar Phantom	00155	03-01	CNR	CNR
x	HP 85070C Dielectric Probe Kit	00033	none	CNR	CNR
x	Gigatronics 8652A Power Meter	00007	1835272	03-May-12	Biennial
x	Gigatronics 80701A Power Sensor	00014	1833542	03-May-12	Biennial
x	Gigatronics 80334A Power Sensor	-	1837001	03-May-12	Biennial
x	HP 8753ET Network Analyzer	00134	US39170292	26-Apr-12	Biennial
x	Rohde & Schwarz SMR20 Signal Generator	00006	100104	02-May-12	Biennial
x	Amplifier Research 5S1G4 Power Amplifier	00106	26235	CNR	CNR
Abbr.	CNR = Calibration Not Required				

Applicant:	Kenwood USA Corporation	FCC ID:	ALH435001	IC ID:	282D-435001	KENWOOD
DUT Type:	Portable UHF PTT Radio Transceiver	Models:	TK-3402-K2-P	406.1 - 470.0 MHz		
2012 Celltech Labs Inc.		This document is not to be reproduced in whole or in part without the prior written permission of Celltech Labs Inc.				Page 27 of 131

	<u>Date(s) of Evaluation</u> Aug 20-30, Oct 4-10, 2012	<u>Test Report Serial No.</u> 081612ALH-T1191-S90V	<u>Test Report Revision No.</u> Rev. 1.0 (1st Release)	 
	<u>Test Report Issue Date</u> Oct. 22, 2012	<u>Description of Test(s)</u> Specific Absorption Rate	<u>RF Exposure Category</u> Occupational (Controlled)	



22.0 MEASUREMENT UNCERTAINTIES

UNCERTAINTY BUDGET FOR DEVICE EVALUATION (FCC - IEEE 1528-2003)									
Uncertainty Component	IEEE 1528 Section	Uncertainty Value ±%	Probability Distribution	Divisor	ci 1g	ci 10g	Uncertainty Value ±% (1g)	Uncertainty Value ±% (10g)	V _i or V _{eff}
Measurement System									
Probe Calibration (450 MHz)	E.2.1	6.70	Normal	1	1	1	6.70	6.70	∞
Axial Isotropy	E.2.2	4.7	Rectangular	1.732050808	0.7	0.7	1.9	1.9	∞
Hemispherical Isotropy	E.2.2	9.6	Rectangular	1.732050808	0.7	0.7	3.9	3.9	∞
Boundary Effect	E.2.3	1	Rectangular	1.732050808	1	1	0.6	0.6	∞
Linearity	E.2.4	4.7	Rectangular	1.732050808	1	1	2.7	2.7	∞
System Detection Limits	E.2.5	1	Rectangular	1.732050808	1	1	0.6	0.6	∞
Readout Electronics	E.2.6	0.3	Normal	1	1	1	0.3	0.3	∞
Response Time	E.2.7	0.8	Rectangular	1.732050808	1	1	0.5	0.5	∞
Integration Time	E.2.8	2.6	Rectangular	1.732050808	1	1	1.5	1.5	∞
RF Ambient Conditions	E.6.1	3	Rectangular	1.732050808	1	1	1.7	1.7	∞
Probe Positioner Mechanical Tolerance	E.6.2	0.4	Rectangular	1.732050808	1	1	0.2	0.2	∞
Probe Positioning wrt Phantom Shell	E.6.3	2.9	Rectangular	1.732050808	1	1	1.7	1.7	∞
Extrapolation, interpolation & integration algorithms for max. SAR evaluation	E.5	1	Rectangular	1.732050808	1	1	0.6	0.6	∞
Test Sample Related									
Test Sample Positioning	E.4.2	2.9	Normal	1	1	1	2.9	2.9	12
Device Holder Uncertainty	E.4.1	3.6	Normal	1	1	1	3.6	3.6	8
SAR Drift Measurement	6.6.2	0	Rectangular	1.732050808	1	1	0.0	0.0	∞
Phantom and Tissue Parameters									
Phantom Uncertainty	E.3.1	4	Rectangular	1.732050808	1	1	2.3	2.3	∞
Liquid Conductivity (target)	E.3.2	5	Rectangular	1.732050808	0.64	0.43	1.8	1.2	∞
Liquid Conductivity (measured)	E.3.3	5.32	Normal	1	0.64	0.43	3.4	2.3	∞
Liquid Permittivity (target)	E.3.2	5	Rectangular	1.732050808	0.6	0.49	1.7	1.4	∞
Liquid Permittivity (measured)	E.3.3	4.37	Normal	1	0.6	0.49	2.6	2.1	∞
Combined Standard Uncertainty			RSS				11.49	10.97	
Expanded Uncertainty (95% Confidence Interval)			k=2				22.97	21.94	

Measurement Uncertainty Table in accordance with IEEE Standard 1528-2003

This uncertainty represents an expanded uncertainty expressed at approximately the 95% confidence level using a coverage factor of k=2

Applicant:	Kenwood USA Corporation	FCC ID:	ALH435001	IC ID:	282D-435001	KENWOOD
DUT Type:	Portable UHF PTT Radio Transceiver	Models:	TK-3402-K2-P	406.1 - 470.0 MHz		
2012 Celltech Labs Inc.		This document is not to be reproduced in whole or in part without the prior written permission of Celltech Labs Inc.				Page 28 of 131



	Date(s) of Evaluation Aug 20-30, Oct 4-10, 2012	Test Report Serial No. 081612ALH-T1191-S90V	Test Report Revision No. Rev. 1.0 (1st Release)	 Test Lab Certificate No. 2470.01
	Test Report Issue Date Oct. 22, 2012	Description of Test(s) Specific Absorption Rate	RF Exposure Category Occupational (Controlled)	

UNCERTAINTY BUDGET FOR DEVICE EVALUATION (IC - IEC 62209-2:2010)									
Source of Uncertainty	IEC 62209-2 Section	Tolerance / Uncertainty ±%	Probability Distribution	Divisor	ci 1g	ci 10g	Standard Uncertainty ±% (1g)	Standard Uncertainty ±% (10g)	V _i or V _{eff}
Measurement System									
Probe Calibration (450 MHz)	7.2.2.1	6.7	Normal	1	1	1	6.7	6.7	∞
Isotropy	7.2.2.2	4.7	Rectangular	1.732050808	1	1	2.7	2.7	∞
Boundary Effect	7.2.2.6	1	Rectangular	1.732050808	1	1	0.6	0.6	∞
Linearity	7.2.2.3	4.7	Rectangular	1.732050808	1	1	2.7	2.7	∞
Detection Limits	7.2.2.5	1	Rectangular	1.732050808	1	1	0.6	0.6	∞
Readout Electronics	7.2.2.7	0.3	Normal	1	1	1	0.3	0.3	∞
Response Time	7.2.2.8	0.8	Rectangular	1.732050808	1	1	0.5	0.5	∞
Integration Time	7.2.2.9	2.6	Rectangular	1.732050808	1	1	1.5	1.5	∞
RF Ambient Conditions	7.2.4.5	3	Rectangular	1.732050808	1	1	1.7	1.7	∞
Probe Positioner Mechanical Restrictions	7.2.3.1	0.4	Rectangular	1.732050808	1	1	0.2	0.2	∞
Probe Positioning wrt Phantom Shell	7.2.3.3	2.9	Rectangular	1.732050808	1	1	1.7	1.7	∞
Post-processing	7.2.5	1	Rectangular	1.732050808	1	1	0.6	0.6	∞
Test Sample Related									
Test Sample Positioning	7.2.3.4.3	2.9	Normal	1	1	1	2.9	2.9	12
Device Holder Uncertainty	7.2.3.4.2	3.6	Normal	1	1	1	3.6	3.6	8
Drift of Output Power (meas. SAR drift)	7.2.2.10	0	Rectangular	1.732050808	1	1	0.0	0.0	∞
Phantom and Tissue Parameters									
Phantom Uncertainty	7.2.3.2	4	Rectangular	1.732050808	1	1	2.3	2.3	∞
SAR Correction Algorithm for deviations in permittivity and conductivity	7.2.4.3	1.2	Normal	1	1	0.81	1.2	0.97	∞
Liquid Conductivity (measured)	7.2.4.3	5.32	Normal	1	0.78	0.71	4.1	3.8	∞
Liquid Permittivity (measured)	7.2.4.3	4.37	Normal	1	0.23	0.26	1.0	1.1	∞
Liquid Permittivity - temp. uncertainty	7.2.4.4	0.27	Rectangular	1.732050808	0.78	0.71	0.1	0.1	∞
Liquid Conductivity - temp. uncertainty	7.2.4.4	0.84	Rectangular	1.732050808	0.23	0.26	0.1	0.1	∞
Combined Standard Uncertainty	7.3.1		RSS				10.74	10.60	
Expanded Uncertainty (95% Confidence Interval)	7.3.2		k=2				21.49	21.19	

Measurement Uncertainty Table in accordance with International Standard IEC 62209-2:2010

This uncertainty represents an expanded uncertainty expressed at approximately the 95% confidence level using a coverage factor of k=2



Applicant:	Kenwood USA Corporation	FCC ID:	ALH435001	IC ID:	282D-435001	KENWOOD
DUT Type:	Portable UHF PTT Radio Transceiver	Models:	TK-3402-K2-P	406.1 - 470.0 MHz		
2012 Celltech Labs Inc.		This document is not to be reproduced in whole or in part without the prior written permission of Celltech Labs Inc.				Page 29 of 131

	<u>Date(s) of Evaluation</u> Aug 20-30, Oct 4-10, 2012	<u>Test Report Serial No.</u> 081612ALH-T1191-S90V	<u>Test Report Revision No.</u> Rev. 1.0 (1st Release)	 Test Lab Certificate No. 2470.01
	<u>Test Report Issue Date</u> Oct. 22, 2012	<u>Description of Test(s)</u> Specific Absorption Rate	<u>RF Exposure Category</u> Occupational (Controlled)	

24.0 REFERENCES



- [1] Federal Communications Commission - "Radiofrequency radiation exposure evaluation: portable devices"; Rule Part 47 CFR §2.1093.
- [2] Health Canada - "Limits of Human Exposure to Radiofrequency Electromagnetic Fields in the Frequency Range from 3 kHz to 300 GHz", Safety Code 6: 1999.
- [3] Federal Communications Commission - "Evaluating Compliance with FCC Guidelines for Human Exposure to Radio frequency Electromagnetic Fields", OET Bulletin 65, Supplement C (Edition 01-01), FCC, Washington, D.C.: June 2001.
- [4] Industry Canada - "Radio Frequency (RF) Exposure Compliance of Radiocommunication Apparatus (All Frequency Bands)", Radio Standards Specification RSS-102 Issue 4: March 2010.
- [5] IEEE Standard 1528-2003 - "Recommended Practice for Determining the Peak Spatial-Average Specific Absorption Rate (SAR) in the Human Head from Wireless Communications Devices: Measurement Techniques": December 2003.
- [6] IEC International Standard 62209-1:2005 - "Human exposure to radio frequency fields from hand-held and body-mounted wireless communication devices - Human models, instrumentation, and procedures."
- [7] International Standard IEC 62209-2 Edition 1.0 2010-03 - "Human exposure to radio frequency fields from hand-held & body-mounted wireless communication devices - Part 2: Procedure to determine the specific absorption rate (SAR) for wireless communication devices used in close proximity to the human body (frequency range of 30 MHz to 6 GHz)".
- [8] Federal Communications Commission, Office of Engineering and Technology - "Mobile and Portable Device RF Exposure Procedures and Equipment Authorization Policies"; KDB 447498 D01 v04: November 2009.
- [9] Federal Communications Commission, Office of Engineering and Technology - "SAR Test Reduction Considerations for Occupational PTT Radios", KDB 643646 D01v01: December 2010.
- [10] Federal Communications Commission, Office of Engineering and Technology - "Application Note: SAR Probe Calibration and System Verification Considerations for Measurements at 150 MHz - 3 GHz"; KDB 450824 D01 v01r01: January 2007.
- [11] Schmid & Partner Engineering AG - DASY4 Manual V4.6, Chapter 16 Application Note, Head Tissue Recipe: Sept. 2005.
- [12] Schmid & Partner Engineering AG - DASY4 Manual V4.6, Chapter 17 Application Note, Body Tissue Recipe: Sept. 2005.
- [13] Schmid & Partner Engineering AG - DASY4 Manual V4.6, Chapter 22 Application Note, SAR Sensitivities: Sept. 2005.
- [14] ISO/IEC 17025 - "General requirements for the competence of testing and calibration laboratories (ISO/IEC 17025:2005)."
- [15] Federal Communications Commission - "Measurements Required: RF Power Output"; Rule Part 47 CFR §2.1046.
- [16] Industry Canada - "General Requirements and Information for the Certification of Radiocommunication Equipment", Radio Standards Specification RSS-Gen Issue 3: December 2010.

Applicant:	Kenwood USA Corporation	FCC ID:	ALH435001	IC ID:	282D-435001	KENWOOD
DUT Type:	Portable UHF PTT Radio Transceiver	Models:	TK-3402-K2-P	406.1 - 470.0 MHz		
2012 Celltech Labs Inc.	This document is not to be reproduced in whole or in part without the prior written permission of Celltech Labs Inc.					Page 30 of 131

	<u>Date(s) of Evaluation</u> Aug 20-30, Oct 4-10, 2012	<u>Test Report Serial No.</u> 081612ALH-T1191-S90V	<u>Test Report Revision No.</u> Rev. 1.0 (1st Release)	 Test Lab Certificate No. 2470.01
	<u>Test Report Issue Date</u> Oct. 22, 2012	<u>Description of Test(s)</u> Specific Absorption Rate	<u>RF Exposure Category</u> Occupational (Controlled)	

APPENDIX B - SYSTEM PERFORMANCE CHECK PLOTS

Applicant:	Kenwood USA Corporation	FCC ID:	ALH435001	IC ID:	282D-435001	KENWOOD
DUT Type:	Portable UHF PTT Radio Transceiver	Models:	TK-3402-K2-P	406.1 - 470.0 MHz		
2012 Celltech Labs Inc.	This document is not to be reproduced in whole or in part without the prior written permission of Celltech Labs Inc.					Page 71 of 131

	<u>Date(s) of Evaluation</u> Aug 20-30, Oct 4-10, 2012	<u>Test Report Serial No.</u> 081612ALH-T1191-S90V	<u>Test Report Revision No.</u> Rev. 1.0 (1st Release)	 Test Lab Certificate No. 2470.01
	<u>Test Report Issue Date</u> Oct. 22, 2012	<u>Description of Test(s)</u> Specific Absorption Rate	<u>RF Exposure Category</u> Occupational (Controlled)	

System Performance Check - 450 MHz Body

Date Tested: 08/20/2012

DUT: Dipole 450 MHz; Type: D450V3; Serial: 1068; Calibrated: 04/27/2012

Program Notes: Ambient Temp: 24C; Fluid Temp: 22.8C; Barometric Pressure: 101.1 kPa; Humidity: 31%

Communication System: CW

Frequency: 450 MHz; Duty Cycle: 1:1

Medium: M450 Medium parameters used: $f = 450 \text{ MHz}$; $\sigma = 0.93 \text{ mho/m}$; $\epsilon_r = 56.1$; $\rho = 1000 \text{ kg/m}^3$

- Probe: ET3DV6 - SN1590; ConvF(7.93, 7.93, 7.93); Calibrated: 24/04/2012
- Sensor-Surface: 4mm (Mechanical Surface Detection)
- Electronics: DAE4 Sn353; Calibrated: 19/04/2012
- Phantom: Barski Industries; Type: Fiberglass Planar; Serial: 03-01
- Measurement SW: DASY4, V4.7 Build 80; Postprocessing SW: SEMCAD, V1.8 Build 186

Body d=15mm Pin=398mW/Area Scan (6x11x1): Measurement grid: dx=15mm, dy=15mm

Maximum value of SAR (measured) = 1.95 mW/g

Body d=15mm Pin=398mW/Zoom Scan (7x7x7)/Cube 0: Measurement grid: dx=5mm, dy=5mm, dz=5mm

Reference Value = 47.0 V/m; Power Drift = 0.028 dB

Peak SAR (extrapolated) = 3.11 W/kg

SAR(1 g) = 1.92 mW/g; SAR(10 g) = 1.27 mW/g

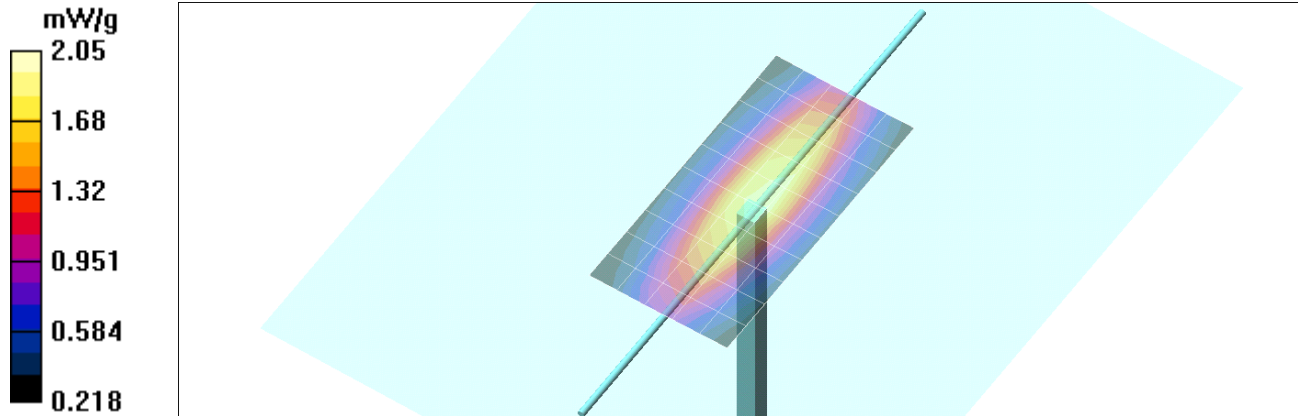

Maximum value of SAR (measured) = 2.05 mW/g

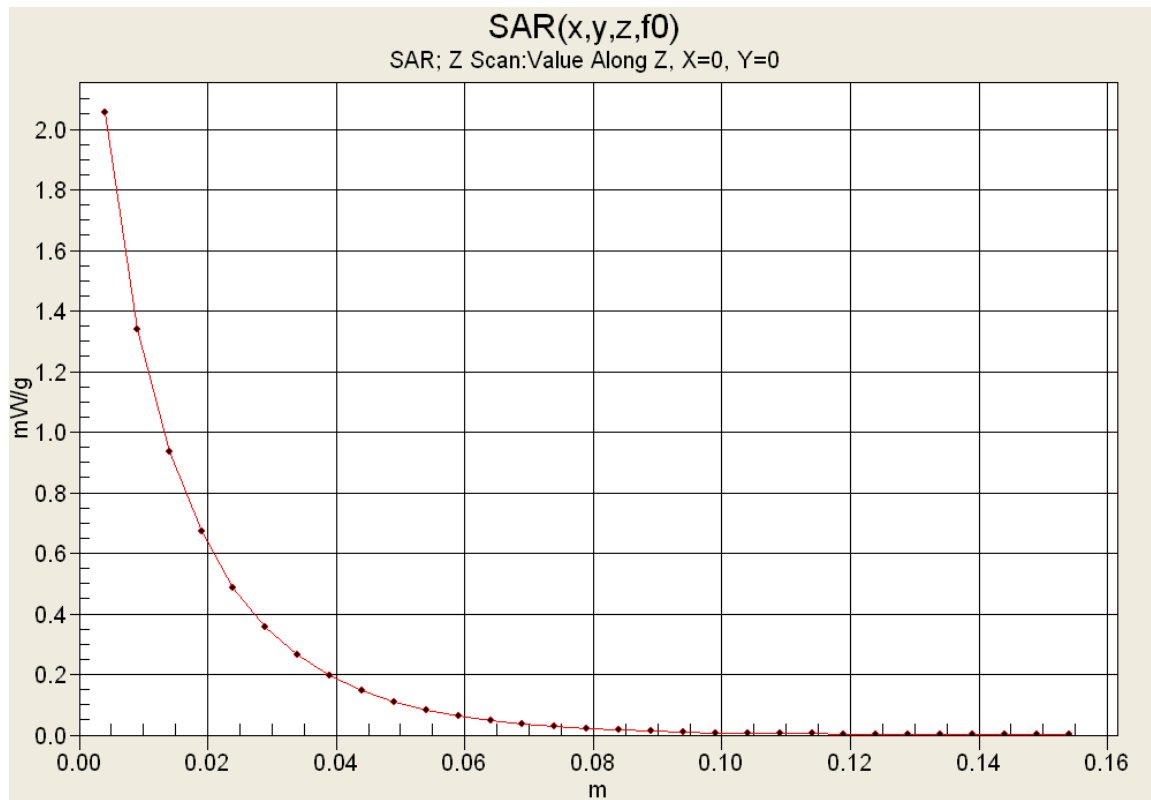

Applicant:	Kenwood USA Corporation	FCC ID:	ALH435001	IC ID:	282D-435001	KENWOOD
DUT Type:	Portable UHF PTT Radio Transceiver	Models:	TK-3402-K2-P	406.1 - 470.0 MHz		
2012 Celltech Labs Inc.		This document is not to be reproduced in whole or in part without the prior written permission of Celltech Labs Inc.				Page 72 of 131

Z-Axis Scan



	<u>Date(s) of Evaluation</u> Aug 20-30, Oct 4-10, 2012	<u>Test Report Serial No.</u> 081612ALH-T1191-S90V	<u>Test Report Revision No.</u> Rev. 1.0 (1st Release)	
	<u>Test Report Issue Date</u> Oct. 22, 2012	<u>Description of Test(s)</u> Specific Absorption Rate	<u>RF Exposure Category</u> Occupational (Controlled)	

System Performance Check - 450 MHz Head

Date Tested: 08/22/2012

DUT: Dipole 450 MHz; Type: D450V3; Serial: 1068; Calibrated: 04/27/2012

Program Notes: Ambient Temp: 24.0C; Fluid Temp: 23.3C; Barometric Pressure: 101.1 kPa; Humidity: 32%

Communication System: CW

Frequency: 450 MHz; Duty Cycle: 1:1

Medium: HSL450 Medium parameters used: $f = 450 \text{ MHz}$; $\sigma = 0.83 \text{ mho/m}$; $\epsilon_r = 43.6$; $\rho = 1000 \text{ kg/m}^3$

- Probe: ET3DV6 - SN1590; ConvF(7.54, 7.54, 7.54); Calibrated: 24/04/2012
- Sensor-Surface: 4mm (Mechanical Surface Detection)
- Electronics: DAE4 Sn353; Calibrated: 19/04/2012
- Phantom: Barski Industries; Type: Fiberglass Planar; Serial: 03-01
- Measurement SW: DAS4, V4.7 Build 80; Postprocessing SW: SEMCAD, V1.8 Build 186

Head d=15mm Pin=398mW/Area Scan (6x11x1): Measurement grid: dx=15mm, dy=15mm

Maximum value of SAR (measured) = 1.83 mW/g

Head d=15mm Pin=398mW/Zoom Scan (7x7x7)/Cube 0: Measurement grid: dx=5mm, dy=5mm, dz=5mm

Reference Value = 49.0 V/m; Power Drift = -0.044 dB

Peak SAR (extrapolated) = 2.90 W/kg

SAR(1 g) = 1.83 mW/g; SAR(10 g) = 1.21 mW/g

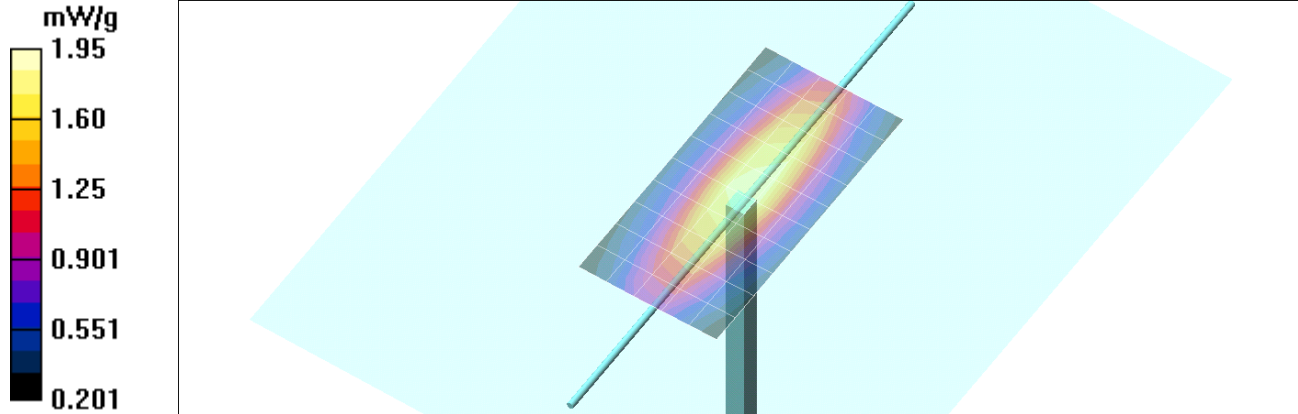

Maximum value of SAR (measured) = 1.95 mW/g

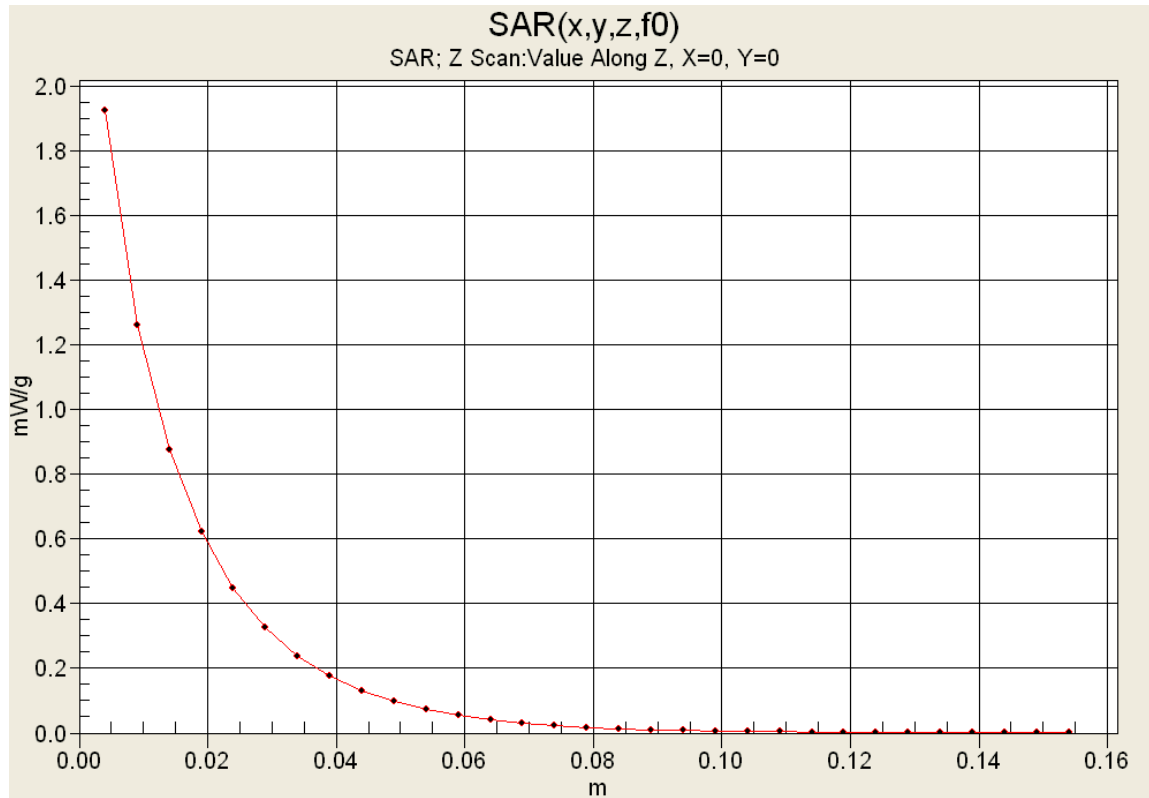

Applicant:	Kenwood USA Corporation	FCC ID:	ALH435001	IC ID:	282D-435001	KENWOOD
DUT Type:	Portable UHF PTT Radio Transceiver	Models:	TK-3402-K2-P	406.1 - 470.0 MHz		
2012 Celltech Labs Inc.		This document is not to be reproduced in whole or in part without the prior written permission of Celltech Labs Inc.				Page 74 of 131

Z-Axis Scan



	<u>Date(s) of Evaluation</u> Aug 20-30, Oct 4-10, 2012	<u>Test Report Serial No.</u> 081612ALH-T1191-S90V	<u>Test Report Revision No.</u> Rev. 1.0 (1st Release)	
	<u>Test Report Issue Date</u> Oct. 22, 2012	<u>Description of Test(s)</u> Specific Absorption Rate	<u>RF Exposure Category</u> Occupational (Controlled)	

System Performance Check - 450 MHz Head

Date Tested: 08/28/2012

DUT: Dipole 450 MHz; Type: D450V3; Serial: 1068; Calibrated: 04/27/2012

Program Notes: Ambient Temp: 23.0C; Fluid Temp: 23.3C; Barometric Pressure: 101.1 kPa; Humidity: 35%

Communication System: CW

Frequency: 450 MHz; Duty Cycle: 1:1

Medium: HSL450 Medium parameters used: $f = 450 \text{ MHz}$; $\sigma = 0.87 \text{ mho/m}$; $\epsilon_r = 44.9$; $\rho = 1000 \text{ kg/m}^3$

- Probe: ET3DV6 - SN1590; ConvF(7.54, 7.54, 7.54); Calibrated: 24/04/2012
- Sensor-Surface: 4mm (Mechanical Surface Detection)
- Electronics: DAE4 Sn353; Calibrated: 19/04/2012
- Phantom: Barski Industries; Type: Fiberglass Planar; Serial: 03-01
- Measurement SW: DASY4, V4.7 Build 80; Postprocessing SW: SEMCAD, V1.8 Build 186

Head d=15mm Pin=398mW/Area Scan (6x11x1): Measurement grid: dx=15mm, dy=15mm
Maximum value of SAR (measured) = 1.89 mW/g

Head d=15mm Pin=398mW/Zoom Scan (7x7x7)/Cube 0: Measurement grid: dx=5mm, dy=5mm, dz=5mm
Reference Value = 48.9 V/m; Power Drift = 0.023 dB
Peak SAR (extrapolated) = 2.98 W/kg

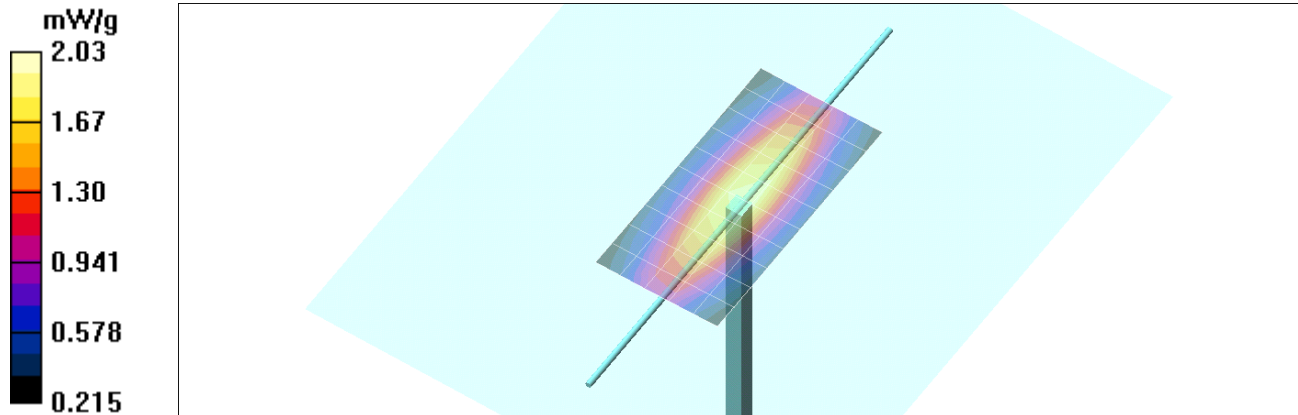

SAR(1 g) = 1.9 mW/g; SAR(10 g) = 1.27 mW/g
Maximum value of SAR (measured) = 2.03 mW/g

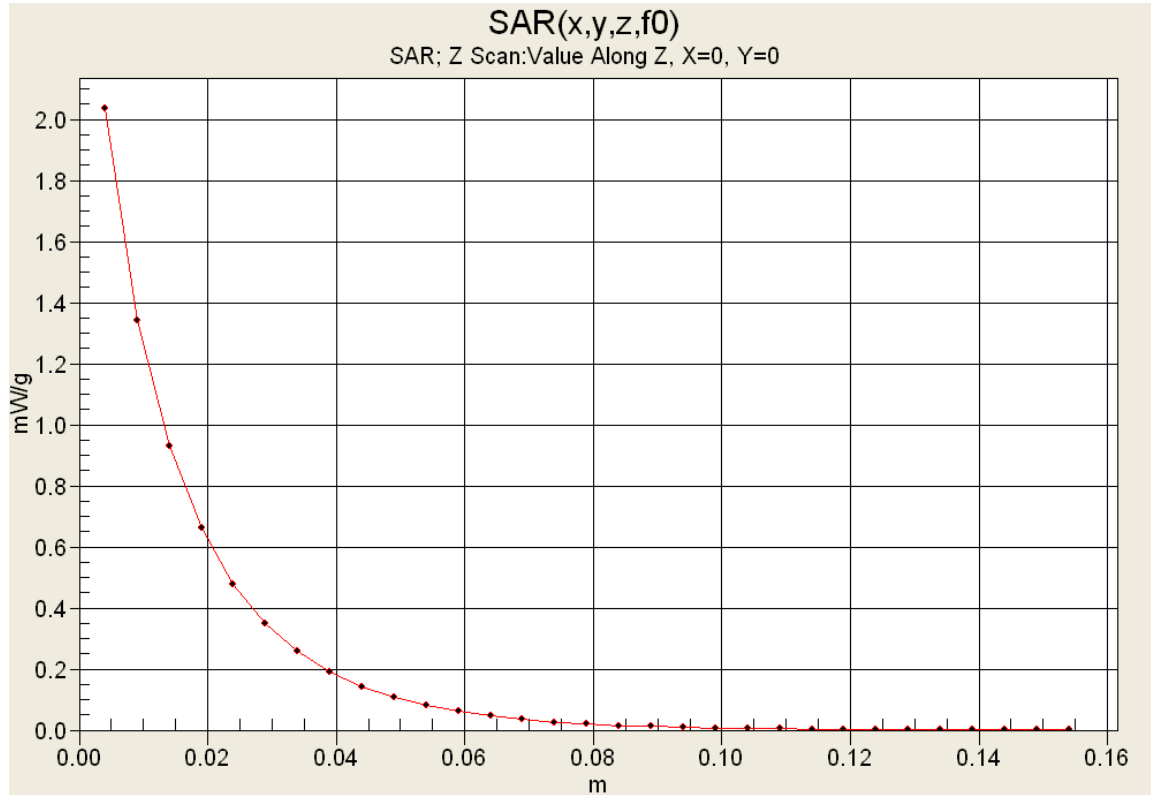

Applicant:	Kenwood USA Corporation	FCC ID:	ALH435001	IC ID:	282D-435001	KENWOOD
DUT Type:	Portable UHF PTT Radio Transceiver	Models:	TK-3402-K2-P	406.1 - 470.0 MHz		
2012 Celltech Labs Inc.		This document is not to be reproduced in whole or in part without the prior written permission of Celltech Labs Inc.				Page 76 of 131

Z-Axis Scan



	<u>Date(s) of Evaluation</u> Aug 20-30, Oct 4-10, 2012	<u>Test Report Serial No.</u> 081612ALH-T1191-S90V	<u>Test Report Revision No.</u> Rev. 1.0 (1st Release)	
	<u>Test Report Issue Date</u> Oct. 22, 2012	<u>Description of Test(s)</u> Specific Absorption Rate	<u>RF Exposure Category</u> Occupational (Controlled)	

System Performance Check - 450 MHz Body

Date Tested: 08/28/2012

DUT: Dipole 450 MHz; Type: D450V3; Serial: 1068; Calibrated: 04/27/2012

Program Notes: Ambient Temp: 23C; Fluid Temp: 23.2C; Barometric Pressure: 101.1 kPa; Humidity: 35%

Communication System: CW

Frequency: 450 MHz; Duty Cycle: 1:1

Medium: M450 Medium parameters used: $f = 450 \text{ MHz}$; $\sigma = 0.93 \text{ mho/m}$; $\epsilon_r = 55.9$; $\rho = 1000 \text{ kg/m}^3$

- Probe: ET3DV6 - SN1590; ConvF(7.93, 7.93, 7.93); Calibrated: 24/04/2012
- Sensor-Surface: 4mm (Mechanical Surface Detection)
- Electronics: DAE4 Sn353; Calibrated: 19/04/2012
- Phantom: Barski Industries; Type: Fiberglass Planar; Serial: 03-01
- Measurement SW: DASY4, V4.7 Build 80; Postprocessing SW: SEMCAD, V1.8 Build 186

Body d=15mm Pin=398mW/Area Scan (6x11x1): Measurement grid: dx=15mm, dy=15mm
Maximum value of SAR (measured) = 1.88 mW/g

Body d=15mm Pin=398mW/Zoom Scan (7x7x7)/Cube 0: Measurement grid: dx=5mm, dy=5mm, dz=5mm
Reference Value = 46.1 V/m; Power Drift = 0.020 dB
Peak SAR (extrapolated) = 2.98 W/kg

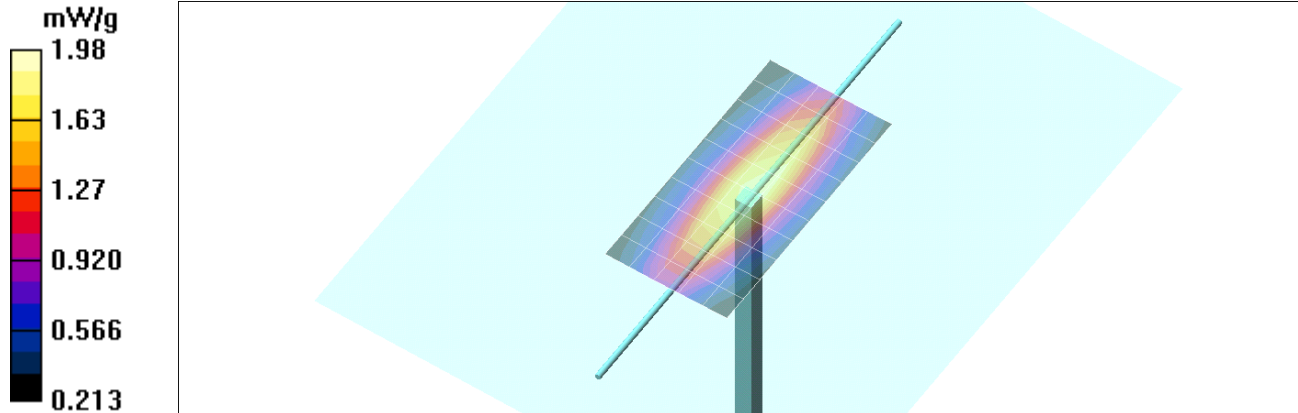

SAR(1 g) = 1.85 mW/g; SAR(10 g) = 1.23 mW/g
Maximum value of SAR (measured) = 1.98 mW/g

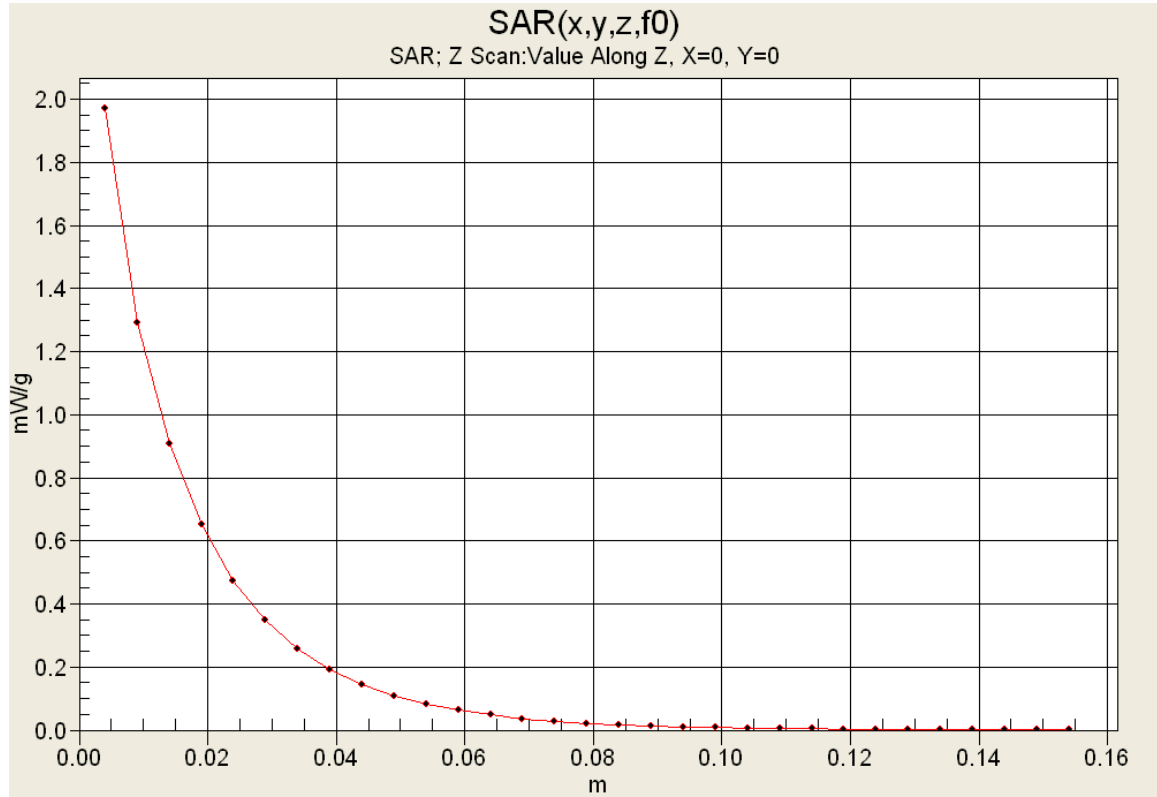

Applicant:	Kenwood USA Corporation	FCC ID:	ALH435001	IC ID:	282D-435001	KENWOOD
DUT Type:	Portable UHF PTT Radio Transceiver	Models:	TK-3402-K2-P	406.1 - 470.0 MHz		
2012 Celltech Labs Inc.		This document is not to be reproduced in whole or in part without the prior written permission of Celltech Labs Inc.				Page 78 of 131

Z-Axis Scan



	<u>Date(s) of Evaluation</u> Aug 20-30, Oct 4-10, 2012	<u>Test Report Serial No.</u> 081612ALH-T1191-S90V	<u>Test Report Revision No.</u> Rev. 1.0 (1st Release)	 Test Lab Certificate No. 2470.01
	<u>Test Report Issue Date</u> Oct. 22, 2012	<u>Description of Test(s)</u> Specific Absorption Rate	<u>RF Exposure Category</u> Occupational (Controlled)	

System Performance Check - 450 MHz Body

Date Tested: 08/30/2012

DUT: Dipole 450 MHz; Type: D450V3; Serial: 1068; Calibrated: 04/27/2012

Program Notes: Ambient Temp: 23C; Fluid Temp: 23.8C; Barometric Pressure: 101.1 kPa; Humidity: 30%

Communication System: CW

Frequency: 450 MHz; Duty Cycle: 1:1

Medium: M450 Medium parameters used: $f = 450 \text{ MHz}$; $\sigma = 0.93 \text{ mho/m}$; $\epsilon_r = 55.8$; $\rho = 1000 \text{ kg/m}^3$

- Probe: ET3DV6 - SN1590; ConvF(7.93, 7.93, 7.93); Calibrated: 24/04/2012
- Sensor-Surface: 4mm (Mechanical Surface Detection)
- Electronics: DAE4 Sn353; Calibrated: 19/04/2012
- Phantom: Barski Industries; Type: Fiberglass Planar; Serial: 03-01
- Measurement SW: DASY4, V4.7 Build 80; Postprocessing SW: SEMCAD, V1.8 Build 186

Body d=15mm Pin=398mW/Area Scan (6x11x1): Measurement grid: dx=15mm, dy=15mm
Maximum value of SAR (measured) = 1.78 mW/g

Body d=15mm Pin=398mW/Zoom Scan (7x7x7)/Cube 0: Measurement grid: dx=5mm, dy=5mm, dz=5mm
Reference Value = 46.3 V/m; Power Drift = 0.023 dB
Peak SAR (extrapolated) = 2.92 W/kg

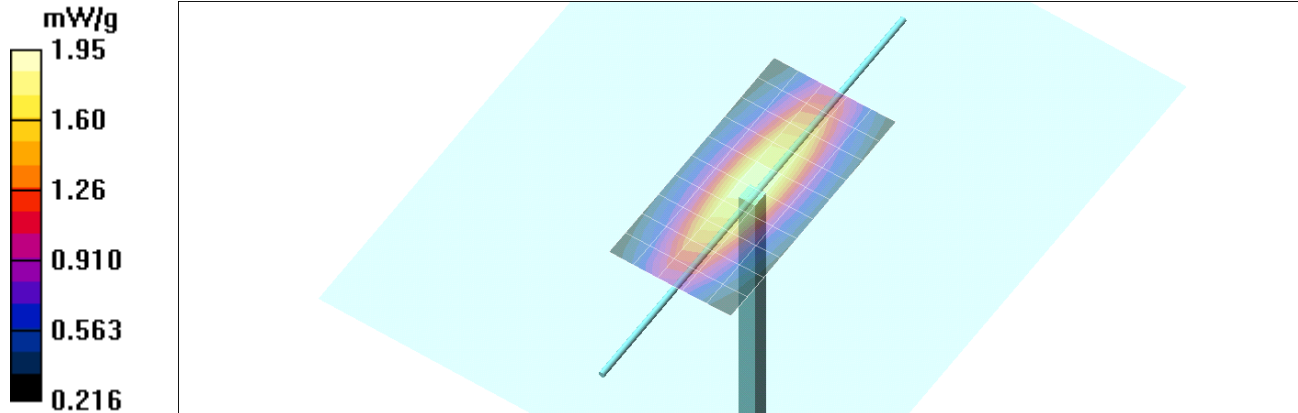

SAR(1 g) = 1.84 mW/g; SAR(10 g) = 1.22 mW/g
Maximum value of SAR (measured) = 1.95 mW/g

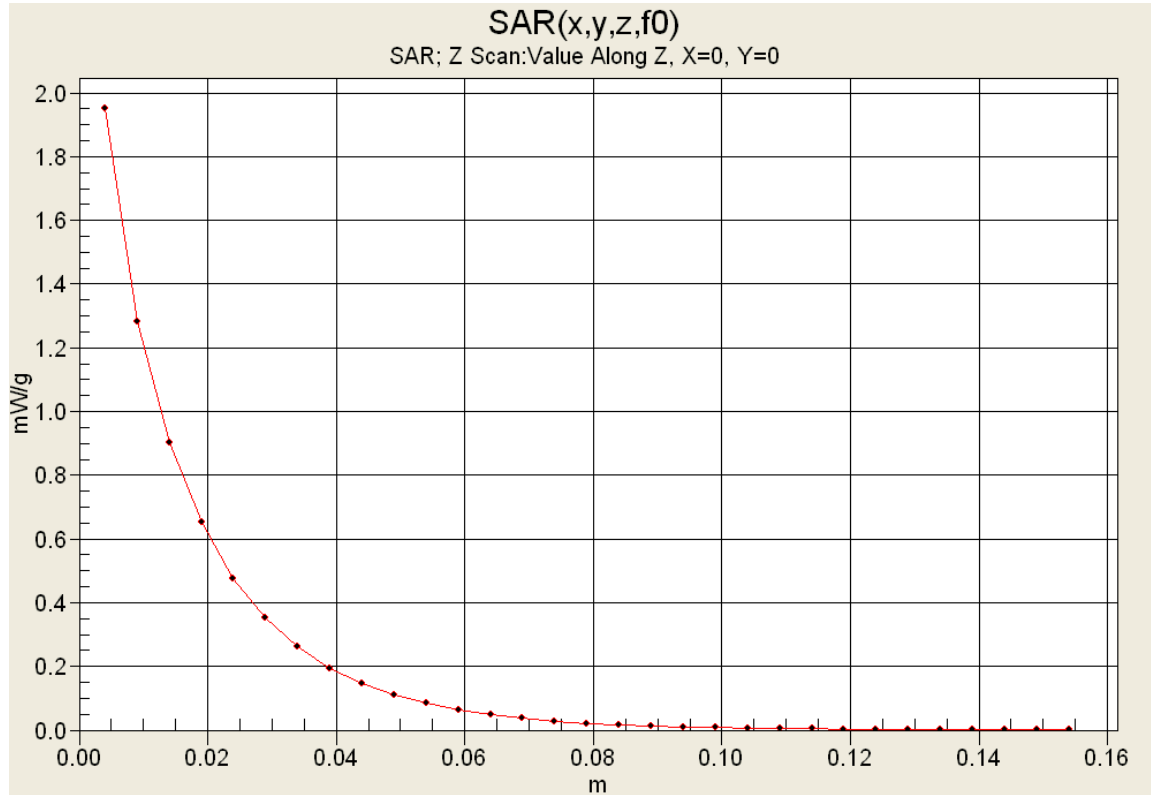

Applicant:	Kenwood USA Corporation	FCC ID:	ALH435001	IC ID:	282D-435001	KENWOOD
DUT Type:	Portable UHF PTT Radio Transceiver	Models:	TK-3402-K2-P	406.1 - 470.0 MHz		
2012 Celltech Labs Inc.		This document is not to be reproduced in whole or in part without the prior written permission of Celltech Labs Inc.				Page 80 of 131

Z-Axis Scan



	<u>Date(s) of Evaluation</u> Aug 20-30, Oct 4-10, 2012	<u>Test Report Serial No.</u> 081612ALH-T1191-S90V	<u>Test Report Revision No.</u> Rev. 1.0 (1st Release)	
	<u>Test Report Issue Date</u> Oct. 22, 2012	<u>Description of Test(s)</u> Specific Absorption Rate	<u>RF Exposure Category</u> Occupational (Controlled)	

System Performance Check - 450 MHz Head

Date Tested: 10/04/2012

DUT: Dipole 450 MHz; Type: D450V3; Serial: 1068; Calibrated: 04/27/2012

Program Notes: Ambient Temp: 23.0C; Fluid Temp: 21.4C; Barometric Pressure: 101.1 kPa; Humidity: 30%

Communication System: CW

Frequency: 450 MHz; Duty Cycle: 1:1

Medium: HSL450 Medium parameters used: $f = 450 \text{ MHz}$; $\sigma = 0.86 \text{ mho/m}$; $\epsilon_r = 45.5$; $\rho = 1000 \text{ kg/m}^3$

- Probe: ET3DV6 - SN1590; ConvF(7.54, 7.54, 7.54); Calibrated: 24/04/2012
- Sensor-Surface: 4mm (Mechanical Surface Detection)
- Electronics: DAE4 Sn353; Calibrated: 19/04/2012
- Phantom: Barski Industries; Type: Fiberglass Planar; Serial: 03-01
- Measurement SW: DASY4, V4.7 Build 80; Postprocessing SW: SEMCAD, V1.8 Build 186

Head d=15mm Pin=398mW/Area Scan (6x11x1): Measurement grid: dx=15mm, dy=15mm
Maximum value of SAR (measured) = 1.91 mW/g

Head d=15mm Pin=398mW/Zoom Scan (7x7x7)/Cube 0: Measurement grid: dx=5mm, dy=5mm, dz=5mm
Reference Value = 49.1 V/m; Power Drift = -0.006 dB
Peak SAR (extrapolated) = 3.01 W/kg

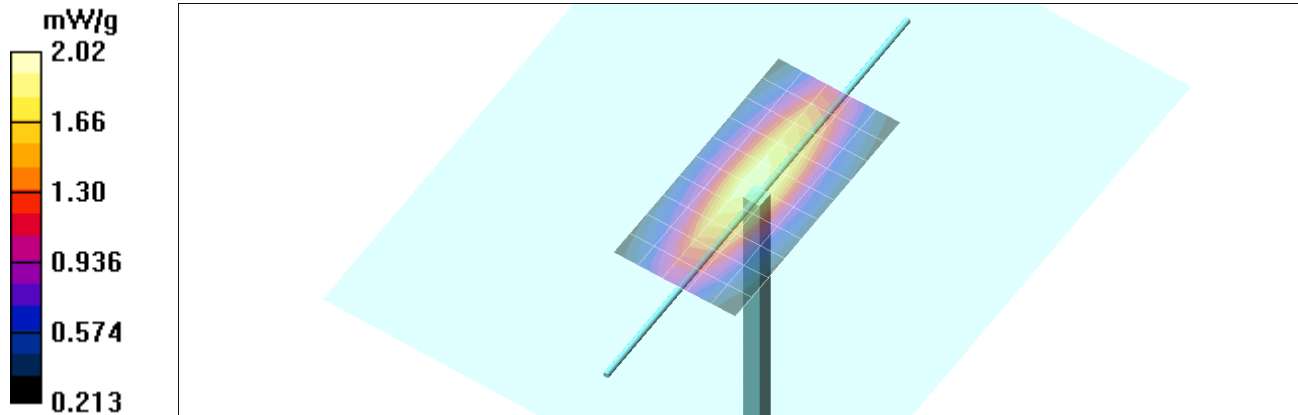

SAR(1 g) = 1.9 mW/g; SAR(10 g) = 1.25 mW/g
Maximum value of SAR (measured) = 2.02 mW/g

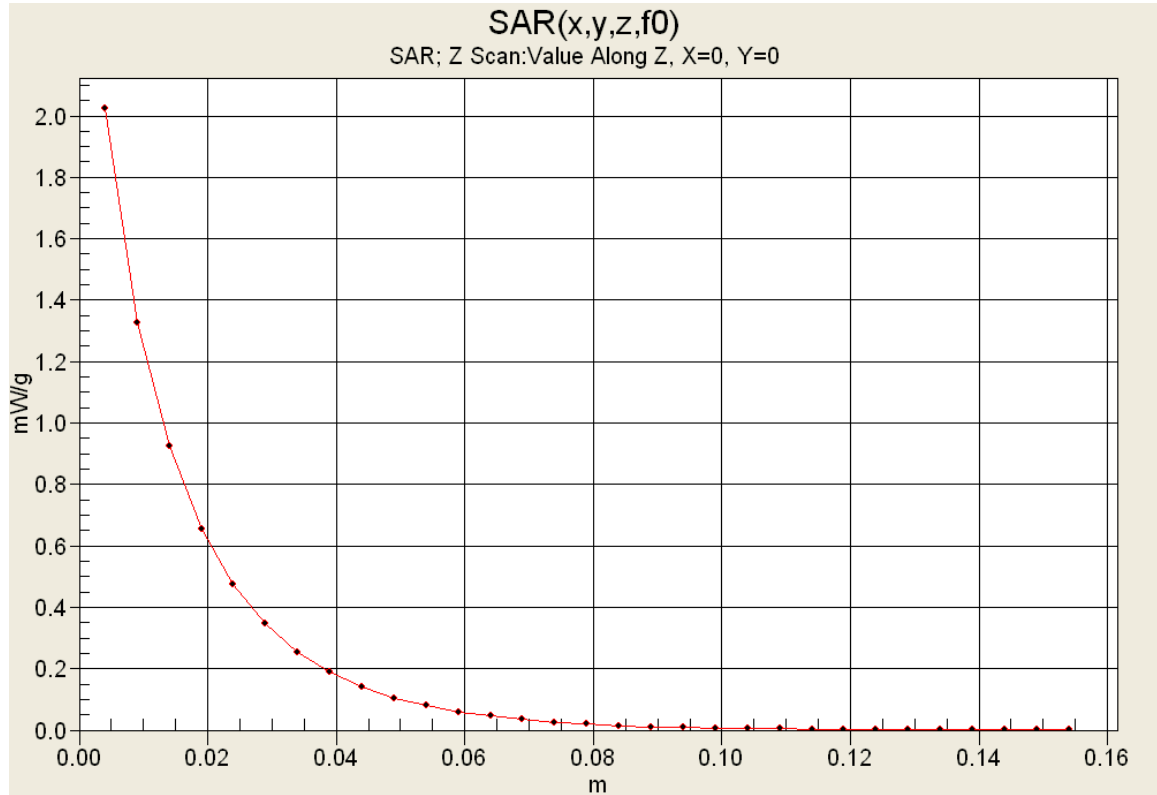

Applicant:	Kenwood USA Corporation	FCC ID:	ALH435001	IC ID:	282D-435001	KENWOOD
DUT Type:	Portable UHF PTT Radio Transceiver	Models:	TK-3402-K2-P	406.1 - 470.0 MHz		
2012 Celltech Labs Inc.		This document is not to be reproduced in whole or in part without the prior written permission of Celltech Labs Inc.				Page 82 of 131

Z-Axis Scan



	<u>Date(s) of Evaluation</u> Aug 20-30, Oct 4-10, 2012	<u>Test Report Serial No.</u> 081612ALH-T1191-S90V	<u>Test Report Revision No.</u> Rev. 1.0 (1st Release)	 Test Lab Certificate No. 2470.01
	<u>Test Report Issue Date</u> Oct. 22, 2012	<u>Description of Test(s)</u> Specific Absorption Rate	<u>RF Exposure Category</u> Occupational (Controlled)	

System Performance Check - 450 MHz Body

Date Tested: 10/09/2012

DUT: Dipole 450 MHz; Type: D450V3; Serial: 1068; Calibrated: 04/27/2012

Program Notes: Ambient Temp: 22C; Fluid Temp: 21.7C; Barometric Pressure: 101.1 kPa; Humidity: 30%

Communication System: CW

Frequency: 450 MHz; Duty Cycle: 1:1

Medium: M450 Medium parameters used: $f = 450 \text{ MHz}$; $\sigma = 0.91 \text{ mho/m}$; $\epsilon_r = 56.9$; $\rho = 1000 \text{ kg/m}^3$

- Probe: ET3DV6 - SN1590; ConvF(7.93, 7.93, 7.93); Calibrated: 24/04/2012
- Sensor-Surface: 4mm (Mechanical Surface Detection)
- Electronics: DAE4 Sn353; Calibrated: 19/04/2012
- Phantom: Barski Industries; Type: Fiberglass Planar; Serial: 03-01
- Measurement SW: DASY4, V4.7 Build 80; Postprocessing SW: SEMCAD, V1.8 Build 186

Body d=15mm Pin=398mW/Area Scan (6x11x1): Measurement grid: dx=15mm, dy=15mm
Maximum value of SAR (measured) = 1.73 mW/g

Body d=15mm Pin=398mW/Zoom Scan (7x7x7)/Cube 0: Measurement grid: dx=5mm, dy=5mm, dz=5mm
Reference Value = 45.8 V/m; Power Drift = 0.045 dB
Peak SAR (extrapolated) = 2.82 W/kg

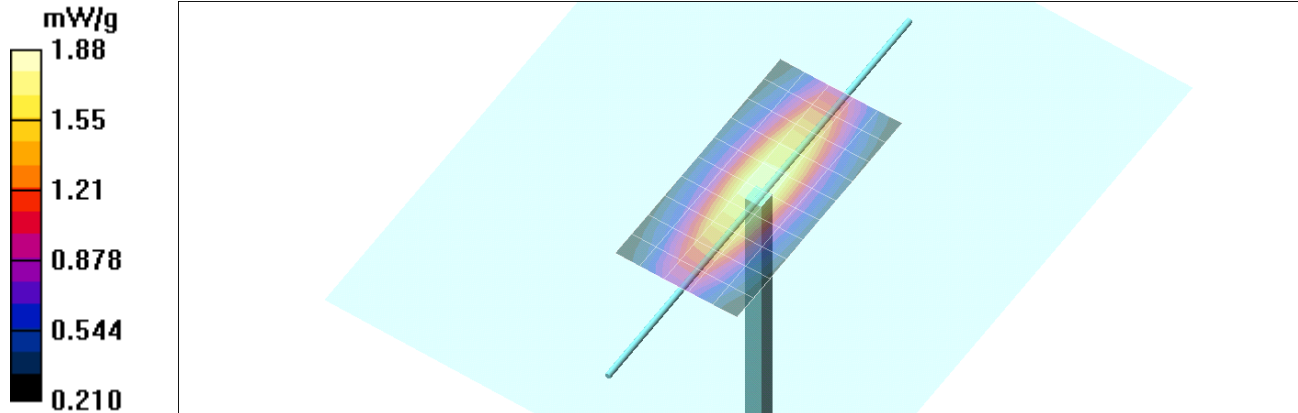

SAR(1 g) = 1.77 mW/g; SAR(10 g) = 1.18 mW/g
Maximum value of SAR (measured) = 1.88 mW/g



Applicant:	Kenwood USA Corporation	FCC ID:	ALH435001	IC ID:	282D-435001	KENWOOD
DUT Type:	Portable UHF PTT Radio Transceiver	Models:	TK-3402-K2-P	406.1 - 470.0 MHz		
2012 Celltech Labs Inc.		This document is not to be reproduced in whole or in part without the prior written permission of Celltech Labs Inc.				Page 84 of 131

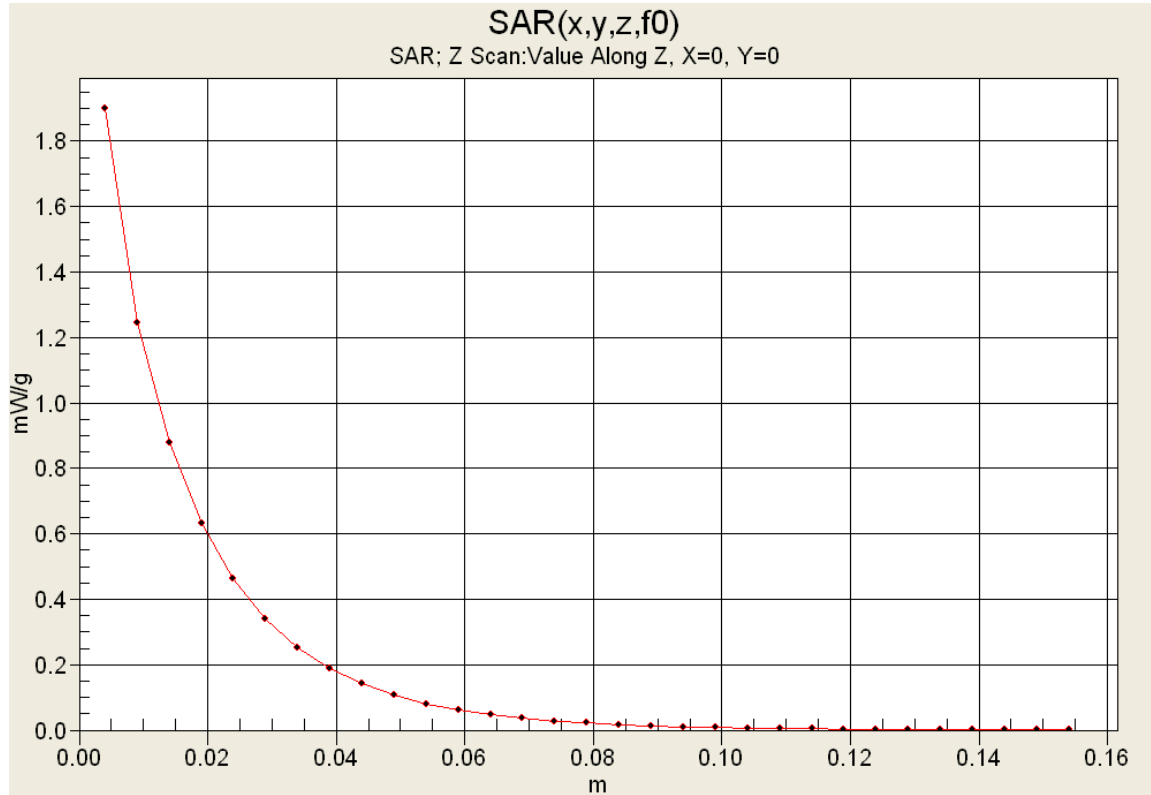

Z-Axis Scan



	<u>Date(s) of Evaluation</u> Aug 20-30, Oct 4-10, 2012	<u>Test Report Serial No.</u> 081612ALH-T1191-S90V	<u>Test Report Revision No.</u> Rev. 1.0 (1st Release)	 Test Lab Certificate No. 2470.01
	<u>Test Report Issue Date</u> Oct. 22, 2012	<u>Description of Test(s)</u> Specific Absorption Rate	<u>RF Exposure Category</u> Occupational (Controlled)	

APPENDIX C - MEASURED FLUID DIELECTRIC PARAMETERS

Applicant:	Kenwood USA Corporation	FCC ID:	ALH435001	IC ID:	282D-435001	KENWOOD
DUT Type:	Portable UHF PTT Radio Transceiver	Models:	TK-3402-K2-P	406.1 - 470.0 MHz		
2012 Celltech Labs Inc.	This document is not to be reproduced in whole or in part without the prior written permission of Celltech Labs Inc.					Page 86 of 131



	<u>Date(s) of Evaluation</u> Aug 20-30, Oct 4-10, 2012	<u>Test Report Serial No.</u> 081612ALH-T1191-S90V	<u>Test Report Revision No.</u> Rev. 1.0 (1st Release)	 Test Lab Certificate No. 2470.01
	<u>Test Report Issue Date</u> Oct. 22, 2012	<u>Description of Test(s)</u> Specific Absorption Rate	<u>RF Exposure Category</u> Occupational (Controlled)	

450 MHz Body

Celltech Labs Inc.
Test Result for UIM Dielectric Parameter
20/Aug/2012
Freq Frequency(GHz)
FCC_eB FCC Limits for Body Epsilon
FCC_sB FCC Limits for Body Sigma
Test_e Epsilon of UIM
Test_s Sigma of UIM

Freq	FCC_eB	FCC_sB	Test_e	Test_s
0.3500	57.70	0.93	58.47	0.87
0.3600	57.60	0.93	57.31	0.87
0.3700	57.50	0.93	57.54	0.89
0.3800	57.40	0.93	57.41	0.86
0.3900	57.30	0.93	57.23	0.88
0.4000	57.20	0.93	57.14	0.88
0.4100	57.10	0.93	56.27	0.91
0.4200	57.00	0.94	56.78	0.91
0.4300	56.90	0.94	56.46	0.92
0.4400	56.80	0.94	56.39	0.93
0.4500	56.70	0.94	56.10	0.93
0.4600	56.66	0.94	56.36	0.94
0.4700	56.62	0.94	55.83	0.95
0.4800	56.58	0.94	56.89	0.96
0.4900	56.54	0.94	55.64	0.97
0.5000	56.51	0.94	55.19	0.98
0.5100	56.47	0.94	55.61	0.97
0.5200	56.43	0.95	55.77	0.99
0.5300	56.39	0.95	55.72	1.01
0.5400	56.35	0.95	55.03	1.02
0.5500	56.31	0.95	55.35	1.03

Applicant:	Kenwood USA Corporation	FCC ID:	ALH435001	IC ID:	282D-435001	KENWOOD
DUT Type:	Portable UHF PTT Radio Transceiver	Models:	TK-3402-K2-P	406.1 - 470.0 MHz		
2012 Celltech Labs Inc.		This document is not to be reproduced in whole or in part without the prior written permission of Celltech Labs Inc.				Page 87 of 131



	<u>Date(s) of Evaluation</u> Aug 20-30, Oct 4-10, 2012	<u>Test Report Serial No.</u> 081612ALH-T1191-S90V	<u>Test Report Revision No.</u> Rev. 1.0 (1st Release)	 Test Lab Certificate No. 2470.01
	<u>Test Report Issue Date</u> Oct. 22, 2012	<u>Description of Test(s)</u> Specific Absorption Rate	<u>RF Exposure Category</u> Occupational (Controlled)	

450 MHz Body

Celltech Labs Inc
Test Result for UIM Dielectric Parameter
21/Aug/2012
Freq Frequency(GHz)
FCC_eB FCC Limits for Body Epsilon
FCC_sB FCC Limits for Body Sigma
Test_e Epsilon of UIM
Test_s Sigma of UIM

Freq	FCC_eB	FCC_sB	Test_e	Test_s
0.3500	57.70	0.93	57.70	0.84
0.3600	57.60	0.93	56.84	0.84
0.3700	57.50	0.93	57.29	0.86
0.3800	57.40	0.93	57.10	0.87
0.3900	57.30	0.93	56.98	0.89
0.4000	57.20	0.93	56.68	0.88
0.4100	57.10	0.93	56.52	0.90
0.4200	57.00	0.94	57.24	0.91
0.4300	56.90	0.94	56.48	0.92
0.4400	56.80	0.94	56.63	0.92
0.4500	56.70	0.94	56.53	0.93
0.4600	56.66	0.94	56.03	0.94
0.4700	56.62	0.94	55.90	0.93
0.4800	56.58	0.94	55.82	0.94
0.4900	56.54	0.94	55.37	0.96
0.5000	56.51	0.94	55.46	0.96
0.5100	56.47	0.94	55.57	0.97
0.5200	56.43	0.95	55.33	0.99
0.5300	56.39	0.95	54.61	1.00
0.5400	56.35	0.95	55.30	1.00
0.5500	56.31	0.95	55.28	1.02

Applicant:	Kenwood USA Corporation	FCC ID:	ALH435001	IC ID:	282D-435001	KENWOOD
DUT Type:	Portable UHF PTT Radio Transceiver	Models:	TK-3402-K2-P	406.1 - 470.0 MHz		
2012 Celltech Labs Inc.		This document is not to be reproduced in whole or in part without the prior written permission of Celltech Labs Inc.				Page 88 of 131



	<u>Date(s) of Evaluation</u> Aug 20-30, Oct 4-10, 2012	<u>Test Report Serial No.</u> 081612ALH-T1191-S90V	<u>Test Report Revision No.</u> Rev. 1.0 (1st Release)	 Test Lab Certificate No. 2470.01
	<u>Test Report Issue Date</u> Oct. 22, 2012	<u>Description of Test(s)</u> Specific Absorption Rate	<u>RF Exposure Category</u> Occupational (Controlled)	

450 MHz Head

Celltech Labs Inc
 Test Result for UIM Dielectric Parameter
 22/Aug/2012
 Frequency(GHz)
 FCC_eHFCC OET 65 Supplement C (June 2001) Limits for Head Epsilon
 FCC_sHFCC OET 65 Supplement C (June 2001) Limits for Head Sigma
 Test_e Epsilon of UIM
 Test_s Sigma of UIM

Freq	FCC_eHFCC_sH	Test_e	Test_s
0.3500	44.70 0.87	45.34	0.76
0.3600	44.58 0.87	45.64	0.77
0.3700	44.46 0.87	45.43	0.76
0.3800	44.34 0.87	45.60	0.78
0.3900	44.22 0.87	44.47	0.80
0.4000	44.10 0.87	44.59	0.80
0.4100	43.98 0.87	44.44	0.80
0.4200	43.86 0.87	44.35	0.81
0.4300	43.74 0.87	44.34	0.81
0.4400	43.62 0.87	44.36	0.84
0.4500	43.50 0.87	43.62	0.83
0.4600	43.45 0.87	43.61	0.85
0.4700	43.40 0.87	43.21	0.85
0.4800	43.34 0.87	42.74	0.86
0.4900	43.29 0.87	42.99	0.86
0.5000	43.24 0.87	42.55	0.89
0.5100	43.19 0.87	42.41	0.88
0.5200	43.14 0.88	42.34	0.89
0.5300	43.08 0.88	42.16	0.91
0.5400	43.03 0.88	42.10	0.91
0.5500	42.98 0.88	42.15	0.92

Applicant:	Kenwood USA Corporation	FCC ID:	ALH435001	IC ID:	282D-435001	KENWOOD
DUT Type:	Portable UHF PTT Radio Transceiver	Models:	TK-3402-K2-P	406.1 - 470.0 MHz		
2012 Celltech Labs Inc.		This document is not to be reproduced in whole or in part without the prior written permission of Celltech Labs Inc.				Page 89 of 131



	<u>Date(s) of Evaluation</u> Aug 20-30, Oct 4-10, 2012	<u>Test Report Serial No.</u> 081612ALH-T1191-S90V	<u>Test Report Revision No.</u> Rev. 1.0 (1st Release)	 Test Lab Certificate No. 2470.01
	<u>Test Report Issue Date</u> Oct. 22, 2012	<u>Description of Test(s)</u> Specific Absorption Rate	<u>RF Exposure Category</u> Occupational (Controlled)	

450 MHz Head

Celltech Labs
Test Result for UIM Dielectric Parameter
28/Aug/2012
Frequency(GHz)
FCC_eHFCC OET 65 Supplement C (June 2001) Limits for Head Epsilon
FCC_sHFCC OET 65 Supplement C (June 2001) Limits for Head Sigma
Test_e Epsilon of UIM
Test_s Sigma of UIM

Freq	FCC_eHFCC_sH	Test_e	Test_s
0.3500	44.70 0.87	47.03	0.78
0.3600	44.58 0.87	45.87	0.79
0.3700	44.46 0.87	46.15	0.78
0.3800	44.34 0.87	45.83	0.79
0.3900	44.22 0.87	46.03	0.79
0.4000	44.10 0.87	45.13	0.81
0.4100	43.98 0.87	45.15	0.83
0.4200	43.86 0.87	45.11	0.83
0.4300	43.74 0.87	45.09	0.84
0.4400	43.62 0.87	44.75	0.85
0.4500	43.50 0.87	44.88	0.87
0.4600	43.45 0.87	43.90	0.86
0.4700	43.40 0.87	43.83	0.88
0.4800	43.34 0.87	44.45	0.88
0.4900	43.29 0.87	43.19	0.90
0.5000	43.24 0.87	43.56	0.90
0.5100	43.19 0.87	43.31	0.91
0.5200	43.14 0.88	43.15	0.93
0.5300	43.08 0.88	42.83	0.93
0.5400	43.03 0.88	42.87	0.95
0.5500	42.98 0.88	42.32	0.95

Applicant:	Kenwood USA Corporation	FCC ID:	ALH435001	IC ID:	282D-435001	KENWOOD
DUT Type:	Portable UHF PTT Radio Transceiver	Models:	TK-3402-K2-P	406.1 - 470.0 MHz		
2012 Celltech Labs Inc.		This document is not to be reproduced in whole or in part without the prior written permission of Celltech Labs Inc.				Page 90 of 131



	<u>Date(s) of Evaluation</u> Aug 20-30, Oct 4-10, 2012	<u>Test Report Serial No.</u> 081612ALH-T1191-S90V	<u>Test Report Revision No.</u> Rev. 1.0 (1st Release)	 Test Lab Certificate No. 2470.01
	<u>Test Report Issue Date</u> Oct. 22, 2012	<u>Description of Test(s)</u> Specific Absorption Rate	<u>RF Exposure Category</u> Occupational (Controlled)	

450 MHz Body

Celltech Labs Inc
Test Result for UIM Dielectric Parameter
28&29/Aug/2012
Frequency(GHz)
FCC_eB FCC Limits for Body Epsilon
FCC_sB FCC Limits for Body Sigma
Test_e Epsilon of UIM
Test_s Sigma of UIM

Freq	FCC_eB	FCC_sB	Test_e	Test_s
0.3500	57.70	0.93	57.73	0.84
0.3600	57.60	0.93	57.39	0.83
0.3700	57.50	0.93	56.75	0.84
0.3800	57.40	0.93	56.98	0.86
0.3900	57.30	0.93	56.79	0.85
0.4000	57.20	0.93	56.44	0.87
0.4100	57.10	0.93	56.32	0.88
0.4200	57.00	0.94	56.32	0.90
0.4300	56.90	0.94	56.28	0.91
0.4400	56.80	0.94	56.05	0.91
0.4500	56.70	0.94	55.87	0.93
0.4600	56.66	0.94	54.74	0.93
0.4700	56.62	0.94	55.43	0.93
0.4800	56.58	0.94	55.10	0.94
0.4900	56.54	0.94	54.08	0.94
0.5000	56.51	0.94	54.56	0.95
0.5100	56.47	0.94	54.54	0.96
0.5200	56.43	0.95	54.87	0.98
0.5300	56.39	0.95	54.88	0.99
0.5400	56.35	0.95	53.94	1.00
0.5500	56.31	0.95	54.32	1.00

Applicant:	Kenwood USA Corporation	FCC ID:	ALH435001	IC ID:	282D-435001	KENWOOD
DUT Type:	Portable UHF PTT Radio Transceiver	Models:	TK-3402-K2-P	406.1 - 470.0 MHz		
2012 Celltech Labs Inc.		This document is not to be reproduced in whole or in part without the prior written permission of Celltech Labs Inc.				Page 91 of 131



	<u>Date(s) of Evaluation</u> Aug 20-30, Oct 4-10, 2012	<u>Test Report Serial No.</u> 081612ALH-T1191-S90V	<u>Test Report Revision No.</u> Rev. 1.0 (1st Release)	 Test Lab Certificate No. 2470.01
	<u>Test Report Issue Date</u> Oct. 22, 2012	<u>Description of Test(s)</u> Specific Absorption Rate	<u>RF Exposure Category</u> Occupational (Controlled)	

450 MHz Body

Celltech Labs Inc
Test Result for UIM Dielectric Parameter
30/Aug/2012
Frequency(GHz)
FCC_eB FCC Limits for Body Epsilon
FCC_sB FCC Limits for Body Sigma
Test_e Epsilon of UIM
Test_s Sigma of UIM

Freq	FCC_eB	FCC_sB	Test_e	Test_s
0.3500	57.70	0.93	57.97	0.85
0.3600	57.60	0.93	57.87	0.87
0.3700	57.50	0.93	57.11	0.90
0.3800	57.40	0.93	57.40	0.89
0.3900	57.30	0.93	57.18	0.89
0.4000	57.20	0.93	56.21	0.90
0.4100	57.10	0.93	57.07	0.90
0.4200	57.00	0.94	56.58	0.91
0.4300	56.90	0.94	56.90	0.91
0.4400	56.80	0.94	56.17	0.92
0.4500	56.70	0.94	55.81	0.93
0.4600	56.66	0.94	56.48	0.95
0.4700	56.62	0.94	56.48	0.95
0.4800	56.58	0.94	55.94	0.97
0.4900	56.54	0.94	55.46	0.97
0.5000	56.51	0.94	55.65	0.97
0.5100	56.47	0.94	55.09	0.98
0.5200	56.43	0.95	55.07	1.00
0.5300	56.39	0.95	55.09	1.00
0.5400	56.35	0.95	55.29	1.03
0.5500	56.31	0.95	55.07	1.02

Applicant:	Kenwood USA Corporation	FCC ID:	ALH435001	IC ID:	282D-435001	KENWOOD
DUT Type:	Portable UHF PTT Radio Transceiver	Models:	TK-3402-K2-P	406.1 - 470.0 MHz		
2012 Celltech Labs Inc.		This document is not to be reproduced in whole or in part without the prior written permission of Celltech Labs Inc.				Page 92 of 131

	<u>Date(s) of Evaluation</u> Aug 20-30, Oct 4-10, 2012	<u>Test Report Serial No.</u> 081612ALH-T1191-S90V	<u>Test Report Revision No.</u> Rev. 1.0 (1st Release)	 Test Lab Certificate No. 2470.01
	<u>Test Report Issue Date</u> Oct. 22, 2012	<u>Description of Test(s)</u> Specific Absorption Rate	<u>RF Exposure Category</u> Occupational (Controlled)	

450 MHz Head



Celltech Labs Inc
Test Result for UIM Dielectric Parameter
04&05/Oct/2012
Frequency(GHz)

FCC_eHFCC OET 65 Supplement C (June 2001) Limits for Head Epsilon
FCC_sHFCC OET 65 Supplement C (June 2001) Limits for Head Sigma

Test_e Epsilon of UIM
Test_s Sigma of UIM

Freq	FCC_eHFCC_sH	Test_e	Test_s
0.3500	44.70 0.87	47.06	0.75
0.3600	44.58 0.87	47.31	0.76
0.3700	44.46 0.87	46.29	0.77
0.3800	44.34 0.87	46.45	0.79
0.3900	44.22 0.87	46.28	0.79
0.4000	44.10 0.87	45.49	0.81
0.4100	43.98 0.87	45.41	0.83
0.4200	43.86 0.87	45.74	0.85
0.4300	43.74 0.87	45.57	0.85
0.4400	43.62 0.87	45.18	0.85
0.4500	43.50 0.87	45.47	0.86
0.4600	43.45 0.87	44.80	0.87
0.4700	43.40 0.87	44.79	0.86
0.4800	43.34 0.87	44.49	0.89
0.4900	43.29 0.87	44.56	0.89
0.5000	43.24 0.87	44.34	0.88
0.5100	43.19 0.87	44.23	0.90
0.5200	43.14 0.88	43.95	0.92
0.5300	43.08 0.88	43.87	0.92
0.5400	43.03 0.88	43.56	0.93
0.5500	42.98 0.88	43.42	0.93

Applicant:	Kenwood USA Corporation	FCC ID:	ALH435001	IC ID:	282D-435001	KENWOOD
DUT Type:	Portable UHF PTT Radio Transceiver	Models:	TK-3402-K2-P	406.1 - 470.0 MHz		
2012 Celltech Labs Inc.		This document is not to be reproduced in whole or in part without the prior written permission of Celltech Labs Inc.				Page 93 of 131



	<u>Date(s) of Evaluation</u> Aug 20-30, Oct 4-10, 2012	<u>Test Report Serial No.</u> 081612ALH-T1191-S90V	<u>Test Report Revision No.</u> Rev. 1.0 (1st Release)	 Test Lab Certificate No. 2470.01
	<u>Test Report Issue Date</u> Oct. 22, 2012	<u>Description of Test(s)</u> Specific Absorption Rate	<u>RF Exposure Category</u> Occupational (Controlled)	

450 MHz Body

Celltech Labs Inc
Test Result for UIM Dielectric Parameter
09&10/Oct/2012
Frequency(GHz)
FCC_eB FCC Limits for Body Epsilon
FCC_sB FCC Limits for Body Sigma
Test_e Epsilon of UIM
Test_s Sigma of UIM

Freq	FCC_eB	FCC_sB	Test_e	Test_s
0.3500	57.70	0.93	58.64	0.81
0.3600	57.60	0.93	57.64	0.83
0.3700	57.50	0.93	58.32	0.84
0.3800	57.40	0.93	57.40	0.83
0.3900	57.30	0.93	57.28	0.84
0.4000	57.20	0.93	56.72	0.84
0.4100	57.10	0.93	56.58	0.87
0.4200	57.00	0.94	57.12	0.87
0.4300	56.90	0.94	56.47	0.89
0.4400	56.80	0.94	56.23	0.89
0.4500	56.70	0.94	56.91	0.91
0.4600	56.66	0.94	55.82	0.92
0.4700	56.62	0.94	55.67	0.92
0.4800	56.58	0.94	55.94	0.93
0.4900	56.54	0.94	55.61	0.93
0.5000	56.51	0.94	54.75	0.95
0.5100	56.47	0.94	55.24	0.94
0.5200	56.43	0.95	54.65	0.96
0.5300	56.39	0.95	54.78	0.97
0.5400	56.35	0.95	54.72	0.98
0.5500	56.31	0.95	54.96	0.99

Applicant:	Kenwood USA Corporation	FCC ID:	ALH435001	IC ID:	282D-435001	KENWOOD
DUT Type:	Portable UHF PTT Radio Transceiver	Models:	TK-3402-K2-P	406.1 - 470.0 MHz		
2012 Celltech Labs Inc.		This document is not to be reproduced in whole or in part without the prior written permission of Celltech Labs Inc.				Page 94 of 131

	<u>Date(s) of Evaluation</u> Aug 20-30, Oct 4-10, 2012	<u>Test Report Serial No.</u> 081612ALH-T1191-S90V	<u>Test Report Revision No.</u> Rev. 1.0 (1st Release)	 Test Lab Certificate No. 2470.01
	<u>Test Report Issue Date</u> Oct. 22, 2012	<u>Description of Test(s)</u> Specific Absorption Rate	<u>RF Exposure Category</u> Occupational (Controlled)	

APPENDIX E - DIPOLE CALIBRATION

Applicant:	Kenwood USA Corporation	FCC ID:	ALH435001	IC ID:	282D-435001	KENWOOD
DUT Type:	Portable UHF PTT Radio Transceiver	Models:	TK-3402-K2-P	406.1 - 470.0 MHz		
2012 Celltech Labs Inc.	This document is not to be reproduced in whole or in part without the prior written permission of Celltech Labs Inc.					Page 129 of 131



Accredited by the Swiss Accreditation Service (SAS)
The Swiss Accreditation Service is one of the signatories to the EA
Multilateral Agreement for the recognition of calibration certificates

Accreditation No.: **SCS 108**

Client **Celltech**

Certificate No: **D450V3-1068_Apr12**

CALIBRATION CERTIFICATE

Object **D450V3 - SN: 1068**

Calibration procedure(s) **QA CAL-15.v6
Calibration procedure for dipole validation kits below 700 MHz**

Calibration date: **April 27, 2012**

This calibration certificate documents the traceability to national standards, which realize the physical units of measurements (SI).
The measurements and the uncertainties with confidence probability are given on the following pages and are part of the certificate.

All calibrations have been conducted in the closed laboratory facility: environment temperature (22 ± 3)°C and humidity < 70%.

Calibration Equipment used (M&TE critical for calibration)

Primary Standards	ID #	Cal Date (Certificate No.)	Scheduled Calibration
Power meter E4419B	GB41293874	29-Mar-12 (No. 217-01508)	Apr-13
Power sensor E4412A	MY41498087	29-Mar-12 (No. 217-01508)	Apr-13
Reference 3 dB Attenuator	SN: S5054 (3c)	27-Mar-12 (No. 217-01531)	Apr-13
Reference 20 dB Attenuator	SN: S5086 (20b)	27-Mar-12 (No. 217-01529)	Apr-13
Type-N mismatch combination	SN: 5047.2 / 06327	27-Mar-12 (No. 217-01533)	Apr-13
Reference Probe ET3DV6	SN: 1507	30-Dec-11 (No. ET3-1507_Dec11)	Dec-12
DAE4	SN: 654	03-May-11 (No. DAE4-654_May11)	May-12

Secondary Standards	ID #	Check Date (in house)	Scheduled Check
Power sensor HP 8481A	MY41092317	18-Oct-02 (in house check Oct-11)	In house check: Oct-13
RF generator R&S SMT-06	100005	04-Aug-99 (in house check Oct-11)	In house check: Oct-13
Network Analyzer HP 8753E	US37390585 S4206	18-Oct-01 (in house check Oct-11)	In house check: Oct-12

	Name	Function	Signature
Calibrated by:	Jeton Kastrati	Laboratory Technician	
Approved by:	Katja Pokovic	Technical Manager	

Approved by: **Katja Pokovic** Technical Manager

Issued: April 27, 2012

This calibration certificate shall not be reproduced except in full without written approval of the laboratory.



Accredited by the Swiss Accreditation Service (SAS)
The Swiss Accreditation Service is one of the signatories to the EA
Multilateral Agreement for the recognition of calibration certificates

Glossary:

TSL	tissue simulating liquid
ConvF	sensitivity in TSL / NORM x,y,z
N/A	not applicable or not measured

Calibration is Performed According to the Following Standards:

- IEEE Std 1528-2003, "IEEE Recommended Practice for Determining the Peak Spatial-Averaged Specific Absorption Rate (SAR) in the Human Head from Wireless Communications Devices: Measurement Techniques", December 2003
- IEC 62209-1, "Procedure to measure the Specific Absorption Rate (SAR) for hand-held devices used in close proximity to the ear (frequency range of 300 MHz to 3 GHz)", February 2005
- Federal Communications Commission Office of Engineering & Technology (FCC OET), "Evaluating Compliance with FCC Guidelines for Human Exposure to Radiofrequency Electromagnetic Fields; Additional Information for Evaluating Compliance of Mobile and Portable Devices with FCC Limits for Human Exposure to Radiofrequency Emissions", Supplement C (Edition 01-01) to Bulletin 65

Additional Documentation:

- DASY4/5 System Handbook

Methods Applied and Interpretation of Parameters:

- Measurement Conditions:** Further details are available from the Validation Report at the end of the certificate. All figures stated in the certificate are valid at the frequency indicated.
- Antenna Parameters with TSL:** The dipole is mounted with the spacer to position its feed point exactly below the center marking of the flat phantom section, with the arms oriented parallel to the body axis.
- Feed Point Impedance and Return Loss:** These parameters are measured with the dipole positioned under the liquid filled phantom. The impedance stated is transformed from the measurement at the SMA connector to the feed point. The Return Loss ensures low reflected power. No uncertainty required.
- Electrical Delay:** One-way delay between the SMA connector and the antenna feed point. No uncertainty required.
- SAR measured:** SAR measured at the stated antenna input power.
- SAR normalized:** SAR as measured, normalized to an input power of 1 W at the antenna connector.
- SAR for nominal TSL parameters:** The measured TSL parameters are used to calculate the nominal SAR result.

The reported uncertainty of measurement is stated as the standard uncertainty of measurement multiplied by the coverage factor $k=2$, which for a normal distribution corresponds to a coverage probability of approximately 95%.

Measurement Conditions

DASY system configuration, as far as not given on page 1.

DASY Version	DASY5	V52.8.1
Extrapolation	Advanced Extrapolation	
Phantom	ELI4 Flat Phantom	Shell thickness: 2 ± 0.2 mm
Distance Dipole Center - TSL	15 mm	with Spacer
Zoom Scan Resolution	dx, dy, dz = 5 mm	
Frequency	450 MHz \pm 1 MHz	

Head TSL parameters

The following parameters and calculations were applied.

	Temperature	Permittivity	Conductivity
Nominal Head TSL parameters	22.0 °C	43.5	0.87 mho/m
Measured Head TSL parameters	(22.0 \pm 0.2) °C	44.1 \pm 6 %	0.87 mho/m \pm 6 %
Head TSL temperature change during test	< 0.5 °C	----	----

SAR result with Head TSL

SAR averaged over 1 cm³ (1 g) of Head TSL	Condition	
SAR measured	398 mW input power	1.87 mW / g
SAR for nominal Head TSL parameters	normalized to 1W	4.71 mW / g \pm 18.1 % (k=2)

SAR averaged over 10 cm³ (10 g) of Head TSL	condition	
SAR measured	398 mW input power	1.25 mW / g
SAR for nominal Head TSL parameters	normalized to 1W	3.15 mW / g \pm 17.6 % (k=2)

Body TSL parameters

The following parameters and calculations were applied.

	Temperature	Permittivity	Conductivity
Nominal Body TSL parameters	22.0 °C	56.7	0.94 mho/m
Measured Body TSL parameters	(22.0 \pm 0.2) °C	54.9 \pm 6 %	0.94 mho/m \pm 6 %
Body TSL temperature change during test	< 0.5 °C	----	----

SAR result with Body TSL

SAR averaged over 1 cm³ (1 g) of Body TSL	Condition	
SAR measured	398 mW input power	1.81 mW / g
SAR for nominal Body TSL parameters	normalized to 1W	4.52 mW / g \pm 18.1 % (k=2)

SAR averaged over 10 cm³ (10 g) of Body TSL	condition	
SAR measured	398 mW input power	1.21 mW / g
SAR for nominal Body TSL parameters	normalized to 1W	3.02 mW / g \pm 17.6 % (k=2)

Appendix

Antenna Parameters with Head TSL

Impedance, transformed to feed point	57.7 Ω - 4.7 j Ω
Return Loss	- 21.6 dB

Antenna Parameters with Body TSL

Impedance, transformed to feed point	54.6 Ω - 8.1 j Ω
Return Loss	- 21.0 dB

General Antenna Parameters and Design

Electrical Delay (one direction)	1.755 ns
----------------------------------	----------

After long term use with 100W radiated power, only a slight warming of the dipole near the feedpoint can be measured.

The dipole is made of standard semirigid coaxial cable. The center conductor of the feeding line is directly connected to the second arm of the dipole. The antenna is therefore short-circuited for DC-signals. On some of the dipoles, small end caps are added to the dipole arms in order to improve matching when loaded according to the position as explained in the "Measurement Conditions" paragraph. The SAR data are not affected by this change. The overall dipole length is still according to the Standard.

No excessive force must be applied to the dipole arms, because they might bend or the soldered connections near the feedpoint may be damaged.

Additional EUT Data

Manufactured by	SPEAG .
Manufactured on	July 16, 2009

DASY5 Validation Report for Head TSL

Date: 27.04.2012

Test Laboratory: SPEAG

DUT: Dipole 450 MHz; Type: D450V3; Serial: D450V3 - SN: 1068

Communication System: CW; Frequency: 450 MHz

Medium parameters used: $f = 450$ MHz; $\sigma = 0.87$ mho/m; $\epsilon_r = 44.1$; $\rho = 1000$ kg/m³

Phantom section: Flat Section

Measurement Standard: DASY5 (IEEE/IEC/ANSI C63.19-2007)

DASY52 Configuration:

- Probe: ET3DV6 - SN1507; ConvF(6.59, 6.59, 6.59); Calibrated: 30.12.2011;
- Sensor-Surface: 4mm (Mechanical Surface Detection)
- Electronics: DAE4 Sn654; Calibrated: 18.04.2012
- Phantom: ELI 4.0; Type: QDOVA001BA; Serial: 1003
- DASY52 52.8.1(838); SEMCAD X 14.6.5(6469)

Dipole Calibration for Head Tissue/d=15mm, Pin=398mW/Zoom Scan (7x7x7)/Cube 0:

Measurement grid: dx=5mm, dy=5mm, dz=5mm

Reference Value = 49.745 V/m; Power Drift = -0.01 dB

Peak SAR (extrapolated) = 2.835 mW/g

SAR(1 g) = 1.87 mW/g; SAR(10 g) = 1.25 mW/g

Maximum value of SAR (measured) = 2.00 mW/g

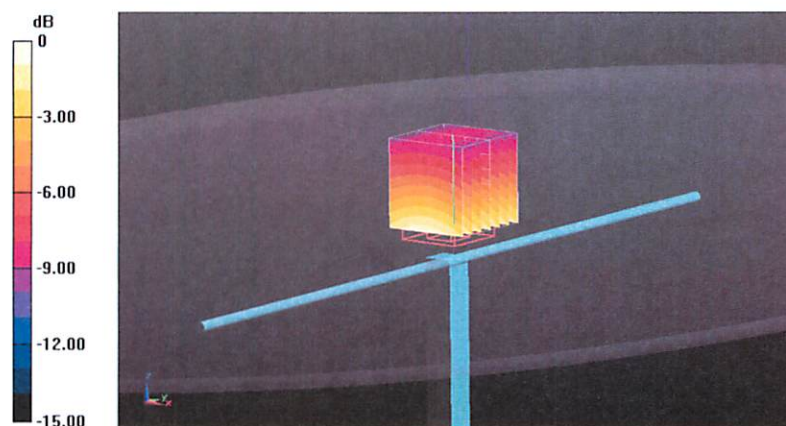

0 dB = 2.00 mW/g = 6.02 dB mW/g

Impedance Measurement Plot for Head TSL

27 Apr 2012 11:05:00
[CH1] S11 1 U FS 1: 57.676 Ω -4.7266 Ω 74.828 pF 450.000 000 MHz

*
De l
Cor

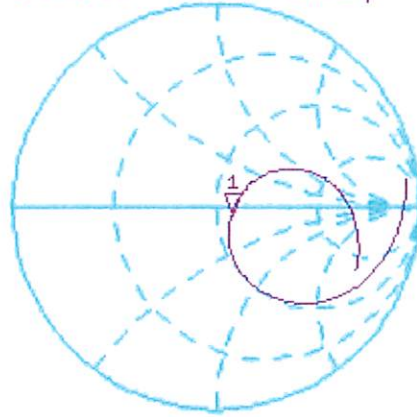

Avg
16

H1 d

CH2 S11 LOG 5 dB/REF -20 dB 1:-21.550 dB 450.000 000 MHz

Cor

Avg
16

H1 d

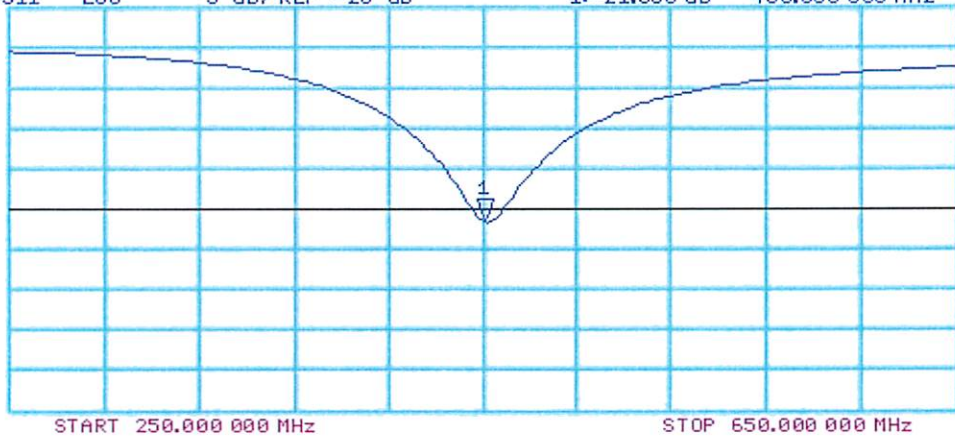

DASY5 Validation Report for Body TSL

Date: 27.04.2012

Test Laboratory: SPEAG

DUT: Dipole 450 MHz; Type: D450V3; Serial: D450V3 - SN: 1068

Communication System: CW; Frequency: 450 MHz

Medium parameters used: $f = 450$ MHz; $\sigma = 0.94$ mho/m; $\epsilon_r = 54.9$; $\rho = 1000$ kg/m³

Phantom section: Flat Section

Measurement Standard: DASY5 (IEEE/IEC/ANSI C63.19-2007)

DASY52 Configuration:

- Probe: ET3DV6 - SN1507; ConvF(7.05, 7.05, 7.05); Calibrated: 30.12.2011;
- Sensor-Surface: 4mm (Mechanical Surface Detection)
- Electronics: DAE4 Sn654; Calibrated: 18.04.2012
- Phantom: ELI 4.0; Type: QDOVA001BA; Serial: 1003
- DASY52 52.8.1(838); SEMCAD X 14.6.5(6469)

Dipole Calibration for Body Tissue/d=15mm, Pin=398mW/Zoom Scan (7x7x7)/Cube 0:

Measurement grid: dx=5mm, dy=5mm, dz=5mm

Reference Value = 46.572 V/m; Power Drift = -0.02 dB

Peak SAR (extrapolated) = 2.834 mW/g

SAR(1 g) = 1.81 mW/g; SAR(10 g) = 1.21 mW/g

Maximum value of SAR (measured) = 1.94 mW/g

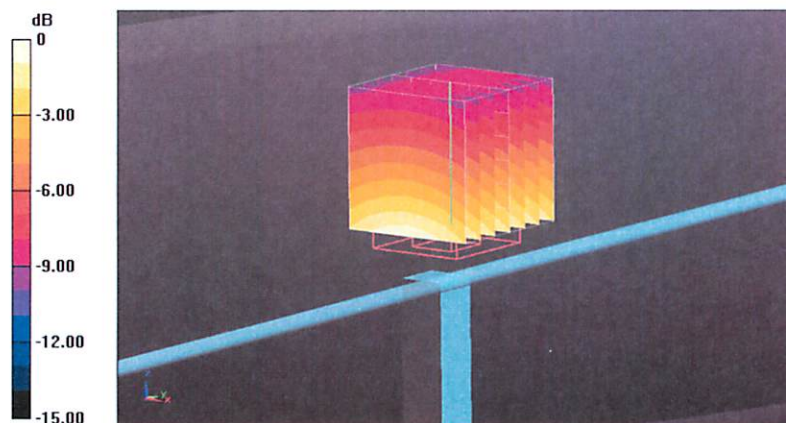

Impedance Measurement Plot for Body TSL

27 Apr 2012 10:46:42
[CH1] S11 1 U FS 1: 54.635 Ω -8.0625 Ω 43.867 pF 450.000 000 MHz

*
De1
Cor

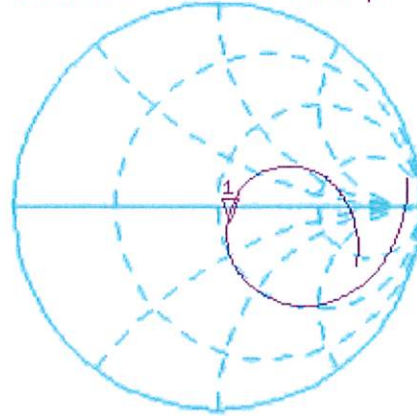

Avg
16

H1 d



CH2 S11 LOG 5 dB/REF -20 dB 1:-21.047 dB 450.000 000 MHz

Cor

Avg
16

H1 d



	<u>Date(s) of Evaluation</u> Aug 20-30, Oct 4-10, 2012	<u>Test Report Serial No.</u> 081612ALH-T1191-S90V	<u>Test Report Revision No.</u> Rev. 1.0 (1st Release)	 Test Lab Certificate No. 2470.01
	<u>Test Report Issue Date</u> Oct. 22, 2012	<u>Description of Test(s)</u> Specific Absorption Rate	<u>RF Exposure Category</u> Occupational (Controlled)	

APPENDIX F - PROBE CALIBRATION

Applicant:	Kenwood USA Corporation	FCC ID:	ALH435001	IC ID:	282D-435001	KENWOOD
DUT Type:	Portable UHF PTT Radio Transceiver	Models:	TK-3402-K2-P	406.1 - 470.0 MHz		
2012 Celltech Labs Inc.	This document is not to be reproduced in whole or in part without the prior written permission of Celltech Labs Inc.					Page 130 of 131



Accredited by the Swiss Accreditation Service (SAS)
The Swiss Accreditation Service is one of the signatories to the EA
Multilateral Agreement for the recognition of calibration certificates

Accreditation No.: **SCS 108**

Client **Celltech**

Certificate No: **ET3-1590_Apr12**

CALIBRATION CERTIFICATE

Object **ET3DV6 - SN:1590**

Calibration procedure(s) **QA CAL-01.v8, QA CAL-12.v7, QA CAL-23.v4, QA CAL-25.v4
Calibration procedure for dosimetric E-field probes**

Calibration date: **April 24, 2012**

This calibration certificate documents the traceability to national standards, which realize the physical units of measurements (SI).
The measurements and the uncertainties with confidence probability are given on the following pages and are part of the certificate.

All calibrations have been conducted in the closed laboratory facility: environment temperature $(22 \pm 3)^\circ\text{C}$ and humidity $< 70\%$.

Calibration Equipment used (M&TE critical for calibration)

Primary Standards	ID	Cal Date (Certificate No.)	Scheduled Calibration
Power meter E4419B	GB41293874	29-Mar-12 (No. 217-01508)	Apr-13
Power sensor E4412A	MY41498087	29-Mar-12 (No. 217-01508)	Apr-13
Reference 3 dB Attenuator	SN: S5054 (3c)	27-Mar-12 (No. 217-01531)	Apr-13
Reference 20 dB Attenuator	SN: S5086 (20b)	27-Mar-12 (No. 217-01529)	Apr-13
Reference 30 dB Attenuator	SN: S5129 (30b)	27-Mar-12 (No. 217-01532)	Apr-13
Reference Probe ES3DV2	SN: 3013	29-Dec-11 (No. ES3-3013_Dec11)	Dec-12
DAE4	SN: 660	10-Jan-12 (No. DAE4-660_Jan12)	Jan-13
Secondary Standards	ID	Check Date (in house)	Scheduled Check
RF generator HP 8648C	US3642U01700	4-Aug-99 (in house check Apr-11)	In house check: Apr-13
Network Analyzer HP 8753E	US37390585	18-Oct-01 (in house check Oct-11)	In house check: Oct-12

	Name	Function	Signature
Calibrated by:	Jeton Kastrati	Laboratory Technician	
Approved by:	Katja Pokovic	Technical Manager	
			Issued: April 26, 2012
This calibration certificate shall not be reproduced except in full without written approval of the laboratory.			



Accredited by the Swiss Accreditation Service (SAS)
The Swiss Accreditation Service is one of the signatories to the EA
Multilateral Agreement for the recognition of calibration certificates

Accreditation No.: **SCS 108**

Glossary:

TSL	tissue simulating liquid
NORM _{x,y,z}	sensitivity in free space
ConvF	sensitivity in TSL / NORM _{x,y,z}
DCP	diode compression point
CF	crest factor (1/duty_cycle) of the RF signal
A, B, C	modulation dependent linearization parameters
Polarization φ	φ rotation around probe axis
Polarization ϑ	ϑ rotation around an axis that is in the plane normal to probe axis (at measurement center), i.e., $\vartheta = 0$ is normal to probe axis

Calibration is Performed According to the Following Standards:

- IEEE Std 1528-2003, "IEEE Recommended Practice for Determining the Peak Spatial-Averaged Specific Absorption Rate (SAR) in the Human Head from Wireless Communications Devices: Measurement Techniques", December 2003
- IEC 62209-1, "Procedure to measure the Specific Absorption Rate (SAR) for hand-held devices used in close proximity to the ear (frequency range of 300 MHz to 3 GHz)", February 2005

Methods Applied and Interpretation of Parameters:

- NORM_{x,y,z}**: Assessed for E-field polarization $\vartheta = 0$ ($f \leq 900$ MHz in TEM-cell; $f > 1800$ MHz: R22 waveguide). NORM_{x,y,z} are only intermediate values, i.e., the uncertainties of NORM_{x,y,z} does not affect the E²-field uncertainty inside TSL (see below *ConvF*).
- NORM(f)_{x,y,z}** = NORM_{x,y,z} * *frequency_response* (see Frequency Response Chart). This linearization is implemented in DASY4 software versions later than 4.2. The uncertainty of the frequency response is included in the stated uncertainty of *ConvF*.
- DCP_{x,y,z}**: DCP are numerical linearization parameters assessed based on the data of power sweep with CW signal (no uncertainty required). DCP does not depend on frequency nor media.
- PAR**: PAR is the Peak to Average Ratio that is not calibrated but determined based on the signal characteristics
- A_{x,y,z}; B_{x,y,z}; C_{x,y,z}; VR_{x,y,z}; A, B, C** are numerical linearization parameters assessed based on the data of power sweep for specific modulation signal. The parameters do not depend on frequency nor media. VR is the maximum calibration range expressed in RMS voltage across the diode.
- ConvF and Boundary Effect Parameters**: Assessed in flat phantom using E-field (or Temperature Transfer Standard for $f \leq 800$ MHz) and inside waveguide using analytical field distributions based on power measurements for $f > 800$ MHz. The same setups are used for assessment of the parameters applied for boundary compensation (alpha, depth) of which typical uncertainty values are given. These parameters are used in DASY4 software to improve probe accuracy close to the boundary. The sensitivity in TSL corresponds to NORM_{x,y,z} * *ConvF* whereby the uncertainty corresponds to that given for *ConvF*. A frequency dependent *ConvF* is used in DASY version 4.4 and higher which allows extending the validity from ± 50 MHz to ± 100 MHz.
- Spherical isotropy (3D deviation from isotropy)**: in a field of low gradients realized using a flat phantom exposed by a patch antenna.
- Sensor Offset**: The sensor offset corresponds to the offset of virtual measurement center from the probe tip (on probe axis). No tolerance required.

Probe ET3DV6

SN:1590

Manufactured: March 19, 2001
Calibrated: April 24, 2012

Calibrated for DASY/EASY Systems
(Note: non-compatible with DASY2 system!)

DASY/EASY - Parameters of Probe: ET3DV6 - SN:1590

Basic Calibration Parameters

	Sensor X	Sensor Y	Sensor Z	Unc (k=2)
Norm ($\mu\text{V}/(\text{V}/\text{m})^2$) ^A	1.79	1.92	1.60	± 10.1 %
DCP (mV) ^B	94.8	98.4	88.8	

Modulation Calibration Parameters

UID	Communication System Name	PAR		A dB	B dB	C dB	VR mV	Unc ^E (k=2)
0	CW	0.00	X	0.00	0.00	1.00	143.4	±4.6 %
			Y	0.00	0.00	1.00	150.1	
			Z	0.00	0.00	1.00	179.4	

The reported uncertainty of measurement is stated as the standard uncertainty of measurement multiplied by the coverage factor k=2, which for a normal distribution corresponds to a coverage probability of approximately 95%.

^A The uncertainties of NormX,Y,Z do not affect the E²-field uncertainty inside TSL (see Pages 5 and 6).

^B Numerical linearization parameter: uncertainty not required.

^E Uncertainty is determined using the max. deviation from linear response applying rectangular distribution and is expressed for the square of the field value.

DASY/EASY - Parameters of Probe: ET3DV6 - SN:1590

Calibration Parameter Determined in Head Tissue Simulating Media

f (MHz) ^C	Relative Permittivity ^F	Conductivity (S/m) ^F	ConvF X	ConvF Y	ConvF Z	Alpha	Depth (mm)	Unct. (k=2)
450	43.5	0.87	7.54	7.54	7.54	0.20	2.16	± 13.4 %
750	41.9	0.89	7.11	7.11	7.11	0.29	3.00	± 12.0 %
835	41.5	0.90	6.77	6.77	6.77	0.27	3.00	± 12.0 %
900	41.5	0.97	6.67	6.67	6.67	0.29	3.00	± 12.0 %

^C Frequency validity of ± 100 MHz only applies for DASY v4.4 and higher (see Page 2), else it is restricted to ± 50 MHz. The uncertainty is the RSS of the ConvF uncertainty at calibration frequency and the uncertainty for the indicated frequency band.

^F At frequencies below 3 GHz, the validity of tissue parameters (ϵ and σ) can be relaxed to ± 10% if liquid compensation formula is applied to measured SAR values. At frequencies above 3 GHz, the validity of tissue parameters (ϵ and σ) is restricted to ± 5%. The uncertainty is the RSS of the ConvF uncertainty for indicated target tissue parameters.

DASY/EASY - Parameters of Probe: ET3DV6 - SN:1590

Calibration Parameter Determined in Body Tissue Simulating Media

f (MHz) ^C	Relative Permittivity ^F	Conductivity (S/m) ^F	ConvF X	ConvF Y	ConvF Z	Alpha	Depth (mm)	Unct. (k=2)
450	56.7	0.94	7.93	7.93	7.93	0.12	2.07	± 13.4 %
750	55.5	0.96	6.71	6.71	6.71	0.22	3.00	± 12.0 %
835	55.2	0.97	6.54	6.54	6.54	0.27	3.00	± 12.0 %
900	55.0	1.05	6.51	6.51	6.51	0.29	2.92	± 12.0 %

^C Frequency validity of ± 100 MHz only applies for DASY v4.4 and higher (see Page 2), else it is restricted to ± 50 MHz. The uncertainty is the RSS of the ConvF uncertainty at calibration frequency and the uncertainty for the indicated frequency band.

^F At frequencies below 3 GHz, the validity of tissue parameters (ϵ and σ) can be relaxed to ± 10% if liquid compensation formula is applied to measured SAR values. At frequencies above 3 GHz, the validity of tissue parameters (ϵ and σ) is restricted to ± 5%. The uncertainty is the RSS of the ConvF uncertainty for indicated target tissue parameters.

Frequency Response of E-Field

(TEM-Cell:ifi110 EXX, Waveguide: R22)

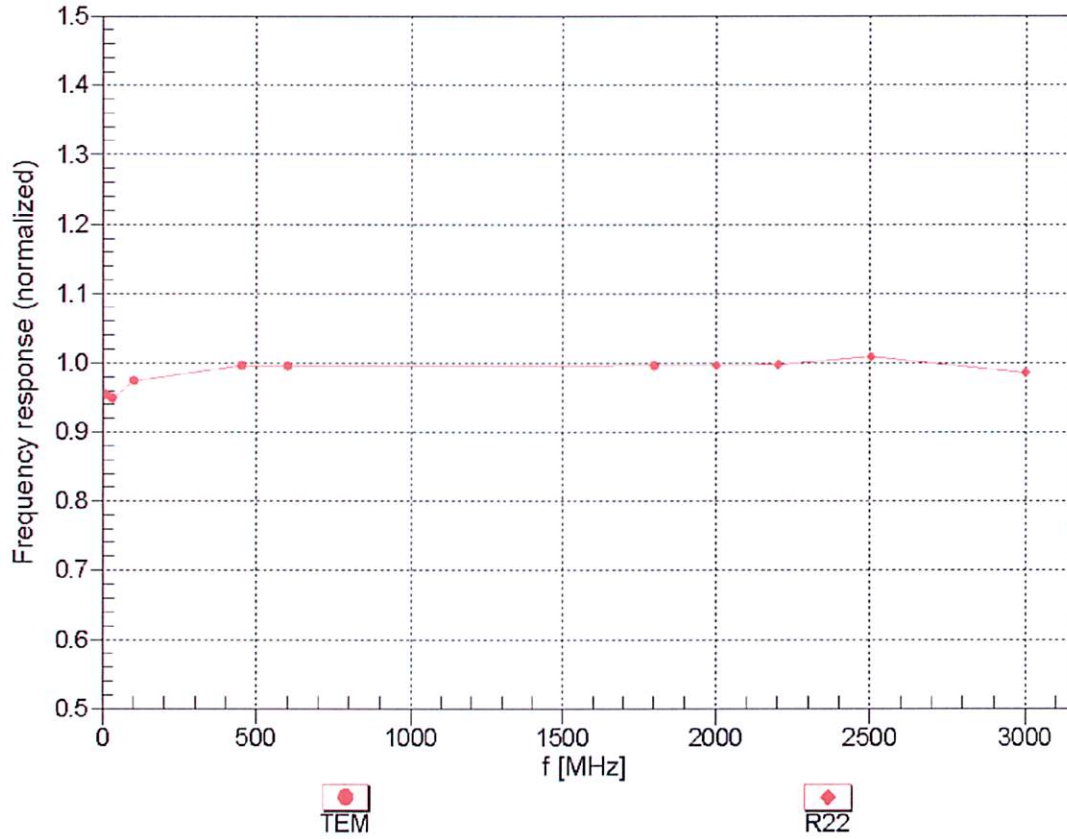

Uncertainty of Frequency Response of E-field: $\pm 6.3\%$ (k=2)

Receiving Pattern (ϕ), $\theta = 0^\circ$

f=600 MHz,TEM

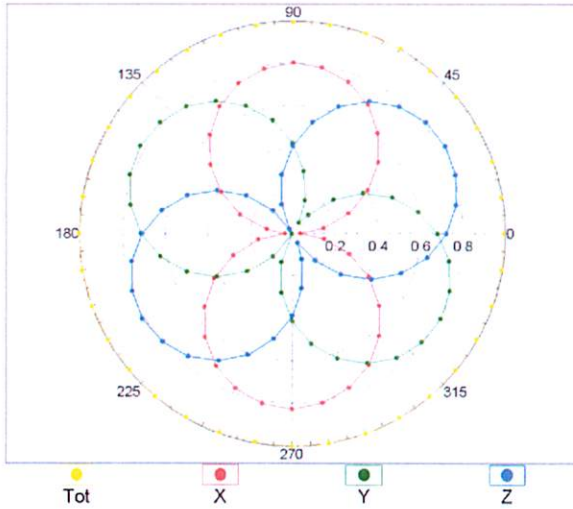

f=1800 MHz,R22

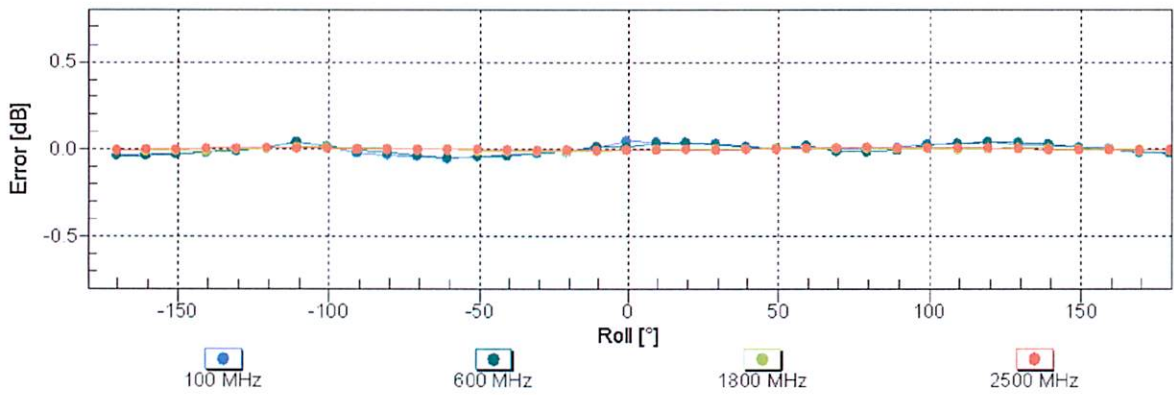
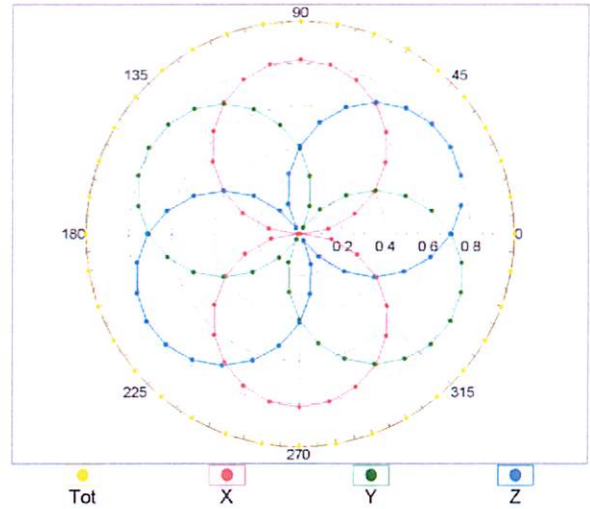

Uncertainty of Axial Isotropy Assessment: $\pm 0.5\%$ (k=2)

Dynamic Range $f(\text{SAR}_{\text{head}})$ (TEM cell , $f = 900 \text{ MHz}$)

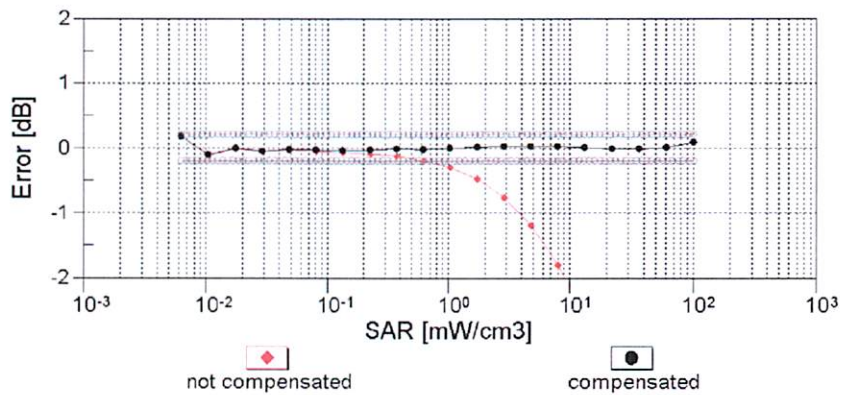
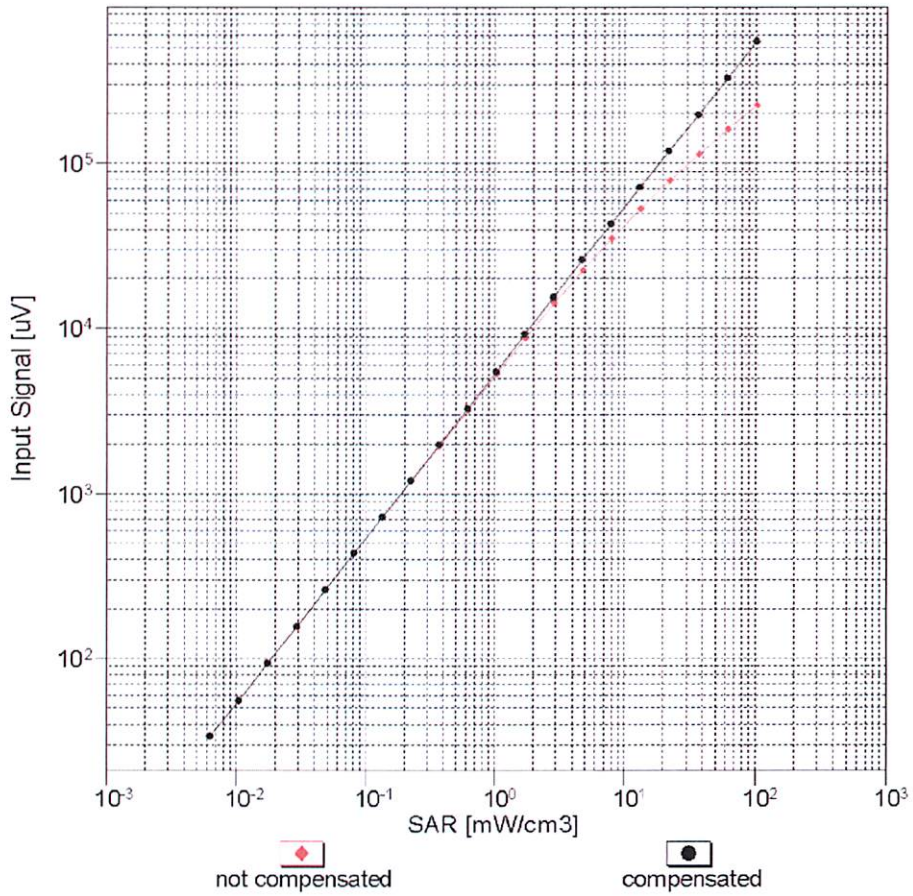

Uncertainty of Linearity Assessment: $\pm 0.6\%$ ($k=2$)

Conversion Factor Assessment

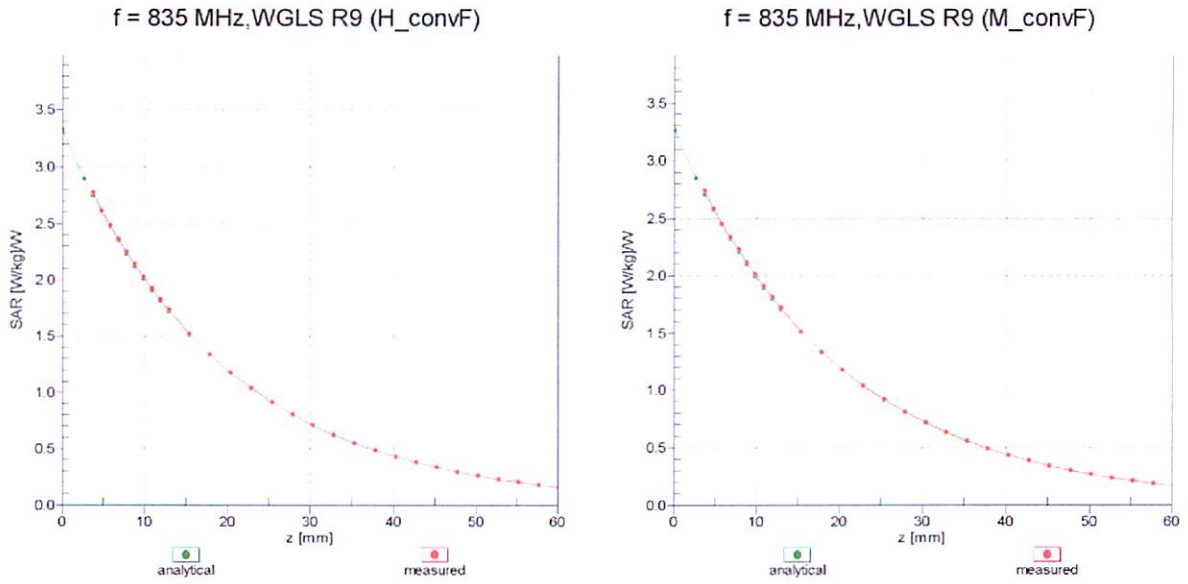

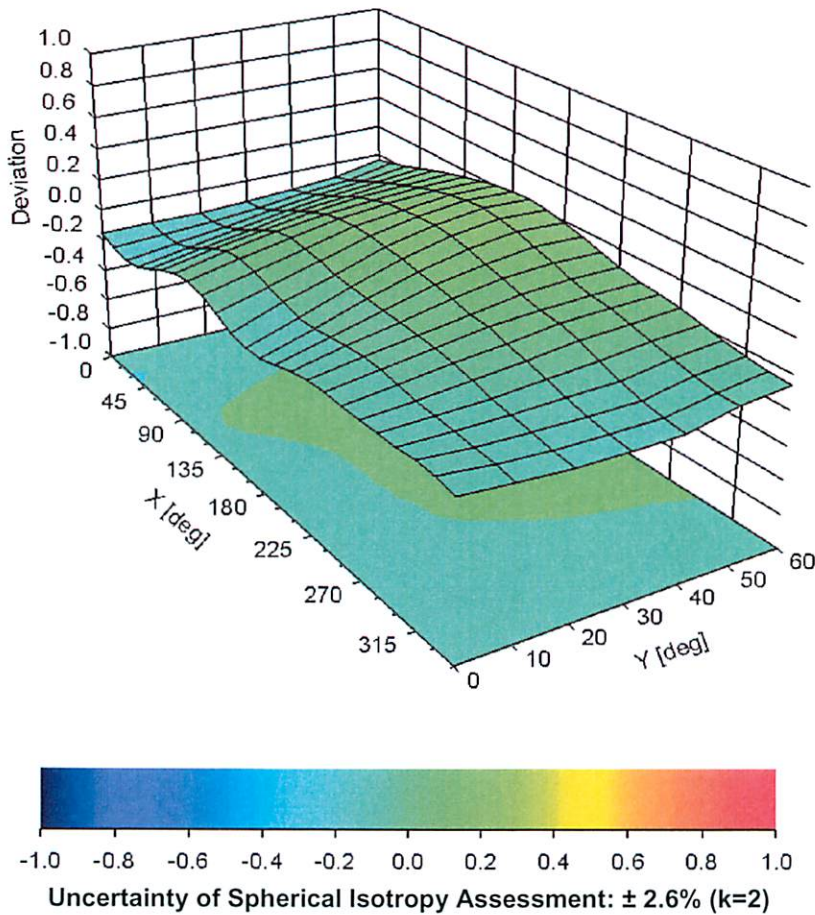

Deviation from Isotropy in Liquid Error (ϕ, ϑ), f = 900 MHz



DASY/EASY - Parameters of Probe: ET3DV6 - SN:1590**Other Probe Parameters**

Sensor Arrangement	Triangular
Connector Angle (°)	-170.8
Mechanical Surface Detection Mode	enabled
Optical Surface Detection Mode	enabled
Probe Overall Length	337 mm
Probe Body Diameter	10 mm
Tip Length	10 mm
Tip Diameter	6.8 mm
Probe Tip to Sensor X Calibration Point	2.7 mm
Probe Tip to Sensor Y Calibration Point	2.7 mm
Probe Tip to Sensor Z Calibration Point	2.7 mm
Recommended Measurement Distance from Surface	4 mm

	<u>Date(s) of Evaluation</u> Aug 20-30, Oct 4-10, 2012	<u>Test Report Serial No.</u> 081612ALH-T1191-S90V	<u>Test Report Revision No.</u> Rev. 1.0 (1st Release)	 Test Lab Certificate No. 2470.01
	<u>Test Report Issue Date</u> Oct. 22, 2012	<u>Description of Test(s)</u> Specific Absorption Rate	<u>RF Exposure Category</u> Occupational (Controlled)	

APPENDIX G - BARSKI PLANAR PHANTOM CERTIFICATE OF CONFORMITY

Applicant:	Kenwood USA Corporation	FCC ID:	ALH435001	IC ID:	282D-435001	KENWOOD
DUT Type:	Portable UHF PTT Radio Transceiver	Models:	TK-3402-K2-P	406.1 - 470.0 MHz		
2012 Celltech Labs Inc.	This document is not to be reproduced in whole or in part without the prior written permission of Celltech Labs Inc.					Page 131 of 131

2378 Westlake Road
Kelowna, B.C. Canada
V1Z-2V2

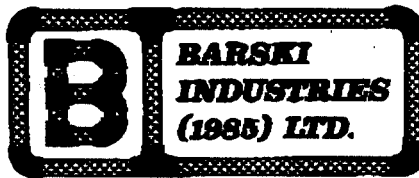

Ph. # 250-769-6848
Fax # 250-769-6334
E-mail: barskiind@shaw.ca
Web: www.bcfiberglass.com

FIBERGLASS FABRICATORS

Certificate of Conformity

Item : Flat Planar Phantom Unit # 03-01
Date: June 16, 2003
Manufacturer: Barski Industries (1985 Ltd)

Test	Requirement	Details
Shape	Compliance to geometry according to drawing	Supplied CAD drawing
Material Thickness	Compliant with the requirements	2mm +/- 0.2mm in measurement area
Material Parameters	Dielectric parameters for required frequencies Based on Dow Chemical technical data	100 MHz-5 GHz Relative permittivity<5 Loss Tangent<0.05

Conformity

Based on the above information, we certify this product to be compliant to the requirements specified.

Signature: _____

A handwritten signature in black ink, appearing to read 'Daniel Chailier', is written over a horizontal line.

Daniel Chailier



Fiberglass Planar Phantom - Top View



Fiberglass Planar Phantom - Front View



Fiberglass Planar Phantom - Back View



Fiberglass Planar Phantom - Bottom View

Dimensions of Fiberglass Planar Phantom

(Manufactured by Barski Industries Ltd. - Unit# 03-01)

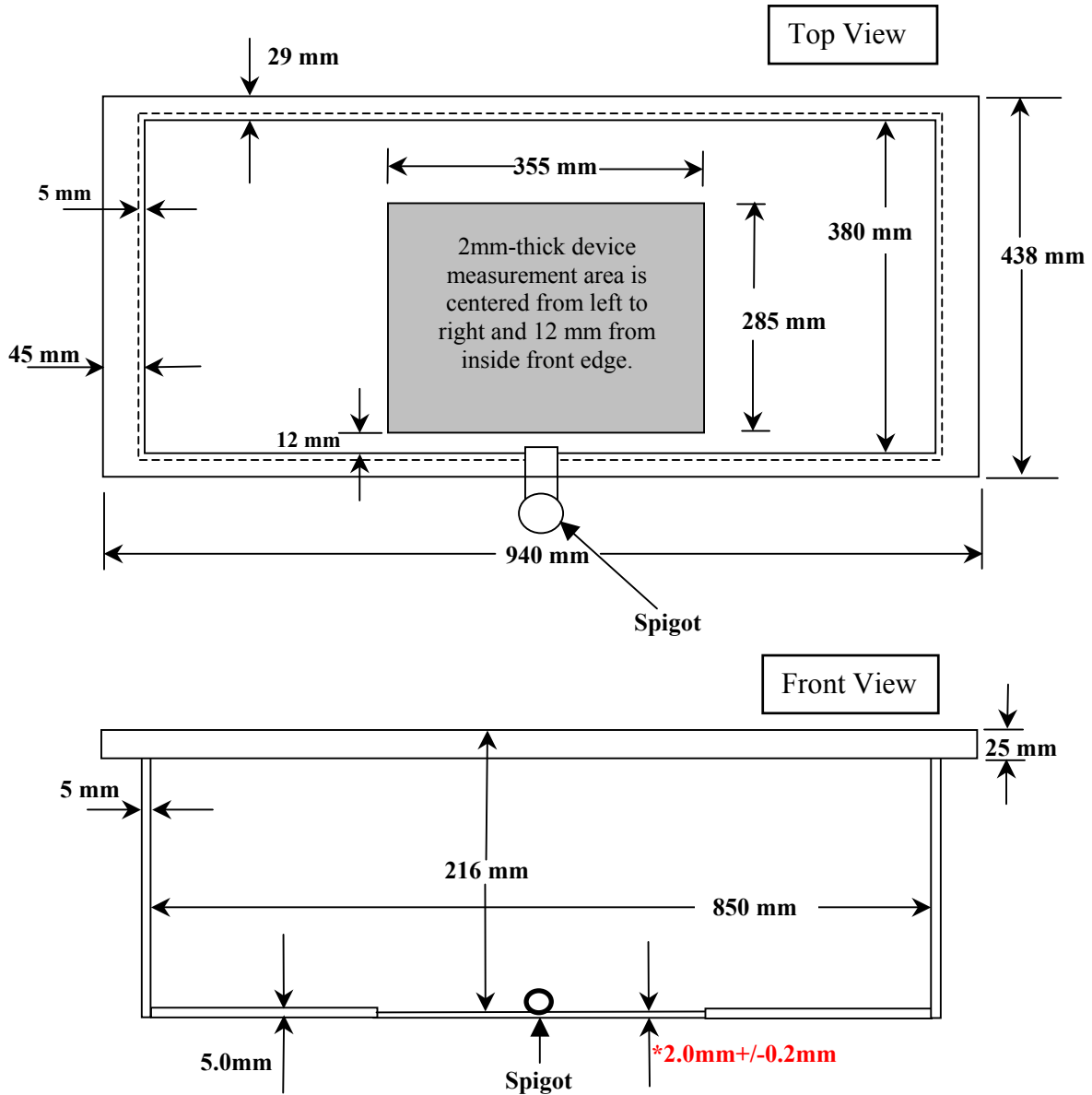

**Note: Measurements that aren't repeated for the opposite sides are the same as the side measured.
This drawing is not to scale.**