



Flom Test Labs

EMI, EMC, RF Testing Experts Since 1963

toll-free: (866) 311-3268
fax: (480) 926-3598
<http://www.flomlabs.com>
info@flomlabs.com

Date: October 27, 2008

Applicant: Kenwood USA Corporation
Communications Division
3970 Johns Creek Court, Suite 100
Suwanee, GA 30024

Attention of: Joel E. Berger, Research & Development
JBerger@kenwoodusa.com
(678) 474-4722; FAX: -4731

Equipment: TK-3302-2
FCC ID: ALH413601
FCC Rules: 22, 74, 90, 90.210

Gentlemen:

Enclosed please find your copy of the Engineering Test Report for which you are subject to the restrictions as listed on the attached summary.

As you know, the FCC, after a TCB issues a Grant, still has 30 days to review a submission and request added information. It is your decision whether or not to market the equipment subject to a possible recall before the end of the 30 days.

If your equipment is still retained by us, it will be returned to you 30 days after approval is achieved. Our invoice for services has been directed to your Accounts Payable Department.

Should you need any clarification, just fax or phone. Thank you again for this order - it has been a pleasure to be of service.

Sincerely yours,

Hoosamuddin S. Bandukwala, Lab Director



Flom Test Labs
EMI, EMC, RF Testing Experts Since 1963

Memo

Date: October 27, 2008

Applicant: Kenwood USA Corporation
Communications Division
3970 Johns Creek Court, Suite 100
Suwanee, GA 30024

Equipment: TK-3302-2
FCC ID: ALH413601

Please note that the enclosed Reports reflect the results of tests performed to the currently published Federal Communications Commissions Rules and Regulations.

Should the FCC's Examiners' interpretations request new and unpublished requirements, we will be pleased to provide them. We will invoice you accordingly, i.e. for the time spent on re-testing, providing the amended pages and/or Reports and for the time necessary to be spent on electronic filing. We will of course provide you with copies of any of the additions.

We regret any added expense to the Applicants, but of late the FCC continues to change their requirements without any prior written publication and/or notices.

As in the past, we will continue to provide all liaison with the FCC necessary for the successful conclusion of your project and the receipt of your Grant of Equipment Authorization.

Sincerely yours,

Hoosamuddin S. Bandukwala, Lab Director

Summary of Restrictions

1. All submissions to the FCC are subject to **their** Examiner's interpretation.
2. Please allow from 60 to 90 days before hearing from the FCC with regard to any submission.
3. The FCC can set aside any action; modify or set aside any action, within 30 days. (FCC Rule 1.108, 1.113).
4. Under Rule 2.803, if device is not type accepted/certificated then it must **not** be sold, leased, offered for sale, imported, shipped or distributed or advertised for sale.
5. FCC can revoke its certificates at any time if the equipment does not meet or **continue** to meet their Rules. (Rule Parts 2.927, 2.939).
6. FCC can request a sample at any time (2.936).

Flom Test Lab

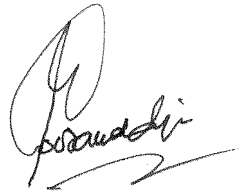

Hoosamuddin S. Bandukwala, Lab Director



Flom Test Labs
EMI, EMC, RF Testing Experts Since 1963

toll-free: (866) 311-3268
fax: (480) 926-3598
<http://www.flomlabs.com>
info@flomlabs.com

Date: October 27, 2008

Federal Communications Commission
Via: Electronic Filing

Attention: Authorization & Evaluation Division

Applicant: Kenwood USA Corporation
Equipment: TK-3302-2
FCC ID: ALH413601
FCC Rules: 22, 90, 74, 90.210

Gentlemen:

On behalf of the Applicant, enclosed please find Application Form 731, Engineering Test Report and all pertinent documentation, the whole for approval of the referenced equipment as shown.

We trust the same is in order. Should you need any further information, kindly contact the writer who is authorized to act as agent.

Sincerely yours,

Hoosamuddin S. Bandukwala, Lab Director



Flom Test Labs
EMI, EMC, RF Testing Experts Since 1963

toll-free: (866) 311-3268
fax: (480) 926-3598
<http://www.flomlabs.com>
info@flomlabs.com

Test Report

for

Model: TK-3302-2

to

Federal Communications Commission

Rule Part(s) 22, 90, 74, 90.210

Date of report: October 27, 2008

On the Behalf of the Applicant:

Kenwood USA Corporation

At the Request of:

Kenwood USA Corporation
Communications Division
3970 Johns Creek Court, Suite 100
Suwanee, GA 30024

Attention of:

Joel E. Berger, Research & Development
JBerger@kenwoodusa.com
(678) 474-4722; FAX: -4731

Supervised by:

Hoosamuddin S. Bandukwala, Lab Director

Revision History

Revision	Date	Revised By	Reason for revision
1.0	October 27, 2008	M.Wyman	Original Document
2.0	November 12, 2008	M.Wyman	TCB RT updates
3.0	November 14, 2008	S. Valentine	Address Correction
4.0	November 17, 2008	M. Wyman	Subsection chg for Part 74

List of Exhibits

(FCC **Certification** (Transmitters) - Revised 9/28/98)

Applicant: Kenwood USA Corporation

FCC ID: ALH413601

By Applicant:

1. Letter of Authorization
2. Confidentiality Request: 0.457 And 0.459
3. Part 90.203(e) & (g) Attestation
4. Identification Drawings, 2.1033(c)(11)
 - Label
 - Location of Label
 - Compliance Statement
 - Location of Compliance Statement
5. Photographs, 2.1033(c)(12)
6. Documentation: 2.1033(c)
 - (3) User Manual
 - (9) Tune Up Info
 - (10) Schematic Diagram
 - (10) Circuit Description
 - Block Diagram
 - Parts List
 - Active Devices
7. MPE/SAR Report

By F.T.L.:

- A. Testimonial & Statement of Certification

The Applicant has been cautioned as to the following:

15.21 Information to the User.

The users manual or instruction manual for an intentional radiator shall caution the user that changes or modifications not expressly approved by the party responsible for compliance could void the user's authority to operate the equipment.

15.27(a) Special Accessories.

Equipment marketed to a consumer must be capable of complying with the necessary regulations in the configuration in which the equipment is marketed. Where special accessories, such as shielded cables and/or special connectors are required to enable an unintentional or intentional radiator to comply with the emission limits in this part, the equipment must be marketed with, i.e. shipped and sold with, those special accessories. However, in lieu of shipping or packaging the special accessories with the unintentional or intentional radiator, the responsible party may employ other methods of ensuring that the special accessories are provided to the consumer, without additional charge.

Information detailing any alternative method used to supply the special accessories for a grant of equipment authorization or retained in the verification records, as appropriate. The party responsible for the equipment, as detailed in § 2.909 of this chapter, shall ensure that these special accessories are provided with the equipment. The instruction manual for such devices shall include appropriate instructions on the first page of text concerned with the installation of the device that these special accessories must be used with the device. It is the responsibility of the user to use the needed special accessories supplied with the equipment.

**Testimonial
and
Statement of Certification**

This is to Certify:

1. **That** the application was prepared either by, or under the direct supervision of, the undersigned.
2. **That** the technical data supplied with the application was taken under my direction and supervision.
3. **That** the data was obtained on representative units, randomly selected.
4. **That**, to the best of my knowledge and belief, the facts set forth in the application and accompanying technical data are true and correct.

Certifying Engineer:

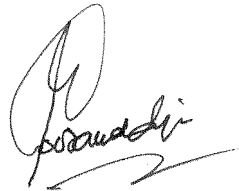

Hoosamuddin S. Bandukwala, Lab Director

Table of Contents

<u>Rule</u>	<u>Description</u>	<u>Page</u>
2.1033(c)(14)	Rule Summary	2
	Standard Test Conditions and Engineering Practices	3
2.1033(c)	General Information Required	4
2.1046(a)	Carrier Output Power (Conducted)	6
2.1046(a)	RF Power Output (Radiated)	7
2.1051	Unwanted Emissions (Transmitter Conducted)	9
2.1053(a)	Field Strength of Spurious Radiation	16
2.1049(c)(1)	Emission Masks (Occupied Bandwidth)	19
90.214	Transient Frequency Behavior	24
2.1047(a)	Audio Low Pass Filter (Voice Input)	28
2.1047(a)	Audio Frequency Response	30
2.1047(b)	Modulation Limiting	32
2.1055(a)(1)	Frequency Stability (Temperature Variation)	35
2.1055(b)(1)	Frequency Stability (Voltage Variation)	37
2.202(g)	Necessary Bandwidth and Emission Bandwidth	38
	Test Equipment Utilized	39

Required information per ISO 17025-2005, paragraph 5.10.2:

a) **Test Report**

b) Laboratory: Flom Test Lab
(FCC: 31040/SIT) 3356 N. San Marcos Place, Suite 107
(Canada: IC 2044-A) Chandler, AZ 85225

c) Report Number: d08a0014

d) Client: Kenwood USA Corporation
Communications Division
3970 Johns Creek Court, Suite 100
Suwanee, GA 30024

e) Identification: TK-3302-2

EUT Description: UHF FM Transceiver

f) EUT Condition: Not required unless specified in individual tests.

g) Report Date: October 27, 2008
EUT Received:

h, j, k): As indicated in individual tests.

i) Sampling method: No sampling procedure used.

l) Uncertainty: In accordance with FTL internal quality manual.

m) Supervised by:

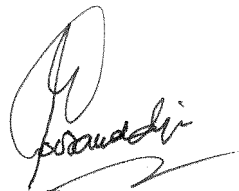

Hoosamuddin S. Bandukwala, Lab Director

n) Results: The results presented in this report relate only to the item tested.

o) Reproduction: This report must not be reproduced, except in full, without written permission from this laboratory.

Accessories used during testing:

Type	Quantity	Manufacturer	Model	Serial No.	FCC ID
Battery Pack	1	Kenwood	KNB-48	N/A	N/A

Sub-part

2.1033(c)(14):

Test and Measurement Data

All tests and measurement data shown were performed in accordance with FCC Rules and Regulations, Volume II; Part 2, Sub-part J, Sections 2.947, 2.1033(c), 2.1041, 2.1046, 2.1047, 2.1079, 2.1051, 2.1053, 2.1055, 2.1057 and the following individual Parts:

- 15 – Radio Frequency Devices (unlicensed)
- 21 – Domestic Public Fixed Radio Services
- 22 – Public Mobile Services
- 22 Subpart H - Cellular Radiotelephone Service
- 22.901(d) - Alternative technologies and auxiliary services
- 23 – International Fixed Public Radiocommunication services
- 24 – Personal Communications Services
- 74 Subpart H - Low Power Auxiliary Stations
- 80 – Stations in the Maritime Services
- 80 Subpart E - General Technical Standards
- 80 Subpart F - Equipment Authorization for Compulsory Ships
- 80 Subpart K - Private Coast Stations and Marine Utility Stations
- 80 Subpart S - Compulsory Radiotelephone Installations for Small Passenger Boats
- 80 Subpart T - Radiotelephone Installation Required for Vessels on the Great Lakes
- 80 Subpart U - Radiotelephone Installations Required by the Bridge-to-Bridge Act
- 80 Subpart V - Emergency Position Indicating Radio Beacons (EPIRB'S)
- 80 Subpart W - Global Maritime Distress and Safety System (GMDSS)
- 80 Subpart X - Voluntary Radio Installations
- 87 – Aviation Services
- 90 – Private Land Mobile Radio Services
- 94 – Private Operational-Fixed Microwave Service
- 95 Subpart A - General Mobile Radio Service (GMRS)
- 95 Subpart C - Radio Control (R/C) Radio Service
- 95 Subpart D - Citizens Band (CB) Radio Service
- 95 Subpart E - Family Radio Service
- 95 Subpart F - Interactive Video and Data Service (IVDS)
- 97 - Amateur Radio Service
- 101 – Fixed Microwave Services

Standard Test Conditions and Engineering Practices

Except as noted herein, the following conditions and procedures were observed during the testing:

In accordance with ANSI/TIA-603-C-2004, and unless otherwise indicated in the specific measurement results, the ambient temperature of the actual EUT was maintained within the range of 10° to 40°C (50° to 104 °F) unless the particular equipment requirements specify testing over a different temperature range. Also, unless otherwise indicated, the humidity levels were in the range of 10% to 90% relative humidity.

Measurement results, unless otherwise noted, are worst-case measurements.

A2LA

“A2LA has accredited Flom Test Labs, Inc. Chandler, AZ for technical competence in the field of Electrical testing. The accreditation covers the specific tests and types of tests listed on the agreed scope of accreditation. This laboratory meets the requirements of ISO 17025:2005 ‘General Requirements for the Competence of Testing and Calibration Laboratories’ and any additional program requirements in the identified field of testing.”

Please refer to www.a2la.org for current scope of accreditation.

Certificate number: 2152.01



IC O.A.T.S. Number: 2044A-1

List of General Information Required for Certification

In Accordance with FCC Rules and Regulations,
Volume II, Part 2 and to

22, 74, 90, 90.210 Sub-part 2.1033

(c)(1):

Name and Address of Applicant:

Kenwood USA Corporation
Communications Division
3970 Johns Creek Court, Suite 100
Suwanee, GA 30024

Manufacturer:

Kenwood Corporation
14-6, Dogenzaka 1-Chome
Shibuya-ku, Tokyo 150, Japan
OR
Kenwood Electronics Technologies PTE Ltd.
1 Ang Mo Kio Street 63
Singapore 569110

(c)(2): **FCC ID:**

ALH413601

Model Number:

TK-3302-2

(c)(3): **Instruction Manual(s):**

Please see attached exhibits

(c)(4): **Type of Emission:**

FM

(c)(5): **Frequency Range, MHz:**

470 - 512

(c)(6): **Power Rating, Watts:**

Switchable

Variable

4.0 (Continuously variable to 1W)

N/A

FCC Grant Note:

(c)(7): **FCC Maximum Limit, Watts:**

4.0

DUT Results:

Passes x Fails

Subpart 2.1033 (continued)

(c)(8): Voltages & currents in all elements in final RF stage, including final transistor or solid-state device:

Collector Current, A	=	2.0
Collector Voltage, Vdc	=	7.5
Supply Voltage, Vdc	=	7.5

(c)(9): **Tune-Up Procedure:**

Please see attached exhibits

(c)(10): **Circuit Diagram/Circuit Description:**

Including description of circuitry & devices provided for determining and stabilizing frequency, for suppression of spurious radiation, for limiting modulation and limiting power.

Please see attached exhibits

(c)(11): **Label Information:**

Please see attached exhibits

(c)(12): **Photographs:**

Please see attached exhibits

(c)(13): **Digital Modulation Description:**

Attached Exhibits
 N/A

(c)(14): **Test and Measurement Data:**

Follows

Name of Test: Carrier Output Power (Conducted)
Specification: 2.1046(a)
Test Equipment Utilized: I00228, i00317

Test Date: 10/13/08

Measurement Procedure

- A) The EUT was connected to a resistive coaxial attenuator of normal load impedance, and the unmodulated output power was measured by means of an RF Power Meter.
- B) Measurement accuracy is $\pm 3\%$.

Test Setup

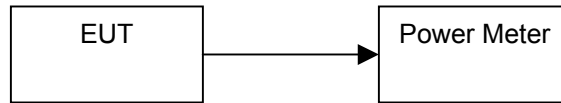

Measurement Results
(Worst case)

Frequency of Carrier, MHz = 470.0 – 512.0
 Ambient Temperature = 23°C \pm 3°C

Frequency, MHz	RF Power, dBm	RF Power, Watts
470.000	36.00dBm	4.0
491.050	35.92dBm	3.9
512.000	35.85dBm	3.9

Performed by:

Michael Wyman

Name of Test: RF Power Output (Radiated)
Specification: 2.1046(a)
Test Equipment Utilized: i00029, i00089

Test Date: 10/13/08

Measurement Procedure

Definition

The average radiated power of a licensed device is the equivalent power required, when delivered to a half-wave dipole or horn antenna, to produce at a distant point the same average received power as produced by the licensed device.

Method of Measurement:

- A) Connect the equipment as illustrated. Place the transmitter to be tested on the turntable in the standard test site.

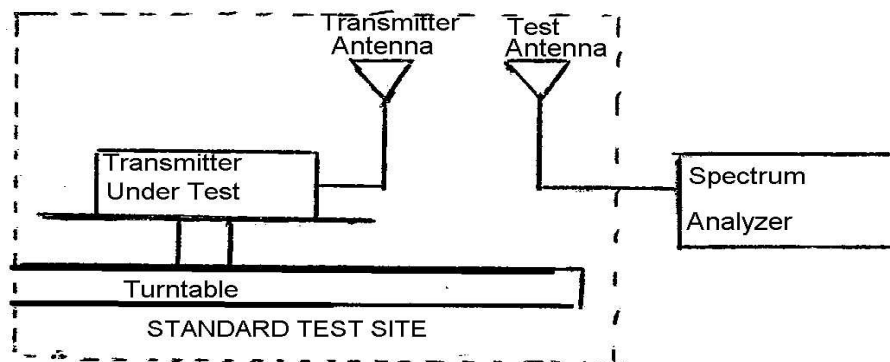

- B) Raise and lower the test antenna from 1m to 6 m with the transmitter facing the antenna and record the highest received signal in dB as LVL.
- C) Repeat step B) for seven additional readings at 45° interval positions of the turntable.
- D) Replace the transmitter under test with a half-wave or horn vertically polarized antenna. The center of the antenna should be at the same location as the transmitter under test. Connect the antenna to a signal generator with a known output power and record the path loss in dB or LOSS.
- E) Calculate the average radiated output power from the readings in step C) and D) by the following:

$$\text{average radiated power} = 10 \log_{10} 10(\text{LVL} - \text{LOSS})/10 \text{ (dBm)}$$

Measurement Results

State: General

Ambient Temperature: 23°C ± 3°C

Amps Mode:

Frequency Tuned, MHz	Frequency Emission, MHz	Meter, dBuV/m	CF, dB	ERP, dBm	ERP, Watts
470.000000	470.064000	119.4	19.6	32.0	1.58
491.050000	491.058000	117.5	20.5	31.0	1.26
512.000000	511.958000	116.2	20.4	29.6	0.91

Name of Test: Unwanted Emissions (Transmitter Conducted)
Specification: 2.1051
Test Equipment Utilized: I00029

Test Date: 10/12/08

Measurement Procedure

- A) The emissions were measured for the worst case as follows:
 - 1). within a band of frequencies defined by the carrier frequency plus and minus one channel.
 - 2). from the lowest frequency generated in the EUT and to at least the 10th harmonic of the carrier frequency, or 40 GHz, whichever is lower.
- B) The magnitude of spurious emissions that are attenuated more than 20 dB below the permissible value need not be specified.

Test Setup

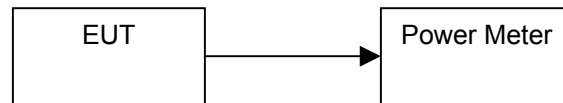

Measurement Results
(Worst case)

Summary:

Frequency of carrier, MHz	=	See Graphs for Details
Spectrum Searched, GHz	=	0 to 10 x F _C
Maximum Response, Hz	=	
All Other Emissions	=	≥ 20 dB Below Limit
Limit(s), dBc		

Tabulated Results follow:

Measurement Results

470MHz Panorama

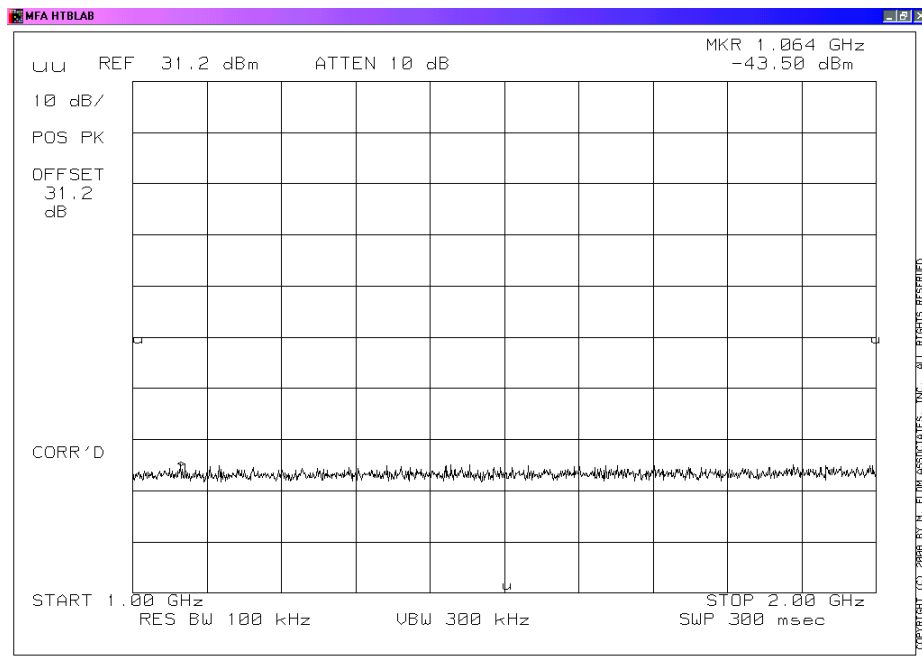
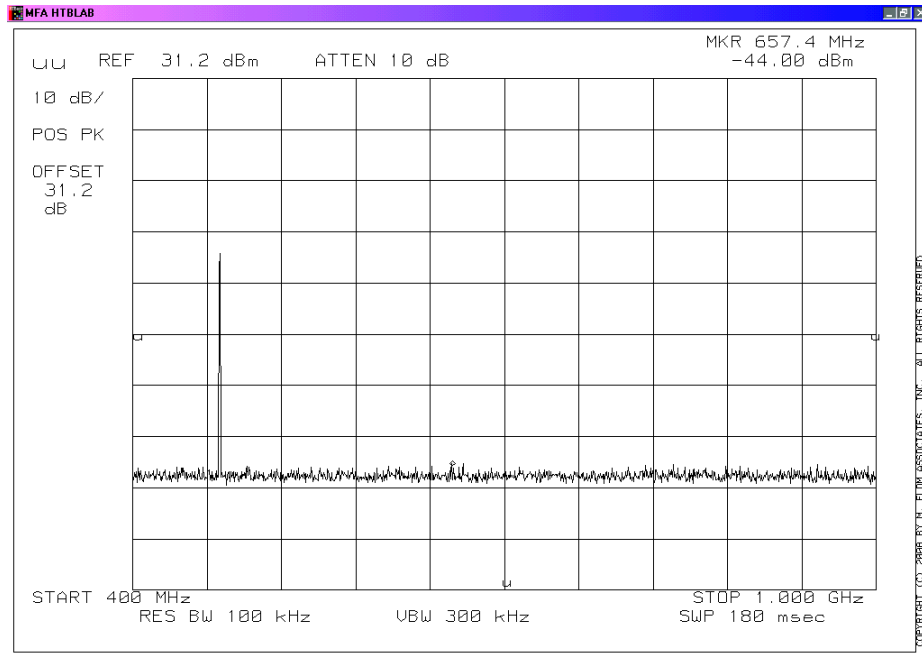

Measurement Results

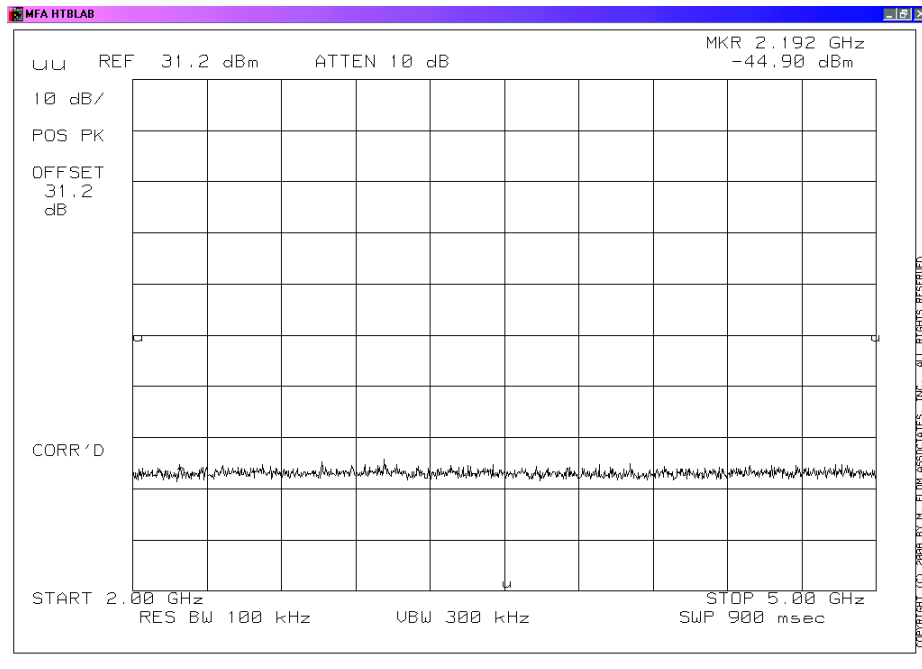

Michael D Wyman

Performed by:

Michael Wyman

Flom Test Labs
3356 North San Marcos Place, Suite 107
Chandler, Arizona 85225-7176
(866) 311-3268 phone, (480) 926-3598 fax

Measurement Results

490MHz Panorama

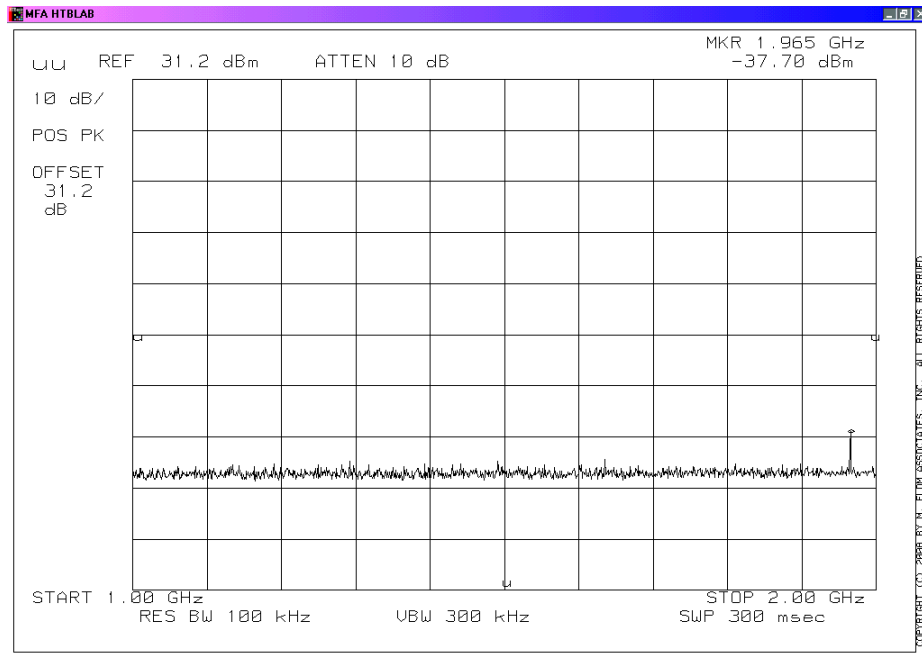
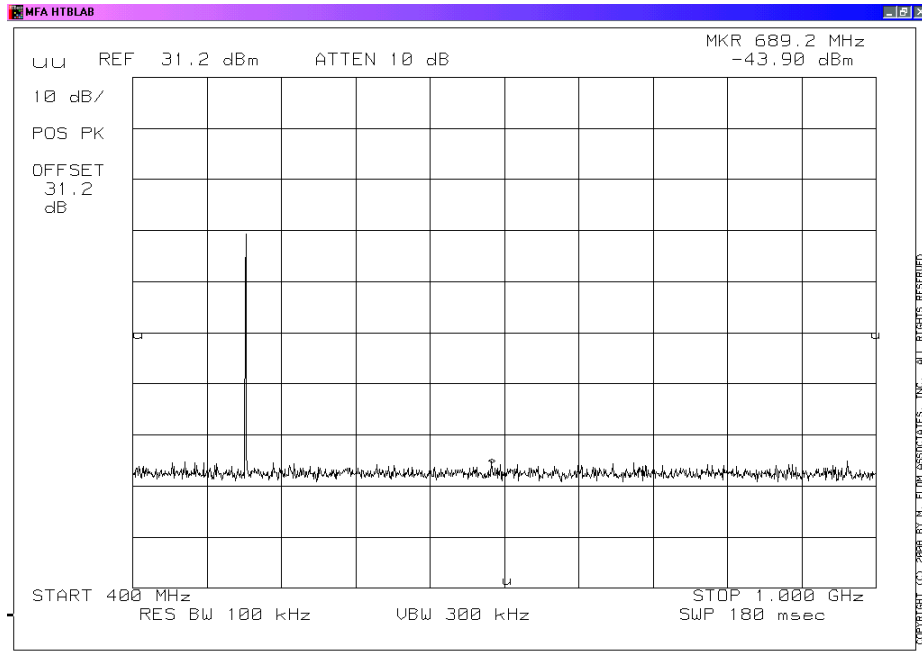

Measurement Results

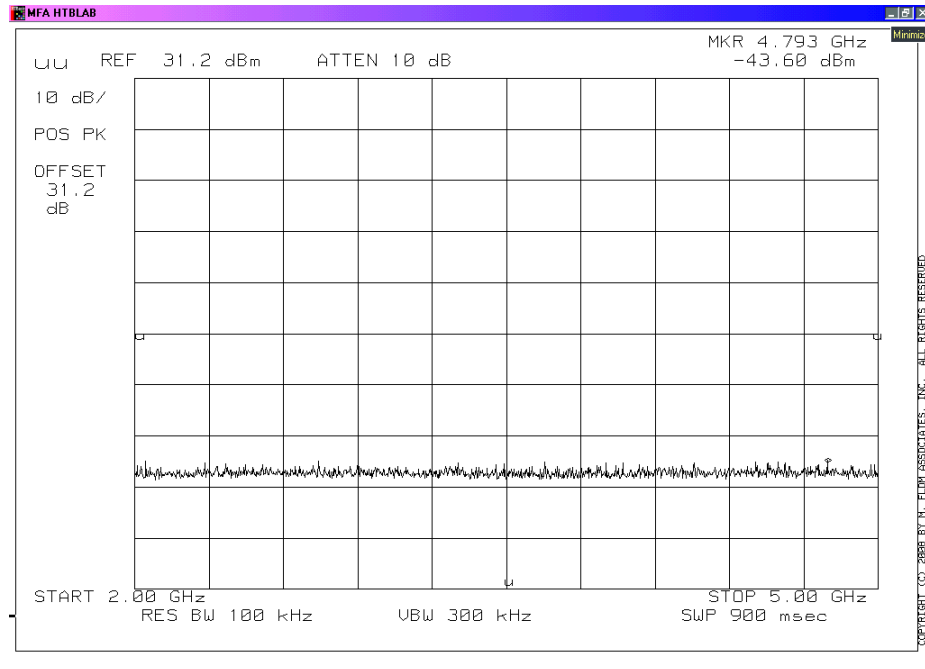

Michael D Wyman

Michael Wyman

Performed by:
Flom Test Labs
3356 North San Marcos Place, Suite 107
Chandler, Arizona 85225-7176
(866) 311-3268 phone, (480) 926-3598 fax

Measurement Results

512MHz Panorama

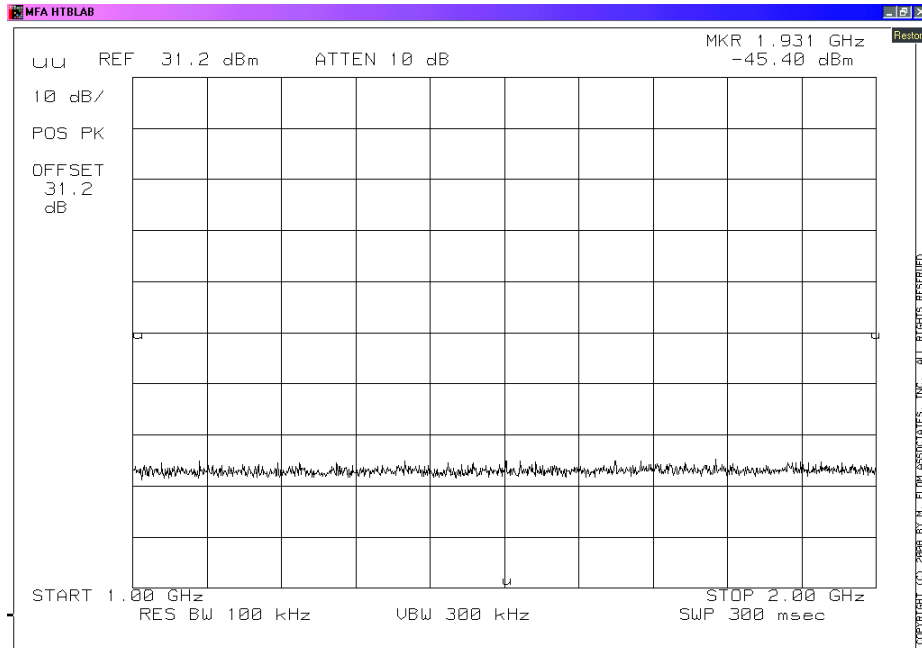
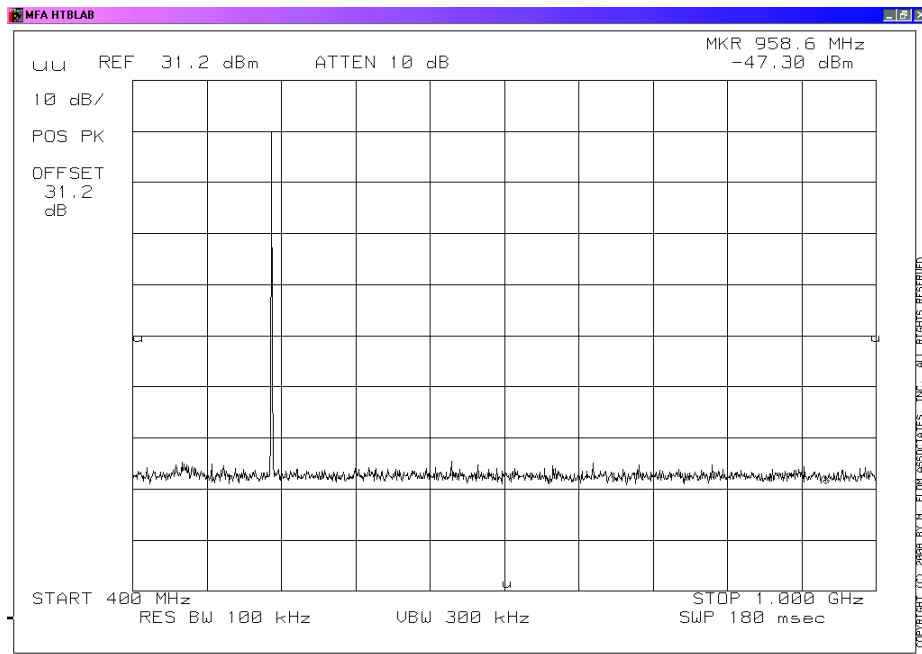

Measurement Result

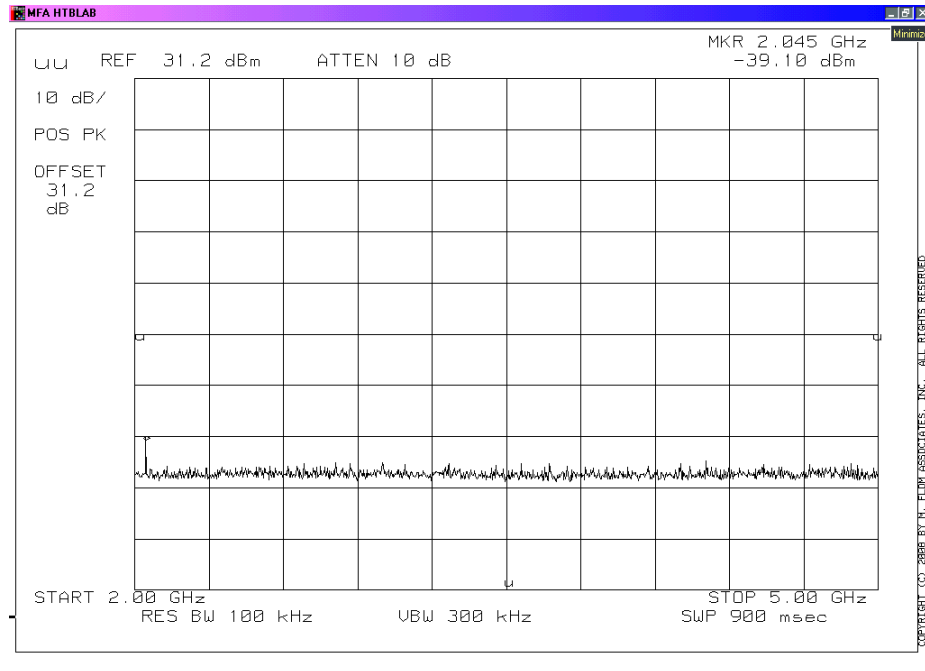

Michael D Wyman

Performed by:

Michael Wyman

Flom Test Labs
3356 North San Marcos Place, Suite 107
Chandler, Arizona 85225-7176
(866) 311-3268 phone, (480) 926-3598 fax

Name of Test: Field Strength of Spurious Radiation
Specification: 2.1053(a)
Test Equipment Utilized:

Test Date: 10/23/08

Measurement Procedure

Definition:

Radiated spurious emissions are emissions from the equipment when transmitting into a non-radiating load on a frequency or frequencies which are outside an occupied band sufficient to ensure transmission of information of required quality for the class of communications desired.

Method of Measurement:

A) Connect the equipment as illustrated.

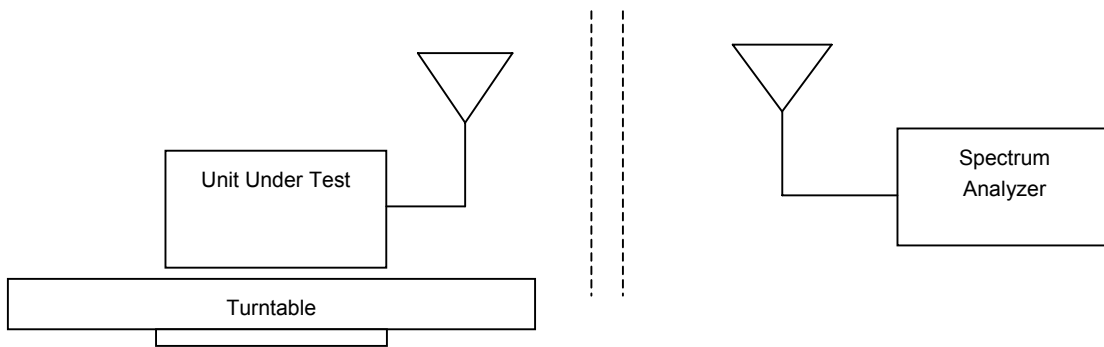

- B) Adjust the spectrum analyzer for the following settings:
- 1) Resolution Bandwidth 100 kHz (<1 GHz), 1 MHz (> 1GHz).
 - 2) Video Bandwidth ≥ 3 times Resolution Bandwidth, or 30 kHz (22.917)
 - 3) Sweep Speed ≤ 2000 Hz/second
 - 4) Detector Mode = Mean or Average Power
- C) Place the transmitter to be tested on the turntable in the standard test site. The transmitter is transmitting into a non-radiating load that is placed on the turntable. The RF cable to this load should be of minimum length.
- D) For each spurious measurement the test antenna should be adjusted to the correct length for the frequency involved. This length may be determined from a calibration ruler supplied with the equipment. Measurements shall be made from the lowest radio frequency generated in the equipment to the tenth harmonic of the carrier, except for the region close to the carrier equal to \pm the test bandwidth (see section 1.3.4.4).
- E) For each spurious frequency, raise and lower the test antenna from 1 m to 4 m to obtain a maximum reading on the spectrum analyzer with the test antenna at horizontal polarity. Repeat this procedure to obtain the highest possible reading. Record this maximum reading.
- F) Repeat step E) for each spurious frequency with the test antenna polarized vertically.

G) Reconnect the equipment as illustrated below.

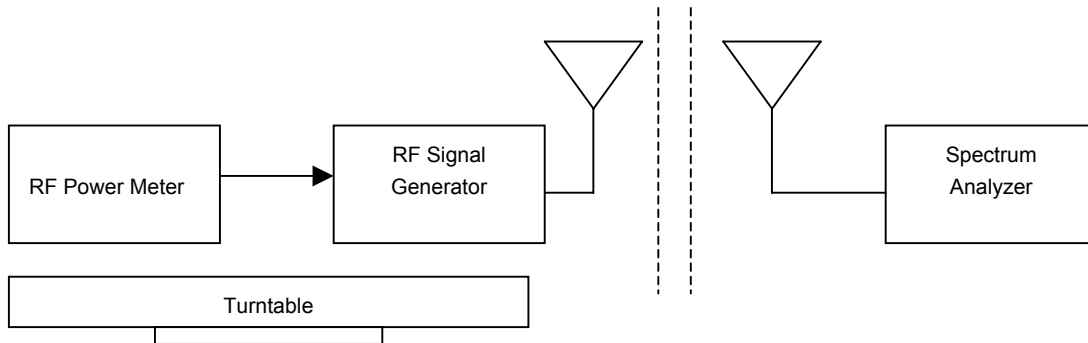

H) Keep the spectrum analyzer adjusted as in step B).

I) Remove the transmitter and replace it with a substitution antenna (the antenna should be half-wavelength for each frequency involved). The center of the substitution antenna should be approximately at the same location as the center of the transmitter. At lower frequencies, where the substitution antenna is very long, this will be impossible to achieve when the antenna is polarized vertically. In such case the lower end of the antenna should be 0.3 m above the ground.

J) Feed the substitution antenna at the transmitter end with a signal generator connected to the antenna by means of a non-radiating cable. With the antennas at both ends horizontally polarized and with the signal generator tuned to a particular spurious frequency, raise and lower the test antenna to obtain a maximum reading at the spectrum analyzer. Adjust the level of the signal generator output until the previously recorded maximum reading for this set of conditions is obtained. This should be done carefully repeating the adjustment of the test antenna and generator output.

K) Repeat step J) with both antennas vertically polarized for each spurious frequency.

L) Calculate power in dBm into a reference ideal half-wave dipole antenna by reducing the readings obtained in steps J) and K) by the power loss in the cable between the generator and the antenna and further corrected for the gain of the substitution antenna used relative to an ideal half-wave dipole antenna.

M) The levels recorded in step L) are absolute levels of radiated spurious emissions in dBm. The radiated spurious emissions in dB can be calculated by the following:

Radiated spurious emissions dB =

$$10\log_{10}(\text{TX power in watts}/0.001) - \text{the levels in step I)}$$

NOTE: It is permissible that other antennas provided can be referenced to a dipole.

Measurement Results

Power output = 36.0 dBm

g0870086: 2008-Jul-29 Tue 09:02:00
 STATE: 2:High Power

Ambient Temperature: 23°C ± 3°C

Frequency Tuned, MHz	Frequency Emission, MHz	ERP, dBm	ERP, dBc
470.000000	940.110000	-18.99	-54.99
470.000000	1410.056000	-58.73	-94.73
470.000000	1880.056000	-57.33	-93.33
470.000000	2350.056000	-53.73	-89.73

Harmonics were check to the 10 harmonic. There were no detectable harmonics above the 4th harmonic.

Measurement Results

Power output = 36.0dBm

g0870087: 2008-Jul-29 Tue 09:07:00
 STATE: 2:High Power

Ambient Temperature: 23°C ± 3°C

Frequency Tuned, MHz	Frequency Emission, MHz	ERP, dBm	ERP, dBc
490.000000	982.112000	-22.69	-58.69
490.000000	1473.054000	-50.34	-86.34
490.000000	1964.204000.	-44.14	-80.14
490.000000	2455.252000	-38.34	-74.34

Harmonics were check to the 10 harmonic. There were no detectable harmonics above the 4th harmonic.

Measurement Results

Power output = 35.9dBm

g0870088: 2008-Jul-29 Tue 09:10:00
 STATE: 2:High Power

Ambient Temperature: 23°C ± 3°C

Frequency Tuned, MHz	Frequency Emission, MHz	ERP, dBm	ERP, dBc
512.000000	1023.904000	-53.19	-89.09
512.000000	1535.852000	-39.39	-75.29
512.000000	2047.852000	-57.89	-93.79
512.000000	2559.852000	-55.44	-91.34

Harmonics were check to the 10 harmonic. There were no detectable harmonics above the 4th harmonic.

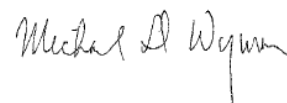

Performed by:

Michael Wyman

Name of Test: Emission Masks (Occupied Bandwidth)
Specification: 2.1049(c)(1)
Test Equipment Utilized: i00049

Test Date: 10/09/08

Measurement Procedure

- A) The EUT and test equipment were set up as shown below
- B) For EUTs supporting audio modulation, the audio signal generator was adjusted to the frequency of maximum response and with output level set for $\pm 2.5/\pm 1.25$ kHz deviation (or 50% modulation). With level constant, the signal level was increased 16 dB.
- C) For EUTs supporting digital modulation, the digital modulation mode was operated to its maximum extent.
- D) The Occupied Bandwidth was measured with the Spectrum Analyzer controls set as shown on the test results.

Test Setup

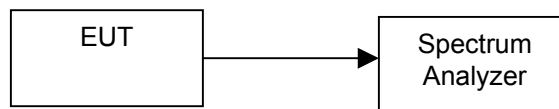

Measurement Results

State:

Ambient Temperature: 23°C ± 3°C

12.5KHz Occupied Bandwidth Plots

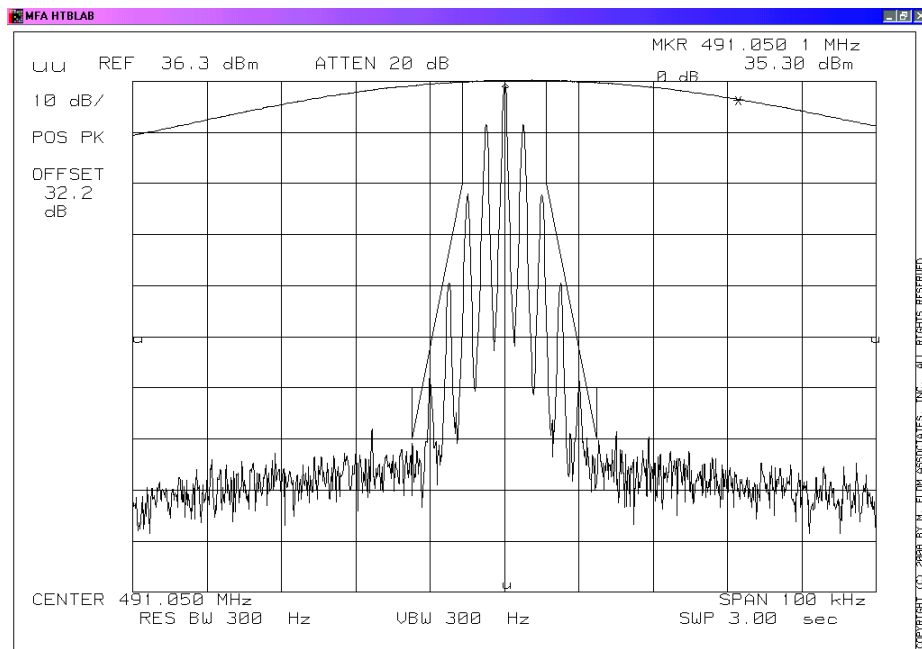
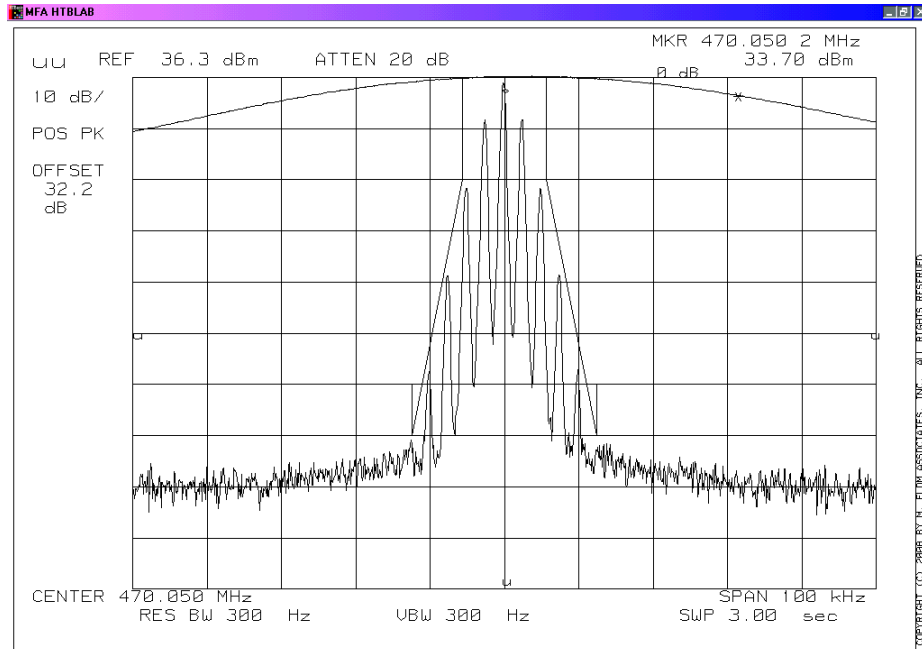

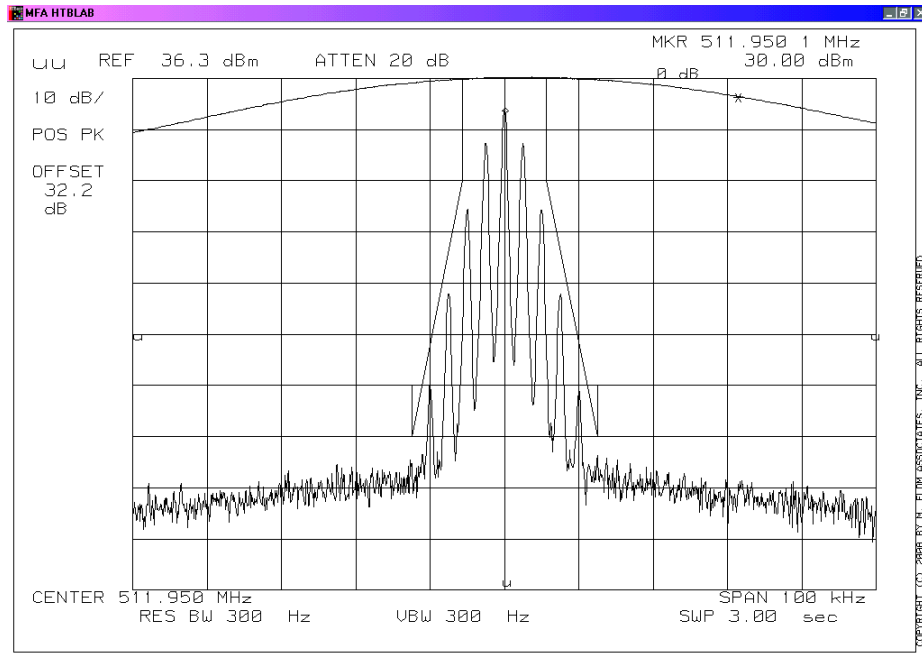

Power:
Modulation:

36.0 dBm
12.5KHz Bandwidth

Michael D Wyman

Performed by:

Michael Wyman

Flom Test Labs
3356 North San Marcos Place, Suite 107
Chandler, Arizona 85225-7176
(866) 311-3268 phone, (480) 926-3598 fax

Measurement Results

State:

Ambient Temperature: 23°C ± 3°C

25.0KHz Occupied Bandwidth Plots

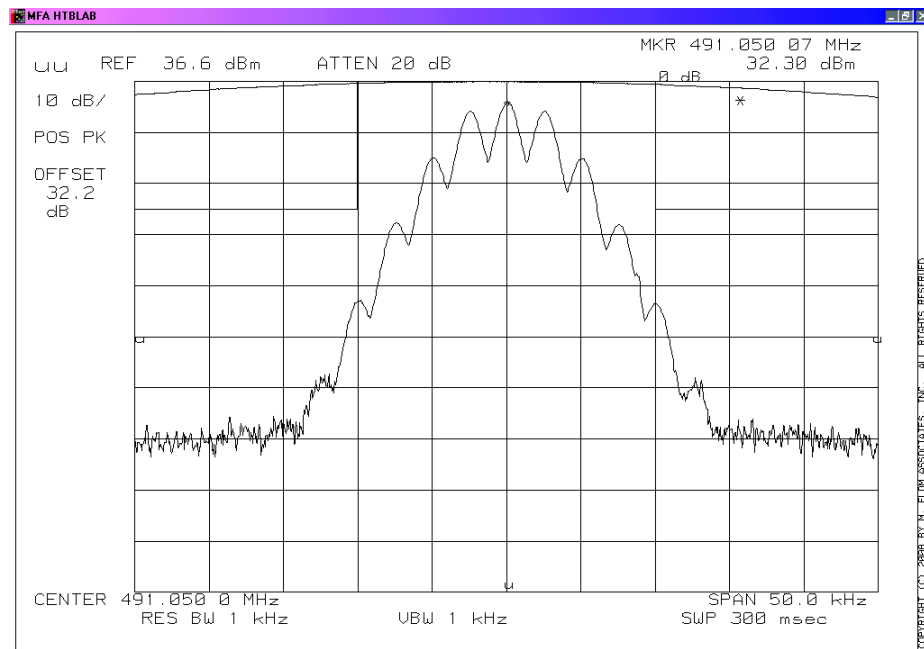
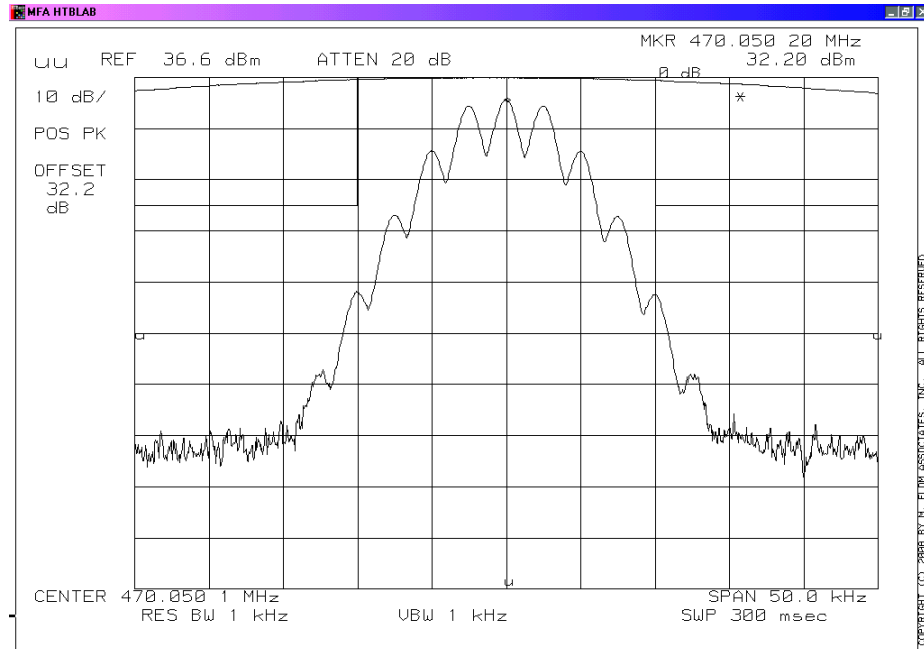

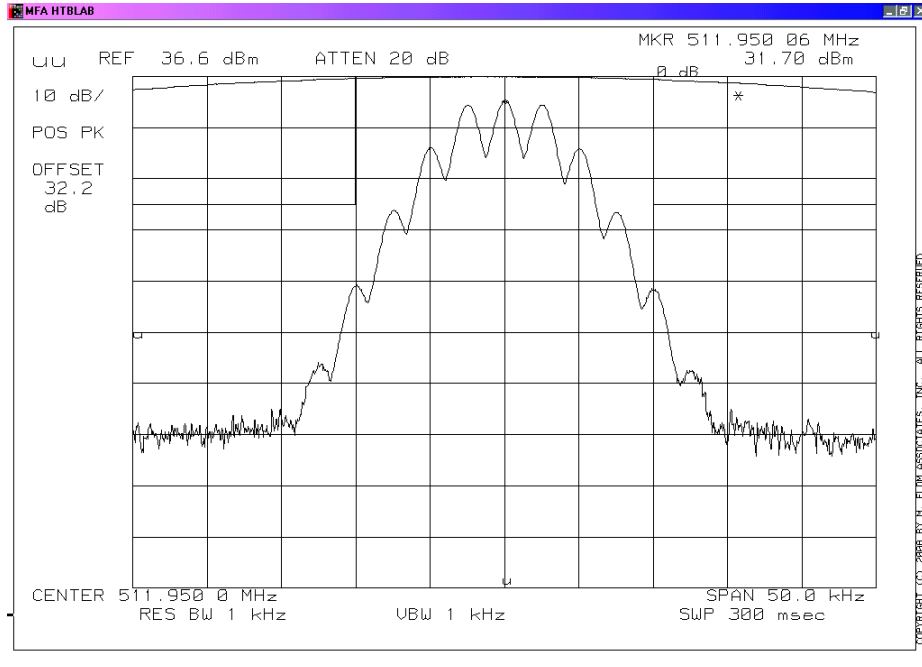

Power:
Modulation:

36.0dBm
25.0KHz Bandwidth

Michael D Wyman

Performed by:

Michael Wyman

Flom Test Labs
3356 North San Marcos Place, Suite 107
Chandler, Arizona 85225-7176
(866) 311-3268 phone, (480) 926-3598 fax

Name of Test: Transient Frequency Behavior
Specification: 90.214
Test Equipment Utilized: I00318, i00324, i00321

Test Date: 10/08/08

Measurement Procedure

- A) The EUT was setup as shown on the attached page, following TIA-603 steps a, b, and c as a *guide*.
- B) The transmitter was turned on.
- C) Sufficient attenuation was provided so that the transmitter carrier level measured at the output of the combiner was 40 dB below the maximum input level of the test receiver. This level was recorded.
- D) The transmitter was turned off.
- E) An RF signal generator (1) modulated with a 1 kHz tone at either 25, 12.5, or 6.25 kHz deviation, and set to the same frequency as the assigned transmitter frequency, (2) was adjusted to a level -20 dB below the level recorded for step C) above, measured at the output of the combiner. This level was then fixed for the remainder of the test.
- F) The oscilloscope was setup using TIA-603 steps j and k as a guide, and to either 10 ms/div (UHF) or 5 ms/div (VHF).
- G) The 30 dB attenuator was removed, the transmitter was turned on, and the level of the carrier at the output of the combiner was recorded.
- H) The carrier on-time as referenced in TIA-603 steps m, n, and o was captured and plotted. The carrier off-time as referenced in TIA-603 steps p, q, r, and s was captured and plotted.

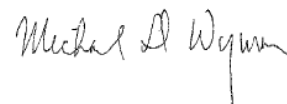

Performed by:

Michael Wyman

Transmitter Set-Up

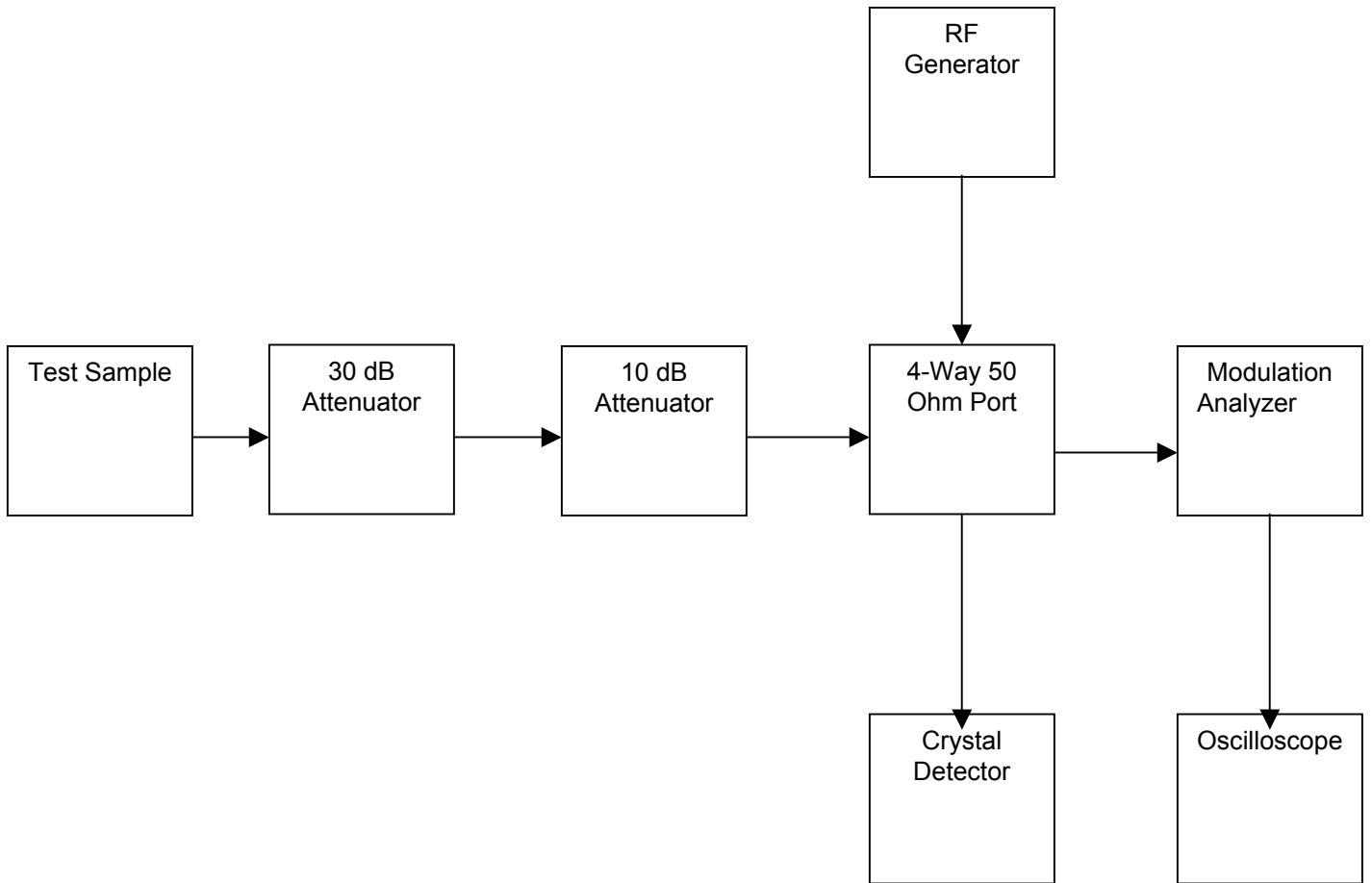

Name of Test: Transient Frequency Behavior

State: General

Ambient Temperature: 23°C ± 3°C

12.5 KHz Transient Behavior

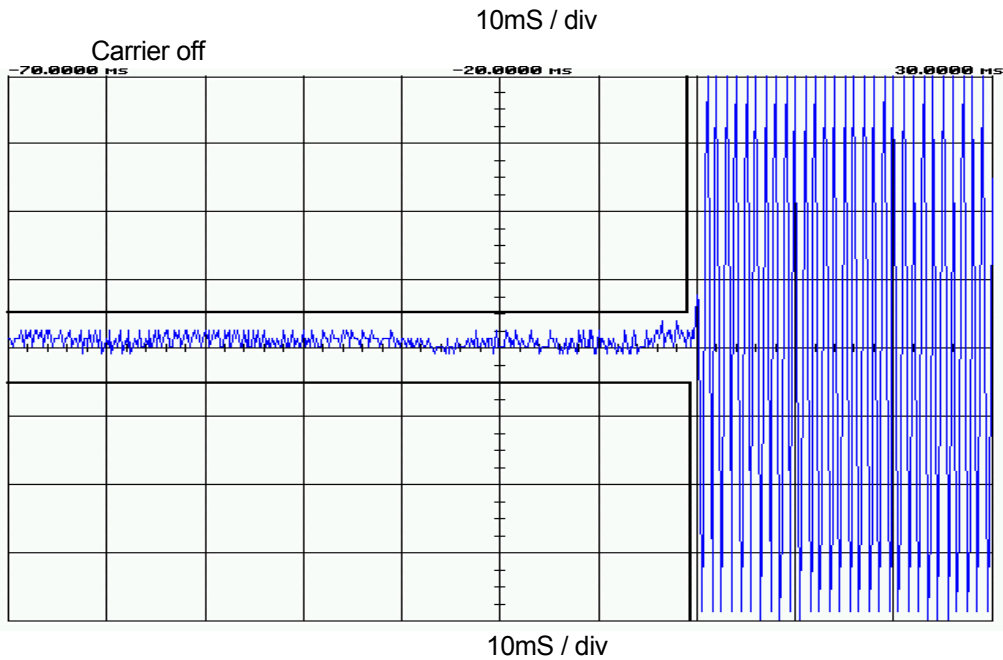
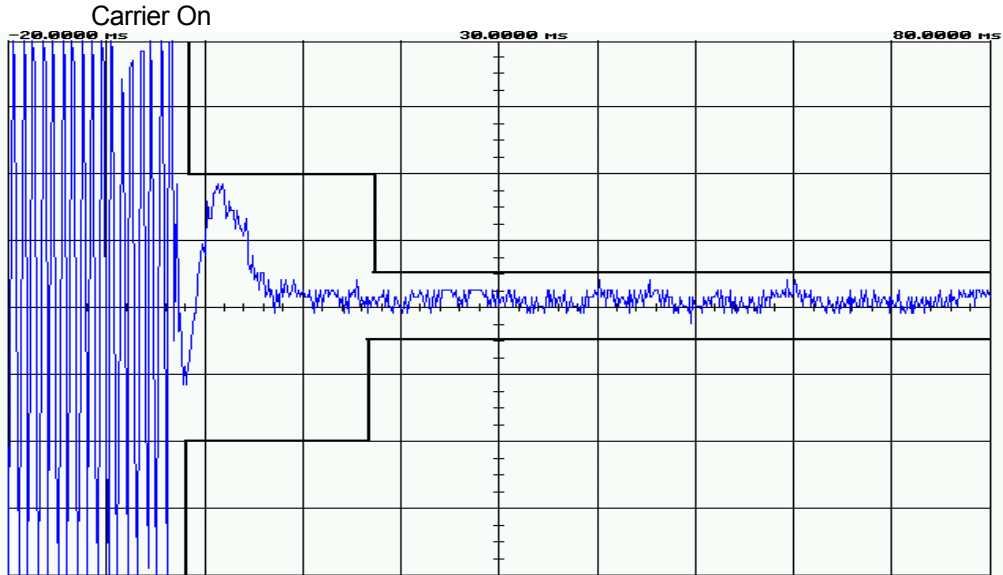

Modulation set at 1000Hz and 12.5KHz deviation

25.0 KHz Transient Behavior

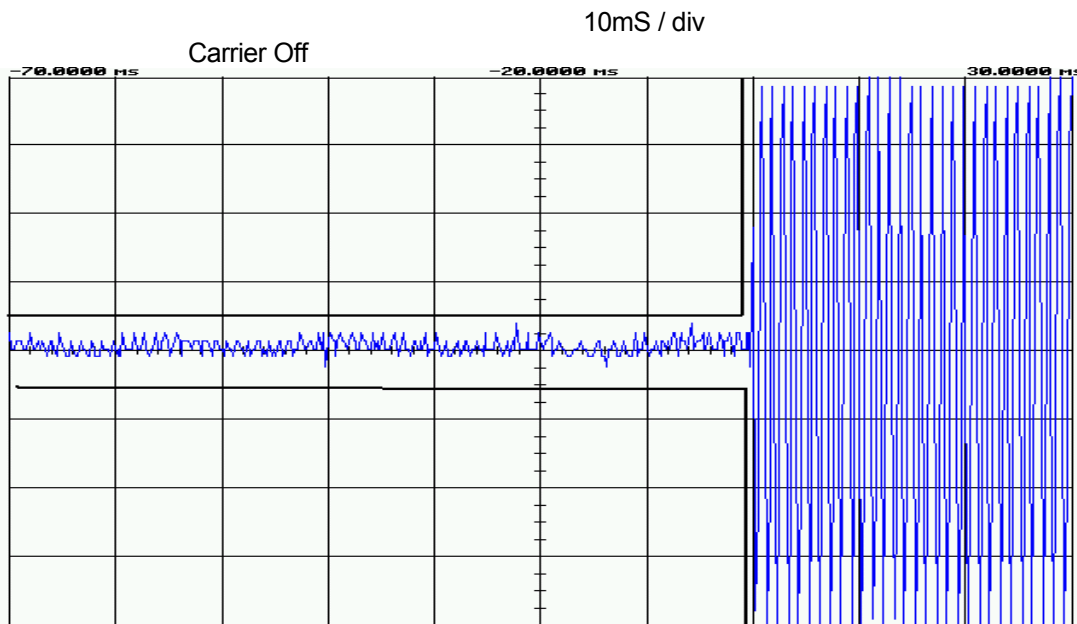
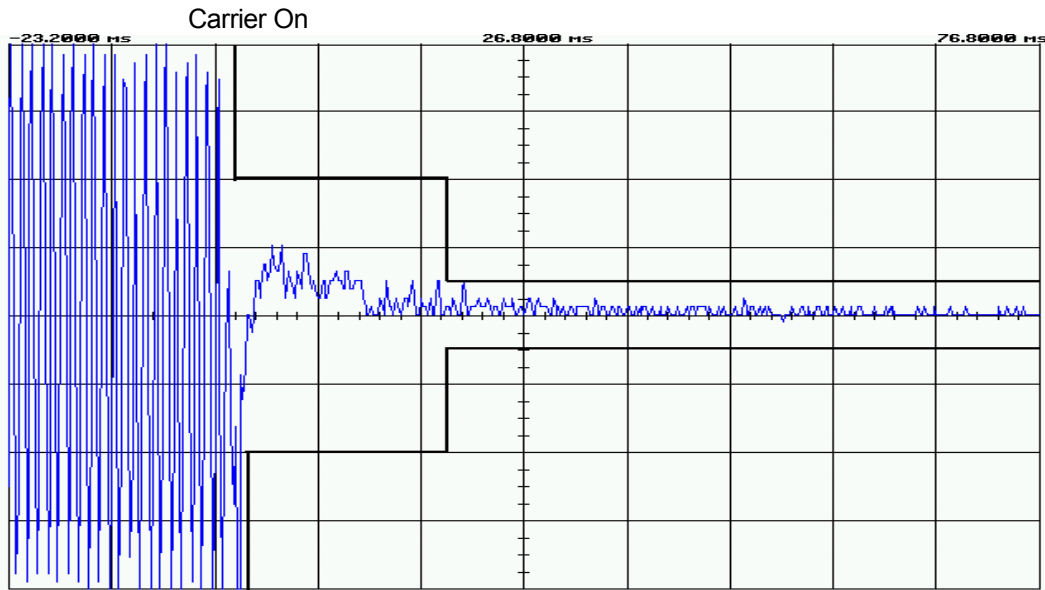

10mS / div

Modulation set at 1000Hz and 25.0KHz deviation

Performed by:

Michael Wyman

Flom Test Labs
3356 North San Marcos Place, Suite 107
Chandler, Arizona 85225-7176
(866) 311-3268 phone, (480) 926-3598 fax

Name of Test: Audio Low Pass Filter (Voice Input)
Specification: 2.1047(a)
Test Equipment Utilized: i00321, i00324

Test Date: 10/21/08

Measurement Procedure

- A) The EUT and test equipment were set up such that the audio input was connected at the input to the modulation limiter, and the modulated stage.
- B) The audio output was connected at the output to the modulated stage.

Transmitter Test Set-Up

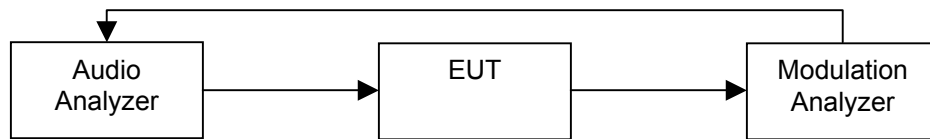

Name of Test: Audio Low Pass Filter (Voice Input)

Measurement Results

g0870063: 2008-Jul-08 Tue 13:10:00
State: 0:General

Ambient Temperature: 23°C ± 3°C

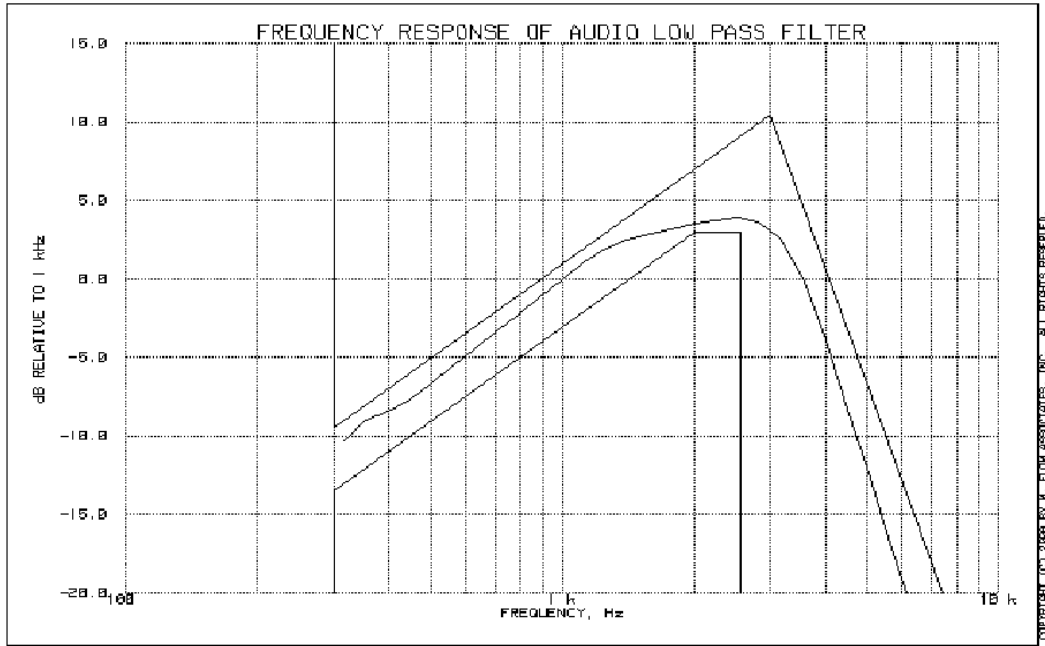

COPYRIGHT © 2008 BY FL. FLOR ASSOCIATES, INC. ALL RIGHTS RESERVED.

?

Michael D Wyman

Performed by:

Michael Wyman

Flom Test Labs
3356 North San Marcos Place, Suite 107
Chandler, Arizona 85225-7176
(866) 311-3268 phone, (480) 926-3598 fax

Name of Test: Audio Frequency Response
Specification: 2.1047(a)
Test Equipment Utilized: i00321, i00324

Test Date: 10/21/08

Measurement Procedure

- A) The EUT and test equipment were set up as shown below.
- B) The audio signal generator was connected to the audio input circuit/microphone of the EUT.
- C) The audio signal input was adjusted to obtain 20% modulation at 1 kHz, and this point was taken as the 0 dB reference level.
- D) With input levels held constant and below limiting at all frequencies, the audio signal generator was varied from 100 Hz to 50 kHz.
- E) The response in dB relative to 1 kHz was measured, using the HP 8901A Modulation Meter.

Transmitter Test Set-Up

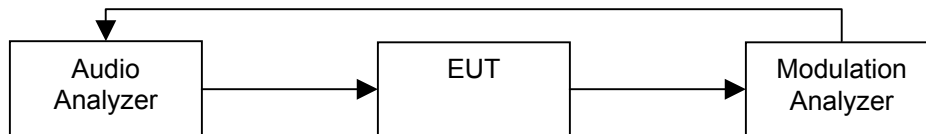

Measurement Results

g0870063: 2008-Jul-08 Tue 13:10:00
State: 0:General

Ambient Temperature: 23°C ± 3°C

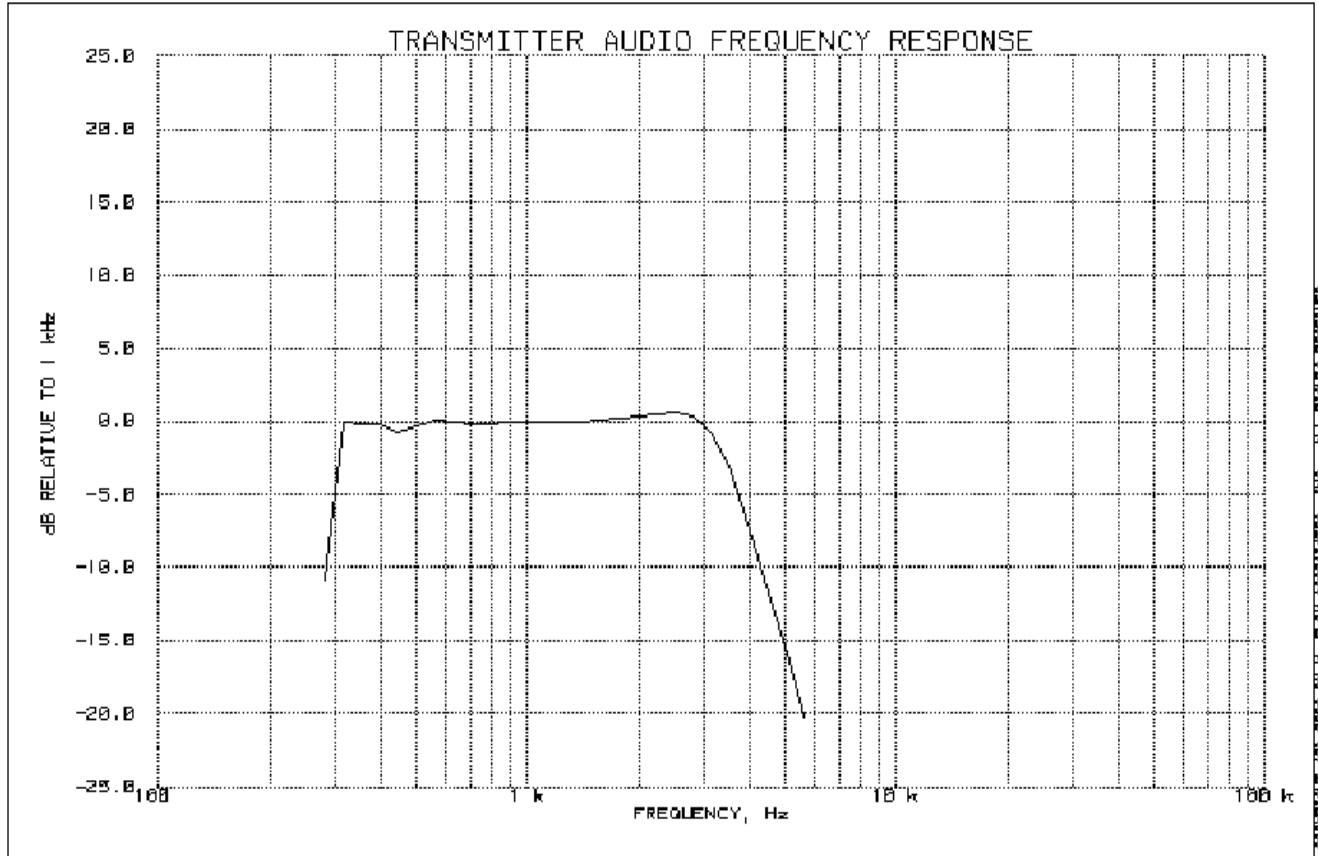

COPYRIGHT (C) 2006 BY H. FLOM ASSOCIATES, INC. ALL RIGHTS RESERVED.

3

Performed by:

Michael Wyman

Flom Test Labs
3356 North San Marcos Place, Suite 107
Chandler, Arizona 85225-7176
(866) 311-3268 phone, (480) 926-3598 fax

Name of Test: Modulation Limiting
Specification: 2.1047(b)
Test Equipment Utilized: i00324, i00321

Test Date: 10/23/08

Measurement Procedure

- A) The signal generator was connected to the input of the EUT as shown below.
- B) The modulation response was measured for each of three frequencies (one of which was the frequency of maximum response), and the input voltage was varied and was observed on an HP 8901A Modulation Analyzer.
- C) The input level was varied from 30% modulation (± 1.5 kHz deviation) to at least 20 dB higher than the saturation point.
- D) Measurements were performed for both negative and positive modulation and the respective results were recorded.

Transmitter Test Set-Up

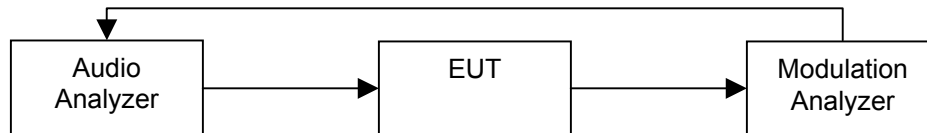

Measurement Results

g0870063: 2008-Jul-08 Tue 13:10:00
State: 0:General

Ambient Temperature: 23°C ± 3°C

12.5KHz Modulation Limiting

Positive
Peaks:

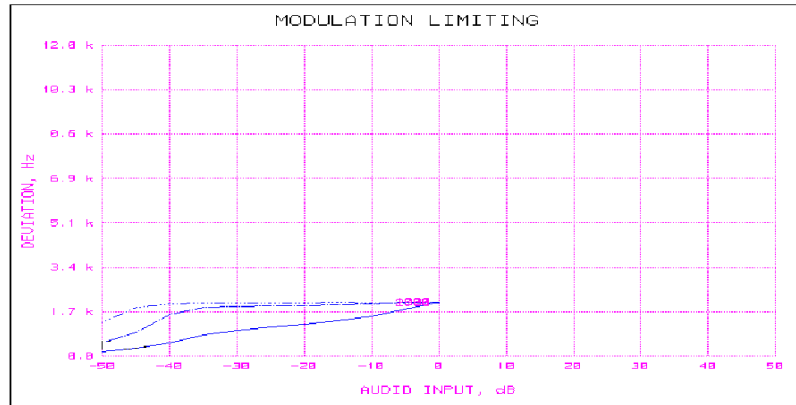

Negative
Peaks:

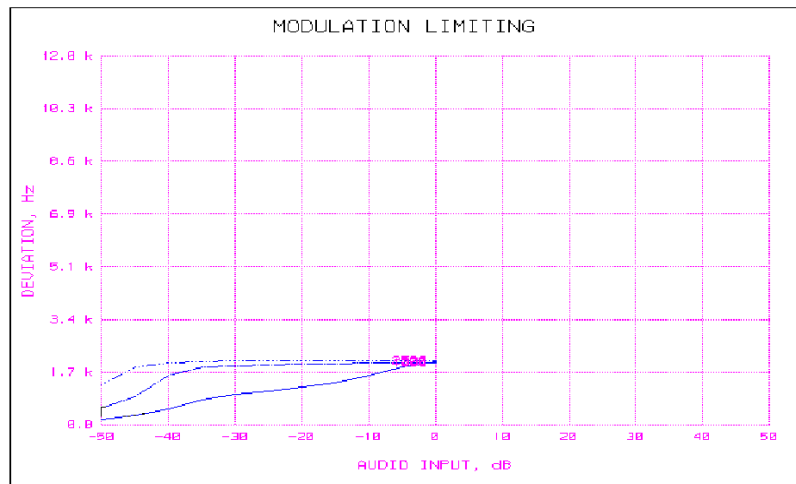

Michael D Wyman

Performed by:

Michael Wyman

Measurement Results

g0870063: 2008-Jul-08 Tue 13:10:00
State: 0:General

Ambient Temperature: 23°C ± 3°C

25KHz Modulation Limiting

Positive
Peaks:

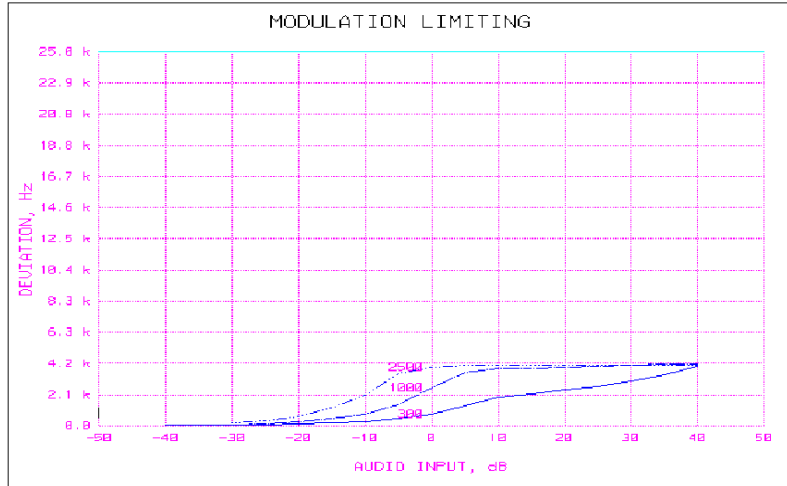

Negative
Peaks:

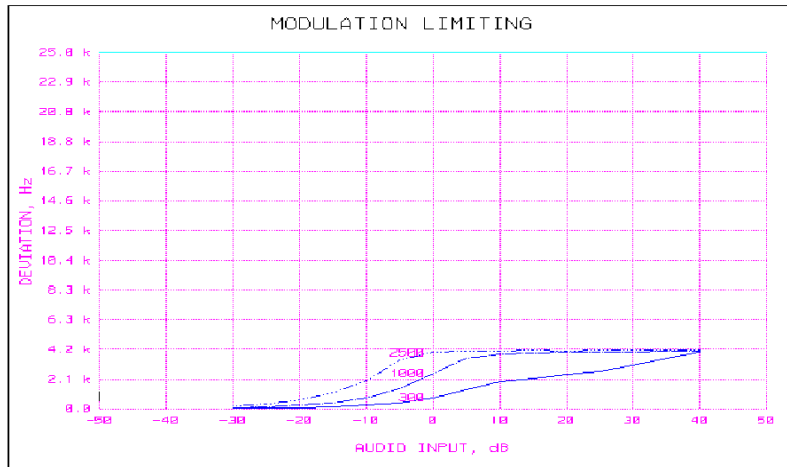

Michael D Wyman

Performed by:

Michael Wyman

Name of Test: Frequency Stability (Temperature Variation)
Specification: 2.1055(a)(1)
Test Equipment Utilized: i00019

Test Date: 10/21/08

Measurement Procedure

- A) The EUT and test equipment were set up as shown on the following page.
- B) With all power removed, the temperature was decreased to -30°C and permitted to stabilize for three hours. Power was applied and the maximum change in frequency was noted within one minute.
- C) With power OFF, the temperature was raised in 10°C steps. The sample was permitted to stabilize at each step for at least one-half hour. Power was applied and the maximum frequency change was noted within one minute.
- D) The temperature tests were performed for the worst case.

Measurement Setup

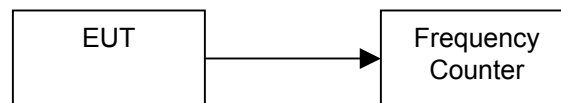

Measurement Results

g0870063: 2008-Jul-08 Tue 13:10:00
State: 0:General

Ambient Temperature: 23°C ± 3°C

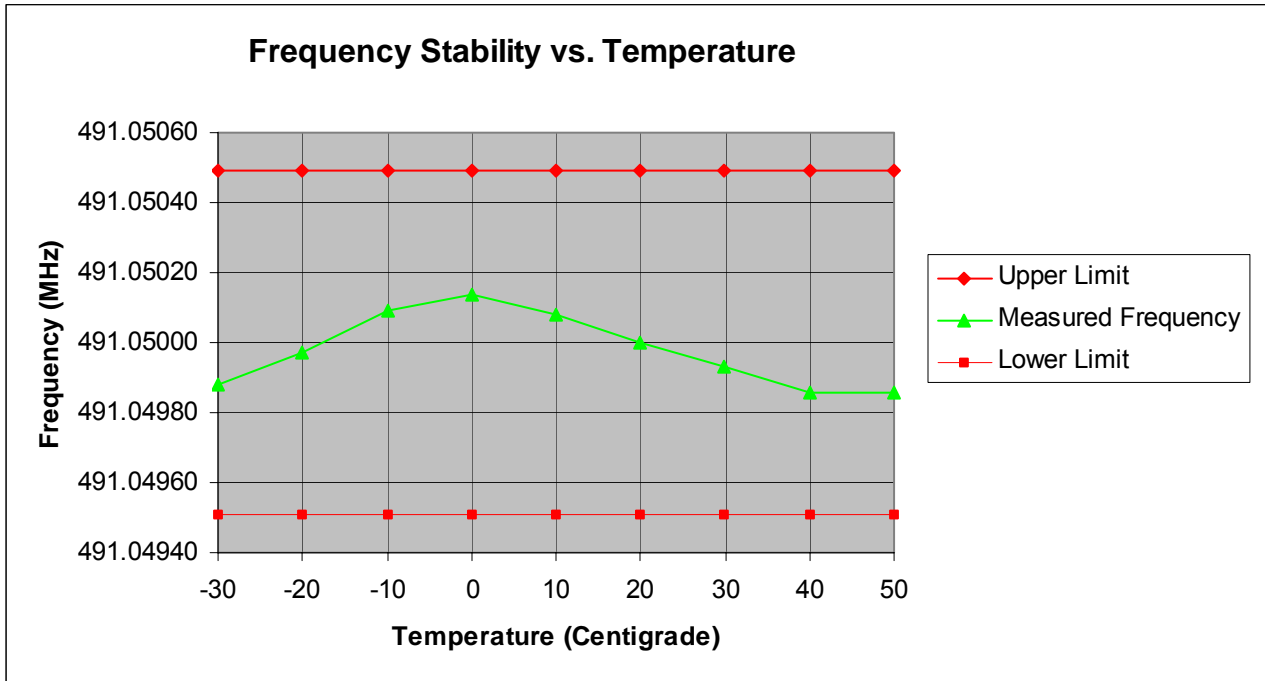

+/- 2.5ppm

Performed by:

Michael Wyman

Name of Test: Frequency Stability (Voltage Variation)
Specification: 2.1055(b)(1)
Test Equipment Utilized: i00019

Test Date: 10/21/08

Measurement Procedure

- A) The EUT was placed in a temperature chamber (if required) at 25±5°C and connected as shown below.
- B) The power supply voltage to the EUT was varied from 85% to 115% of the nominal value measured at the input to the EUT.
- C) The variation in frequency was measured for the worst case.

Measurement Setup

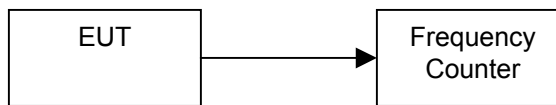

Measurement Results

g0870063: 2008-Jul-08 Tue 13:10:00
 State: 0:General

Ambient Temperature: 23°C ± 3°C

Limit, ppm = +/-2.5
 Limit, MHz = 0.00035
 Battery End Point (Voltage) = 7.39

% of STV	Voltage	Frequency, MHz	Change, Hz	Change, ppm
115	7.61	491.04991	0	<1
100	7.5	491.04991	0	<1
85	7.39	491.04991	0	<1

Performed by:

Michael Wyman

Name of Test: Necessary Bandwidth and Emission Bandwidth
Specification: 2.202(g)

By Carson's rule:

$$\text{Ex: } BW_{\text{Necessary}} = (2M+2DK)$$

Modulation =

Necessary Bandwidth Calculation:

Maximum Modulation (M), kHz	= 2.5	5.0
Maximum Deviation (D), kHz	= 3.0	3.0
Constant Factor (K)	= 1.0	1.0
Necessary Bandwidth (B _N), kHz	= 11K0F3E	16K0F3E

Test Equipment Utilized

Description	MFG	Model Number	FTL Asset Number	Last Cal Date	Cal Due Date
RF Pre-Amplifier	HP	8449	i00028	1/23/07	1/23/09
Spectrum Analyzer	HP	8563E	i00029	6/5/08	6/5/09
Spectrum Analyzer	HP	8566B	i00049	8/18/08	8/18/09
Bi Con Antenna	EMCO	3109B	i00088	10/15/07	10/15/09
Log Periodic Antenna	Aprel	2001	i00089	10/22/07	10/22/09
Monopole Antenna	Ailtech	DM-105A-T1, T2, T3	i00037, 39 i00042, 48	Verified	Verified
Horn Antenna	EMCO	3115	i00103	9/5/06	9/5/08
Horn Antenna	Aprel	3115	i00091	NCR	NCR
Horn Antenna	ARA	DRG-1181A	i00271	3/6/07	3/6/09
Power Meter	HP	E4418B	i00228	9/6/08	9/6/09
Power sensor	HP	8481A	i00317	9/6/08	9/6/09
Spectrum Analyzer	HP	8566B	i00329	5/05/08	5/05/09
Voltmeter	Fluke	87III	i00319	11/05/07	11/05/08
Temperature Chamber	Tenney	Tenney Jr.	i00027	9/25/07	10/25/08*
Audio Analyzer	HP	8903A	i00324	9/14/08	9/14/09
Modulation Analyzer	HP	8901A	i00321	9/17/08	9/17/09
Frequency Counter	HP	5334A	i00019	11/20/07	11/29/08
Power Supply	HP	6286A	i00005	NCR	NCR
Signal Generator	R&S	SMT-03	i00266	NCR	NCR

In addition to the above listed equipment standard RF connectors and cables were utilized in the testing of the described equipment. Prior to testing these components were tested to verify proper operation.

*The test was performed under the 30 day extension for the oven. The New cal date is 10/29/09

END OF TEST REPORT