



**Flom Test Labs**  
EMI, EMC, RF Testing Experts Since 1963

toll-free: (866) 311-3268  
fax: (480) 926-3598  
<http://www.flomlabs.com>  
[info@flomlabs.com](mailto:info@flomlabs.com)

**Date:** June 22, 2007

Federal Communications Commission  
Via: Electronic Filing

**Attention:** Authorization & Evaluation Division

**Applicant:** Kenwood USA Corporation  
**Equipment:** NX-300  
**FCC ID:** ALH378500  
**FCC Rules:** 22, 74, 90, 95

Gentlemen:

On behalf of the Applicant, enclosed please find Application Form 731, Engineering Test Report and all pertinent documentation, the whole for approval of the referenced equipment as shown.

We trust the same is in order. Should you need any further information, kindly contact the writer who is authorized to act as agent.

Sincerely yours,

Hoosamuddin S. Bandukwala, Lab Director

enclosure(s)  
cc: Applicant  
HSB/mdw

Flom Test Labs  
3356 North San Marcos Place, Suite 107  
Chandler, Arizona 85225-7176  
(866) 311-3268 phone, (480) 926-3598 fax

MFA p0750002, d0760022



**Flom Test Labs**  
EMI, EMC, RF Testing Experts Since 1963

toll-free: (866) 311-3268  
fax: (480) 926-3598  
<http://www.flomlabs.com>  
[info@flomlabs.com](mailto:info@flomlabs.com)

**Date:** June 22, 2007

Federal Communications Commission  
Via: Electronic Filing

**Attention:** Authorization & Evaluation Division

**Applicant:** Kenwood USA Corporation  
**Equipment:** NX-300  
**FCC ID:** ALH378500  
**FCC Rules:** 22, 74, 90, 95

Gentlemen:

On behalf of the Applicant, enclosed please find Application Form 731, Engineering Test Report and all pertinent documentation, the whole for approval of the referenced equipment as shown i.e.:

- a) Application Form
- b) Test Report (if applicable)
- c) Filing Fees
- d) Copy of Original Grant
- e) Expository Statement and/or letter by Applicant
- f) Photos (if applicable)
- g) Label Drawing (if changes have been made)

We trust the same is in order. Should you need any further information, kindly contact the writer who is authorized to act as agent.

Sincerely yours,

Hoosamuddin S. Bandukwala, Lab Director

enclosure(s)  
cc: Applicant  
HSB/mdw

Flom Test Labs  
3356 North San Marcos Place, Suite 107  
Chandler, Arizona 85225-7176  
(866) 311-3268 phone, (480) 926-3598 fax

MFA p0750002, d0760022



**Flom Test Labs**  
EMI, EMC, RF Testing Experts Since 1963

toll-free: (866) 311-3268  
fax: (480) 926-3598  
<http://www.flomlabs.com>  
[info@flomlabs.com](mailto:info@flomlabs.com)

## **Transmitter Certification**

of

Model: NX-300

to

**Federal Communications Commission**

Rule Part(s) 22, 74, 90, 95

Date of report: June 22, 2007

**On the Behalf of the Applicant:**

Kenwood USA Corporation

**At the Request of:**

Kenwood USA Corporation  
Communications Division  
3975 Johns Creek Court, Suite 300  
Suwanee, GA 30024

**Attention of:**

Joel E. Berger, Research & Development  
[JBerger@kenwoodusa.com](mailto:JBerger@kenwoodusa.com)  
(678) 474-4722; FAX: -4731

Supervised by:

Hoosamuddin S. Bandukwala, Lab Director

Flom Test Labs  
3356 North San Marcos Place, Suite 107  
Chandler, Arizona 85225-7176  
(866) 311-3268 phone, (480) 926-3598 fax

MFA p0750002, d0760022

List of Exhibits

(FCC **Certification** (Transmitters) - Revised 9/28/98)

Applicant: Kenwood USA Corporation

FCC ID: ALH378500

**By Applicant:**

1. Letter of Authorization
2. Confidentiality Request: 0.457 And 0.459
3. Part 90.203(e) & (g) Attestation
4. Identification Drawings, 2.1033(c)(11)
  - Label
  - Location of Label
  - Compliance Statement
  - Location of Compliance Statement
5. Photographs, 2.1033(c)(12)
6. Documentation: 2.1033(c)
  - (3) User Manual
  - (9) Tune Up Info
  - (10) Schematic Diagram
  - (10) Circuit Description
  - Block Diagram
  - Parts List
  - Active Devices
7. MPE/SAR Report

**By M.F.A. Inc.:**

- A. Testimonial & Statement of Certification

**The Applicant has been cautioned as to the following:**

**15.21 Information to the User.**

The users manual or instruction manual for an intentional radiator shall caution the user that changes or modifications not expressly approved by the party responsible for compliance could void the user's authority to operate the equipment.

**15.27(a) Special Accessories.**

Equipment marketed to a consumer must be capable of complying with the necessary regulations in the configuration in which the equipment is marketed. Where special accessories, such as shielded cables and/or special connectors are required to enable an unintentional or intentional radiator to comply with the emission limits in this part, the equipment must be marketed with, i.e. shipped and sold with, those special accessories. However, in lieu of shipping or packaging the special accessories with the unintentional or intentional radiator, the responsible party may employ other methods of ensuring that the special accessories are provided to the consumer, without additional charge.

Information detailing any alternative method used to supply the special accessories for a grant of equipment authorization or retained in the verification records, as appropriate. The party responsible for the equipment, as detailed in § 2.909 of this chapter, shall ensure that these special accessories are provided with the equipment. The instruction manual for such devices shall include appropriate instructions on the first page of text concerned with the installation of the device that these special accessories must be used with the device. It is the responsibility of the user to use the needed special accessories supplied with the equipment.

## Table of Contents

Rule	Description	Page
2.1033(c)(14)	Rule Summary	2
	Standard Test Conditions and Engineering Practices	3
2.1033(c)	General Information Required	4
2.1046(a)	Carrier Output Power (Conducted)	6
2.1046(a)	ERP Carrier Power (Radiated)	8
2.1046(a)	RF Power Output (Radiated)	9
2.1051	Unwanted Emissions (Transmitter Conducted)	10
2.1053(a)	Field Strength of Spurious Radiation	20
2.1049(c)(1)	Emission Masks (Occupied Bandwidth)	24
90.214	Transient Frequency Behavior	28
2.1047(a)	Audio Low Pass Filter (Voice Input)	33
2.1047(a)	Audio Frequency Response	35
2.1047(b)	Modulation Limiting	37
2.1055(a)(1)	Frequency Stability (Temperature Variation)	40
2.1055(b)(1)	Frequency Stability (Voltage Variation)	42
2.202(g)	Necessary Bandwidth and Emission Bandwidth	44

Required information per ISO 17025-2004, paragraph 5.0:

- a) **Test Report**
- b) Laboratory: Flom Test Lab  
(FCC: 31040/SIT) 3356 N. San Marcos Place, Suite 107  
(Canada: IC 2044) Chandler, AZ 85225
- c) Report Number: d0760022
- d) Client: Kenwood USA Corporation  
Communications Division  
3975 Johns Creek Court, Suite 300  
Suwanee, GA 30024
- e) Identification: NX-300  
EUT Description: UHF Mobile Radio
- f) EUT Condition: Not required unless specified in individual tests.
- g) Report Date: June 22, 2007
- h, j, k): As indicated in individual tests.
- i) Sampling method: No sampling procedure used.
- l) Uncertainty: In accordance with FTL internal quality manual.
- m) Supervised by:

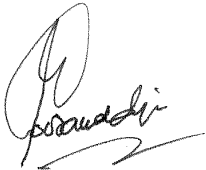

Hoosamuddin S. Bandukwala, Lab Director

- n) Results: The results presented in this report relate only to the item tested.
- o) Reproduction: This report must not be reproduced, except in full, without written permission from this laboratory.

Accessories used during testing:

Type	Quantity	Manufacturer	Model	Serial No.	FCC ID
------	----------	--------------	-------	------------	--------

Sub-part  
2.1033(c)(14):

### Test and Measurement Data

All tests and measurement data shown were performed in accordance with FCC Rules and Regulations, Volume II; Part 2, Sub-part J, Sections 2.947, 2.1033(c), 2.1041, 2.1046, 2.1047, 2.1079, 2.1051, 2.1053, 2.1055, 2.1057 and the following individual Parts:

- 15 – Radio Frequency Devices (unlicensed)
- 21 – Domestic Public Fixed Radio Services
- 22 – Public Mobile Services
- 22 Subpart H - Cellular Radiotelephone Service
- 22.901(d) - Alternative technologies and auxiliary services
- 23 – International Fixed Public Radiocommunication services
- 24 – Personal Communications Services
- 74 Subpart H - Low Power Auxiliary Stations
- 80 – Stations in the Maritime Services
- 80 Subpart E - General Technical Standards
- 80 Subpart F - Equipment Authorization for Compulsory Ships
- 80 Subpart K - Private Coast Stations and Marine Utility Stations
- 80 Subpart S - Compulsory Radiotelephone Installations for Small Passenger Boats
- 80 Subpart T - Radiotelephone Installation Required for Vessels on the Great Lakes
- 80 Subpart U - Radiotelephone Installations Required by the Bridge-to-Bridge Act
- 80 Subpart V - Emergency Position Indicating Radio Beacons (EPIRB'S)
- 80 Subpart W - Global Maritime Distress and Safety System (GMDSS)
- 80 Subpart X - Voluntary Radio Installations
- 87 – Aviation Services
- 90 – Private Land Mobile Radio Services
- 94 – Private Operational-Fixed Microwave Service
- 95 Subpart A - General Mobile Radio Service (GMRS)
- 95 Subpart C - Radio Control (R/C) Radio Service
- 95 Subpart D - Citizens Band (CB) Radio Service
- 95 Subpart E - Family Radio Service
- 95 Subpart F - Interactive Video and Data Service (IVDS)
- 97 - Amateur Radio Service
- 101 – Fixed Microwave Services



## Standard Test Conditions and Engineering Practices

Except as noted herein, the following conditions and procedures were observed during the testing:

In accordance with ANSI C63.4-2003 Draft, section 6.1.9, and unless otherwise indicated in the specific measurement results, the ambient temperature of the actual EUT was maintained within the range of 10° to 40°C (50° to 104 °F) unless the particular equipment requirements specify testing over a different temperature range. Also, unless otherwise indicated, the humidity levels were in the range of 10% to 90% relative humidity.

Prior to testing, the EUT was tuned up in accordance with the manufacturer's alignment procedures. All external gain controls were maintained at the position of maximum and/or optimum gain throughout the testing.

Measurement results, unless otherwise noted, are worstcase measurements.

### A2LA

"A2LA has accredited Flom Test Labs, Inc. Chandler, AZ for technical competence in the field of Electrical testing. The accreditation covers the specific tests and types of tests listed on the agreed scope of accreditation. This laboratory meets the requirements of ISO 17025:2005 'General Requirements for the Competence of Testing and Calibration Laboratories' and any additional program requirements in the identified field of testing."

Please refer to [www.a2la.org](http://www.a2la.org) for current scope of accreditation.

Certificate number: 2152.01



## List of General Information Required for Certification

In Accordance with FCC Rules and Regulations,  
Volume II, Part 2 and to

22, 74, 90, 95 Sub-part 2.1033

(c)(1):

**Name and Address of Applicant:**

Kenwood USA Corporation  
 Communications Division  
 3975 Johns Creek Court, Suite 300  
 Suwanee, GA 30024

**Manufacturer:**

Kenwood Corporation  
 14-6, Dogenzaka 1-Chome  
 Shibuya-ku, Tokyo 150, Japan  
 OR  
 Kenwood Electronics Technologies PTE Ltd.  
 1 Ang Mo Kio Street 63  
 Singapore 569110

(c)(2): **FCC ID:**

ALH378500

**Model Number:**

NX-300

(c)(3): **Instruction Manual(s):**

Please see attached exhibits

(c)(4): **Type of Emission:**

16K0F3E, 11K0F3E, 8K00F1E,  
 8K00F1D, 8K00F7W, 3K80F1E,  
 3K80F1D, 3K80F7W, 3K80F2D,  
 8K10F1D, 8K10F1E

(c)(5): **Frequency Range, MHz:**

450-520

(c)(6): **Power Rating, Watts:**

5

\_\_\_\_\_ Switchable

\_\_\_\_\_ Variable

\_\_\_\_\_ N/A

**FCC Grant Note:**

(c)(7): **Maximum Power Rating, Watts:**

50

**DUT Results:**

Passes

\_\_\_\_\_ x \_\_\_\_\_

Fails \_\_\_\_\_

Subpart 2.1033 (continued)

(c)(8): Voltages & currents in all elements in final RF stage, including final transistor or solid-state device:

Collector Current, A	=	0.667
Collector Voltage, Vdc	=	7.5
Supply Voltage, Vdc	=	7.5

(c)(9): **Tune-Up Procedure:**

Please see attached exhibits

(c)(10): **Circuit Diagram/Circuit Description:**

Including description of circuitry & devices provided for determining and stabilizing frequency, for suppression of spurious radiation, for limiting modulation and limiting power.

Please see attached exhibits

(c)(11): **Label Information:**

Please see attached exhibits

(c)(12): **Photographs:**

Please see attached exhibits

(c)(13): **Digital Modulation Description:**

Attached Exhibits  
 N/A

(c)(14): **Test and Measurement Data:**

Follows

**Name of Test:** Carrier Output Power (Conducted)  
**Specification:** 47 CFR 2.1046(a)  
**Guide:** ANSI/TIA/EIA-603-C-2004, Paragraph 2.2.1

**Measurement Procedure**

- A) The EUT was connected to a resistive coaxial attenuator of normal load impedance, and the unmodulated output power was measured by means of an RF Power Meter.
- B) Measurement accuracy is  $\pm 3\%$ .

**Transmitter Test Set-Up: RF Power Output**

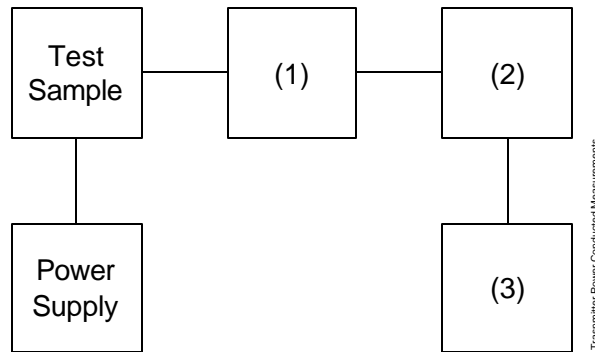

Asset	Description	s/n	Cycle	Last Cal
(1)	<b>Coaxial Attenuator</b>			
X	i00231/2 PASTERNAK PE7021-30 (30 dB)	231 or 232	N/A	NCR
	i00122/3 NARDA 766 (10 dB)	7802 or 7802A	N/A	NCR
(2)	<b>Power Meters</b>			
X	i00321 HP 8901A Power Mode	2239A02170	12 mo.	Sep-06
(3)	<b>Frequency Counter</b>			
X	i00321 HP 8901A Frequency Mode	2239A02170	12 mo.	Sep-06

**Name of Test:** Carrier Output Power (Conducted)

**Measurement Results**  
(Worst case)

Power Output = High  
Ambient Temperature = 23°C +/- 3°C

Tuned Frequency (MHz)	Conducted Power (dBm)	RF Power (Vatts)
450.05	37.0	5.0
462.50	36.9	4.89
519.95	36.8	4.78

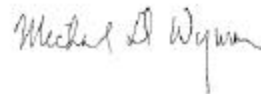

Performed by:

Michael Wyman

**Name of Test:** ERP Carrier Power (Radiated)

**Specification:** ANSI/TIA/EIA-603-C-2004 (Substitution Method)

**Measurement Procedure**

**Definition**

The average radiated power of a licensed device is the equivalent power required, when delivered to a halfwave dipole or horn antenna, to produce at a distant point the same average received power as produced by the licensed device.

**Method of Measurement:**

- A) Connect the equipment as illustrated. Place the transmitter to be tested on the turntable in the standard test site.

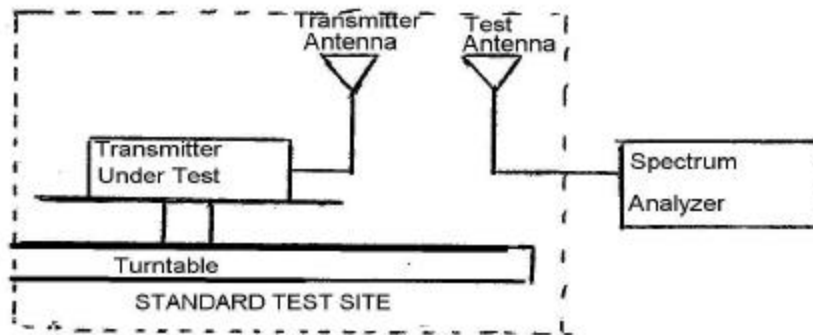

- B) Raise and lower the test antenna from 1m to 6 m with the transmitter facing the antenna and record the highest received signal in dB as LVL.
- C) Repeat step B) for seven additional readings at 45° interval positions of the turntable.
- D) Replace the transmitter under test with a halfwave or horn vertically polarized antenna. The center of the antenna should be at the same location as the transmitter under test. Connect the antenna to a signal generator with a known output power and record the path loss in dB or LOSS.
- E) Calculate the average radiated output power from the readings in step C) and D) by the following:

$$\text{average radiated power} = 10 \log_{10} \left( \frac{10(LVL - LOSS)}{10} \right) \text{ (dBm)}$$

**Name of Test:** RF Power Output (Radiated)  
**Specification:** 47 CFR 2.1046(a)  
**Test Equipment:** As per attached page

### Measurement Procedure (Radiated)

1. The EUT was placed on an open-field site and its radiated field strength at a known distance was measured by means of a spectrum analyzer. Equivalent loading was calculated from the equation  $P_r = ((E \times R)^2 / 49.2)$  watts, where R = 3m.
2. Measurement accuracy is  $\pm 1.5$  dB.

### Measurement Results

Frequency Tuned, MHz	Frequency E mission (MHz)	Level (dB $\mu$ V/m)	CF (dB)	ERP (dBm)	ERP (Watts)
450.05	450.05	114.6	21.3	38.5	7.07
462.50	462.53	116.0	21.6	40.3	10.7
519.95	519.95	113.0	22.7	38.3	6.76

**Name of Test:** Unwanted Emissions (Transmitter Conducted)  
**Specification:** 47 CFR 2.1051  
**Guide:** ANSI/TIA/EIA-603-C-2004, Paragraph 2.2.13

**Measurement Procedure**

- A) The emissions were measured for the worst case as follows:
  - 1). within a band of frequencies defined by the carrier frequency plus and minus one channel.
  - 2). from the lowest frequency generated in the EUT and to at least the 10th harmonic of the carrier frequency, or 40 GHz, whichever is lower.
- B) The magnitude of spurious emissions that are attenuated more than 20 dB below the permissible value need not be specified.

**Transmitter Test Set-Up: Spurious Emission**

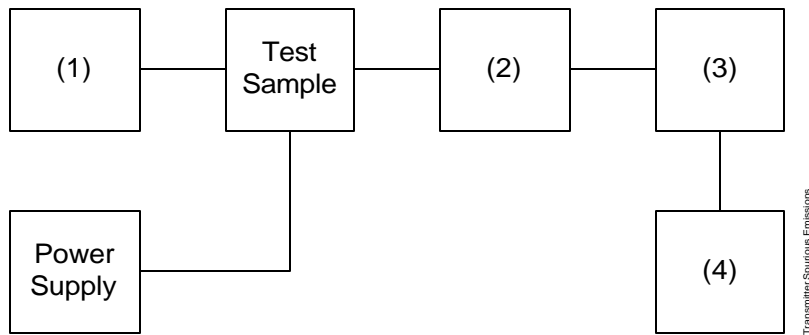

Asset	Description	s/n			
<b>(1) Audio Oscillator/Generator</b>					
X	i00324	HP 8903B Audio Analyzer	3011A09079	12 mo.	Oct-06
	i00002	HP 3336B Synthesizer / Level Gen.	1931A01465	N/A	NCR
<b>(2) Coaxial Attenuator</b>					
X	i00231/2	PASTERNAK PE7021-30 (30 dB)	231 or 232	N/A	NCR
	i0012/3	NARDA 766 (10 dB)	7802 or 7802A	N/A	NCR
<b>(3) Filters; Notch, HP, LP, BP</b>					
X	Notch	-33 dB Supression		N/A	NCR
<b>(4) Spectrum Analyzer</b>					
X	i00048	HP 8566B Spectrum Analyzer	2511A01467	12 mo.	Aug-06
	i00029	HP 8563E Spectrum Analyzer	3213A00104	12 mo.	Jan-06



**Name of Test:** Unwanted Emissions (Transmitter Conducted)

**Measurement Results**

**Sample calculation**

Conducted Power – Spurious Power = Spurious dBc

**Limit calculation**

Limit = 50 + 10 Log Conducted Power

**Summary Results Table**

Tuned Frequency (MHz)	Emission Frequency (MHz)	Conducted Power (dBm)	Spurious Power (dBm)	Spurious (dBc)	Limit (dBc)
450.05	889.7	37.0	-59.39	-96.39	-65.68
519.95	1037.3	36.8	-59.39	-96.19	-65.65

In all cases a notch filter was used to suppress the fundamental carrier (-33dB) and the suppressed carrier was set to the reference level of the spectrum analyzer for ease of measurement.

**Measurement Plots**

g0750041: 2007-May-08 Tue 10:11:00  
 State: 2:High Power

Ambient Temperature: 23°C ± 3°C

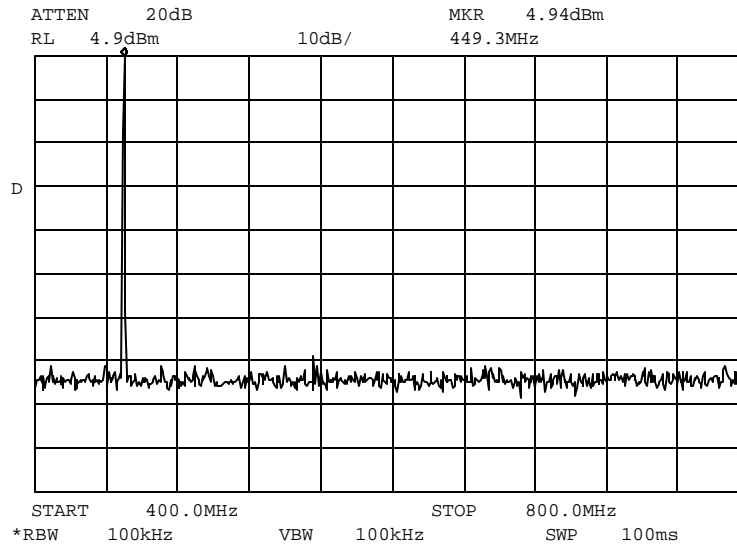

Power: HIGH  
 Modulation: NONE  
 Frequency: 450MHz

*Michael D Wyman*

Performed by:

Michael Wyman

Flom Test Labs  
 3356 North San Marcos Place, Suite 107  
 Chandler, Arizona 85225-7176  
 (866) 311-3268 phone, (480) 926-3598 fax

Measurement Plots

g0750042: 2007-May-08 Tue 10:11:00  
State: 2:High Power

Ambient Temperature: 23°C ± 3°C

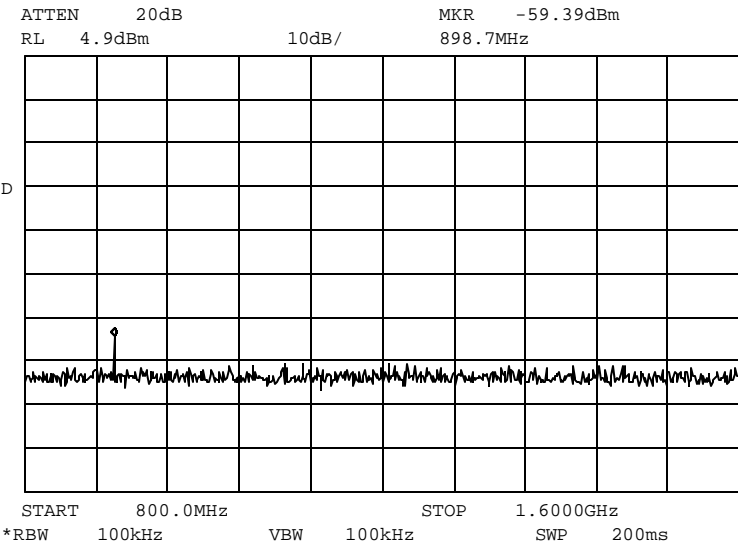

Power: HIGH  
Modulation: NONE

Performed by:

Michael Wyman

Flom Test Labs  
3356 North San Marcos Place, Suite 107  
Chandler, Arizona 85225-7176  
(866) 311-3268 phone, (480) 926-3598 fax

Measurement Plots

g0750043: 2007-May-08 Tue 10:14:00  
State: 2:High Power

Ambient Temperature: 23°C ± 3°C

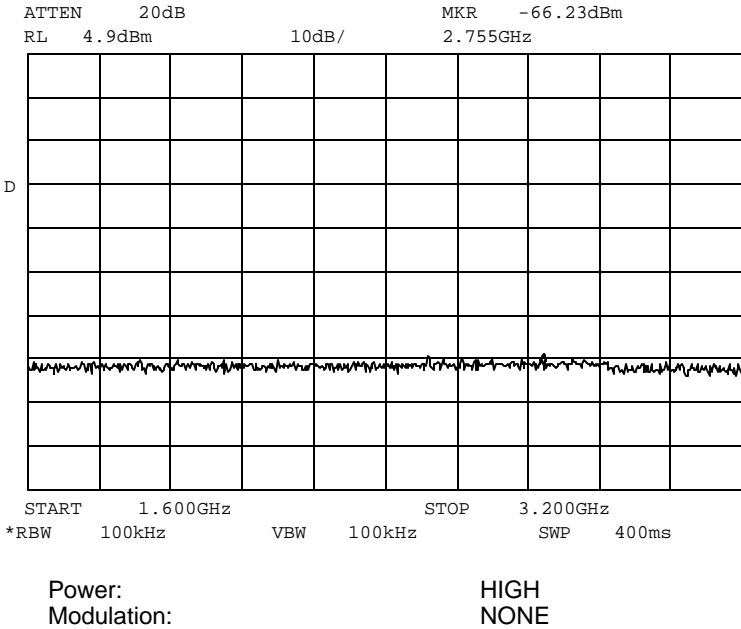

Performed by:

Michael Wyman

Flom Test Labs  
3356 North San Marcos Place, Suite 107  
Chandler, Arizona 85225-7176  
(866) 311-3268 phone, (480) 926-3598 fax

Page 14 of 45

MFA p0750002, d0760022

### Measurement Plots

g0750044: 2007-May-08 Tue 10:15:00  
State: 2:High Power

Ambient Temperature: 23°C ± 3°C

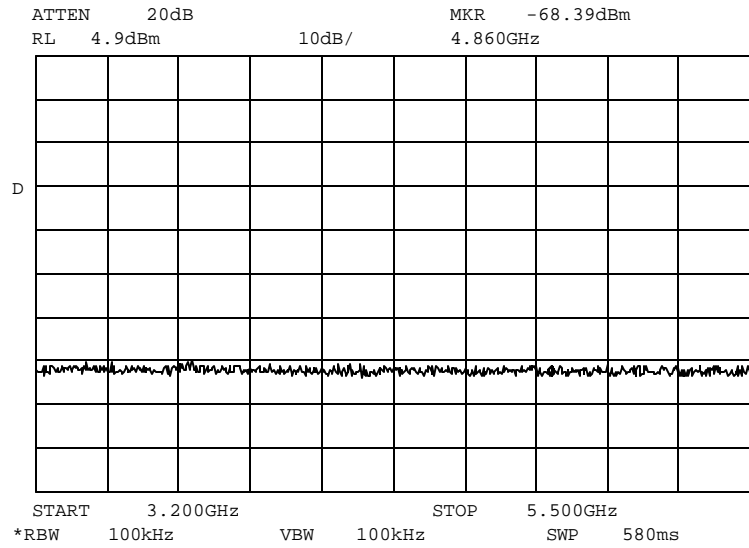

Power:  
Modulation:

HIGH  
NONE

Performed by:

Michael Wyman

**Name of Test:** Conducted Spurious Emissions

**Measurement Plots**

g0750045: 2007-May-08 Tue 10:16:00  
 State: 2:High Power

Ambient Temperature: 23°C ± 3°C

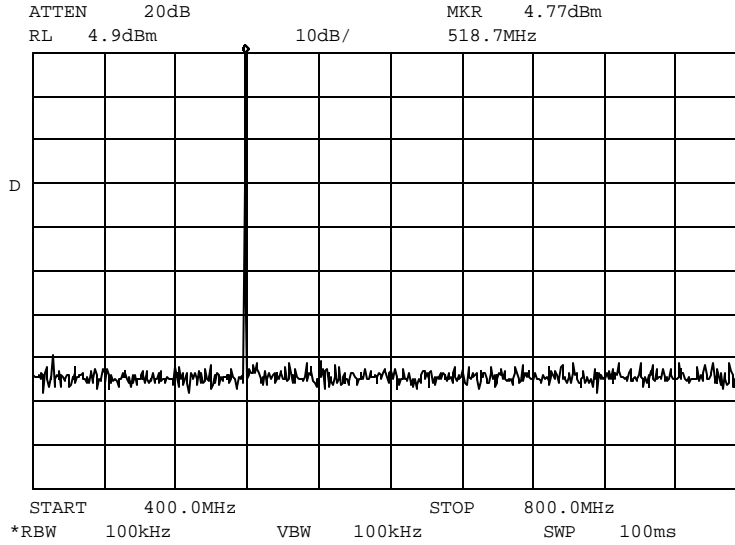

Power: HIGH  
 Modulation: NONE  
 Frequency: 520MHz

Performed by:

Michael Wyman

Name of Test: Conducted Spurious Emissions

Measurement Results

g0750046: 2007-May-08 Tue 10:17:00  
State: 2:High Power

Ambient Temperature: 23°C ± 3°C

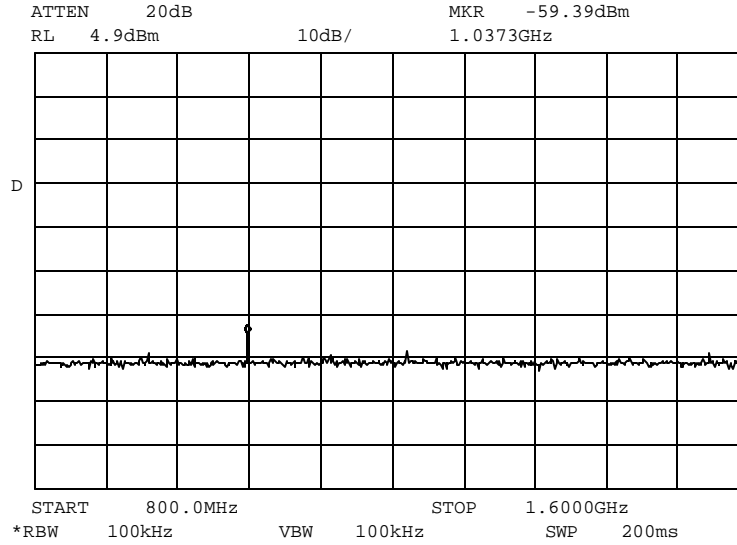

Power: HIGH  
Modulation: NONE

Performed by:

Michael Wyman

Name of Test: Conducted Spurious Emissions

Measurement Results

g0750047: 2007-May-08 Tue 10:17:00  
State: 2:High Power

Ambient Temperature: 23°C ± 3°C

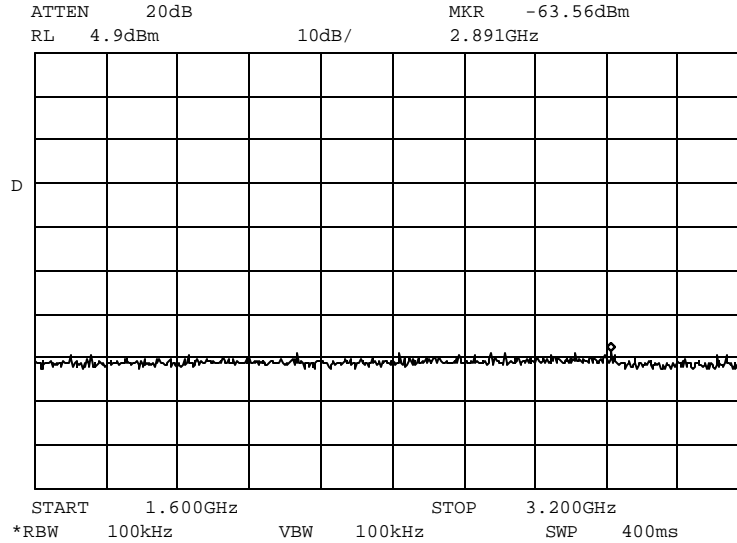

Power: HIGH  
Modulation: NONE

Performed by:

Michael Wyman



Name of Test: Conducted Spurious Emissions

Measurement Results

g0750048: 2007-May-08 Tue 10:18:00  
State: 2:High Power

Ambient Temperature: 23°C ± 3°C

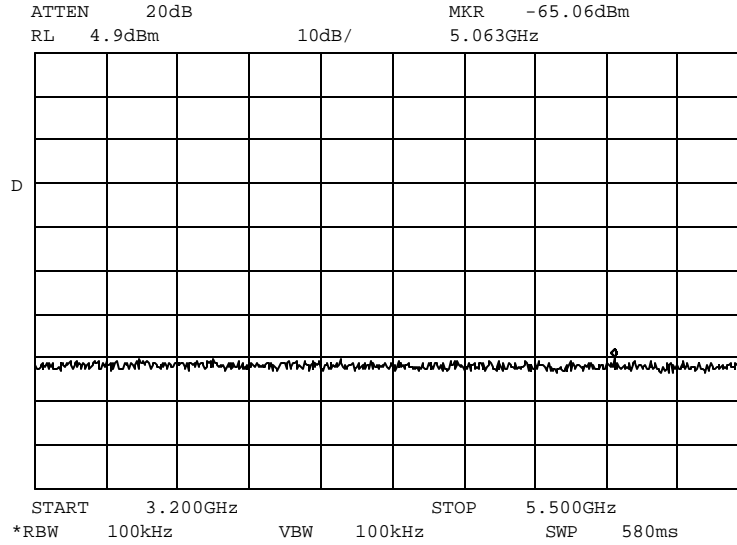

Power: HIGH  
Modulation: NONE

Performed by:

Michael Wyman

Flom Test Labs  
3356 North San Marcos Place, Suite 107  
Chandler, Arizona 85225-7176  
(866) 311-3268 phone, (480) 926-3598 fax

**Name of Test:** Field Strength of Spurious Radiation  
**Specification:** 47 CFR 2.1053(a)  
**Guide:** ANSI/TIA/EIA-603-C-2004, Paragraph 1.2.12 and Table 16, 47 CFR 22.917

**Measurement Procedure**

**Definition:**

Radiated spurious emissions are emissions from the equipment when transmitting into a non-radiating load on a frequency or frequencies which are outside an occupied band sufficient to ensure transmission of information of required quality for the class of communications desired.

**Method of Measurement:**

- A) Connect the equipment as illustrated
- B) Adjust the spectrum analyzer for the following settings:
  - 1) Resolution Bandwidth 100 kHz (<1 GHz), 1 MHz (> 1GHz).
  - 2) Video Bandwidth = 3 times Resolution Bandwidth, or 30 kHz (22.917)
  - 3) Sweep Speed  $\leq 2000$  Hz/second
  - 4) Detector Mode = Mean or Average Power
- C) Place the transmitter to be tested on the turntable in the standard test site. The transmitter is transmitting into a non-radiating load that is placed on the turntable. The RF cable to this load should be of minimum length.

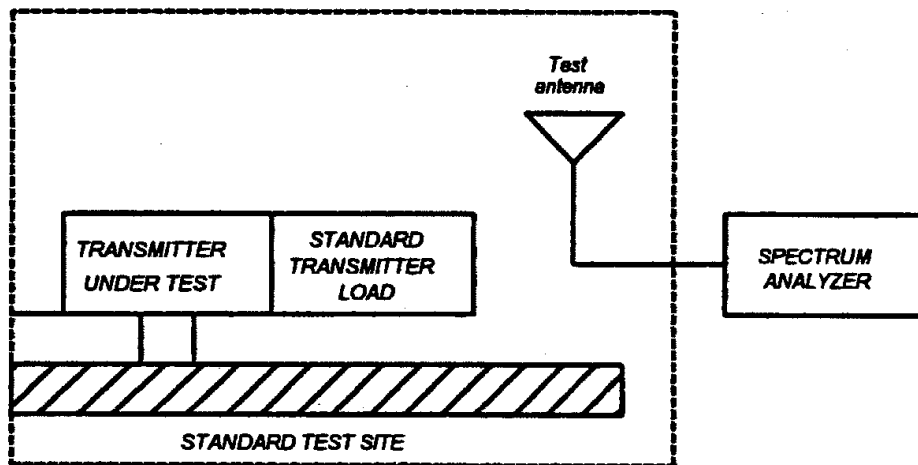

**Name of Test:** Field Strength of Spurious Radiation (Cont.)

- D) For each spurious measurement the test antenna should be adjusted to the correct length for the frequency involved. This length may be determined from a calibration ruler supplied with the equipment. Measurements shall be made from the lowest radio frequency generated in the equipment to the tenth harmonic of the carrier, except for the region close to the carrier equal to  $\pm$  the test bandwidth (see section 1.3.4.4).
- E) For each spurious frequency, raise and lower the test antenna from 1 m to 4 m to obtain a maximum reading on the spectrum analyzer with the test antenna at horizontal polarity. Repeat this procedure to obtain the highest possible reading. Record this maximum reading.
- F) Repeat step E) for each spurious frequency with the test antenna polarized vertically.

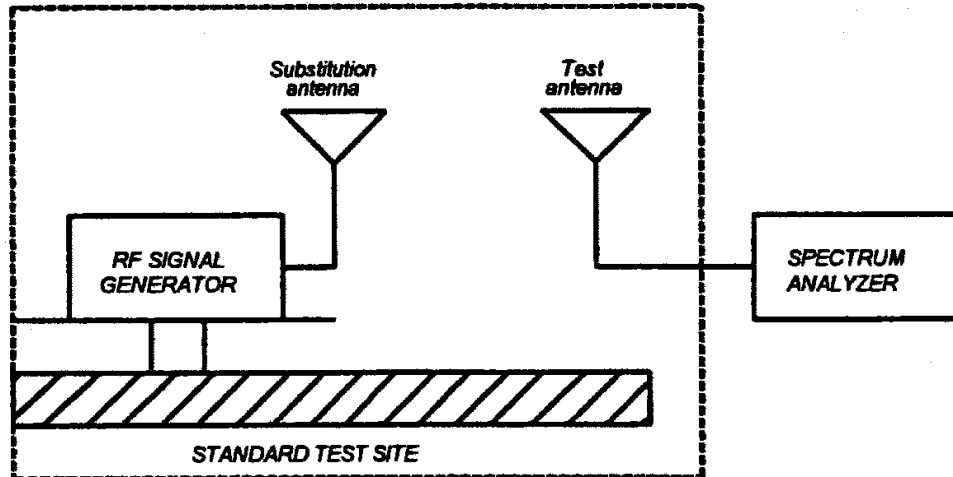

- G) Reconnect the equipment as illustrated.
- H) Keep the spectrum analyzer adjusted as in step B).
- I) Remove the transmitter and replace it with a substitution antenna (the antenna should be half wavelength for each frequency involved). The center of the substitution antenna should be approximately at the same location as the center of the transmitter. At lower frequencies, where the substitution antenna is very long, this will be impossible to achieve when the antenna is polarized vertically. In such case the lower end of the antenna should be 0.3 m above the ground.

**Name of Test:** Field Strength of Spurious Radiation (Cont.)

- J) Feed the substitution antenna at the transmitter end with a signal generator connected to the antenna by means of a non-radiating cable. With the antennas at both ends horizontally polarized and with the signal generator tuned to a particular spurious frequency, raise and lower the test antenna to obtain a maximum reading at the spectrum analyzer. Adjust the level of the signal generator output until the previously recorded maximum reading for this set of conditions is obtained. This should be done carefully repeating the adjustment of the test antenna and generator output.
- K) Repeat step J) with both antennas vertically polarized for each spurious frequency.
- L) Calculate power in dBm into a reference ideal half-wave dipole antenna by reducing the readings obtained in steps J) and K) by the power loss in the cable between the generator and the antenna and further corrected for the gain of the substitution antenna used relative to an ideal halfwave dipole antenna.
- M) The levels recorded in step L) are absolute levels of radiated spurious emissions in dBm. The radiated spurious emissions in dB can be calculated by the following:

Radiated spurious emissions dB =

$$10\log_{10}(\text{TX power in watts}/0.001) - \text{the levels in step I)}$$

*NOTE: It is permissible that other antennas provided can be referenced to a dipole.*

### Test Equipment

Asset	Description	s/n	Cycle	Last Cal
<b>Transducer</b>				
i00088	EMCO 3109-B 25MHz-300MHz	2336	12 mo.	Oct-05
X i00089	Aprel 2001 200MHz-1GHz	001500	24 mo.	Oct-06
X i00103	EMCO 3115 1GHz-18GHz	9208-3925	24 mo.	Sep-06
<b>Amplifier</b>				
X i00028	HP 8449A	2749A00121	12 mo.	Jun-06
<b>Spectrum Analyzer</b>				
X i00029	HP 8563E	3213A00104	12 mo.	Jan-06
X i00033	HP 85462A	3625A00357	12 mo.	Oct-06
<b>Substitution Generator</b>				
X i00067	HP 8920A Communication TS	3345U01242	12 mo.	Jun-06
i00207	HP 8753D Network Analyzer	3410A08514	12 mo.	May-06

**Name of Test:** Field Strength of Spurious Radiation

**Measurement Results**

g0760053: 2007-Jun-21 Thu 20:46:00  
 STATE: 1:High Power

Ambient Temperature: 23°C ± 3°C

**Sample calculation**

Radiated ERP – Spurious Power = Spurious dBc

**Limit calculation**

Limit = 50 + 10 Log Radiated ERP

**Summary Results Table**

Tuned Frequency (MHz)	Emission Frequency (MHz)	Radiated ERP (dBm)	Spurious Power (dBm)	Spurious (dBc)	Limit (dBc)
450.05	900.12	38.3	-32.1	-70.4	-65.83
450.05	1350.25	38.3	-61.5	-99.8	-65.83
450.05	1800.02	38.3	-62.0	-100.3	-65.83
450.05	2200.25	38.3	-59.7	-98.0	-65.83
450.05	2700.30	38.3	-57.7	-96.0	-65.83
450.05	3150.35	38.3	-55.7	-94.0	-65.83
450.05	3600.40	38.3	-53.9	-92.2	-65.83
450.05	4050.45	38.3	-52.0	-90.3	-65.83

Tuned Frequency (MHz)	Emission Frequency (MHz)	Radiated ERP (dBm)	Spurious Power (dBm)	Spurious (dBc)	Limit (dBc)
519.95	1039.95	38.5	-34.4	-72.9	-65.84
519.95	1559.85	38.5	-37.1	-75.6	-65.84
519.95	2079.80	38.5	-52.6	-91.1	-65.84
519.95	2599.75	38.5	-53.0	-91.5	-65.84
519.95	3119.70	38.5	-51.0	-89.5	-65.84
519.95	3639.65	38.5	-48.9	-87.4	-65.84
519.95	4159.60	38.5	-46.9	-85.4	-65.84
519.95	4679.55	38.5	-45.8	-84.3	-65.84
519.95	5199.50	38.5	-43.2	-81.7	-65.84

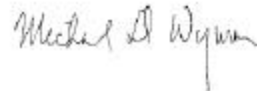

Performed by:

Michael Wyman

**Name of Test:** Emission Masks (Occupied Bandwidth)  
**Specification:** 47 CFR 2.1049(c)(1), 90.210  
**Guide:** ANSI/TIA/EIA-603-C-2004, Paragraph 2.2.11

**Measurement Procedure**

- A) The EUT and test equipment were set up as shown below
- B) For EUTs supporting audio modulation, the audio signal generator was adjusted to the frequency of maximum response and with output level set for  $\pm 2.5/\pm 1.25$  kHz deviation (or 50% modulation). With level constant, the signal level was increased 16 dB.
- C) For EUTs supporting digital modulation, the digital modulation mode was operated to its maximum extent.
- D) The Occupied Bandwidth was measured with the Spectrum Analyzer controls set as shown on the test results.

**Transmitter Test Set-Up: Occupied Bandwidth**

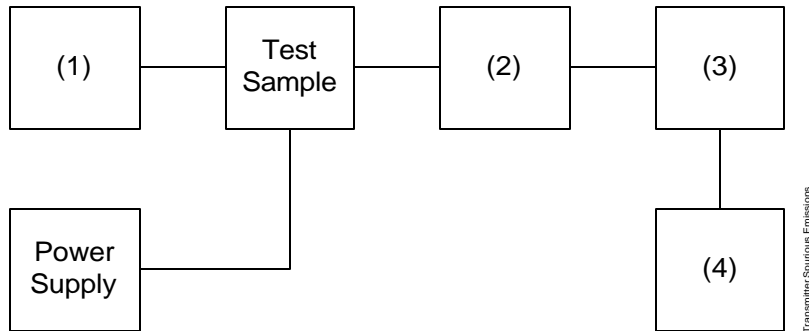

Asset	Description	s/n	Cycle	Last Cal
<b>(1) Audio Oscillator/Generator</b>				
X i00324	HP 8903B Modulation Meter	3011A09079	12 mo.	Oct-06
<b>(2) Coaxial Attenuator</b>				
X i00231/2	PASTERNAK PE7021-30 (30 dB)	231 or 232	N/A	NCR
i00123	NARDA 766 (10 dB)	7802A	N/A	NCR
<b>(3) Interface</b>				
X i00021	HP 8954A Transceiver Interface	2146A00159	N/A	NCR
<b>(4) Spectrum Analyzer</b>				
X i00048	HP 8566B Spectrum Analyzer	2511A01467	12 mo.	Aug-06
i00029	HP 8563E Spectrum Analyzer	3213A00104	12 mo.	Jan-06

Name of Test: Emission Masks (Occupied Bandwidth)

Measurement Results

g0750049: 2007-May-08 Tue 14:06:00  
State: 2:High Power

Ambient Temperature: 23°C ± 3°C

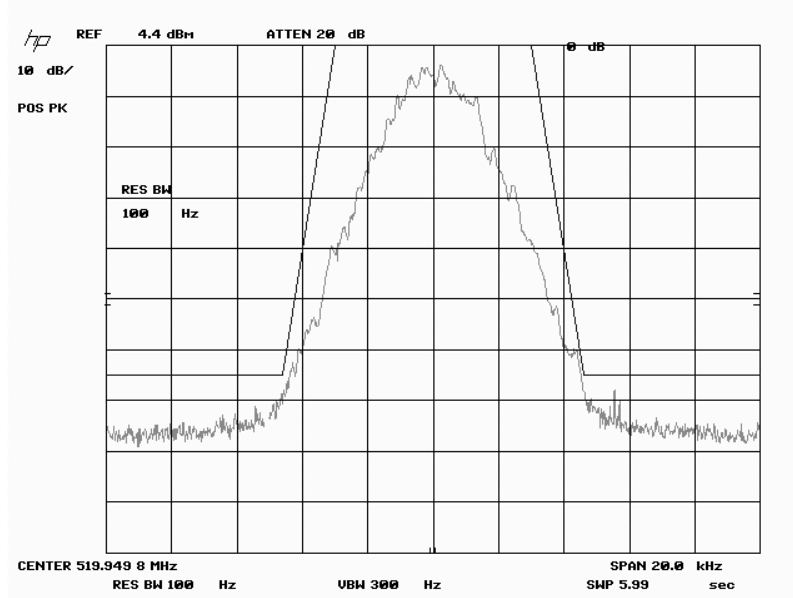

Power: HIGH  
Modulation: 6.25KHz BW

*Michael D Wyman*

Performed by:

Michael Wyman

**Name of Test:** Emission Masks (Occupied Bandwidth)

**Measurement Results**

g0750050: 2007-May-08 Tue 14:08:00  
 State: 2:High Power

Ambient Temperature: 23°C ± 3°C

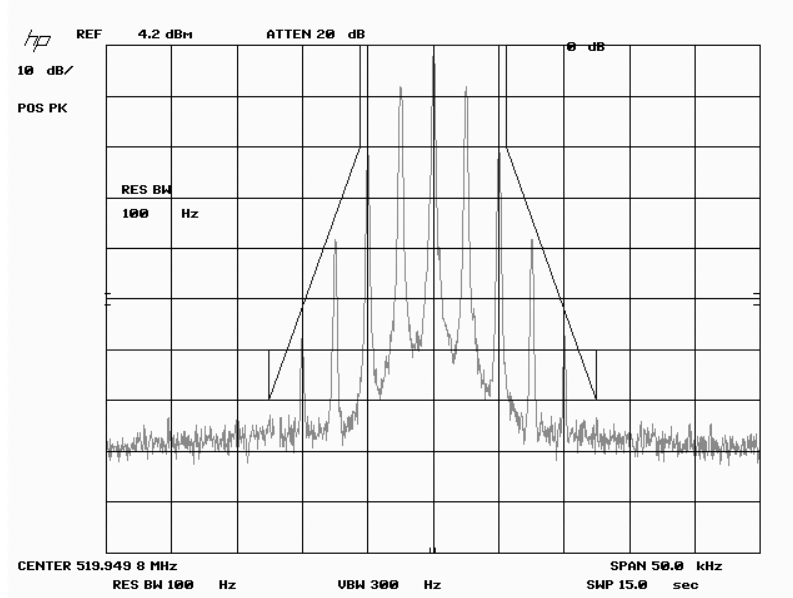

Power: HIGH  
 Modulation: 12.50 KHz BW

*Michael D Wyman*

Performed by:

Michael Wyman



Name of Test: Emission Masks (Occupied Bandwidth)

Measurement Results

g0750050: 2007-May-08 Tue 14:08:00  
State: 2:High Power

Ambient Temperature: 23°C ± 3°C

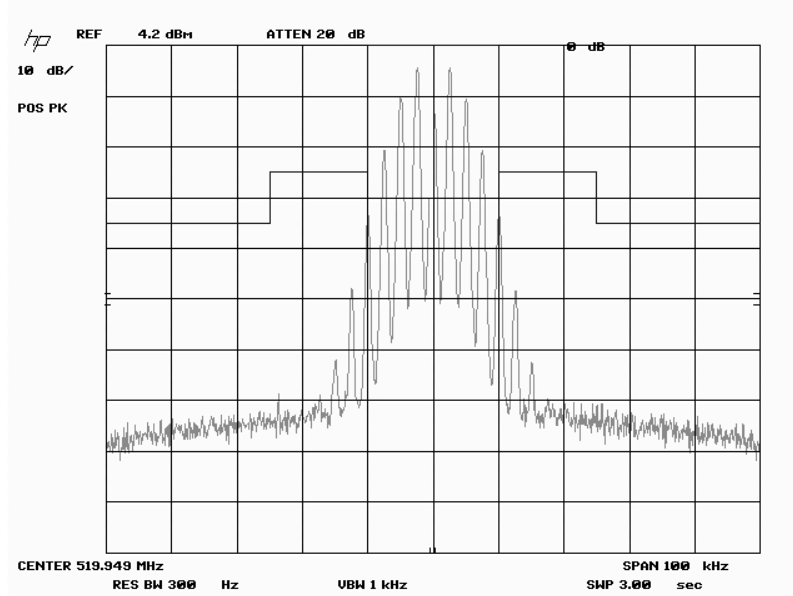

Power:  
Modulation:

HIGH  
25.00 KHz BW

Performed by:

Michael Wyman

**Name of Test:** Transient Frequency Behavior  
**Specification:** 47 CFR 90.214  
**Guide:** ANSI/TIA/EIA-603-C-2004, Paragraph 2.2.19

#### Measurement Procedure

- A) The EUT was setup as shown on the attached page, following TIA/EIA-603 steps a, b, and c as a *guide*.
- B) The transmitter was turned on.
- C) Sufficient attenuation was provided so that the transmitter carrier level measured at the output of the combiner was 40 dB below the maximum input level of the test receiver. This level was recorded.
- D) The transmitter was turned off.
- E) An RF signal generator (1) modulated with a 1 kHz tone at either 25, 12.5, or 6.25 kHz deviation, and set to the same frequency as the assigned transmitter frequency, (2) was adjusted to a level -20 dB below the level recorded for step C) above, measured at the output of the combiner. This level was then fixed for the remainder of the test.
- F) The oscilloscope was setup using TIA/EIA-603 steps j and k as a guide, and to either 10 ms/div (UHF) or 5 ms/div (VHF).
- G) The 30 dB attenuator was removed, the transmitter was turned on, and the level of the carrier at the output of the combiner was recorded.
- H) The carrier on-time as referenced in TIA/EIA-603 steps m, n, and o was captured and plotted. The carrier off-time as referenced in TIA/EIA-603 steps p, q, r, and s was captured and plotted.

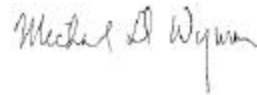

Performed by:

Michael Wyman

Name of Test: Transient Frequency Behavior

Transmitter Set-Up

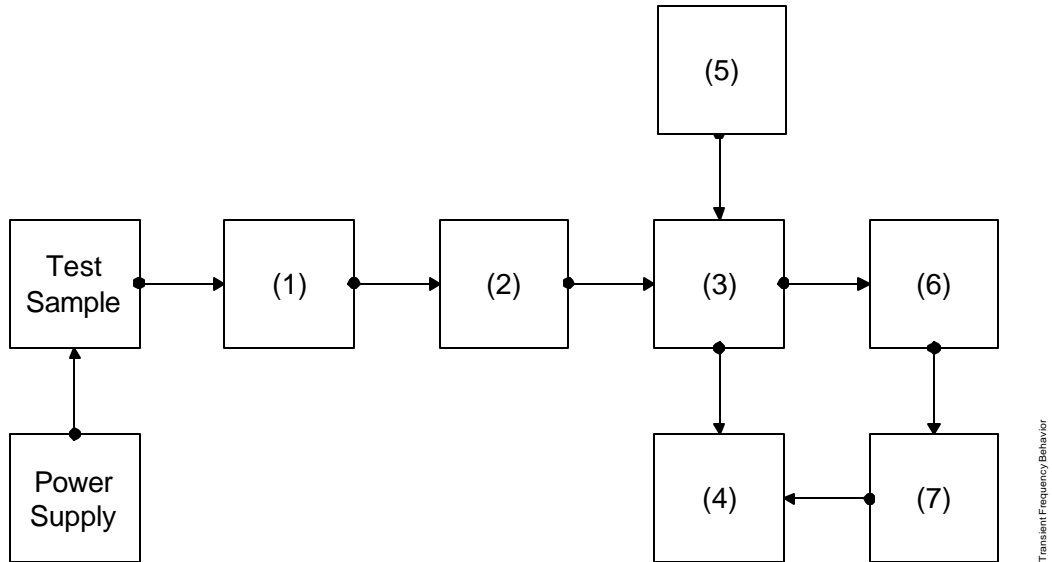

Asset	Description	s/n	Cycle	Last Cal
(1) <b>Attenuator</b>	(Removed after 1st step)			
X i00231/2	PASTERNAK PE7021-30 (30 dB)	231 or 232	N/A	NCR
(2) <b>Attenuator</b>				
X i00231/2	PASTERNAK PE7021-30 (30 dB)	231 or 232	N/A	NCR
i00122/3	NARDA 766 (10 dB)	7802 or 7802A	N/A	NCR
(3) <b>Combiner</b>				
X i00154	4 x 25 Ω Combiner	154	N/A	NCR
(4) <b>Crystal Decoder</b>				
X i00159	HP 8470B Crystal Detector	1822A10054	N/A	NCR
(5) <b>RF Signal Generator</b>				
X i00067	HP 8920A Communication TS	3345U01242	12 mo.	Jun-06
(6) <b>Modulation Analyzer</b>				
X i00321	HP 8901A Modulation Meter	2239A02170	12 mo.	Sep-06
(7) <b>Oscilloscope</b>				
X i00318	HP 54502A Digital Oscilloscope	2934A00688	12 mo.	Sep-06

Name of Test: Transient Frequency Behavior

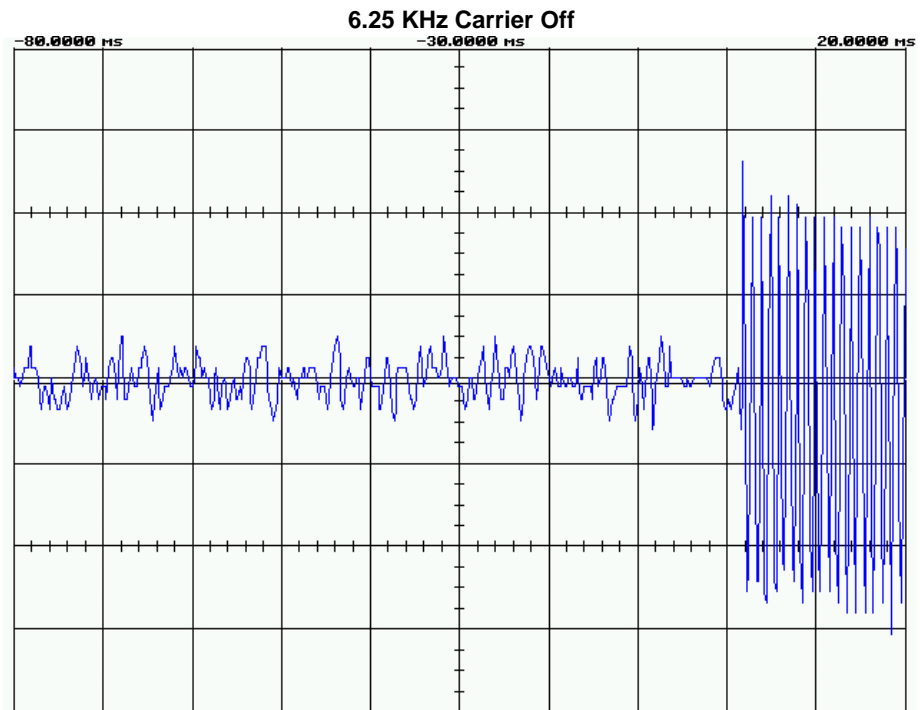
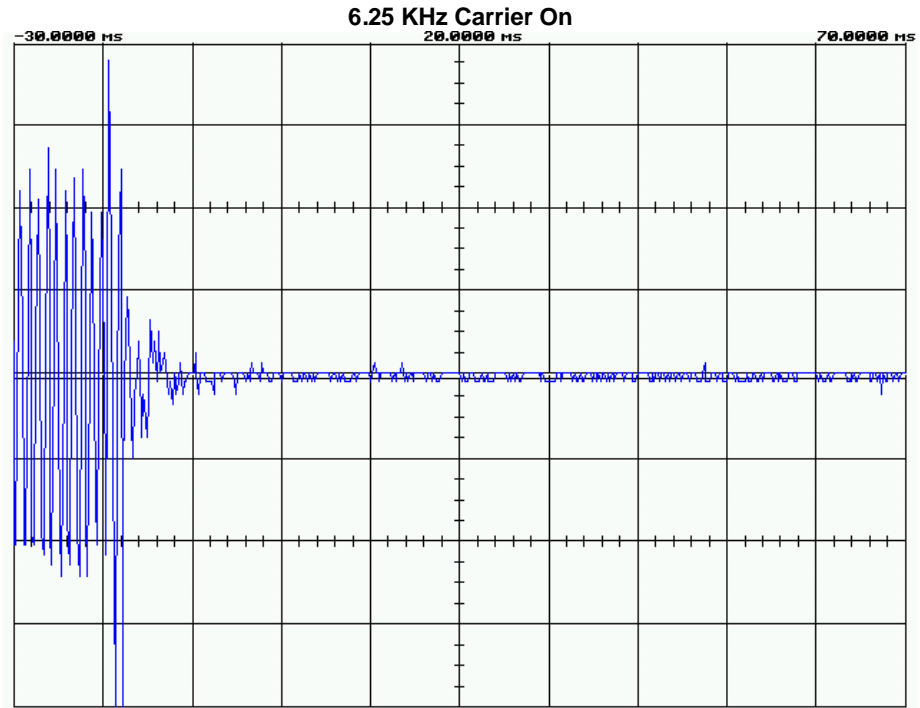

### 12.5 KHz Carrier On

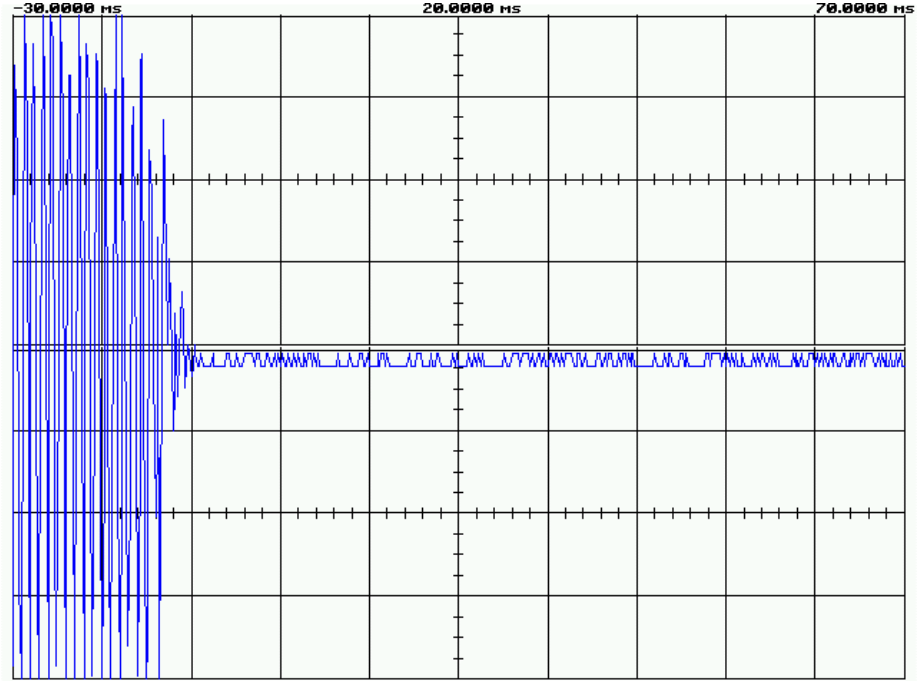

### 12.5 KHz Carrier Off

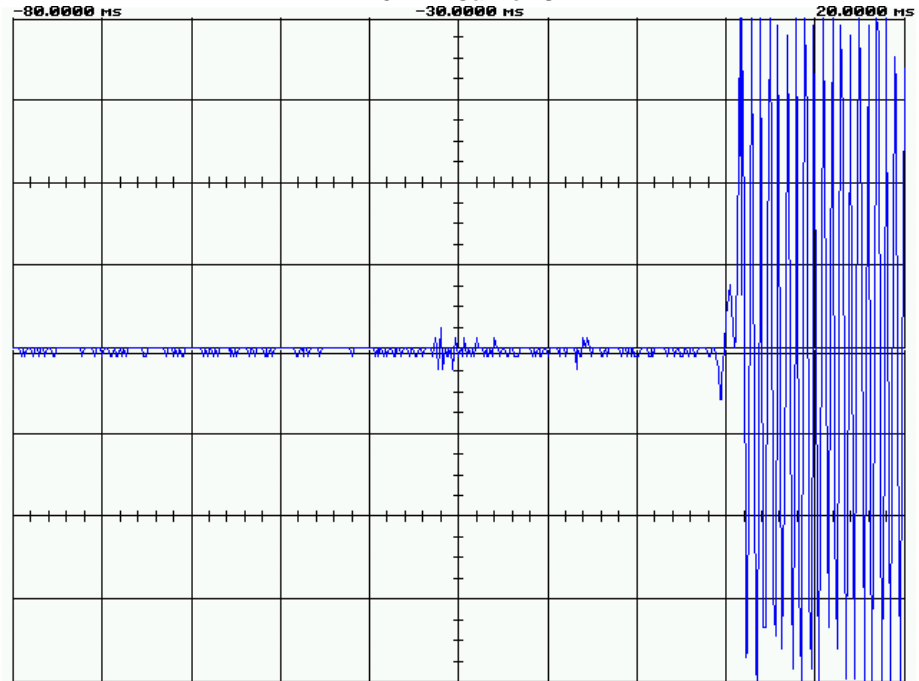

### 25 KHz Carrier On

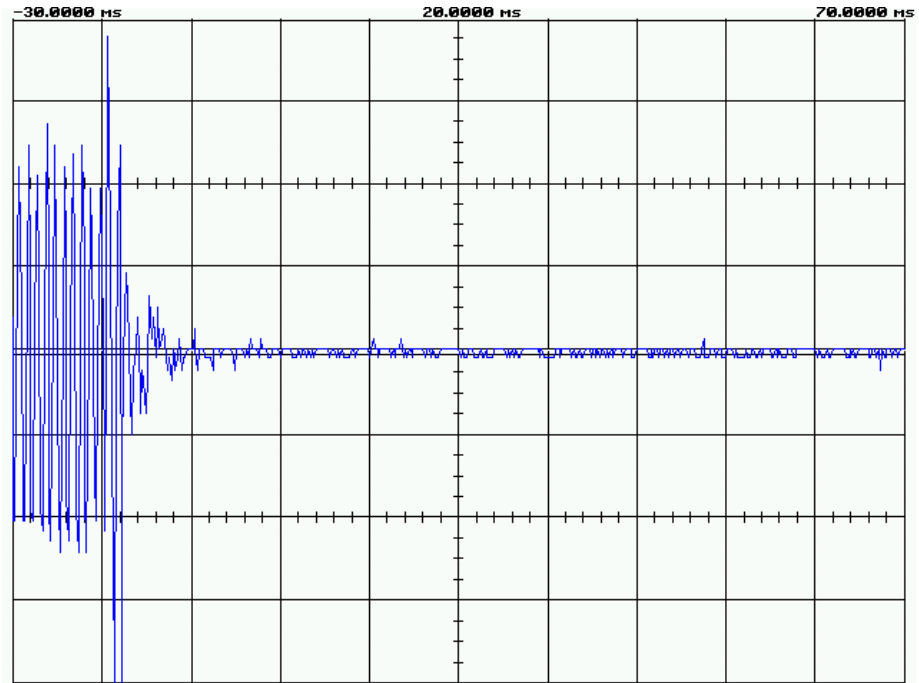

### 25 KHz Carrier Off

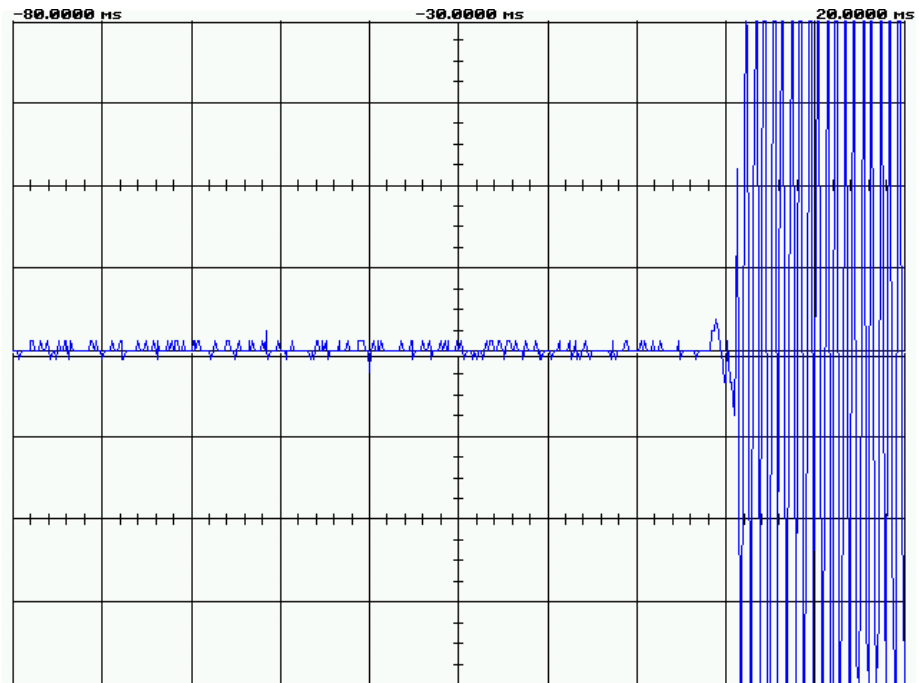

**Name of Test:** Audio Low Pass Filter (Voice Input)  
**Specification:** 47 CFR 2.1047(a)  
**Guide:** ANSI/TIA/EIA-603-C-2004, Paragraph 2.2.15

**Measurement Procedure**

- A) The EUT and test equipment were set up such that the audio input was connected at the input to the modulation limiter, and the modulated stage.
- B) The audio output was connected at the output to the modulated stage.

**Transmitter Test Set-Up: Response of Low Pass Filter**

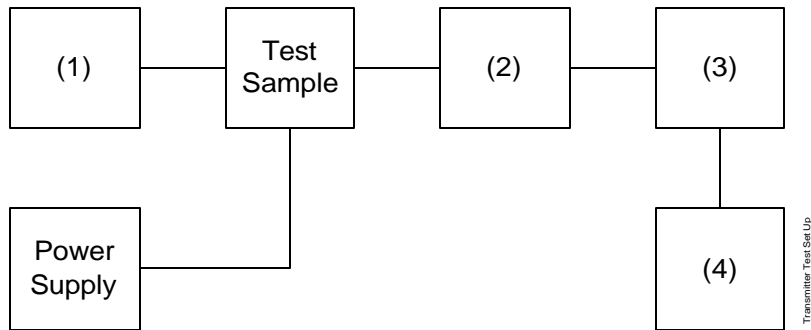

Asset	Description	s/n	Cycle	Last Cal
(1)	<b>Audio Oscillator</b>			
i00002	HP 3336B Synthesizer / Level Gen.	1931A01465	12 mo	Jun-06
(2)	<b>Coaxial Attenuator</b>			
i00122/3	NARDA 766 (10dB)10	7802 or 7802A	N/A	NCR
X i00231/2	PASTERNAK PE7021-30 (30 dB)	231 or 232	N/A	NCR
(3)	<b>Modulation Analyzer</b>			
X i00321	HP 8901A Modulation Analyzer	2239A02170	12 mo.	Sep-06
(4)	<b>Audio Analyzer</b>			
X I00324	HP 8903B Audio Analyzer	3011A09079	12 mo.	Oct-06

Name of Test: Audio Low Pass Filter (Voice Input)

Measurement Results

g0760035: 2007-Jun-21 Thu 13:49:00  
State: 0:General

Ambient Temperature: 23°C ± 3°C

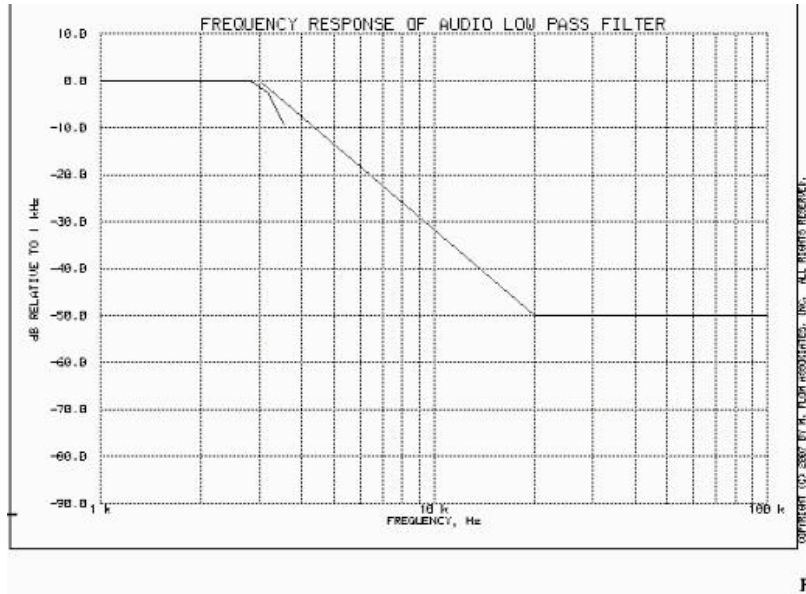

Performed by:

Michael Wyman

Flom Test Labs  
3356 North San Marcos Place, Suite 107  
Chandler, Arizona 85225-7176  
(866) 311-3268 phone, (480) 926-3598 fax



**Name of Test:** Audio Frequency Response  
**Specification:** 47 CFR 2.1047(a)  
**Guide:** ANSI/TIA/EIA-603-C-2004, Paragraph 2.2.6

**Measurement Procedure**

- A) The EUT and test equipment were set up as shown below.
- B) The audio signal generator was connected to the audio input circuit/microphone of the EUT.
- C) The audio signal input was adjusted to obtain 20% modulation at 1 kHz, and this point was taken as the 0 dB reference level.
- D) With input levels held constant and below limiting at all frequencies, the audio signal generator was varied from 100 Hz to 50 kHz.
- E) The response in dB relative to 1 kHz was measured, using the HP 8901A Modulation Meter.

**Transmitter Test Set-Up: Audio Frequency Response**

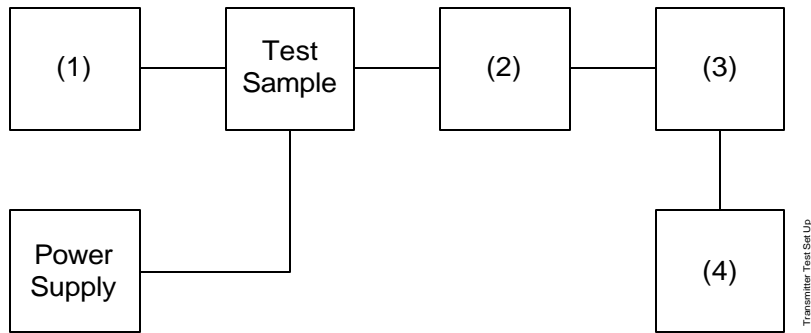

Asset	Description	s/n	Cycle	Last Cal
<b>(1) Audio Oscillator</b>				
X	i00324 HP 8903B Audio Analyzer	3011A09079	12 mo.	Oct-06
<b>(2) Coaxial Attenuator</b>				
	i00122/3 NARDA 766-(10 dB)	7802 or 7802A	N/A	NCR
X	i00231/2 PASTERNAK PE7021-30 (30 dB)	231 or 232	N/A	NCR
<b>(3) Modulation Analyzer</b>				
X	i00321 HP 8901A Modulation Analyzer	2239A02170	12 mo.	Sep-06
<b>(4) Audio Analyzer</b>				
X	i00324 HP 8903B Audio Analyzer	3011A09079	12 mo.	Oct-06

Name of Test: Audio Frequency Response

**Measurement Results**

g0760034: 2007-Jun-21 Thu 13:44:00

State: 0:General

Ambient Temperature: 23°C ± 3°C

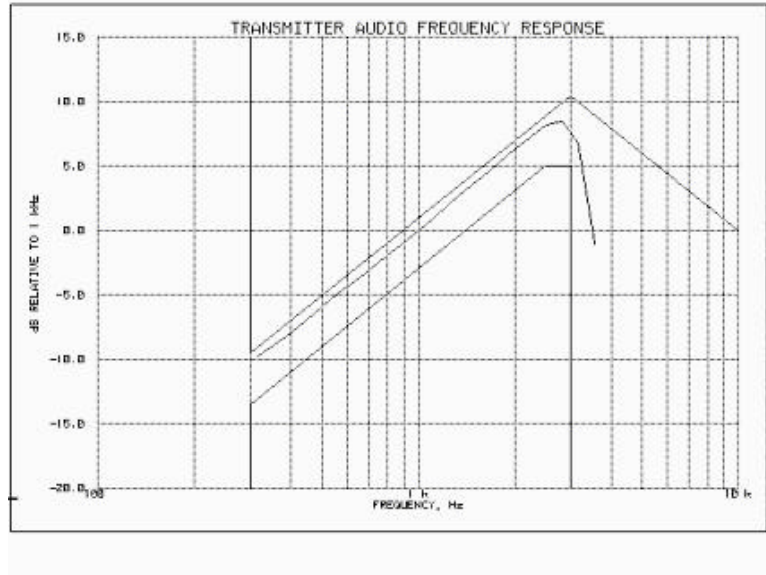

Frequency of Maximum Audio Response, Hz = 2820

Additional points:

Frequency, Hz	Level, dB
300	-10.23
20000	-18.41
30000	-18.52
50000	-18.42

Performed by:

Michael Wyman

**Name of Test:** Modulation Limiting  
**Specification:** 47 CFR 2.1047(b)  
**Guide:** ANSI/TIA/EIA-603-C-2004, Paragraph 2.2.3

**Measurement Procedure**

- A) The signal generator was connected to the input of the EUT as shown below.
- B) The modulation response was measured for each of three frequencies (one of which was the frequency of maximum response), and the input voltage was varied and was observed on an HP 8901A Modulation Analyzer.
- C) The input level was varied from 30% modulation ( $\pm 1.5$  kHz deviation) to at least 20 dB higher than the saturation point.
- D) Measurements were performed for both negative and positive modulation and the respective results were recorded.

**Transmitter Test Set-Up: Modulation Limiting**

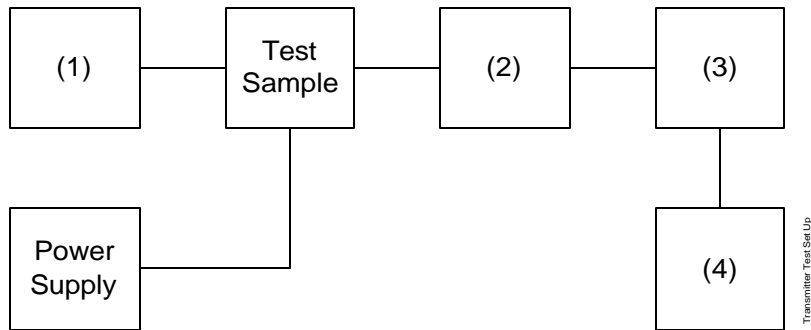

Asset	Description	s/n		
<b>(1) Audio Oscillator</b>				
X	i00324 HP 8903B Audio Analyzer	3011A09079	12 mo.	Oct-06
<b>(2) Coaxial Attenuator</b>				
	i0012/23 NARDA 766-(10 dB)	7802 or 7802A	N/A	NCR
X	i00231/2 PASTERNAK PE7021-30 (30 dB)	231 or 232	N/A	NCR
<b>(3) Modulation Analyzer</b>				
X	i00321 HP 8901A Modulation Meter	2239A02170	12 mo.	Sep-06
<b>(4) Audio Analyzer</b>				
X	i00324 HP 8903B Audio Analyzer	3011A09079	12 mo.	Oct-06

Name of Test: Modulation Limiting

Measurement Results

g0760037: 2007-Jun-21 Thu 14:00:00

State: 0:General

Ambient Temperature: 23°C ± 3°C

Positive Peaks:

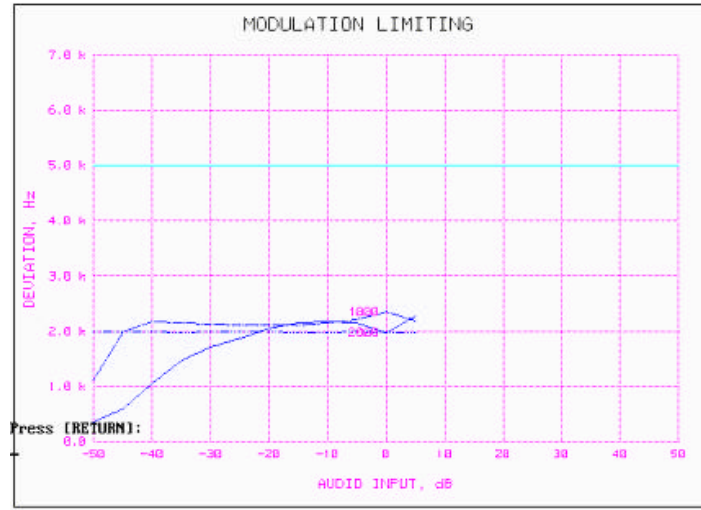

Negative Peaks:

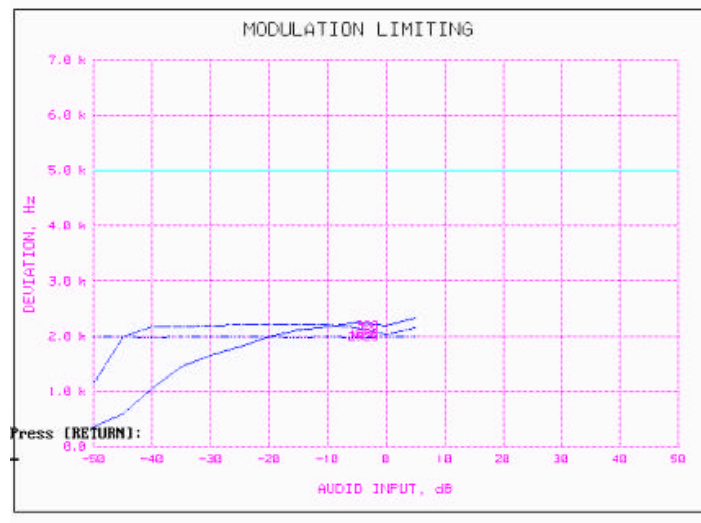

*Michael D Wyman*

Performed by:

Michael Wyman

Flom Test Labs  
 3356 North San Marcos Place, Suite 107  
 Chandler, Arizona 85225-7176  
 (866) 311-3268 phone, (480) 926-3598 fax

Name of Test: Modulation Limiting

Measurement Results

g0760037: 2007-Jun-21 Thu 14:00:00

State: 0:General

Ambient Temperature: 23°C ± 3°C

25 K Positive Peaks:

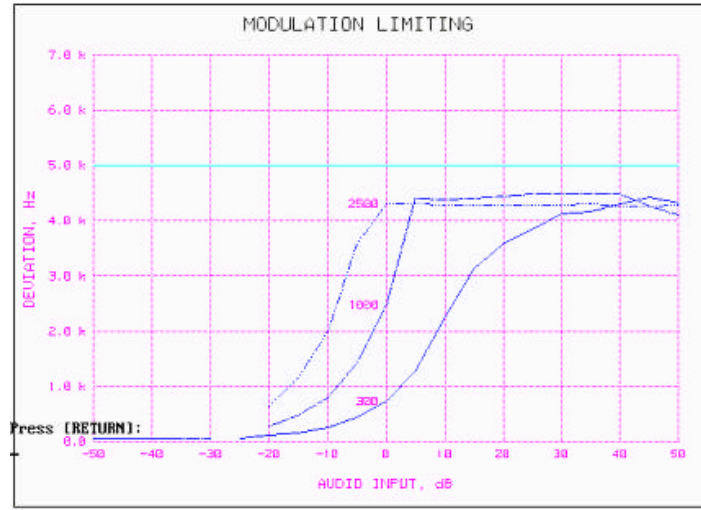

25K Negative Peaks:

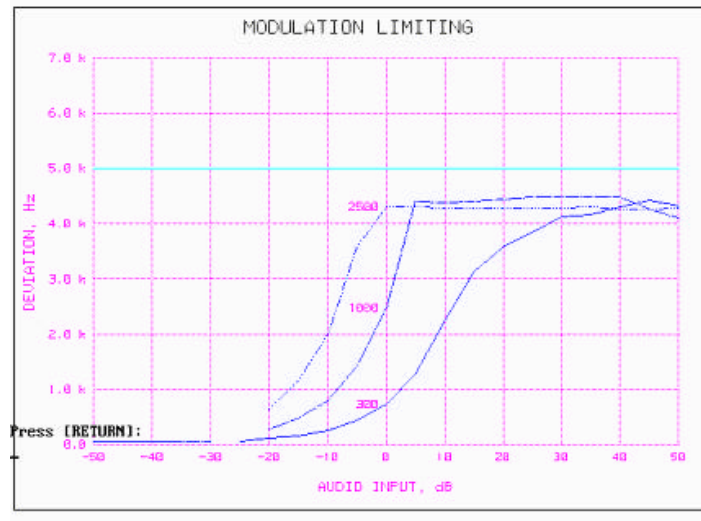

*Michael D Wyman*

Performed by:

Michael Wyman

Flom Test Labs  
 3356 North San Marcos Place, Suite 107  
 Chandler, Arizona 85225-7176  
 (866) 311-3268 phone, (480) 926-3598 fax

**Name of Test:** Frequency Stability (Temperature Variation)  
**Specification:** 47 CFR 2.1055(a)(1)  
**Guide:** ANSI/TIA/EIA-603-C-2004, Paragraph 2.2.2

**Measurement Procedure**

- A) The EUT and test equipment were set up as shown on the following page.
- B) With all power removed, the temperature was decreased to -30°C and permitted to stabilize for three hours. Power was applied and the maximum change in frequency was noted within one minute.
- C) With power OFF, the temperature was raised in 10°C steps. The sample was permitted to stabilize at each step for at least one-half hour. Power was applied and the maximum frequency change was noted within one minute.
- D) The temperature tests were performed for the worst case.

**Transmitter Test Set-Up: Temperature Variation**

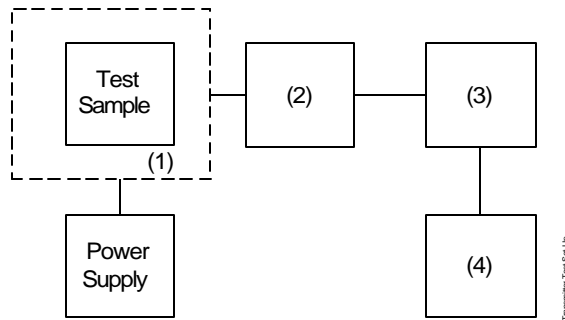

Asset	Description	s/n	Cycle	Last Cal
<b>(1) Temperature, Humidity, Vibration</b>				
X	i00027 Tenney Temp. Chamber	9083-765-234	12 mo.	Sep-06
<b>(2) Coaxial Attenuator</b>				
X	i00231/2 PASTERNAK PE7021-30 (30 dB)	231 or 232	N/A	NCR
	i00122/3 NARDA 766 (10 dB)	7802 or 7802A	N/A	NCR
<b>(3) RF Power</b>				
X	i00067 HP 8920A Communications TS	3345U01242	12 mo.	Jun-06
<b>(4) Frequency Counter</b>				
X	i00067 HP 8920A Communications TS	3345U01242	12 mo.	Jun-06

Name of Test: Frequency Stability (Temperature Variation)

Measurement Results

g0760048: 2007-Jun-19 Tue 17:22:00  
State: 0:General

Ambient Temperature: 23°C ± 3°C

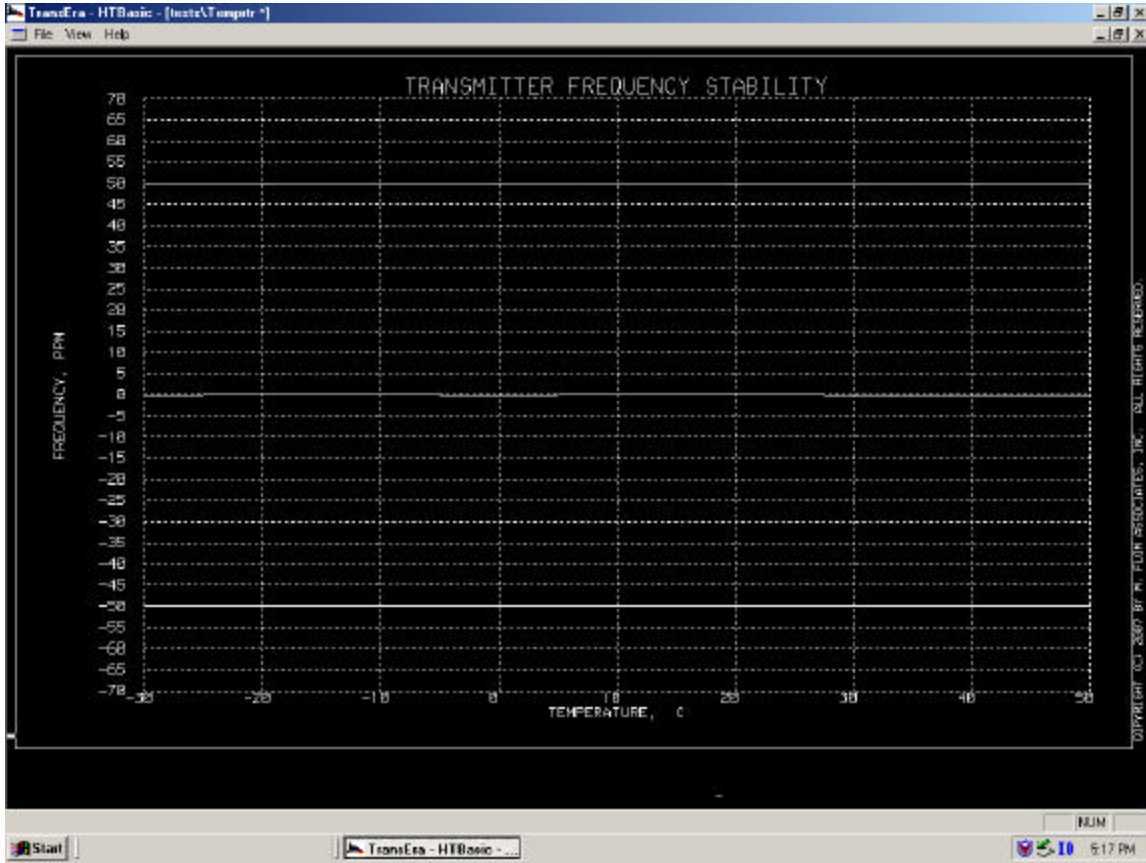

*Michael D Wyman*

Performed by:

Michael Wyman

**Name of Test:** Frequency Stability (Voltage Variation)  
**Specification:** 47 CFR 2.1055(d)(1)  
**Guide:** ANSI/TIA/EIA-603-C-2004, Paragraph 2.2.2

**Measurement Procedure**

- A) The EUT was placed in a temperature chamber (if required) at 25±5°C and connected as shown below.
- B) The power supply voltage to the EUT was varied from 85% to 115% of the nominal value measured at the input to the EUT.
- C) The variation in frequency was measured for the worst case.

**Transmitter Test Set-Up: Voltage Variation**

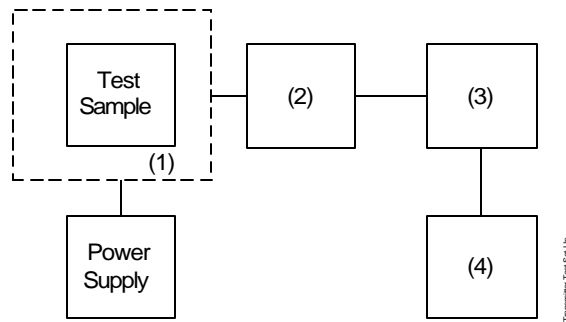

Asset	Description	s/n	Cycle	Last Cal
<b>(1) Temperature, Humidity, Vibration</b>				
i00027	Tenney Temp. Chamber	9083-765-234	N/A	NCR
<b>(2) Coaxial Attenuator</b>				
X i00231/2	PASTERNAK PE7021-30 (30 dB)	231 or 232	N/A	NCR
i00122/3	NARDA 766 (10 dB)	7802 or 7802A	N/A	NCR
<b>(3) RF Power</b>				
X i00321	HP 8901A Power Mode	2239A02170	12 mo.	Sep-06
<b>(4) Frequency Counter</b>				
X i00321	HP 8901A Frequency Mode	2239A02170	12 mo.	Sep-06



**Results:** Frequency Stability (Voltage Variation)

**State:** Ambient Temperature: 23°C ± 3°C

 Limit, ppm = 2.5  
 Limit, Hz = 1300  
 Battery End Point (Voltage) = 6.00

% of STV	Voltage	Frequency, MHz	Change, Hz	Change, ppm
115	8.63	519.950413	4	0
100	7.50	519.950409	0	0
85	6.38	519.950408	1	0
Dropout Voltage	6.0	519.950423	14	.001

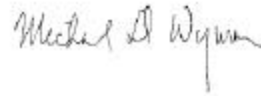
**Performed by:**
**Michael Wyman**

Name of Test: Necessary Bandwidth and Emission Bandwidth

## Necessary Bandwidth and Emission Bandwidth - 47cfr 2.202(g)

### CALCULATION RESULTS

State: **16K0F3E** (25 kHz channel bandwidth)

Item	Mark	
Maximum modulation frequency	M	3 kHz
Peak frequency deviation	D	5 kHz
Numerical factor	K	1
Necessary bandwidth	Bn	16 kHz

$$Bn=(2xM)+(2xDxK)$$

State: **11K0F3E** (12.5 kHz channel bandwidth)

Item	Mark	
Maximum modulation frequency	M	3 kHz
Peak frequency deviation	D	2.5 kHz
Numerical factor	K	1
Necessary bandwidth	Bn	16 kHz

$$Bn=(2xM)+(2xDxK)$$

State: **8K00F1E / 8K00F1D / 8K00F7W** (4 Level FSK / 9600bps, 12.5 kHz channel BW)

Item	Mark	
Digital information rate	R	9600 bps
Peak frequency deviation	D	3.056 kHz
Signaling states	S	4
Numerical factor	K	0.516
Necessary bandwidth	Bn	8 kHz

$$Bn=(R/Log_2S)+2DK$$

State: **3K80F1E / 3K80F1D / 3K80F7W** (4 Level FSK / 4800bps, 6.25 kHz channel BW)

Item	Mark	
Digital information rate	R	4800 bps
Peak frequency deviation	D	1.337 kHz
Signaling states	S	4
Numerical factor	K	0.516
Necessary bandwidth	Bn	3.8 kHz

$$Bn=(R/Log_2S)+2DK$$

State: **3K80F2D** (CWID 6.25 kHz channel bandwidth)

Item	Mark	
Maximum modulation frequency	M	1.1 kHz
Peak frequency deviation	D	0.8 kHz
Numerical factor	K	1
Necessary bandwidth	Bn	3.8 kHz

$$B_n = (2 \times M) + (2 \times D \times K)$$

State: **8K10F1D / 8K10F1E** (C4FM / 9600bps, 12.5 kHz channel bandwidth)

Item	Mark	
Digital information rate	R	9600 bps
Peak frequency deviation	D	3.111kHz
Signaling states	S	4
Numerical factor	K	1
Necessary bandwidth	Bn	8.1 kHz Measurements were done*

\*Measurements per Rule 47CFR Part 2.202(c)(4) were done because Part 2.202(g) Table IIIA.1.

formulation produces an excessive result using the value of K recommended in the Table. Therefore the 99% energy rule (title 47CFR 2.202(a)) was used for digital mode and is more accurate than Carson's rule. It basically states that 99% of the modulation energy falls within X kHz, in this case, 8.10kHz Measurements were performed in accordance with TIA/EIA 102.CAAB Section 2.2.5.2. The emission mask was obtained from 47CFR 90.210(d).

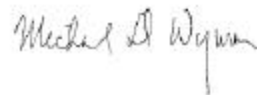

Performed by:

Michael Wyman

**END OF TEST REPORT**

**Testimonial  
and  
Statement of Certification**

**This is to Certify:**

1. **That** the application was prepared either by, or under the direct supervision of, the undersigned.
2. **That** the technical data supplied with the application was taken under my direction and supervision.
3. **That** the data was obtained on representative units, randomly selected.
4. **That**, to the best of my knowledge and belief, the facts set forth in the application and accompanying technical data are true and correct.

Certifying Engineer:

Flom Test Labs  
3356 North San Marcos Place, Suite 107  
Chandler, Arizona 85225-7176  
(866) 311-3268 phone, (480) 926-3598 fax

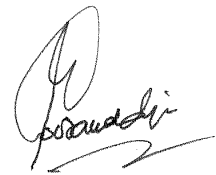

Hoosamuddin S. Bandukwala, Lab Director