

MFA **M. Flom Associates, Inc. - Global Compliance Center**
3356 North San Marcos Place, Suite 107, Chandler, Arizona 85225-7176
www.mflom.com general@mflom.com (480) 926-3100, FAX: 926-3598

Transmitter Certification

of

FCC ID: ALH36913120

Model: TK-2200

to

Federal Communications Commission

Rule Parts 22, 74, 90, 90.210, Confidentiality

Date of report: April 23, 2004

On the Behalf of the Applicant:

Kenwood USA Corporation

At the Request of:

P.O. JB-F-006

Kenwood USA Corporation
Communications Division
3975 Johns Creek Court, Suite 300
Suwanee, GA 30024

Attention of:

Joel E. Berger, Research & Development
JBerger@kenwoodusa.com
(678) 474-4722; FAX: -4731

Supervised by:



Morton Flom, P. Eng.

List of Exhibits

(FCC **Certification** (Transmitters) - Revised 9/28/98)

Applicant: Kenwood USA Corporation

FCC ID: ALH36913120

By Applicant:

- | | |
|---|---|
| 1. Letter of Authorization | x |
| 2. Confidentiality Request: 0.457 And 0.459 | x |
| 3. Part 90.203(e) & (g) Attestation | x |
| 4. Identification Drawings, 2.1033(c)(11) | |
| <u>x</u> Label | |
| <u>x</u> Location of Label | |
| <u>x</u> Compliance Statement | |
| <u>x</u> Location of Compliance Statement | |
| 5. Photographs, 2.1033(c)(12) | x |
| 6. Documentation: 2.1033(c) | |
| (3) User Manual | x |
| (9) Tune Up Info | x |
| (10) Schematic Diagram | x |
| (10) Circuit Description | x |
| Block Diagram | x |
| Active Devices | x |

By M.F.A. Inc.:

- A. Testimonial & Statement of Certification

The Applicant has been cautioned as to the following:**15.21 Information to the User.**

The users manual or instruction manual for an intentional radiator shall caution the user that changes or modifications not expressly approved by the party responsible for compliance could void the user's authority to operate the equipment.

15.27(a) Special Accessories.

Equipment marketed to a consumer must be capable of complying with the necessary regulations in the configuration in which the equipment is marketed. Where special accessories, such as shielded cables and/or special connectors are required to enable an unintentional or intentional radiator to comply with the emission limits in this part, the equipment must be marketed with, i.e. shipped and sold with, those special accessories. However, in lieu of shipping or packaging the special accessories with the unintentional or intentional radiator, the responsible party may employ other methods of ensuring that the special accessories are provided to the consumer, without additional charge.

Information detailing any alternative method used to supply the special accessories for a grant of equipment authorization or retained in the verification records, as appropriate. The party responsible for the equipment, as detailed in § 2.909 of this chapter, shall ensure that these special accessories are provided with the equipment. The instruction manual for such devices shall include appropriate instructions on the first page of text concerned with the installation of the device that these special accessories must be used with the device. It is the responsibility of the user to use the needed special accessories supplied with the equipment.

Table of Contents

<u>Rule</u>	<u>Description</u>	<u>Page</u>
	Test Report	1
2.1033(c)	General Information Required	2
2.1033(c)(14)	Rule Summary	6
	Standard Test Conditions and Engineering Practices	7
2.1046(a)	Carrier Output Power (Conducted)	8
2.1046(a)	ERP Carrier Power (Radiated)	10
2.1049(c)(1)	Emission Masks (Occupied Bandwidth)	12
2.1053(a)	Field Strength of Spurious Radiation	19
90.214	Transient Frequency Behavior	23
2.1047(a)	Audio Low Pass Filter (Voice Input)	29
2.1047(a)	Audio Frequency Response	32
2.1047(b)	Modulation Limiting	34
2.1055(a)(1)	Frequency Stability (Temperature Variation)	37
2.1055(b)(1)	Frequency Stability (Voltage Variation)	40
2.202(g)	Necessary Bandwidth and Emission Bandwidth	41

Page Number 1 of 41.

Required information per ISO/IEC Guide 25-1990, paragraph 13.2:

- a) **Test Report**
- b) Laboratory: M. Flom Associates, Inc.
(FCC: 31040/SIT) 3356 N. San Marcos Place, Suite 107
(Canada: IC 2044) Chandler, AZ 85225
- c) Report Number: d0440029
- d) Client: Kenwood USA Corporation
Communications Division
3975 Johns Creek Court, Suite 300
Suwanee, GA 30024
- e) Identification: TK-2200
FCC ID: ALH36913120
S/N: V3
EUT Description: VHF/FM Portable Transceiver
- f) EUT Condition: Not required unless specified in individual tests.
- g) Report Date: April 23, 2004
EUT Received: March 19, 2004
- h, j, k): As indicated in individual tests.
- i) Sampling method: No sampling procedure used.
- l) Uncertainty: In accordance with MFA internal quality manual.
- m) Supervised by: 
Morton Flom, P. Eng.
- n) Results: The results presented in this report relate only to the item tested.
- o) Reproduction: This report must not be reproduced, except in full, without written permission from this laboratory.

Page Number 2 of 41.

List of General Information Required for Certification

In Accordance with FCC Rules and Regulations,
Volume II, Part 2 and to

22, 74, 90, 90.210, Confidentiality

Sub-part 2.1033

(c)(1): Name and Address of Applicant:

Kenwood USA Corporation
Communications Division
3975 Johns Creek Court, Suite 300
Suwanee, GA 30024

Manufacturer:

Kenwood Electronics Technologies PTE Ltd.
1 Ang Mo Kio Street 63
Singapore 569110

(c)(2): FCC ID: ALH36913120

Model Number: TK-2200

(c)(3): Instruction Manual(s):

Please see attached exhibits

(c)(4): Type of Emission: 16K0F3E, 11K0F3E

(c)(5): Frequency Range, MHz: 150 to 174

(c)(6): Power Rating, Watts: 1 to 2
 Switchable Variable N/A

FCC Grant Note: BE - The output power is continuously variable from the value listed in this entry to 15%-20% of the value listed.

(c)(7): Maximum Power Rating, Watts: 300

DUT Results: Passes Fails

Page Number

3 of 41.

Information for Push-To-Talk Devices

Type and number of antenna to be used for this device:

3 models of whip antenna

Maximum antenna gain for antenna indicated above:

0dBi

Can this device sustain continuous operation with respect to its hardware capabilities and allowable operating functions?

No

Other hardware or operating restrictions that could limit a person's RF Exposure:

Time Out Timer

Source-based time-averaging (see 2.1093 of rules) applicable to reduce the average output power:

No

If device has headset and belt-clip accessories that would allow body-worn operations, what is the minimum separation distance between the antenna and the user's body in this operating configuration?

2.5cm

Can device access wire-line services to make phone calls, either directly or through an operator?

No

Can specific operating instructions be given to users to eliminate any potential RF Exposure concerns for both front-of-the-face and body-worn operating configurations?

Yes – see manual

Other applicable information the applicant may provide that can serve as effective means for ensuring RF Exposure compliance:

See Manual

Industry Canada

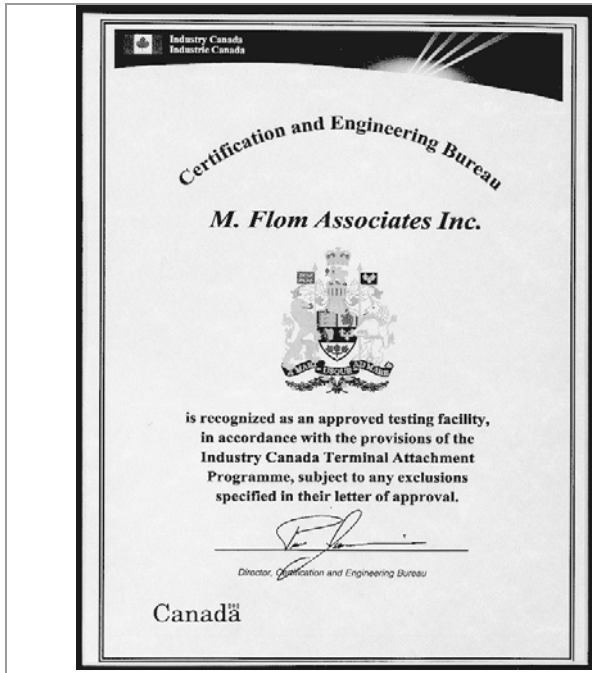

 Industrie Canada Industrie Canada
 Certification and Engineering Bureau
 1241 Clyde Avenue
 Ottawa, Ontario
 K2C 1Y3
 February 24, 1998
 Mr. M. Flom
 M. Flom Associates, Inc.
 3356 North San Marcos Place, Suite 107
 Chandler, Arizona 85224-1571

Tel. No. (613) 952-3650
 Fax. No. (613) 952-1088
 Our File: 46327-2044
 Submission: 19320 O

Dear Mr. Flom,

The Bureau has received your test report for the Open Area Test Site located at Chandler, Arizona, dated January 30, 1998 and the supplemental information received February 24, 1998. I have reviewed the report and find it complies with RSP 100, Issue 7, section 3.3 Description of Open Area Test Site.

The site is acceptable to Industry Canada for the performance of radiated measurements. Please reference the file number "IC 2044" in the body of all test reports containing measurements made on this site. This reference number is the indication of Industry Canada's acceptance of your site. Your company has been added to our published list of qualified sites on the Bureau's web page. It is located at: <http://spectrum.ic.gc.ca/cert/> Please keep the contact information current by notifying us if it changes or is in error.

Keep informed of the latest Industry Canada regulations by visiting the Bureau's site on the World Wide Web;

<http://spectrum.ic.gc.ca/~cert/>
 or the Industry Canada main site at:
<http://strategies.ic.gc.ca>

Whenever major construction or repairs to the site are completed, a re-submission of the site attenuation characteristics will be required.

Yours sincerely,

Brian Kasper

Brian Kasper
 Head, EMC and Standards
 Certification and Engineering Bureau

Canada

NIST

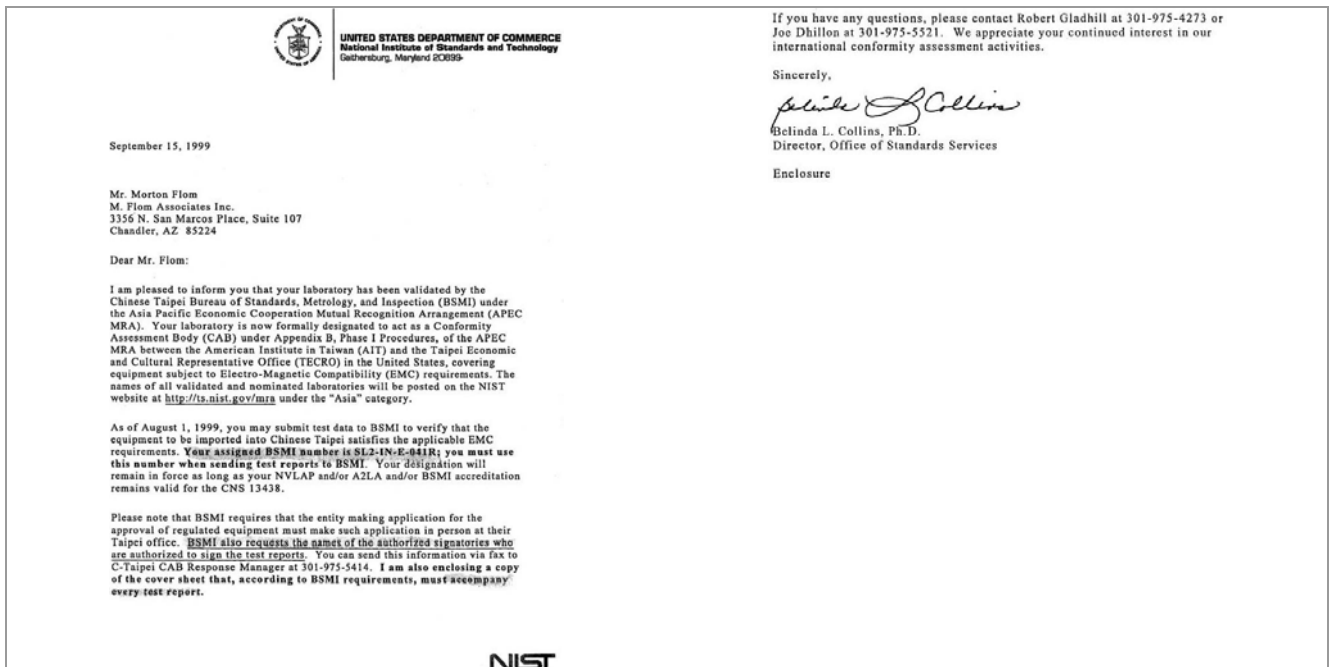

September 15, 1999

Mr. Morton Flom
 M. Flom Associates Inc.
 3356 N. San Marcos Place, Suite 107
 Chandler, AZ 85224

Dear Mr. Flom:

I am pleased to inform you that your laboratory has been validated by the Chinese Taipei Bureau of Standards, Metrology, and Inspection (BSMI) under the Asia Pacific Economic Cooperation Mutual Recognition Arrangement (APEC MRA). Your laboratory is now formally designated to act as a Conformity Assessment Body (CAB) under Appendix B, Phase 1 Procedures, of the APEC MRA between the American Institute in Taiwan (AIT) and the Taipei Economic and Cultural Representative Office (TECRO) in the United States, covering equipment subject to Electro-Magnetic Compatibility (EMC) requirements. The names of all validated and nominated laboratories will be posted on the NIST website at <http://ts.nist.gov/mra> under the "Asia" category.

As of August 1, 1999, you may submit test data to BSMI to verify that the equipment to be imported into Chinese Taipei satisfies the applicable EMC requirements. Your assigned BSMI number is **SL2-IN-E-041R**; you must use this number when sending test reports to BSMI. Your designation will remain in force as long as your NVLAP and/or A2LA and/or BSMI accreditation remains valid for the CNS 13438.

Please note that BSMI requires that the entity making application for the approval of regulated equipment must make such application in person at their Taipei office. BSMI also requires the names of the authorized signatories who are authorized to sign the test reports. You can send this information via fax to C-Taipei CAB Response Manager at 301-975-5414. I am also enclosing a copy of the cover sheet that, according to BSMI requirements, must accompany every test report.

If you have any questions, please contact Robert Gladhill at 301-975-4273 or Joe Dhillon at 301-975-5521. We appreciate your continued interest in our international conformity assessment activities.

Sincerely,

 Belinda L. Collins, Ph.D.
 Director, Office of Standards Services

Enclosure

NIST

Page Number 5 of 41.

Subpart 2.1033 (continued)

(c)(8): Voltages & currents in all elements in final RF stage, including final transistor or solid-state device:

Collector Current, A	=	per manual
Collector Voltage, Vdc	=	per manual
Supply Voltage, Vdc	=	7.5

(c)(9): **Tune-Up Procedure:**

Please see attached exhibits

(c)(10): **Circuit Diagram/Circuit Description:**

Including description of circuitry & devices provided for determining and stabilizing frequency, for suppression of spurious radiation, for limiting modulation and limiting power.

Please see attached exhibits

(c)(11): **Label Information:**

Please see attached exhibits

(c)(12): **Photographs:**

Please see attached exhibits

(c)(13): **Digital Modulation Description:**

Attached Exhibits
 N/A

(c)(14): **Test and Measurement Data:**

Follows

Page Number

6 of 41.

Sub-part

2.1033(c)(14):**Test and Measurement Data**

All tests and measurement data shown were performed in accordance with FCC Rules and Regulations, Volume II; Part 2, Sub-part J, Sections 2.947, 2.1033(c), 2.1041, 2.1046, 2.1047, 2.1079, 2.1051, 2.1053, 2.1055, 2.1057 and the following individual Parts:

- 21 - Domestic Public Fixed Radio Services
- 22 - Public Mobile Services
- 22 Subpart H - Cellular Radiotelephone Service
- 22.901(d) - Alternative technologies and auxiliary services
- 23 - International Fixed Public Radiocommunication services
- 24 - Personal Communications Services
- 74 Subpart H - Low Power Auxiliary Stations
- 80 - Stations in the Maritime Services
- 80 Subpart E - General Technical Standards
- 80 Subpart F - Equipment Authorization for Compulsory Ships
- 80 Subpart K - Private Coast Stations and Marine Utility Stations
- 80 Subpart S - Compulsory Radiotelephone Installations for Small Passenger Boats
- 80 Subpart T - Radiotelephone Installation Required for Vessels on the Great Lakes
- 80 Subpart U - Radiotelephone Installations Required by the Bridge-to-Bridge Act
- 80 Subpart V - Emergency Position Indicating Radio Beacons (EPIRB'S)
- 80 Subpart W - Global Maritime Distress and Safety System (GMDSS)
- 80 Subpart X - Voluntary Radio Installations
- 87 - Aviation Services
- 90 - Private Land Mobile Radio Services
- 94 - Private Operational-Fixed Microwave Service
- 95 Subpart A - General Mobile Radio Service (GMRS)
- 95 Subpart C - Radio Control (R/C) Radio Service
- 95 Subpart D - Citizens Band (CB) Radio Service
- 95 Subpart E - Family Radio Service
- 95 Subpart F - Interactive Video and Data Service (IVDS)
- 97 - Amateur Radio Service
- 101 - Fixed Microwave Services

**Standard Test Conditions
and
Engineering Practices**

Except as noted herein, the following conditions and procedures were observed during the testing:

In accordance with ANSI C63.4-1992/2000 Draft, section 6.1.9, and unless otherwise indicated in the specific measurement results, the ambient temperature of the actual EUT was maintained within the range of 10° to 40°C (50° to 104 °F) unless the particular equipment requirements specify testing over a different temperature range. Also, unless otherwise indicated, the humidity levels were in the range of 10% to 90% relative humidity.

Prior to testing, the EUT was tuned up in accordance with the manufacturer's alignment procedures. All external gain controls were maintained at the position of maximum and/or optimum gain throughout the testing.

Measurement results, unless otherwise noted, are worst-case measurements.

Page Number 8 of 41.
Name of Test: Carrier Output Power (Conducted)
Specification: 47 CFR 2.1046(a)
Guide: ANSI/TIA/EIA-603-1992, Paragraph 2.2.1
Test Equipment: As per attached page

Measurement Procedure

1. The EUT was connected to a resistive coaxial attenuator of normal load impedance, and the unmodulated output power was measured by means of an RF Power Meter.
2. Measurement accuracy is $\pm 3\%$.

Measurement Results
(Worst case)

Frequency of Carrier, MHz = 150.100, 162.100, 173.900
Ambient Temperature = 23°C \pm 3°C

Power Setting	RF Power, Watts
Low	1
High	2



Performed by:

David E. Lee, Lab Manager

Transmitter Power Conducted Measurements

Test A. RF Power Output

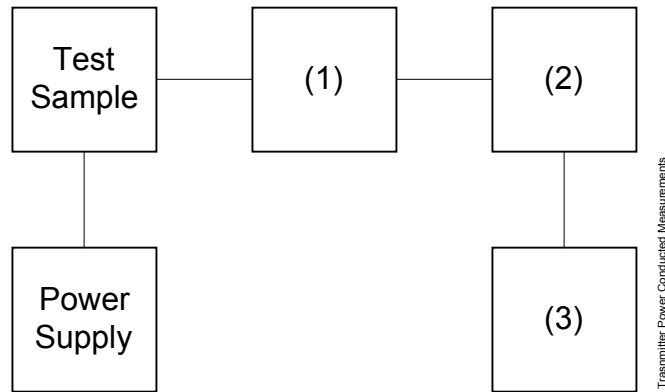

Asset	Description	s/n
(1)	Coaxial Attenuator	
X i00231/2	PASTERNAK PE7021-30 (30 dB)	231 or 232
i00122/3	NARDA 766 (10 dB)	7802 or 7802A
(2)	Power Meters	
X i00020	HP 8901A Power Mode	2105A01087
(3)	Frequency Counter	
X i00020	HP 8901A Frequency Mode	2105A01087

Page Number 10 of 41.

Name of Test: ERP Carrier Power (Radiated)

Specification: TIA/EIA 603A (Substitution Method)

Definition:

The average radiated power of a licensed device is the equivalent power required, when delivered to a half-wave dipole or horn antenna, to produce at a distant point the same average received power as produced by the licensed device.

Method of Measurement:

a) Connect the equipment as illustrated. Place the transmitter to be tested on the turntable in the standard test site.

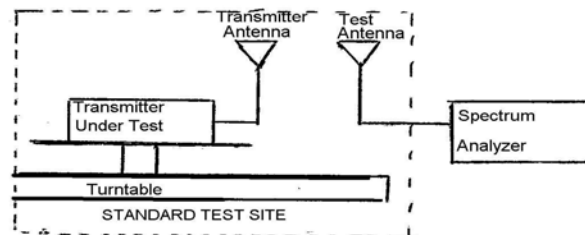

b) Raise and lower the test antenna from 1m to 6 m with the transmitter facing the antenna and record the highest received signal in dB as LVL.

c) Repeat step b) for seven additional readings at 45° interval positions of the turntable.

d) Replace the transmitter under test with a half-wave or horn vertically polarized antenna. The center of the antenna should be at the same location as the transmitter under test. Connect the antenna to a signal generator with a known output power and record the path loss in dB or LOSS.

e) Calculate the average radiated output power from the readings in step c) and d) by the following:

$$\text{average radiated power} = 10 \log_{10} \sum 10(\text{LVL} - \text{LOSS})/10 \text{ (dBm)}$$

Results

	150 MHz		162 MHz		173.90 MHz	
	LVL, dbm	Path Loss, db	LVL, dbm	Path Loss, db	LVL, dbm	Path Loss, db
0°	17.0	2.8	27.4	3.3	22.0	1.8
45°	18.1	2.8	28.3	3.3	23.2	1.8
90°	20.7	2.8	27.6	3.3	24.5	1.8
135°	20.8	2.8	18.9	3.3	22.6	1.8
180°	18.9	2.8	23.1	3.3	27.3	1.8
225°	7.7	2.8	24.2	3.3	24.5	1.8
270°	15.7	2.8	24.4	3.3	25.7	1.8
315°	18.3	2.8	29.3	3.3	26.6	1.8
Av. Radiated Power:		150 MHz	162 MHz	173.90 MHz		
		19.95dbm	28.70dbm	26.35dbm		

Transmitter Spurious Emission

Test A. Occupied Bandwidth (In-Band Spurious)

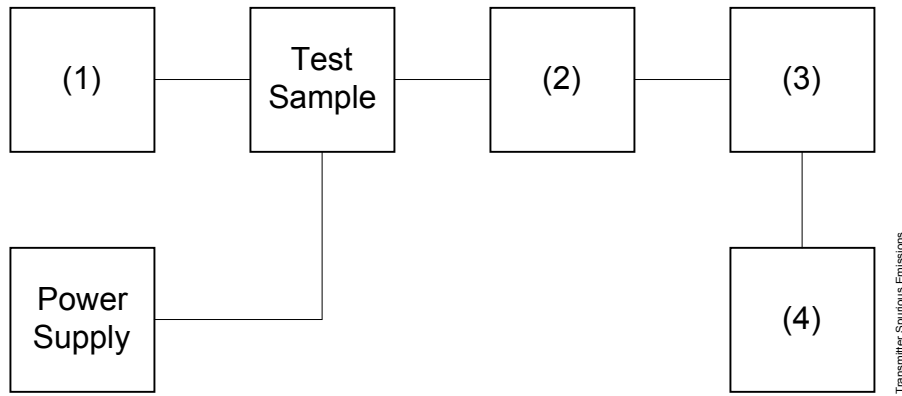

Asset	Description	s/n
(1) Audio Oscillator/Generator		
X i00017	HP 8903A Audio Analyzer	2216A01753
i00002	HP 3336B Synthesizer / Level Gen.	1931A01465
(2) Coaxial Attenuator		
X i00231/2	PASTERNAK PE7021-30 (30 dB)	231 or 232
i0012/3	NARDA 766 (10 dB)	7802 or 7802A
(3) Filters; Notch, HP, LP, BP		
i00126	Eagle TNF-1 Notch Filter	100-250
i00125	Eagle TNF-1 Notch Filter	50-60
i00124	Eagle TNF-1 Notch Filter	250-850
(4) Spectrum Analyzer		
X i00048	HP 8566B Spectrum Analyzer	2511A01467
i00029	HP 8563E Spectrum Analyzer	3213A00104

Page Number 12 of 41.

Name of Test: Emission Masks (Occupied Bandwidth)

Specification: 47 CFR 2.1049(c)(1)

Guide: ANSI/TIA/EIA-603-1992, Paragraph 2.2.11

Test Equipment: As per previous page

Measurement Procedure

1. The EUT and test equipment were set up as shown on the following page, with the Spectrum Analyzer connected.
2. For EUTs supporting audio modulation, the audio signal generator was adjusted to the frequency of maximum response and with output level set for $\pm 2.5/\pm 1.25$ kHz deviation (or 50% modulation). With level constant, the signal level was increased 16 dB.
3. For EUTs supporting digital modulation, the digital modulation mode was operated to its maximum extent.
4. The Occupied Bandwidth was measured with the Spectrum Analyzer controls set as shown on the test results.
5. Measurement Results: Attached

Page Number 13 of 41.

Name of Test: Emission Masks (Occupied Bandwidth)

g0440019: 2004-Apr-20 Tue 22:01:00

State: 1:Low Power

Ambient Temperature: 23°C ± 3°C

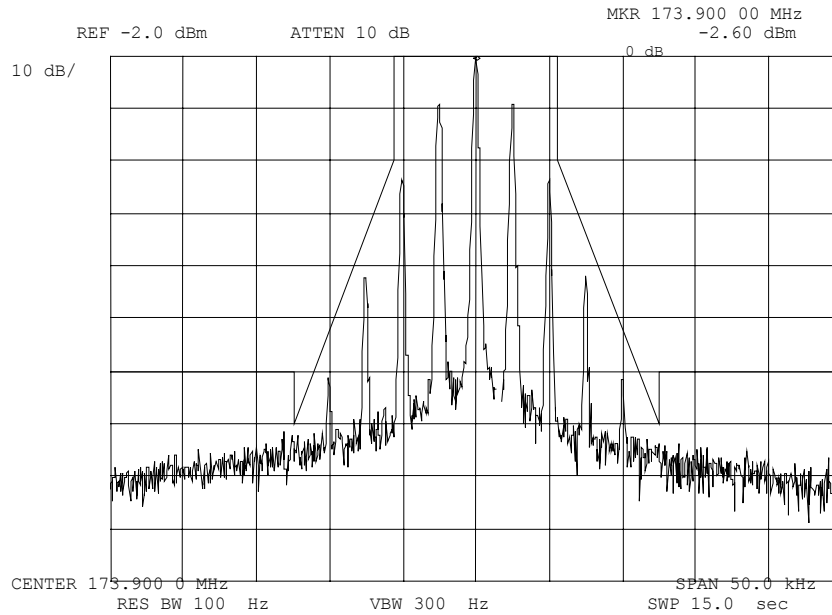

Power:
Modulation:

LOW
VOICE: 2500 Hz SINE WAVE
MASK: D, VHF/UHF 12.5kHz BW

Performed by:

David E. Lee, Lab Manager

Page Number 14 of 41.

Name of Test: Emission Masks (Occupied Bandwidth)

g0440020: 2004-Apr-20 Tue 22:02:00

State: 1:Low Power

Ambient Temperature: 23°C ± 3°C

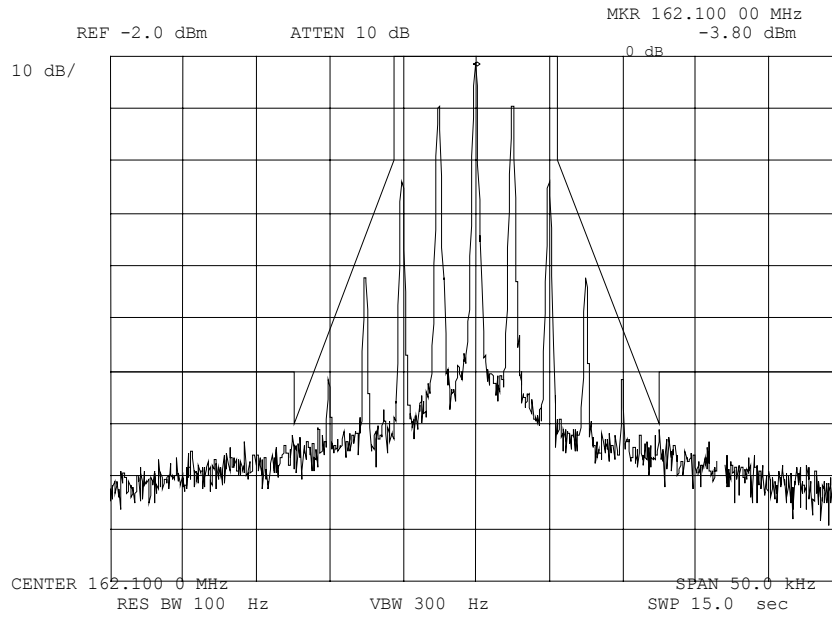

Power:
Modulation:

LOW
VOICE: 2500 Hz SINE WAVE
MASK: D, VHF/UHF 12.5kHz BW

Performed by:

David E. Lee, Lab Manager

Page Number 15 of 41.

Name of Test: Emission Masks (Occupied Bandwidth)

g0440021: 2004-Apr-20 Tue 22:04:00

State: 1:Low Power

Ambient Temperature: 23°C ± 3°C

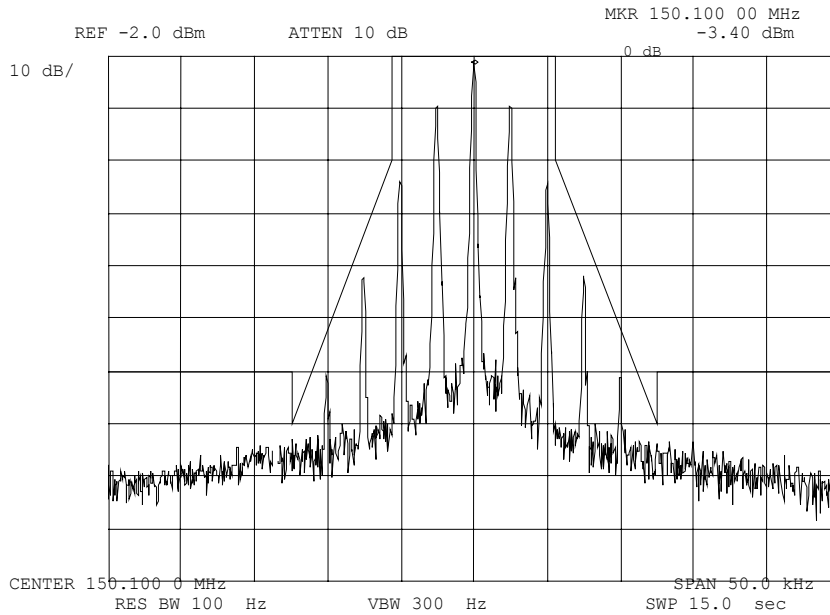

Power:
Modulation:

LOW
VOICE: 2500 Hz SINE WAVE
MASK: D, VHF/UHF 12.5kHz BW

Performed by:

David E. Lee, Lab Manager

Page Number 16 of 41.

Name of Test: Emission Masks (Occupied Bandwidth)

g0440013: 2004-Apr-20 Tue 21:35:00

State: 2:High Power

Ambient Temperature: 23°C ± 3°C

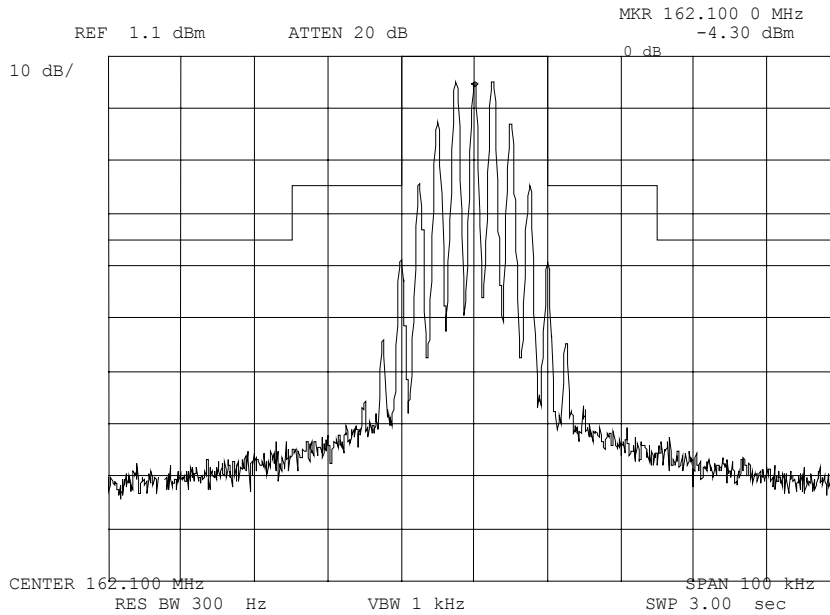

Power:
Modulation:

HIGH
VOICE: 2500 Hz SINE WAVE
MASK: B, VHF/UHF 25kHz, w/LPF

Performed by:

David E. Lee, Lab Manager

Page Number 17 of 41.

Name of Test: Emission Masks (Occupied Bandwidth)

g0440014: 2004-Apr-20 Tue 21:37:00

State: 2:High Power

Ambient Temperature: 23°C ± 3°C

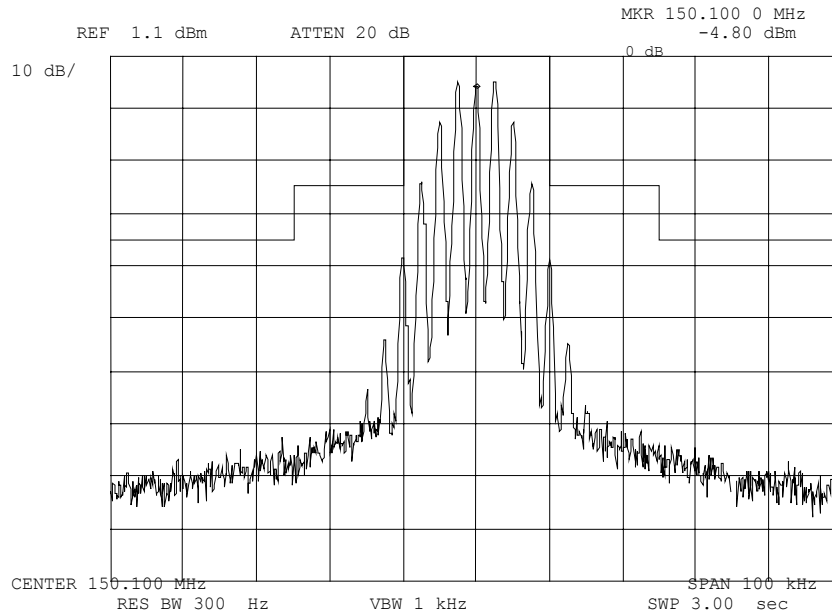

Power:
Modulation:

HIGH
VOICE: 2500 Hz SINE WAVE
MASK: B, VHF/UHF 25kHz, w/LPF

Performed by:

David E. Lee, Lab Manager

Page Number 18 of 41.

Name of Test: Emission Masks (Occupied Bandwidth)

g0440015: 2004-Apr-20 Tue 21:37:00

State: 2:High Power

Ambient Temperature: 23°C ± 3°C

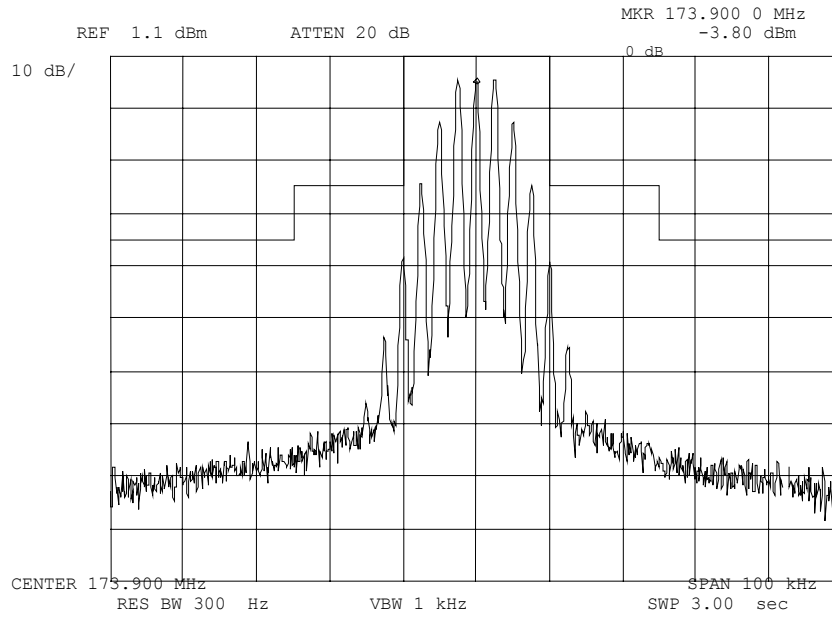

Power:
Modulation:

HIGH
VOICE: 2500 Hz SINE WAVE
MASK: B, VHF/UHF 25kHz, w/LPF

Performed by:

David E. Lee, Lab Manager

Page Number 19 of 41.

Name of Test: Field Strength of Spurious Radiation

Specification: 47 CFR 2.1053(a)

Guide: ANSI/TIA/EIA-603-1992/2001, Paragraph 1.2.12 and Table 16, 47 CFR 22.917

Measurement Procedure

1.2.12.1 Definition: Radiated spurious emissions are emissions from the equipment when transmitting into a non-radiating load on a frequency or frequencies which are outside an occupied band sufficient to ensure transmission of information of required quality for the class of communications desired.

1.2.12.2 Method of Measurement

- A) Connect the equipment as illustrated
- B) Adjust the spectrum analyzer for the following settings:
 - 1) Resolution Bandwidth 100 kHz (<1 GHz), 1 MHz (> 1GHz).
 - 2) Video Bandwidth ≥ 3 times Resolution Bandwidth, or 30 kHz (22.917)
 - 3) Sweep Speed ≤ 2000 Hz/second
 - 4) Detector Mode = Mean or Average Power
- C) Place the transmitter to be tested on the turntable in the standard test site. The transmitter is transmitting into a non-radiating load which is placed on the turntable. The RF cable to this load should be of minimum length.

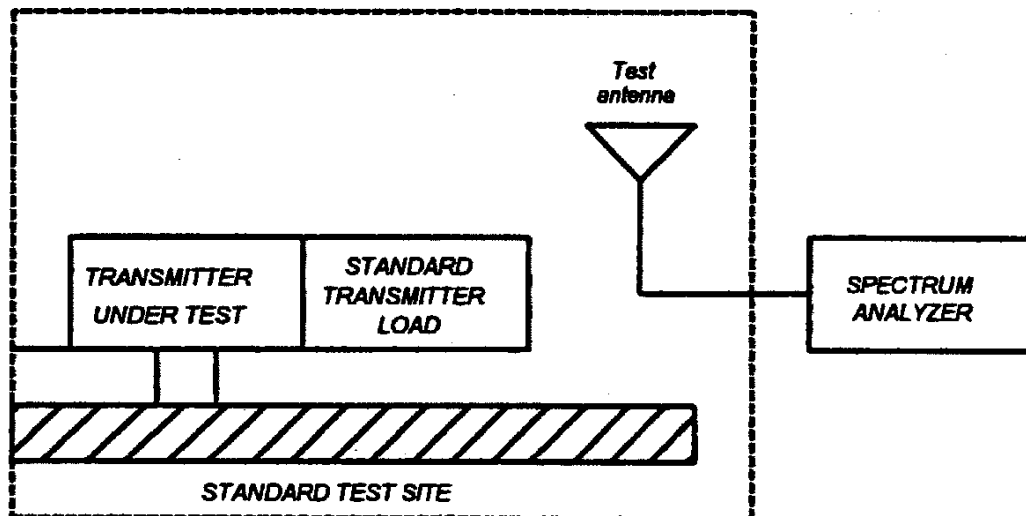

Page Number 20 of 41.

Name of Test: Field Strength of Spurious Radiation (Cont.)

- D) For each spurious measurement the test antenna should be adjusted to the correct length for the frequency involved. This length may be determined from a calibration ruler supplied with the equipment. Measurements shall be made from the lowest radio frequency generated in the equipment to the tenth harmonic of the carrier, except for the region close to the carrier equal to \pm the test bandwidth (see section 1.3.4.4).
- E) For each spurious frequency, raise and lower the test antenna from 1 m to 4 m to obtain a maximum reading on the spectrum analyzer with the test antenna at horizontal polarity. Repeat this procedure to obtain the highest possible reading. Record this maximum reading.
- F) Repeat step E) for each spurious frequency with the test antenna polarized vertically.

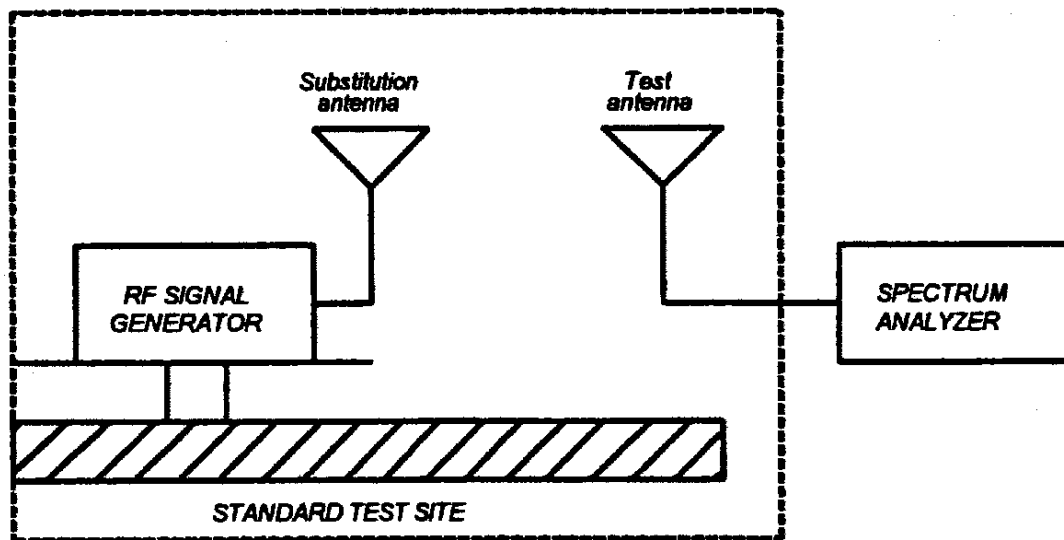

- G) Reconnect the equipment as illustrated.
- H) Keep the spectrum analyzer adjusted as in step B).
- I) Remove the transmitter and replace it with a substitution antenna (the antenna should be half-wavelength for each frequency involved). The center of the substitution antenna should be approximately at the same location as the center of the transmitter. At lower frequencies, where the substitution antenna is very long, this will be impossible to achieve when the antenna is polarized vertically. In such case the lower end of the antenna should be 0.3 m above the ground.

Page Number 21 of 41.

Name of Test: Field Strength of Spurious Radiation (Cont.)

- J) Feed the substitution antenna at the transmitter end with a signal generator connected to the antenna by means of a non-radiating cable. With the antennas at both ends horizontally polarized and with the signal generator tuned to a particular spurious frequency, raise and lower the test antenna to obtain a maximum reading at the spectrum analyzer. Adjust the level of the signal generator output until the previously recorded maximum reading for this set of conditions is obtained. This should be done carefully repeating the adjustment of the test antenna and generator output.
- K) Repeat step J) with both antennas vertically polarized for each spurious frequency.
- L) Calculate power in dBm into a reference ideal half-wave dipole antenna by reducing the readings obtained in steps J) and K) by the power loss in the cable between the generator and the antenna and further corrected for the gain of the substitution antenna used relative to an ideal half-wave dipole antenna.
- M) The levels recorded in step L) are absolute levels of radiated spurious emissions in dBm. The radiated spurious emissions in dB can be calculated by the following:

Radiated spurious emissions dB =
 $10\log_{10}(\text{TX power in watts}/0.001) - \text{the levels in step l)}$

NOTE: It is permissible that other antennas provided can be referenced to a dipole.

Test Equipment:

Asset	Description	s/n	Cycle	Last Cal
Transducer				
X i00088	EMCO 3109-B 25MHz-300MHz	2336	12 mo.	Sep-03
X i00089	April 2001 200MHz-1GHz	001500	12 mo.	Sep-03
X i00103	EMCO 3115 1GHz-18GHz	9208-3925	12 mo.	Jan-03
Amplifier				
X i00028	HP 8449A	2749A00121	12 mo.	May-03
Spectrum Analyzer				
X i00029	HP 8563E	3213A00104	12 mo.	May-03
X i00033	HP 85462A	3625A00357	12 mo.	Aug-03
Substitution Generator				
X i00067	HP 8920A Communication TS	3345U01242	12 mo.	Oct-03
i00207	HP 8753D Network Analyzer	3410A08514	12 mo.	Jul-03

Microphone, Antenna Port, and Cabling

Microphone Yes Cable Length _____ Meters
 Antenna Port Terminated Yes Load No Antenna Gain 0dBi
 All Ports Terminated by Load No Peripheral No

Page Number 22 of 41.

Name of Test: Field Strength of Spurious Radiation

g0440009: 2004-Apr-08 Thu 13:48:00

STATE: 2:High Power

Ambient Temperature: 23°C ± 3°C

Frequency Tuned, MHz	Frequency Emission, MHz	ERP, dBm	ERP, dBc
150.100	300.207500	-40.8	-77.8
150.100	450.311300	-46.8	-79.8
150.100	600.401300	-41.9	-74.9
150.100	750.491000	-58.2	-91.2
150.100	900.595000	-50.2	-83.2
150.100	1050.688000	-48.8	-81.8
150.100	1200.788000	-51.7	-85.7
150.100	1350.888000	-45.0	-78.0
150.100	1500.988000	-45.8	-78.8



Performed by:

David E. Lee, Lab Manager

Page Number 23 of 41.

Name of Test: Transient Frequency Behavior
Specification: 47 CFR 90.214
Guide: ANSI/TIA/EIA-603-1992, Paragraph 2.2.19

Test Equipment: As per attached page

Measurement Procedure

- A) The EUT was setup as shown on the attached page, following TIA/EIA-603 steps a, b, and c as a *guide*.
- B) The transmitter was turned on.
- C) Sufficient attenuation was provided so that the transmitter carrier level measured at the output of the combiner was 40 dB below the maximum input level of the test receiver. This level was recorded.
- D) The transmitter was turned off.
- E) An RF signal generator (1) modulated with a 1 kHz tone at either 25, 12.5, or 6.25 kHz deviation, and set to the same frequency as the assigned transmitter frequency, (2) was adjusted to a level -20 dB below the level recorded for step C) above, measured at the output of the combiner. This level was then fixed for the remainder of the test.
- F) The oscilloscope was setup using TIA/EIA-603 steps j and k as a guide, and to either 10 ms/div (UHF) or 5 ms/div (VHF).
- G) The 30 dB attenuator was removed, the transmitter was turned on, and the level of the carrier at the output of the combiner was recorded.
- H) The carrier on-time as referenced in TIA/EIA-603 steps m, n, and o was captured and plotted. The carrier off-time as referenced in TIA/EIA-603 steps p, q, r, and s was captured and plotted.



Performed by:

David E. Lee, Lab Manager

Transient Frequency Behavior

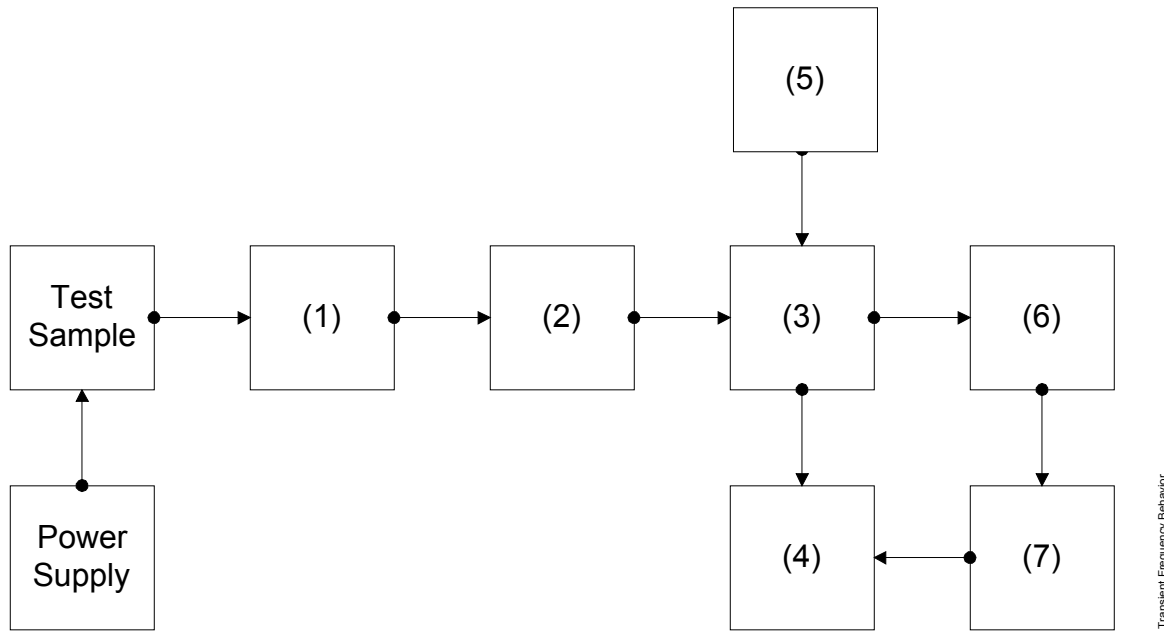

Asset	Description	s/n
(1) Attenuator X i00231/2	(Removed after 1st step) PASTERNAK PE7021-30 (30 dB)	231 or 232
(2) Attenuator X i00231/2 i00122/3	PASTERNAK PE7021-30 (30 dB) NARDA 766 (10 dB)	231 or 232 7802 or 7802A
(3) Combiner X i00154	4 x 25 Ω Combiner	154
(4) Crystal Decoder X i00159	HP 8470B Crystal Detector	1822A10054
(5) RF Signal Generator X i00067	HP 8920A Communication TS	3345U01242
(6) Modulation Analyzer X i00020	HP 8901A Modulation Meter	2105A01087
(7) Oscilloscope X i00030	HP 54502A Digital Oscilloscope	2927A00209

Page Number 25 of 41.

Name of Test: Transient Frequency Behavior

g0440022: 2004-Apr-21 Wed 03:16:00

State: 0:General

Ambient Temperature: 23°C ± 3°C

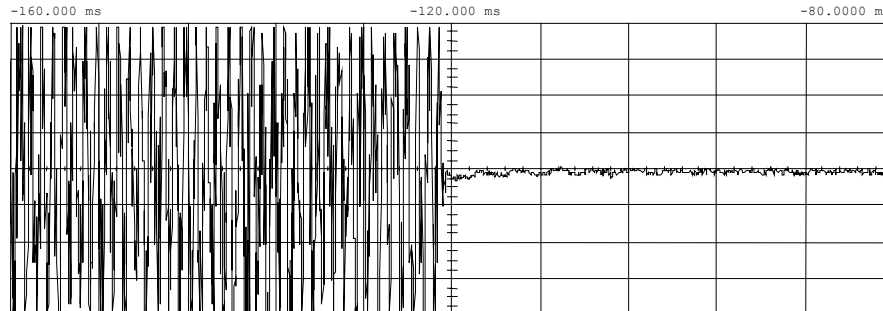

Main	Timebase 8.00 ms/div	Delay/Pos -160.000 ms	Reference Left	Mode Realtime (EXTENDED)
Channel 1	Sensitivity 90.0 mV/div	Offset 0.00000 V	Probe 1.000 :1	Coupling dc (1M ohm)

Trigger mode : Edge
 On Negative Edge Of Chan2
 Trigger Level
 Chan2 = -15.000 mV (noise reject ON)
 Holdoff = 40.000 ns

Power:	HIGH
Bandwidth:	25kHz
Description:	CARRIER ON TIME

Performed by:

David E. Lee, Lab Manager

Page Number 26 of 41.

Name of Test: Transient Frequency Behavior

g0440023: 2004-Apr-21 Wed 03:17:00

State: 0:General

Ambient Temperature: 23°C ± 3°C

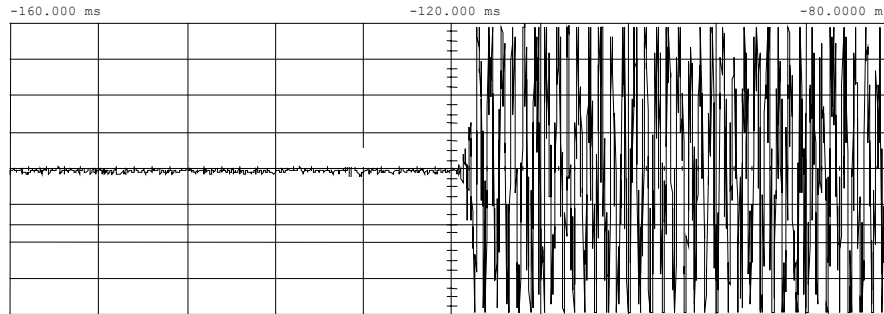

Main	Timebase 8.00 ms/div	Delay/Pos -160.000 ms	Reference Left	Mode Realtime (EXTENDED)
Channel 1	Sensitivity 90.0 mV/div	Offset 0.00000 V	Probe 1.000 :1	Coupling dc (1M ohm)

Trigger mode : Edge
On Positive Edge Of Chan2
Trigger Level
Chan2 = -15.000 mV (noise reject ON)
Holdoff = 40.000 ns

Power:	HIGH
Bandwidth:	25kHz
Description:	CARRIER OFF TIME

Performed by:

David E. Lee, Lab Manager

Page Number 27 of 41.

Name of Test: Transient Frequency Behavior

g0440024: 2004-Apr-21 Wed 03:18:00

State: 0:General

Ambient Temperature: 23°C ± 3°C

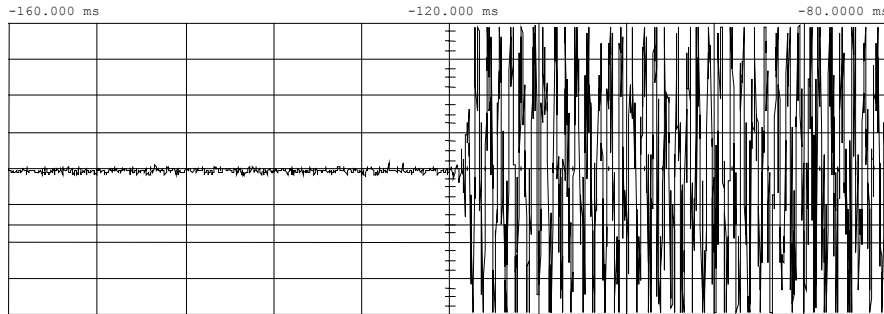

Main	Timebase 8.00 ms/div	Delay/Pos -160.000 ms	Reference Left	Mode Realtime (EXTENDED)
Channel 1	Sensitivity 90.0 mV/div	Offset 0.00000 V	Probe 1.000 :1	Coupling dc (1M ohm)

Trigger mode : Edge
On Positive Edge Of Chan2
Trigger Level
Chan2 = -15.000 mV (noise reject ON)
Holdoff = 40.000 ns

Power:
Bandwidth:
Description:

HIGH
12.5kHz
CARRIER OFF TIME

Performed by:

David E. Lee, Lab Manager

Page Number 28 of 41.

Name of Test: Transient Frequency Behavior

g0440025: 2004-Apr-21 Wed 03:18:00

State: 0:General

Ambient Temperature: 23°C ± 3°C

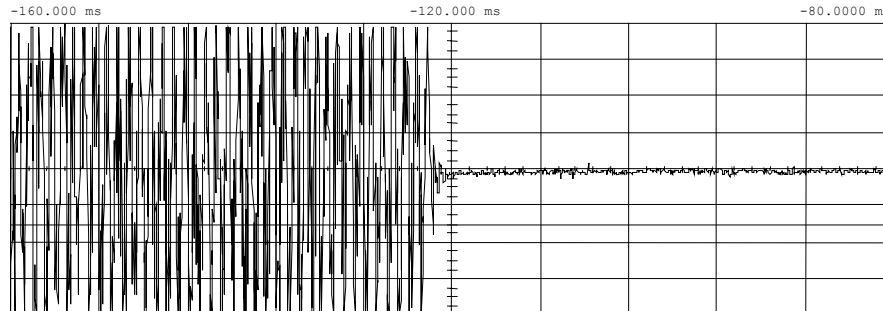

Main	Timebase 8.00 ms/div	Delay/Pos -160.000 ms	Reference Left	Mode Realtime (EXTENDED)
Channel 1	Sensitivity 90.0 mV/div	Offset 0.00000 V	Probe 1.000 :1	Coupling dc (1M ohm)

Trigger mode : Edge
 On Negative Edge Of Chan2
 Trigger Level
 Chan2 = -15.000 mV (noise reject ON)
 Holdoff = 40.000 ns

Power:	HIGH
Bandwidth:	12.5kHz
Description:	CARRIER ON TIME

Performed by:

David E. Lee, Lab Manager

Page Number 29 of 41.
Name of Test: Audio Low Pass Filter (Voice Input)
Specification: 47 CFR 2.1047(a)
Guide: ANSI/TIA/EIA-603-1992, Paragraph 2.2.15
Test Equipment: As per attached page

Measurement Procedure

1. The EUT and test equipment were set up such that the audio input was connected at the input to the modulation limiter, and the modulated stage.
2. The audio output was connected at the output to the modulated stage.
3. Measurement Results: Attached

Transmitter Test Set-Up

- Test A. Modulation Capability/Distortion
- Test B. Audio Frequency Response
- Test C. Hum and Noise Level
- Test D. Response of Low Pass Filter
- Test E. Modulation Limiting

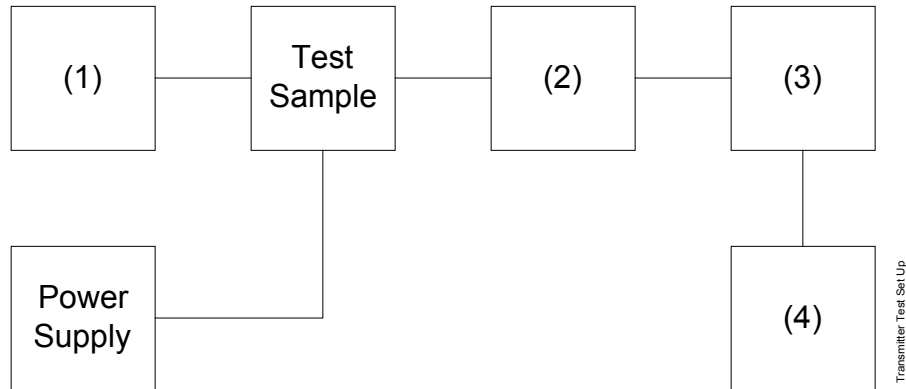

Asset	Description	s/n
(1) Audio Oscillator		
X i00002	HP 3336B Synthesizer / Level Gen.	1931A01465
(2) Coaxial Attenuator		
i00122/3	NARDA 766 (10dB)10	7802 or 7802A
X i00231/2	PASTERNAK PE7021-30 (30 dB)	231 or 232
(3) Modulation Analyzer		
X i00020	HP 8901A Modulation Meter	2105A01087
(4) Audio Analyzer		
X i00001	HP 3586B Selective Level Meter	1928A01360

Page Number

31 of 41.

Name of Test: Audio Low Pass Filter (Voice Input)

g0440002: 2004-Apr-21 Wed 04:05:00

State: 0:General

Ambient Temperature: 23°C ± 3°C

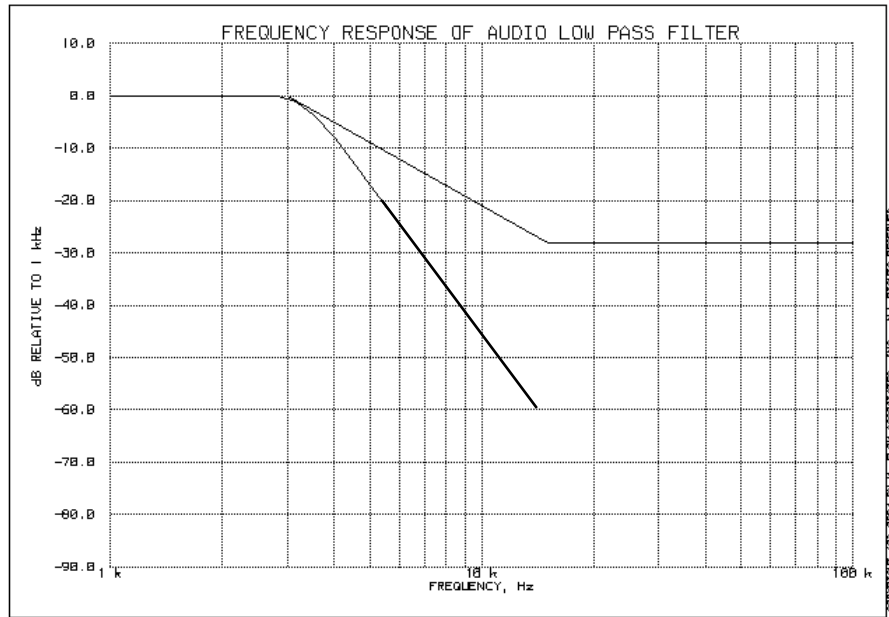

Performed by:

David E. Lee, Lab Manager

Page Number 32 of 41.
Name of Test: Audio Frequency Response
Specification: 47 CFR 2.1047(a)
Guide: ANSI/TIA/EIA-603-1992, Paragraph 2.2.6
Test Equipment: As per previous page

Measurement Procedure

1. The EUT and test equipment were set up as shown on the following page.
2. The audio signal generator was connected to the audio input circuit/microphone of the EUT.
3. The audio signal input was adjusted to obtain 20% modulation at 1 kHz, and this point was taken as the 0 dB reference level.
4. With input levels held constant and below limiting at all frequencies, the audio signal generator was varied from 100 Hz to 50 kHz.
5. The response in dB relative to 1 kHz was then measured, using the HP 8901A Modulation Analyzer.
6. Measurement Results: Attached

Page Number 33 of 41.

Name of Test: Audio Frequency Response

g0440001: 2004-Apr-21 Wed 04:01:00

State: 0:General

Ambient Temperature: 23°C ± 3°C

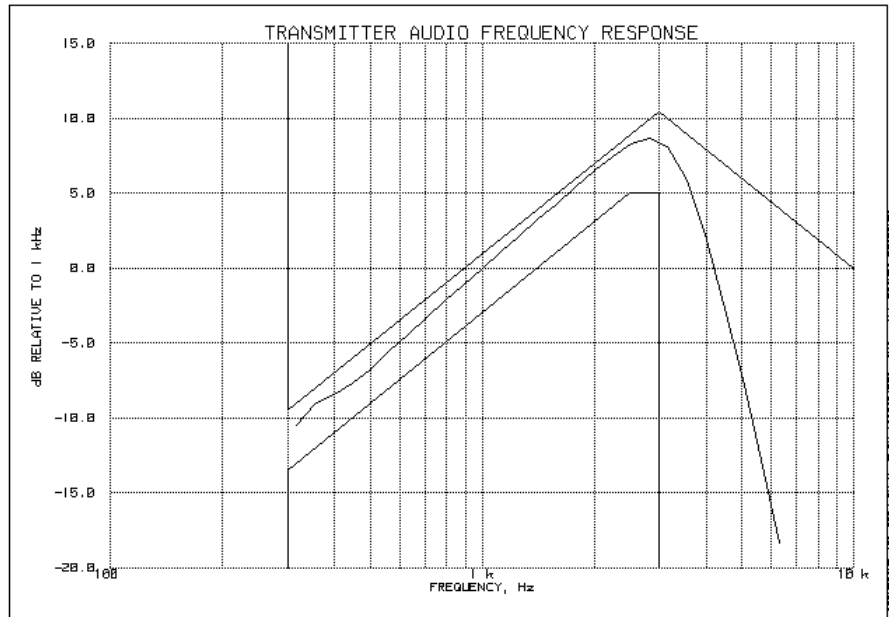

Frequency of Maximum Audio Response, Hz = 2820

Additional points:

Frequency, Hz	Level, dB
300	-10.81
20000	-27.14
30000	-27.32
50000	-27.24

Performed by:

David E. Lee, Lab Manager

Page Number 34 of 41.

Name of Test: Modulation Limiting

Specification: 47 CFR 2.1047(b)

Guide: ANSI/TIA/EIA-603-1992, Paragraph 2.2.3

Test Equipment: As per previous page

Measurement Procedure

1. The signal generator was connected to the input of the EUT as for "Frequency Response of the Modulating Circuit."
2. The modulation response was measured for each of three frequencies (one of which was the frequency of maximum response), and the input voltage was varied and was observed on an HP 8901A Modulation Analyzer.
3. The input level was varied from 30% modulation (± 1.5 kHz deviation) to at least 20 dB higher than the saturation point.
4. Measurements were performed for both negative and positive modulation and the respective results were recorded.
5. Measurement Results: Attached

Name of Test: Modulation Limiting (25kHz Bandwidth / 5kHz Deviation)
g0440003: 2004-Apr-21 Wed 04:09:00
State: 0:General Ambient Temperature: 23°C ± 3°C

Positive Peaks:

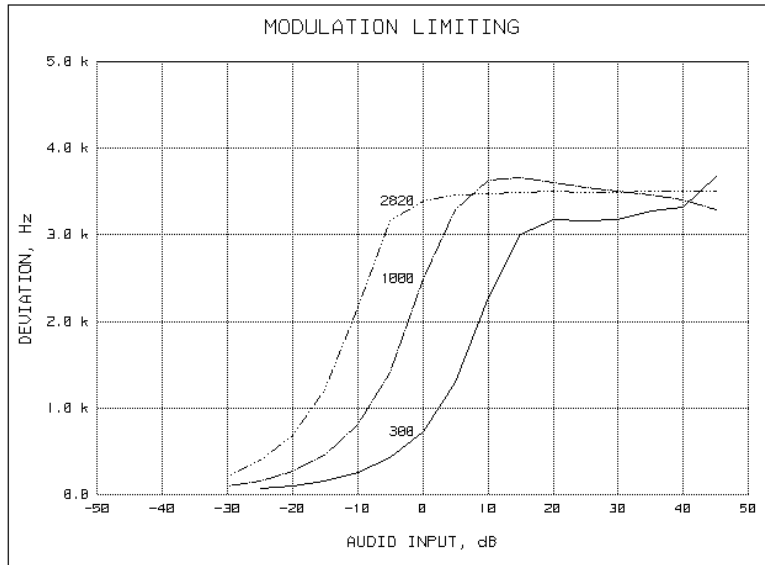

Negative Peaks:

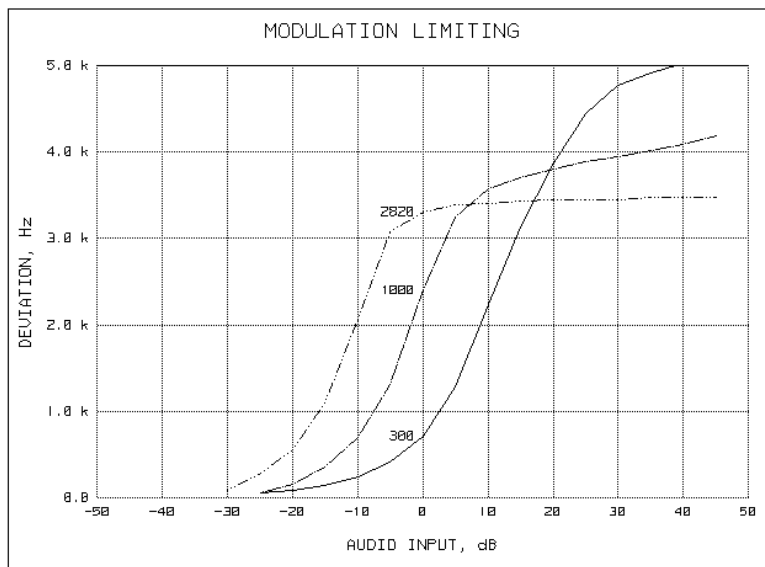

Performed by:

David E. Lee, Lab Manager

Name of Test: Modulation Limiting (12.5kHz Bandwidth / 2.5kHz Deviation)

g0440004: 2004-Apr-21 Wed 04:15:00

State: 0:General

Ambient Temperature: 23°C ± 3°C

Positive
Peaks:

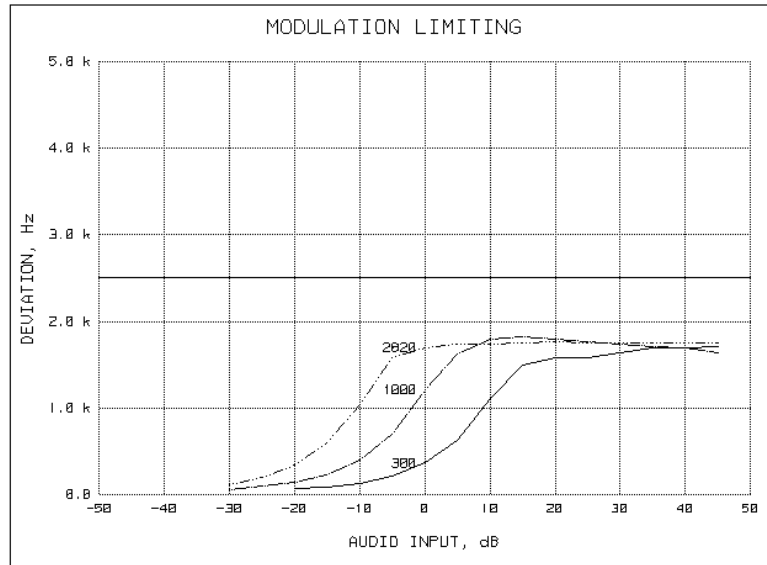

Negative
Peaks:

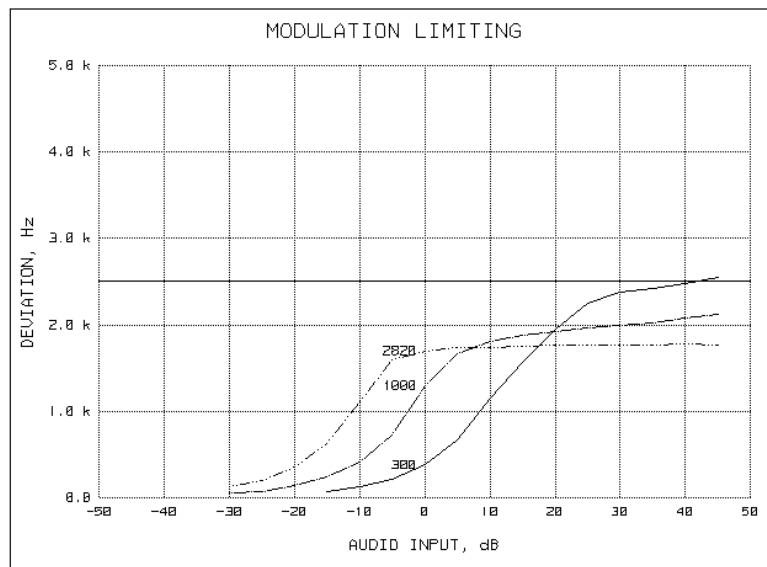

Performed by:

David E. Lee, Lab Manager

Page Number 37 of 41.

Name of Test: Frequency Stability (Temperature Variation)

Specification: 47 CFR 2.1055(a)(1)

Guide: ANSI/TIA/EIA-603-1992, Paragraph 2.2.2

Test Conditions: As Indicated

Test Equipment: As per previous page

Measurement Procedure

1. The EUT and test equipment were set up as shown on the following page.
2. With all power removed, the temperature was decreased to -30°C and permitted to stabilize for three hours. Power was applied and the maximum change in frequency was noted within one minute.
3. With power OFF, the temperature was raised in 10°C steps. The sample was permitted to stabilize at each step for at least one-half hour. Power was applied and the maximum frequency change was noted within one minute.
4. The temperature tests were performed for the worst case.
5. Measurement Results: Attached

Transmitter Test Set-Up

Frequency Stability: Temperature Variation
 Frequency Stability: Voltage Variation

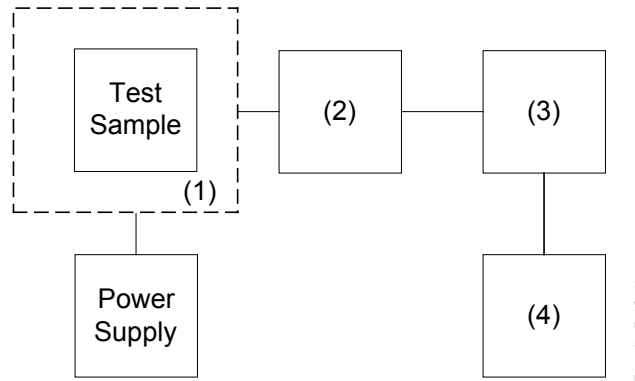

Asset	Description	s/n
(1) Temperature, Humidity, Vibration		
X i00027	Tenney Temp. Chamber	9083-765-234
(2) Coaxial Attenuator		
X i00231/2	PASTERNAK PE7021-30 (30 dB)	231 or 232
i00122/3	NARDA 766 (10 dB)	7802 or 7802A
(3) RF Power		
X i00067	HP 8920A Communications TS	3345U01242
(4) Frequency Counter		
X i00067	HP 8920A Communications TS	3345U01242

Page Number 39 of 41.

Name of Test: Frequency Stability (Temperature Variation)

State: General

Ambient Temperature: 23°C ± 3°C

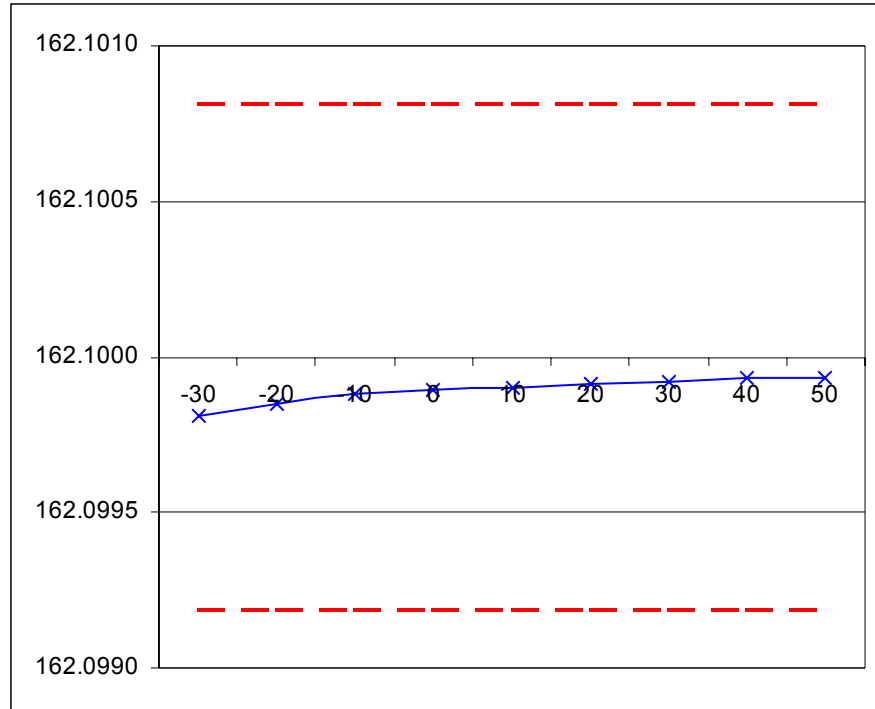

Performed by:

David E. Lee, Lab Manager

Page Number 40 of 41.
Name of Test: Frequency Stability (Voltage Variation)
Specification: 47 CFR 2.1055(d)(1)
Guide: ANSI/TIA/EIA-603-1992, Paragraph 2.2.2
Test Equipment: As per previous page

Measurement Procedure

1. The EUT was placed in a temperature chamber at 25±5°C and connected as for "Frequency Stability - Temperature Variation" test.
2. The power supply voltage to the EUT was varied from 85% to 115% of the nominal value measured at the input to the EUT.
3. The variation in frequency was measured for the worst case.

Results: Frequency Stability (Voltage Variation)
g04440026: 2004-Apr-21 Wed 03:40:04
State: 0:General Ambient Temperature: 23°C ± 3°C

Limit, ppm = 5
Limit, Hz = 811
Battery End Point (Voltage) = 6.2

% of STV	Voltage	Frequency, MHz	Change, Hz	Change, ppm
85	6.37	162.099910	-90	-0.55
100	7.5	162.099890	-110	-0.68
115	8.62	162.099890	-110	-0.68
83	6.2	162.099900	-100	-0.62



Performed by: David E. Lee, Lab Manager

Page Number 41 of 41.

Name of Test: Necessary Bandwidth and Emission Bandwidth

Specification: 47 CFR 2.202(g)

Modulation = 16K0F3E

Necessary Bandwidth Calculation:

Maximum Modulation (M), kHz	=	3
Maximum Deviation (D), kHz	=	5
Constant Factor (K)	=	1
Necessary Bandwidth (B _N), kHz	=	(2xM)+(2xDxK)
	=	16.0

Modulation = 11K0F3E

Necessary Bandwidth Calculation:

Maximum Modulation (M), kHz	=	3
Maximum Deviation (D), kHz	=	2.5
Constant Factor (K)	=	1
Necessary Bandwidth (B _N), kHz	=	(2xM)+(2xDxK)
	=	11.0



Performed by:

David E. Lee, Lab Manager

END OF TEST REPORT

**Testimonial
and
Statement of Certification**

This is to Certify:

1. **That** the application was prepared either by, or under the direct supervision of, the undersigned.
2. **That** the technical data supplied with the application was taken under my direction and supervision.
3. **That** the data was obtained on representative units, randomly selected.
4. **That**, to the best of my knowledge and belief, the facts set forth in the application and accompanying technical data are true and correct.

Certifying Engineer:



Morton Flom, P. Eng.