



Engineering and Testing for EMC and Safety Compliance

TYPE CERTIFICATION REPORT

Kenwood USA Corporation

3975 John Creek Ct, Suite 300

Suwanee, GA 30024

Joel Berger

Phone: 678-474-4722

MODEL: TK-8100-1

FCC ID: ALH36033110

October 1, 2003

STANDARDS REFERENCED FOR THIS REPORT	
PART 2: 2001	FREQUENCY ALLOCATIONS AND RADIO TREATY MATTERS; GENERAL RULES AND REGULATIONS
PART 15: 2001	RADIO FREQUENCY DEVICES - §15.109: RADIATED EMISSIONS LIMITS
PART 22: 1998	PUBLIC MOBILE SERVICES
PART 74: 2001	EXPERIMENTAL RADIO AUXILIARY, SPECIAL BROADCAST AND OTHER PROGRAM DISTRIBUTIONAL SERVICES
PART 90: 2001	PRIVATE LAND MOBILE RADIO SERVICES
ANSI C63.4-1992	STANDARD FORMAT MEASUREMENT/TECHNICAL REPORT PERSONAL COMPUTER AND PERIPHERALS
ANSI/TIA/EIA603- 1992	LAND MOBILE FM OR PM COMMUNICATIONS EQUIPMENT MEASUREMENT AND PERFORMANCE STANDARDS
ANSI/TIA/EIA 603-1-1998	ADDENDUM TO ANSI/TIA/EIA 603-1992
RSS-119; Issue 6; 2000	LAND MOBILE AND FIXED RADIO TRANSMITTERS AND RECEIVERS 27.41 TO 960.0 MHz

Frequency Range	Maximum Measured Output Power (W) Conducted	Frequency Tolerance (ppm)	Emission Designator
450-490 MHz	25.82	2.5	16K0F3E
450-490 MHz	25.82	2.5	11K0F3E
450-490 MHz	4.90	2.5	16K0F3E
450-490 MHz	4.90	2.5	11K0F3E

REPORT PREPARED BY TEST ENGINEER: RACHID SEHB

Document Number: 2003163

No part of this report may be reproduced without the full written approval of Rhein Tech Laboratories, Inc.

TABLE OF CONTENTS

1	GENERAL INFORMATION.....	5
1.1	TEST FACILITY.....	5
1.2	RELATED SUBMITTAL(S)/GRANT(S).....	5
2	CONFORMANCE STATEMENT.....	6
3	TESTED SYSTEM DETAILS.....	7
4	FCC RULES AND REGULATIONS PART 2 §2.1033(C)(8) VOLTAGES AND CURRENTS THROUGH THE FINAL AMPLIFYING STAGE.....	8
5	FCC RULES AND REGULATIONS PART 2 §2.1046 (A): RF POWER OUTPUT: CONDUCTED.....	9
5.1	TEST PROCEDURE.....	9
5.2	TEST DATA.....	9
6	FCC RULES AND REGULATIONS PART 2 §2.1051: SPURIOUS EMISSIONS AT ANTENNA TERMINALS.....	10
6.1	TEST PROCEDURE.....	10
6.2	TEST DATA.....	10
7	FCC RULES AND REGULATIONS PART 2 §2.1053 (A): FIELD STRENGTH OF SPURIOUS RADIATION.....	12
7.1	TEST PROCEDURE.....	12
7.2	TEST DATA.....	13
7.2.1	CFR 47 PART 90.210 REQUIREMENTS.....	13
8	FCC RULES AND REGULATIONS PART 2 §2.1049 (C) (1): OCCUPIED BANDWIDTH.....	15
8.1	TEST PROCEDURE.....	15
8.2	TEST DATA.....	15
9	FCC RULES AND REGULATION PART 2 §2.1055: FREQUENCY STABILITY.....	17
9.1	TEST PROCEDURE.....	17
9.2	TEST DATA.....	18
9.2.1	FREQUENCY STABILITY/TEMPERATURE VARIATION.....	18
9.2.2	FREQUENCY STABILITY/VOLTAGE VARIATION.....	20
10	FCC PART 2 §2.1047 (A): MODULATION CHARACTERISTICS - AUDIO FREQUENCY RESPONSE.....	22
10.1	TEST PROCEDURE.....	22
10.2	TEST DATA.....	22
11	FCC PART 2 §2.1047 (A): MODULATION CHARACTERISTICS – AUDIO LOW PASS FILTER.....	24
11.1	TEST PROCEDURE.....	24
11.2	TEST DATA.....	24
12	FCC RULES AND REGULATIONS PART 2 §2.1047 (B): MODULATION CHARACTERISTICS - MODULATION LIMITING.....	26
12.1	TEST PROCEDURE.....	26
12.2	TEST DATA.....	26
13	FCC RULES AND REGULATIONS PART 90 §90.214: TRANSIENT FREQUENCY BEHAVIOR.....	30
13.1	TEST PROCEDURE.....	30
13.2	TEST DATA.....	30
14	FCC RULES AND REGULATIONS PART 2 §2.202: NECESSARY BANDWIDTH AND EMISSION BANDWIDTH.....	34
15	CONCLUSION.....	34

TABLE OF TABLES

TABLE 3-1:	EQUIPMENT UNDER TEST (EUT)	7
TABLE 5-1:	RF POWER OUTPUT (HIGH AND LOW POWER): CARRIER OUTPUT POWER (UNMODULATED).....	9
TABLE 5-2:	RF POWER OUTPUT (RATED POWER).....	9
TABLE 5-3:	TEST EQUIPMENT USED FOR TESTING (RF POWER OUTPUT - CONDUCTED)	9
TABLE 6-1:	CONDUCTED SPURIOUS EMISSIONS HIGH POWER- 470.15 MHz.....	10
TABLE 6-2:	CONDUCTED SPURIOUS EMISSIONS LOW POWER- 470.15 MHz.....	10
TABLE 6-3:	TEST EQUIPMENT USED FOR TESTING (CONDUCTED SPURIOUS EMISSIONS).....	11
TABLE 7-1:	FIELD STRENGTH OF SPURIOUS RADIATION- 470.15 MHz; NARROW BAND, HIGH POWER	13
TABLE 7-2:	FIELD STRENGTH OF SPURIOUS RADIATION- 470.15 MHz; NARROW BAND, LOW POWER	13
TABLE 7-3:	TEST EQUIPMENT USED FOR TESTING (FIELD STRENGTH OF SPURIOUS RADIATION)	14
TABLE 9-1:	TEMPERATURE FREQUENCY STABILITY, 470.15 MHz.....	19
TABLE 9-2:	TEST EQUIPMENT USED FOR TESTING (FREQUENCY STABILITY/TEMPERATURE).....	19
TABLE 9-3:	FREQUENCY STABILITY/VOLTAGE VARIATION, 470.15MHz.....	20
TABLE 9-4:	TEST EQUIPMENT USED FOR TESTING (FREQUENCY STABILITY/VOLTAGE).....	21
TABLE 10-1:	TEST EQUIPMENT USED FOR TESTING (AUDIO FREQUENCY RESPONSE).....	23
TABLE 11-1:	TEST EQUIPMENT USED FOR TESTING (AUDIO LOW PASS FILTER RESPONSE)	25
TABLE 12-1:	TEST EQUIPMENT USED FOR TESTING (MODULATION LIMITING)	29
TABLE 13-1:	TEST EQUIPMENT USED FOR TESTING (TRANSIENT FREQUENCY BEHAVIOR).....	33

TABLE OF PLOTS

PLOT 8-1:	OCCUPIED BANDWIDTH; WIDE BAND; AUDIO MODULATION: 2,500 Hz.....	15
PLOT 8-2:	OCCUPIED BANDWIDTH; NARROW BAND; AUDIO MODULATION: 2,500 Hz.....	16
PLOT 9-1:	TEMPERATURE FREQUENCY STABILITY.....	18
PLOT 9-2:	VOLTAGE FREQUENCY STABILITY.....	20
PLOT 10-1:	MODULATION CHARACTERISTICS - AUDIO FREQUENCY RESPONSE {12.5 kHz CHANNEL BANDWIDTH}	22
PLOT 11-1:	MODULATION CHARACTERISTICS - AUDIO LOW PASS FILTER.....	24
PLOT 12-1:	MODULATION CHARACTERISTICS - MODULATION LIMITING: WIDE BAND; POSITIVE PEAK	26
PLOT 12-2:	MODULATION CHARACTERISTICS - MODULATION LIMITING: WIDE BAND; NEGATIVE PEAK	27
PLOT 12-3:	MODULATION CHARACTERISTICS - MODULATION LIMITING: NARROW BAND; POSITIVE PEAK	28
PLOT 12-4:	MODULATION CHARACTERISTICS - MODULATION LIMITING: NARROW BAND; NEGATIVE PEAK.....	29
PLOT 13-1:	TRANSIENT FREQUENCY BEHAVIOR - 470.15 MHz; HIGH POWER; WIDE BAND; CARRIER ON TIME.....	30
PLOT 13-2:	TRANSIENT FREQUENCY BEHAVIOR - 470.15 MHz; HIGH POWER; WIDE BAND; CARRIER OFF TIME.....	31
PLOT 13-3:	TRANSIENT FREQUENCY BEHAVIOR - 470.15 MHz; HIGH POWER; NARROW BAND; CARRIER ON TIME	32
PLOT 13-4:	TRANSIENT FREQUENCY BEHAVIOR - 470.15 MHz; HIGH POWER; NARROW BAND; CARRIER OFF TIME	33

TABLE OF FIGURES

FIGURE 3-1:	CONFIGURATION OF TESTED SYSTEM.....	8
-------------	-------------------------------------	---

TABLE OF APPENDICES

APPENDIX A:	AGENCY AUTHORIZATION	36
APPENDIX B:	CONFIDENTIALITY REQUEST	37
APPENDIX C:	FCC PART 1.1307, 1.1310, 2.1091, 2.1093: RF EXPOSURE	38
APPENDIX D:	OPERATIONAL DESCRIPTION	40
APPENDIX E:	LABEL INFORMATION	41
APPENDIX F:	PARTS LIST	42
APPENDIX G:	SCHEMATICS	43
APPENDIX H:	BLOCK DIAGRAM	44
APPENDIX I:	MANUAL	45
APPENDIX J:	TEST CONFIGURATION PHOTOGRAPHS	46
APPENDIX K:	EXTERNAL PHOTOGRAPHS	48
APPENDIX L:	INTERNAL PHOTOGRAPHS	49

TABLE OF PHOTOGRAPHS

PHOTOGRAPH 1:	RADIATED EMISSIONS FRONT VIEW	46
PHOTOGRAPH 2:	RADIATED EMISSIONS REAR VIEW	47

1 GENERAL INFORMATION

The following Type Certification Report is prepared on behalf of **Kenwood USA Corporation** in accordance with the Federal Communications Commission and Industry Canada Rules and Regulations. The Equipment Under Test (EUT) was the **TK-8100-1, FCC ID: ALH36033110**. The EUT is capable of transmitting a power output adjustable from 5 W up to 25 W. The test results reported in this document relate only to the item that was tested.

All measurements contained in this application were conducted in accordance with FCC Rules and Regulations CFR 47, Industry Canada RSS-119, and ANSI C63.4 Methods of Measurement of Radio Noise Emissions, 1992. The instrumentation utilized for the measurements conforms to the ANSI C63.4 standard for EMI and Field Strength Instrumentation. Calibration checks are performed regularly on the instruments, and all accessories including high pass filter, coaxial attenuator, preamplifier, and cables.

1.1 TEST FACILITY

The open area test site and conducted measurement facility used to collect the radiated data is located on the parking lot of Rhein Tech Laboratories, Inc. 360 Herndon Parkway, Suite 1400, Herndon, Virginia 20170. This site has been fully described in a report dated March 3, 1994, submitted to and approved by the Federal Communications Commission to perform AC line conducted and radiated emissions testing (ANSI C63.4 1992).

1.2 RELATED SUBMITTAL(S)/GRANT(S)

This is an original application report.

2 CONFORMANCE STATEMENT

STANDARDS REFERENCED FOR THIS REPORT	
PART 2: 2001	FREQUENCY ALLOCATIONS AND RADIO TREATY MATTERS; GENERAL RULES AND REGULATIONS
PART 15: 2001	§15.109: RADIATED EMISSIONS LIMITS
PART 22: 1998	PUBLIC MOBILE SERVICES
PART 74: 2001	EXPERIMENTAL RADIO AUXILIARY, SPECIAL BROADCAST AND OTHER PROGRAM DISTRIBUTIONAL SERVICES
PART 90: 2001	PRIVATE LAND MOBILE RADIO SERVICES
ANSI C63.4-1992	STANDARD FORMAT MEASUREMENT/TECHNICAL REPORT PERSONAL COMPUTER AND PERIPHERALS
ANSI/TIA/EIA603- 1992	LAND MOBILE FM OR PM COMMUNICATIONS EQUIPMENT MEASUREMENT AND PERFORMANCE STANDARDS
ANSI/TIA/EIA 603-1-1998	ADDENDUM TO ANSI/TIA/EIA 603-1992
RSS-119; Issue 6; 2000	LAND MOBILE AND FIXED RADIO TRANSMITTERS AND RECEIVERS 27.41 TO 960.0 MHz

Frequency Range	Output Power (W) Conducted	Frequency Tolerance (ppm)	Emission Designator
450-490 MHz	25.82	2.5	16K0F3E
450-490 MHz	25.82	2.5	11K0F3E
450-490 MHz	4.90	2.5	16K0F3E
450-490 MHz	4.90	2.5	11K0F3E

We, the undersigned, hereby declare that the equipment tested and referenced in this report conforms to the identified standard(s) as described in this attached test record. No modifications were made to the equipment during testing in order to achieve compliance with these standards.

Furthermore, there was no deviation from, additions to, or exclusions from, the above standards for certification methodology.

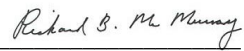
Signature: 

Date: October 1, 2003

Typed/Printed Name: Rick McMurray

Position: Vice President of Operations

Signature: 

Date: October 1, 2003

Typed/Printed Name: Rachid Sehb

Position: EMC Engineer

 Accredited by the National Voluntary Accreditation Program for the specific scope of accreditation under Lab Code 200061-0.

Note: This report may not be used by the client to claim product endorsement by NVLAP or any agency of the U.S. Government.

3 TESTED SYSTEM DETAILS

Listed below are the identifiers and descriptions of all equipment, cables, and internal devices used with the EUT for this test, as applicable.

TABLE 3-1: EQUIPMENT UNDER TEST (EUT)

Part	Manufacturer	Model	PN/Serial Number	FCC ID	RTL Bar Code
UHF Mobile Radio	KENWOOD	TK-8100-1	N/A	ALH36033110	15415
Microphone	KENWOOD	N/A	PC A02-2547	N/A	15417
Power Cable	KENWOOD	N/A	N/A	N/A	10cm+1.5m extension

FIGURE 3-1: CONFIGURATION OF TESTED SYSTEM

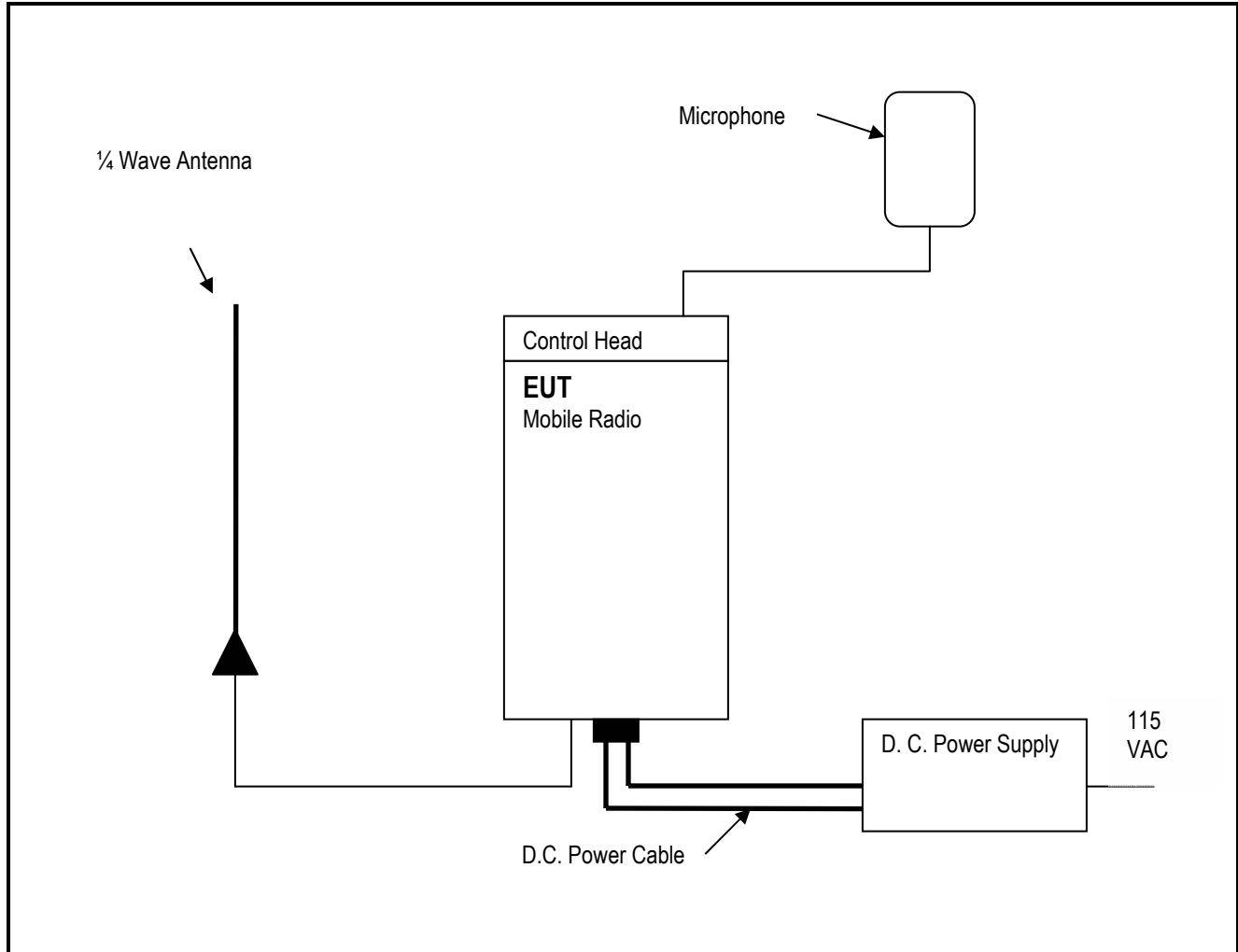

4 FCC RULES AND REGULATIONS PART 2 §2.1033(C)(8) VOLTAGES AND CURRENTS THROUGH THE FINAL AMPLIFYING STAGE

Nominal DC Voltage: 13.6 VDC
Current: 8 AMPS or less

5 FCC RULES AND REGULATIONS PART 2 §2.1046 (A): RF POWER OUTPUT: CONDUCTED

5.1 TEST PROCEDURE

ANSI/TIA/EIA-603-1992, section 2.2.1

The EUT was connected to a coaxial attenuator having a 50Ω load impedance.

5.2 TEST DATA

The following channels (in MHz) were tested: 450.15, 470.15, and 489.85

TABLE 5-1: RF POWER OUTPUT (HIGH AND LOW POWER): CARRIER OUTPUT POWER (UNMODULATED)

Channel	Frequency (MHz)	RF Power Measured (Watt)*
1	450.15	25.82
3	470.15	25.47
5	489.85	25.82
7	450.15	4.90
9	470.15	4.90
11	489.85	4.45

* Measurement accuracy: +/- .02 dB (logarithmic mode)

TABLE 5-2: RF POWER OUTPUT (RATED POWER)

Rated Power (W)
5 - 25

TABLE 5-3: TEST EQUIPMENT USED FOR TESTING (RF POWER OUTPUT - CONDUCTED)

RTL Asset #	Manufacturer	Model	Part Type	Serial Number	Calibration Due Date
901184/901186	Agilent	E4416A/E9323A	Power Meter / Sensor	GB41050573/US15410380	7/30/04

TEST PERSONNEL:

RACHID SEHB		SEPTEMBER 25, 2003
TEST TECHNICIAN/ENGINEER	SIGNATURE	DATE OF TEST

6 FCC RULES AND REGULATIONS PART 2 §2.1051: SPURIOUS EMISSIONS AT ANTENNA TERMINALS

6.1 TEST PROCEDURE

ANSI/TIA/EIA-603-1992, Section 2.2.13

The transmitter is terminated with a 50 Ω load and interfaced with a spectrum analyzer.

The transmitter is modulated with a 2,500 Hz sine wave at an input level 16 dB greater than that required to produce 50% of the rated system deviation at 1,000 Hz.

6.2 TEST DATA

Frequency range of measurement per Part 2.1057: 9 kHz to 10 x Fc

Limits: Mask D (dBm): $P(\text{dBm}) - (50 + 10 \times \text{LOG } P(\text{W}))$

The following channels (in MHz) were investigated: 450.15, 470.15, and 489.85. The worse case (unwanted emissions) channels are shown. The magnitude of emissions attenuated more than 20 dB below the FCC limit need not be recorded.

TABLE 6-1: CONDUCTED SPURIOUS EMISSIONS HIGH POWER– 470.15 MHz

(470.15 MHz); 12.5 kHz channel spacing; Mask D; Conducted power = 25.47W

Frequency (MHz)	Level (dBc)	Limit (dBc)	Margin(dB)
940.3	87.8	64.1	-23.7
1410.45	95.6	64.1	-31.5
1880.6	102.5	64.1	-38.4
2350.75	74.8	64.1	-10.7
2820.9	83.2	64.1	-19.1
3291.05	88.5	64.1	-24.4
3761.2	95.5	64.1	-31.4
4231.35	79.7	64.1	-15.6
4701.5	96.9	64.1	-32.8

TABLE 6-2: CONDUCTED SPURIOUS EMISSIONS LOW POWER– 470.15 MHz

(470.15 MHz); 12.5 kHz channel spacing; Mask D; Conducted power = 4.90W

Frequency (MHz)	Level (dBc)	Limit (dBc)	Margin(dB)
940.3	86.0	56.9	-29.1
1410.45	97.3	56.9	-40.4
1880.6	103.8	56.9	-46.9
2350.75	82.1	56.9	-25.2
2820.9	82.5	56.9	-25.6
3291.05	93.8	56.9	-36.9
3761.2	93.7	56.9	-36.8
4231.35	84.8	56.9	-27.9
4701.5	105.0	56.9	-48.1

TABLE 6-3: TEST EQUIPMENT USED FOR TESTING (CONDUCTED SPURIOUS EMISSIONS)

RTL Asset #	Manufacturer	Model	Part Type	Serial Number	Calibration Due Date
901215	Hewlett Packard	8596EM (9 kHz-12.8 GHz)	EMC Analyzer	3826A00144	8/27/04
901057	Hewlett Packard	3336B	Synthesizer/Level Generator	2514A02585	8/6/04
901054	Hewlett Packard	HP 3586B	Selective Level Meter	1928A01892	9/9/04

TEST PERSONNEL:

RACHID SEHB		SEPTEMBER 26, 2003
TEST TECHNICIAN/ENGINEER	SIGNATURE	DATE OF TEST

7 FCC RULES AND REGULATIONS PART 2 §2.1053 (A): FIELD STRENGTH OF SPURIOUS RADIATION

7.1 TEST PROCEDURE

ANSI/TIA/EIA-603-1992, section 2.2.12

Analog Modulation: The transmitter is terminated with a 50 Ω load and is modulated with a 2,500 Hz sine wave at an input level 16 dB greater than that required to produce 50% of the rated system deviation at 1,000 Hz.

The spurious emissions levels were measured and the device under test was replaced by a substitution antenna connected to a signal generator. This signal generator level was then corrected by subtracting the cable loss from the substitution antenna to the signal generator and the gain of the antenna was further corrected to a half wave dipole.

7.2 TEST DATA

7.2.1 CFR 47 PART 90.210 REQUIREMENTS

The worst-case emissions test data are shown. The magnitude of emissions attenuated more than 20 dB below the FCC limit need not be recorded.

TABLE 7-1: FIELD STRENGTH OF SPURIOUS RADIATION– 470.15 MHz; NARROW BAND, HIGH POWER

Radiated Spurious Emissions
 Mid Band (470.15 MHz, Narrowband)
 Limit = $50 + 10 \log P = 64.1 \text{ dBc}$
 Conducted Power = 44.1 dBm = 25.47 W

Frequency (MHz)	Spectrum Analyzer Level (dBuV)	Signal Generator Level (dBm)	Cable Loss (dB)	Antenna Gain (dBd)	Corrected Signal Generator Level (dBc)	Margin (dB)
940.3	75.1	-24.4	3.0	-1.1	-72.6	-8.5
1410.6	72.0	-27.1	5.2	4.4	-72.1	-7.9
1830.6	51.7	-33.8	6.5	4.8	-79.6	-15.5
2350.8	60.0	-28.1	8.0	11.7	-68.5	-4.4
2820.9	67.0	-20.0	9.8	5.4	-68.5	-4.4
3291.0	62.1	-23.9	11.0	5.8	-73.3	-9.1
3761.1	58.1	-23.2	12.5	5.7	-74.1	-10.0
4231.4	44.5	-34.0	12.5	6.3	-84.3	-20.2
4701.5	43.0	-36.3	13.2	7.1	-86.5	-22.3

*This insertion loss corresponds to the cable connecting the RF Signal Generator to the ½ wave dipole antenna.

TABLE 7-2: FIELD STRENGTH OF SPURIOUS RADIATION– 470.15 MHz; NARROW BAND, LOW POWER

Radiated Spurious Emissions
 Mid Band (470.15 MHz, Narrowband)
 Limit = $50 + 10 \log P = 56.9 \text{ dBc}$
 Conducted Power = 36.9 dBm = 4.9 W

Frequency (MHz)	Spectrum Analyzer Level (dBuV)	Signal Generator Level (dBm)	Cable Loss (dB)	Antenna Gain (dBd)	Corrected Signal Generator Level (dBc)	Margin (dB)
940.3	67.3	-29.2	3.0	-1.1	-70.2	-13.3
1410.6	62.9	-29.2	5.2	4.4	-67.0	-10.0
1830.6	47.3	-38.2	6.5	4.8	-76.8	-19.9
2350.8	46.6	-41.5	8.0	11.7	-74.7	-17.8
2820.9	49.5	-37.5	9.8	5.4	-78.8	-21.9
3291.0	41.5	-44.5	11.0	5.8	-86.7	-29.7
3761.1	43.8	-37.5	12.5	5.7	-81.2	-24.3
4231.4	37.1	-41.4	12.5	6.3	-84.5	-27.6
4701.5	33.6	-45.7	13.2	7.1	-88.7	-31.7

*This insertion loss corresponds to the cable connecting the RF Signal Generator to the ½ wave dipole antenna.

TABLE 7-3: TEST EQUIPMENT USED FOR TESTING (FIELD STRENGTH OF SPURIOUS RADIATION)

RTL Asset #	Manufacturer	Model	Part Type	Serial Number	Calibration Due Date
901053	Schaffner-Chase	CBL6112	Antenna (25 MHz – 2 GHz)	2648	9/3/04
900932	Hewlett Packard	8449B OPT H02	Preamplifier (1 - 26.5 GHz)	3008A00505	N/A
901020	Hewlett Packard	8564E	Portable Spectrum Analyzer (9 kHz - 40 GHz)	3943A01719	7/15/04
901158	Compliance Design, Inc.	Roberts Dipole Antenna	Adjustable Elements Dipole	00401	5/9/04
900321	EMCO	3161-03	Horn Antenna (4.0 - 8.2 GHz)	9508-1020	N/A
900772	EMCO	3161-02	Horn Antenna (2 - 4 GHz)	9804-1044	N/A
900814	Electro-Metrics	EM-6961 (RGA-60)	Double Ridges Guide Antenna (1 - 18 GHz)	2310	2/17/04
900917	Hewlett Packard	8648C	Synthesized. Signal Generator (9 kHz - 3200 MHz)	3537A01741	5/2/04
900928	Hewlett Packard	83752A	Synthesized Sweeper (0.01 - 20 GHz)	3610A00866	8/5/04

TEST PERSONNEL:

RACHID SEHB		SEPTEMBER 27, 2003
TEST TECHNICIAN/ENGINEER	SIGNATURE	DATE OF TEST

8 FCC RULES AND REGULATIONS PART 2 §2.1049 (C) (1): OCCUPIED BANDWIDTH

OCCUPIED BANDWIDTH - COMPLIANCE WITH THE EMISSION MASKS

8.1 TEST PROCEDURE

ANSI/TIA/EIA-603-1992, section 2.2.11 and TIA/EIA-102.CAAA-1999 section 2.2.5

Device with audio modulation: Transmitter was modulated with a 2,500 Hz sine wave at an input level of 16 dB greater than that required to produce 50% of rated system deviation at 1,000 Hz.

8.2 TEST DATA

PLOT 8-1: OCCUPIED BANDWIDTH; WIDE BAND; AUDIO MODULATION: 2,500 Hz

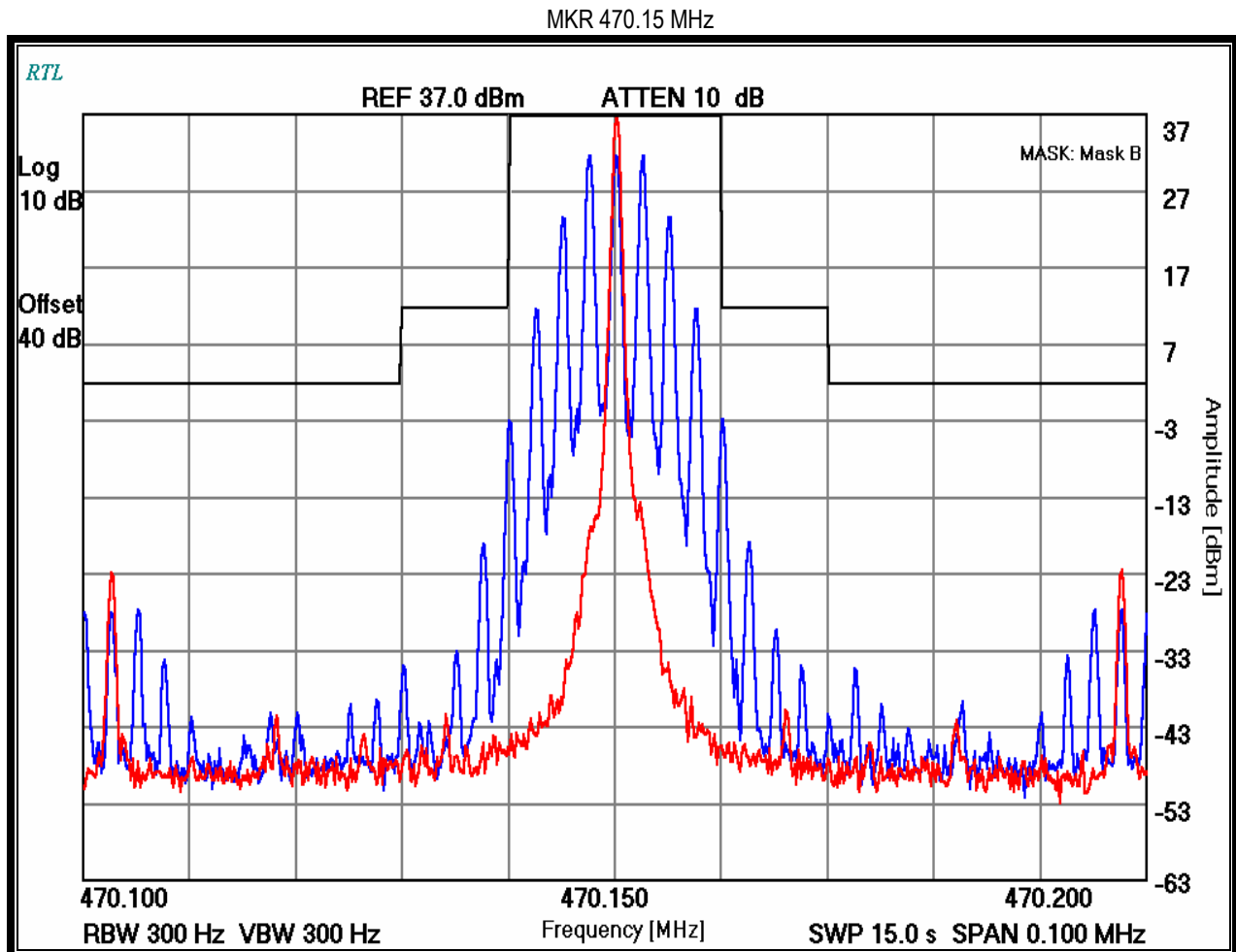

PLOT 8-2: OCCUPIED BANDWIDTH; NARROW BAND; AUDIO MODULATION: 2,500 Hz

MKR 470.15 MHz

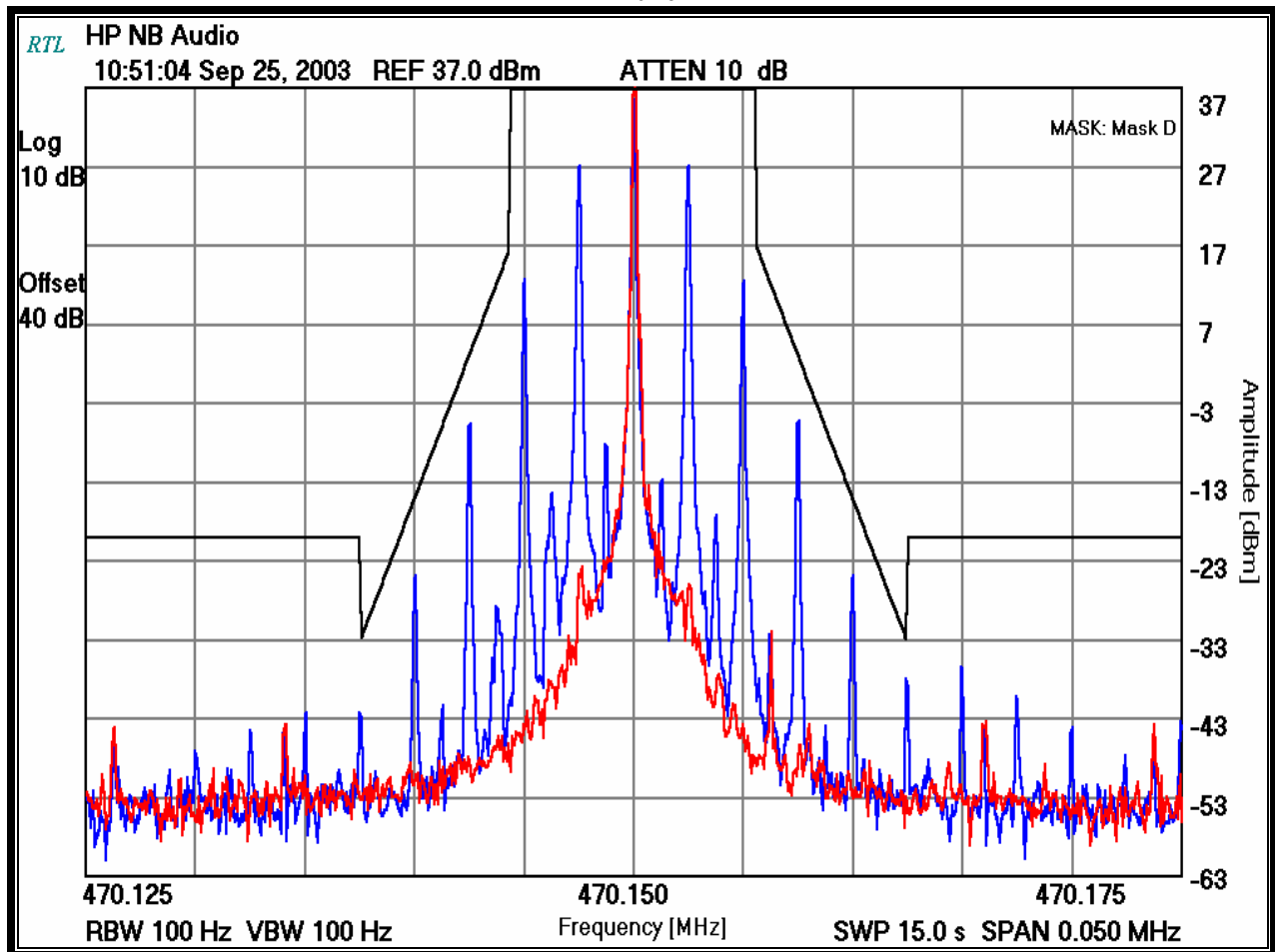

9 FCC RULES AND REGULATION PART 2 §2.1055: FREQUENCY STABILITY

9.1 TEST PROCEDURE

ANSI/TIA/EIA-603-1992, section 2.2.2

The carrier frequency stability is the ability of the transmitter to maintain an assigned carrier frequency.

The EUT was evaluated over the temperature range -30°C to +60°C.

The temperature was initially set to -30°C and a 2-hour period was observed for stabilization of the EUT. The frequency stability was measured within one minute after application of primary power to the transmitter. The temperature was raised at intervals of 10 degrees centigrade through the range. A one half hour period was observed to stabilize the EUT at each measurement step and the frequency stability was measured within one minute after application of primary power to the transmitter. Additionally, the power supply voltage of the EUT was varied from the battery end point to maximum voltage.

The worst-case test data is shown below in Table 9-1.

9.2 TEST DATA

9.2.1 FREQUENCY STABILITY/TEMPERATURE VARIATION

Limit is 2.5 ppm for mobile device with a 12.5 kHz channel bandwidth. Worst-case deviation was found to be 2.23 ppm at -10°C.

PLOT 9-1: TEMPERATURE FREQUENCY STABILITY

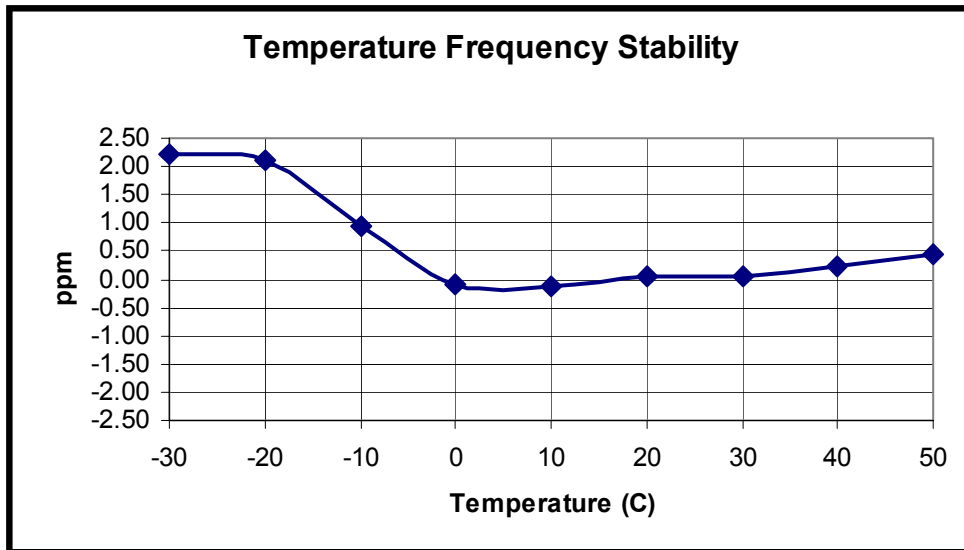



TABLE 9-1: TEMPERATURE FREQUENCY STABILITY, 470.15 MHz

Temperature C	Measured Frequency (MHz)	ppm
-30	470.151050	2.23
-20	470.150990	2.11
-10	470.150445	0.95
0	470.149955	-0.10
10	470.149935	-0.14
20	470.150030	0.06
30	470.150020	0.04
40	470.150115	0.24
50	470.150205	0.44

TABLE 9-2: TEST EQUIPMENT USED FOR TESTING (FREQUENCY STABILITY/TEMPERATURE)

RTL Asset #	Manufacturer	Model	Part Type	Serial Number	Calibration Due Date
900946	Tenney Engineering, Inc.	TH65	Temperature Chamber with Humidity	11380	2/4/04
901118	Hewlett Packard	8901A Opt. 002-003	Modulation Analyzer	2406A00178	6/18/04
901215	Hewlett Packard	8596EM (9 kHz-12.8 GHz)	EMC Analyzer	3826A00144	8/27/04

TEST PERSONNEL:

RACHID SEHB		SEPTEMBER 30, 2003
TEST TECHNICIAN/ENGINEER	SIGNATURE	DATE OF TEST

9.2.2 FREQUENCY STABILITY/VOLTAGE VARIATION

Worst-case variation is 0.14 ppm.

PLOT 9-2: VOLTAGE FREQUENCY STABILITY

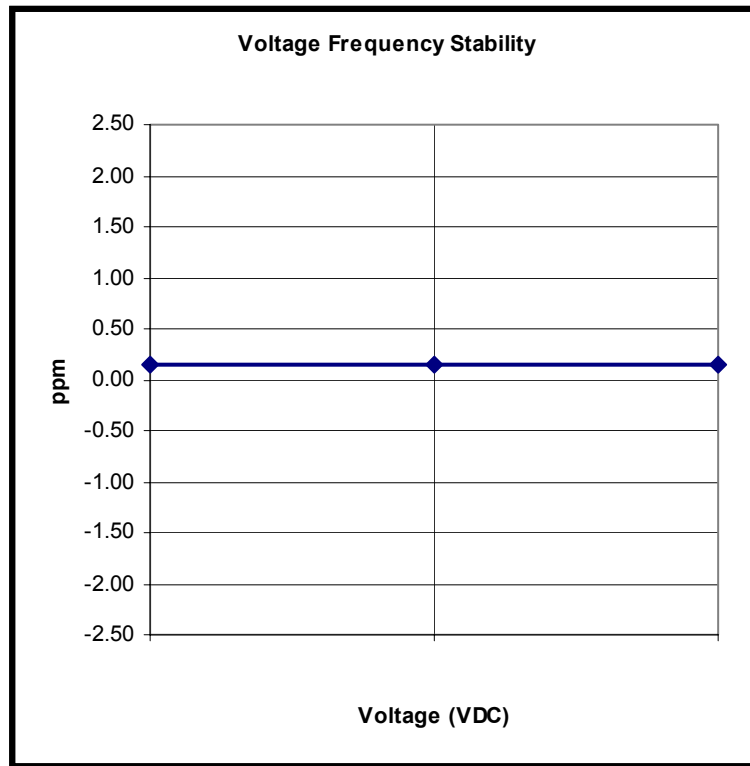



TABLE 9-3: FREQUENCY STABILITY/VOLTAGE VARIATION, 470.15MHZ

Voltage (Vdc)	Measured Frequency (MHz)	ppm
11.56	470.150065	0.14
13.6	470.150068	0.14
15.64	470.150065	0.14

TABLE 9-4: TEST EQUIPMENT USED FOR TESTING (FREQUENCY STABILITY/VOLTAGE)

RTL Asset #	Manufacturer	Model	Part Type	Serial Number	Calibration Due Date
901215	Hewlett Packard	8596EM (9 kHz-12.8 GHz)	EMC Analyzer	3826A00144	8/27/04
901118	Hewlett Packard	8901A Opt. 002-003	Modulation Analyzer	2406A00178	6/18/04

TEST PERSONNEL:

RACHID SEHB		SEPTEMBER 30, 2003
TEST TECHNICIAN/ENGINEER	SIGNATURE	DATE OF TEST

10 FCC PART 2 §2.1047 (A): MODULATION CHARACTERISTICS - AUDIO FREQUENCY RESPONSE

10.1 TEST PROCEDURE

ANSI/TIA/EIA-603-1992, section 2.2.6

The audio frequency response is the degree of closeness to which the frequency deviation of the transmitter follows a prescribed characteristic.

The input audio level at 1000 Hz was set to produce 20% of the rated system deviation. This point is shown as the 0 dB reference level, noted DEVref. The audio signal generator was varied from 100 Hz to 5 kHz with the input level held constant. The deviation in kHz was recorded using a modulation analyzer as DEVfreq. The response in dB relative to 1 kHz was calculated as follows:

$$\text{Audio Frequency Response} = 20 \text{ LOG} (\text{DEVfreq}/\text{DEVref})$$

10.2 TEST DATA

PLOT 10-1: MODULATION CHARACTERISTICS - AUDIO FREQUENCY RESPONSE {12.5 kHz CHANNEL BANDWIDTH}

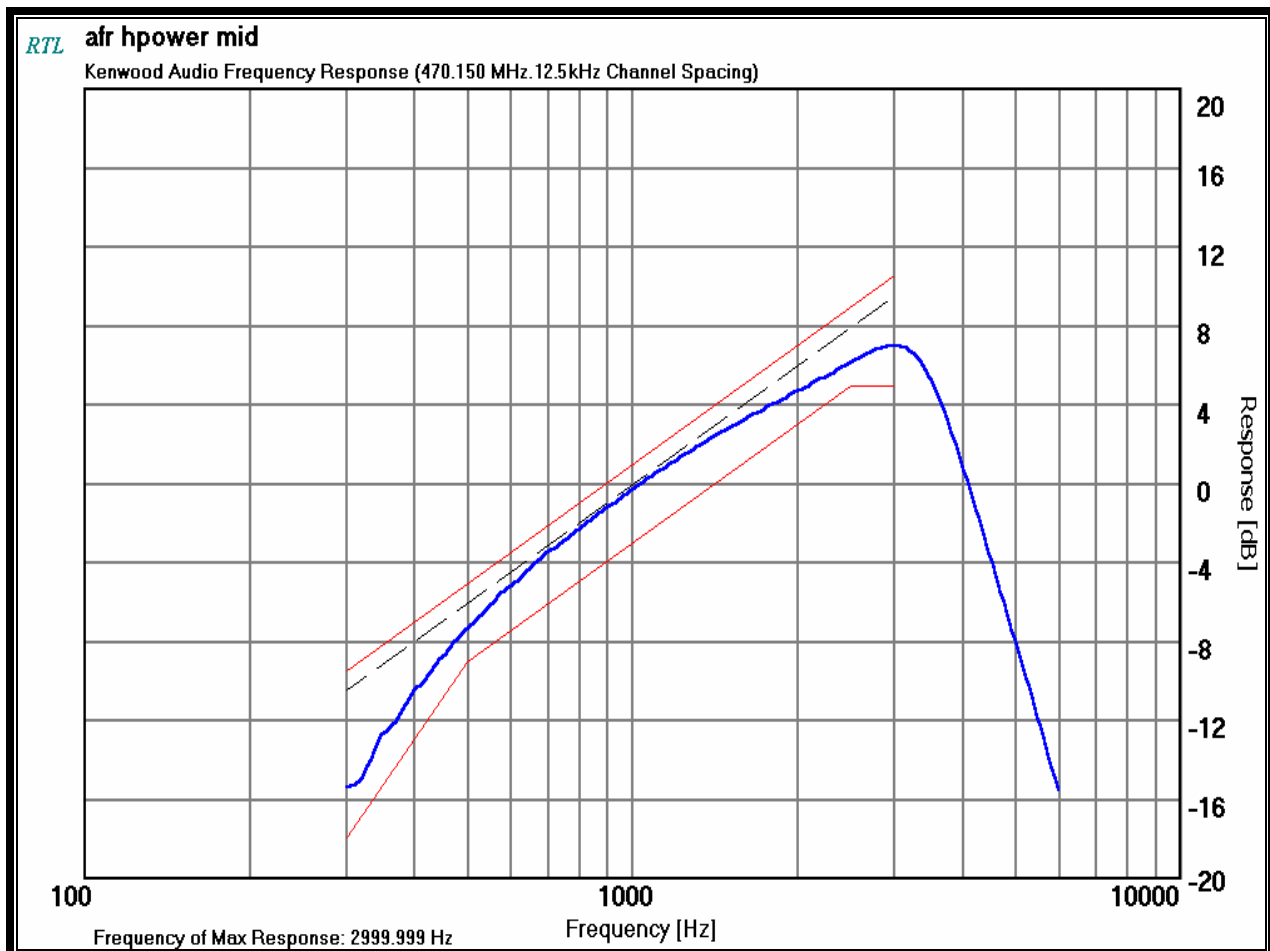



TABLE 10-1: TEST EQUIPMENT USED FOR TESTING (AUDIO FREQUENCY RESPONSE)

RTL Asset #	Manufacturer	Model	Part Type	Serial Number	Calibration Due Date
901057	Hewlett Packard	3336B	Synthesizer/Level Generator	2514A02585	8/6/04
901118	Hewlett Packard	8901A Opt. 002-003	Modulation Analyzer	2406A00178	6/18/04
901054	Hewlett Packard	3586B	Selective Level Meter	1928A01892	9/9/04

TEST PERSONNEL:

RACHID SEHB		SEPTEMBER 28, 2003
TEST TECHNICIAN/ENGINEER	SIGNATURE	DATE OF TEST

11 FCC PART 2 §2.1047 (A): MODULATION CHARACTERISTICS – AUDIO LOW PASS FILTER

11.1 TEST PROCEDURE

ANSI/TIA/EIA-603-1992, 2.2.15

The Audio Low Pass Filter Response is the frequency response of the post limiter low pass filter circuit above 3000 Hz.

11.2 TEST DATA

PLOT 11-1: MODULATION CHARACTERISTICS – AUDIO LOW PASS FILTER



TABLE 11-1: TEST EQUIPMENT USED FOR TESTING (AUDIO LOW PASS FILTER RESPONSE)

RTL Asset #	Manufacturer	Model	Part Type	Serial Number	Calibration Due Date
901057	Hewlett Packard	3336B	Synthesizer/Level Generator	2514A02585	9/9/04
901118	Hewlett Packard	8901A Opt. 002-003	Modulation Analyzer	2406A00178	6/18/04
901054	Hewlett Packard	3586B	Selective Level Meter	1928A01892	9/9/04

TEST PERSONNEL:

RACHID SEHB		SEPTEMBER 28, 2003
TEST TECHNICIAN/ENGINEER	SIGNATURE	DATE OF TEST

12 FCC RULES AND REGULATIONS PART 2 §2.1047 (B): MODULATION CHARACTERISTICS - MODULATION LIMITING

12.1 TEST PROCEDURE

ANSI/TIA/EIA-603-1992, section 2.2.3

The transmitter was adjusted for full rated system deviation. The audio input level was adjusted for 60% of rated system deviation at 1000 Hz. Using this level as a reference (0dB) the audio input level was varied from the reference +/-20 dB for modulation frequencies of 300 Hz, 1,000 Hz, and 2,500 Hz. The system deviation obtained as a function of the input level was recorded. Both positive and negative peak deviations were recorded.

12.2 TEST DATA

PLOT 12-1: MODULATION CHARACTERISTICS – MODULATION LIMITING: WIDE BAND; POSITIVE PEAK

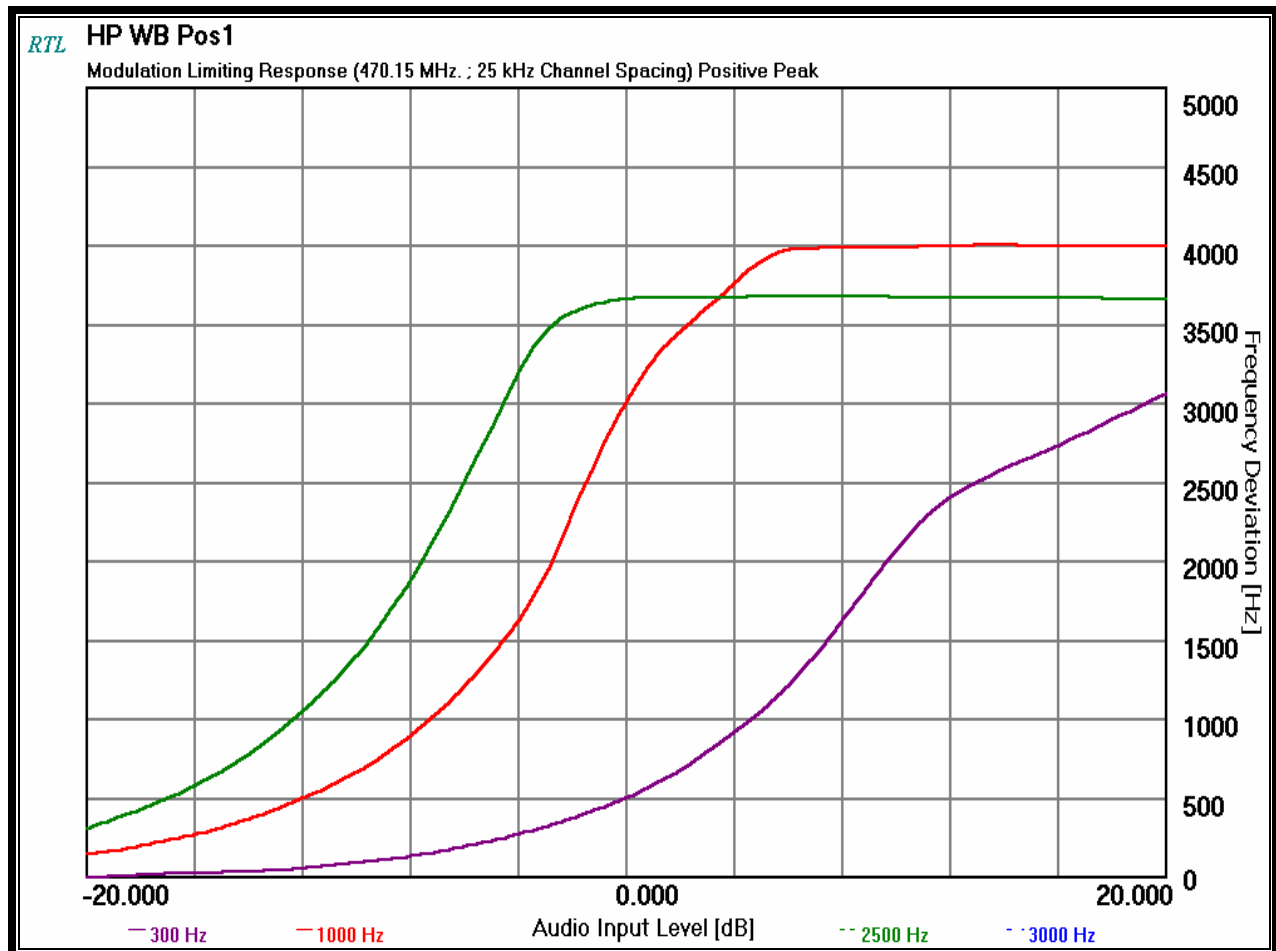

PLOT 12-2: MODULATION CHARACTERISTICS – MODULATION LIMITING: WIDE BAND; NEGATIVE PEAK

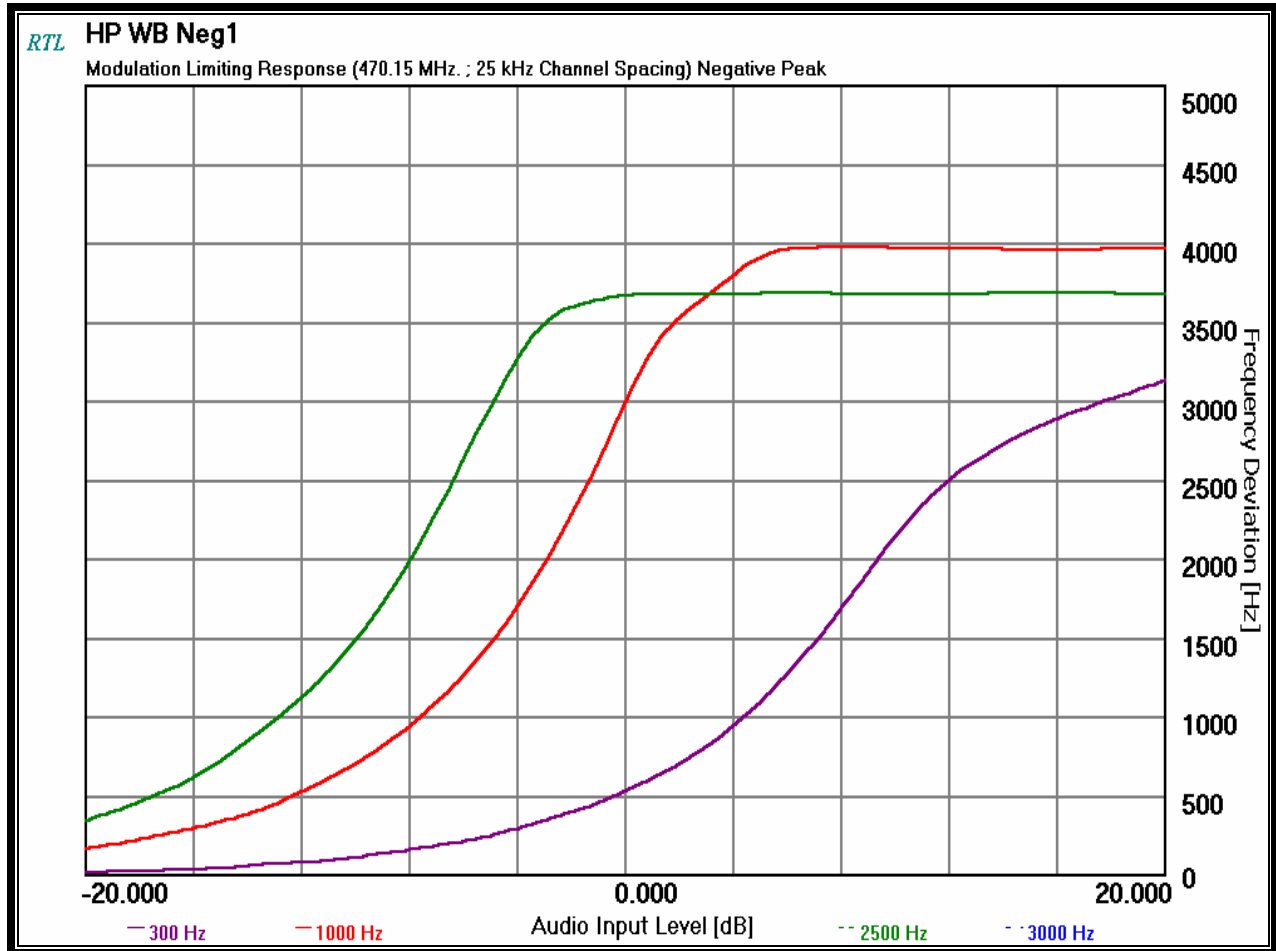

PLOT 12-3: MODULATION CHARACTERISTICS – MODULATION LIMITING: NARROW BAND; POSITIVE PEAK

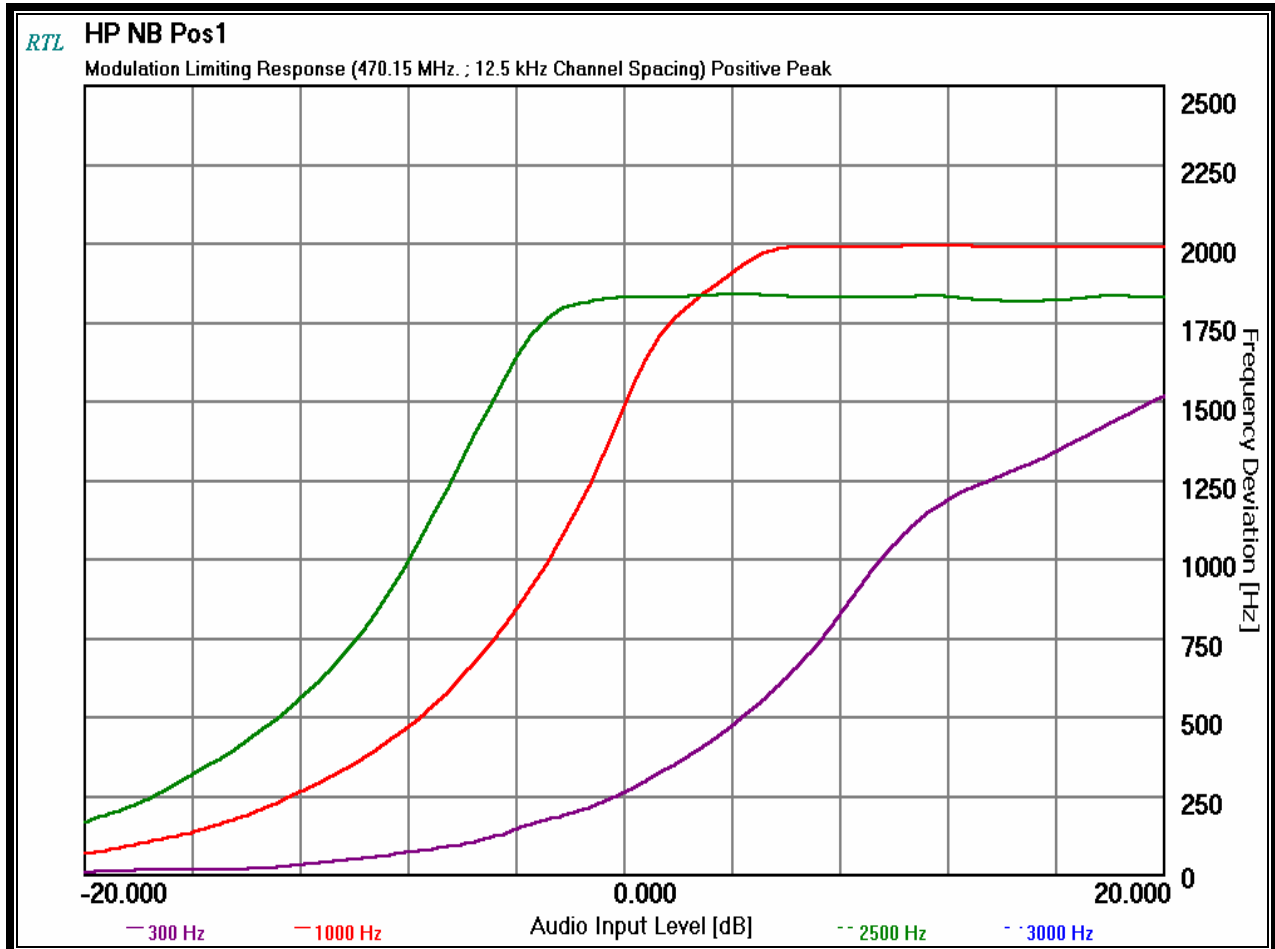

PLOT 12-4: MODULATION CHARACTERISTICS – MODULATION LIMITING: NARROW BAND; NEGATIVE PEAK

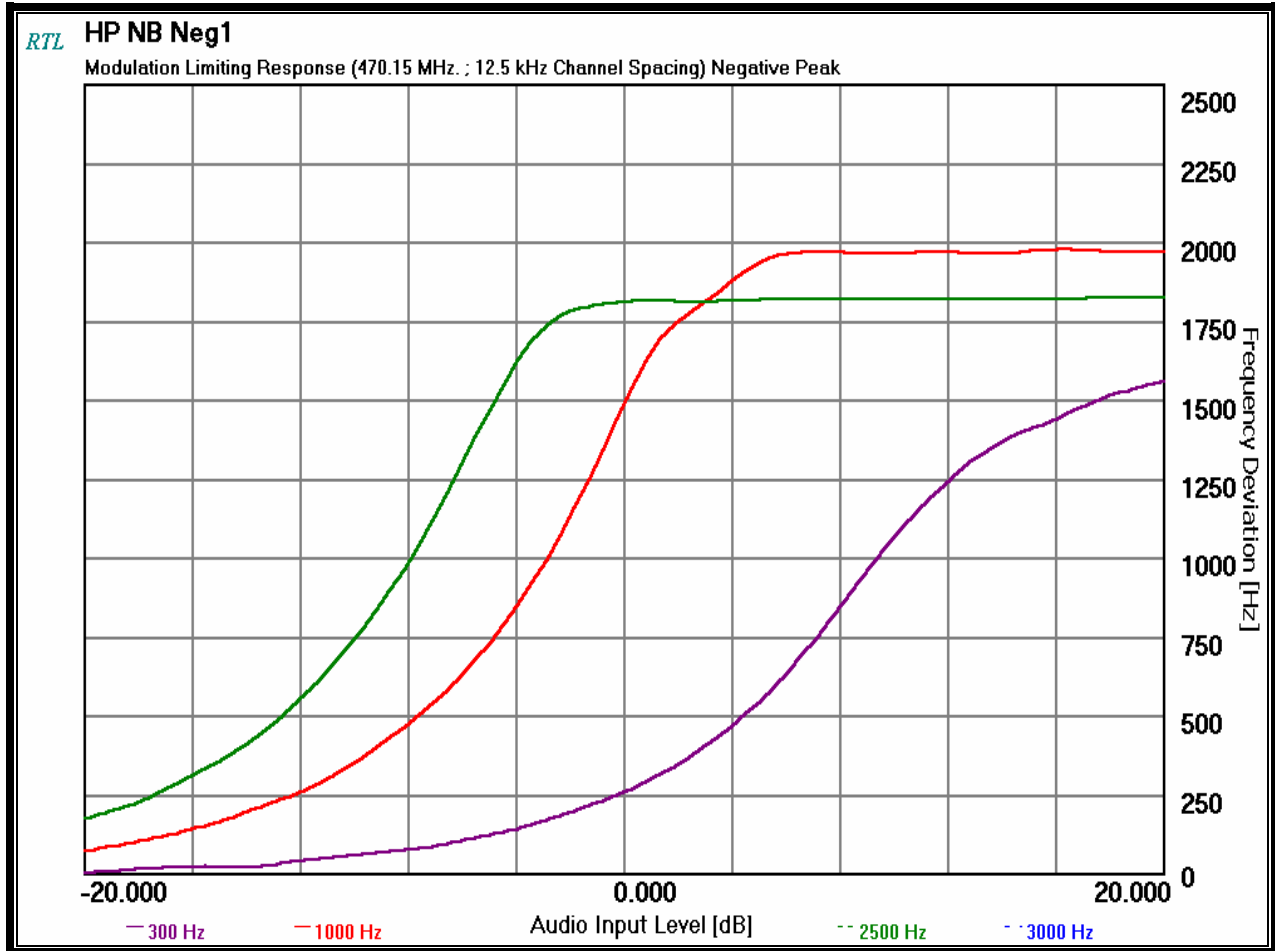



TABLE 12-1: TEST EQUIPMENT USED FOR TESTING (MODULATION LIMITING)

RTL Asset #	Manufacturer	Model	Part Type	Serial Number	Calibration Due Date
901057	Hewlett Packard	3336B	Synthesizer/Level Generator	2514A02585	9/9/04
901118	Hewlett Packard	8901A Opt. 002-003	Modulation Analyzer	2406A00178	6/18/04
901054	Hewlett Packard	3586B	Selective Level Meter	1928A01892	9/9/04

TEST PERSONNEL:

RACHID SEHB		SEPTEMBER 30, 2003
TEST TECHNICIAN/ENGINEER	SIGNATURE	DATE OF TEST

13 FCC RULES AND REGULATIONS PART 90 §90.214: TRANSIENT FREQUENCY BEHAVIOR

13.1 TEST PROCEDURE

ANSI/TIA/EIA-603-1992, section 2.2.3

13.2 TEST DATA

PLOT 13-1: TRANSIENT FREQUENCY BEHAVIOR – 470.15 MHz; HIGH POWER; WIDE BAND; CARRIER ON TIME

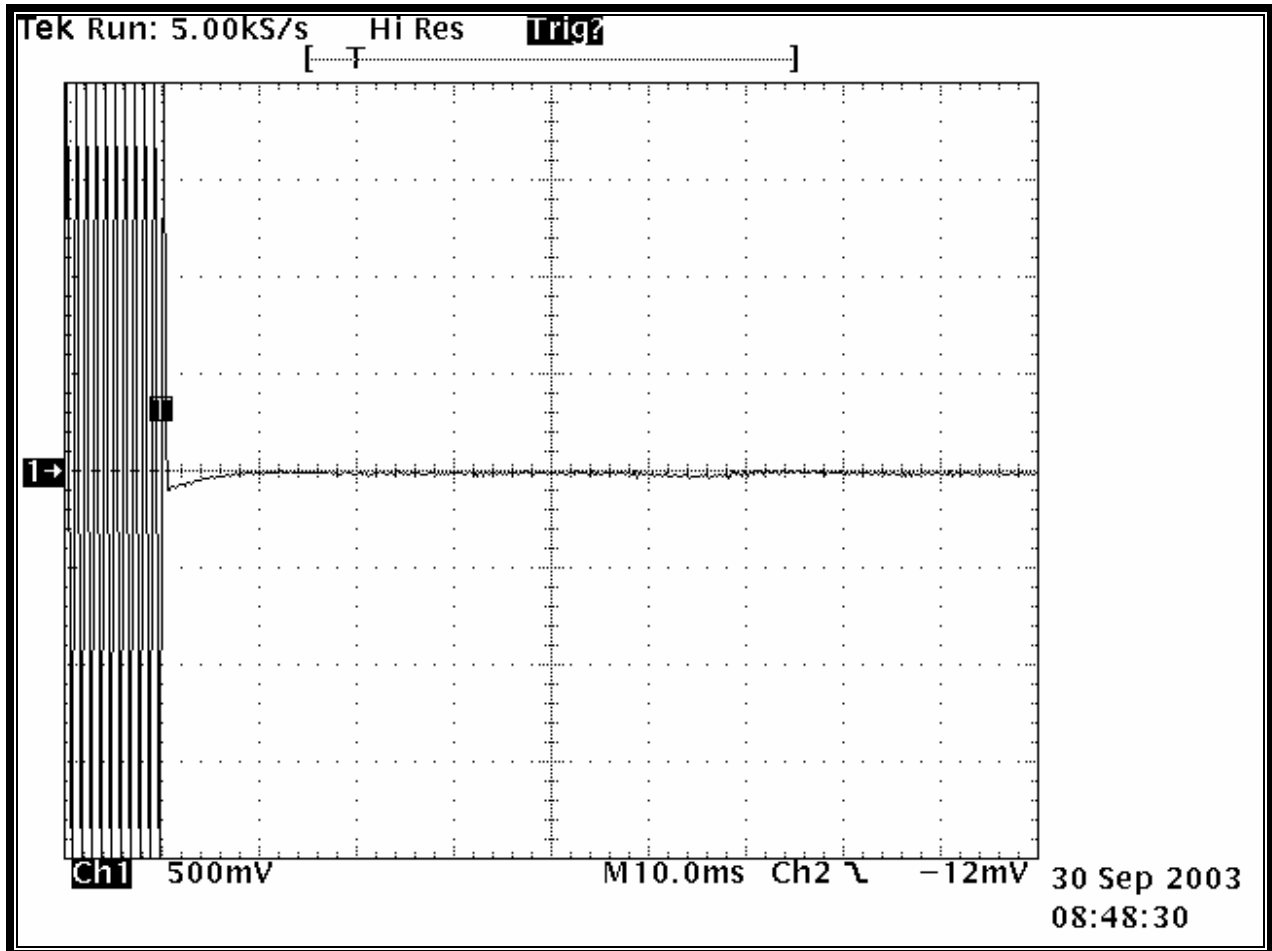

PLOT 13-2: TRANSIENT FREQUENCY BEHAVIOR – 470.15 MHz; HIGH POWER; WIDE BAND; CARRIER OFF TIME

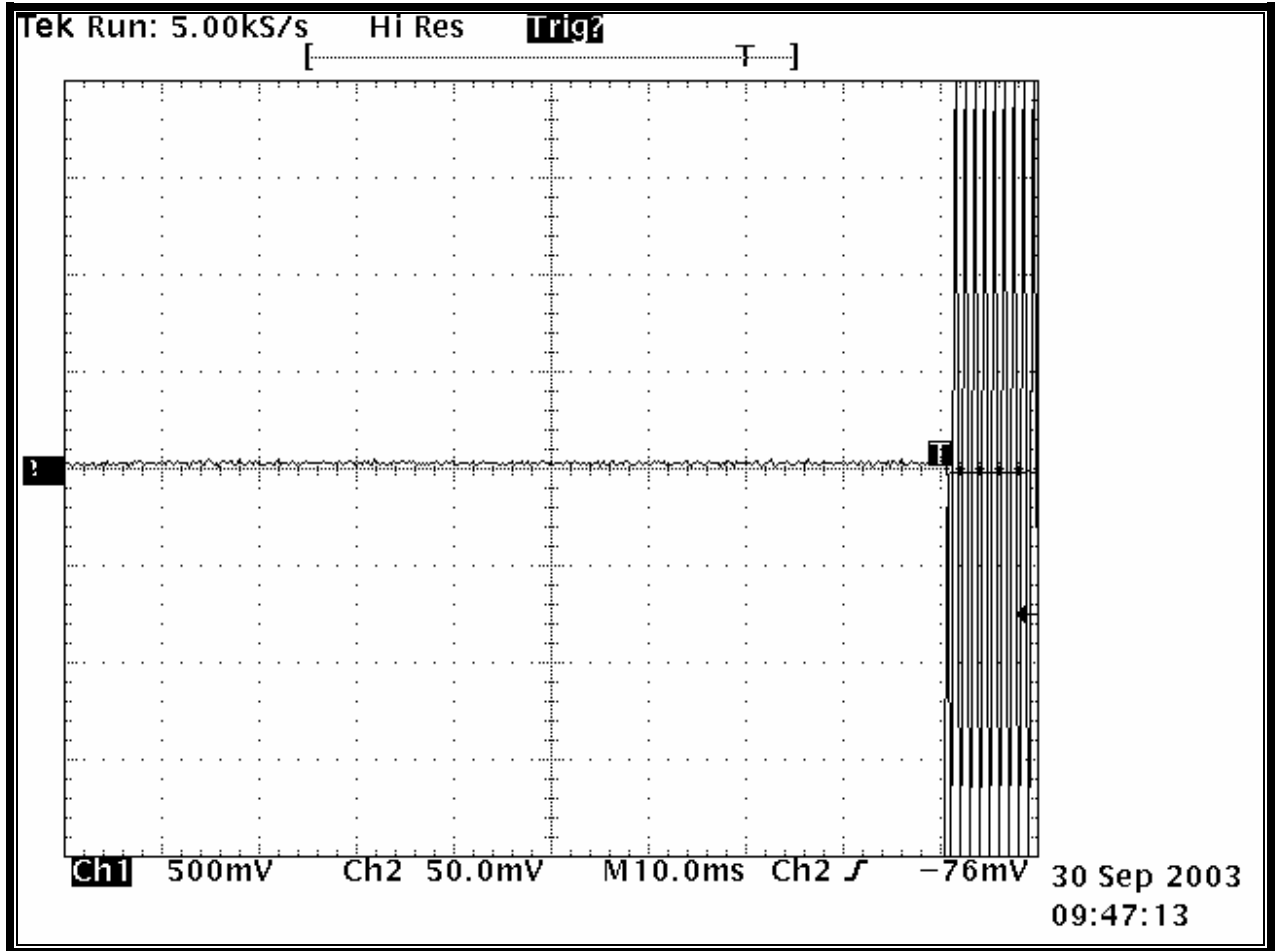

PLOT 13-3: TRANSIENT FREQUENCY BEHAVIOR – 470.15 MHz; HIGH POWER; NARROW BAND; CARRIER ON TIME

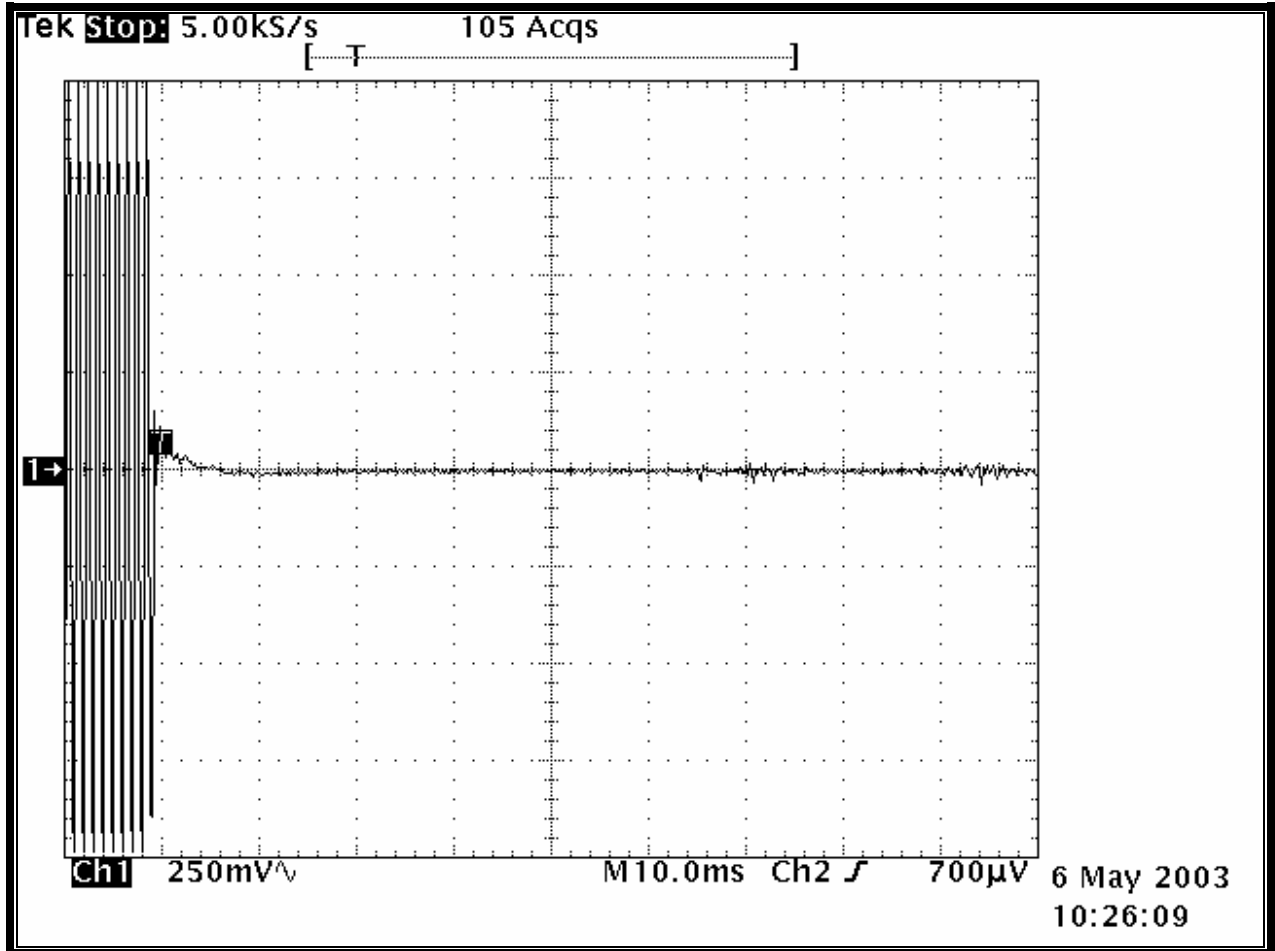

PLOT 13-4: TRANSIENT FREQUENCY BEHAVIOR – 470.15 MHz; HIGH POWER; NARROW BAND; CARRIER OFF TIME

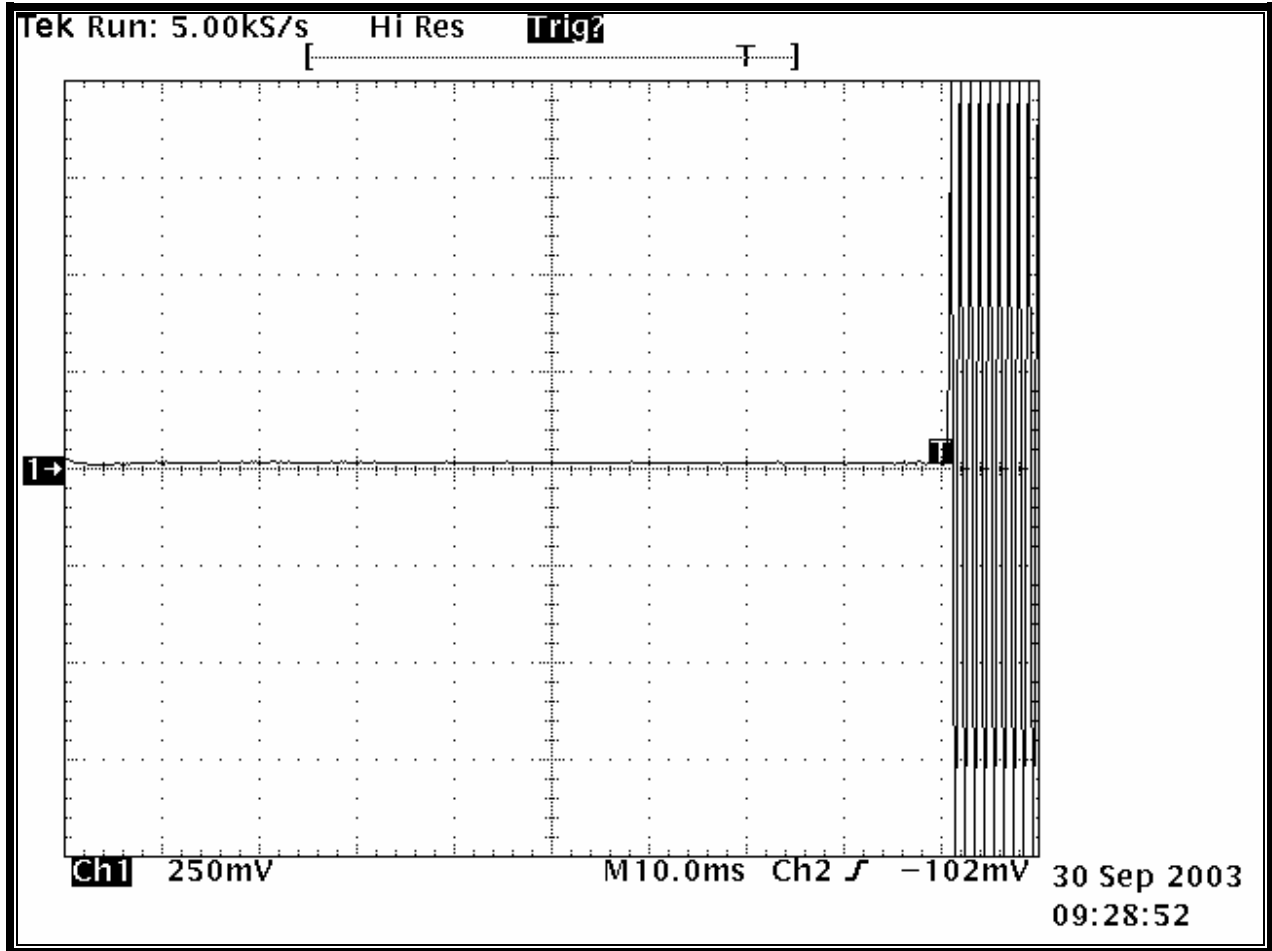



TABLE 13-1: TEST EQUIPMENT USED FOR TESTING (TRANSIENT FREQUENCY BEHAVIOR)

RTL Asset #	Manufacturer	Model	Part Type	Serial Number	Calibration Due Date
901118	Hewlett Packard	8901A Opt. 002-003	Modulation Analyzer	2406A00178	6/18/04
900917	Hewlett Packard	8648C	Signal Generator	3537A01741	05/02/04
900561	Tektronix	TDS540B	Oscilloscope	B020129	02/19/04
900352	Werlatone	C1795	Directional Coupler	4989	N/A

TEST PERSONNEL:

RACHID SEHB		SEPTEMBER 30, 2003
TEST TECHNICIAN/ENGINEER	SIGNATURE	DATE OF TEST

14 FCC RULES AND REGULATIONS PART 2 §2.202: NECESSARY BANDWIDTH AND EMISSION BANDWIDTH

Type of Emission: F3E, F1D, F1E

Necessary Bandwidth and Emission Bandwidth:

Voice – 25 kHz channel separation

Calculation:

Max modulation(M) in kHz: 3.0

Max deviation (D) in kHz: 5

Constant factor (K): 1 (assumed)

$B_n = 2xM+2xDK = 16.0$ kHz

Emission designator: 16K0F3E

Voice – 12.5 kHz channel separation

Calculation:

Max modulation(M) in kHz: 3.0

Max deviation (D) in kHz: 2.5

Constant factor (K): 1 (assumed)

$B_n = 2xM+2xDK = 11.0$ kHz

Emission designator: 11K0F3E

15 CONCLUSION

The data in this measurement report shows that the **Kenwood USA Corporation**, Model **TK-8100-1**, FCC ID: **ALH36033110**, complies with all the requirements of Parts 90, 74, 22, 15, and 2 of the FCC Rules, and Industry Canada RSS-119, Issue 6, 2000.