

| USE FOR    | SYMBOL | REVISION NO | ISSUED | DATE |
|------------|--------|-------------|--------|------|
| X57-639... | △      |             |        |      |
|            | △      |             |        |      |
|            | △      |             |        |      |
|            | △      |             |        |      |
|            | △      |             |        |      |
|            | △      |             |        |      |
|            | △      |             |        |      |
|            | △      |             |        |      |
|            | △      |             |        |      |
|            | △      |             |        |      |

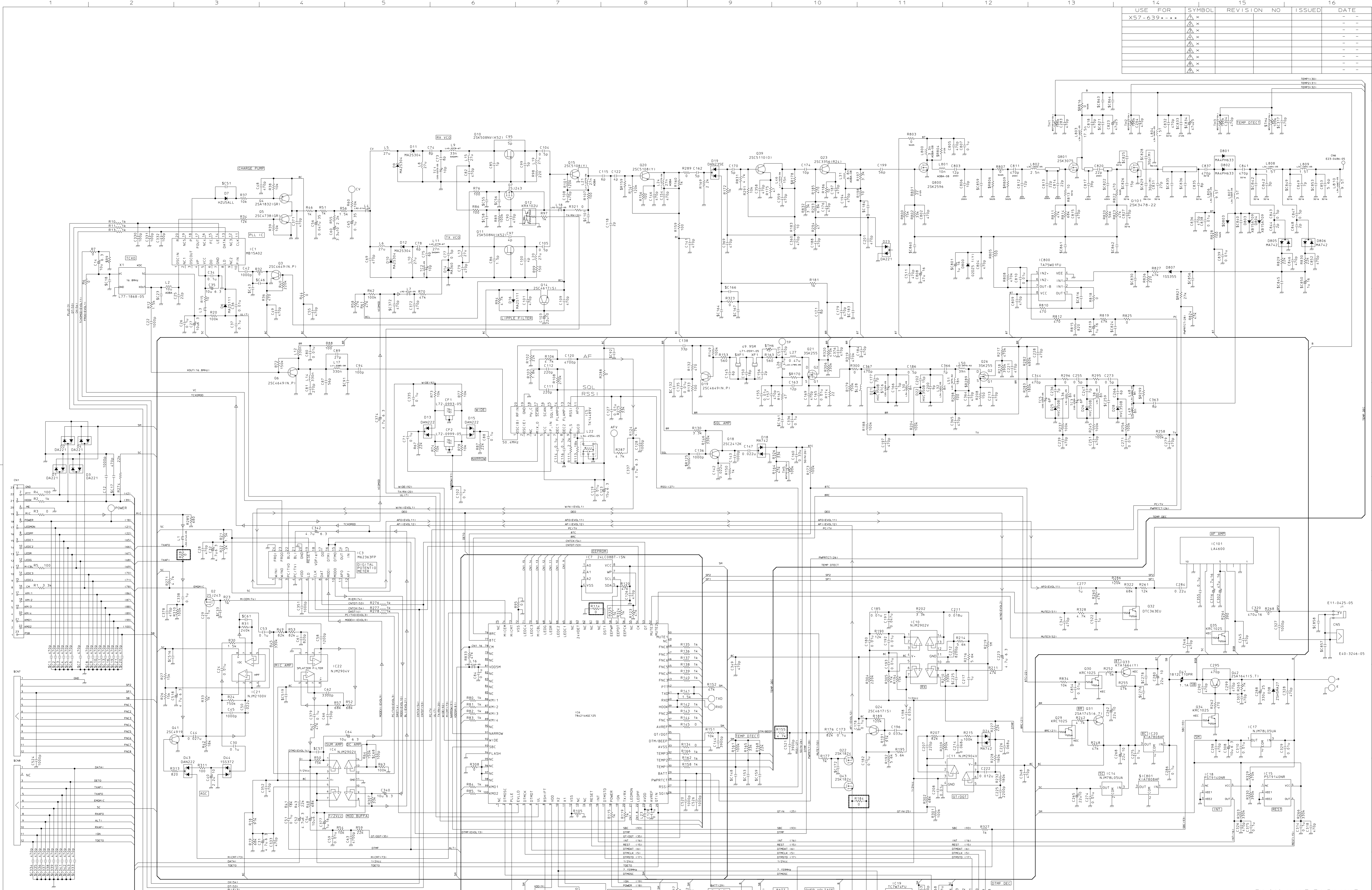

| DESIGNED | DRAWN | CHECKED | APPROVED | PART NAME           |
|----------|-------|---------|----------|---------------------|
| 00DES    |       | 00CHE   | 00APP    | UNIT WIRING DIAGRAM |
| 00ESIG   |       | 00CHK   | 00APRD   | PART NUMBER         |





TK-810\*H UHF TX/RX UNIT  
 1/100  
 株式会社ケンウッド KENWOOD CORPORATION

1

2

3

4

| USE FOR     | SYMBOL  | REVISION NO | ISSUED  | DATE      |
|-------------|---|-------------|---------|-----------|
| X54-334*-** |  ×2  |             | Y. HORI | 2001-4-27 |
|             |  ×  |             |         | -         |
|             |  × |             |         | -         |
|             |  × |             |         | -         |
|             |  × |             |         | -         |

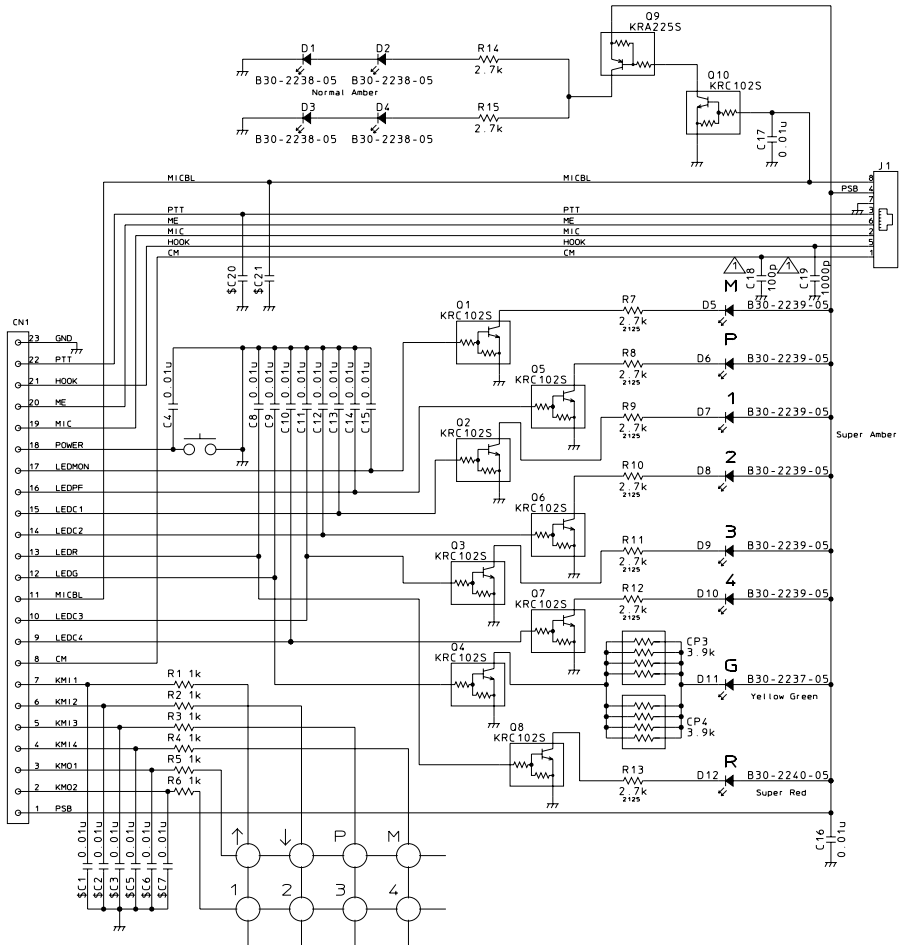

## TK-710\*/810\* DISPLAY UNIT

| DESIGNED                      | DRAWN       | CHECKED     | APPROVED     | PART NAME          |   |
|-------------------------------|-------------|-------------|--------------|--------------------|---|
| @D_DES                        | 15/MAY/2001 | 15/MAY/2001 | 15/MAY/2001  | SCEMATIC DIAGRAM   | F |
| @DESIG                        | Y. HORI     | Y. KUNAGAI  | K. MOROHASHI | PART NUMBER        | S |
| 株式会社ケンウッド KENWOOD CORPORATION |             |             |              | Z92-0821-04 1/1 01 | - |