

CERTIFICATE OF COMPLIANCE SAR EVALUATION

<p><u>Test Lab:</u></p> <p>CELLTECH RESEARCH INC. Testing and Engineering Lab 1955 Moss Court Kelowna, B.C. Canada V1Y 9L3 Phone: 250 - 860-3130 Fax: 250 - 860-3110 Toll Free: 1-877-545-6287 e-mail: info@celltechlabs.com web site: www.celltechlabs.com</p>	<p><u>Applicant Information:</u></p> <p>KENWOOD COMMUNICATIONS CORP. 3975 Johns Creek Court, Suite 300 Suwanee, GA 30024</p>
---	--

FCC Rule Part(s):	2.1093; ET Docket 96-326
FCC ID:	ALH32263130
Model(s):	TK-3140-3
EUT Type:	Portable UHF PTT Radio Transceiver
Modulation:	FM (UHF Band)
Tx Frequency Range:	400 - 430 MHz
Rated RF Conducted Power:	4.0 Watts (High Power)
Antenna Type(s):	Fixed Stubby
Battery Type(s):	7.2VDC 1200mAh Ni-Cd 7.2VDC 2000mAh Ni-MH
Body-Worn Accessories:	Belt-Clip & Speaker-Microphone

Celltech Research Inc. declares under its sole responsibility that this device was found to be in compliance with the Specific Absorption Rate (SAR) RF exposure requirements specified in OET Bulletin 65, Supplement C, Edition 01-01 (Occupational/Controlled Exposure), and was tested in accordance with the appropriate measurement standards, guidelines, and recommended practices specified in American National Standards Institute C95.1-1992.

I attest to the accuracy of data. All measurements were performed by me or were made under my supervision and are correct to the best of my knowledge and belief. I assume full responsibility for the completeness of these measurements and vouch for the qualifications of all persons taking them.

This test report shall not be reproduced partially, or in full, without the prior written approval of Celltech Research Inc. The results and statements contained in this report pertain only to the device(s) evaluated.



Shawn McMillen
General Manager
Celltech Research Inc.



TABLE OF CONTENTS

1.0	INTRODUCTION.....	1
2.0	DESCRIPTION OF EQUIPMENT UNDER TEST.....	1
3.0	SAR MEASUREMENT SYSTEM	2
4.0	MEASUREMENT SUMMARY.....	3-4
5.0	DETAILS OF SAR EVALUATION.....	5
6.0	EVALUATION PROCEDURES.....	6
7.0	SYSTEM VALIDATION.....	7
8.0	TISSUE PARAMETERS.....	7
9.0	SIMULATED TISSUES.....	8
10.0	SAR SAFETY LIMITS.....	8
11.0	ROBOT SYSTEM SPECIFICATIONS.....	9
12.0	SAM PHANTOM.....	10
13.0	LARGE PLANAR PHANTOM.....	10
14.0	DEVICE HOLDER.....	10
15.0	PROBE SPECIFICATION.....	10
16.0	TEST EQUIPMENT LIST.....	11
17.0	MEASUREMENT UNCERTAINTIES.....	12
18.0	REFERENCES.....	13
	APPENDIX A - SAR MEASUREMENT DATA.....	14
	APPENDIX B - DIPOLE VALIDATION.....	15
	APPENDIX C - DIPOLE CALIBRATION.....	16
	APPENDIX D - PROBE CALIBRATION.....	17
	APPENDIX E - SAR SENSITIVITIES.....	18
	APPENDIX F - SAR TEST SETUP PHOTOGRAPHS.....	19

1.0 INTRODUCTION

This measurement report shows that the KENWOOD COMMUNICATIONS CORP. Model: TK-3140-3 Portable UHF PTT Radio Transceiver FCC ID: ALH32263130 complies with FCC Part 2.1093, ET Docket 96-326 Rules for mobile and portable devices (controlled exposure). The test procedures, as described in American National Standards Institute C95.1-1992 (see reference [1]), and FCC OET Bulletin 65, Supplement C, Edition 01-01 (see reference [2]) were employed. A description of the product and operating configuration, detailed summary of the test results, methodology and procedures used in the evaluation, equipment used, and the various provisions of the rules are included within this test report.

2.0 DESCRIPTION OF EQUIPMENT UNDER TEST (EUT)

Rule Part(s)	FCC 2.1093; ET Docket 96.326	Modulation	FM (UHF Band)
EUT Type	Portable UHF PTT Radio Transceiver	Tx Frequency Range	400 - 430 MHz
Body-Worn Accessories	1. Belt-Clip 2. Speaker-Microphone	Rated RF Conducted Output Power	4.0 Watts (High Power)
FCC ID	ALH32263130	Antenna Type	Fixed Stubby
Model No.(s)	TK-3140-3	Antenna Length	83 mm
Serial No.	Pre-production	Battery Type(s)	7.2VDC 1200mAh Ni-Cd 7.2VDC 2000mAh Ni-MH



EUT with Speaker-Mic



Front of EUT



Back of EUT & Belt-Clip



Right Side of EUT



Left Side of EUT



Ni-Cd & Ni-MH Batteries

3.0 SAR MEASUREMENT SYSTEM

Celltech Research SAR measurement facility utilizes the Dosimetric Assessment System (DASY™) manufactured by Schmid & Partner Engineering AG (SPEAG™) of Zurich, Switzerland. The DASY system is comprised of the robot controller, computer, near-field probe, probe alignment sensor, specific anthropomorphic mannequin (SAM) phantom, and various planar phantoms for brain or body SAR evaluations. The robot is a six-axis industrial robot performing precise movements to position the probe to the location (points) of maximum electromagnetic field (EMF). A cell controller system contains the power supply, robot controller, teach pendant (Joystick), and remote control, is used to drive the robot motors. The Staubli robot is connected to the cell controller to allow software manipulation of the robot. A data acquisition electronic (DAE) circuit performs the signal amplification, signal multiplexing, AD-conversion, offset measurements, mechanical surface detection, collision detection, etc. is connected to the Electro-optical coupler (EOC). The EOC performs the conversion from the optical into digital electric signal of the DAE and transfers data to the PC plug-in card. The DAE3 utilizes a highly sensitive electrometer-grade preamplifier with auto-zeroing, a channel and gain-switching multiplexer, a fast 16-bit AD-converter and a command decoder and control logic unit. Transmission to the PC-card is accomplished through an optical downlink for data and status information and an optical uplink for commands and clock lines. The mechanical probe-mounting device includes two different sensor systems for frontal and sidewise probe contacts. They are also used for mechanical surface detection and probe collision detection. The robot uses its own controller with a built in VME-bus computer.



DASY3 SAR Measurement System with SAM phantom

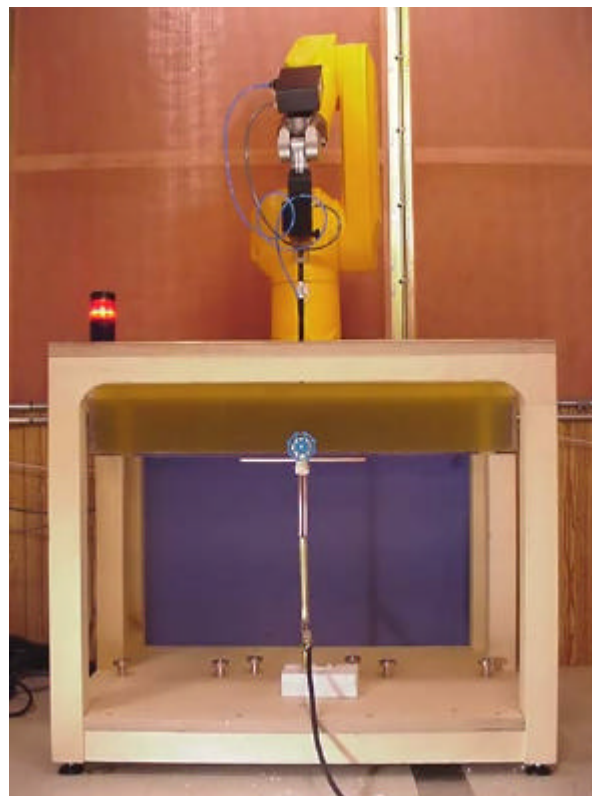

DASY3 SAR Measurement System with large planar phantom

4.0 MEASUREMENT SUMMARY

The measurement results were obtained with the EUT tested in the conditions described in this report. Detailed measurement data and plots showing the maximum SAR location of the EUT are reported in Appendix A.

Face-Held SAR Measurement Results

Freq. (MHz)	Channel	Mode	Conducted Power Before (W)	Conducted Power After (W)	Battery Type	Separation Distance (cm)	SAR (w/kg)	
							100% Duty Cycle	50% Duty Cycle
400.05	Low	CW	4.0	3.8	2000mAh Ni-MH	2.5	5.71	2.86
415.05	Mid	CW	4.1	3.9	2000mAh Ni-MH	2.5	5.09	2.55
429.95	High	CW	4.1	3.9	2000mAh Ni-MH	2.5	6.47	3.24
429.95	High	CW	4.1	3.9	1200mAh Ni-Cd	2.5	6.23	3.12
Mixture Type: Brain Dielectric Constant: 43.7 Conductivity: 0.87 (Measured)				ANSI / IEEE C95.1 1992 - SAFETY LIMIT Spatial Peak: Controlled Exposure / Occupational BRAIN: 8.0 W/kg (averaged over 1 gram)				

Notes:

1. The SAR values found were below the maximum limit of 8.0 w/kg (controlled exposure).
2. The highest face-held SAR value found was 6.47 w/kg (100% duty cycle, 2000mAh Ni-MH battery).
3. The EUT was tested for face-held SAR with a 2.5cm separation distance between the front of the EUT and the outer surface of the SAM planar phantom.
4. Ambient TEMPERATURE: 23.3 °C
 Relative HUMIDITY: 38.7 %
 Atmospheric PRESSURE: 101.1 kPa
5. Fluid Temperature ≈ 23.0 °C
6. During the entire test the conducted power was maintained to within 5% of the initial conducted power.



Face-held SAR Test Setup
 2.5cm Separation Distance

Body-Worn SAR Measurement Results

Freq. (MHz)	Channel	Mode	Conducted Power Before (W)	Conducted Power After (W)	Battery Type	Belt-Clip Separation Distance (cm)	SAR (w/kg)	
							100% Duty Cycle	50% Duty Cycle
400.05	Low	CW	4.0	3.8	2000mAh Ni-MH	1.0	7.20	3.60
415.05	Mid	CW	4.1	3.9	2000mAh Ni-MH	1.0	8.25	4.13
429.95	High	CW	4.1	3.9	2000mAh Ni-MH	1.0	7.79	3.90
415.05	Mid	CW	4.1	3.9	1200mAh Ni-Cd	1.0	8.07	4.04
Mixture Type: Body Dielectric Constant: 56.9 Conductivity: 0.94 (Measured)				ANSI / IEEE C95.1 1992 - SAFETY LIMIT Spatial Peak Controlled Exposure / Occupational BRAIN: 8.0 W/kg (averaged over 1 gram)				

Notes:

1. The highest SAR value found was below the maximum limit of 8.0 w/kg (controlled exposure, 50% duty cycle).
2. The highest body-worn SAR value found was 4.13 w/kg (50% duty cycle, 2000mAh Ni-MH battery).
3. The EUT was tested for body-worn SAR with speaker-microphone accessory, and the attached belt-clip providing a 1.0cm separation distance between the back of the EUT and the outer surface of the SAM planar phantom.
4. Ambient TEMPERATURE: 23.3 °C
 Relative HUMIDITY: 38.7 %
 Atmospheric PRESSURE: 101.1 kPa
5. Fluid Temperature ≈ 23.0 °C
6. During the entire test the conducted power was maintained to within 5% of the initial conducted power.



Body-worn SAR Test Setup with Belt-Clip & Speaker-Mic (Belt-Clip providing a 1.0cm Separation)

5.0 DETAILS OF SAR EVALUATION

The KENWOOD COMMUNICATIONS CORP. Model: TK-3140-3 Portable UHF PTT Radio Transceiver FCC ID: ALH32263130 was found to be compliant for localized Specific Absorption Rate (controlled exposure) based on the following test provisions and conditions:

1. The EUT was tested in a face-held configuration with the front of the device placed parallel to the outer surface of the SAM planar phantom at a 2.5cm separation distance.
2. The EUT was tested in a body-worn configuration with speaker-microphone accessory, and the attached belt-clip touching the outer surface of the planar phantom. The belt-clip provided a 1.0cm separation distance between the back of the EUT and the outer surface of the SAM planar phantom.
3. The EUT was evaluated for SAR at maximum power and the unit was operated for an appropriate period prior to the evaluation in order to minimize drift. The conducted power levels were checked before and after each test. If the conducted power level deviated more than 5% of the initial power level, then the EUT was retested. Any unusual anomalies over the course of the test also warranted a re-evaluation.
4. The conducted power was measured according to the procedures described in FCC Part 2.1046.
5. The EUT was tested with the transmitter in continuous operation (100% duty cycle) throughout the SAR evaluation. As this is a push-to-talk device the 50% duty cycle compensation reported assumes a transmit/receive cycle of equal time base.
6. The location of the maximum spatial SAR distribution (Hot Spot) was determined relative to the device and its antenna.
7. The EUT was tested with a fully charged battery (2000mAh and 1200mAh battery options).



Face SAR Test Setup with SAM Planar Phantom



Body SAR Test Setup with SAM Planar Phantom

6.0 EVALUATION PROCEDURES

The Specific Absorption Rate (SAR) evaluation was performed in the following manner:

- a. (i) The evaluation was performed in the applicable area of the phantom depending on the type of device being tested. For devices held to the ear during normal operation both the left and right ear positions were evaluated at the low, middle, and high frequencies of the band at maximum power, and with the device antenna in both the extended and extracted positions as applicable. The positioning of the ear-held device relative to the phantom was performed in accordance with FCC OET Bulletin 65, Supplement C (Edition 01-01) using the SAM phantom.
- (ii) For face-held and body-worn devices a planar phantom was used. Depending on the phantom used for the evaluation, all other phantoms were drained of fluid.
- b. The SAR was determined by a pre-defined procedure within the DASY3 software. Upon completion of a reference and optical surface check, the exposed region of the phantom was scanned near the inner surface using a uniform grid spacing.
- c. A 5x5x7 matrix was performed around the greatest spatial SAR distribution found during the area scan of the applicable exposed region. SAR values were then calculated using a 3-D spline interpolation algorithm and averaged over spatial volumes of 1 and 10 grams.
- d. The depth of the simulating tissue in the phantom used for the SAR evaluation was no less than 15cm.
- e. The target tissue parameters for 450MHz were used in the SAR evaluation software. If there was any appreciable variation in the measured tissue parameters from the target values specified then the SAR was adjusted using the sensitivities to SAR (see "Appendix D - SAR Sensitivities").

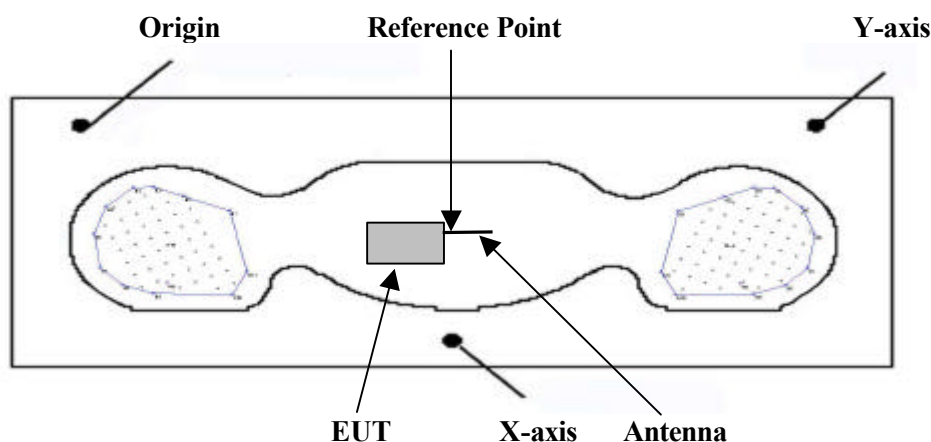

Device Positioning & Reference Point

7.0 SYSTEM VALIDATION

Prior to the assessment, the system was verified in a planar phantom with a 450MHz dipole. A forward power of 250mW was applied to the dipole and the system was verified to a tolerance of $\pm 10\%$. The applicable verifications are as follows (see Appendix B for dipole validation test plots and Appendix C for dipole calibration information):

Dipole Validation Kit	Target SAR 1g (w/kg)	Measured SAR 1g (w/kg)	Fluid Temperature	Validation Date
450MHz	1.47	1.46	≈ 23.0 °C	11/29/01

8.0 TISSUE PARAMETERS

The dielectric parameters of the fluids were verified prior to the SAR evaluation using an 85070C Dielectric Probe Kit and an 8753E Network Analyzer. The dielectric parameters of the fluid are as follows:

BRAIN TISSUE PARAMETERS - DIPOLE VALIDATION AND EUT EVALUATION			
Equivalent Tissue	Dielectric Constant ϵ_r	Conductivity s (mho/m)	r (Kg/m ³)
450MHz Brain (Target)	$43.5 \pm 5\%$	$0.87 \pm 5\%$	1000
450MHz Brain (Measured: 11/29/01)	43.7	0.87	1000

BODY TISSUE PARAMETERS - EUT EVALUATION			
Equivalent Tissue	Dielectric Constant ϵ_r	Conductivity s (mho/m)	r (Kg/m ³)
450MHz Body (Target)	$56.7 \pm 5\%$	$0.94 \pm 5\%$	1000
450MHz Body (Measured: 11/29/01)	56.9	0.94	1000

9.0 SIMULATED TISSUES

The brain and muscle mixtures consist of a viscous gel using hydroxethylcellulose (HEC) gelling agent and saline solution. Preservation with a bactericide is added and visual inspection is made to ensure air bubbles are not trapped during the mixing process. The fluid was prepared according to standardized procedures, and measured for dielectric parameters (permittivity and conductivity).

TISSUE MIXTURES FOR DIPOLE VALIDATION & EUT EVALUATION		
INGREDIENT	450MHz Brain Mixture (Validation & EUT Evaluation) %	450MHz Body Mixture (EUT Evaluation) %
Water	38.56	52.00
Sugar	56.32	45.65
Salt	3.95	1.75
HEC	0.98	0.10
Bactericide	0.19	0.10

10.0 SAR SAFETY LIMITS

EXPOSURE LIMITS	SAR (W/Kg)	
	(General Population / Uncontrolled Exposure Environment)	(Occupational / Controlled Exposure Environment)
Spatial Average (averaged over the whole body)	0.08	0.4
Spatial Peak (averaged over any 1g of tissue)	1.60	8.0
Spatial Peak (hands/wrists/feet/ankles averaged over 10g)	4.0	20.0

Notes:

1. Uncontrolled environments are defined as locations where there is potential exposure of individuals who have no knowledge or control of their potential exposure.
2. Controlled environments are defined as locations where there is potential exposure of individuals who have knowledge of their potential exposure and can exercise control over their exposure.

11.0 ROBOT SYSTEM SPECIFICATIONS

Specifications

POSITIONER: Stäubli Unimation Corp. Robot Model: RX60L
Repeatability: 0.02 mm
No. of axis: 6

Data Acquisition Electronic (DAE) System

Cell Controller

Processor: Pentium III
Clock Speed: 450 MHz
Operating System: Windows NT
Data Card: DASY3 PC-Board

Data Converter

Features: Signal Amplifier, multiplexer, A/D converter, and control logic
Software: DASY3 software
Connecting Lines: Optical downlink for data and status info.
Optical uplink for commands and clock

PC Interface Card

Function: 24 bit (64 MHz) DSP for real time processing
Link to DAE3
16-bit A/D converter for surface detection system
serial link to robot
direct emergency stop output for robot

E-Field Probe

Model: ET3DV6
Serial No.: 1590
Construction: Triangular core fiber optic detection system
Frequency: 10 MHz to 6 GHz
Linearity: ± 0.2 dB (30 MHz to 3 GHz)

Evaluation Phantom

Type: SAM V4.0C
Configuration: Left Head, Right Head, Planar Section
Shell Material: Fiberglass
Thickness: 2.0 ± 0.1 mm
Volume: Approx. 20 liters

Validation Phantom (£ 450MHz)

Type: Large Planar Phantom
Shell Material: Plexiglas
Bottom Thickness: $6.2 \text{ mm} \pm 0.1 \text{ mm}$
Dimensions: 86.0cm (L) x 39.5cm (W) x 21.8cm (H)

12.0 SAM PHANTOM V4.0C

The SAM phantom V4.0C is a fiberglass shell phantom with a 2.0 mm shell thickness for left and right head and flat planar area integrated in a wooden table. The shape of the fiberglass shell corresponds to the phantom defined by SCC34-SC2. The device holder positions are adjusted to the standard measurement positions in the three sections.



SAM Phantom V4.0C

13.0 LARGE PLANAR PHANTOM

The large planar phantom is constructed of Plexiglas material with a 6.0 mm shell thickness for SAR validations at and below 450MHz. The large planar phantom is mounted in the DASY3 compact system in place of the SAM phantom.



Large Planar Phantom

14.0 DEVICE HOLDER

The DASY3 device holder has two scales for device rotation (with respect to the body axis) and the device inclination (with respect to the line between the ear openings). The plane between the ear openings and the mouth tip has a rotation angle of 65°. The bottom plate contains three pair of bolts for locking the device holder. The device holder positions are adjusted to the standard measurement positions in the three sections.



Device Holder

15.0 PROBE SPECIFICATION (ET3DV6)

Construction: Symmetrical design with triangular core
Built-in shielding against static charges
PEEK enclosure material (resistant to organic solvents, e.g. glycol)

Calibration: In air from 10 MHz to 2.5 GHz
In brain simulating tissue at frequencies of 900 MHz
and 1.8 GHz (accuracy $\pm 8\%$)

Frequency: 10 MHz to >6 GHz; Linearity: ± 0.2 dB
(30 MHz to 3 GHz)

Directivity: ± 0.2 dB in brain tissue (rotation around probe axis)
 ± 0.4 dB in brain tissue (rotation normal to probe axis)

Dynam. Rnge: 5 μ W/g to >100 mW/g; Linearity: ± 0.2 dB

Srfce. Detect. ± 0.2 mm repeatability in air and clear liquids over
diffuse reflecting surfaces

Dimensions: Overall length: 330 mm
Tip length: 16 mm
Body diameter: 12 mm
Tip diameter: 6.8 mm
Distance from probe tip to dipole centers: 2.7 mm

Application: General dosimetry up to 3 GHz
Compliance tests of mobile phone



ET3DV6 E-Field Probe

16.0 TEST EQUIPMENT LIST

SAR MEASUREMENT SYSTEM		
<u>EQUIPMENT</u>	<u>SERIAL NO.</u>	<u>DATE CALIBRATED</u>
DASY3 System -Robot -ET3DV6 E-Field Probe -300MHz Validation Dipole -450MHz Validation Dipole -900MHz Validation Dipole -1800MHz Validation Dipole -SAM Phantom V4.0C	599396-01 1590 135 136 054 247 N/A	N/A Mar 2001 Oct 2001 Oct 2001 June 2001 June 2001 N/A
85070C Dielectric Probe Kit	N/A	N/A
Gigatronics 8652A Power Meter -Power Sensor 80701A -Power Sensor 80701A	1835272 1833535 1833542	Oct 2001 Jan 2001 Feb 2001
E4408B Spectrum Analyzer	US39240170	Nov 2001
8594E Spectrum Analyzer	3543A02721	Mar 2001
8753E Network Analyzer	US38433013	Nov 2001
8648D Signal Generator	3847A00611	Aug 2001
5S1G4 Amplifier Research Power Amplifier	26235	N/A

17.0 MEASUREMENT UNCERTAINTIES

Uncertainty Description	Error	Distribution	Weight	Standard Deviation	Offset
Probe Uncertainty					
Axial isotropy	±0.2 dB	U-Shaped	0.5	±2.4 %	
Spherical isotropy	±0.4 dB	U-Shaped	0.5	±4.8 %	
Isotropy from gradient	±0.5 dB	U-Shaped	0	±	
Spatial resolution	±0.5 %	Normal	1	±0.5 %	
Linearity error	±0.2 dB	Rectangle	1	±2.7 %	
Calibration error	±3.3 %	Normal	1	±3.3 %	
SAR Evaluation Uncertainty					
Data acquisition error	±1 %	Rectangle	1	±0.6 %	
ELF and RF disturbances	±0.25 %	Normal	1	±0.25 %	
Conductivity assessment	±5 %	Rectangle	1	±5.8 %	
Spatial Peak SAR Evaluation Uncertainty					
Extrapolated boundary effect	±3 %	Normal	1	±3 %	±5 %
Probe positioning error	±0.1 mm	Normal	1	±1 %	
Integrated and cube orientation	±3 %	Normal	1	±3 %	
Cube Shape inaccuracies	±2 %	Rectangle	1	±1.2 %	
Device positioning	±6 %	Normal	1	±6 %	
Combined Uncertainties				±11.7 %	±5 %

Measurement uncertainties in SAR measurements are difficult to quantify due to several variables including biological, physiological, and environmental.

According to ANSI/IEEE C95.3, the overall uncertainties are difficult to assess and will vary with the type of meter and usage situation. However, accuracy's of ± 1 to 3 dB can be expected in practice, with greater uncertainties in near-field situations and at higher frequencies (shorter wavelengths), or areas where large reflecting objects are present. Under optimum measurement conditions, SAR measurement uncertainties of at least ± 2dB can be expected.

According to CENELEC, typical worst-case uncertainty of field measurements is ± 5 dB. For well-defined modulation characteristics the uncertainty can be reduced to ± 3 dB.

18.0 REFERENCES

- (1) ANSI, *ANSI/IEEE C95.1: IEEE Standard for Safety Levels with Respect to Human Exposure to Radio Frequency Electromagnetic Fields, 3kHz to 300 Ghz*, The Institute of Electrical and Electronics Engineers, Inc., New York, NY: 1992.
- (2) Federal Communications Commission, “Evaluating Compliance with FCC Guidelines for Human Exposure to Radio frequency Electromagnetic Fields”, OET Bulletin 65, Supplement C, Edition 01-01, FCC, Washington, D.C. 20554: June 2001.
- (3) Thomas Schmid, Oliver Egger, and Niels Kuster, “Automated E-field scanning system for dosimetric assessments”, *IEEE Transaction on Microwave Theory and Techniques*, Vol. 44, pp. 105 – 113: January 1996.
- (4) Niels Kuster, Ralph Kastle, and Thomas Schmid, “Dosimetric evaluation of mobile communications equipment with know precision”, *IEICE Transactions of Communications*, vol. E80-B, no. 5, pp. 645 – 652: May 1997.

APPENDIX A - SAR MEASUREMENT DATA

KENWOOD COMM. CORP. TK-3140-3 / FCC ID: ALH32263130

SAM Phantom; Flat Section; Position: (90°,90°)
Probe: ET3DV6 - SN1590; ConvF(7.36,7.36,7.36); Crest factor: 1.0
450 MHz Brain: $\sigma = 0.87$ mho/m $\epsilon_r = 43.5$ $\rho = 1.00$ g/cm³
Coarse: Dx = 20.0, Dy = 20.0, Dz = 10.0
Cube 5x5x7 Powerdrift: -0.18 dB
SAR (1g): 5.71 mW/g, SAR (10g): 4.14 mW/g

Face-held SAR with 2.5cm Separation Distance
7.2VDC Ni-MH 2000mAh Battery
Continuous Wave Mode
Low Channel [400.05 MHz]
Conducted Power: 4.0 Watts
Date Tested: November 29, 2001

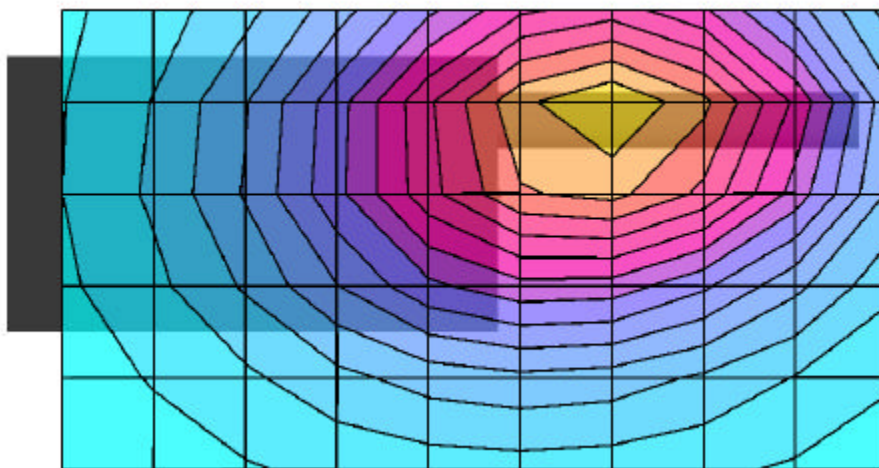

SAR_{Tot} [mW/g]

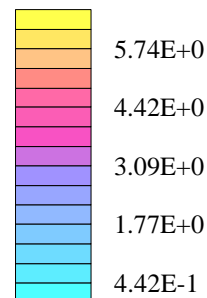

KENWOOD COMM. CORP. TK-3140-3 / FCC ID: ALH32263130

SAM Phantom; Flat Section; Position: (90°,90°)
Probe: ET3DV6 - SN1590; ConvF(7.36,7.36,7.36); Crest factor: 1.0
450 MHz Brain: $\sigma = 0.87$ mho/m $\epsilon_r = 43.5$ $\rho = 1.00$ g/cm³
Coarse: Dx = 20.0, Dy = 20.0, Dz = 10.0
Cube 5x5x7 Powerdrift: -0.16 dB
SAR (1g): 5.09 mW/g, SAR (10g): 3.71 mW/g

Face-held SAR with 2.5cm Separation Distance
7.2VDC Ni-MH 2000mAh Battery
Continuous Wave Mode
Mid Channel [415.05 MHz]
Conducted Power: 4.1 Watts
Date Tested: November 29, 2001

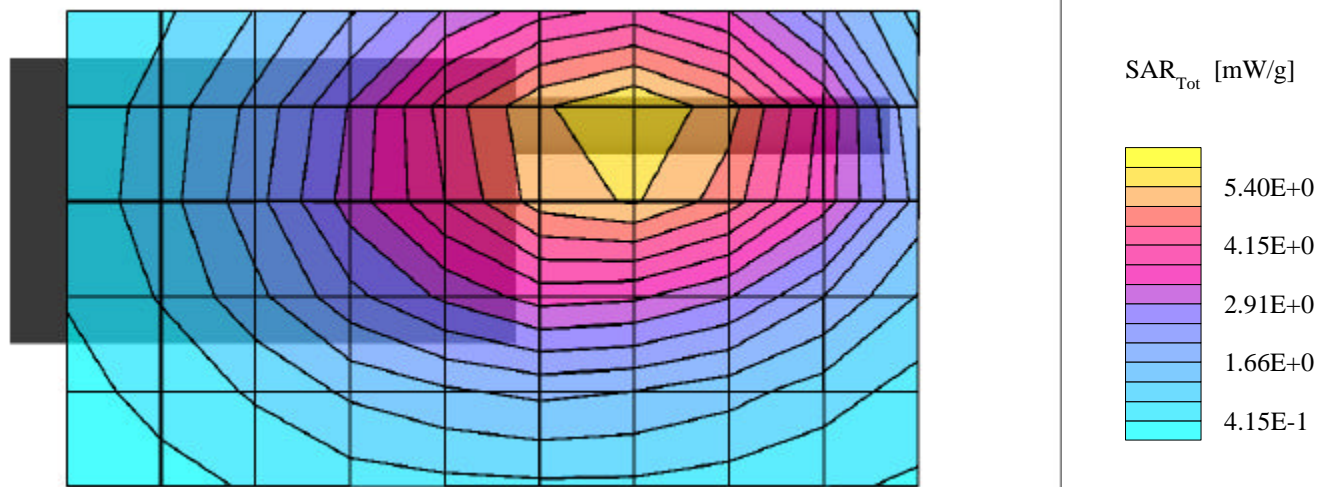

KENWOOD COMM. CORP. TK-3140-3 / FCC ID: ALH32263130

SAM Phantom; Flat Section; Position: (90°,90°)
Probe: ET3DV6 - SN1590; ConvF(7.36,7.36,7.36); Crest factor: 1.0
450 MHz Brain: $\sigma = 0.87$ mho/m $\epsilon_r = 43.5$ $\rho = 1.00$ g/cm³
Coarse: Dx = 20.0, Dy = 20.0, Dz = 10.0
Cube 5x5x7 Powerdrift: -0.17 dB
SAR (1g): 6.47 mW/g, SAR (10g): 4.71 mW/g

Face-held SAR with 2.5cm Separation Distance
7.2VDC Ni-MH 2000mAh Battery
Continuous Wave Mode
High Channel [429.95 MHz]
Conducted Power: 4.1 Watts
Date Tested: November 29, 2001

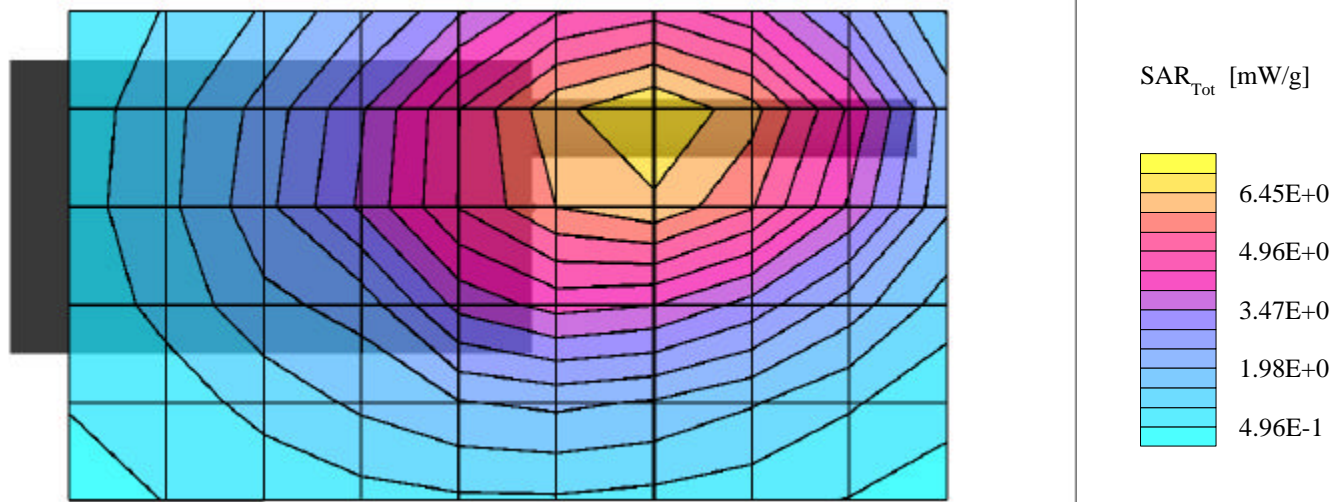

KENWOOD COMM. CORP. TK-3140-3 / FCC ID: ALH32263130

SAM Phantom; Flat Section; Position: (90°,90°)
Probe: ET3DV6 - SN1590; ConvF(7.36,7.36,7.36); Crest factor: 1.0
450 MHz Brain: $\sigma = 0.87$ mho/m $\epsilon_r = 43.5$ $\rho = 1.00$ g/cm³
Coarse: Dx = 20.0, Dy = 20.0, Dz = 10.0
Cube 4x4x7; Powerdrift: -0.16 dB
SAR (1g): 6.23 mW/g, SAR (10g): 4.54 mW/g

Face-held SAR with 2.5cm Separation Distance
7.2VDC Ni-Cd 1200mAh Battery
Continuous Wave Mode
High Channel [429.95 MHz]
Conducted Power: 4.1 Watts
Dated Tested: November 29, 2001

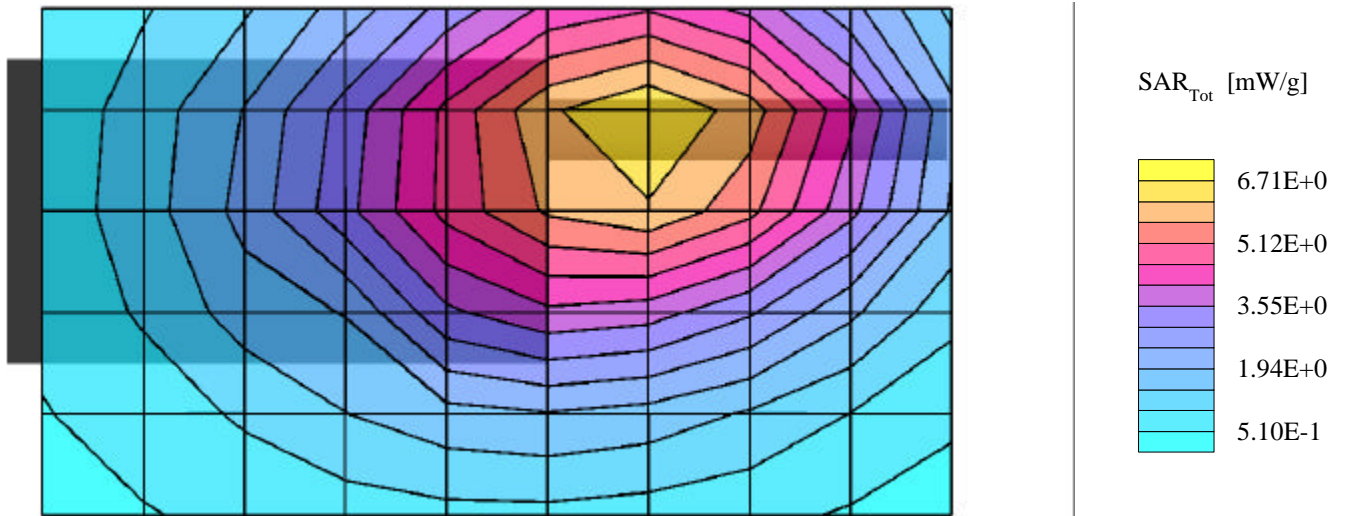

KENWOOD COMM. CORP. TK-3140-3 / FCC ID: ALH32263130

SAM Phantom; Flat Section; Position: (270°,270°)
Probe: ET3DV6 - SN1590; ConvF(7.23,7.23,7.23); Crest factor: 1.0
450 MHz Muscle: $\sigma = 0.94$ mho/m $\epsilon_r = 56.7$ $\rho = 1.00$ g/cm³
Coarse: Dx = 20.0, Dy = 20.0, Dz = 10.0
Cube 5x5x7 Powerdrift: -0.17 dB
SAR (1g): 7.20 mW/g, SAR (10g): 5.18 mW/g

Body-Worn SAR with 1.0cm Belt-Clip & Speaker-Mic
7.2VDC Ni-MH 2000mAh Battery
Continuous Wave Mode
Low Channel [400.05 MHz]
Conducted Power: 4.0 Watts
Date Tested: November 29, 2001

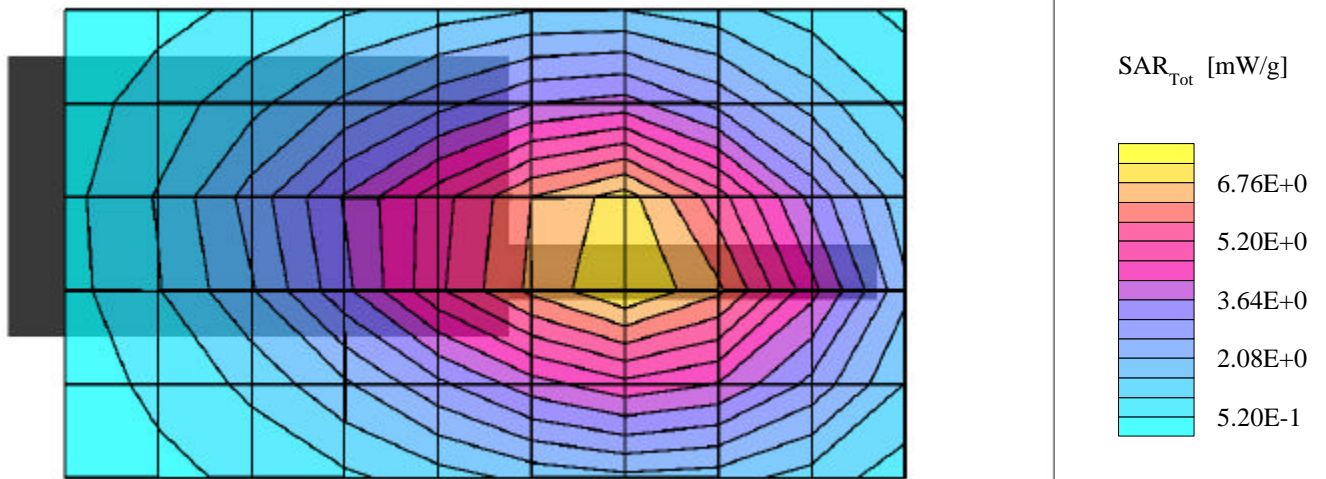

KENWOOD COMM. CORP. TK-3140-3 / FCC ID: ALH32263130

SAM Phantom; Flat Section; Position: (270°,270°)
Probe: ET3DV6 - SN1590; ConvF(7.23,7.23,7.23); Crest factor: 1.0
450 MHz Muscle: $\sigma = 0.94$ mho/m $\epsilon_r = 56.7$ $\rho = 1.00$ g/cm³
Coarse: Dx = 20.0, Dy = 20.0, Dz = 10.0
Cube 5x5x7 Powerdrift: -0.19 dB
SAR (1g): 8.25 mW/g, SAR (10g): 5.94 mW/g

Body-Worn SAR with 1.0cm Belt-Clip & Speaker-Mic
7.2VDC Ni-MH 2000mAh Battery
Continuous Wave Mode
Mid Channel [415.05 MHz]
Conducted Power: 4.1 Watts
Date Tested: November 29, 2001

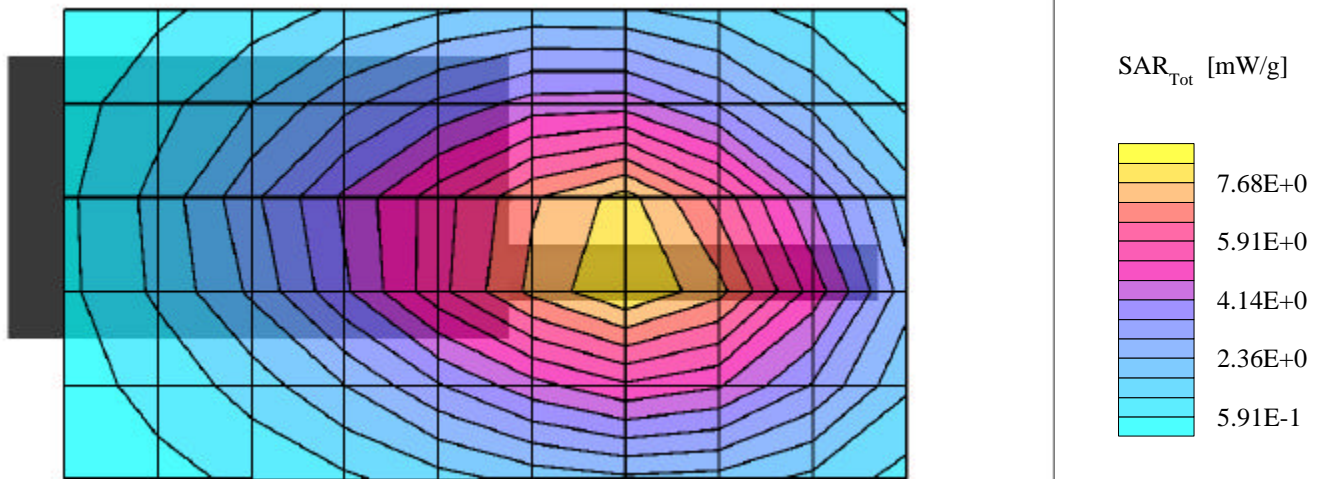

KENWOOD COMM. CORP. TK-3140-3 / FCC ID: ALH32263130

SAM Phantom; Flat Section; Position: (270°,270°)
Probe: ET3DV6 - SN1590; ConvF(7.23,7.23,7.23); Crest factor: 1.0
450 MHz Muscle: $\sigma = 0.94$ mho/m $\epsilon_r = 56.7$ $\rho = 1.00$ g/cm³
Coarse: Dx = 20.0, Dy = 20.0, Dz = 10.0
Cube 5x5x7 Powerdrift: -0.18 dB
SAR (1g): 7.79 mW/g, SAR (10g): 5.64 mW/g

Body-Worn SAR with 1.0cm Belt-Clip & Speaker-Mic
7.2VDC Ni-MH 2000mAh Battery
Continuous Wave Mode
High Channel [429.95 MHz]
Conducted Power: 4.1 Watts
Date Tested: November 29, 2001

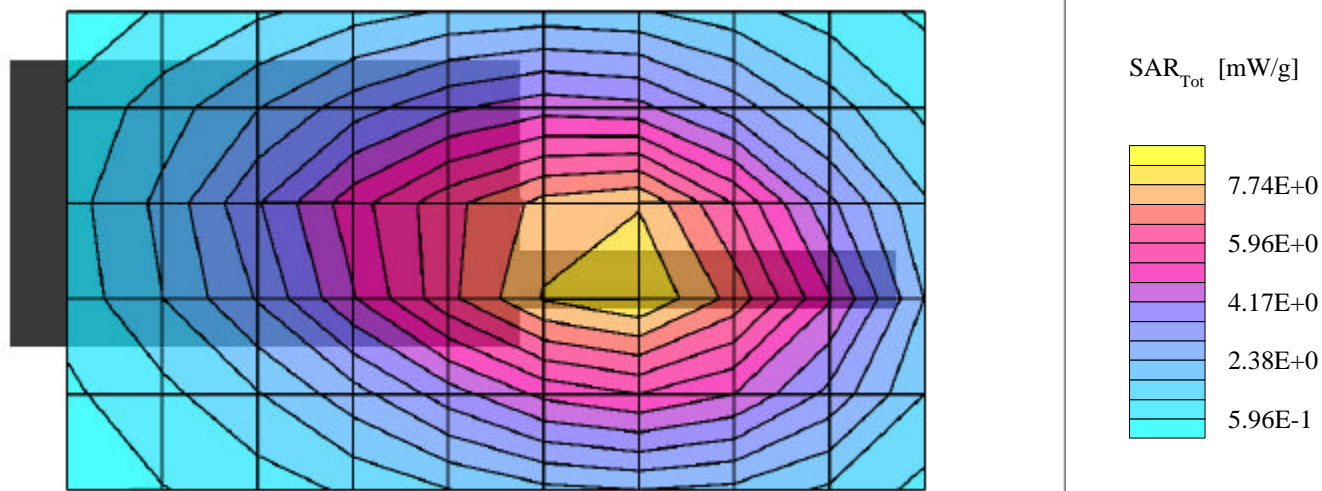

KENWOOD COMM. CORP. TK-3140-3 / FCC ID: ALH32263130

SAM Phantom; Flat Section; Position: (270°,270°)
Probe: ET3DV6 - SN1590; ConvF(7.23,7.23,7.23); Crest factor: 1.0
450 MHz Muscle: $\sigma = 0.94$ mho/m $\epsilon_r = 56.7$ $\rho = 1.00$ g/cm³
Coarse: Dx = 20.0, Dy = 20.0, Dz = 10.0
Cube 4x4x7; Powerdrift: -0.12 dB
SAR (1g): 8.07 mW/g, SAR (10g): 5.84 mW/g

Body-Worn SAR with 1.0cm Belt-Clip & Speaker-Mic
7.2VDC Ni-Cd 1200mAh Battery
Continuous Wave Mode
Mid Channel [415.05 MHz]
Conducted Power: 4.1 Watts
Dated Tested: November 29, 2001

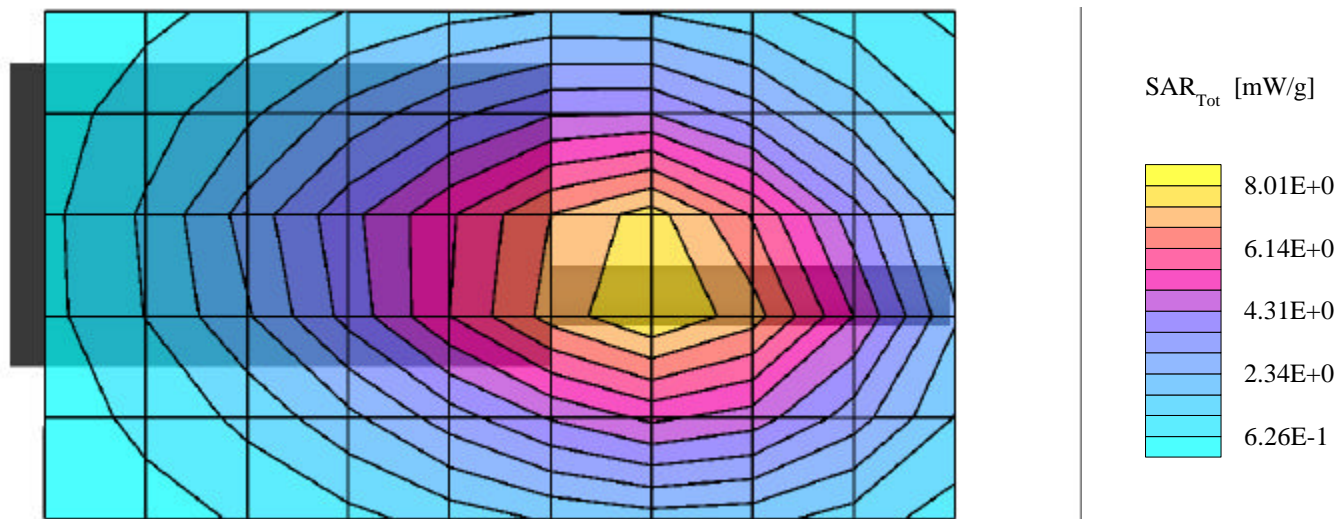

APPENDIX B - DIPOLE VALIDATION

Dipole 450MHz

Frequency: 450 MHz; Conducted Input Power: 250 [mW]

Large Planar Phantom; Planar Section

Probe: ET3DV6 - SN1590; ConvF(7.36,7.36,7.36); Crest factor: 1.0; 450 MHz Brain: $\sigma = 0.87$ mho/m $\epsilon_r = 43.5$ $\rho = 1.00$ g/cm³

Cube 5x5x7: Peak: 2.29 mW/g, SAR (1g): 1.46 mW/g, SAR (10g): 0.959 mW/g, (Worst-case extrapolation)

Penetration depth: 12.1 (10.5, 14.1) [mm]

Powerdrift: 0.01 dB

Validation Date: Nov. 29, 2001

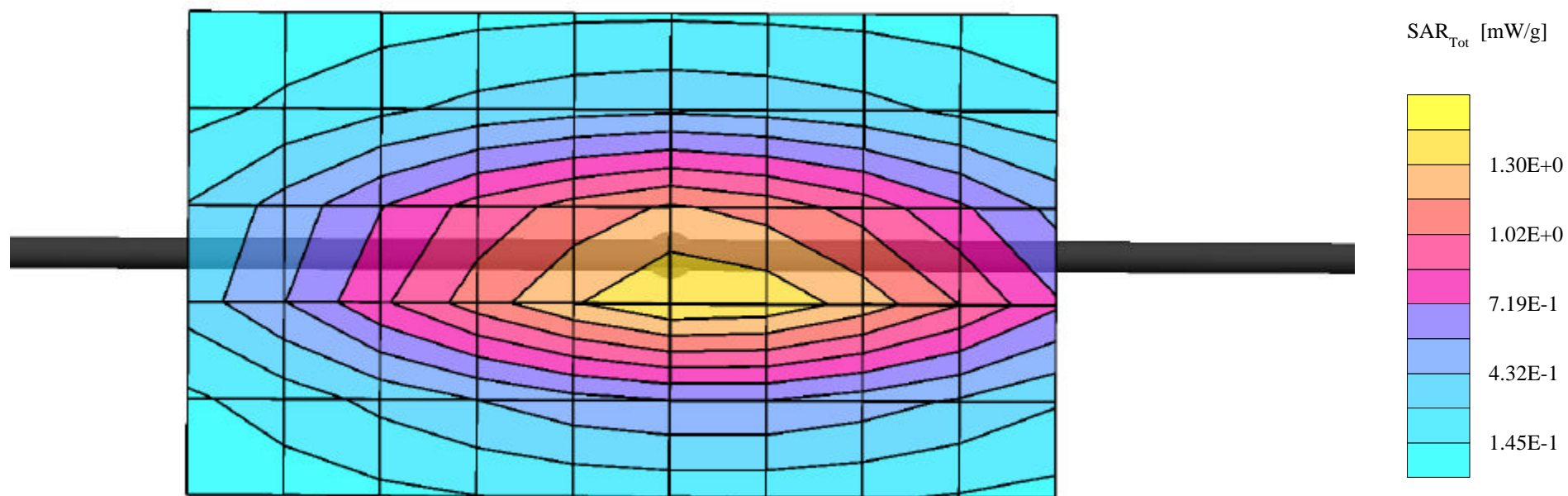

Validation Dipole 450MHz, d = 15 mm

Large Planar Phantom; Planar Section

Probe: ET3DV6 - SN1590; ConvF(7.36,7.36,7.36); Crest factor: 1.0

450 MHz Brain: $\sigma = 0.87$ mho/m $\epsilon_r = 43.5$ $\rho = 1.00$ g/cm³

Z-Axis: Dx = 0.0, Dy = 0.0, Dz = 5.0

Z-Axis scan to show minimum fluid depth of 15cm was maintained

Test Date: November 29, 2001

conducted power: 250 mW

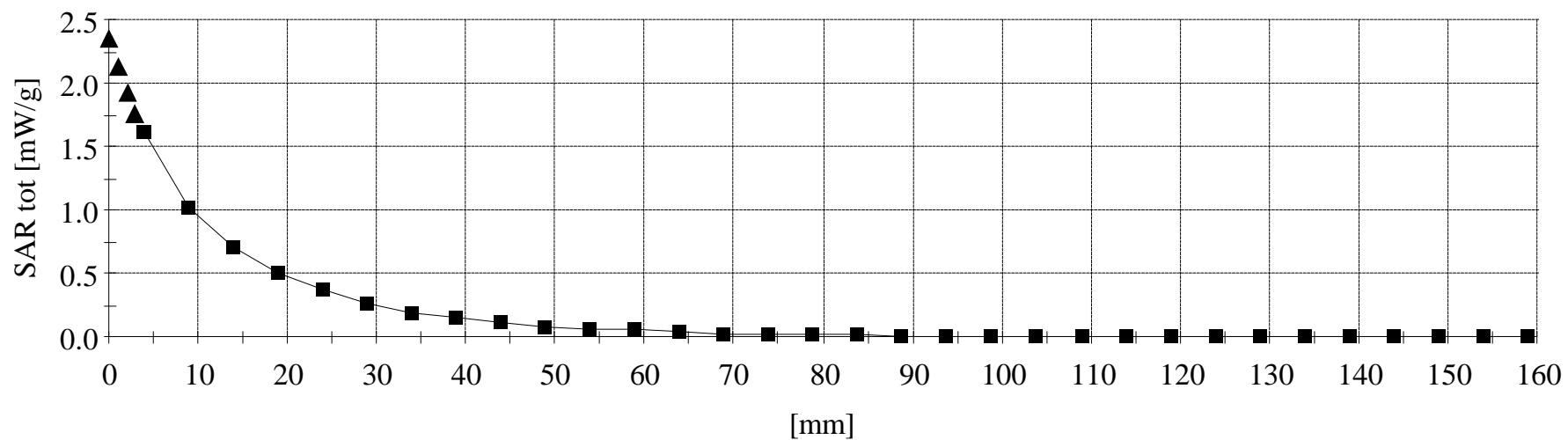

APPENDIX C - DIPOLE CALIBRATION

450MHz SYSTEM VALIDATION DIPOLE

Type:

450MHz Validation Dipole

Serial Number:

136

Place of Calibration:

Celltech Research Inc.

Date of Calibration:

October 17, 2001

Celltech Research Inc. hereby certifies that this device has been calibrated on the date indicated above.

Calibrated by:



Approved by:

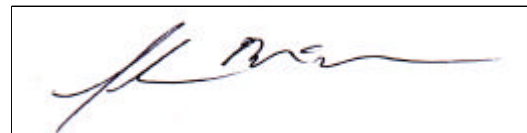

1. Dipole Construction & Electrical Characteristics

The validation dipole was constructed in accordance with the IEEE Std “Recommended Practice for Determining the Spatial-Peak Specific Absorption Rate (SAR) in the Human Body Due to Wireless Communications Devices: Experimental Techniques”. The electrical properties were measured using an HP 8753E Network Analyzer. The network analyzer was calibrated to the validation dipole N-type connector feed point using an HP85032E Type N calibration kit. The dipole was placed parallel to a planar phantom at a separation distance of 15.0mm from the simulating fluid using a loss-less dielectric spacer. The measured input impedance is:

Feed point impedance at 450MHz

$$\text{Re}\{Z\} = 49.982\Omega$$

$$\text{Im}\{Z\} = 5.8594\Omega$$

Return Loss at 450MHz

$$-24.714\text{dB}$$

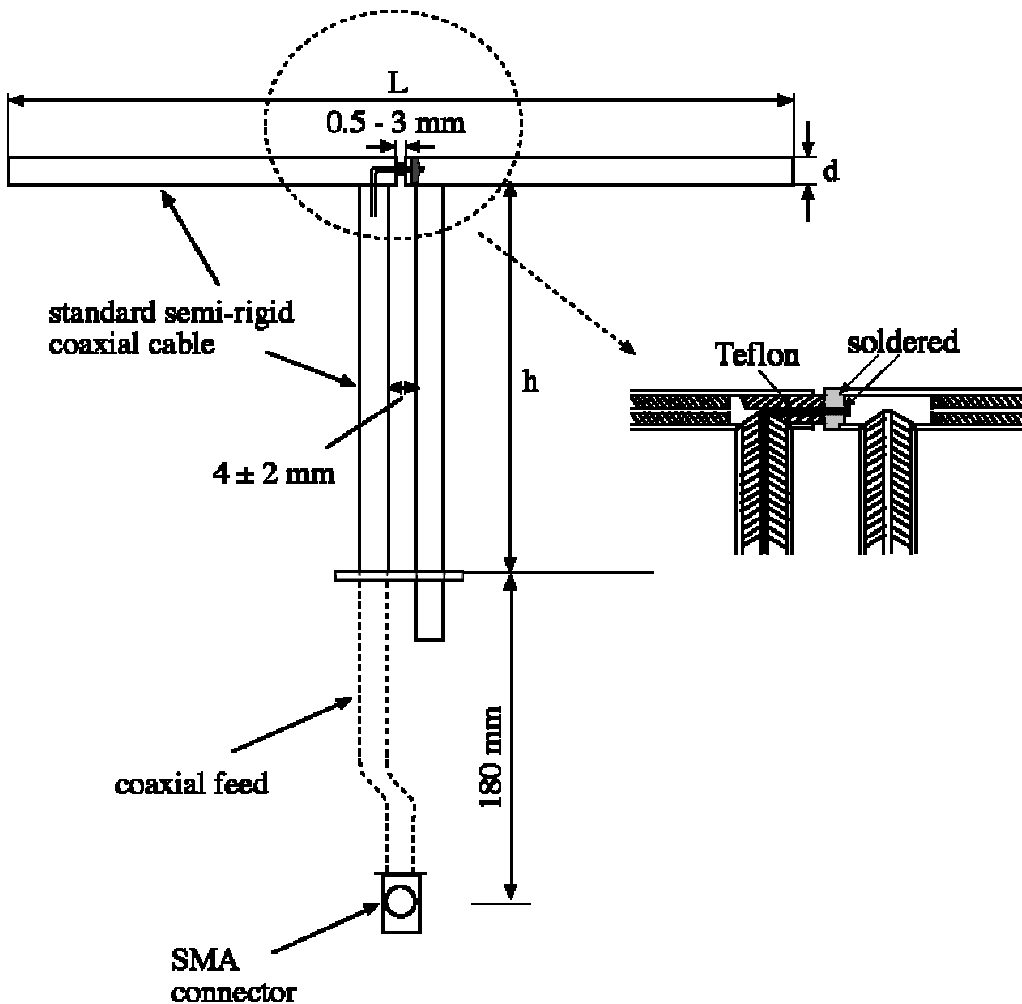

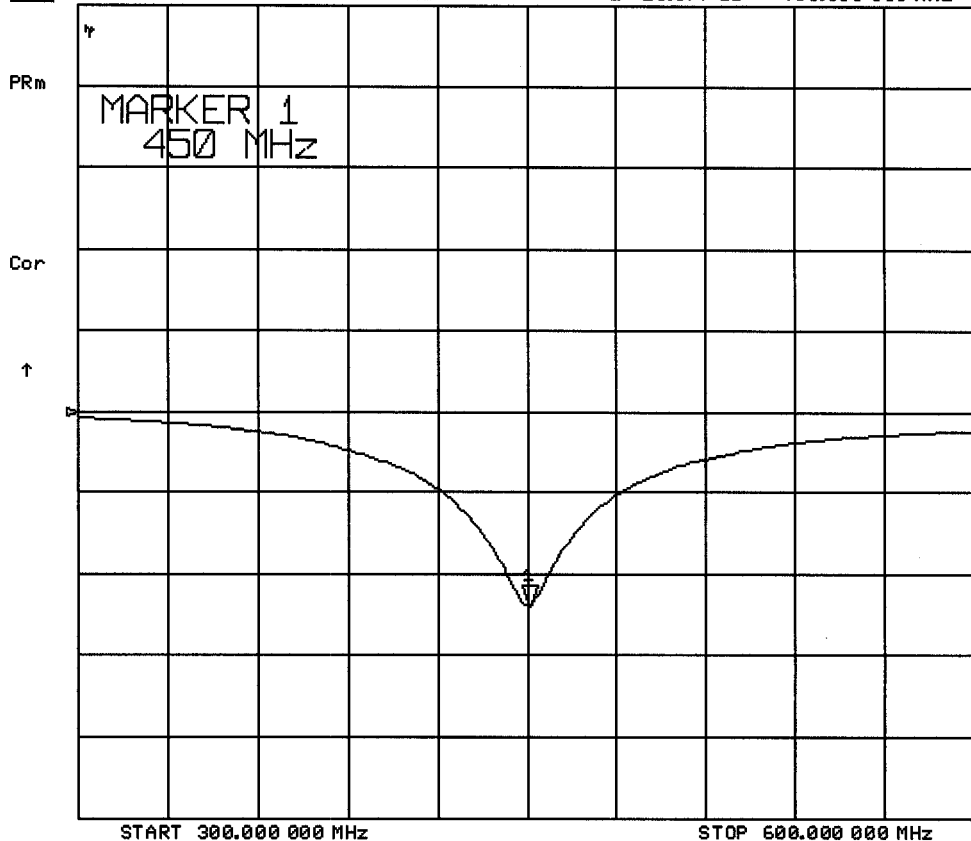

CH1 S11 1 U FS

1: 48.291 Ω 5.9902 Ω 2.1186 nH

11 Oct 2001 15:34:54

450.000 000 MHz

PRm

MARKER 1
450 MHz

Cor

↑

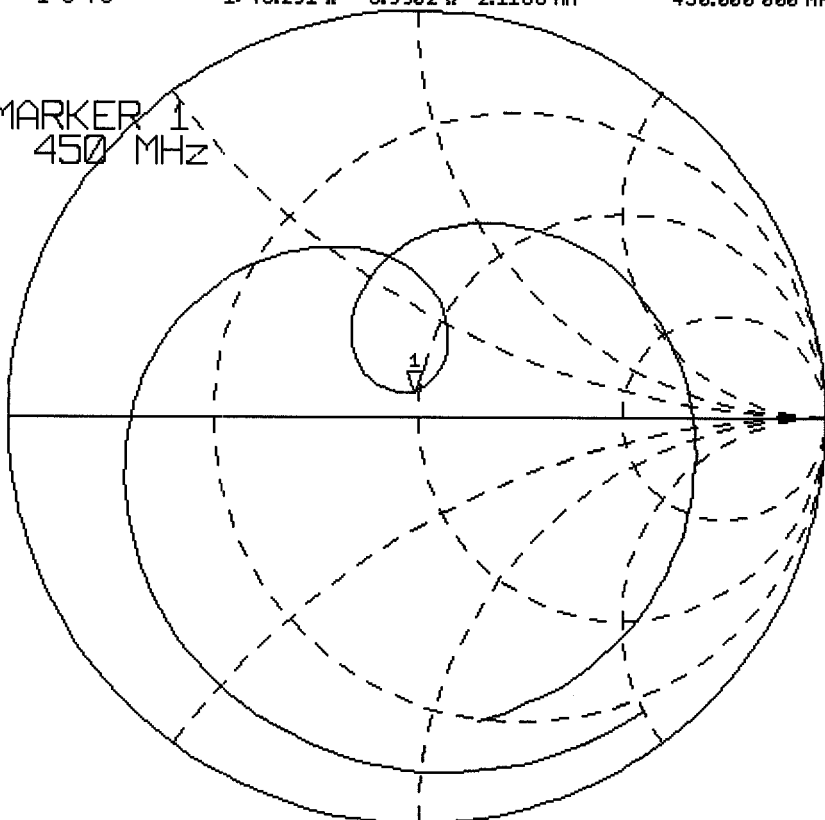

START 300.000 000 MHz

STOP 500.000 000 MHz

Validation Dipole Dimensions

Frequency (MHz)	L (mm)	h (mm)	d (mm)
300	420.0	250.0	6.2
450	288.0	167.0	6.2
835	161.0	89.8	3.6
900	149.0	83.3	3.6
1450	89.1	51.7	3.6
1800	72.0	41.7	3.6
1900	68.0	39.5	3.6
2000	64.5	37.5	3.6
2450	51.8	30.6	3.6
3000	41.5	25.0	3.6

2. Validation Phantom

The validation phantom was constructed using relatively low-loss tangent Plexiglas material. The dimensions of the phantom are as follows:

Length: 83.5 cm
Width: 36.9 cm
Height: 21.8 cm

The bottom of the phantom is constructed of 6.2 ± 0.1 mm Plexiglas.

Dimensions of Plexiglas Planar Phantom

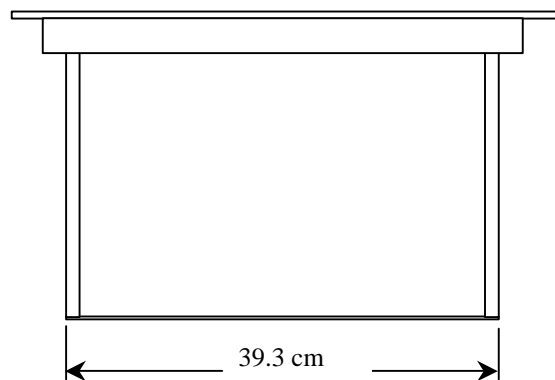
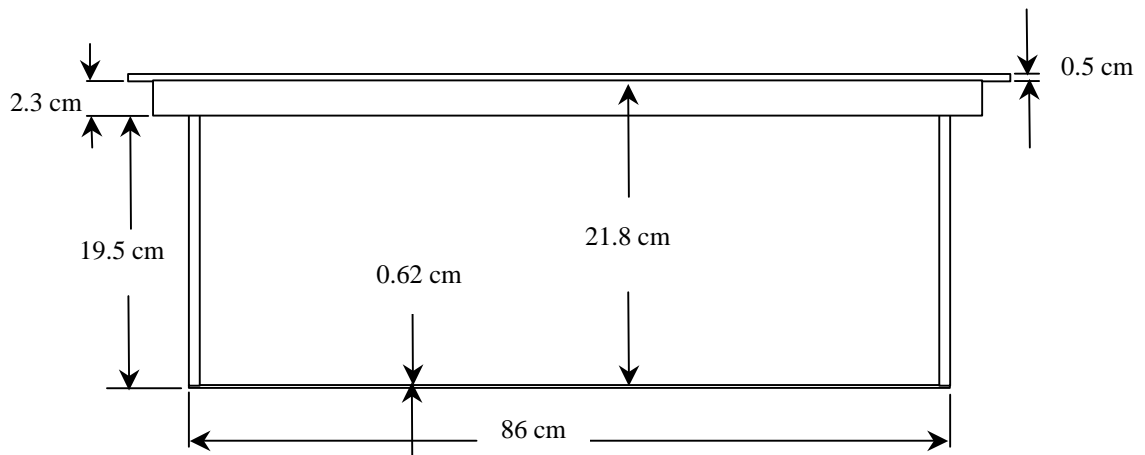
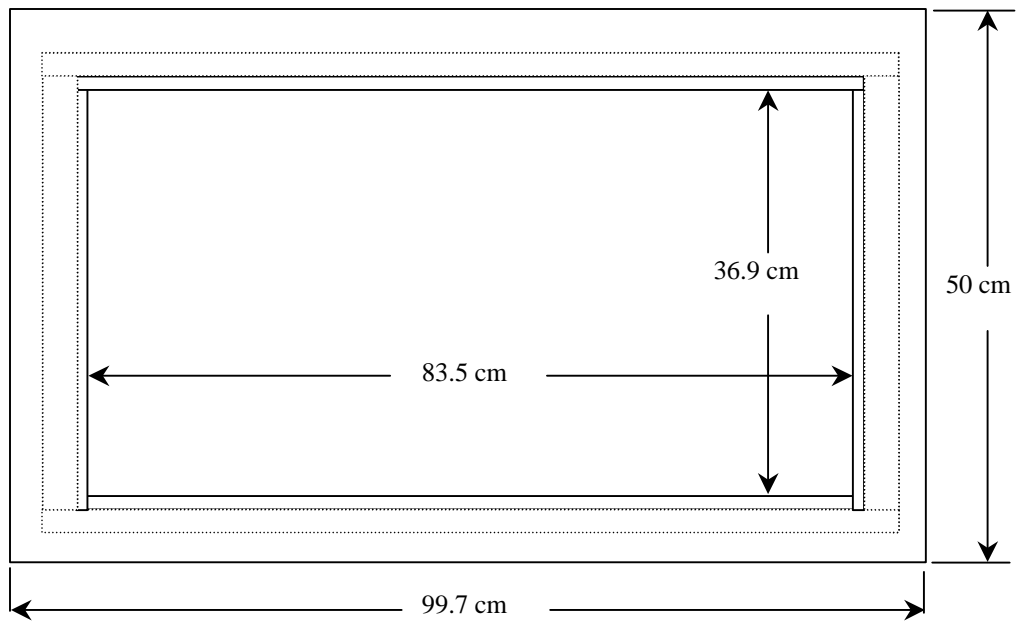

450MHz Dipole Calibration Photo

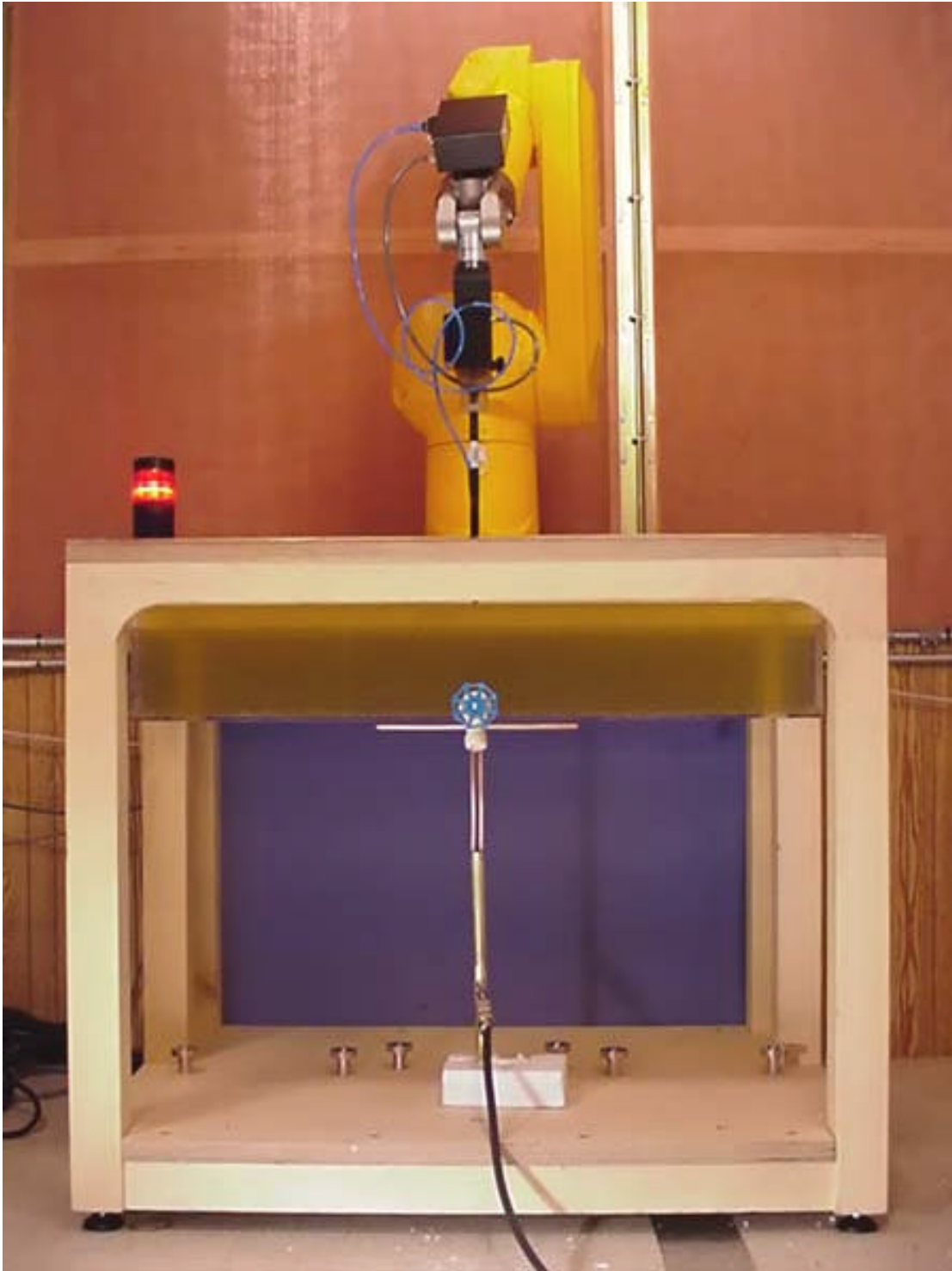

450MHz Dipole Calibration Photo



3. Measurement Conditions

The planar phantom was filled with brain simulating tissue having the following electrical parameters at 450MHz:

Relative Permittivity:	43.8	$\pm 5\%$
Conductivity:	0.86 mho/m	$\pm 5\%$
Temperature:	23.1°C	

The 450MHz simulating tissue consists of the following ingredients:

Ingredient	Percentage by weight
Water	38.56%
Sugar	56.32%
Salt	3.95%
HEC	0.98%
Dowicil 75	0.19%
Target Dielectric Parameters at 22°C	$\epsilon_r = 43.5$ $\sigma = 0.87 \text{ S/m}$

4. SAR Measurement

The SAR measurement was performed with the E-field probe in mechanical detection mode only. The setup and determination of the forward power into the dipole was performed using the following procedures.

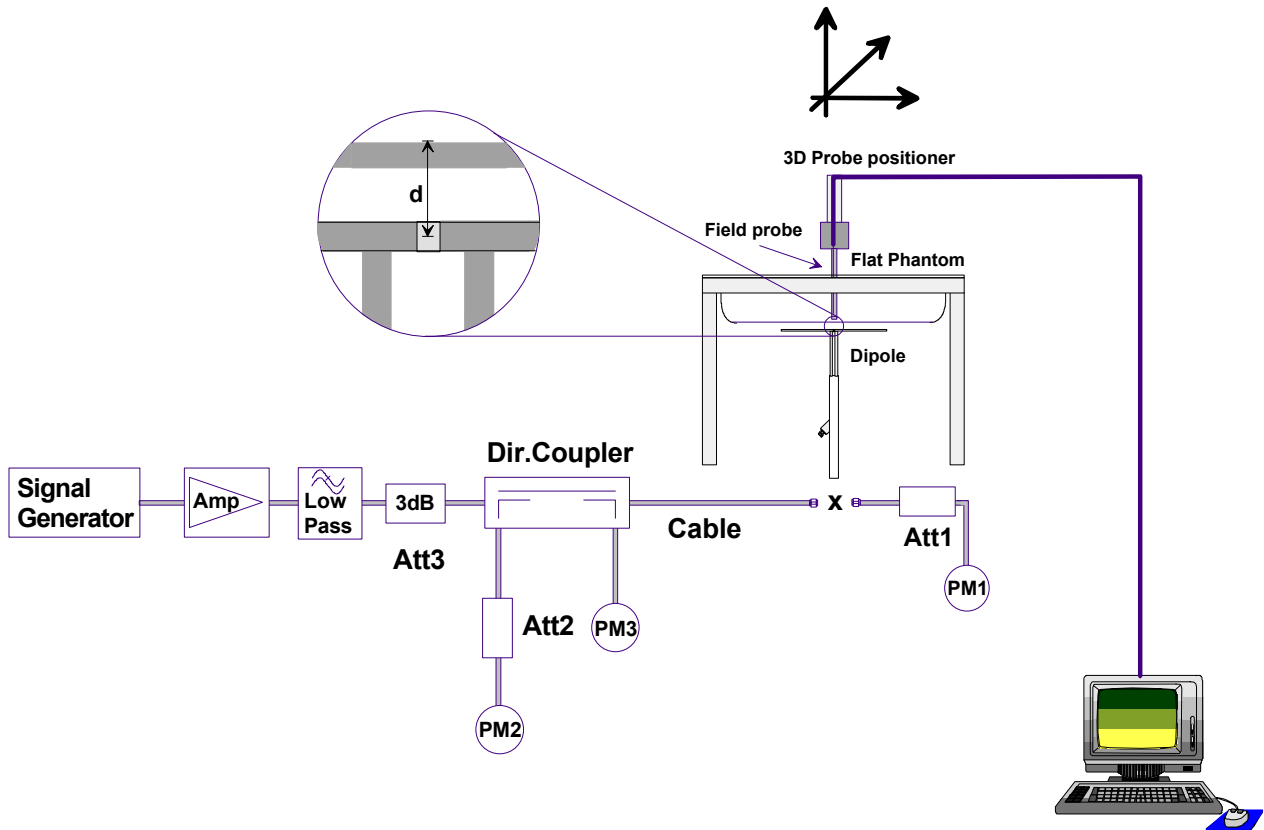

First the power meter PM1 (including attenuator Att1) is connected to the cable to measure the forward power at the location of the dipole connector (X). The signal generator is adjusted for the desired forward power at the dipole connector (taking into account the attenuation of Att1) as read by power meter PM2. After connecting the cable to the dipole, the signal generator is readjusted for the same reading at power meter PM2. If the signal generator does not allow adjustment in 0.01dB steps, the remaining difference at PM2 must be taken into consideration. PM3 records the reflected power from the dipole to ensure that the value is not changed from the previous value. The reflected power should be 20dB below the forward power.

Ten SAR measurements were performed in order to achieve repeatability and to establish an average target value.

Validation Dipole SAR Test Results

Validation Measurement	SAR @ 0.25W Input averaged over 1g	SAR @ 1W Input averaged over 1g	SAR @ 0.25W Input averaged over 10g	SAR @ 1W Input averaged over 10g	Peak SAR @ 0.25W Input
Test 1	1.47	5.88	0.971	3.88	2.31
Test 2	1.43	5.72	0.949	3.80	2.25
Test 3	1.45	5.80	0.961	3.84	2.27
Test 4	1.44	5.76	0.954	3.82	2.26
Test 5	1.46	5.84	0.969	3.88	2.29
Test 6	1.42	5.68	0.939	3.76	2.23
Test 7	1.45	5.80	0.960	3.84	2.27
Test 8	1.41	5.64	0.928	3.71	2.22
Test 9	1.43	5.72	0.950	3.80	2.25
Test10	1.46	5.84	0.971	3.88	2.29
Average Value	1.44	5.77	0.946	3.82	2.26

The results have been normalized to 1W (forward power) into the dipole.

Averaged over 1cm (1g) of tissue: 5.77 mW/g

Averaged over 10cm (10g) of tissue: 3.82 mW/g

Validation Dipole 450MHz, d = 15 mm

Frequency: 450 MHz; Antenna Input Power: 250 [mW]

Flat Phantom; Planar Section

Probe: ET3DV6 - SN1590; ConvF(7.36,7.36,7.36); Crest factor: 1.0

450 MHz Brain: $\sigma = 0.87$ mho/m $\epsilon_r = 43.5$ $\rho = 1.00$ g/cm³

Cube 5x5x7: Peak: 2.34 mW/g, SAR (1g): 1.47 mW/g, SAR (10g): 0.963 mW/g, (Worst-case extrapolation)

Penetration depth: 12.3 (10.7, 14.4) [mm]

Powerdrift: 0.02 dB

Calibration Date: Oct. 17, 2001

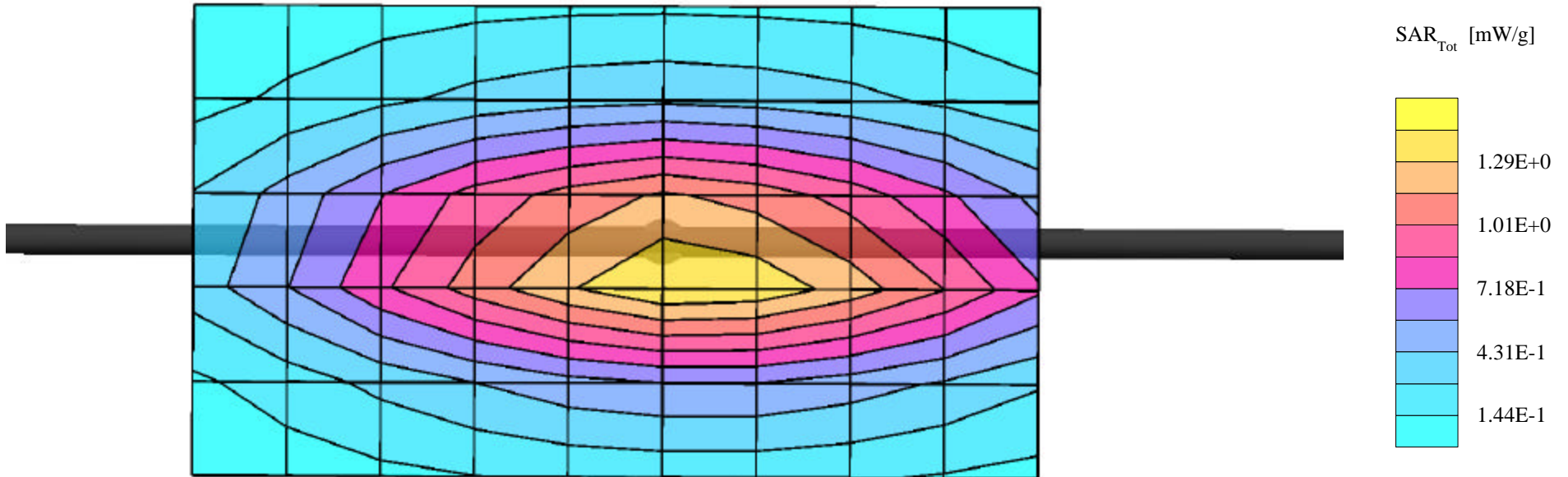

Validation Dipole 450MHz, d = 15 mm

Flat Phantom; Planar Section

Probe: ET3DV6 - SN1590; ConvF(7.36,7.36,7.36); Crest factor: 1.0

450 MHz Brain: $\sigma = 0.87$ mho/m $\epsilon_r = 43.5$ $\rho = 1.00$ g/cm³

Z-Axis: Dx = 0.0, Dy = 0.0, Dz = 5.0

Test Date: October 17, 2001

conducted power: 250 mW

